

VIDEO SENTRY COLOR TILT COLOR TILT VIDEO ENTRY SECURITY INTERCOM

Models: **KCS-1ARD**, *Set of KC-DAR, KC-1MRD & power supply*
KC-1MRD, *Master station*

INSTALLATION MANUAL

! Please also refer to the PS-24E Installation Manual.
Check the package contents before installation.

KC-DAR Package Contents

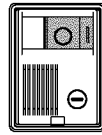

- Screws (2)
- Wood Screws (2)
- Hexagonal wrench

Please save Hexagonal wrench for maintenance.

KC-1MRD Package Contents

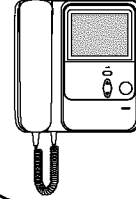

- Installation Manual
- Operation Manual
- Screws (4)
- Wood Screws (4)
- Connector (for door release)











PRECAUTIONS ON INSTALLATION & WIRING

This Manual and the Markings on the product contain various symbols in order that the product can be used safely and properly, and that the installer and user are protected from injury and property damage. The following precautions must be thoroughly read and understood before proceeding.





⚠ WARNING *Negligence could result in death or serious injury.*

⚠ CAUTION *Negligence could result in injury or damage to property.*

⚠ WARNING

1. Do not connect any power source other than specified to terminals +, - on KC-1MRD.  Fire or damage to the unit could result.
2. Do not open KC-1MRD. High voltage is present inside, and it can cause electric shock. 
3. Do not change or alter KC-1MRD. It can cause fire or electric shock. 
4. Make sure wires are connected properly before plugging in power supply. 
5. Keep the KC-1MRD unit away from water or any other liquid. Fire or electric shock could result. 
6. Do not put any forcible strength on the video monitor. Damage may result. 
7. Keep AC plug away from moisture or dust. 
8. Keep AC cord away from being marred or crushed. 
9. Do not plug or unplug with wet hands. 
10. Do not put any metal into KC-1MRD through openings. It can cause fire, electric shock or unit damage. 

⚠ CAUTION

1. Do not install or make any wire terminations while power supply is plugged in. It can cause electrical shock or damage to the unit. 
2. Verify chime volume while handset is on the hook. Chime sound from KC-1MRD speaker is loud, and may cause hearing damage. 
3. In case of electrical storms, unplug power supply from AC outlet. It can cause fire, electric shock, or power surge damage. 
4. Mount KC-1MRD on wall in a convenient location, but not where it could be bumped or jarred.
5. Do not install KC-1MRD in any of the following locations, as it may cause the system to malfunction; 
 - High or extreme cold temperature area, such as under direct sunlight, near equipment that varies in temperature, in front of air conditioner, inside a refrigerated area, etc.
 - Places subject to moisture or humidity extremes. (bathroom, cellar, greenhouse, etc.) 
 - Places subject to environmental conditions, such as oil, dust, chemicals, salt, etc.
 - Places subject to constant vibration or impact.
 - Places where noise generating devices such as TV or radio are close by.

⚠ GENERAL PRECAUTIONS

1. KC-1MRD equipment, except for KC-DAR, is designed for indoor use only. Do not install outdoors.
2. KC-1MRD system is not operational during a power failure.
3. In areas where broadcasting station antennas are close by, intercom system may be affected by radio frequency interference.
4. Keep all DC wiring at least 1'(30cm) away from AC 100~240V wiring, fluorescent lighting, or dimmer switches. Otherwise, cross AC wiring at a 90° angle.
5. KC-1MRD system has to be kept in the distance of more than 3'3" (1m) away from TV or radio.

Examples of Symbols;

⚠ GENERAL PRECAUTIONS: -  mark indicates caution statement (incl. danger and warning), which is specifically shown inside.

! GENERAL INSTRUCTIONS: -  mark indicates contents which demands a specific action shown inside or attached.

⊘ GENERAL PROHIBITIONS: -  mark indicates contents which prohibit a specific action shown inside or attached.

 **DISMANTLE PROHIBITIONS**

 **MOISTURE PROHIBITIONS**

1 MOUNTING

Master station

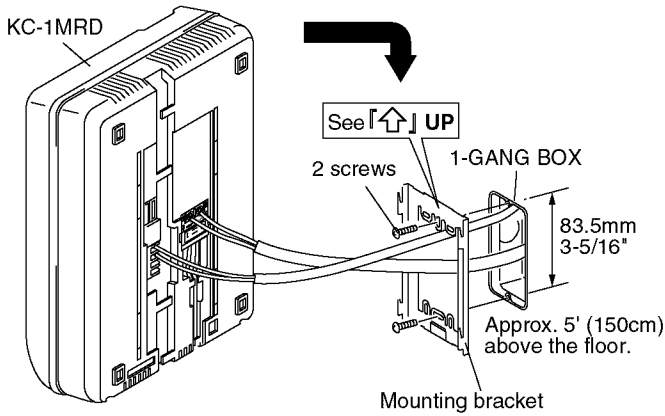

Video door station

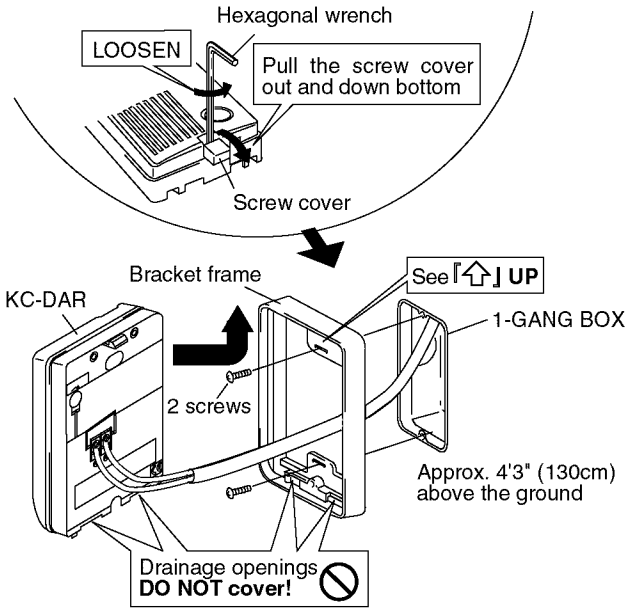

Video door station

Image viewing area (Vertical)

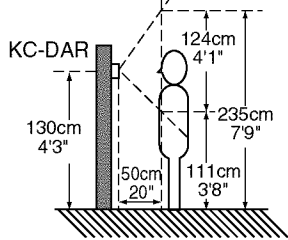

(Horizontal)

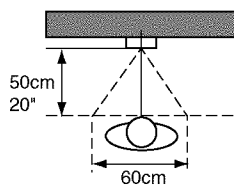

(All distances are approximate.)

Using KAW-D 30° angle box

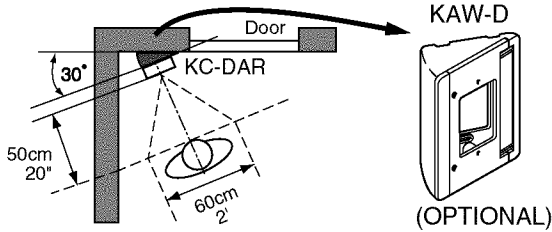

Mounting Precautions

- The video door station employs a CCD camera, and its performance may be affected by bright direct light, such as strong sunlight, gate light, street or porch light which shines directly into the camera lens.
- Install the video door station in front of where the caller will normally stand.
- When outside temperature lowers sharply, after rain, etc., the inside of the camera may fog up slightly, causing a blurry picture. This is not a malfunction. Normal operation will be restored when moisture evaporates.

2 WIRING

Max. wiring distance cable

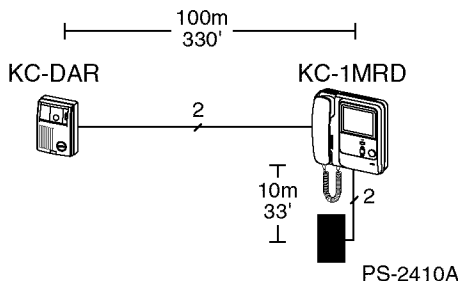

Wiring Precautions

- Keep all wiring at least 30cm, 20" away from AC 100~240V wiring, fluorescent lighting, or dimmer switches. It may cause noise interference or malfunction.

- Use a parallel conductor cable. Coaxial cable cannot be used.

Parallel cable



Coaxial cable



Vinyl jacketed, PE (polyethylene) insulation cable is recommended.

For other types of cables, normal operation and max. communication distance cannot be guaranteed.

- Extra wire(s) in the installed cable can affect image quality, and must be terminated with a 120 ohm resistor at each end.

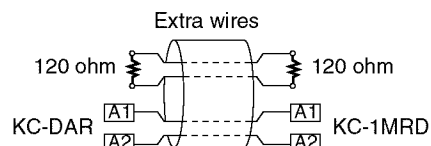

If proper cable is not used, system may malfunction.

2 WIRING (continued)

 Do not use extra terminals for other purposes.

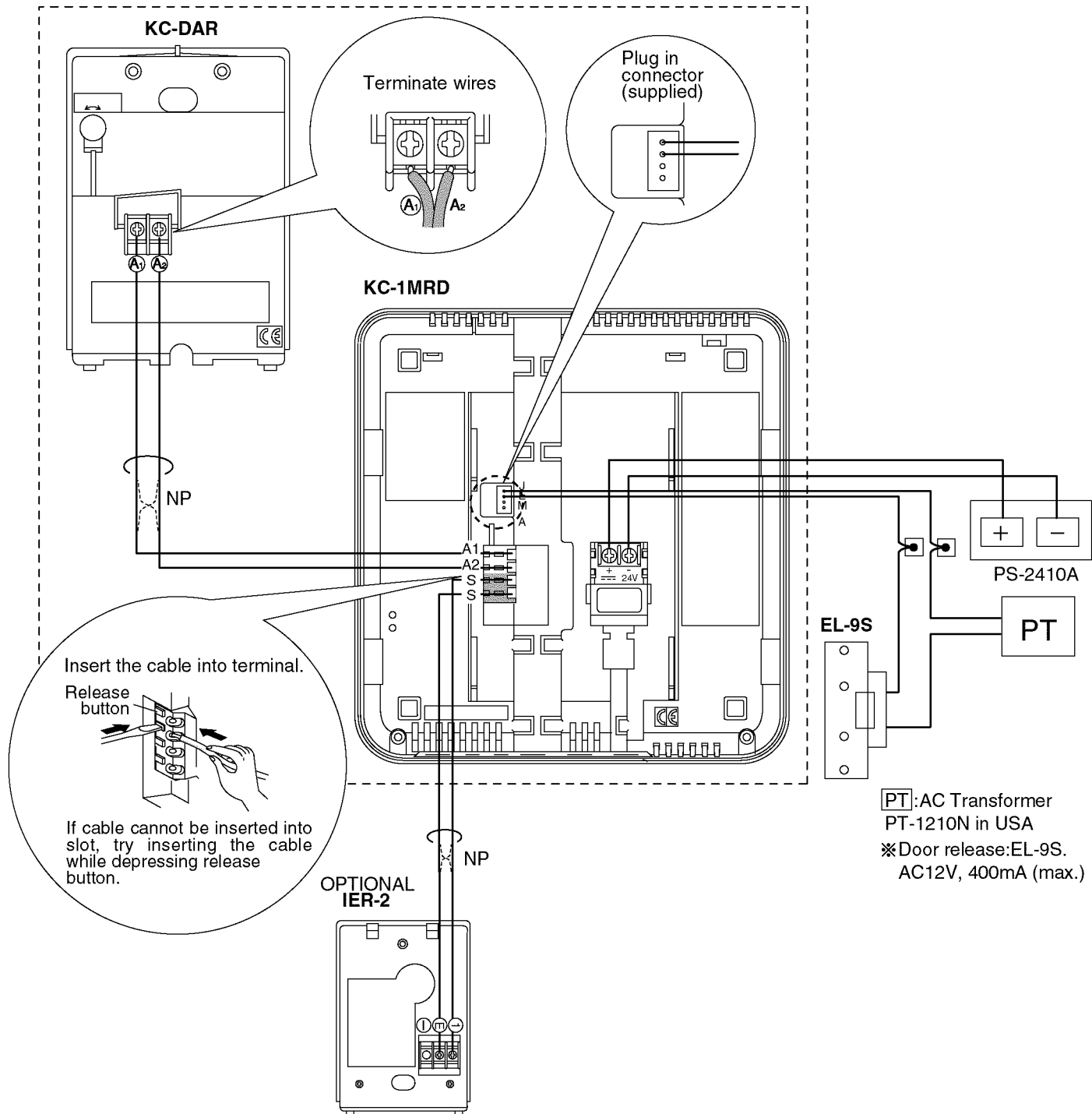

3 BEFORE ASKING FOR REPAIRS

Trouble mode	Potential cause of trouble	Solution
The system does not have chime tone when call button is pressed.	Power switch is OFF.	Turn on the Power switch.
Cannot communicate with door station.	Improper power source.	System uses PS-2410A, 24V DC, 1A.
Image does not appear when the monitor button is pressed.	Wiring between the door station and master station.	See installation manual for proper wiring.
Hard to hear the call tone from door station.	Environmental noise around the master station makes the chime hard to hear.	① Adjust tone volume.
Can hear outside voice even though handset is not lifted.	Normal operation. The system has the feature of instantly monitoring the door station when the call button is pressed.	② Adjust monitor volume.
The LCD monitor looks too dark or too bright.	Characteristics of LCD panel.	③ Adjust Bright control.
Hard to see the monitor when it gets dark outside. Built-in illumination light sometimes turns on.	Appropriate lighting conditions are needed for a clear picture. Illumination lights turn on automatically when it gets dark outside.	④ Adjust the White Light illuminator to OFF or ON as needed.
<p>KC-1MRD Bottom view</p>		
There is a white dot or a portion steadily lit on the monitor.	It must be noted in advance that the TFT Color LCD panel, though manufactured with very high precision techniques, inevitably has a very small portion of picture elements that are either steadily lit or not lit at all, which is not considered a unit malfunction.	

4 SPECIFICATIONS

KC-1MRD (Master station)

Power source	24V DC, 1 A Use PS-2410A				
Consumption	Max. 650mA. 50mA standby				
Call-in	From video door station : 4-tone chime				
Wiring Distance	•KC-DAR ~ KC-1MRD	0.65mm	1.0mm	22AWG	18AWG
	•KC-1MRD ~ IER-2	50m	100m	165'	330'
Communication	Simultaneous with handset				
Video monitor	4 inch TFT color LCD				
Ambient temperature	32°F ~ 104°F (0°C ~ 40°C)				
Housing	Fire-retardant ABS plastic				
Color	White				
Dimensions	7-1/4"(W) x 7-3/4"(H) x 3-1/2"(D) (185(W) x 195(H) x 88(D)mm)				
Weight	2.2 lbs (1kg) approx.				
Door release	12V AC, 400mA.				

KC-DAR (Video door station)

Power source	12V DC in standby. 22V DC in operation (supplied from KC-1MRD)
Consumption	4mA approx. in standby. 350mA approx. max
Camera element	1/4 inch color CCD
Image view area	Approx. 2' Horiz., 3'8"~7'9" Vert. at 4'3" high (up to box center) and at 20" from camera. (60cmH, 111~235cm V at 130cm high & 50cm away)
Lighting at night	White light cast up to 1' (30cm), in front of camera. *Background scene beyond 1' (30cm) cannot be seen.
Communication	Simultaneous in open voice
Ambient temperature	14°F ~ 140°F (-10°C ~ 60°C)
Housing	Fire-retardant ACS plastic.
Color	Gray
Dimensions	4-1/8"(W) x 5-1/2"(H) x 1-3/4"(D) (105(W) x 140(H) x 44(D)mm)
Weight	0.68 lbs.(310g) approx.

AIPHONE CO., LTD., NAGOYA, JAPAN
AIPHONE CORPORATION, BELLEVUE, WA, USA
AIPHONE EUROPE NV, ANTWERP, BELGIUM

COMMUNICATION SYSTEMS
AIPHONE[®]
HOME, BUSINESS, INDUSTRY.