

MY Series WIDE-ANGLE DOOR STATION

Model: **MY-DS**

INSTALLATION & OPERATION MANUAL

1 SYSTEM OUTLINE & FEATURES

MY-DS is a fixed position camera system, and installs with either PanTilt MY-2CD or other MY video-monitors, MY-CU, etc.

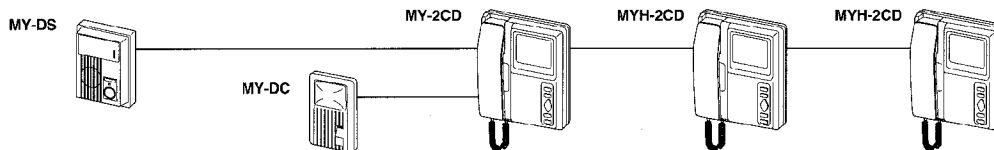

Provides vision of 70cm, 2'3" vertical and 100cm, 3'3" horizontal through wide-angle lens on a 2-parallel conductor cable, expandable up to 200m, 650' distance.

Check with the package contents

- Wide-viewing door (MY-DS)
- Screws-pack
- Installation & Operation Manual

2 NAMES AND FUNCTIONS

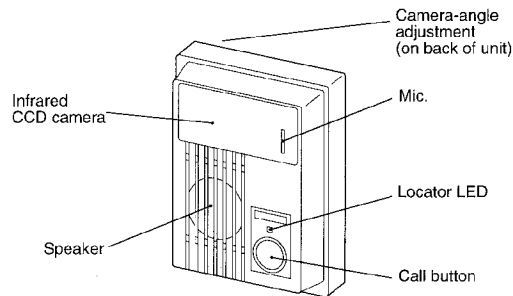

3 INSTRUCTIONS ON INSTALLATION & WIRING

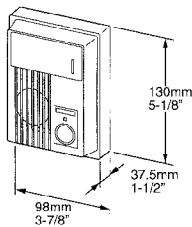

MY-DS is a surface-mount, thin and slim designed, and as flat as audio IF-DA door.

Provides a sharp-focused and clear image through infrared CCD camera system. Backlight control works to brighten image of entry dim or strongly backlit.

Features **camera-angle adjustment**, which enables site-adjusting of camera angle upwardly by 14°. Move down adjustment lever on back of unit, and inadequately low mounting height may be compensated.

Camera angle adjuster

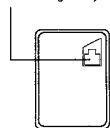

Move down the lever to turn up the camera.

Before actually mounting, it is suggested to wire on MY-DS and using monitor, and make calling and image viewing operations. This allows to re-examine MY-DS camera-mounting height as well as direction to avoid strong light coming directly into the camera lens. Feasibility to use on existing cable installation can also be checked.

When camera views horizontally

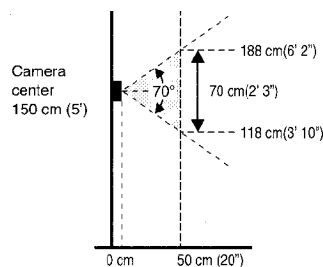

When camera angle is upwardly adjusted

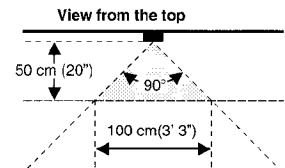
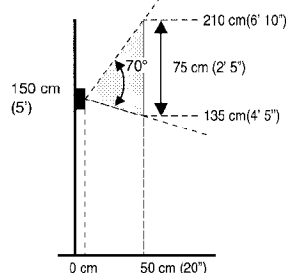

(All the figures are approximate)

4 MOUNTING

MY-DS camera angle is preset for horizontal viewing. Refer to the charts showing MY-DS viewing area.

Separate main unit from back frame, loosening a front bottom screw. Chassis is then mounted with guide of 83.5mm, 3-5/16". Terminate wires on nonpolar A1, A2 terminals, which must be adequately protected to avoid shorting. Cable opening is provided at bottom of back case, which should not be sealed to secure vaporization.

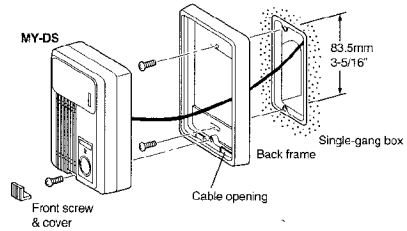

5 WIRING

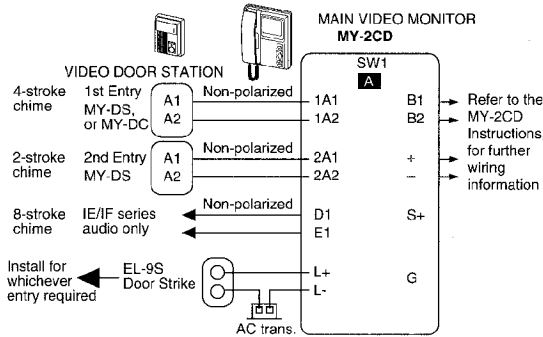

Use a single pair (parallel) cable to MY-DS door. Never use coaxial cable. Extra pairs in the cable, image-affecting, should be terminated with 120 ohm resistor at each end.

6 OPERATIONS

Single-touch of Call button activates own camera to provide image of entry, approx. 45-second timed on the inside monitors. The caller is to stand at 50cm, 20" distance in front of camera. Projects infrared up to 50cm, 20", and sees identifiably image in near darkness. The inside monitor/intercom hears chime tone and picks up or selects. Talk handsfree.

7 BEFORE ASKING FOR REPAIR

MY-DS is weather-resistant. But observe that the door station must be adequately protected against weather conditions. When cleaning, use only neutral household cleanser or plastic cleaner, and wipe off camera lens cover gently with a soft cloth. When the temperature outside lowers rapidly (after rain, etc.) the camera lens may be fogged and offer a dim image at inside video-monitor. This is not a malfunction, and will return to normal shortly.

8 SPECIFICATIONS

| | |
|-----------------------------|--|
| Power source | DC 18V system. Power is fed by main video-monitor. |
| Camera unit | Infrared CCD camera, 250,000 pixels |
| Scanning line | 525 lines |
| Image viewing area | 70cm, 2'3" vertical and 100cm, 3'3" horizontal at 50cm, 20" distance |
| Minimum illumination | 1 Lux or less at same distance |
| Wiring distance | 100m with 0.65mm dia. 200m with 1.0mm dia. 330' with 22AWG. 650' with 18AWG |
| Dimensions | 130mm high x 98mm wide x 37.5mm deep, 5-1/8" H x 3-7/8" W x 1-1/2" D |
| Weight | 230g (0.51 lbs.) approx. |

This equipment has been tested and found to comply with the limits for a Class B digital device, pursuant to Part 15 of the FCC Rules. These limits are designed to provide reasonable protection against harmful interference in a residential installation. This equipment generates, uses, and can radiate radio frequency energy and, if not installed and used in accordance with the instructions, may cause harmful interference to radio communications. However, there is no guarantee that interference will not occur in a particular installation. If this equipment does cause harmful interference to radio or television reception, which can be determined by turning the equipment off and on, the user is encouraged to try to correct the interference by one or more of the following measures:

- Reorient or relocate the receiving antenna.
- Connect the equipment into an outlet on a circuit different from that to which the receiver is connected.
- Increase the separation between the equipment and receiver.
- Consult the dealer or an experienced radio/TV technician for help.

WARRANTY

Aiphone warrants its products to be free from defects of material and workmanship under normal use and service for a period of two years after delivery to the ultimate user and will repair free of charge or replace at no charge, should it become defective upon which examination shall disclose to be defective and under warranty. Aiphone reserves unto itself the sole right to make the final decision whether there is a defect in materials and/or workmanship; and whether or not the product is within the warranty.

This warranty shall not apply to any Aiphone product which has been subject to misuse, neglect, accident, or to use in violation of instructions furnished, nor extended to units which have been repaired or altered outside of the factory. This warranty does not cover batteries or damage caused by batteries used in connection with the product.

This warranty covers bench repairs only, and any repairs must be made at the shop or place designated in writing by Aiphone.

Aiphone will not be responsible for any costs incurred involving on site service calls.