

# SPEED TOUCH PRO

## User's Guide



Status Released

Change Note BD F aa 34297

**Short Title** CD-UG STPro R3.2.6

All rights reserved. Passing on and copying of this document, use and communication of its contents not permitted without written authorization from Alcatel.

# Contents

<b>1</b>	<b>Speed Touch Quick Guide</b> .....	<b>11</b>
1.1	Get Acquainted with your Speed Touch .....	12
1.2	Speed Touch Installation .....	15
1.2.1	What you Need .....	16
1.2.2	STPro Wiring .....	17
1.2.3	Check your Service Provider's Offering .....	19
1.2.4	Configure your STPro (If Necessary) .....	20
1.2.5	Surf the Internet .....	21
1.2.6	Detailed STPro Information .....	22
<b>2</b>	<b>Wiring Guide – Ethernet and ATMF-25.6</b> .....	<b>25</b>
2.1	LAN Cables .....	26
2.2	Connecting Ethernet .....	27
2.2.1	Ethernet Port(s) on your STPro .....	28
2.2.2	Single PC Ethernet Wiring .....	29
2.2.3	LAN Ethernet Wiring .....	30
2.3	Connecting the ATMF-25.6 Port (Optional) .....	31
2.4	Ethernet vs. ATMF-25.6 Connectivity .....	32
<b>3</b>	<b>Wiring Guide – DSL, Power and Console</b> .....	<b>33</b>
3.1	Locating Ports .....	34
3.2	Connecting the DSL Port .....	35
3.3	Connecting the Power Adapter .....	36
3.4	Connecting the Serial Port (Optional) .....	37
<b>4</b>	<b>Wiring Guide – Résumé</b> .....	<b>39</b>
<b>5</b>	<b>Configuration and Use – Packet Services</b> .....	<b>43</b>
5.1	Supported Packet Services .....	44
5.2	Packet Services at a Glance .....	45
5.3	Selection Criteria .....	48
<b>6</b>	<b>Configuration and Use – Transparent Bridging</b> .....	<b>49</b>
6.1	Preparatory Steps .....	50
6.2	Using Bridging .....	51
6.3	Bridging Configuration .....	52
6.4	Bridge Data .....	55
<b>7</b>	<b>Configuration and Use – Bridged PPPoE</b> .....	<b>57</b>
7.1	Preparatory Steps .....	58
7.2	Using Bridged PPPoE .....	59

7.3	Bridged PPPoE Configuration .....	60
<b>8</b>	<b>Configuration and Use – PPP-to-PPTP Relaying .....</b>	<b>61</b>
8.1	Preparatory Steps .....	62
8.2	Using PPPoA-PPTP Relaying .....	63
8.2.1	Preparing the PC for PPTP Tunneling .....	64
8.2.2	Using PPTP towards your STPro .....	65
8.3	Example : MS Windows 98 Dial-Up Networking .....	66
8.3.1	Create a New Dial-Up Networking Icon .....	67
8.3.2	Open a Dial-Up Session .....	70
8.3.3	Close a Dial-Up Session in Use .....	72
8.4	PPPoA/PPTP Configuration .....	73
<b>9</b>	<b>Configuration and Use – PPP &amp; IP Routing .....</b>	<b>79</b>
9.1	Preparatory Steps .....	80
9.2	Using PPP & IP Routing .....	81
9.3	PPP Configuration .....	84
9.4	PPP Entry Configuration .....	87
9.4.1	The PPP Configuration Page .....	88
9.4.2	Authentication Related Configurations .....	89
9.4.3	IP Routing Related Configurations .....	90
9.4.4	Connection Related Configuration .....	94
<b>10</b>	<b>Configuration and Use – CIP &amp; IP Routing .....</b>	<b>97</b>
10.1	Preparatory Steps .....	98
10.2	CIP Configuration for a LIS .....	99
10.2.1	General CIP Configuration Procedure .....	100
10.2.2	Retrieving LIS Parameters .....	101
10.2.3	Implicit Assignment Mechanism .....	102
10.2.4	Explicit Assignment Mechanism .....	103
10.2.5	Configuring the STPro for CIP .....	104
10.2.6	Adding Appropriate Routes to the Routing Tables .....	105
10.2.7	Example Configuration .....	107
10.3	Using CIP & IP Routing .....	109
10.4	CIP Configuration .....	110
<b>11</b>	<b>Networking – ATM .....</b>	<b>117</b>
11.1	The ATM Packet Switching Technology .....	118
11.1.1	ATM Parameters .....	119
11.1.2	ATM and the STPro .....	120
11.1.3	ATM and Interfaces .....	121
11.2	ATMF-25.6 Port Configuration .....	123
11.3	The Speed Touch Phonebook .....	124
11.3.1	The STPro 'Phonebook' Page .....	125
11.3.2	Using the Phonebook .....	128

11.3.3	AutoPVC and the Phonebook .....	130
<b>12</b>	<b>Networking Services – IP .....</b>	<b>133</b>
12.1	Speed Touch and IP .....	134
12.2	Packet Services and IP .....	135
12.2.1	Transparent Bridging .....	136
12.2.2	PPPoA-to-PPTP Relaying .....	137
12.2.3	Routed Packet Services .....	138
12.3	Speed Touch Addresses .....	139
12.3.1	STPro IP Address Types .....	140
12.3.2	Static IP Address Configuration .....	142
12.4	Speed Touch DHCP .....	145
12.4.1	STPro DHCP Pages .....	146
12.4.2	The STPro DHCP Server .....	147
12.4.3	The STPro DHCP Client .....	153
12.5	Speed Touch Routing .....	154
12.5.1	The STPro IP Router .....	155
12.5.2	Configuring the STPro IP Routing Table .....	158
12.6	Speed Touch NAT&PAT .....	162
12.6.1	STPro and NA(P)T .....	163
12.6.2	Packet Services and NA(P)T .....	164
<b>13</b>	<b>Networking Services – DNS .....</b>	<b>167</b>
13.1	Speed Touch DNS Resolving .....	168
13.2	Configuring the Speed Touch DNS Server .....	170
<b>14</b>	<b>Maintenance – Speed Touch Software .....</b>	<b>175</b>
14.1	Software Upload from the local LAN .....	176
14.2	Software Download from the DSL WAN .....	181
<b>15</b>	<b>Maintenance – Speed Touch Password .....</b>	<b>183</b>
<b>16</b>	<b>Maintenance – Speed Touch To-Defaults .....</b>	<b>185</b>
16.1	Ping-of-Life .....	186
16.2	Speed Touch Reset .....	189
16.2.1	Browse-to-Defaults .....	190
16.2.2	Ping-to-Defaults .....	191
16.2.3	Switch-to-Defaults .....	192
<b>17</b>	<b>Maintenance – Speed Touch Web Interface .....</b>	<b>193</b>
17.1	Web Interface Preconditions .....	194
17.1.1	Disabling Proxy Servers .....	195
17.1.2	Disabling Proxying for Local IP Addresses .....	196
17.2	Browsing to the Speed Touch Pages .....	197
17.3	Speed Touch Page Structure .....	198

<b>18</b>	<b>Maintenance – Speed Touch CLI</b>	<b>201</b>
18.1	Native CLI Access	202
18.1.1	CLI through a Telnet Session	203
18.1.2	CLI via Serial Access	205
18.1.3	CLI Command Basics	206
	<b>Abbreviations</b>	<b>211</b>
<b>AppendixA</b>	<b>Speed Touch Troubleshooting</b>	<b>213</b>
<b>AppendixB</b>	<b>Speed Touch Specifications</b>	<b>215</b>
<b>AppendixC</b>	<b>Speed Touch Default Assignments</b>	<b>227</b>
<b>AppendixD</b>	<b>Safety and Agency Regulatory Notices</b>	<b>231</b>

---

# Alcatel Speed Touch Pro

## Introduction

---



---

The **Alcatel Speed Touch™Pro** DSL router provides high-speed access to the Internet and Corporate networks for small office and fastidious home users and high-speed inter office LAN-to-LAN connections.

For optimal Local Area Network (LAN) performance the **Alcatel Speed Touch™Pro** includes a comprehensive set of features, as there are a DHCP server, DNS server and NAT&PAT to name a few.

---

---

## ADSL/POTS and ADSL/ISDN

Three variants of **Alcatel's Speed Touch™Pro** Asymmetric Digital Subscriber Line (ADSL) routers exist:

- ▶ An ADSL/POTS variant connecting to an analog POTS(\*) line
- ▶ two ADSL/ISDN variants connecting to a digital ISDN(\*\*) line:
  - An ISDN variant compliant to ETSI standards
  - An ISDN variant compliant to both ETSI and ITU standards.

(\*) Plain Old Telephone Service (POTS)

(\*\*) Integrated Services Digital Network (ISDN)

---

## Terminology

For readability, the **Alcatel Speed Touch™Pro** will be referred to as **STPro** in this User's Guide.

---

## Safety instructions

Prior to connecting the **Alcatel Speed Touch™Pro**, read the Safety Instructions in appendix D.

---



**CAUTION**  
**WARNING**

The following words and symbols mark special messages throughout this document:

**WARNING:** indicates that failure to follow the directions could cause bodily harm or loss of life.

**CAUTION:** indicates that failure to follow the directions could result in damage to equipment or loss of information.

---



---

## Trademarks

The following trademarks are used in this document:

- ▶ Speed Touch™ is a trademark of the Alcatel Company
- ▶ Netscape® and Netscape Navigator® are registered trademarks of Netscape Communications Corporation
- ▶ Windows™ and Internet Explorer™ are trademarks of Microsoft Corporation
- ▶ Apple® and Mac®OS are registered trademarks of Apple Computer Inc.
- ▶ UNIX® is a registered trademark of UNIX System Laboratories, Inc.
- ▶ Ethernet™ is a trademark of Xerox Corporation.

Other products may be trademarks or registered trademarks of their respective manufacturers.

---

## Service Provider

For readability, the term Service Provider (SP) will be used to designate all organizations which provide either DSL connectivity, Internet access or Corporate access, for example an Internet Service Provider (ISP).

---

## PC, workstation, terminal, ...

For readability, PC will refer to all involved computer devices which are able to interact with the **STPro**, i.e. Personal Computer (PC), Macintosh computer, workstation, (remote) terminal, etc.

---

## Disclaimer

All examples throughout this document refer to :

- ▶ "Net 10" IP addresses for local network configurations
- ▶ VPI 0, or VPI 8 to identify the Virtual Path (VP) on the DSL line.

However, your SP might prefer other values.

---

---

## **User's Guide updates**

Due to the continuous evolution of the Alcatel DSL technology, existing products are regularly upgraded. Alcatel documentation changes accordingly.

For more information on the newest technological changes and documents, please consult the Alcatel web site at following Uniform Resource Locator (URL):

*<http://www.alcatel.com>*

*<http://www.alcateldsl.com>*

---

# 1 Speed Touch Quick Guide

---

**Aim of this Quick Guide** Use this chapter to quickly connect your **STPro** to the Internet.

---

**In this chapter**

Topic	See
Get Acquainted with your <b>STPro</b>	1.1
<b>STPro</b> Installation	1.2

---

## 1.1 Get Acquainted with your Speed Touch

---

- Delivery check** Check your **STPro** package for the following items:
- ▶ The **Alcatel Speed Touch™ Pro**
  - ▶ 1 Power supply adapter with 2m (6.56ft.) connecting cable
  - ▶ 2m Cat.5 straight-through Ethernet/ATMF cable (RJ45/RJ45)
  - ▶ 2m DSL cable (RJ11/RJ11, RJ14/RJ14)
  - ▶ This User's Guide, either in hard copy format or on CD-rom.
- 

**Damaged or missing items** In the event of damaged or missing items, contact your local product dealer for further instructions.

---

**Other materials** Your **STPro** shipping carton may also include release notes, safety and conformity declarations, and other materials.

---

**Your STPro** Your **STPro** is presented in a slim line box:



For a detailed information and a LED description, refer to appendix B.

---

### **ADSL/POTS and ADSL/ISDN**

Three **STPro** variants exist:

- ▶ The ADSL/POTS **STPro** variant
- ▶ The ADSL/ISDN (ETSI) **STPro** variant
- ▶ The ADSL/ISDN (ETSI/ITU) **STPro** variant.

---

### **STPro models**

Three **STPro** models can be identified:

- ▶ The single 10Base-T Ethernet port **STPro** model
- ▶ The dual port **STPro** model with both 10Base-T Ethernet port and ATM Forum - 25.6 Mbps (ATMF-25.6) port
- ▶ The integrated 10Base-T four port Ethernet hub **STPro** model.

To determine your model, refer to appendix B.

---

**Identify your variant**

Use only the **STPro** variant which is appropriate for the DSL service delivered to your local premises.

Identify your **STPro** via the marking label on the bottom:

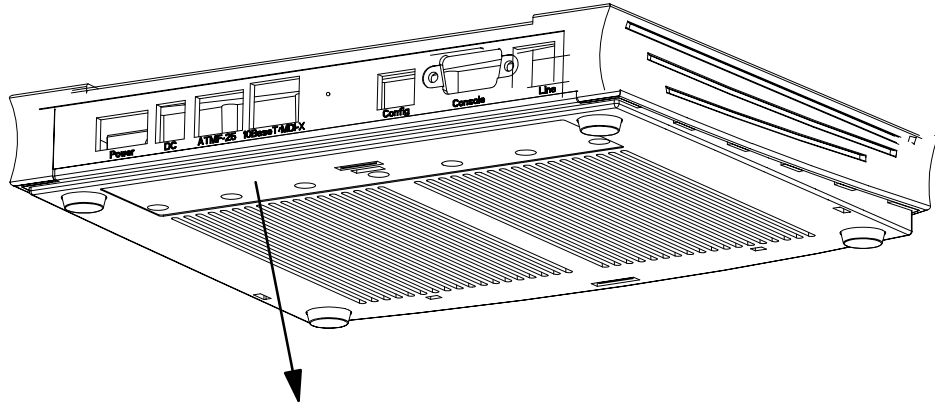

In the figure above, an example is provided of the marking label for an ADSL/POTS **STPro**.

**Note:** For ADSL/ISDN variants, the description **POTS** is replaced by **ISDN**.

The North-American market uses exclusively ADSL/POTS models. The marking label is similar to the example below:

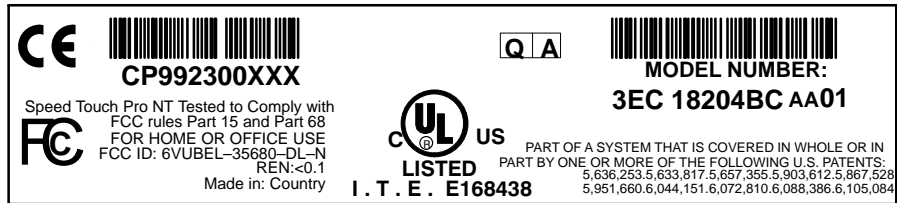

## 1.2 Speed Touch Installation

---

**Aim of this section** Execution of the steps in this section will bring you on the Internet in no time.

---

**In this section**

Topic	See
What you Need	1.2.1
<b>STPro</b> Wiring	1.2.2
Check your SP's Service Offerings	1.2.3
Configure your <b>STPro</b> (If Necessary)	1.2.4
Surf the Internet	1.2.5
Detailed <b>STPro</b> Information	1.2.6

---

## 1.2.1 What you Need

---

**DSL service** Depending on the **STPro** variant you purchased, the following DSL service must be available at your local premisses:

- ▶ ADSL/POTS  
ADSL service must be enabled on your POTS telephone line.
- ▶ ADSL/ISDN  
ADSL service must be enabled on your ISDN telephone line.

As both telephone and ADSL service are simultaneously available from the same copper pair, you need a central splitter, or distributed filters for decoupling ADSL and telephone signals.

Contact your SP for more information.

---

**Local networking** To use the Ethernet port(s) you need at least:

- ▶ One PC with an Ethernet 10Base-T PC-Network Interface Card (NIC) installed.
- ▶ For local networking, a 10Base-T hub (if needed) and the necessary connection cables.

To use the (optional) ATMF-25.6 port you need:

- ▶ A PC with an ATMF-25.6 PC-NIC installed.
  - ▶ For ATM networking, a workgroup ATM switch.
- 

**Accessing the STPro** For local configuration via HTTP/HTML, you need:

- ▶ A TCP/IP protocol suite
- ▶ A Web browser.

For native Command Line Interface (CLI) you need:

- ▶ A serial cable
  - ▶ An ASCII terminal (VT100), or a PC with ASCII terminal emulation.
-



## 1.2.2 STPro Wiring

- You must wire**
- ▶ The Ethernet Port(s) (10Base-T)
  - ▶ The Optional ATMF-25.6 Port (ATMF-25)
  - ▶ The DSL Port (Line)
  - ▶ The Power Port (DC).

---

**Ethernet port(s) (10Base-T)** Use the included LAN cable to wire your PC's Ethernet port to **STPro's** Ethernet interface.  
Refer to section 2.2 for more information.

---

**Optional ATMF-25.6 port (ATMF-25)** Use the included LAN cable to wire your PC's ATMF-25.6 port to the **STPro's** ATMF-25.6 port.  
Refer to section 2.3 for more information.

---

**DSL port (Line)** Use the included DSL cable to wire the **STPro's** Line port to your DSL wall outlet.  
Refer to section 3.2 for more information.

---

**Power port (DC)** Firstly check whether the included mains adapter suits the local power specifications. If you are not sure of the regional power conditions, check the adapter's specifications in section B.5, and your local power company.  
Plug the adapter's coaxial jack into the **STPro's** receptacle marked 'DC'.  
Refer to section 3.3 for more information.

---

**Check your wiring** Once all connections are made, the result should look similar as below:

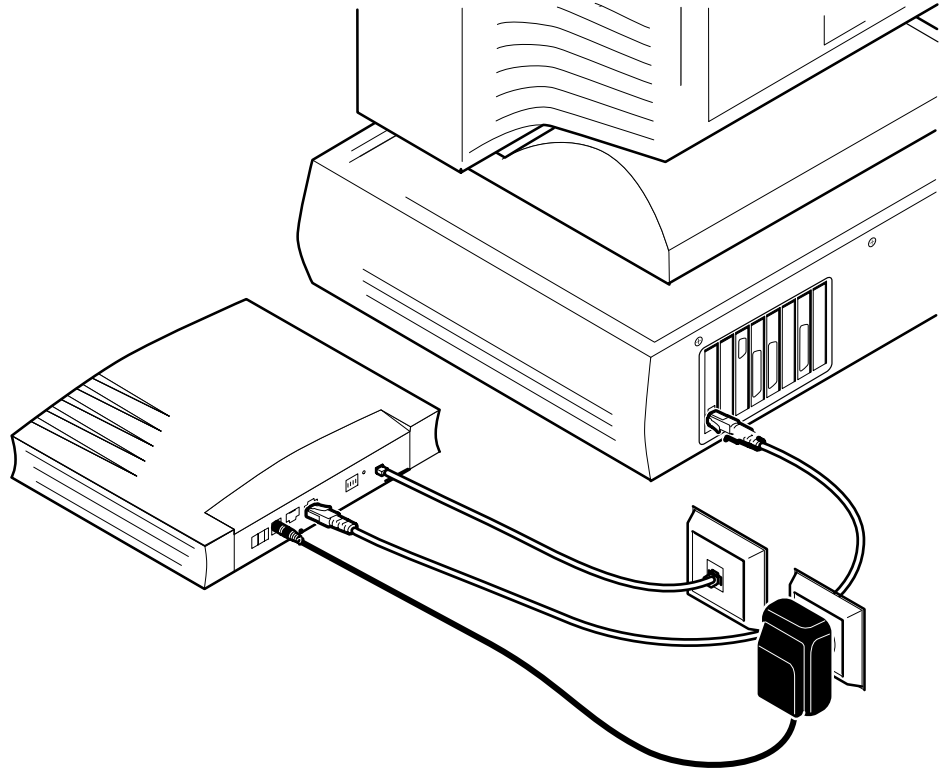

**Turn on your STPro** Once all previous steps are completed, turn on your **STPro**. The **STPro** is ready for service as soon as the start-up procedures are completed, the Power On Self Test (POST) is passed and both *Power/Alarm* and *Line Sync* LEDs on the front panel are constantly lit green.

Refer to section B.2 for more information.

---

## 1.2.3 Check your Service Provider's Offering

---

- Service offering** The SP provides at least the following information:
- ▶ The **VPI/VCI** of the Virtual Channel (VC) to use on the DSL line
  - ▶ The **Packet Service** supported on this VC
  - ▶ The **Encapsulation Method** (if different from the Packet Service's default encapsulation).

**Example:**

- ▶ VPI/VCI = 0/35
- ▶ Packet Service = Transparent Bridging
- ▶ Encapsulation Method : Bridge default, i.e. LLC/SNAP

Your **STPro** supports multiple simultaneous VCs on the DSL line. If your SP exploits this capability, he will provide this information per VC.

---

- Selection criteria** For more information on the criteria to prefer one Packet Service over the other, see chapter 5.
- 

- Default STPro VPI/VCI settings** The VPI/VCI value of the default configured VCs are listed in appendix C.

In the event that the provided VPI/VCI differ with the **STPro** defaults, you can change VC settings via the **STPro** pages. See section 11.3 for more information.

---

## 1.2.4 Configure your STPro (If Necessary)

---

**STPro access** In most cases your **STPro** provides instant Internet connectivity as it features well chosen defaults

In exceptional cases additional or advanced configurations are desired, the **STPro** offers various access methods:

- ▶ Its web interface (See chapter 17)
  - ▶ A Telnet CLI session (See subsection 18.1.1)
  - ▶ A Serial CLI session (See subsection 18.1.2).
- 

**STPro Configuration** Configure the **STPro** via its web interface.

Most **STPro** topics have a dedicated page, e.g. for Bridging, DHCP, DNS, etc. Context related Help pages provide detailed information.

For profound configurations use the Command Line Interface (CLI).

---

## 1.2.5 Surf the Internet

---

**Finishing setup** After wiring (and optionally configuring) the **STPro** you are ready to surf the Internet.

---

**Access methods** Depending on the selected packet service(s), there is:

- ▶ Always-On Access
- ▶ Dial-In Access.

---

**Always-on access** With *Transparent Bridging* and *CIP & IP Routing*, no connection procedure is needed. Turn on the **STPro** and you are online.

**Note:** Although no access procedure is needed, some SPs require authentication before granting access to their resources.

---

**Dial-in access** A main feature of the **STPro** is support for traditional Dial-in connectivity to a Remote Access Server (RAS) via its *PPPoA-to-PPTP Relaying* and *PPP & IP Routing* packet services.

Manually establish a connection via the **STPro** pages or via Operating System (OS) dependent dial-in applications.

Most dial-in procedures require a user name and password for identification and authentication.

---

## 1.2.6 Detailed STPro Information

**The STPro is more than  
"just" a DSL router**

Use the following parts to explore **STPro's** advanced features:

Alcatel Speed Touch™ Quick Guide	1
<b>Alcatel Speed Touch™ Wiring Guide</b>	
Ethernet and ATMF-25.6	2
DSL, Power and Console	3
Resumé	4
<b>Alcatel Speed Touch™ Configuration and Use</b>	
Packet Services	5
Transparent Bridging	6
Bridged PPPoE	7
PPPoA-to-PPTP Relaying	8
PPP & IP Routing	9
CIP & IP Routing	10
<b>Alcatel Speed Touch™ Networking</b>	
ATM	11
IP	12
DNS	13
<b>Alcatel Speed Touch™ Maintenance</b>	
Alcatel Speed Touch™ Software	14
Alcatel Speed Touch™ Password	15
Alcatel Speed Touch™ To-Defaults	16
Alcatel Speed Touch™ Web Interface	17
Alcatel Speed Touch™ CLI	18
<b>Alcatel Speed Touch™ Appendices</b>	

---

# Alcatel Speed Touch™ Pro

## Wiring Guide

---





## 2 Wiring Guide – Ethernet and ATMF-25.6

---

**In this chapter**

Topic	See
LAN Cables	2.1
Connecting Ethernet	2.2
Connecting ATMF-25.6 (Optional)	2.3
Ethernet vs. ATMF-25.6 Connectivity	2.4

---

## 2.1 LAN Cables

**Included LAN cable** In your **STPro** package a full wired straight-through RJ45/RJ45 cable, further referred to as LAN cable is included.





**Using LAN cables** You can use *LAN cables* other than the one provided in the box, e.g. crossover LAN cables. However, make sure that these have the correct layout.

See section B.6 for more information on how to identify straight-through and crossover LAN cables.

**Note:** As the included LAN cable is fully wired, it can also be used for connecting the **STPro**'s ATMF-25.6 port.

### LAN cable types vs. port types

Determine the LAN cable type from the following table:

Speed Touch™	Other equipment	Type of LAN cable	Symbol
MDI-X	MDI-X	Crossover	
	MDI	Straight-through	
ATM-Network	ATM-Network	Crossover	
	ATM-End	Straight-through	

**Equipment and ports** PC Ethernet ports are always of type MDI; ATM PC-NIC ports are always of type ATM-End.

Ethernet hub ports are of type MDI-X; ATM switch ports are of type ATM-Network.

**Note:** You may use the (switchable) "uplink" or "cascade" MDI port which is sometimes present on Ethernet hubs. However, make sure to use the correct cable type.

## 2.2 Connecting Ethernet

### In this section

---

Topic	See
Ethernet Port(s) on your <b>STPro</b>	2.2.1
Single PC Ethernet Wiring	2.2.2
LAN Ethernet Wiring	2.2.2

---

## 2.2.1 Ethernet Port(s) on your STPro

### Ethernet interfaces

Each Ethernet port ① of the **STPro** is a 10Base-T *Half Duplex* Ethernet interface of type MDI-X:

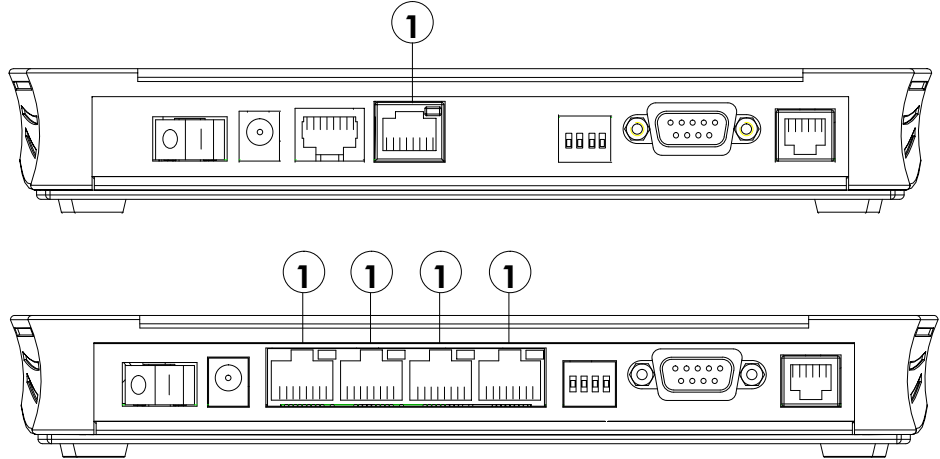

### Ethernet port(s) LED

Each Ethernet port on the rear panel has a LED:

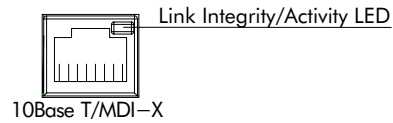

Indicator			Description
Name	Color	State	
Integrity Activity	Green	Off	No connection on this port.
		On	Ethernet link up.
		Flashing	Data is flowing from/to this Ethernet port. (hub only)



### 10Base-T Half Duplex Interfacing

Make sure the 10Base-T port(s) of your PC(s) are configured for either Auto Negotiation or Half Duplex.

Never configure the 10Base-T Ports for Full-Duplex !

## 2.2.2 Single PC Ethernet Wiring

**Single PC configuration** In this configuration the **STPro** is connected to a single PC. Your “LAN” consists of only one PC and the **STPro**.

**Procedure** Proceed as indicated in the following figure to connect your **STPro** to a single PC:

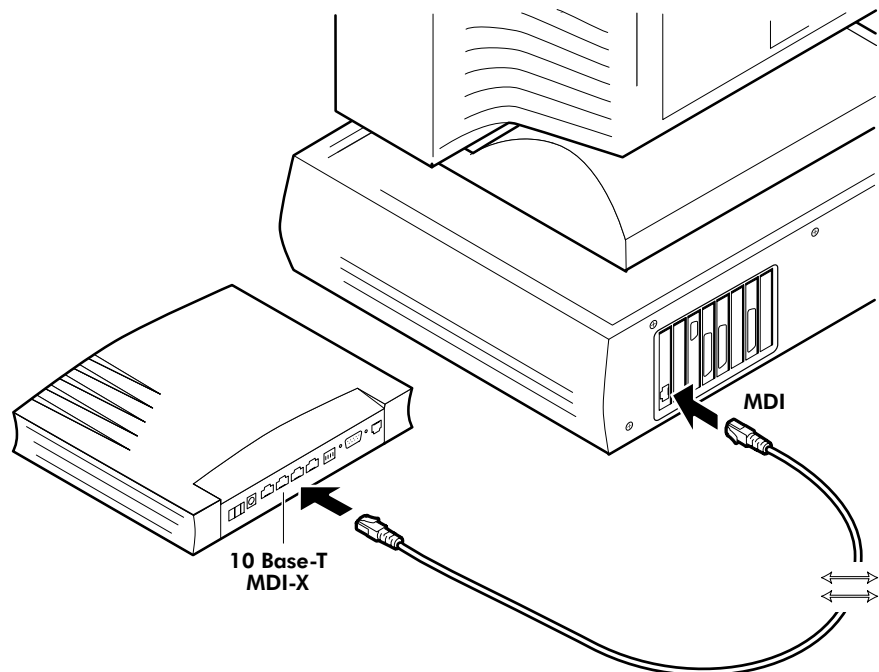

## 2.2.3 LAN Ethernet Wiring

**Procedure** Proceed as indicated in the following figure to make the connections for a LAN (**STPro** hub specific connections are shaded gray):

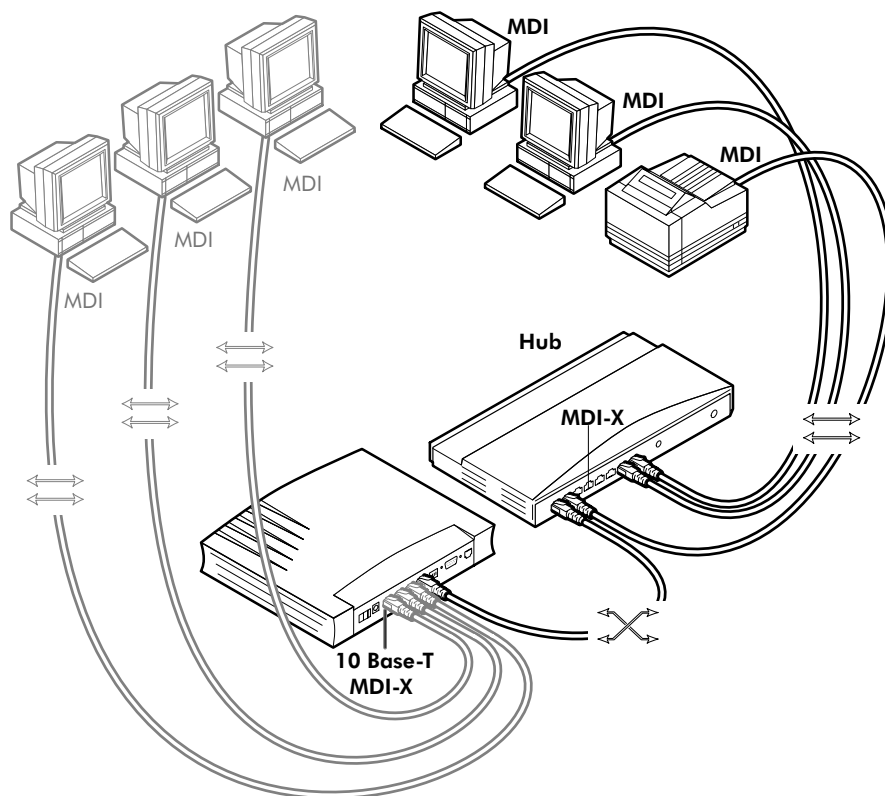

### Cascading Repeating Hubs

You may cascade up to four repeating hubs in your LAN (limitations of Repeating Ethernet V2.0/IEEE802.3 hubs). In case more hubs need to be cascaded, you must use switching hubs.

### MDI vs. MDI-X hub ports and the STPro

In the above figure an MDI-X port on the hub connects to the **STPro**. Therefore, a crossover LAN cable is used.

**Note:** In case the hub's "uplink" port is used to wire the **STPro** you can use the included straight-through LAN cable.

## 2.3 Connecting the ATMF-25.6 Port (Optional)

**Check your STPro model** This connection procedure applies solely to the dual port **STPro** model.

**ATMF-25.6 port** The ATMF-25.6 port on the single Ethernet port **STPro** model is an ATM Forum 25.6 Mbit/s compliant interface of type "ATM Network Equipment"; the PC-NIC's ATMF-25.6 port is of type "ATM End Equipment".

**Procedure** Proceed as indicated in the following figure to connect the **STPro** ATMF-25.6 port to your PC's ATMF-25.6 PC-NIC using the included straight-through LAN cable:

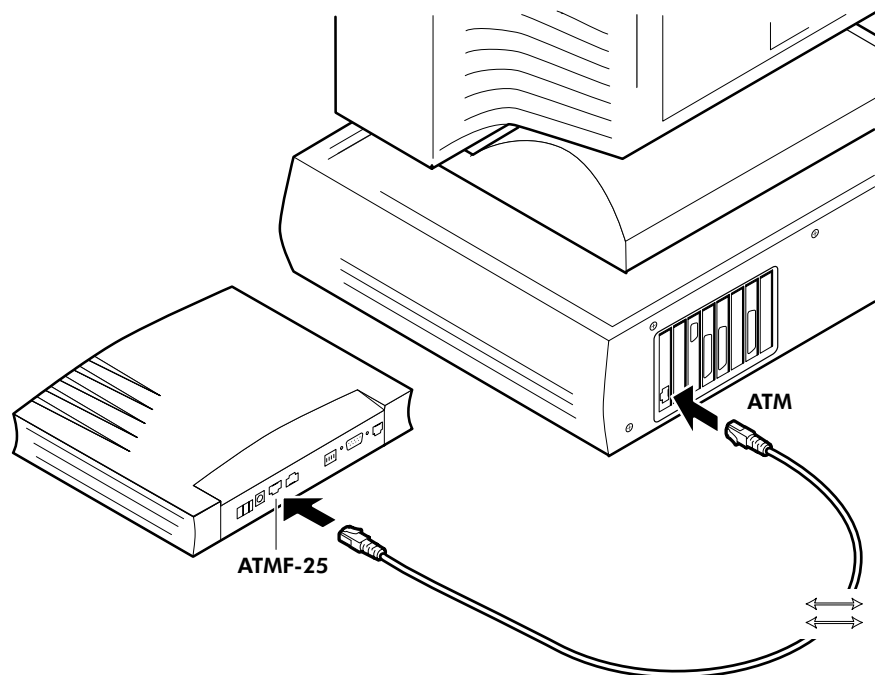

## 2.4 Ethernet vs. ATMF-25.6 Connectivity

---

**Ethernet port(s)** Due to its inherent support for networking, Ethernet will be your natural choice for creating a small LAN.

---

**ATMF-25.6 port** The (optional) ATMF-25.6 port provides excellent protocol transparency and native ATM application support.

---

**Concurrent use of both ports** The dual port **STPro** model is designed for the concurrent use of both Ethernet and ATMF-25.6 ports. Networking configurations remain equally valid if the ports are used simultaneously.

There is no performance penalty on this simultaneous use except for the sharing of the upstream and downstream DSL bandwidth.

---



## 3 Wiring Guide – DSL, Power and Console

---

**In this chapter**

Topic	See
Locating Ports	3.1
Connecting the DSL Port	3.2
Connecting the Power Adapter	3.3
Connecting the Serial Port (Optional)	3.4

---

## 3.1 Locating Ports

### Port description

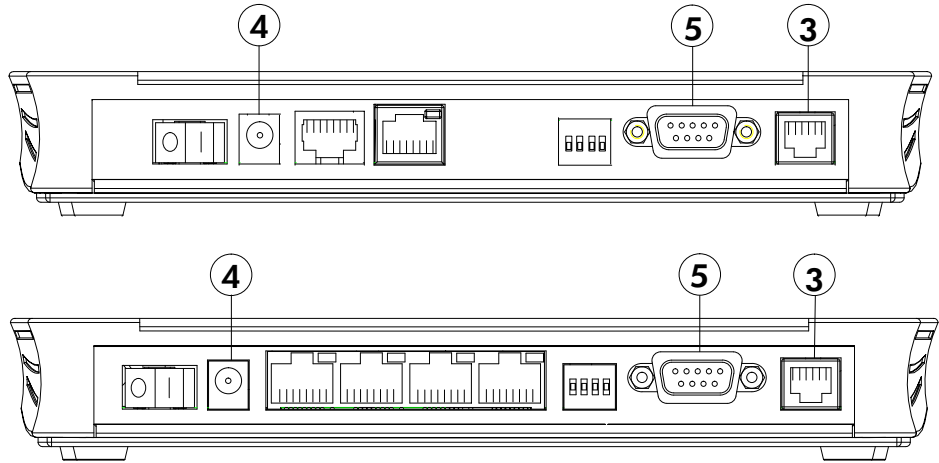

Following ports are used:

- ▶ ③: DSL line port, marked "LINE"
- ▶ ④: Power socket, market "DC"
- ▶ ⑤: Serial port, marked "Console".

## 3.2 Connecting the DSL Port

### Preconditions prior to connecting

A **central splitter** or **distributed filters** for decoupling DSL and POTS or ISDN signals must be installed on your telephone line or telephone wall outlets. In some cases crossover adapters might be required.

### Procedure

Proceed as indicated in the following figure to connect the **STPro** to the DSL line using the included black DSL cable:

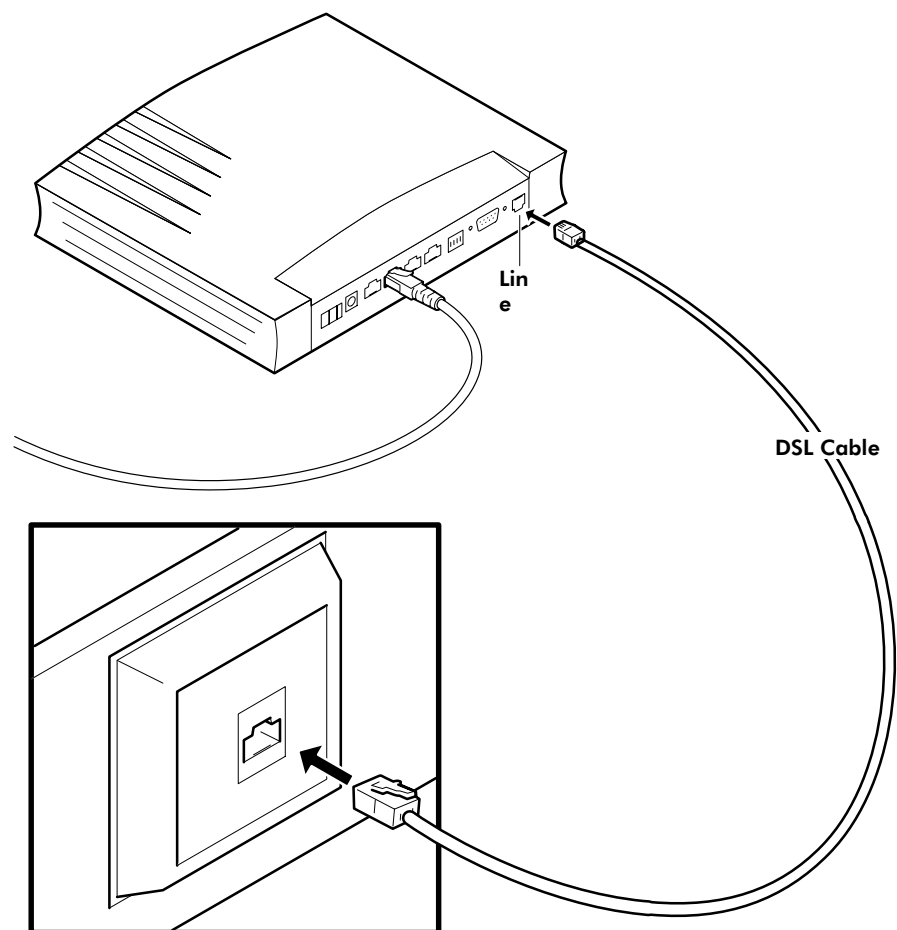

## 3.3 Connecting the Power Adapter

**Introduction** The **STPro** is delivered with a modular external power adapter converting the AC mains to 9V<sub>DC</sub>/1A unregulated output voltage.

**Power adapter types** Check if the power adapter included in the **STPro** package is compatible with your local electrical power specifications.  
See section B.5 for connector layout and output specifications.  
If you are not sure of the specifications of your local mains power, contact your local product dealer for more information.

**Procedure** Proceed as follows to connect the power supply adapter :

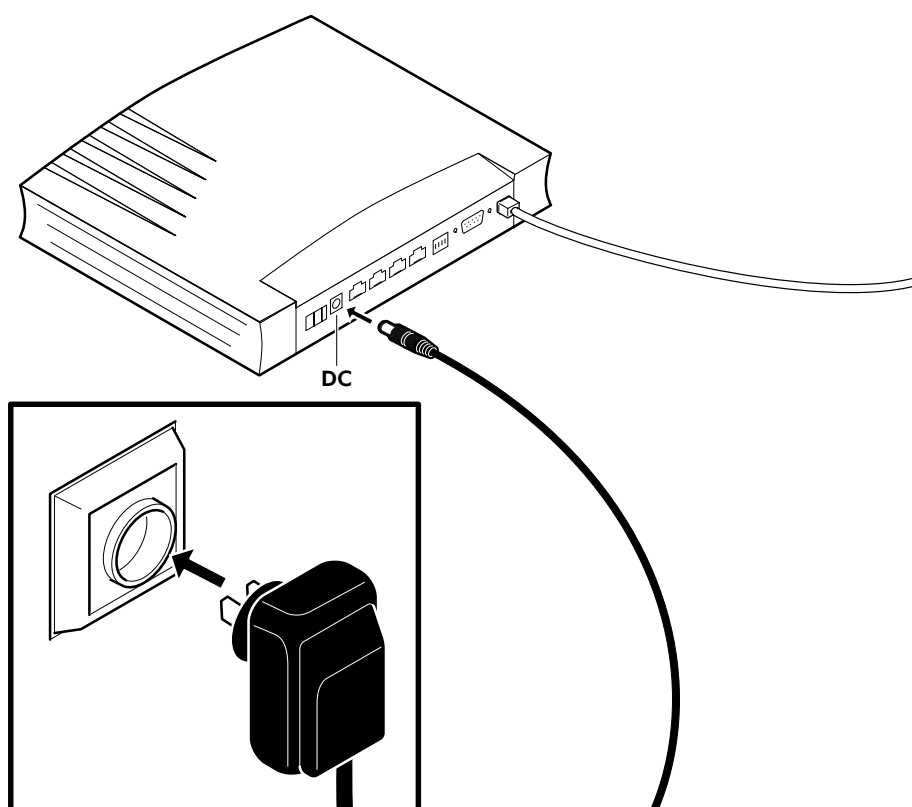

## 3.4 Connecting the Serial Port (Optional)

**Serial access** Like most routers the **STPro** carries a serial port on its back panel, featuring access from a remote host via a modem connection or local access from a terminal.

**Requirements for using the serial access** For access via the serial port, you must have the following:

- ▶ A serial cable
- ▶ An ASCII terminal (VT100) or a workstation/PC with ASCII terminal emulation or emulation application for local configuration via the CLI

or

- ▶ A POTS or ISDN modem for remote configuration of the **STPro** via the CLI.

**Procedure** Proceed as follows to connect the **STPro** serial port:

Step	Action
1	Determine the serial port on the <b>STPro</b> back panel. See appendix B for more information.
2	Connect the serial cable to the <b>STPro</b> serial port.
3	Connect the other end of the serial cable to the serial interface of the (emulated) ASCII terminal or modem.



## 4 Wiring Guide – Resumé

**After wiring** The following illustrations show some of the wiring configurations possible for the **STPro** once all of the connections have been made:

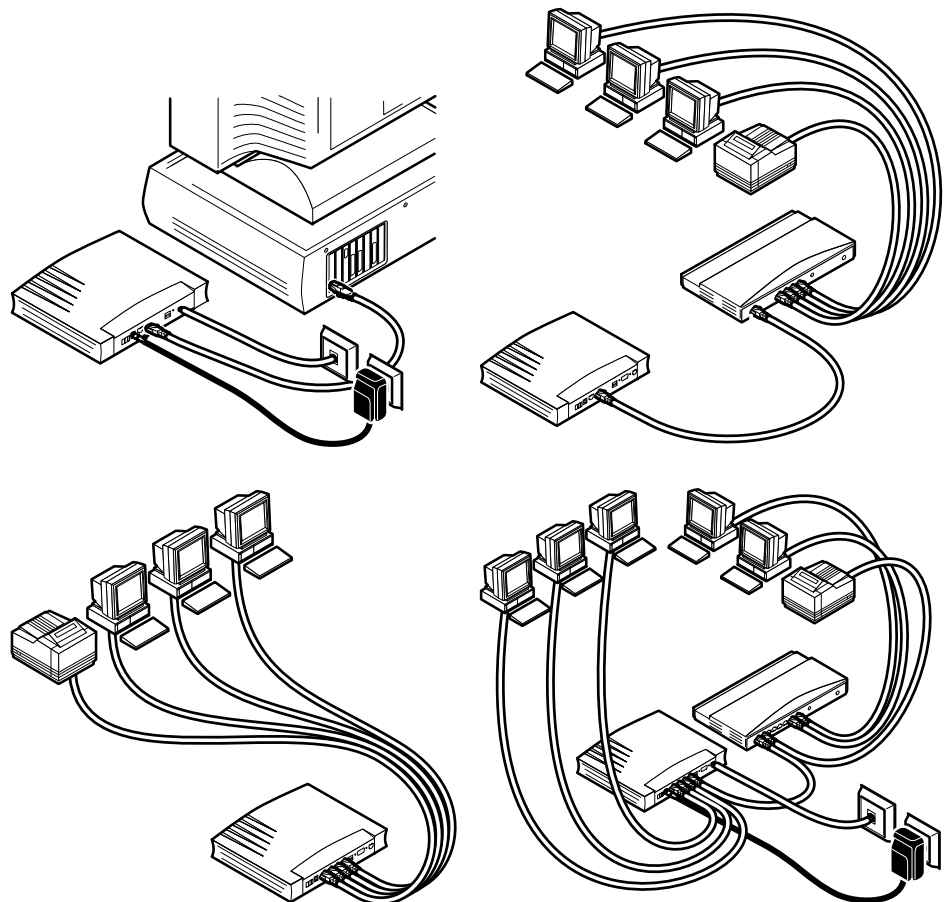





---

# Alcatel Speed Touch™ Pro

## Configuration and Use

---



## 5 Configuration and Use – Packet Services

---

### In this chapter

Topic	See
Supported Packet Services	5.1
Packet Services at a Glance	5.2
Selection Criteria	5.3

---

## 5.1 Supported Packet Services

---

**What is a packet service ?** *Packet services are the core functions of the **STPro**. They provide that frames or packets get forwarded from the LAN side towards the DSL line and vice versa.*

---

- Six packet services**
- ▶ Transparent Bridging
  - ▶ Bridged PPPoE
  - ▶ PPPoA-to-PPTP Relaying
  - ▶ PPP & IP Routing
  - ▶ Classical IP & IP Routing
  - ▶ ATM cell switching (\*).
- (\* Requires the optional ATMF-25.6 port.
- 

**Multiprotocol** All examples in this User's Guide are based on the Internet Protocol (IP) suite.

However, the **STPro** DSL router is a true multiprotocol device: it can easily handle most other popular protocol suites

---

**Examples in this User's Guide** This User's Guide presents typical configurations, but as an experienced user you are free to experiment and to find an optimal configuration.

---

## 5.2 Packet Services at a Glance

---

**Access methods** The **STPro** supports two access methods:

▶ **Direct access**

Once initial configuration is done, continuous and immediate access is available via the DSL line.

For direct access use either of:

- Transparent Bridging
- CIP & IP Routing.

▶ **Dial-in access**

In this mode access must be explicitly established, e.g. by “dialing” into a Remote Access Server (RAS).

For dial-in access use either of:

- Bridged PPPoE
  - PPPoA-to-PPTP Relaying
  - PPP & IP Routing.
- 

**Forwarding methods** As their names imply the packet services can be differentiated in two groups:

▶ Forwarding packet services:

- Transparent Bridging
- Bridged PPPoE
- PPPoA-to-PPTP Relaying.

These packet services forward frames unmodified.

▶ Routing packet services:

- PPP & IP Routing
- CIP & IP Routing.

These packet services, combined with NA(P)T allow to share a single IP address amongst multiple users on the LAN.

---

**Transparent Bridging** The **STPro IEEE802.1D Transparent Bridging** packet service (further referred to as *Bridging*) offers complete protocol transparency and has inherent configuration simplicity. Yet it provides excellent forwarding performance.

---

**PPPoE** PPPoE is one of two popular mechanisms to get in touch with the SP.

- ▶ **Bridged PPPoE**  
By installing a PPPoE client application (provided by your SP) on your PC(s) and by using the **STPro's** bridge, connectivity can be established.
- 

**PPPoA** The other method to get in touch with the SP over the DSL line is PPPoA.

- ▶ **PPPoA-to-PPTP Relaying**  
Similar to Bridged PPPoE this requires installation of a PPTP dial-in application (\*) on your PC(s).
- ▶ **PPP & IP Routing**  
PPPoA SP access can equally be accomplished by the embedded PPPoA dial-in client of the **STPro**.

(\*) Most popular OSs have a PPTP dial-in application installed, e.g. Microsoft Dial-Up Networking or support PPTP Tunneling software to be installed.

---

**CIP & IP Routing** The **STPro IP** router can also be combined with *Classical IP (CIP)*. *Classical IP* is a mature technique for creating classical IP networks on top of ATM technology. It is widely supported by most, if not all remote access routers.

Although not the original aim of *Classical IP* it is mostly used for connecting routers over wide area point-to-point links.

---

**Packet services resumé** All **STPro**'s packet services can be summarized as follows:

Port	Packet Service	User/VC	IP Address	Protocol
10Base-T	Bridging	n	1 per user	Multiprotocol
Ethernet	Bridged PPPoE	n	1 per user	Multiprotocol (*)
	PPPoA/PPTP	1	1 per user	Multiprotocol (*)
	PPP & IP Routing	n	1 (via NAPT)	IP Suite
	CIP & IP Routing	n	1 (via NAPT)	IP Suite
ATMF-25.6 (optional)	ATM Cell Switching The functionality of ATM Cell switching depends on the capabilities, offered by the drivers included with the ATMF-25.6 PC-NIC.			

(\*) The supported protocol(s) depend on the provisioning by the session client application, e.g. IP, IPX and NETBEUI for Microsoft's Dial-Up Networking application for PPPoA-to-PPTP Relaying.

### Detailed packet service use description

For more information on the configuration and use of all of the **STPro** packet services, see for:

- ▶ Transparent Bridging: chapter 6
- ▶ Bridged PPPoE: chapter 7
- ▶ Relayed PPPoA: chapter 8
- ▶ Routed PPPoA: chapter 9
- ▶ Classical IP & IP Routing: chapter 10.

## 5.3 Selection Criteria

- 
- In this section**
- ▶ Selection Criteria
  - ▶ Simultaneous Use of Packet Services.
- 

**Selection criteria** The criteria below can help you to select the most appropriate packet service for your application:

- ▶ The configuration required by your SP
  - ▶ The application protocol you wish to use (within the boundaries of the remote end)
  - ▶ The access method: an “Always-on” connection or a connection that is established when needed, i.e. “Dial-in”
  - ▶ Connectivity to a single or multiple remote networks
  - ▶ Security features such as identification, authentication, encryption and NA(P)T
  - ▶ DSL modem vs DSL gateway model.
- 

**Simultaneous use of packet services** All packet services can be active at the same time without any restriction. The **STPro** can manage any combination of the packet services simultaneously up to a maximum number of 12 configured virtual connections.

**Note:** For Transparent Bridging (including Bridged PPPoE) the maximum number of configured Bridging ports is four.

---



## 6 Configuration and Use – Transparent Bridging

---

- Introduction** *Transparent Bridging* is the packet service of your choice as it:
- ▶ Is platform and OS independent
  - ▶ Is true multiprotocol
  - ▶ Has no performance limitations in the Alcatel implementation
  - ▶ Has almost no constraints on the number of attached users.
- 

**In this chapter**

Topic	See
Preparatory Steps	6.1
Using Bridging	6.2
Bridging Configuration	6.3
Bridge Data	6.4

---

## 6.1 Preparatory Steps

- Needed information**
- ▶ **VPI/VCI** value of the VC(s) to use on the DSL line
  - ▶ **Transparent Bridging service** must be supported on these VCs
  - ▶ **Encapsulation** method (LLC/SNAP)
  - ▶ The PC's IP configuration: static or dynamic (DHCP).

**Note:** The RFC1483 is updated by RFC2684. The **STPro** fully complies with the relevant sections in both RFCs.

---

**Multiple destinations** You can attach up to four connections (VCs ) to the bridge. To conserve DSL upstream bandwidth do not attach more connections than needed.

---

**PC(s)** Bridging does not impose specific requirements to your PC's protocol layers. However, make sure that these are properly installed and configured.

In all subsequent examples, TCP/IP will be used.

---

**TCP/IP** For TCP/IP, your SP will assign either static IP parameters or will ask to enable DHCP (per PC).

---



### Transparent Bridging and DHCP

If the SP requires you to use DHCP on your local PC(s), you must disable the **STPro** DHCP server.

This is to avoid conflicts between two DHCP servers.

See section 12.4 for more information.

---

## 6.2 Using Bridging

---

### Bridging configuration

Per default, following Bridging entry is preconfigured:

► **Br1** (Bridge on 8.35)

This entry is disabled per default. To enable it change its state into “*forwarding*” on the ‘*Bridge*’ page.

In case this Bridging entry does not meet your requirements, you can configure a new one as follows:

1. If needed, add a Bridging phonebook entry with the correct VPI/VCI on the ‘*Phonebook*’ page.
2. On the ‘*Bridge*’ page, select this phonebook entry from the ‘*Bridge Port*’ pop-down list.
3. For this entry, select the correct encapsulation method.
4. Click  .

See section 6.3 for more information.

---

### Using Bridging

Make sure your **STPro** is turned on first.

Turn on your PC(s), start your Web browser and you are on the Internet or have Corporate Intranet access.

Although the access method of the bridge is ‘*Always-on*’, the remote organization might ask for a user name and password.

---

## 6.3 Bridging Configuration

**Introduction** This section describes the use of the **STPro** 'Bridge' page.

- In this section**
- ▶ The 'Bridge' Page
  - ▶ The 'Bridging Ports' Table
  - ▶ 'Bridging Ports' Table Components
  - ▶ The 'Aging' Box
  - ▶ Adding Entries
  - ▶ Deleting Entries.

**The 'Bridge' page** Click **Bridge** in the left pane of the **STPro** pages to pop up the 'Bridging' page (See section 17.2 for more information):

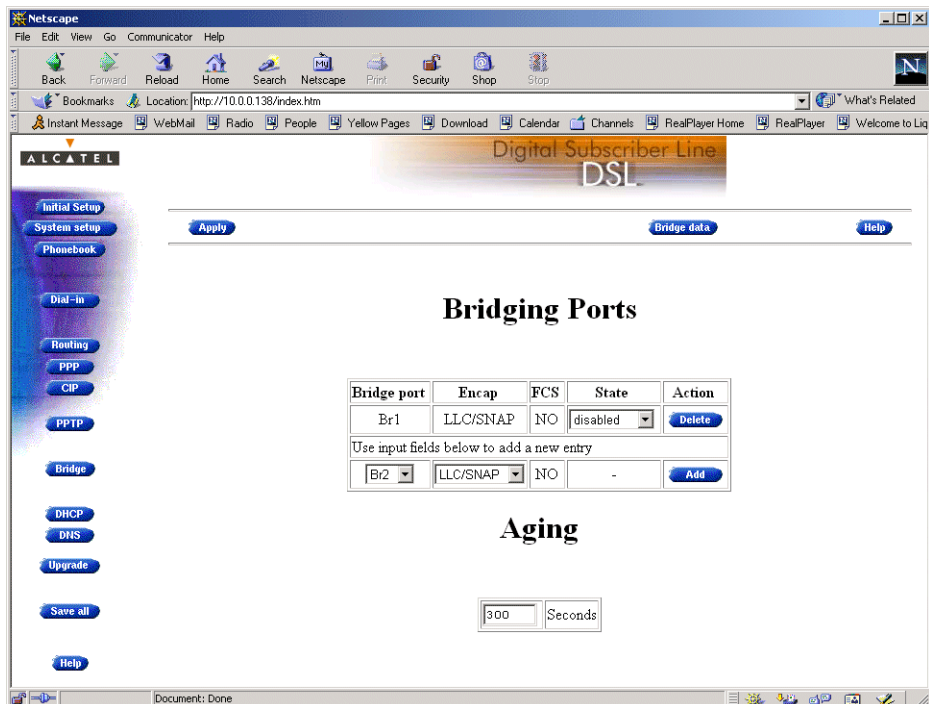

### The 'Bridging Ports' table

The following figure shows the 'Bridging Ports' table:

Bridge port	Encap	FCS	State	Action
Br1	LLC/SNAP	NO	disabled ▾	<b>Delete</b>
Use input fields below to add a new entry				
Br2 ▾	LLC/SNAP ▾	NO	-	<b>Add</b>

### 'Bridging Ports' table components

Field	Description								
Bridge Port	Indicates the phonebook entry used by the Bridging entry.								
Encap	Indicates the applied encapsulation method for Ethernet frames(*) on the VC.  The <b>STPro</b> supports both the LLC/SNAP method (default) and the VC-MUX method.								
FCS	Indicates whether the last four bytes of the Ethernet frames are preserved or not. By default the FCS is set to <b>NO</b> .  <b>Note:</b> You can set the FCS to <b>YES</b> via the CLI.								
State	Allows you to change the state of the individual LAN ports. It can take following values: <table border="1" data-bbox="762 1205 1380 1704"> <thead> <tr> <th>Value</th> <th>Description</th> </tr> </thead> <tbody> <tr> <td><b>disabled</b></td> <td>The Bridge port participates in the relaying of frames.  Source MAC addresses of frames, arriving in the Bridge via this port are also stored in the filtering database.</td> </tr> <tr> <td><b>learning</b></td> <td>The Bridge port only submits information to the filtering database.  It does not participate in the relaying of frames.</td> </tr> <tr> <td><b>forwarding</b></td> <td>The Bridge port in this state, does not participate in the relaying of frames, nor in updating the filtering database.</td> </tr> </tbody> </table> <p>By default, the sole configured Bridge port <i>Br1</i> is disabled.</p>	Value	Description	<b>disabled</b>	The Bridge port participates in the relaying of frames.  Source MAC addresses of frames, arriving in the Bridge via this port are also stored in the filtering database.	<b>learning</b>	The Bridge port only submits information to the filtering database.  It does not participate in the relaying of frames.	<b>forwarding</b>	The Bridge port in this state, does not participate in the relaying of frames, nor in updating the filtering database.
Value	Description								
<b>disabled</b>	The Bridge port participates in the relaying of frames.  Source MAC addresses of frames, arriving in the Bridge via this port are also stored in the filtering database.								
<b>learning</b>	The Bridge port only submits information to the filtering database.  It does not participate in the relaying of frames.								
<b>forwarding</b>	The Bridge port in this state, does not participate in the relaying of frames, nor in updating the filtering database.								

(\*) Ethernet frames are also referred to as Medium Access Control (MAC) frames or IEEE802.3 frames.

**The 'Aging' box** The following figure shows the 'Aging' box:



The image shows a configuration interface for the 'Aging' timer. It consists of two adjacent boxes. The left box is a text input field containing the number '300'. The right box is a dropdown menu with the word 'Seconds' selected and displayed.

It indicates the aging timer of the bridge internal database. If the aging time of a MAC entry has expired this entry will be removed from the database. Only in exceptional cases the default value of 300 seconds (5 minutes) needs to be modified. The allowed range is from 10 seconds to 12 days.

---

**Adding entries** Proceed as follows:

1. Browse to the 'Bridge' page.
  2. Select the phonebook entry from the 'Bridge port' pop-down list.  
**Note:** In case the presented phonebook entries do not suite your desired configuration, you must firstly create a correct phonebook entry. See section 11.3 for more information.
  3. Select the encapsulation method for the Bridging port from the 'Encap' pop-down list (per default set to LLC/SNAP).
  4. Click **Add** and **Save all** to finish the procedure.
- 

**Deleting entries** On the 'Bridge' page, click **Delete** next to the Bridging entry you want to delete. As a result your selection is deleted.

Click **Save all**.

---

## 6.4 Bridge Data

**Introduction** Transparent Bridging relies completely on its filtering database for its frame forwarding through the bridge. This filtering database is accessible via the 'Bridge' page and allows you to overview all current MAC entries.

**The 'Bridge Data' page** Click **Bridge data** on the 'Bridge' page to pop up the 'Bridge Data' page:

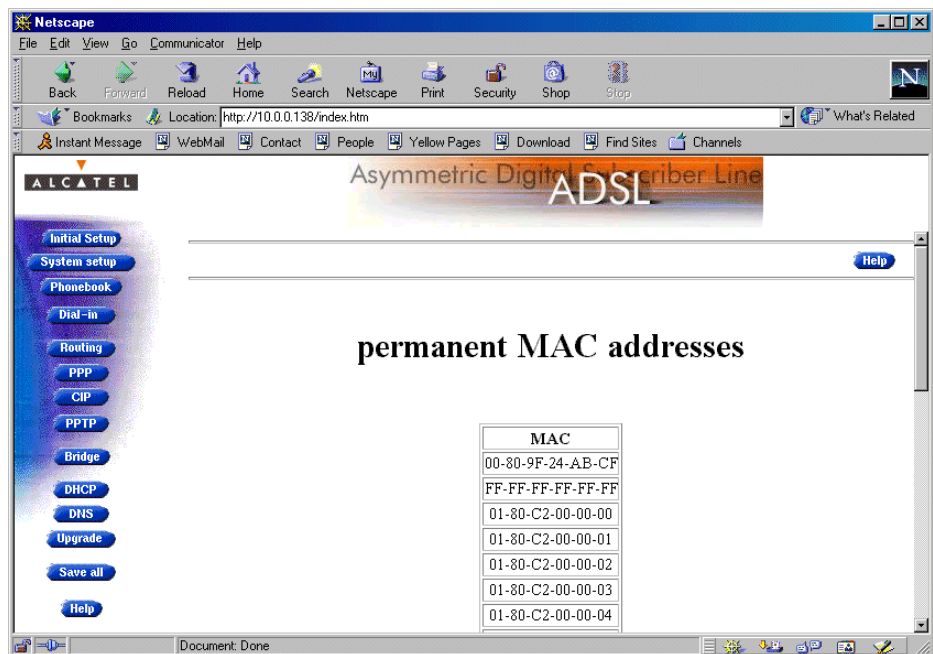

**Available 'Bridge Data' tables** All MAC entries are spread over 3 tables:

- ▶ The 'permanent MAC addresses' table
- ▶ The 'static MAC addresses' table
- ▶ The 'dynamic MAC addresses' table.

**Permanent MAC addresses**

These are the MAC addresses that must always be resident inside the bridge, as stipulated in the IEEE802.1D standard:

- ▶ The **STPro**'s own Ethernet MAC address:  
e.g. 00–80–9F–01–02–03
- ▶ The Broadcast MAC address:  
FF–FF–FF–FF–FF–FF
- ▶ The bridge group MAC address:  
01–80–C2–00–00–00
- ▶ The 16 reserved MAC addresses of IEEE802.1D:  
From 01–80–C2–00–00–01  
up to 01–80–C2–00–00–0F
- ▶ The all LANs bridge management group MAC address:  
01–80–C2–00–00–10

---

**Static MAC addresses**

This table lists the MAC addresses you have added to the filtering database via the CLI. These MAC addresses will never be aged by the bridge.

In principle, no static MAC addresses are to be configured.

---

**Dynamic MAC addresses**

This table lists all MAC entries added by the learning process of the Bridge.

If the aging time of a MAC entry has expired, i.e. its age equals the time indicated in the 'Aging' box, this entry will be removed from the list.

---



## 7 Configuration and Use – Bridged PPPoE

---

**Introduction** The **STPro** transparent bridge can be used in combination with a PPP over Ethernet (PPPoE) client installed on your PC. The resulting *Bridged PPPoE* packet service provides similar dial-in experience as found on point-to-point connections.

---

### In this chapter

Topic	See
Preparatory Steps	7.1
Using Bridged PPPoE	7.2
Bridged PPPoE Configuration	7.3

---

## 7.1 Preparatory Steps

- 
- Needed information**
- ▶ **VPI/VCI** value of the VC(s) to use on the DSL line
  - ▶ **Bridging packet service** must be supported on this VC
  - ▶ **Encapsulation** method (LLC/SNAP)
  - ▶ Remote access server must be a **PPPoE server**
  - ▶ **PPPoE client** to be installed
  - ▶ User name and password for your **user account**.
- 

**Multiple destinations** Up to four simultaneous Bridged PPPoE sessions can be active.  
**Note:** Per active Bridged PPPoE session a dedicated Bridging entry must be made available on the **STPro**. See section 7.3 for more information.

---

**PC(s)** To use Bridged PPPoE, a PPPoE client must be installed on your PC. The SP will provide the PPPoE client software. Contact him for more information.

---

## 7.2 Using Bridged PPPoE

---

### **Creating and using a PPPoE session instance**

Via the PPPoE client, you will be able to create PPPoE session icons, representing all the connection parameters, just like creating Dial-Up icons with Microsoft's Dial-Up Networking.

All you need is your user name and password for your account; although sometimes also a Service Name and/or Access Concentrator is required.

Check with your SP which Service Name and/or Access Concentrator to choose, if any.

For further details on how to fill in these parameters and use additional functionality, consult the User's Guide of your PPPoE client or follow the instructions of your SP.

---

## 7.3 Bridged PPPoE Configuration

---

**Introduction** As the Bridged PPPoE packet service implies nothing more than using the **STPro** Transparent Bridging packet service, no specific configuration for Bridged PPPoE is required on the **STPro**.

However, you may need to configure the *Transparent Bridging* packet service of the **STPro** in order to meet the requirements of your SP regarding VC(s) and encapsulation.

---

**Bridging configuration** Proceed as follows:

1. Browse to the 'Bridge' page.
2. Select the phonebook entry from the 'Bridge port' pop-down list.

**Note:** In case the presented phonebook entries do not suite your desired configuration, you must firstly create a correct phonebook entry. See section 11.3 for more information.

3. For this entry, select the correct encapsulation method from the 'Encap' pop-down list (per default set to LLC/SNAP).
4. Click **Add** and **Save all** to finish the procedure.

See section 6.3 for more information.

---

## 8 Configuration and Use – PPP-to-PPTP Relaying

**Introduction** *PPPoA-to-PPTP Relaying*(\*) is the packet service of your choice as it:

- ▶ Provides standard Dial-in PPP behavior
- ▶ Supports security via identification, authentication and encryption
- ▶ Has multiprotocol support depending on the PPTP implementation, e.g. for MS Windows: TCP/IP, IPX/SPX and NETBEUI
- ▶ Offers complete TCP/IP protocol transparency; no NAPT is required
- ▶ Supports concurrent access to multiple remote destinations (depending on provisioning).

(\*) PPPoA-to-PPTP Relaying is also referred to as Relayed PPP over ATM (PPPoA) or PPPoA/PPTP.

**See also** *PPP & IP Routing* packet service in chapter 9.

### Topics

Topic	See
Preparatory Steps	8.1
Using PPPoA-to-PPTP Relaying	8.2
Example: MS Windows 98 Dial-Up Networking	8.3
PPPoA/PPTP Configuration	8.4

## 8.1 Preparatory Steps

---

### What you should know in advance

- ▶ **VPI/VCI** value of the VC(s) to use on the DSL line
- ▶ **PPPoA/PPTP packet service** must be supported on this VC
- ▶ **Encapsulation** method (VC-MUX)
- ▶ Remote access server must be a **PPP(oA) server**
- ▶ User name and password for your **user account**.

---

### Multiple destination

The **STPro** can manage up to 12 PPPoA/PPTP connections simultaneously.

**Note:** Check with your SP or corporate whether multiple end-to-end connectivity is enabled.

---

### PC(s)

Your PC must support Point-to-Point Protocol (PPP) and Point-to-Point Tunnelling Protocol (PPTP).

**Note:** All Microsoft Windows platforms support PPP and PPTP.

A PPTP Dial-Up application must be installed on your PC.

**Note:** All Microsoft Windows platforms have a PPTP Dial-Up application installed per default.

---

### TCP/IP

Before you can establish PPTP tunnels, you must configure:

- ▶ An IP address in each PC which initiates a PPTP tunnel
- ▶ An IP address in the **STPro** which terminates the PPTP tunnel(s)

See chapter 12 for more information on IP.

---

## 8.2 Using PPPoA-PPTP Relaying

**Introduction** Before you can create a PPTP tunnel towards the **STPro**, firstly you must initially configure a PPTP dial-up connection on your PC. Once this PPTP dial-up connection is configured, you can use it to open a PPPoA/PPTP connection to the remote side of the DSL line. Because the configuration and use of such a connection follows similar patterns for all popular OSs, this section will describe the procedures in global. In section 8.3 an example is provided on how to create and use a PPTP Dial-Up icon in MS Windows 98.

### In this section

Topic	See
Preparing the PC for PPTP Tunneling	8.2.1
Using PPTP towards your <b>STPro</b>	8.2.2

## 8.2.1 Preparing the PC for PPTP Tunneling

---

### Creating a PPTP connection icon

Most, if not all OSs provide a Graphical User Interface (GUI) guided procedure for the initial creation of a PPTP connection icon.

The result of such creation is in most cases an icon or entry in a folder or a table called 'RAS', 'Dial-Up Networking', 'PPTP', 'Call sessions', 'Remote Access', etc.

---

### PPTP connection parameters

During the initial configuration of your PPTP connection icon, you must provide the following parameters:

- ▶ A name for the PPTP connection icon
- ▶ The VPN server's IP address or DNS hostname, i.e. the **STPro**'s IP address or DNS hostname

Optionally, you can complete this entry with

- ▶ The VC's PPTP phonebook name – configured on your **STPro** – to be used for this connection.

**Note:** Only in case multiple PPTP phonebook entries are directed towards different destinations, you must add the appropriate phonebook name to the dial-string. This allows the **STPro** to open the session to the correct specific destination. In case all PPTP phonebook entries are directed towards the same destination, it is better not to add a phonebook name to the dial-string.

---



## 8.2.2 Using PPTP towards your STPro

---

### PPPoA/PPTP configuration

Per default, following PPTP phonebook entries are available for PPPoA/PPTP connections:

- ▶ **RELAY\_PPP1** (PPTP on 8.48)
- ▶ **RELAY\_PPP2** (PPTP on 8.49)
- ▶ **RELAY\_PPP3** (PPTP on 8.50)
- ▶ **RELAY\_PPP4** (PPTP on 8.51)

In case these PPTP phonebook entries do not meet your requirements, you can configure a new one.

See section 11.3 for more information.

---

### Opening a session

Depending on your OS, you can open a session by either double-clicking the PPTP session icon or selecting it from a RAS table and clicking 'Dial-Up' or 'Connect'.

---

### Credentials

Before you can actually browse the Internet or contact the remote side's resources, you must supply the following credentials:

- ▶ A user name
- ▶ An associated password.

**Note:** Most, if not all OSs allow the credentials to be saved.

---

## 8.3 Example : MS Windows 98 Dial-Up Networking

---





**In this section** The following overview summarizes the necessary steps to setup a Microsoft Windows 98 PC for the use of PPPoA-to-PPTP Relaying:



Step	Action	See
1	Configure a <i>Private</i> IP address on your PC	
2	Create a new Dial-Up Networking icon	8.3.1
5	Open a Dial-Up Session	8.3.2
6	Surf the Internet.	
7	Close a Dial-Up Session in Use	8.3.3

---

## 8.3.1 Create a New Dial-Up Networking Icon

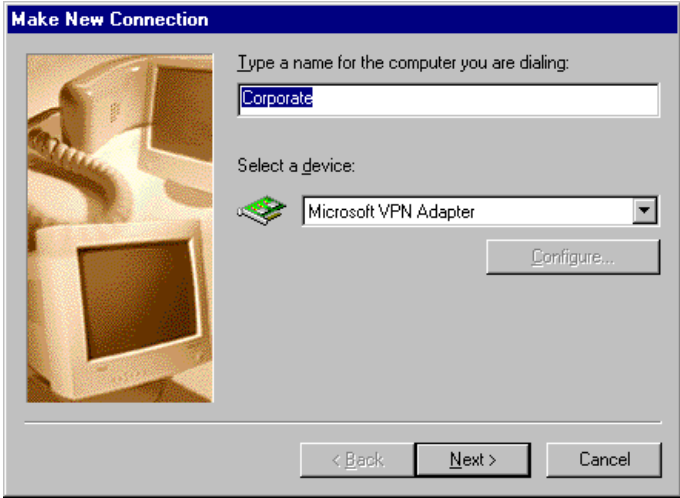
**Procedure** Proceed as follows:

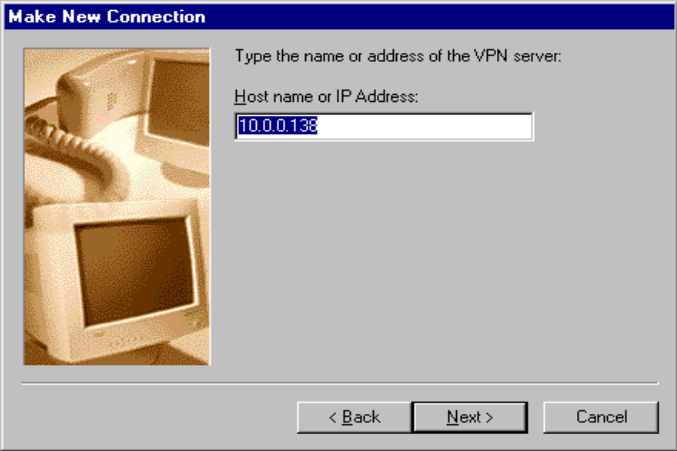
Step	Action and Description
1	Double-click the 'My Computer' icon on your desktop.  My Computer
2	Double-click the 'Dial-Up Networking' icon.  Dial-Up Networking
3	Double-click the 'Make New Connection' icon to activate the 'Make New Connection' wizard.  Make New Connection
4	If you use the Dial-Up Networking application for the first time, the 'Welcome to Dial-Up Networking' window appears. In that case, click  The 'Make New Connection' window pops up: 

Step	Action and Description
5	<p>In the first input field of the 'Make New Connection' window, type a name, e.g. an alias for the organization you are connecting to.</p> <p><b>Note:</b> This name will appear below the Dial-Up icon at the end of this procedure.</p>
6	<p>In the 'Select a device' listbox of the 'Make New Connection' window you must select the 'Microsoft VPN Adapter' for PPTP tunneling.</p>
7	<p>Click  to pop up the VPN server window:</p> 
8	<p>Enter the DNS hostname or IP address of the Virtual Private Network (VPN) server.</p> <p><b>Note:</b> "VPN server" is another word for PPTP server, which is in this case your <b>STPro</b>.</p> <p>The default IP address for the <b>STPro</b> is 10.0.0.138. Its default hostname is "SpeedTouch".</p> <p>Optionally, you can add the phonebook name to specify which VC is to be used for the connection.</p>
9	<p>A window pops up confirming that you have successfully installed a new Dial-Up connection.</p> <p>Click  to finish the procedure.</p>

**Result** A new icon with the name of the connection you have just created will be added to your 'Dial-Up Networking' folder:

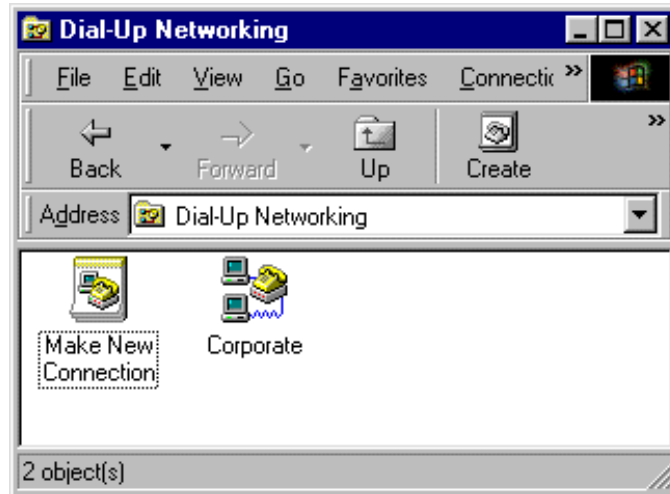



### Creating multiple Dial-Up icons for multiple destinations

Per destination you can create a unique icon. To do so, repeat the steps starting with step 3 of the previous procedure.

## 8.3.2 Open a Dial-Up Session

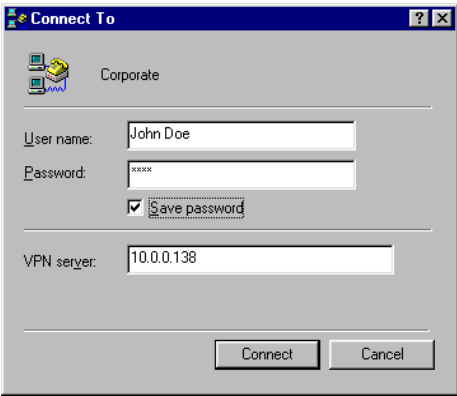
**Procedure** Proceed as follows:

Step	Action and Description
1	<p>Double-click the appropriate Dial-Up icon in the 'Dial-Up Networking' folder or double-click its shortcut on your desktop.</p>  <p>Corporate</p> <p>The 'Connect To' window pops up:</p> 
2	<p>Fill in your <i>user name</i> and <i>password</i>, according your user account at the SP.</p> <p><b>Note:</b> If you want the current Dial-Up connection to remember your credentials for future use, check the 'Save Password' box (✓). Make sure though, that you have logged in when you boot your PC.</p>
3	<p>Click </p> <p>The 'Connecting To Corporate' window appears shortly before being minimized in the system tray:</p> 
4	Start your application now, e.g. a Web browser.

**While you are connected**

Once the Dial-Up connection is established, you can find the MSDUN icon showing two PCs connected to each other in the system tray:



The MSDUN icon symbolizes activity on the PPPoA/PPTP connection by flashing PC(s):

- ▶ A flashing “Front” PC symbolizes upstream (Tx) link activity (from your local PC towards the **STPro**)
- ▶ A flashing “Behind” PC symbolizes downstream (Rx) link activity (from the **STPro** towards your PC).

**The ‘Connected To’ window**



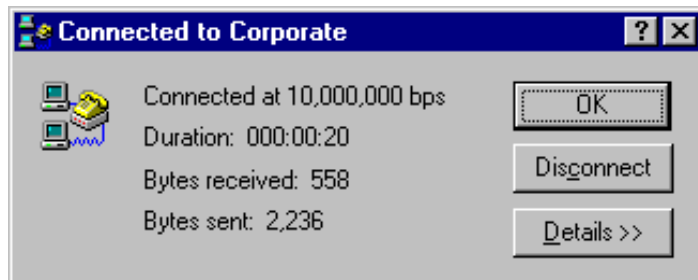

You can check the status of the connection by double-clicking the MSDUN icon  in the system tray.

A ‘Connected To’ window will pop up, showing the status of the PPPoA/PPTP connection:

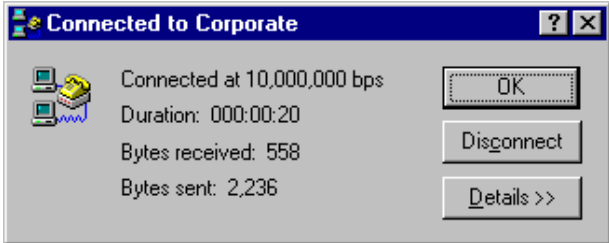

### 8.3.3 Close a Dial-Up Session in Use

**Procedure** Proceed as follows:

Step	Action and Description
1	<p>If the Dial-Up connection is minimized, click the MSDUN icon  in the system tray:</p>  <p>The 'Connected To' window pops up.</p> 
2	Click  to close the Dial-Up session.

**Result** The PPTP tunnel to the **STPro** will no longer exist. The PPPoA/PPTP entry on the **STPro** is made available again for other users.



## 8.4 PPPoA/PPTP Configuration

**Introduction** This section describes the use of the **STPro** 'PPTP' page.

- In this subsection**
- ▶ The 'PPTP' Page
  - ▶ The 'PPTP Connections' Table
  - ▶ 'PPTP Connections' Table Components
  - ▶ Adding Entries
  - ▶ Deleting Entries
  - ▶ Tunneling from behind an IP Router.

**The 'PPTP' page** Click **PPTP** in the left pane of the **STPro** pages to pop up the 'PPTP' page (See section 17.2 for more information):

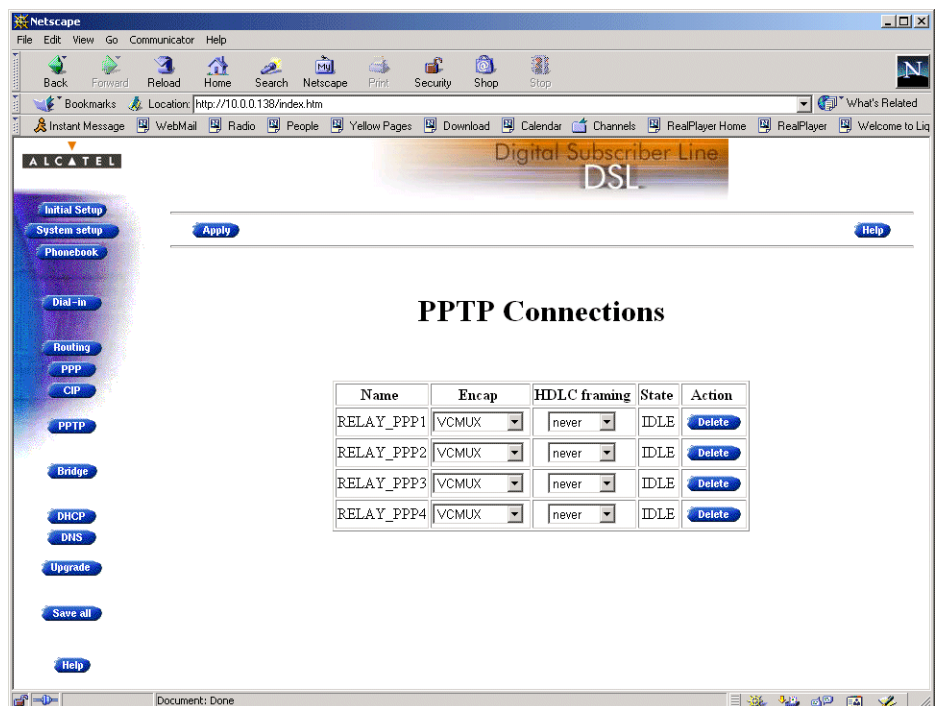

**The 'PPTP Connections' table**

The following figure shows the 'PPTP Connections' table:

Name	Encap	HDLC framing	State	Action
RELAY_PPP1	VCMUX	never	IDLE	Delete
RELAY_PPP2	VCMUX	never	IDLE	Delete
RELAY_PPP3	VCMUX	never	IDLE	Delete
RELAY_PPP4	VCMUX	never	IDLE	Delete

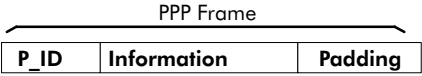
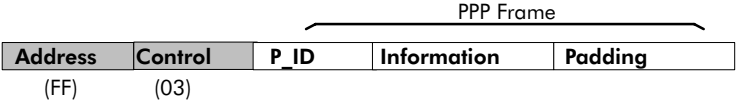

**'PPTP Connections' table components**

Field	Description
Name	Indicates the phonebook entry name used for the PPPoA/PPTP connection.
Encap	Indicates the applied encapsulation method for PPP frames in VCs. The <b>STPro</b> supports both the VC-MUX method (default) and the LLC/NLPID method. The encapsulation method for a PPPoA/PPTP connection can be configured via the CLI.
HDLC Framing	<p>The PPP frames arriving via a PPTP tunnel, and the PPP frames encapsulated on ATM connections, differ in format.</p> <p>The PPP format on AAL5 follows RFC 1661 "Point-to-Point Protocol (PPP)":</p> <div style="text-align: center;">  <p>PPP Frame</p> </div> <p>Whereas the PPP format within a tunnel follows "Point-to-Point Tunneling Protocol (PPTP)":</p> <div style="text-align: center;">  <p>PPP Frame</p> </div> <p>The latter format has two additional bytes in front of the frame (FF-03) inherited from another encapsulation i.e., RFC 1662 "PPP in HDLC-like framing".</p>

Field	Description								
HDLC Framing (continued)	<p>In order to cope with these PPP frame differences, the <b>STPro</b> adapts to the different formats on a 'per connection' base.</p> <p>Additionally, the <b>STPro</b> offers the following PPP/AAL5 format configuration options via the CLI if interoperability problems should arise:</p> <table border="1"> <thead> <tr> <th>Value</th> <th>Description</th> </tr> </thead> <tbody> <tr> <td><b>Never</b></td> <td>The <b>STPro</b> will make sure that FF-03 will never be found in front of a PPP frame encapsulated on a AAL5/ATM connection, independent of the actual format of the PPP frame in the tunnel. This setting is default, and follows RFC2364.</td> </tr> <tr> <td><b>Always</b></td> <td>The <b>STPro</b> will make sure that FF-03 is always in front of a PPP frame encapsulated on an AAL5/ATM connection. Although not supported by RFC2364, some equipment may rely on this format.</td> </tr> <tr> <td><b>Keep</b></td> <td>The <b>STPro</b> will not change the PPP frame arriving via a tunnel.</td> </tr> </tbody> </table> <p><b>Note:</b> This configuration possibility applies only to the upstream direction ! In the downstream direction, the <b>STPro</b> will always make sure that FF-03 is in front of the frame prior to put it in a PPTP tunnel.</p>	Value	Description	<b>Never</b>	The <b>STPro</b> will make sure that FF-03 will never be found in front of a PPP frame encapsulated on a AAL5/ATM connection, independent of the actual format of the PPP frame in the tunnel. This setting is default, and follows RFC2364.	<b>Always</b>	The <b>STPro</b> will make sure that FF-03 is always in front of a PPP frame encapsulated on an AAL5/ATM connection. Although not supported by RFC2364, some equipment may rely on this format.	<b>Keep</b>	The <b>STPro</b> will not change the PPP frame arriving via a tunnel.
Value	Description								
<b>Never</b>	The <b>STPro</b> will make sure that FF-03 will never be found in front of a PPP frame encapsulated on a AAL5/ATM connection, independent of the actual format of the PPP frame in the tunnel. This setting is default, and follows RFC2364.								
<b>Always</b>	The <b>STPro</b> will make sure that FF-03 is always in front of a PPP frame encapsulated on an AAL5/ATM connection. Although not supported by RFC2364, some equipment may rely on this format.								
<b>Keep</b>	The <b>STPro</b> will not change the PPP frame arriving via a tunnel.								
State	<p>The <b>STPro</b> allows multiple users to connect simultaneously via several PPTP entries.</p> <p>The 'State' column indicates the connection state of the PPTP entry. It can take following values:</p> <table border="1"> <thead> <tr> <th>Value</th> <th>Description</th> </tr> </thead> <tbody> <tr> <td><b>Idle</b></td> <td>The PPTP entry is configured, and ready for use.</td> </tr> <tr> <td><b>In Use (IP)</b></td> <td>A user opened a session on this PPTP entry.  The number in brackets is the IP address of the PC currently using the PPPoA/PPTP connection.</td> </tr> </tbody> </table>	Value	Description	<b>Idle</b>	The PPTP entry is configured, and ready for use.	<b>In Use (IP)</b>	A user opened a session on this PPTP entry.  The number in brackets is the IP address of the PC currently using the PPPoA/PPTP connection.		
Value	Description								
<b>Idle</b>	The PPTP entry is configured, and ready for use.								
<b>In Use (IP)</b>	A user opened a session on this PPTP entry.  The number in brackets is the IP address of the PC currently using the PPPoA/PPTP connection.								



### Adding entries

Proceed as follows:

1. Browse to the '*PPTP*' page.
2. Select the phonebook entry from the '*Name*' pop-down list.  
**Note:** In case the presented phonebook entries do not suite your desired configuration, you must firstly create a correct phonebook entry. See section 11.3 for more information.
3. Select the encapsulation method for the PPPoA/PPTP entry from the '*Encap*' pop-down list (per default set to VC-MUX).
4. Select the HDLC framing from the '*HDLC*' pop-down list (per default set to "never").
5. Click  and  to finish the procedure.

---

### Deleting entries

On the '*PPTP*' page, click  next to the PPPoA/PPTP entry you want to delete. As a result your selection is deleted. Click  .

---

### Tunneling from behind an IP router

The **STPro** allows local tunneling from behind an IP router:

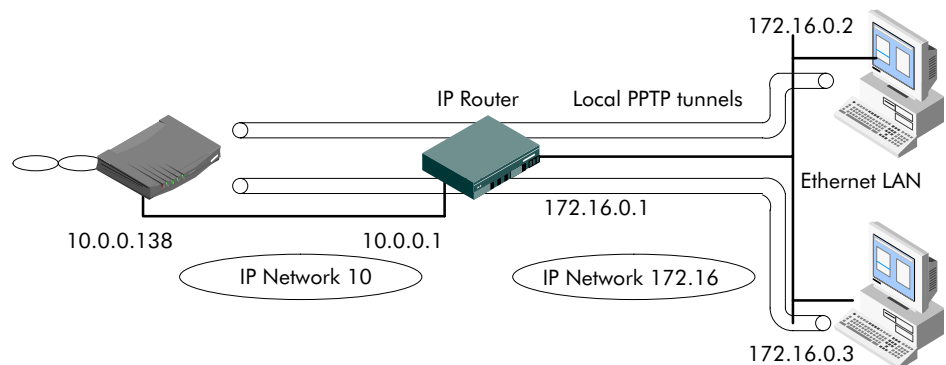

This requires settings in both **STPro** and PCs.

**STPro** You must add a default route for the **STPro** via the 'Routing' page (See section 12.5 for more information).

In the example of the figure above the route to be added has the following parameters:

- ▶ Destination: 0.0.0.0/0
- ▶ Source: Any
- ▶ Gateway: 10.0.0.1

**PCs** For each PC, you must add a route to its internal routing table. This route must point to the **STPro**.

In the example of the figure above the route to be added to each PC's routing table has the following parameters:

- ▶ Destination: 10.0.0.138
- ▶ Gateway: 172.16.0.1

### Verify connectivity

You can verify connectivity from behind the IP router by applying a ping to the **STPro**.



---

## 9 Configuration and Use – PPP & IP Routing

---

**Introduction** *PPP & IP Routing*(\*) is the packet service of your choice as it:

- ▶ Has an authenticated session concept: it supports identification, authentication and auto-configuration
- ▶ Requires no session client on the PC(s), avoiding special installation procedures
- ▶ Allows multiple users to share a single IP address if NA(P)T is enabled.

(\*) PPP & IP Routing is also referred to as Routed PPPoA.

---

### In this chapter

Topic	See
Preparatory Steps	9.1
Using PPP & IP Routing	9.2
PPP Configuration	9.3
PPP Entry Configuration	9.4

---

## 9.1 Preparatory Steps

- 
- Needed information**
- ▶ **VPI/VCI** value of the VC(s) to use on the DSL line
  - ▶ **PPP & IP Routing packet service** must be supported on this VC
  - ▶ **Encapsulation** method (VC-MUX)
  - ▶ Remote access server must be a **PPP(oA) server**
  - ▶ User name and password for your **user account**

**Note:** If connectivity to multiple remote organizations is required, you need additional sets of these parameters.

---

**Multiple destinations** The **STPro** can manage up to 12 PPP & IP Routing connections simultaneously.

**Note:** Check with your SP or corporate whether multiple end-to-end connectivity is enabled.

---

**PC(s)** In order to use the PPP & IP Routing mode of the **STPro**, the OS on your PC(s) must support TCP/IP.

See chapter 12 for more information on IP.

---



## 9.2 Using PPP & IP Routing

**Access methods for PPP** Three methods exist to open a PPP & IP Routing session:

- ▶ **Dial-in**  
The session is opened manually.
- ▶ **Always-on**  
After the **STPro** is powered and finished its POST successfully, the **STPro** automatically tries to open the PPP session.
- ▶ **Dial-on-demand**  
The session is opened automatically, triggered by the arrival or departure of packets at an **STPro** Ethernet port, destined for a PPP connection.

**PPP & IP Routing configuration** Per default, following PPP & IP Routing connections are preconfigured:

- ▶ **PPP1**: dial-in connection
- ▶ **PPP2**: always-on connection
- ▶ **DHCP\_SPOOF**: spoofing connection.

In case these entries do not meet your requirements, you can configure a new one as follows:

1. If needed, add a PPP phonebook entry with the correct VPI/VCI on the 'Phonebook' page.
2. On the 'PPP' page, select this phonebook entry from the 'Name' pop-down list.
3. For this entry, select the correct encapsulation method from the 'Encap' pop-down list.
4. Click .
5. Optionally, perform detailed configurations.

See section 9.3 for more information.

**Opening dial-in sessions**

Proceed as follows (See section 17.2 for more information):

1. Click **Dial-in** on the **STPro** pages.
2. On the 'Dial-in' page the following table is shown:

Name	State	Action
PPP1	down	<b>Dial-in</b>
DHCP_SPOOF	down	<b>Dial-in</b>
Your_Connection	down	<b>Dial-in</b>

3. Click **Dial-in** next to the PPP dial-in entry you want to connect with.
4. If applicable the 'Authentication' table pops up:

**Authentication**

User :

Password :

Save password :

Enter your user name and password in the appropriate fields. If you want the **STPro** to remember your credentials, check 'Save password' (✓).

5. Click **Apply**.
6. After identification and authentication the 'Dial-in' page reappears.

While the **STPro** tries to open the session '**trying**' will appear in the 'State' field. Once the session is active the field displays '**up**'. From then you are online and you can start your application or browse the Internet.

**Closing dial-in sessions**

Proceed as follows:

1. Browse to the 'Dial-in' page.
2. Active PPP & IP routing sessions are indicated via **up** in the 'State' field.

Click  next to the PPP & IP routing entry you want to close the session for.

The session state of the entry will change to **down**, i.e. it becomes idle.

---

## 9.3 PPP Configuration

**Introduction** This section describes the use of the 'PPP' page.  
 Prior to be able to use the PPP entry, you may need to configure it.  
 This is described in section 9.4.

- In this subsection**
- ▶ The 'PPP' Page
  - ▶ The 'PPP Configuration' Table
  - ▶ 'PPP Configuration' Table Components
  - ▶ Adding Entries
  - ▶ Deleting Entries.

**The 'PPP' page** Click **PPP** in the left pane of the **STPro** pages to pop up the 'PPP' page (See section 17.2 for more information):

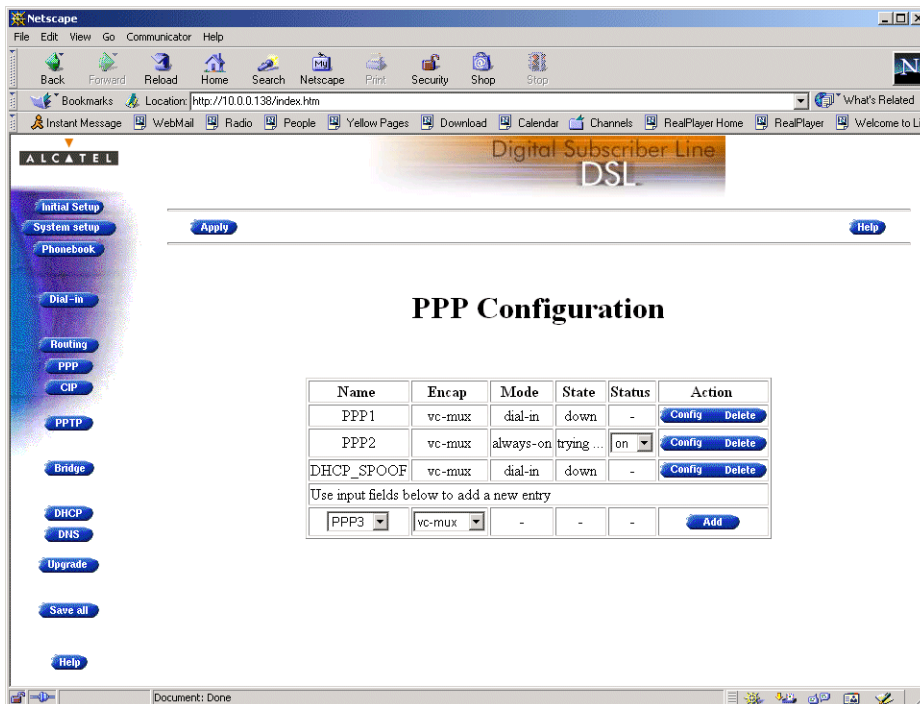

**The 'PPP Configuration' table**

The following figure shows the 'PPP Configuration' table:

Name	Encap	Mode	State	Status	Action
PPP1	vc-mux	dial-in	down	-	<a href="#">Config</a> <a href="#">Delete</a>
PPP2	vc-mux	always-on	trying ...	<input type="checkbox"/> on	<a href="#">Config</a> <a href="#">Delete</a>
DHCP_SPOOF	vc-mux	dial-in	down	-	<a href="#">Config</a> <a href="#">Delete</a>
Use input fields below to add a new entry					
<input type="text" value="PPP3"/>	<input type="text" value="vc-mux"/>	-	-	-	<a href="#">Add</a>

**'PPP Configuration' table components**

Field	Description								
Name	Indicates the PPP phonebook entry name for the PPP entry.								
Encap	Indicates the applied encapsulation method for PPP frames in the VC.  The <b>STPro</b> supports both the VC-MUX method (default) and the LLC/SNAP method.								
Mode	Indicates whether the PPP entry is configured for: <ul style="list-style-type: none"> <li>• "Always-on" connectivity</li> <li>• "Dial-in" connectivity</li> <li>• "Dial-on-Demand" connectivity.</li> </ul> See section 9.4.4 for more information.								
State	Indicates the active state of the PPP session. It can take following values: <table border="1" style="margin-left: 20px;"> <thead> <tr> <th>Value</th> <th>Description</th> </tr> </thead> <tbody> <tr> <td><b>Up</b></td> <td>The PPP session is opened and active.</td> </tr> <tr> <td><b>Down</b></td> <td>The PPP session is closed, the PPP connection is idle.</td> </tr> <tr> <td><b>Trying</b></td> <td>The PPP session is trying to reach the active state.</td> </tr> </tbody> </table>	Value	Description	<b>Up</b>	The PPP session is opened and active.	<b>Down</b>	The PPP session is closed, the PPP connection is idle.	<b>Trying</b>	The PPP session is trying to reach the active state.
Value	Description								
<b>Up</b>	The PPP session is opened and active.								
<b>Down</b>	The PPP session is closed, the PPP connection is idle.								
<b>Trying</b>	The PPP session is trying to reach the active state.								
Status	Allows to change the state of Always-on PPP entries: <ul style="list-style-type: none"> <li>• On: The always-on PPP connection is enabled.</li> <li>• Off: The always-on PPP connection is disabled.</li> </ul>								

### Adding entries

Proceed as follows:

1. Browse to the 'PPP' page.
2. Select the phonebook entry from the 'Name' pop-down list.  
**Note:** In case the presented phonebook entries do not suite your desired configuration, you must firstly create a correct phonebook entry. See section 11.3 for more information.
3. Select the encapsulation method for the PPP entry from the 'Encap' pop-down list (per default set to VC-MUX).
4. Click **Add**.
5. Optionally, click **Config** to enter the appropriate configurations in the 'Authentication', 'Routing' and 'Options' tables.

See section 9.4 for more information.

6. Click **Save all** to finish the procedure.

---

### Detailed configuration

Prior to using the PPPoA connection you may need to enter additional configurations for the connection.

See section 9.4 for more information.

---

### Deleting entries

On the 'PPP' page, click **Delete** next to the idle PPP entry you want to delete. As a result your selection is deleted. Click

**Save all**.

---

## 9.4 PPP Entry Configuration

**Introduction** After enabling the PPP entry in the 'PPP Configurations' table, you must configure the PPP connection.

Configuration of PPP entries must be done per PPP entry.

This section describes the various PPP entry configurations the **STPro** offers for assuring end-to-end connectivity.

**Interaction with the STPro IP router** Most of the configurations described in this section, influence the IP router in the **STPro**.

See section 12.5 for more information on IP routing aspects.

### In this section

Topic	Section
The PPP Configuration Page	9.4.1
Authentication Related Configuration	9.4.2
IP Routing Related Configuration	9.4.3
Connection Related Configuration	9.4.4

## 9.4.1 The PPP Configuration Page

The 'PPP configuration' page

Click **Config** next to a PPP entry you want to configure to pop up the particular 'PPP Configuration' page:

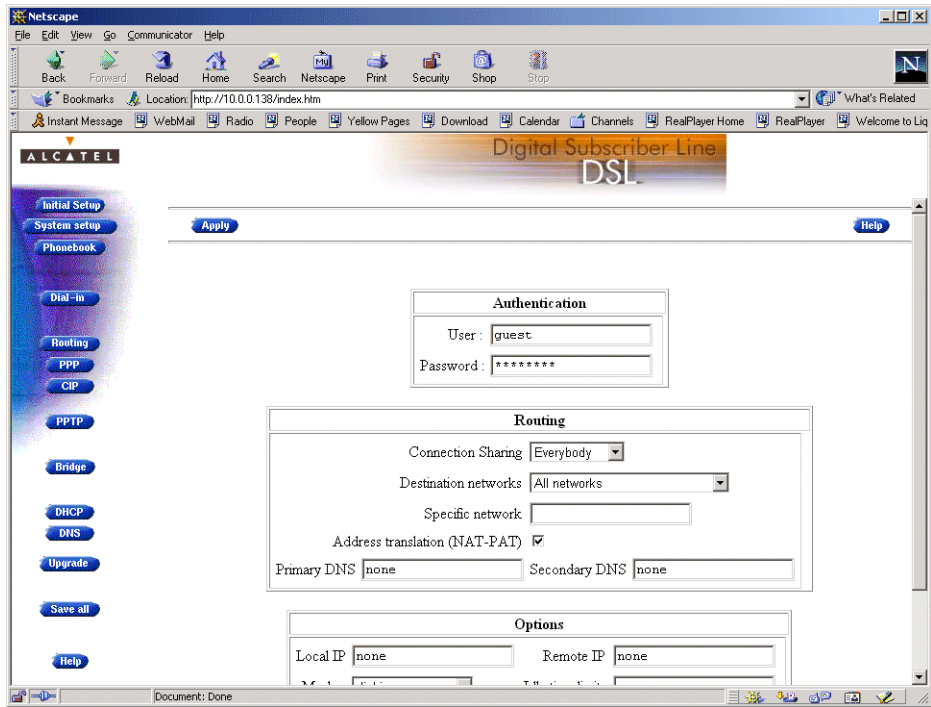



## 9.4.2 Authentication Related Configurations

**Introduction** In most cases you will have a user account with user name and password to identify and authenticate yourself. Via the 'Authentication' box in the 'PPP Configuration' page, you can fill out your credentials for permanent storage.

**'Authentication' box** Following figure shows the 'Authentication' box:

Authentication	
User :	<input type="text" value="guest"/>
Password :	<input type="password" value="*****"/>

**"Guest" credentials** Per default, the user account "guest" is assumed (Both user name and password are 'guest'). If your SP has a guest account, you are able to open a session without having an actual subscription.

**Memorizing credentials** The **STPro** is able to memorize user name, and password per PPP connection; fill out both, and click [Save all](#) .

The next time you establish this PPP connection, the information is retrieved from permanent storage.

**Note:** Leaving the entries blank, forces users to identify and authenticate themselves each time the session is opened.

## 9.4.3 IP Routing Related Configurations

**Introduction** If a PPP session is opened successfully (either manually by the user, triggered by LAN traffic, or automatic at boot time), routes are automatically added to the **STPro**'s routing table.

**Advanced routing** For advanced users, the **STPro** allows manual configuration of routes to dedicated destinations.  
See section 12.5 for more information.  
Moreover, routes can be configured via the CLI, which will only be added to the IP route table upon establishing the PPP connection.  
See chapter 18 for more information on the CLI.

- In this subsection**
- ▶ 'Routing' box
  - ▶ Connection Sharing
  - ▶ Connection Sharing Subnet Values
  - ▶ 'My net only' Configuration
  - ▶ Destination Networks
  - ▶ Destination Networks Subnet Values
  - ▶ Address Translation (✓)
  - ▶ Primary and Secondary DNS Server.

**'Routing' box** The following figure shows the 'Routing' input box:

Routing	
Connection Sharing	Everybody ▾
Destination networks	All networks ▾
Specific network	<input type="text"/>
Address translation (NAT-PAT)	<input checked="" type="checkbox"/>
Primary DNS	none <input type="text"/>
Secondary DNS	none <input type="text"/>

**Connection sharing** The 'Connection Sharing' field allows you to configure which LAN members, besides the PC that opened the PPP session, can use the PPP connection.

Three options are available:

▶ **Only Me**

Only frames of the PC that opened the PPP session will be routed via this PPP connection.

Suppose you opened a PPP session to your corporate and other LAN members are surfing the Internet.

Via this option you can prevent them from using the PPP connection to your corporate as their gateway to the Internet.

▶ **Everybody**

All PC(s) on the local LAN can forward frames over this PPP connection. This option is the exact opposite to 'Only me'.

If you open a PPP session to the Internet, other LAN members can share the PPP connection. In this way they are not required to open a session themselves.

▶ **My net only**

Only PC(s) having the same network, and subnet number as the PC that opened the outbound PPP session, can use the PPP connection.

**Connection sharing subnet values** The following table lists the used netmasks, related to the three possible options:

Connection Sharing value	Related Source Subnet Mask	Notation
Only Me	255.255.255.255	/32
Everybody	0.0.0.0	/0
My net Only	255.255.255.0 (default) This value depends on the subnet mask in use.	/*

**'My net Only' configuration**

In case you want to privilege access via a particular PPP connection for specific PCs, proceed as follows::

Step	Action
1	Configure the PCs, to which you want to privilege outbound access via this PPP connection, in a particular subnet of your local LAN.  <b>Note:</b> Don't forget to make the <b>STPro</b> also a member of this workgroup.
2	Configure the 'Connection Sharing' box of the particular PPP connection for 'My net only'.
3	It is sufficient now to open the PPP session of this PPP connection from one PC of this subnet.

**Note:** As a result, only the members of that particular subnet can share this PPP connection.

**Destination networks**

The 'Destination networks' field allows you to configure which destination can be reached over the particular PPP connection.

Four options are available:

▶ **All networks**

The **STPro** can potentially route frames to all destinations over this PPP connection. The PPP connection acts as if it was a default gateway.

▶ **Remote net only**

A PPP connection configured for 'Remote net only', only forwards frames that is destined to this specific network. All other frames are blocked.

▶ **Remote host only**

Only those frames with a destination IP address which matches exactly with this entry in the **STPro** routing table are forwarded over this PPP connection. In fact, only communication with the single remote host is possible.

▶ **Specific network defined below**

If all previous cases do not fulfill your requirements, 'Specific network' might help you out: you can specify which destination(s) are reachable over this PPP connection. Only if the destination IP address of a packet matches with this entry, the packet is forwarded over this PPP connection.

**Destination networks  
subnet values**

The following table lists the used netmasks, related to the four possible options:

Connection Sharing value	Related Source Subnet Mask	Notation
All Networks	0.0.0.0	/0
Remote net only	255.255.255.0	/0
Remote host only	255.255.255.255	/32
Specific network defined below	255.255.255.0.0 (default) This value is depending on the destination Subnet Mask.	/*

**Address translation**  
(✓)

You can apply Network Address and Port Translation (NA(P)T) on the (negotiated) PPP IP address. Per default NA(P)T are enabled.

Via this checkbox it is possible to check/uncheck the NA(P)T flag (✓).

See section 12.6 for more information.

**Primary and secondary  
DNS server**

These fields allow – optionally – to enter the IP address(es) of the primary, and optionally the secondary, DNS server(s). If you supply these IP addresses, the **STPro** will negotiate these addresses with the remote side of the PPP connection. If these fields are left blank, the remote side will supply the IP addresses of the primary and secondary DNS servers.

See chapter 13 for more information.

## 9.4.4 Connection Related Configuration

**Introduction** The following paragraphs explain which options that are used by a PPP entry when it opens a PPP session.

- In this subsection**
- ▶ 'Options' box
  - ▶ Local and/or Remote IP: **STPro** PPP Client/Server Behavior
  - ▶ Mode: Triggering of a PPP Session
  - ▶ Idle Time Limit
  - ▶ LCP Echo (✓) Requests
  - ▶ PAP (✓): Authentication Protocols
  - ▶ ACCOMP (✓): PPP Framing.

**'Options' box** Following figure shows the 'Options' input box:

Options	
Local IP <input type="text" value="none"/>	Remote IP <input type="text" value="none"/>
Mode : <input type="text" value="dial-in"/>	Idle time limit : <input type="text"/>
<input checked="" type="checkbox"/> LCP echo(currently enabled)	
<input type="checkbox"/> PAP(currently disabled)	
<input checked="" type="checkbox"/> ACCOMP(currently enabled)	

### Local and/or remote IP: STPro PPP server/client behavior

During the opening of a PPP session, IP addresses are negotiated between the two peers for the PPP connection. The *Local IP* and *Remote IP* fields influence this negotiation.

Typically at the client side, the *Local IP* and *Remote IP* boxes are left empty. This forces the client to ask the remote server for addresses.

In case you want to set up the **STPro** as PPP server, suitable values for your network configuration must be supplied:

- ▶ **Setting a local IP address**  
Forces the remote PPP client (if it allows to) to accept this IP address as the **STPro** PPP session IP address.
- ▶ **Setting a remote IP address**  
Forces the remote client (if it allows to) to accept this IP address as its PPP session IP address.

### Mode: triggering of PPP session

The *Mode* field allows you to configure how a PPP session is opened.

Three options are available:

- ▶ **Dial-in**

The PPP session is opened manually by clicking  next to the PPP connection in the *Dial-in* page.

- ▶ **Always-on**

After the **STPro** is powered and finished its Power On Self Test (POST) successfully, the **STPro** automatically tries to open a PPP session for the PPP connection.

- ▶ **Dial-on-demand**

The PPP session is opened automatically for a limited period of time. The opening of the session is triggered by the arrival of packets at the **STPro** Ethernet port, to be sent over the PPP connection.

**Note:** By default one PPP connection is configured as *Dial-in* (i.e. PPP1), another as *Always-on* (i.e. PPP2).

**Idle time limit** In case you configured a PPP connection for *'Dial-on-demand'*, the *'Idle Time Limit'* box allows you to specify the time after which an opened, but unused PPP session is closed.  
If left free, the idle limit time is infinite (i.e. the PPP session will never be closed).

---

**LCP echo (✓) requests** If a PPP session is up, it can issue Link Control Protocol (LCP) echo requests at regular intervals and expects LCP echo replies in return.  
This checkbox allows to turn on/off LCP echo request/replies by respectively setting (✓), or clearing the flag.  
By default LCP echo is on (i.e. flagged ✓), allowing the local PPP peer to detect communication errors, resulting in closing of the PPP session.

---

**PAP (✓): used authentication protocol** The **STPro** features two authentication protocols to be used:

- ▶ Challenge Handshake Authentication Protocol (CHAP).
- ▶ Password Authentication Protocol (PAP)

Per default the **STPro** will negotiate CHAP with the BroadBand RAS (BBRAS) as it is the safest authentication protocol. However, PAP will be allowed, if needed.  
Setting the PAP flag (✓) will force the **STPro** only to negotiate PAP with the BBRAS.

---

**ACCOMP (✓): used PPP framing** Address and Control field COMPression (ACCOMP), sometimes abbreviated as ACCM, is by default enabled, i.e. flagged (✓).  
This option flag should not be cleared, except in special circumstances, i.e. where the remote PPP server expects to see HDLC like framing (FF03 imposed to the PPP packet).

---



---

# 10 Configuration and Use – CIP & IP Routing

---

**Introduction** *Classical IP & IP routing*(\*) is the packet service of your choice as it:

- ▶ Is a third standardized method next to PPPoA and PPPoE for creating IP networks on top of ATM technology
- ▶ Is traditionally well supported by ATM access routers at the remote end of the connection
- ▶ Similar to Bridging, provides “Always-on” type of connections.

(\*) In the following, Classical IP & IP Routing will be referred to as Classical IP (CIP).

---

## In this chapter

Topic	Section
Preparatory Steps	10.1
CIP Configuration for a LIS	10.2
Using CIP & IP Routing	10.3
CIP Configuration	10.4

---

## 10.1 Preparatory Steps

- 
- Needed information**
- ▶ **VPI/VCI** value of the VC(s) to use on the DSL line
  - ▶ **CIP packet service** must be supported on this VC
  - ▶ **Encapsulation** method (LLC/SNAP)
  - ▶ For full compliancy to RFC1577 the remote access device must issue and respond to **InATMARP** messages.

**Note:** The RFC1577 on which Classical IP over ATM relies is updated by RFC2225. The **STPro** fully complies with both RFCs.

---

**Multiple destinations** The **STPro** can manage up to 12 CIP connections simultaneously.  
**Note:** Check with your SP whether multiple end-to-end connectivity is enabled.

---

**PC(s)** In order to use the CIP & IP Routing mode of the **STPro**, the OS on your PC(s) must support TCP/IP.  
See chapter 12 for more information on IP.

---

## 10.2 CIP Configuration for a LIS

---

**Introduction** In this section the basic procedure to enable connectivity in a Logical IP Subnet (LIS) via the ATM core network.

---

### In this section

Topic	See
General CIP Configuration Procedure	10.2.1
Retrieving LIS Parameters	10.2.2
Implicit Assignment Mechanism	10.2.3
Explicit Assignment Mechanism	10.2.4
Configuring the <b>STPro</b> for CIP	10.2.5
Adding Appropriate Routes to the Routing Tables.	10.2.6
Example of a CIP LIS Configuration	10.2.7

---

## 10.2.1 General CIP Configuration Procedure

**Decision procedure** Due to the many decisions that must be made in order to be able to configure the **STPro** to be an active member of a LIS, the procedure to be followed is best retrieved from the following decision table:

Step	Decision and/or Action	See									
1	Are you configuring the <b>STPro</b> for an existing LIS ?	10.2.2									
	<table border="1"> <thead> <tr> <th>Answer</th> <th>Action and Description</th> </tr> </thead> <tbody> <tr> <td><b>Yes</b></td> <td>You must retrieve the LIS IP parameters to which your local configuration must adhere to. See topic 'Configuration for an <i>Existing LIS</i>' of subsection 10.2.2.</td> </tr> <tr> <td><b>No</b></td> <td>You can create the LIS with IP parameters of your choice. See topic 'Creating a New LIS' of subsection 10.2.2.  In case you create a new LIS, you must create the LIS at both end of the DSL connection, i.e. at the local, and on the remote side.</td> </tr> </tbody> </table>	Answer	Action and Description	<b>Yes</b>	You must retrieve the LIS IP parameters to which your local configuration must adhere to. See topic 'Configuration for an <i>Existing LIS</i> ' of subsection 10.2.2.	<b>No</b>	You can create the LIS with IP parameters of your choice. See topic 'Creating a New LIS' of subsection 10.2.2.  In case you create a new LIS, you must create the LIS at both end of the DSL connection, i.e. at the local, and on the remote side.				
Answer	Action and Description										
<b>Yes</b>	You must retrieve the LIS IP parameters to which your local configuration must adhere to. See topic 'Configuration for an <i>Existing LIS</i> ' of subsection 10.2.2.										
<b>No</b>	You can create the LIS with IP parameters of your choice. See topic 'Creating a New LIS' of subsection 10.2.2.  In case you create a new LIS, you must create the LIS at both end of the DSL connection, i.e. at the local, and on the remote side.										
2	Retrieve the appropriate LIS parameters, and check on which VCs (identifiable by their VPI/VCI values) your service provider enabled the CIP packet service.	10.2.2									
3	If needed, create a CIP phonebook entry, i.e. a CIP PVC, in the 'Phonebook' web page.	10.4									
4	Is the remote access router a RFC1577/RFC2225 compliant device, e.g. another <b>STPro</b> ?										
	<table border="1"> <thead> <tr> <th>Answer</th> <th>Action and Description</th> <th>See</th> </tr> </thead> <tbody> <tr> <td><b>Yes</b></td> <td>The remote access router will respond to 'InATMARP' requests, thus the CIP PVC can be implicitly assigned to the CIP member.</td> <td>10.2.3</td> </tr> <tr> <td><b>No</b></td> <td>The remote access router will <b>not</b> respond to 'InATMARP' requests submitted by the <b>STPro</b>, thus the CIP PVC must be explicitly assigned to the CIP member.</td> <td>10.2.4</td> </tr> </tbody> </table>	Answer	Action and Description	See	<b>Yes</b>	The remote access router will respond to 'InATMARP' requests, thus the CIP PVC can be implicitly assigned to the CIP member.	10.2.3	<b>No</b>	The remote access router will <b>not</b> respond to 'InATMARP' requests submitted by the <b>STPro</b> , thus the CIP PVC must be explicitly assigned to the CIP member.	10.2.4	
Answer	Action and Description	See									
<b>Yes</b>	The remote access router will respond to 'InATMARP' requests, thus the CIP PVC can be implicitly assigned to the CIP member.	10.2.3									
<b>No</b>	The remote access router will <b>not</b> respond to 'InATMARP' requests submitted by the <b>STPro</b> , thus the CIP PVC must be explicitly assigned to the CIP member.	10.2.4									
5	If needed, create a CIP member in the 'CIP Interfaces' table of the 'CIP' page.	10.4									
6	Add appropriate IP routes to the <b>STPro</b> via the 'IP route' table on the 'Routing' page.	10.2.6									
7	Add appropriate IP routes in you PC(s).	10.2.6									

## 10.2.2 Retrieving LIS Parameters

---

**LIS** The LIS is an important CIP concept. It is a group of IP machines configured as members of the same IP subnet. In other words: they share the same IP network and subnetwork numbers.

In most cases this LIS will be a corporate LAN/WAN environment, which is interconnected via the DSL/ATM network.

---

**LIS parameters** In order to be able to properly configure your **STPro** for sharing the same logical IP subnet, you must know the following LIS parameters:

- ▶ The IP network number
- ▶ The IP subnetwork number
- ▶ The remote access router's RFC1577/RFC2225 compliancy state
- ▶ The remote access router IP address, in the case it is not RFC1577/RFC2225 compliant.

Of course, in case you know the IP address of one member of the LIS, and the associated netmask, you also have enough information.

---

**Configuration for an existing LIS** For an existing LIS, you must configure the **STPro** CIP settings, according to the existing LIS parameters.

If the default CIP member's IP parameters, and the CIP connection's remote IP address, configured in the **STPro**, match with these parameters, nothing needs to be configured.

However, make sure that the CIP member's local IP address is not ambiguous within the LIS.

---

**Creating a new LIS** In the case of creating a new LIS, you are recommended to use the default CIP configurations of the **STPro**. In case the remote access router is also a **STPro**, best results are assured.

**Note:** Both ends of the LIS must be properly configured for connectivity, inclusive the routing tables.

---

### 10.2.3 Implicit Assignment Mechanism

**Implicit assignment** If the remote side is RFC1577/RFC2225 compliant, e.g. another **STPro**, your local **STPro** is able to retrieve the remote IP address of the CIP PVC, by issuing an InATMARP request on that PVC.  
 That way, you must not specify an IP address for the CIP PVCs you add to the 'CIP Connections' table, it will be implicitly assigned when connecting to the LIS.

**Implicit assignment example** The sequence below describes an example of an implicit assignment mechanism:

Phase	Decision and Description	
1	Suppose you added a CIPPVC without supplying an IP address (e.g. CIPPVC2).	
2	The <b>STPro</b> will automatically issue an InATMARP request on this PVC.	
3	Is the remote side is RFC1577/RFC2225 compliant ?	
	<b>Yes</b>	<b>No</b>
4	It responds with an InATMARP reply, containing its IP address. The CIP's remote IP address in the 'CIP Connections' table is completed.	"Unresolved" will show up in the 'Remote IP Address' field. Consequently the CIPPVC cannot be assigned and IP connectivity will not exist with the remote machine.
5	Does the remote address share a LIS with a local CIP member ?	
	<b>Yes</b>	
6	the CIPPVC is assigned to this member. Connectivity is assured.	"Unresolved" will show up. No connectivity exists.

**Note** The grey shaded area of the table indicates the sequence of a correct RFC1577/RFC2225 compliant LIS interconnection.

## 10.2.4 Explicit Assignment Mechanism

**Explicit assignment** In the case of a remote access server which is not RFC1577/RFC2225 compliant, it will not respond to InATMARP requests.

As a consequence, the **STPro** can not retrieve the remote IP address to assign the CIP PVC to the CIP member.

Therefore you must explicit assign a remote IP address to the CIP PVC.

**Explicit assignment example** The default configuration of the **STPro** is an example of the explicit assignment of a CIP PVC to a CIP member:

In the '*CIP Interfaces*' table, the CIP member is configured as follows:

Name	Local IP-Address	Mask
cip0	172.16.1.1	255.255.255.0

In the '*CIP Connections*' table, the remote IP address is statically configured:

Dest	Remote IP-Address
CIPPVC1	172.16.1.2

Consequently, *CIPPVC1* is explicitly assigned to *cip0*.

**Note** Both local and remote IP addresses must fall within the same IP network and IP subnetwork, according the LIS parameters.

## 10.2.5 Configuring the STPro for CIP

---

**Introduction** After retrieving the LIS parameters, you must configure the **STPro**, according to these parameters.

This section describes in short the global procedure for configuring your **STPro** 'Phonebook' and 'CIP' pages.

---

### Configuration of the STPro 'Phonebook' page

By default the **STPro** is configured for a CIP VC as used in the example of section 10.2.7. If this VC is appropriate to your, and/or the SP's needs, nothing has to be configured in the **STPro** phonebook.

If this VC does not match the requirements, three other CIP phonebook entries are available to add.

However, in the case none of the entries match, you must add a CIP phonebook entry yourself.

Adding phonebook entries is described in section 11.3.

---

### Configuration of the STPro 'CIP' page

The default CIP phonebook entry mentioned above is by default configured for a LIS according to the example of section 10.2.7. If this LIS configuration meets your requirements, nothing needs to be configured, and your **STPro** is ready for use.

However, if additional configuration is needed, you can configure CIP members yourself.

The assignment of your CIP PVC to the CIP member can be done implicit, or explicit, according the RFC1577/RFC2225 compliancy of the remote access router.

Configuration of the **STPro** 'CIP' page is fully described in section 10.4.

---



## 10.2.6 Adding Appropriate Routes to the Routing Tables

**Introduction to routing** IP routing is a very important aspect of a LIS configuration. This subsection describes how you can ensure end-to-end connectivity for a CIP environment.

- In this subsection**
- ▶ Configuring the **STPro** for LIS Connectivity, Basic
  - ▶ Configuring the **STPro** for LIS Connectivity, Advanced
  - ▶ Configuring your LAN PCs for End-to-End Connectivity
  - ▶ Routing Table Configuration.

**Configuring the STPro for LIS connectivity, basic** Generally, for proper CIP routing, an IP route pointing to the remote access router must exist in your **STPro**'s IP routing table. If the remote access router is RFC1577/RFC2225 compliant, no routes for LIS connectivity need to be configured by yourself for the **STPro**'s IP router. This because it automatically adds two necessary routes as soon you configure the CIP member, i.e. two default gateways, thus any (0.0.0.0/0) as source address, and with:

- ▶ The LIS's local CIP member's IP address, i.e. the **STPro**'s CIP interface address as destination
- and
- ▶ The LIS's IP subnetwork (based on the CIP member's IP parameters) as destination.

As the RFC1577/RFC2225 compliant remote access router, falls within the same LIS as the **STPro** CIP member, it is also a member of the second route's destination IP subnetwork.

If the remote access router is not RFC1577/RFC2225 compliant, you must add this default route (with the known remote IP address) yourself.

**Configuring the STPro  
for LIS connectivity,  
advanced**

The possibility exists to add routes yourself, e.g. to be more specific in the source IP address pool.

The default added routes have `any` as source address, meaning that all local hosts can use this gateway to connect to the LIS via the CIP interface.

However, you might want to embed restrictions in LIS access by creating a subnet in your LAN, e.g. `10.0.1.x`, and privilege access to the LIS – and its beyond LAN – to this subnet by adding a route pointing to the remote access router (implicit, or explicit) but now with source IP address pool `10.0.1.0/24`.

Of course then the default IP routes configured by default, must be deleted.

**Configuration your LAN  
PCs for end-to-end  
connectivity**

In order to have end-to-end connectivity from your PCs to the remote side of the CIP connection and beyond you must add routes having the **STPro** Ethernet interface IP address as gateway.

By specifying `0.0.0.0/0` as destination and the **STPro** local Ethernet IP address as gateway the **STPro** is configured as the default gateway for all connection requests.

However, you can specify a destination IP address pool, e.g. if the remote LAN's IP subnetwork is `192.6.11.x`, you can add routes in your PC's routing table with destination `192.6.11.0/32`, and the **STPro** as gateway.

**Routing table  
configuration**

Configuring routes for the **STPro** is described in section 12.5.

## 10.2.7 Example Configuration

**Configuration figure** The configuration of a Classical IP LIS is illustrated with the following example:

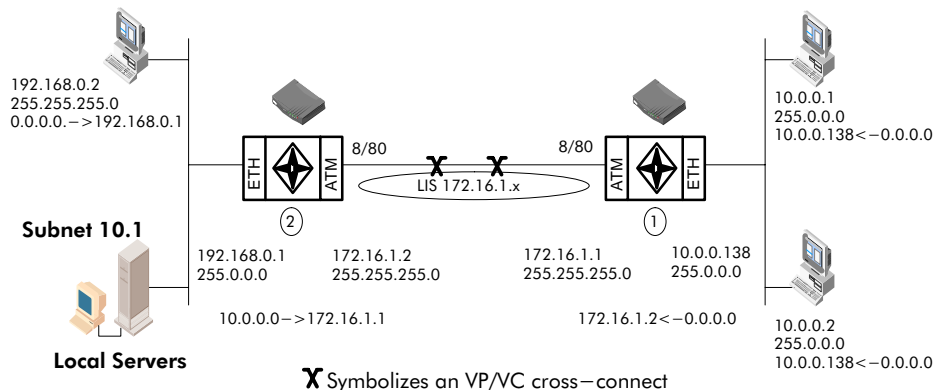

In the drawing above a LIS, 172.16.1.x, represented by the ellipse, runs between the **STPro(1)** and the remote access router (2).

### Local premisses configuration

At the local premisses an IP network, 10.x.x.x, is created. An IP address is configured on the Ethernet port (10.0.0.138). On the DSL side of the **STPro(1)** one CIP member is by default enabled. This CIP member is configured with IP address 172.16.1.1 and is part of the LIS 172.16.1.x. One VC in the **STPro(1)** phonebook (CIPPVC1), is explicitly assigned to this CIP member. This VC(8/80) is cross-connected to the remote destination.

**Remote premisses configuration**

At the remote DSL side, the CIP LIS is terminated by the remote access router (2) and IP packets are forwarded to local servers, or the Internet and vice versa.

Here, the CIP member is configured with IP address 172.16.1.2 and is part of the same LIS 172.16.1.x.

Additionally, a VC, with the same VPI/VCI values 8/80, is assigned to this CIP member (e.g. implicit assignment, because **STPro(1)** is RFC1577/RFC2225 compliant).

---

**Routing configuration**

The routing engine must be configured with routes to the final destinations.

For the given example, the configuration is as follows:

- ▶ **STPro(1)** has its default route pointing to the remote access router (2)

The local PCs of IP network 10.0.0.x have default gateways pointing to **STPro(1)**

- ▶ The remote access router (2) has a route for “Net10” (10.0.0.0) pointing to **STPro(1)**

The remote IP network 192.168.0.x has a default gateway pointing to access router (2).

---

**Note** You will notice that the example relies exclusively on *Private* IP addresses. Depending the application though, other IP addresses in combination with NA(P)T (configurable via the CLI) can be used.

---

## 10.3 Using CIP & IP Routing

**CIP operation** Similar to classical LAN networking, CIP adheres to the “always-on” concept.

IP packets sourced by local PCs, arrive via the Ethernet segment in the **STPro**. The latter makes routing decisions based on the destination IP address of the packet. If the packet ends up in the CIP member it will on its turn determine to which VC it has to output the packet.

You can check IP connectivity from any PC on the local Ethernet segment. Therefore, ping the IP address at the far end of the virtual connection; e.g. for the example of subsection 10.2.7, this would be 172.16.1.2, or thus `ping 172.16.1.2`.

**Classical IP and STPro** The IP router in the **STPro** forwards packets between the Ethernet port and the Classical IP entity sitting on top of the DSL/ATM port. In turn, the CIP entity determines which VC it has to output the packet to, prior to ATM encapsulation.

**Configuration and operation example** The figure below provides an overview of the **STPro** rear-to-front end Classical IP operation:

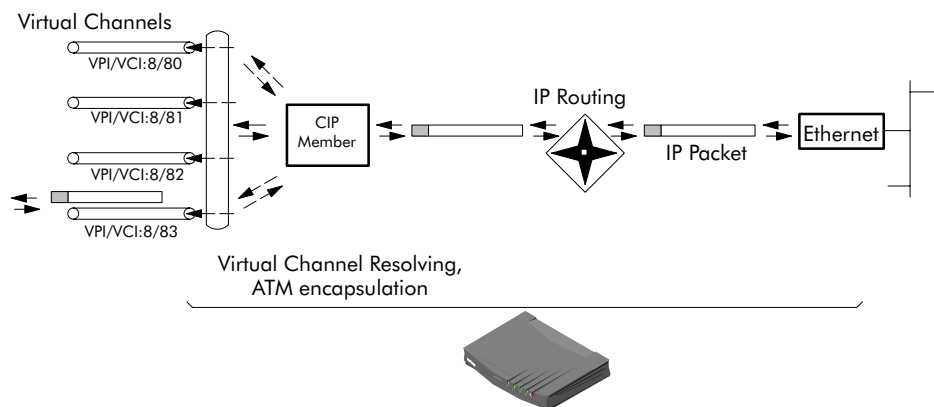

## 10.4 CIP Configuration

**Introduction** This section describes the use of the **STPro** 'CIP' page.

- In this subsection**
- ▶ The 'CIP' Page
  - ▶ The 'CIP Interfaces' Table
  - ▶ 'CIP Interfaces' Table Components
  - ▶ The 'CIP connections' Table
  - ▶ 'CIP Connections' Table Components
  - ▶ Adding CIP members
  - ▶ Assigning CIP PVCs to CIP members
  - ▶ Deleting CIP Entries.

**The 'CIP' page** Click **CIP** in the left pane of the **STPro** pages to pop up the 'CIP' page (See section 17.2 for more information):

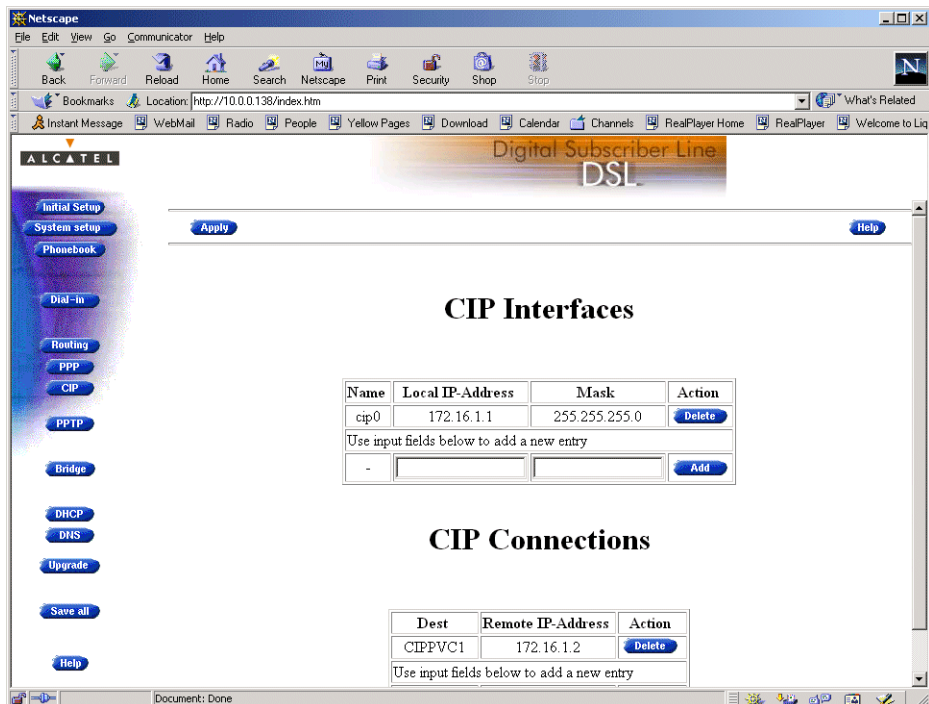

### The 'CIP Interfaces' table

The following figure shows the 'CIP Interfaces' table:

Name	Local IP-Address	Mask	Action
cip1	172.16.1.1	255.255.255.0	<a href="#">Delete</a>
Use input fields below to add a new entry			
-	<input type="text"/>	<input type="text"/>	<a href="#">Add</a>

### 'CIP Interfaces' table components

The following fields are shown:

Field	Description
Name	Indicates the CIP member name. All CIP members are named 'cipX', where X is a number.
Local IP-Address	Indicates the IP address of the local DSL side of the LIS, i.e. the IP address of your CIP interface.
Mask	Indicates the netmask/subnetmask of the local IP address.

### The 'CIP Connections' table

The following figure shows the 'CIP Connections' table:

Dest	Remote IP-Address	Action
CIPPVC1	172.16.1.2	<a href="#">Delete</a>
Use input fields below to add a new entry		
CIPPVC2 ▾	<input type="text"/>	<a href="#">Add</a>

### 'CIP Connections' table components

The following fields are shown:

Field	Description
<i>Dest</i>	Indicates the CIP VC phonebook name.
<i>Remote IP-Address</i>	Indicates the remote IP address of the remote DSL side of the LIS, i.e. the IP address of the remote CIP interface.  <b>Note:</b> In case the VC is not cross-connected, or implicit assignment was not successful, this field shows "Unresolved".



**Adding CIP members**

Proceed as follows:

1. Browse to the 'CIP' page.

Addition of a CIP member is performed in the 'CIP Interfaces' table.

2. Fill in the following CIP member parameters:

- **Local IP-address**

The IP address of the CIP member at your local side of the LIS.

- **Mask**

The associated netmask/subnetmask for this local IP address.

3. Click  and  to finish the procedure.

---

**Result**

A CIP member of the LIS is created at your **STPro**'s CIP interface side of the LIS. The local IP address is added to the 'IP Address' table.

Two default routes are added to the 'IP Route' table, both pointing to the **STPro** as gateway, but the first with the CIP member itself as destination, the second with the LIS subnetwork IP address pool as destination.

---

### Assigning CIP PVCs to CIP members

Proceed as follows:

1. Browse to the 'CIP' page.

Assignment of a CIP PVC is performed in the 'CIP Connections' table.

2. Select the phonebook entry from the 'Dest' pop-down list.

**Note:** In case the presented phonebook entries do not suite your desired configuration, you must firstly create a correct phonebook entry. See section 11.3 for more information.

3. Depending the RFC1577/RFC2225 compliancy of the remote access router, the following must be filled in, in the 'Remote address' field:

Compliancy	Remote IP address
YES	You don't have to fill in anything; the InATMARP reply will implicitly assign the PVC to the CIP member.
NO	You must fill in the exact IP address of the remote access router; the PVC is explicitly assigned to the CIP member.

4. Click **Add** and **Save all** to finish the procedure.

### Deleting CIP entries

On the 'CIP' page, click **Delete** next to the CIP connection or CIP interface you want to delete. As a result your selection is deleted. Click **Save all**.

---

# Alcatel Speed Touch™ Pro

## Networking

---



---

# 11 Networking – ATM

---

**Introduction** All data arriving at and departing from your **STPro** via the DSL line is carried in Asynchronous Transfer Mode (ATM) cells.

In this way, ATM is the fundamental communication “language” for the **STPro** towards the remote devices.

The dual port **STPro** model, equipped with the additional ATMF-25.6 port, is even capable to extend ATM connectivity up to your local PC or local network (via ATM switches).

---

## In this chapter

Topic	See
The ATM Packet Switching Technology	11.1
ATMF-25.6 Port Configuration	11.2
The <b>STPro</b> Phonebook	11.3

---

## 11.1 The ATM Packet Switching Technology

---

### ATM Switching

ATM is a connection-oriented packet switching technology using fixed-size packets, called *cells*.

These cells consist of a header and a payload and are switched through a public or private ATM network depending on the contents of the header.

End-to-end connections are formed by cross-connecting individual ATM segments in ATM switches.

---

### In this section

Topic	See
ATM Parameters	11.1.1
ATM and the <b>STPro</b>	11.1.2
ATM and Interfaces	11.1.3

---

---

## 11.1.1 ATM Parameters

- 
- Virtual channels** ATM uses VCs to create individual communication links between network nodes. ATM uses two types of VCs:
- ▶ Permanent Virtual Channels (PVCs) are static connections between network nodes that are configured statically. For a Permanent Virtual Channel (PVC) the nodes of the connection operate as if they are connected with a dedicated physical line.
  - ▶ Switched Virtual Channels (SVCs) are similar to voice telephone network connections. These are temporary connections between any two end points on the network and are configured via signaling. A Switched Virtual Channel (SVC) is created dynamically for each session and released when the information exchange is complete.

---

**VCs and the STPro** Currently all **STPro** ATM connections are static, i.e. of type PVC.

---

**Channel identifiers** Each ATM cell carries two labels called Virtual Path Identifier (VPI) and Virtual Channel Identifier (VCI) as part of its header.

An ATM channel, commonly referred to as **Virtual Channel**, is fully identified by these two labels. Therefore, multiple ATM channels can reside on your DSL line.

---

## 11.1.2 ATM and the STPro

### End-to-end ATM connectivity

The following figure provides an overview of the end-to-end architecture of the ATM connectivity; from your **STPro** to remote access devices.

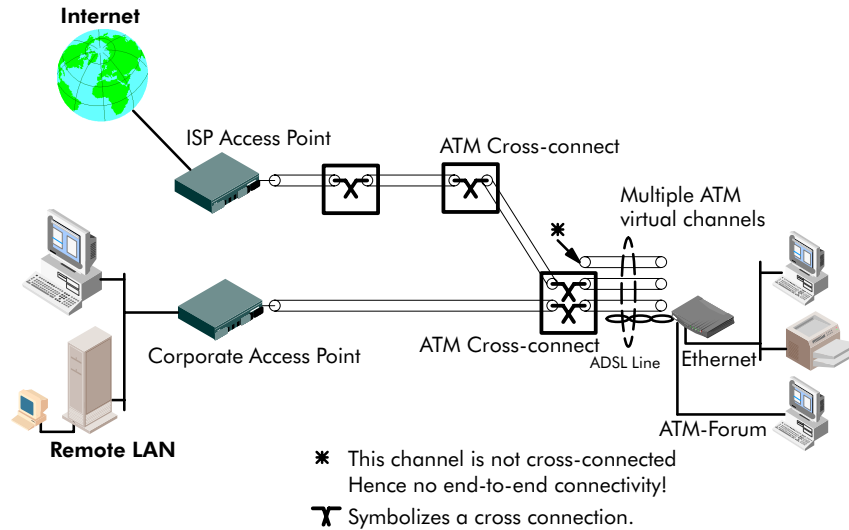

### STPro vs. remote destination

Practically speaking, a number of VCs to one, or multiple remote destination(s) can start from/are terminated at the **STPro**.

By default, a number of channels are terminated in the **STPro** for Ethernet; others are cross-connected to the ATMF-25.6 port (if equipped).

### ATM provision

End-to-end ATM connectivity is the responsibility of local operators. There might be regional differences in the type and number of ATM channels that are cross-connected.

If problems are encountered, check with your local operator for more information.



### 11.1.3 ATM and Interfaces

---

**ATM traffic handling** ATM traffic arriving at the **STPro** is switched to either the Ethernet port(s), or the (optional) ATMF-25.6 port depending on the VPI/VCI values in the individual cells.

Inside ATM VCs any protocol can be transported. However, at both endpoints – that is where the ATM channels are terminated –, the same protocol must be supported. If not, there will be no end-to-end connectivity.

---

**ATMF-25 port** This port, optional available on the single Ethernet port **STPro**, does not terminate ATM connections, it just switches ATM cells between the DSL and ATMF-25.6 port.

It is the ATMF-25.6 PC-NIC of the PC that actually initiates, or terminates ATM VCs.

It is important to check in advance which protocols are supported by the ATMF-25.6 PC-NIC driver. At least RFC1483 and RFC2364 should be fully implemented.

See section 11.2 for more information.

---

**Ethernet port** This port terminates a number of ATM connections and extracts frames from arriving cells and encapsulates frames in departing cells.

Only frames recognized/supported by the **STPro** on a particular ATM connection are extracted, or encapsulated.

Currently the supported encapsulations are:

- ▶ For **Transparently Bridged** connections:  
RFC 1483, Ethernet V2.0/IEEE 802.3 bridged PDUs for both the LLC/SNAP method and VC-MUX method
  - ▶ For **Bridged PPPoE** connections:  
RFC 1483, Ethernet V2.0/IEEE 802.3 bridged PDUs for both the LLC/SNAP method and VC-MUX method
  - ▶ For **PPPoA-to-PPTP Relaying** connections:  
RFC 2364, PPP PDUs for both the LLC/NLPID method and VC-MUX method
  - ▶ For **PPP & IP Routing** connections:  
RFC 2364, PPP PDUs for both the LLC/NLPID method and VC-MUX method
  - ▶ For **CIP & IP Routing** connections:  
RFC 1483 LLC/SNAP method for Routed PDUs.
-

---

## 11.2 ATMF-25.6 Port Configuration

---

**Disclaimer** This section applies only to the dual **STPro** model, equipped with both Ethernet and ATMF-25.6 port.

---

**ATM connectivity in your LAN** If your PC (alternatively via an ATM switch) is connected to the ATMF interface, ATM service is delivered into the PC. This implies that ATM cells, sourced by PC applications via the PC's ATMF PC-NIC port are captured by the **STPro** ATMF-25.6 port and cross-connected or switched to the DSL line.

---

**The STPro ATMF-25.6 port** The **STPro**'s ATMF-25.6 port is completely transparent to upper protocol layers.

---

**The PC ATMF-25.6 PC-NIC** The available support of the packet services depend solely on your ATMF-25.6 PC-NIC's capabilities. Consult your ATMF-25.6 PC-NIC documentation for information on service configuration.

---

**ATM VC support** The VPI/VCI of the VCs, cross-connected between the DSL line and the ATMF-25.6 port, are listed in appendix C. Connectivity is only possible if your ATMF-25.6 PC-NIC is sending and receiving ATM cells on one (or more) of these VCs.

---

## 11.3 The Speed Touch Phonebook

---

**Introduction** The **STPro** phonebook is like any ordinary phonebook:  
*“A repository for names and numbers”.*

However, in contrast to a standard phonebook, it contains additional connectivity information.

Basic to the **STPro** operation are ATM VCs. The **STPro** phonebook is the management tool for all possible ATM VC connections.

This chapter describes how to use the **STPro** phonebook and consequently how to manage this VC pool.

---

### In this section

Topic	See
The 'Phonebook' Page	11.3.1
Using the Phonebook	11.3.2
AutoPVC	11.3.3

---

## 11.3.1 The STPro 'Phonebook' Page

- In this subsection
- ▶ The 'Phonebook' Page
  - ▶ The 'Phonebook' Table
  - ▶ 'Phonebook' Table Components
  - ▶ Phonebook Defaults
  - ▶ The 'AutoPVC' Table.

The 'Phonebook' page Click **Phonebook** in the left pane of the **STPro** pages to pop up the 'Phonebook' page (See section 17.2 for more information):

The screenshot shows the 'Phonebook' page in a Netscape browser window. The page title is 'Phonebook'. On the left, there is a vertical navigation pane with buttons for 'Initial Setup', 'System setup', 'Phonebook', 'Dial-in', 'Routing', 'PPP', 'CIP', 'PPTP', 'Bridge', 'DHCP', 'DNS', 'Upgrade', 'Save all', and 'Help'. The 'Phonebook' button is highlighted. The main content area contains a table with the following data:

Name	VPI	VCI	Type	Usage	Action
Br1	8	35	bridge	configured	-
Br2	8	36	bridge	free	Delete
Br3	8	37	bridge	free	Delete
Br4	8	38	bridge	free	Delete
RELAY_PPP1	8	48	pptp	configured	-
RELAY_PPP2	8	49	pptp	configured	-
RELAY_PPP3	8	50	pptp	configured	-
RELAY_PPP4	8	51	pptp	configured	-
PPP1	8	64	ppp	configured	-
PPP2	8	65	ppp	configured	-
PPP3	8	66	ppp	free	Delete
DHCP_SPOOF	8	67	ppp	configured	-

**The 'Phonebook' table** The following figure shows an example of the 'Phonebook' table of the 'Phonebook' page:

Name	VPI	VCI	Type	Usage	Action
Br1	8	35	bridge	configured	-
Br2	8	36	bridge	free	Delete
Br3	8	37	bridge	free	Delete
Br4	8	38	bridge	free	Delete
RELAY_PPP1	8	48	pptp	configured	-
RELAY_PPP2	8	49	pptp	configured	-
RELAY_PPP3	8	50	pptp	configured	-
RELAY_PPP4	8	51	pptp	configured	-
PPP1	8	64	ppp	configured	-
PPP2	8	65	ppp	configured	-
PPP3	8	66	ppp	free	Delete
DHCP_SPOOF	8	67	ppp	configured	-
CIPPVC1	8	80	cip	configured	-
CIPPVC2	8	81	cip	free	Delete
CIPPVC3	8	82	cip	free	Delete
CIPPVC4	8	83	cip	free	Delete

Use input fields below to add a new entry

<input type="text"/>	<input type="text" value="8"/>	<input type="text"/>	bridge	-	Add
----------------------	--------------------------------	----------------------	--------	---	-----

**'Phonebook' table components**

Field	Description
Name	Indicates the name, or alias of the virtual connection phonebook entry. Any name can be given to an entry.
VPI/VCI	Indicates the VPI and VCI value of the ATM VC terminated on the DSL port for the phonebook entry. The allowed VPI range: from 0 up to 15. The allowed VCI range: from 32 up to 511. <b>Note:</b> In case your single Ethernet port <b>STPro</b> is equipped with an ATMF-25.6 port, VPI values 0 to 7 are cross-connected between the DSL port and the ATMF-25.6 port.

Field	Description										
Type	<p>Represents the packet service that is supported on the ATM VC. It can take the following values:</p> <table border="1"> <thead> <tr> <th>Value</th> <th>Packet Service</th> </tr> </thead> <tbody> <tr> <td><b>bridge</b></td> <td>IEEE802.1D Transparent Bridging See chapter 6 for more information.</td> </tr> <tr> <td><b>pptp</b></td> <td>PPPoA-to-PPTP Relaying See chapter 8 for more information.</td> </tr> <tr> <td><b>ppp</b></td> <td>IP Routing &amp; PPP See chapter 9 for more information.</td> </tr> <tr> <td><b>cip</b></td> <td>IP Routing &amp; CIP See chapter 10 for more information.</td> </tr> </tbody> </table>	Value	Packet Service	<b>bridge</b>	IEEE802.1D Transparent Bridging See chapter 6 for more information.	<b>pptp</b>	PPPoA-to-PPTP Relaying See chapter 8 for more information.	<b>ppp</b>	IP Routing & PPP See chapter 9 for more information.	<b>cip</b>	IP Routing & CIP See chapter 10 for more information.
Value	Packet Service										
<b>bridge</b>	IEEE802.1D Transparent Bridging See chapter 6 for more information.										
<b>pptp</b>	PPPoA-to-PPTP Relaying See chapter 8 for more information.										
<b>ppp</b>	IP Routing & PPP See chapter 9 for more information.										
<b>cip</b>	IP Routing & CIP See chapter 10 for more information.										
Usage	<p>Indicates the state of the VC phonebook entry. This column is read only, and can take the following values:</p> <table border="1"> <thead> <tr> <th>Value</th> <th>Description</th> </tr> </thead> <tbody> <tr> <td><b>free</b></td> <td>The phonebook entry is not configured in any packet service web page. It does not consume the <b>STIAD</b> communications resources.</td> </tr> <tr> <td><b>configured</b></td> <td>The phonebook entry is configured in the appropriate packet service web page.</td> </tr> </tbody> </table>	Value	Description	<b>free</b>	The phonebook entry is not configured in any packet service web page. It does not consume the <b>STIAD</b> communications resources.	<b>configured</b>	The phonebook entry is configured in the appropriate packet service web page.				
Value	Description										
<b>free</b>	The phonebook entry is not configured in any packet service web page. It does not consume the <b>STIAD</b> communications resources.										
<b>configured</b>	The phonebook entry is configured in the appropriate packet service web page.										

**The 'AutoPVC' table** The following figure shows an example of the 'AutoPVC' table:

Type	VPI	VCI
bridge	8	35
pptp	8	48
ppp	8	64
ppp	8	67
cip	8	80

Any PVC, identified by its VPI/VCI and communicated via AutoPVC is added to the 'AutoPVC' table. If AutoPVC is not supported at the remote side, i.e. the Digital Subscriber Line Access Multiplexer (DSLAM), the 'AutoPVC' table stays empty.

See subsection 11.3.3 for more information.

## 11.3.2 Using the Phonebook

---

**Introduction** The main function of the **STPro** phonebook is to present an instant overview of all possible entries and their status.

Another important function is that it helps you to navigate through the various **STPro** VC connection possibilities.

---

- In this subsection**
- ▶ Restrictions for Adding Phonebook Entries
  - ▶ Adding Entries
  - ▶ Deleting Entries.
- 

### Restrictions for adding phonebook entries

Although you are free to give any name to a phonebook entry, a few restrictions apply:

- ▶ You may not provide an entry with a name which already is supplied in the *'Phonebook'* table.
- ▶ Phonebook entries, which are intended to be used for the PPPoA-to-PPTP Relaying packet service may not start with a capital 'P', or a capital 'T'.
- ▶ In case you want to use the **STPro** PPP-to-DHCP Spoofing feature, the name of the PPP entry you intend to use with this feature, must start with 'DHCP', e.g. DHCP\_Spoof1, DHCP\_2, etc.

Each entry in the **STPro** phonebook must have a unique VC, i.e. a unique VPI/VCI combination. Adding a phonebook entry with a VPI/VCI, which is already used in the *'Phonebook'* table, will result in an error message.

---



### Adding phonebook entries

Proceed as follows:

1. Browse to the 'Phonebook' page.
2. Enter a name of your choice to identify the new phonebook entry in the 'Name' field.
3. Enter the VC's VPI and VCI values in the 'VPI' and 'VPI' fields.  
**Note:** In most cases these values are provided by your SP.
4. Select the Packet Service of your choice, or choose any from the 'Type' pop-down list.
5. Click **Add** and **Save all** to finish the procedure.

### Deleting phonebook entries

On the 'Phonebook' page, click **Delete** next to the phonebook entry you want to delete. As a result your selection is deleted. Click **Save all**.



In the case you want to delete a configured phonebook entry, i.e. an entry which 'Usage' field displays **configured**, firstly you must delete the entry on the page related to the packet service type, displayed in the 'Type' field.

E.g. for a configured CIP phonebook entry, you must firstly delete the entry from the 'CIP connections' table of the 'CIP' page, prior to be able to delete the phonebook entry.

### 11.3.3 AutoPVC and the Phonebook

**AutoPVC** The default VCs, can be remotely modified via the *AutoPVC* feature of the **STPro**. AutoPVC operates only in conjunction with the Alcatel Digital Subscriber Line Access Multiplexer (DSLAM) – often referred to as ATM Subscriber Access Multiplexer (ASAM) – and offers the following functionality:

- ▶ User VCs that are to be terminated on the Ethernet port, can be notified by the **STPro**
- ▶ User VCs that need to be cross-connected between the DSL port and the ATMF-25.6 port, can be remotely established.

---

**Operation of AutoPVC** Basically the following steps are executed:

1. The DSL operator configures VCs on the DSLAM.
2. Via AutoPVC the VPI/VCI values are communicated to the **STPro**.
3. AutoPVC messages are subsequently processed by the **STPro**, according to the four criteria listed below.

---

**Criterion 1** Any PVC, or VPI/VCI communicated via AutoPVC is added to the AutoPVC list on the 'Phonebook' page.

If AutoPVC is not supported by the DSLAM, this list is empty.

---

**Criterion 2** If the VPI value is in the range from 0 up to 7, and the **STPro** is equipped with an ATMF-25.6 port, cross-connects will be configured between the DSL port and the ATMF-25.6 port.

---

**Criterion 3** An AutoPVC VPI value in the range from 8 up to 15 will be notified in the 'AutoPVC' list.

If the VPI/VCI value is used in the Phonebook, this phonebook entry will be highlighted by a yellow bar.

---

**Criterion 4** An Ethernet only **STPro** version (single port, or hub version) reacts identical as for Criteria 3, however the VPI range is now from 0 up to 15.

**Example 1** If the SP configures Virtual **Path** (VP) 5 on the DSLAM, then the **STPro** cross-connects VPI 5 on the DSL line to VPI 5 on the ATMF-25.6 port

**Example 2** If the SP configures Virtual **Channel** (VC) 0/32 on the DSLAM, then the **STPro** cross-connects VPI/VCI 0/32 on the DSL line to VPI/VCI 0/32 on the ATMF-25.6 port.

**Example 3** Suppose the SP configures one of the **STPro**'s default **terminated VCs**, e.g. 8/35, on the DSLAM.

VPI/VCI 8/35 will end up in the 'AutoPVC' list:

Type	VPI	VCI
bridge	8	35

As this VC matches with the Bridging entry *Br1*, this phonebook entry will be highlighted in the 'Phonebook' table:

## Phonebook

Name	VPI	VCI	Type	Usage	Action
Br1	8	35	bridge	configured	-
Pr2	8	36	bridge	free	

In this way the user can distinguish the activated VC from dummy phonebook entries.



# 12 Networking Services – IP

**Introduction** For Internet access, and home networking, IP(\*) plays a crucial role. Due to the flexibility and the multitude of IP features, numerous configurations are possible.

(\*) Although not the same, IP is often referred to as Transmission Control Protocol (TCP)/IP.

**Aim of this chapter** This chapter highlights some general IP parameters and some possible IP configurations for the below purposes:

- ▶ Internet access via your SP
- ▶ Private LAN-to-LAN interconnections over the DSL/ATM network
- ▶ Local IP connectivity towards other PCs on your LAN.

## In this chapter

Topic	See
<b>STPro</b> and IP	12.1
Packet Services and IP	12.2
<b>STPro</b> Addresses	12.3
<b>STPro</b> DHCP	12.4
<b>STPro</b> Routing	12.5
<b>STPro</b> NAT&PAT	12.6

## 12.1 Speed Touch and IP

---

**Introduction** In this section all IP features of the **STPro** are shortly described.

---

**STPro IP addressing** The **STPro** has a preconfigured “Net10” address: 10.0.0.138. As the **STPro** IP layer supports logical multi-homing (one interface supporting multiple IP addresses), multiple manually configured IP addresses and multiple dynamically assigned IP address(es) can be active at the same time.

---

**STPro DHCP** The **STPro** features a DHCP server. Dynamic Host Configuration Protocol (DHCP) allows the PC(s) on your local network to retrieve automatically an IP address from an “IP address leasing” server, i.e. a DHCP server. See subsection 12.4 for more information.

---

**STPro IP router** The **STPro** features an IP router. In general, IP Routing allows hosts to contact other hosts which reside in other (sub)networks. For the **STPro** the main function of the IP router is to route IP packets from the local network to the remote networks over the ATM/DSL connections and vice versa. See section 12.5 for more information.

---

**STPro NAT & PAT** The **STPro** features a combination of Network Address Translation (NAT) and Port Address Translation (PAT) called NA(P)T. Combined with the **STPro** IP Router, NA(P)T allows multiple PCs to share a single public IP address. See section 12.6 for more information.

---

## 12.2 Packet Services and IP

---

**Introduction** In this section the interaction between IP addresses and packet services is described.

Apart from Bridging, all packet services require the IP suite, and even the Bridging packet service will in most cases be used in combination with IP addressing.

---

### In this section

Topic	See
Transparent Bridging	12.2.1
PPPoA-to-PPTP Relaying	12.2.2
Routed Packet Services	12.2.3

---

## 12.2.1 Transparent Bridging

**IP vs. Bridging** Basically, Bridging does not require any IP address at all: neither in your PC(s), nor in your **STPro**.

However, in case of Internet access, private IP networking or in case the Bridging packet service is used for Bridged PPPoE, your PC(s) must be configured for TCP/IP.

**Typical Bridging Setup** In most cases, your SP will require you to use DHCP for your PC. In this case the DHCP server is at the remote side of the DSL connection. Therefore, your **STPro**'s DHCP server must be disabled.

**Using TCP/IP and Bridging** Your SP may:

- ▶ Provide you with an IP address
- ▶ Require you to use DHCP.

**Local IP communication** Alternatively, a second but *Private* IP address can be manually configured for local IP communication. It depends on your OS whether it supports this combination.  
e.g. Microsoft supports Logical Multihoming via Registry keys.



### Bridging & DHCP Service

The **STPro** DHCP server is by default **enabled** (via Auto DHCP).

In case you use your **STPro** in Bridging mode and your ISP requires you to enable DHCP in your PC(s), you **must** disable the DHCP server inside the **STPro** to avoid conflicts between two DHCP servers being active at the same time.

Setting the DHCP modes of your **STPro** is described in section 12.4.



---

## 12.2.2 PPPoA-to-PPTP Relaying

- 
- IP vs. PPPoA/PPTP** Prior to using PPTP, local IP addresses must be configured. The use of these IP addresses is limited to the local network.
- 
- Private IP addresses** You are free to choose any IP address as long as it is compatible with your local network and is unique in that same network.  
As the **STPro** has a preconfigured “Net10” address (10.0.0.138), you should configure IP addresses like 10.0.0.1, 10.0.0.2, ... on your PCs.  
**Note:** IP addresses can be configured automatically via **STPro**’s DHCP server. See section 12.4 for more information.
- 
- Public IP addresses** A second set of (Public) IP addresses having end-to-end scope will automatically be negotiated via the PPP protocol inside your PC(s).
- 
- Simultaneous use of public & private IP** Both Public and Private IP addresses are active simultaneously because of tunneling. In fact two “nested” IP layers exist: the *Public* IP layer which is carried within the *Private* IP layer on the local LAN.
- 
- PPP IP address negotiation** By default the PPTP tunnel application automatically negotiates the Public IP address.  
In case your SP instructs you to use a static IP address for Relayed PPPoA, most dial-in applications allow a static IP address to be supplied.
-

## 12.2.3 Routed Packet Services

---

### IP routing and IP addresses

Local IP addresses must be configured prior to use IP routing.

---

### STPro IP addresses

As the **STPro** has a preconfigured “Net10” address (10.0.0.138), you can configure IP addresses like 10.0.0.1, 10.0.0.2, ... in your PCs, or use the **STPro** DHCP server.

In case another IP address is required, you can set **STPro**'s IP address via the **STPro** pages.

See sections 12.3 and 16.1 for more information.

---

### PC IP address configuration

The PC IP address can be configured statically (no DHCP), or dynamically (**STPro** as DHCP server).

---

### Default gateway for the PCs

In addition, configure the **STPro**'s IP address as default gateway in your PCs.

---

### PPP & IP Routing

At the DSL side of the **STPro** IP router, PPP automatically negotiates an IP address with its remote PPP peer.

You can configure the PPP local IP address of the **STPro**. In special circumstances, you can configure a remote IP address for the PPP connection.

See subsection 9.4.4 for more information.

---

### CIP & IP Routing

As its name implies Classical IP & IP Routing relies on basic IP Addressing and routing for its packet forwarding.

I.e. both local as remote users on either side of the DSL connection experience the LIS environment as if they are sharing one single network.

The configuration and use of all IP specific issues for a Classical IP environment is profoundly described in chapter 10.

---

## 12.3 Speed Touch Addresses

---

**Introduction** Like any other member of a LAN, the **STPro** must be locally identified by an IP address to be able to communicate with other local LAN devices.

This section deals with the IP address configuration of the **STPro** for local communication only.

---

### In this section

Topic	See
<b>STPro</b> IP Address Types	12.3.1
Static IP Address Configuration	12.3.2

---

### 12.3.1 STPro IP Address Types

#### Assigning IP addresses to the STPro

IP addresses can be assigned to the **STPro** in several ways. Summarized, following IP address types exist:

- ▶ The default IP address: 10.0.0.138
- ▶ IP addresses assigned via the 'Initial Setup' page
- ▶ IP addresses assigned via a 'Ping-of-Life™
- ▶ IP addresses assigned via the 'Routing' page
- ▶ IP addresses assigned to the **STPro** via DHCP
- ▶ IP addresses configured and/or negotiated by connections.

#### STPro and multiple IP addresses

As the **STPro** IP layer supports logical multi-homing (one interface supporting multiple IP addresses), both statically and dynamically configured IP address(es) can be active at the same time.

#### 'IP address' table

On the **STPro** 'Routing' page the 'IP address' table summarizes all IP addresses configured on any of the **STPro** interfaces.

Intf	Address	Netmask	Type	Transl	Action
eth0	10.0.0.138	255.0.0.0	Extra	none	<a href="#">Delete</a>
cip0	172.16.1.1	255.255.255.0	CIP	none	-
loop	127.0.0.1	255.0.0.0	Auto	none	-

Use input fields below to add a new entry

eth0	<input type="text"/>	<input type="text"/>	Extra	none	<a href="#">Add</a>
------	----------------------	----------------------	-------	------	---------------------

**'IP address' table components**

Field	Description										
<i>Intf</i>	Indicates the interface (Intf) to which the IP parameter set was assigned to.  It can take several values depending on the packet services that are active. The Ethernet (eth0) and the Loopback (loop) are always present.										
<i>Address</i>	Shows the IP address of the interface.										
<i>Netmask</i>	If available, it shows the netmask of the interface.										
<i>Type</i>	Indicates the origin of the IP parameters. It can take following values: <table border="1" data-bbox="762 741 1382 1182"> <thead> <tr> <th>Value</th> <th>Description</th> </tr> </thead> <tbody> <tr> <td><b>Auto</b></td> <td>Implies that the parameters were acquired automatically through DHCP, or are typical standard IP addresses (e.g. 'loop').</td> </tr> <tr> <td><b>User</b></td> <td>Implies that an additional IP parameter set was added through the 'Initial Setup' page.</td> </tr> <tr> <td><b>Extra</b></td> <td>Implies that an additional IP parameter set was added through the 'Routing' page. The default IP address 10.0.0.138 is also of this type.</td> </tr> <tr> <td><b>Temp</b></td> <td>Implies that this (additional) IP parameter set was added via a <i>Ping-of-Life</i><sup>TM</sup>.</td> </tr> </tbody> </table>	Value	Description	<b>Auto</b>	Implies that the parameters were acquired automatically through DHCP, or are typical standard IP addresses (e.g. 'loop').	<b>User</b>	Implies that an additional IP parameter set was added through the 'Initial Setup' page.	<b>Extra</b>	Implies that an additional IP parameter set was added through the 'Routing' page. The default IP address 10.0.0.138 is also of this type.	<b>Temp</b>	Implies that this (additional) IP parameter set was added via a <i>Ping-of-Life</i> <sup>TM</sup> .
Value	Description										
<b>Auto</b>	Implies that the parameters were acquired automatically through DHCP, or are typical standard IP addresses (e.g. 'loop').										
<b>User</b>	Implies that an additional IP parameter set was added through the 'Initial Setup' page.										
<b>Extra</b>	Implies that an additional IP parameter set was added through the 'Routing' page. The default IP address 10.0.0.138 is also of this type.										
<b>Temp</b>	Implies that this (additional) IP parameter set was added via a <i>Ping-of-Life</i> <sup>TM</sup> .										
<i>Transl</i>	Indicates whether translation is allowed/performed on this IP address or not. It can take following values: <table border="1" data-bbox="762 1319 1382 1507"> <thead> <tr> <th>Value</th> <th>Description</th> </tr> </thead> <tbody> <tr> <td><b>None</b></td> <td>No address translation can be performed on this address.</td> </tr> <tr> <td><b>PAT</b></td> <td>NA(P)T can be (or is) performed on this address.</td> </tr> </tbody> </table>	Value	Description	<b>None</b>	No address translation can be performed on this address.	<b>PAT</b>	NA(P)T can be (or is) performed on this address.				
Value	Description										
<b>None</b>	No address translation can be performed on this address.										
<b>PAT</b>	NA(P)T can be (or is) performed on this address.										

## 12.3.2 Static IP Address Configuration

### Default STPro IP address

In case you add the **STPro** to an existing LAN, it could be that you must configure a “User Defined” IP address, other than the “Net 10” address, appropriate for the LAN’s IP settings.

### In this subsection

- ▶ Setting an IP Address via the ‘Initial Setup’ Page
- ▶ Setting an IP Address via the ‘Routing’ Page.

### Setting an IP address via the ‘Initial Setup’ page

Proceed as follows:

1. Click **Initial Setup** in the left pane of the **STPro** pages to pop up the ‘Initial Setup’ page (See section 17.2 for more information):

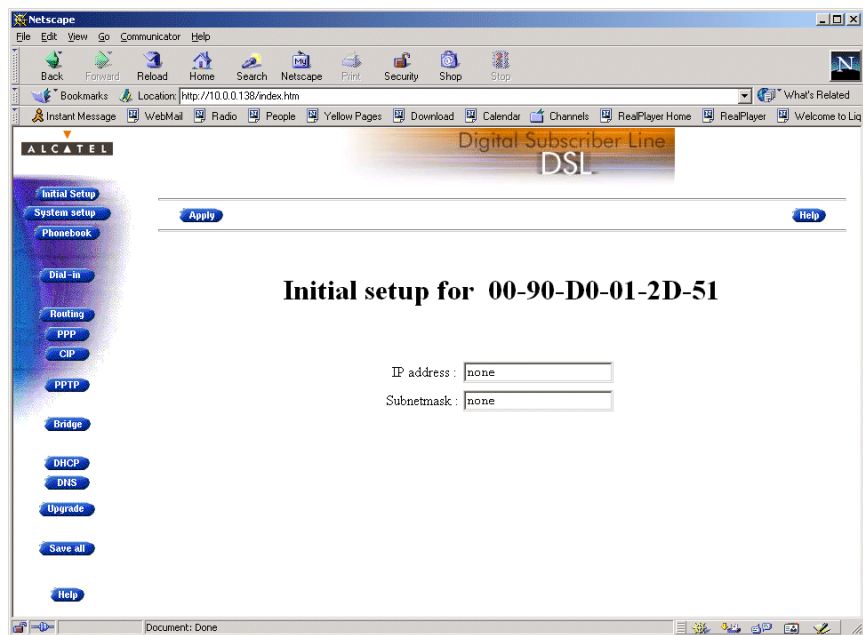

2. Enter an IP address in the ‘IP Address’ field.
3. Enter a netmask for applying subnetting in your network in the ‘Subnetmask’ field.

- Click **Apply**. As a result the new IP settings are applied:

**RESULT : the IP settings have been applied. Change the IP settings on your own machine (if needed) and point your browser at the new address (<http://10.0.0.151/>) to verify connectivity with the new configuration. Use 'Save all' to make it permanent.**

- To verify connectivity, point your Web browser to the new IP address. Make sure though that your PC shares the same subnet.
- Click **Save all** to store the applied IP settings to permanent storage.

### Setting an IP address via the 'Routing' page

Proceed as follows:

- Click **Routing** in the left pane of the **STPro** pages to pop up the 'Routing' page (See section 17.2 for more information). On this page the following 'IP Address' table can be found:

Intf	Address	Netmask	Type	Transl	Action
eth0	10.0.0.138	255.0.0.0	Extra	none	<b>Delete</b>
cip0	172.16.1.1	255.255.255.0	CIP	none	-
loop	127.0.0.1	255.0.0.0	Auto	none	-

Use input fields below to add a new entry

eth0	<input type="text"/>	<input type="text"/>	Extra	none	<b>Add</b>
------	----------------------	----------------------	-------	------	------------

- Enter the following information:
  - Select *eth0* from the 'Intf' drop-down list
  - Enter an IP address in the 'IP Address' field, e.g. 192.6.11.150
  - Enter an associated (sub)netmask in the 'Netmask' field, e.g. 255.255.255.0
- Click **Add**. As a result the new IP settings are applied.
- To verify connectivity, point your Web browser to the new IP address. Make sure though that your PC shares the same subnet.
- Click **Save all** to store the applied IP settings to permanent storage.

**Sample configuration:  
single PC**

In the below figure, a simple configuration is given: One PC attached to the **STPro**:

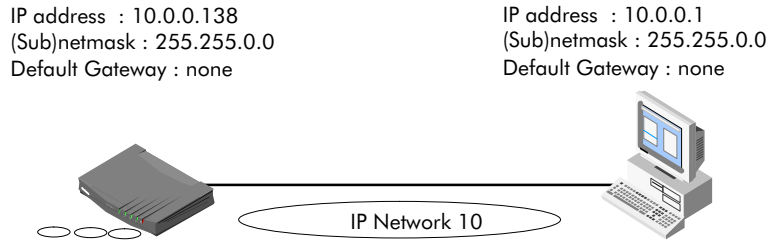

**Sample configuration:  
small workgroup**

You can setup a local workgroup around the **STPro** as shown in the figure below.

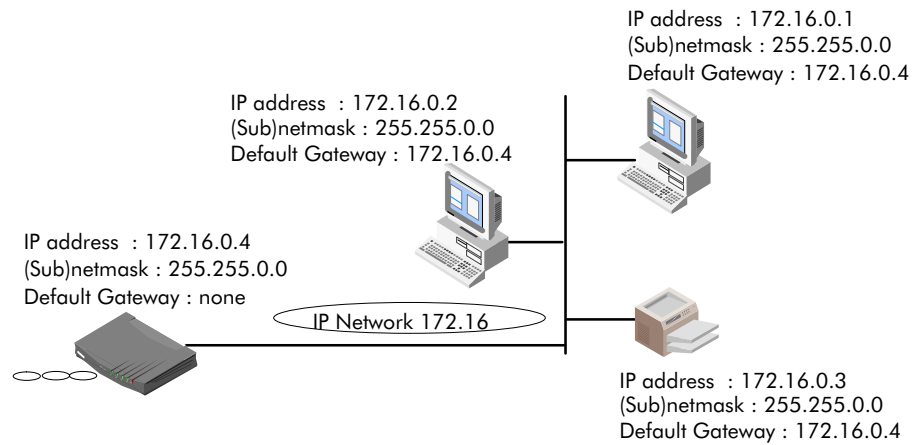

**Note:** Notice that the default gateways in the PCs point to the **STPro**.

---



## 12.4 Speed Touch DHCP

**DHCP** Depending on the size and complexity of your network, a few DHCP configurations can be envisaged:

LAN Type	DHCP Mode	Argumentation
Simple	No	All few members of the small LAN have static IP addresses, including the <b>STPro</b> .
Medium sized	Server	For small home LANs it might be worthwhile to configure all of your LAN devices as DHCP clients, and the <b>STPro</b> as the DHCP server.  In this configuration each time a computer starts, it will obtain its IP configuration from the <b>STPro</b> .
Advanced	Client	For advanced networks, the role of DHCP server might be performed by an IP node other than the <b>STPro</b> on the local LAN.  Typically such functions are attributed to home gateways: computers having better networking capabilities than the other PC(s) on the home LAN.  All local PCs remain configured as DHCP clients, including the <b>STPro</b> .

**Default STPro DHCP** Both the **STPro** DHCP server and DHCP client are enabled by default: *AutoDHCP*.

### In this section

Topic	See
The <b>STPro</b> DHCP Pages	12.4.1
The <b>STPro</b> DHCP Server	12.4.2
The <b>STPro</b> DHCP Client	12.4.3

## 12.4.1 STPro DHCP Pages

The 'DHCP' page Click **DHCP** in the left pane of the **STPro** pages to pop up the 'DHCP' page (See section 17.2 for more information):

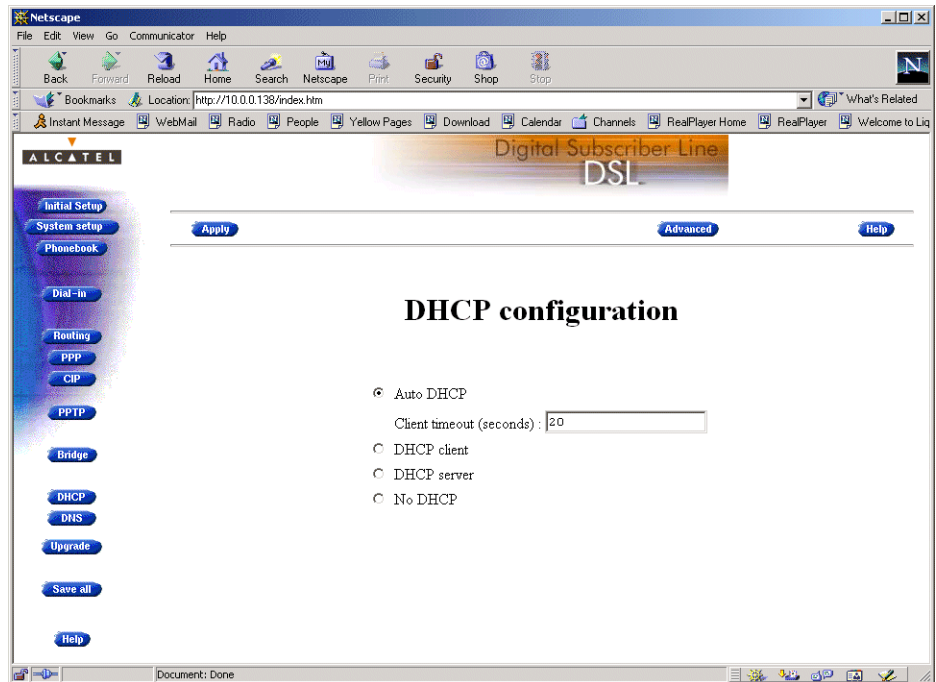

## 12.4.2 The STPro DHCP Server

- In this subsection**
- ▶ The '*DHCP Server Start-up Mode*' Radiobuttons
  - ▶ Configuring the **STPro** for LANs without DHCP Server
  - ▶ Configuring the **STPro** as DHCP Server
  - ▶ Configuring the **STPro** for Auto DHCP
  - ▶ '*DHCP Server Configuration*' Table
  - ▶ Address Pool Configuration
  - ▶ PPP Spoofing Configuration
  - ▶ '*DHCP Server Lease*' Table
  - ▶ Adding Leases Manually.

**'DHCP Server Start-up Mode' radiobuttons** On the **STPro** '*DHCP*' page the '*DHCP Server Start-up Mode*' radiobuttons allow to configure the **STPro** DHCP server mode:

- Auto DHCP
  - Client timeout (seconds) :
- DHCP client
- DHCP server
- No DHCP

### Configuring the STPro for a LAN without DHCP

To setup the **STPro** without DHCP, tick  No DHCP .

In this configuration, it is assumed that all members, the **STPro** included, have static IP addresses.

See subsection 12.3.2 for static IP addressing of the **STPro**.

**Note:** This configuration might be required in case you use the Transparent Bridging packet service.

### Configuring the STPro as DHCP server

To setup the **STPro** as DHCP server, tick  DHCP server .

Via the 'DHCP Server Configuration' tables, you can configure the **STPro** DHCP server settings.

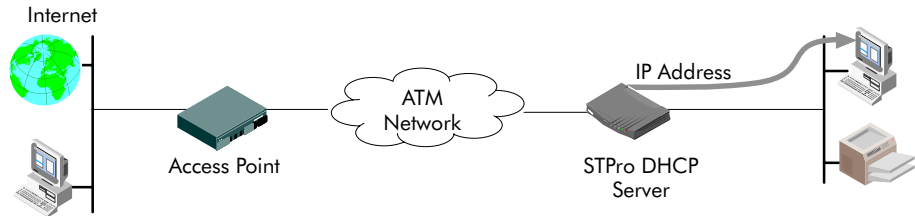

**Note:** This setting might cause side effects with Bridging. See section 12.2.1 for more information.

### Configuring the STPro for Auto DHCP

One of the **STPro** features is that it can automatically revert from DHCP client to DHCP server.

At boot time the **STPro** probes the LAN for a specified time limit ('Client timeout') to check whether another DHCP server is available on the network. If so, it will act as a DHCP client. If no response is received within the specified time, the **STPro** becomes a DHCP server.

To allow the **STPro** to act as Auto DHCP client/server, tick

Auto DHCP .

Additionally, you can configure the 'Client timeout' in seconds:

Client timeout (seconds) :  .

Via the 'DHCP server configuration' tables, you can configure the **STPro** DHCP server settings.

**Automatic IP addressing**

OSs supporting '*Automatic IP Addressing*', might initially not establish IP connectivity with the **STPro**. This is because the IP address they assimilated is not within the **STPro** '*Auto DHCP*' server range.

**To prevent this problem, please power on your LAN devices after the STPro has come online.**

Indeed, when the **STPro** is in '*Auto DHCP*', it will first operate as a DHCP client. After the client timeout exceeded, it switches to DHCP server mode, but this might be too late as some clients will already selected an automatic IP address.

Dynamic IP addressing is a feature allowing DHCP clients to assign themselves an IP address.

This happens when there is no DHCP server on the network, or when the server is temporarily down. After automatic assignment, the DHCP client will issue DHCP requests at regular instances.

If the DHCP server is back online, the client will now lease an IP address from the server, after discarding its temporary automatic IP address.

---

**The 'DHCP server configuration' table**

Click **Advanced** on the 'DHCP' page to pop up the 'DHCP server configuration' page:

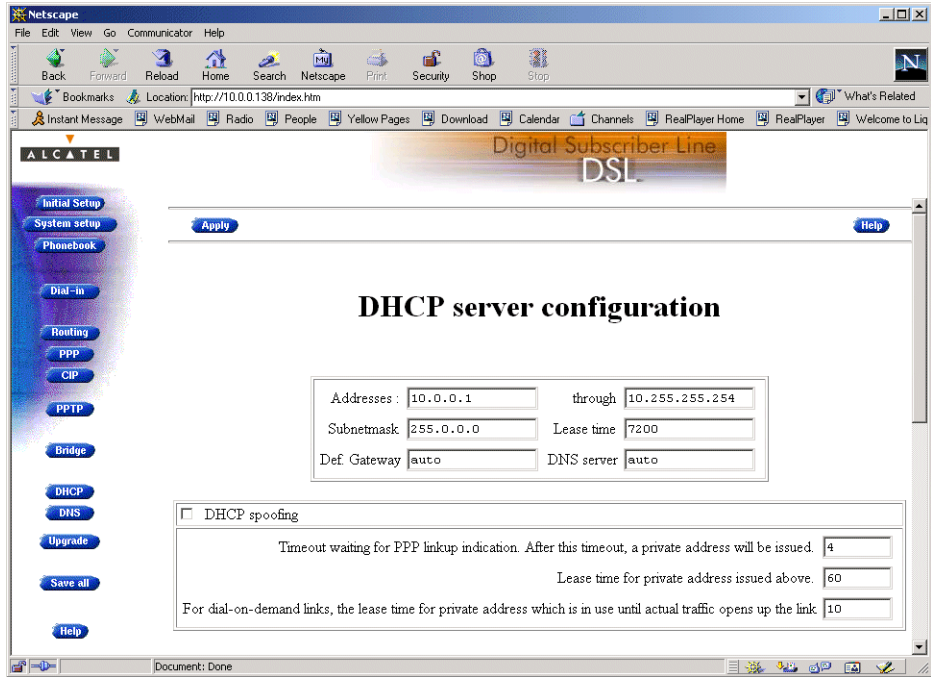

**Address pool configuration**

You can configure following DHCP server parameters:

Field	This configures ...	Default
Addresses through ...	The range of addresses the DHCP server can choose an IP address from for lease.	"Net10"
Subnet Mask	The subnetting applied to the local network, scoped by the DHCP server.	no subnetting
Lease Time	The time (Lease Time) IP addresses can be assigned to a device by DHCP.	7200 seconds
Default Gateway	The IP address of the default gateway.	'auto' (*)
DNS Server	The IP address of the DNS server.	'auto' (**)

(\*) Setting 'auto' in the 'Def. Gateway' field means, that there will be referred to the 'Routing' page.

(\*\*) Setting 'auto' in the 'DNS server' field means, that there will be referred to the 'DNS' page.

**DHCP spoofing configuration**

This box allows you to set the DHCP spoofing parameters for PPP-to-DHCP spoofing connections.

You can configure following parameters:

Field	This configures ...	Default
<i>PPP link-up timeout</i>	The number of seconds to wait for a PPP link to successfully negotiate an IP address. After timeout a private IP address will be issued.	4 seconds
<i>Private lease time</i>	The time (Lease Time) in seconds of the private IP address issued when after timeout a PPP link fails.	60 seconds
<i>Dial-on-demand lease time</i>	The lease time for the temporary private IP address in case of a Dial-on-demand PPP link.	10 seconds

**DHCP lease table**



This table allows you to overview all current leases of the **STPro** DHCP server (if activated) or manually add new leases:

Client id	address	Expires	State	Action
01:52:41:53:20:a0:c2:33:62:57:6b:c0:01:01:00:00:00	10.0.15.25	15	free	<a href="#">Delete</a>
01:52:41:53:20:50:6d:c0:40:02:32:c0:01:01:00:00:00	10.0.15.26	18	free	<a href="#">Delete</a>
01:52:41:53:20:80:62:c9:ba:a0:95:c0:01:01:00:00:00	10.0.15.27	39	free	<a href="#">Delete</a>
01:52:41:53:20:f0:79:a8:a6:9e:7c:c0:01:01:00:00:00	10.0.15.28	53	free	<a href="#">Delete</a>
01:52:41:53:20:30:f4:89:5f:9b:44:c0:01:01:00:00:00	10.0.15.29	54	free	<a href="#">Delete</a>
01:52:41:53:20:10:2e:29:25:b5:7e:c0:01:01:00:00:00	10.0.15.30	64	free	<a href="#">Delete</a>
01:52:41:53:20:20:27:49:47:b2:5e:c0:01:01:00:00:00	10.0.15.31	105	free	<a href="#">Delete</a>
01:00:a0:24:ae:66:e1	10.0.0.25	4803	used	<a href="#">Delete</a>
01:00:90:d0:01:47:de	10.0.7.159	6257	used	<a href="#">Delete</a>
Use input fields below to add a new entry				
<input type="text"/>	<input type="text"/>	-	-	<a href="#">Add</a>

### **Adding leases manually**

You can add leases manually in case the devices need reserved IP addresses (e.g. FTP server) or in case the device is not able to send/receive DHCP requests/replies. These leases are permanent, i.e. will never be released.

Proceed as follows:

- 1.** Enter the following information:
    - Enter the MAC address of the device you want to lease and an IP address in the 'Client ID' field
    - Enter an IP address in the 'IP Address' field.
  - 2.** Click . As a result the new lease is applied.
  - 3.** Click  to store the applied lease to permanent storage.
-



## 12.4.3 The STPro DHCP Client

- In this subsection**
- ▶ The **STPro** DHCP Client
  - ▶ 'DHCP Client Configuration' Table
  - ▶ 'DHCP Client Configuration' Table Components
  - ▶ Enabling an **STPro** DHCP Client

**The STPro DHCP client** Apart from being DHCP server, the **STPro** can also act as DHCP client. The dynamically assigned IP addresses is obtained from a DHCP server (other than the **STPro**) on the local network.

**Configuring the STPro as DHCP client** To setup the **STPro** as DHCP client, tick  DHCP client on the 'DHCP' page.

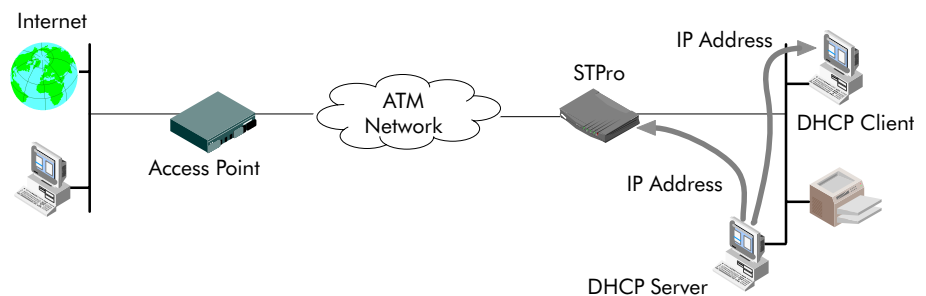

## 12.5 Speed Touch Routing

---

**Introduction** Next to the DSL router part, the **STPro** supports also IP routing via its IP router.  
This section aims to familiarize you with the **STPro** IP router abilities.

---

**In this section**

Topic	See
The <b>STPro</b> IP router	12.5.1
Configuring the <b>STPro</b> IP Routing Table	12.5.2

---

---

## 12.5.1 The STPro IP Router

---

**Introduction** Because the **STPro** can act as an IP router, it has the ability to access hosts in other networks than its own. This can be achieved by adding specific routes to its IP routing table.

This subsection provides some general information on the **STPro** IP router functionality.

---

- Features** IP routing:
- ▶ Is a standard and a well-known principle, mainly due to the widespread Internet use
  - ▶ Has broad application support, as it is implemented in most, if not all Operating Systems (Windows, Unix, Linux, Mac OS, ...).
- 

**Configuring an IP routing table** The routes in an ordinary routing table or Forwarding Information Base (FIB) include, among others, destination IP addresses, subnet masks and gateways.

When an IP packet arrives at the router, the router examines the destination IP address. The router looks up the most specific match in the routing table for that destination address. Finding the most specific match equals finding the longest subnet mask for that IP address.

For example, the subnet mask 255.255.255.0 is more specific than 255.255.0.0 because the network part in the first case is longer (and thus more specific) than the network part in the second case.

Once the most specific match is found, the router forwards the IP packet to the gateway associated with that match.

---

### Simplified example of a traditional IP routing table

The following table is an example of an IP routing table:

Route Destination	Subnet Mask	Gateway
30.0.0.2	255.255.255.255	30.0.0.10
10.0.0.0	255.255.255.0	10.0.0.138
0.0.0.0	0.0.0.0	20.0.0.10

### The STPro IP routing table

Depending on the configuration made, the **STPro** may use an extended routing table.

In addition to the data contained in an ordinary routing table, it contains information about the source IP address and the source subnet mask.

The lookup principle may also be extended: not only the combination of destination IP address and subnet mask is looked up, but also the combination of source IP address and subnet mask.

The extended IP routing table gives extra functionality to the **STPro** and is explained in subsection 12.5.2.

### Example of the STPro extended IP routing table

The following table is an example of the **STPro** extended IP routing table:

Dest. IP Address	Dest. Subnet Mask	Source IP Address	Source Subnet Mask	Gateway
30.0.0.2	255.255.255.255	10.0.0.2	255.255.255.255	30.0.0.10
10.0.0.0	255.255.255.0	10.0.0.0	255.255.255.0	10.0.0.138
0.0.0.0	0.0.0.0	10.0.0.0	255.255.255.0	20.0.0.10

**prefix notation for IP addresses**

A more up to date representation of masks does not refer to a subnet mask, but to a prefix length.

The prefix number equals the number of ones in the subnet mask. For example, the subnet mask 255.255.255.0 could also be written as the prefix /24.

---

**Example**

For example:

- ▶ IP address 10.0.0.138
- ▶ netmask 255.255.255.0

With the prefix notation this will be written as :

- ▶ prefix IP address 10.0.0.138/24
- 

**STPro and prefix notation**

In the **STPro** routing table the prefix notation will be used.

---

## 12.5.2 Configuring the STPro IP Routing Table

**Introduction** The main function of the IP router in the **STPro**, is to route IP packets from the local network to the remote networks over the ATM/DSL connections and vice versa.

In this subsection, the configuration of the **STPro** IP routing table is described.

- In this subsection**
- ▶ General ATM/ADSL End-to-End IP Architecture
  - ▶ ATM/DSL IP Routing
  - ▶ **STPro** Power-on IP Routing Table Configuration
  - ▶ 'IP route' Table
  - ▶ 'IP route' Table Components
  - ▶ Adding Specific Routes to the 'IP Route' Table
  - ▶ Criteria for a Route to be Valid.

### General ATM/DSL end-to-end IP architecture

The figure below provides an overview of the general end-to-end IP architecture:

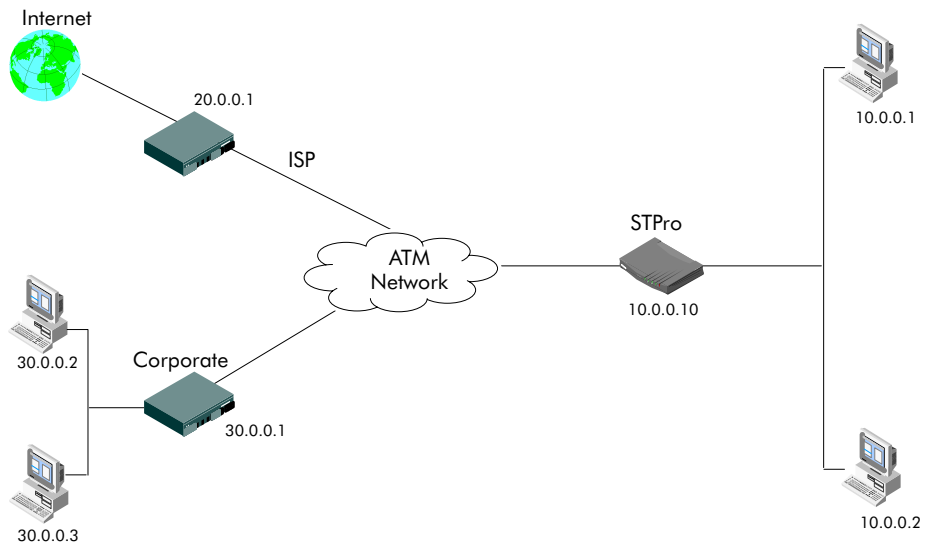

**ATM/ADSL IP routing**

Routing to ATM/DSL connections actually means:

- ▶ Routing between the local LAN and Classical Logical IP subnets and vice/versa
- ▶ Routing between the local LAN and PPP connections and vice/versa.

Basically the IP router only cares about IP addresses, i.e. the 'Destination IP address' of any packet received on any of its interfaces (PPP, CIP or Ethernet) is looked up in the IP routing table. The lookup process will determine the best route that may lead to the final destination of the packet. As a consequence it will forward the packet to the interface that may reach this destination.

---

**STPro power-on IP routing table configuration**

When the **STPro** is powered on, routes are automatically configured in the routing table for the following possible IP address entries in the 'IP address' table:

- ▶ As soon as the Ethernet interface is up and running, routes are added for each of the Ethernet interface IP addresses.
  - ▶ Routes are added for the IP address negotiated between the remote peer and an **STPro** PPP & IP Routing entry (configured for Always-On).
  - ▶ If a CIP member is created and explicitly configured with an IP address, routes are added for this IP address.
-

**'IP route' table** On the **STPro** 'Routing' page the 'IP route' table summarizes all IP routes configured on the **STPro**:

Destination	Source	Gateway	Intf	Action
10.0.0.0/8	10.0.0.0/8	10.0.0.138	eth0	Delete
255.255.255.255/32	any	10.0.0.138	eth0	Delete
10.0.0.138/32	any	10.0.0.138	eth0	Delete
172.16.1.1/32	any	172.16.1.1	cip0	Delete
127.0.0.1/32	any	127.0.0.1	loop	Delete
172.16.1.0/24	any	172.16.1.1	cip0	Delete
10.0.0.0/8	any	10.0.0.138	eth0	Delete

Use input fields below to add a new entry

<input type="text"/>	<input type="text"/>	<input type="text"/>	-	Add
----------------------	----------------------	----------------------	---	-----



**'IP Route' table components**

Field	Description
<i>Destination</i>	Indicates the destination IP address (pool)/prefix mask or "next-hop" device IP address for the IP route.
<i>Source</i>	Indicates the source IP address (pool)/prefix mask of the IP route.
<i>Gateway</i>	Indicates the IP address of the directly connected gateway to which the routed packets for this interface are forwarded.
<i>Intf</i>	Indicates the interface (Intf) on which the IP route is applied. It can take several values depending on the packet services that are active. Among others the Ethernet (eth0) and the Loopback (loop) should always be present.



### Adding specific routes to the 'IP route' table

Proceed as follows:

1. Enter the following route information:
  - 'Destination' IP address (pool) of the destination or "next-hop" device in prefix notation  
Specifying **default** indicates that all outgoing traffic is sent over this route.
  - 'Source' IP address (pool) in prefix notation  
Specifying **any** indicates that all traffic coming from the Ethernet interface is sent over this route.
  - 'Gateway' IP address of a directly connected gateway device, e.g. the **STPro** itself.
2. Click . As a result the route is applied.
3. Click  to store the routing configuration to permanent storage.

### Criteria for a route to be valid

A route is only accepted by the **STPro** if it meets following conditions:

- ▶ The destination and source entries must yield correct prefixes
- ▶ The gateway must be directly connected.

## 12.6 Speed Touch NAT&PAT

**NA(P)T** Network Address Translation (NAT) is a technique that allows you to shield or decouple an internal (Private) IP address from the (negotiated) external (Public) IP address.

In addition, via Port Address Translation (PAT), this single external Public IP address is mapped onto multiple internal ports on the LAN, thus allowing multiple users to share this external IP address simultaneously.

The amalgam of address & port allocation is often referred to as Network Address and Port Translation (NA(P)T).

**Note:** NA(P)T is described in RFC3022 which obsoletes RFC1631 “The IP Network Translator (NAT)”.

### In this section

Topic	See
<b>STPro</b> and NA(P)T	12.6.1
Packet Services and NA(P)T	12.6.2

## 12.6.1 STPro and NA(P)T

---

**Use of NA(P)T** NAT is a technique used to share one IP address amongst several PCs. For most applications, enabling NA(P)T on a specific **STPro** interface, e.g. on a PPPoA interface is adequate. From then on, all PPPoA clients behind the **STPro** NAT router automatically share the same IP address.

To serve that purpose, the CLI allows NA(P)T to be enabled per interface.

---

**Services behind the STPro** To run a server behind a NAT router, additional configuration is needed. Therefore, the **STPro** exhibits NA(P)T specific commands allowing static IP address and UDP/TCP port mapping for inbound IP packets to be configured.

Moreover a default server can be specified. All incoming connections will be forwarded to the device with this IP address. In most cases this setting should be adequate for most server applications.

---

**NA(P)T and supported protocols** All supported protocols that are insensitive for NA(P)T, pass transparently through the **STPro** NA(P)T router. In addition, the **STPro** supports also the following protocols as NA(P)T insensitive:

- ▶ All generic TCP/User Datagram Protocol (UDP) protocols, e.g. HTTP (Hyper Text Transfer Protocol)
- ▶ Internet Control Message Protocol (ICMP)
- ▶ File Transfer Protocol (FTP)
- ▶ Internet Relay Chat (IRC)
- ▶ Real Audio
- ▶ Real Time Stream Protocol (RTSP).

## 12.6.2 Packet Services and NA(P)T

---

**Introduction** The **STPro** supports NA(P)T to be used in combination with:

- ▶ PPP & IP Routing
- ▶ CIP & IP Routing.

---

**PPP & IP Routing** You can enable/disable NA(P)T via the '*PPP Configuration*' page per PPP entry.

In the '*Routing*' box (See subsection 9.4.3) it is possible to check/uncheck the NAT flag (✓). This allows the **STPro** to decouple your local IP addresses from the public IP address negotiated during a session.

---

**CIP & IP Routing** You can enable/disable NA(P)T for each IP address of type CIP via the CLI. This allows the **STPro** to decouple the explicit assigned or implicit assigned IP addresses from your local network configuration. That way, the **STPro** is able to act as a genuine LIS member and to route between the CIP LIS and your LAN.

---

**Consequences of NA(P)T on layers** The NA(P)T feature comes at the expense of the **STPro** transparency. This because a number of protocols that are layered on top of either TCP/IP or UDP/IP do not adhere to the ISO/OSI reference model.

**Note:** The ISO Open Systems Interconnection (OSI) reference model promotes the layered implementation of communications protocol stacks. Layers from protocol stacks implemented according to this model can be changed without affecting the upper or lower layers.

An important consequence is that changing IP addresses or TCP/UDP ports via NA(P)T affects the other layers as well.

Due to these changes, applications that are the ultimate consumers of the protocols cannot decode the information correctly anymore.

---

- STPro solutions** The **STPro** offers some solutions to cope with this situation. Basically these solutions boil down in transporting Public IP addresses transparently through the **STPro** towards a device where a more advanced NAT and/or PAT can be performed. Some solutions are described in the following paragraphs:
- ▶ ATMF-25.6 (if equipped)
  - ▶ Via the PPP-to-PPTP Relay
  - ▶ PPP-to-DHCP Spoofing.

**ATMF-25.6** The ATMF-25.6 port offers maximum TCP/IP transparency because it switches ATM cells and does not touch TCP/IP information.

You might consider the following setup:

Step	Action
1	Install both an ATMF-25.6 PC-NIC and Ethernet PC-NIC in a PC.
2	Install an OS on this PC that has routing capabilities, e.g. Windows NT, UNIX, etc.
3	Install on this PC a NAT/PAT package that supports all TCP/IP protocols. Now this PC can act as some 'home gateway'.
4	Connect the ATMF-25.6 port of the <b>STPro</b> to the ATMF-25.6 PC-NIC.
5	Connect your local LAN to the Ethernet PC-NIC.

**Result** The Public IP address goes transparently through the **STPro** to end up in this advanced 'home gateway', where more complex NAT and/or PAT operations can be performed.

**Via the PPPoA-to-PPTP Relay**

A similar configuration as above can be used in combination with the **STPro** PPPoA-to-PPTP Relay.

Instead of installing an ATMF-25.6 PC-NIC, you must install a second Ethernet PC-NIC that connects to the **STPro**.

By setting up a PPTP tunnel from the 'home gateway', again the Public IP address is transported transparently through the **STPro** to end up in the 'home gateway'.

**PPP-to-DHCP Spoofing**

A third technique is to use the PPP-to-DHCP Spoofing feature of the **STPro**. The network configuration is practically identical to the one described above:

Step	Action
1	Install two Ethernet PC-NICs in a PC.
2	Install an OS on this PC that has routing capabilities, e.g. Windows NT, UNIX, Linux, etc.
3	Install on this PC a NAT/PAT package that supports all TCP/IP protocols. Now this PC can act as some 'home gateway'.
4	Connect (one of) the Ethernet interface(s) of the <b>STPro</b> to the PC's Ethernet PC-NIC port.
5	Connect your local LAN to the other Ethernet PC-NIC.
6	Configure the PC (acting as 'home gateway') as DHCP client.
7	Configure the <b>STPro</b> as DHCP server.
8	DHCP in the <b>STPro</b> must be configured for DHCP Spoofing. See section 12.4 for more information.
9	At least one PPP connection must begin with the mnemonic "DHCP" in its phonebook name, e.g. DHCP_Spoof.

**Result**

As soon as a DHCP request from the home gateway hits the **STPro**, a PPP-to-DHCP Spoofing connection is triggered. The IP parameters that are negotiated with the remote peer, are carried up to the home gateway via a DHCP reply message.

# 13 Networking Services – DNS

---

**Introduction** IP addresses are fundamental to the operation of the Internet. They not only uniquely identify Internet nodes but also allow IP routers to forward packets to their destinations.

IP addresses, being 32-bit numbers, are ideally suited for computers but are far from usable to humans.

Therefore, the *Domain Name System (DNS)* was designed: a distributed database, held by a hierarchical system of servers, that is used by TCP/IP applications to map between hostnames and IP addresses.

This chapter describes **STPro**'s DNS abilities.

---

## In this chapter

Topic	See
<b>STPro</b> DNS Resolving	13.1
Configuring your <b>STPro</b> DNS Server	13.2

---

## 13.1 Speed Touch DNS Resolving

---

**Introduction** The **STPro** features a DNS server for the locally attached PCs, and as DNS relay for non-local DNS hostnames.

---

**Local DNS resolving** The same mechanism for resolving computer names to IP addresses when browsing the Internet, applies to your local network.  
Instead of using the IP addresses for a local IP node e.g. 10.0.0.138 for the **STPro**, you can give your nodes names and let a local DNS server, e.g. the **STPro** itself, do the resolving.

---

**Example of local DNS resolving** In the following example, a LAN is built around the **STPro**. In this scenario, it is assumed that the **STPro** acts as DHCP server, and as DNS server for the local network.  
During start-up, a first PC launches a DHCP request on the LAN. One of the fields in the DHCP request contains the computer name e.g. *YourPC*.  
The **STPro** reacts by intercepting this request and returns a DHCP reply containing:

- ▶ The IP address for his computer, e.g. 10.0.0.1
- ▶ The local domain name, e.g. *lan* (default)
- ▶ The IP address of the local DNS server, e.g. 10.0.0.138 being the **STPro** (default).

A second PC, named *MyPC*, is powered on and is configured via a DHCP reply as below:

- ▶ The IP address for his computer, e.g. 10.0.0.2
- ▶ The local domain name, i.e. *lan*
- ▶ The IP address of the local DNS server, i.e. 10.0.0.138

---

**Result of local DNS resolving** In the example scenario, it is now possible to ping both PCs, *MyPC* and *YourPC*, by referring to their computer names instead of their IP addresses.

---



**Local DNS resolving mechanism**

The mechanism as follows:

Phase	Description
1	Apply a <code>ping YourPC</code> on <i>MyPC</i> .
2	Via this command, <i>MyPC</i> launches a DNS request, basically asking: “What is the IP address of <i>YourPC.lan</i> ?”
3	As the <b>STPro</b> is the DNS server, it will respond with the appropriate IP address, being 10.0.0.1.
4	The ping utility in <i>MyPC</i> will now submit the ping to 10.0.0.1 which may eventually reply.

**Non-local DNS resolving**

The **STPro** resolves names within the local domain, i.e. *lan* (default **STPro** setting) as described above.

However, all other domain names, e.g. *alcatel.com*, cannot be resolved by the **STPro**, and are forwarded over the appropriate link on the DSL line.

## 13.2 Configuring the Speed Touch DNS Server

**In this subsection** The example of section 13.1, refers to a new LAN, using the default **STPro** configuration, thus as well as Auto DHCP server, as DNS server.  
 In case the **STPro** is added to a existing LAN, configuration of the **STPro** DNS server might be necessary to meet the existing LAN conditions.

**The 'DNS' page** Click **DNS** in the left pane of the **STPro** pages to pop up the 'DNS' page (See section 17.2 for more information):

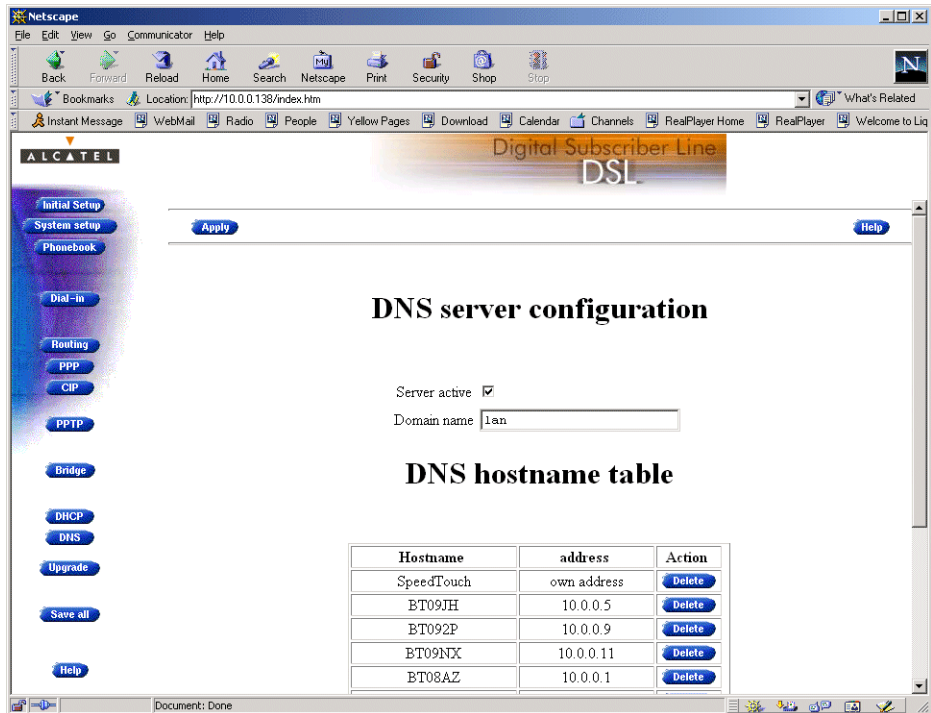

**DNS server field** This field allows configuration of the **STPro** DNS server:

Server active

Domain name

### DNS server field components

Field	Description	Default
Server active	Enables (✓) or disables the <b>STPro</b> DNS server.	✓, <b>STPro</b> DNS server active.
Domain Name	Specifies the domain name of your LAN.	lan

**DNS hostname table** This table shows the DNS hostnames of all current DNS clients and allows to add leases manually:

Hostname	address	Action
SpeedTouch	own address	<a href="#">Delete</a>
Use input fields below to add a new entry		
<input type="text"/>	<input type="text"/>	<a href="#">Add</a>

### DNS hostname table components

Field	Description
Hostname	The DNS hostname of the device.
Address	The IP address to which the DNS hostname is assigned.

### Configuring the DNS server

Check the 'Server active' checkbox to enable the **STPro** DNS server.

In the 'Domain name' field you can enter the domain name of your LAN. You may use a DNS subdomain name, e.g. *dsl.office.lan*.

This name is communicated by the DNS server to the local PCs, and is subsequently used by the PCs to complete a DNS request.

---

### Adding leases manually

You can add leases manually in case the devices need reserved DNS hostnames, e.g. for devices which do not support DNS.

Proceed as follows:

1. Enter the following information in the 'DNS hostname' table:
    - The DNS hostname for the device
    - The IP address of the device.
  2. Click **Add** and **Save all** to finish the procedure.
-

---

# Alcatel Speed Touch™ Pro

## Maintenance

---



## 14 Maintenance – Speed Touch Software

- Software Upgrade** The **STPro** supports two software upgrade possibilities:
- ▶ A new version of the software can be downloaded via the DSL line to your **STPro**
  - ▶ You can upload new **STPro** software yourself from a PC on your local LAN.

Both features, presented in this chapter, are simultaneously supported. However the final result depends on the SP's policy.

### In this chapter

Topic	See
Software Upload from the local LAN	14.1
Software Download from the DSL WAN.	14.2

# 14.1 Software Upload from the local LAN

**Introduction** Alcatel DSL products continue to evolve. By upgrading software, the **STPro** is able to follow this evolution.

- In this section**
- ▶ The 'Upgrade' Page
  - ▶ 'Upgrade' Page Components
  - ▶ 'Upgrade' Page Buttons
  - ▶ Upgrade Preconditions
  - ▶ Uploading Software
  - ▶ Activating Software.

**The 'Upgrade' page** Click  in the left pane of the **STPro** pages to pop up the 'Upgrade' page (See section 17.2 for more information):

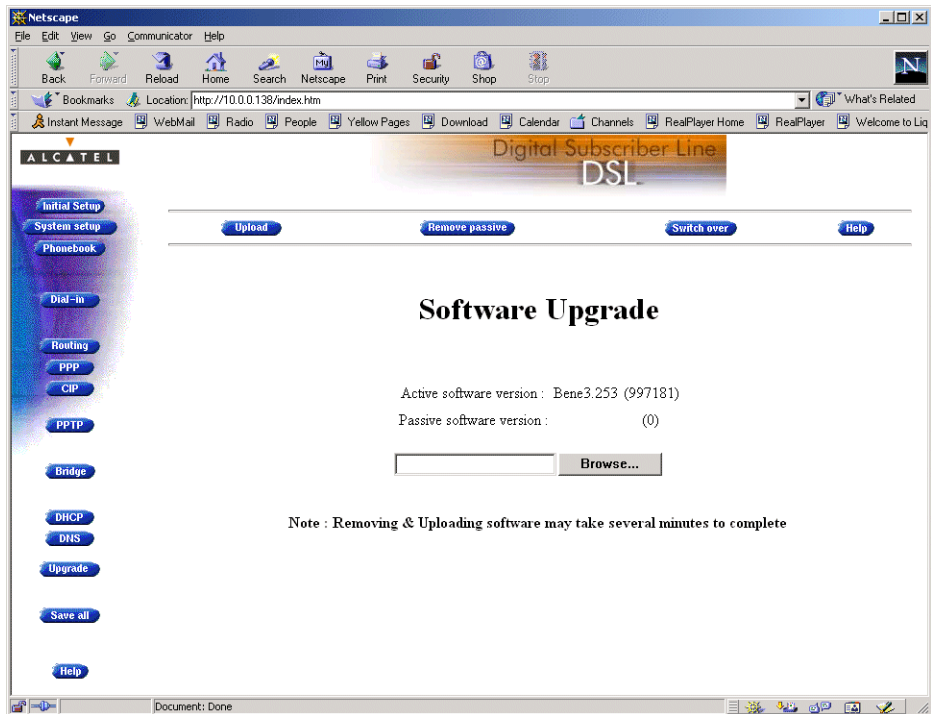



**'Upgrade' page components**

The following fields are shown:

▶ *'Active software version'*

Indicates the software version the **STPro** is currently using.

▶ *'Passive software version'*

Indicates the software version resident in the **STPro**, but not used. This could be a newer version which is yet to be switched to active, but also a dormant older version.



▶ *Software path* field

Allows you to specify the path to the **STPro** upgrade software package to be uploaded.

Clicking  allows you to browse to the location of the upgrade software.

**'Upgrade' page buttons**

The following buttons are available:

Button	Functionality
	To start the upload process. The software package indicated by the <i>Software path</i> will be transferred to the <b>STPro</b> to become the passive software version.
	To remove the passive software version from the <b>STPro</b> memory.
	To switch active and passive software versions after a successful upload. Your <b>STPro</b> will reboot and come online again with the new version.

**Upgrade Preconditions** A valid **STPro** software package must reside either on a local drive, on a floppy disk or a CD-rom.

For new software upgrade packages, please contact your SP or check the Alcatel web sites at:

<http://www.alcatel.com>

<http://www.alcateldsl.com>

**Uploading software** Proceed as follows:

1. Browse to the 'Upgrade' page.
2. In the 'Active software version' field the software package that is running is labeled.

Check whether the 'Passive software version' field is empty. If not, click **Remove passive**.

3. Click **Browse...** next to the 'Software path' input field to locate the upgrade software package

**Note:** If the path is known you can immediately enter it in the *Software path* input field and skip step in this procedure.

4. The 'File Upload' window pops up:

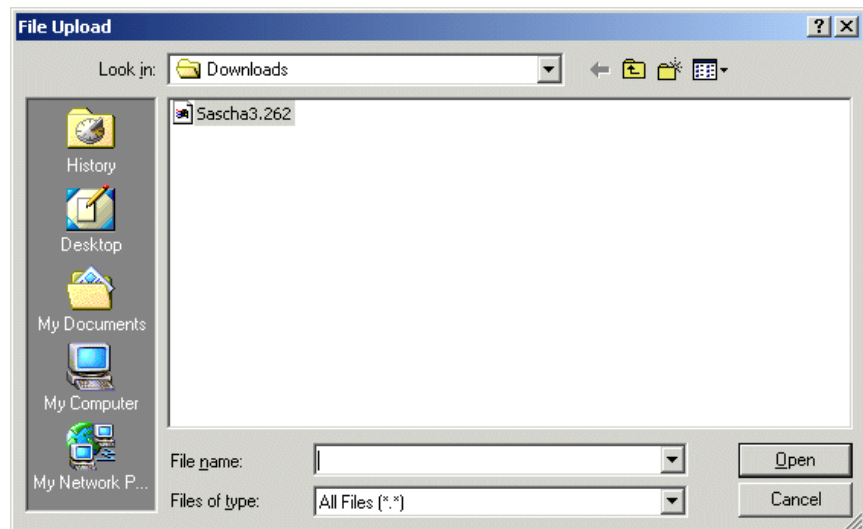

This window allows you to browse to the location of the upgrade software package on either your local drive, floppy, or CD-rom.

- Click on the appropriate upgrade software package name to select it and click  .

As a result, the upgrade software location will be inserted in the 'Software path' input field.

- Click  to start the upload. As a result the upgrade software package name will appear in the 'Passive software version' field:

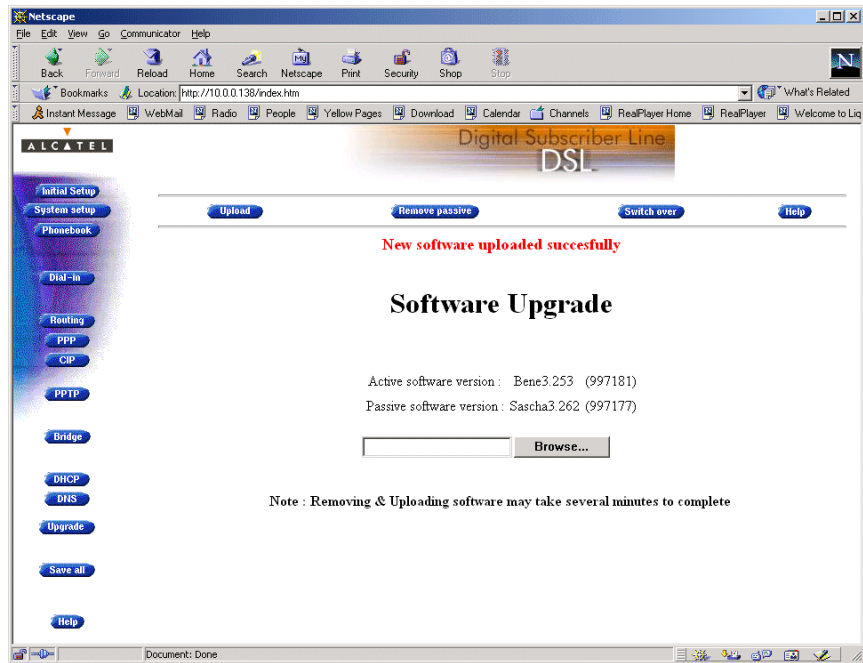

**Note:** In case you did not remove the passive version, prior to uploading new software, the upload will be unsuccessful and an error message will appear.

**Upload Result** After a successful upload, two software versions are stored on the **STPro**: The running (active) version and a passive version.

### Activating software

Proceed as follows to switch passive upgrade and active running software versions:

1. If needed, browse to the 'Upgrade' page.

**Note:** Make sure a passive software version is labeled in the 'Passive software version' field. If not, firstly upload a upgrade software package as described in the previous procedure.

2. Click **Switch over** to start the switching of the two versions.

After switching the versions, the **STPro** reboots:

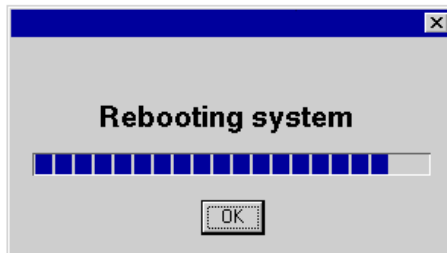

**Result** After reboot your **STPro** will come online with the upgrade version (active and passive software are switched):

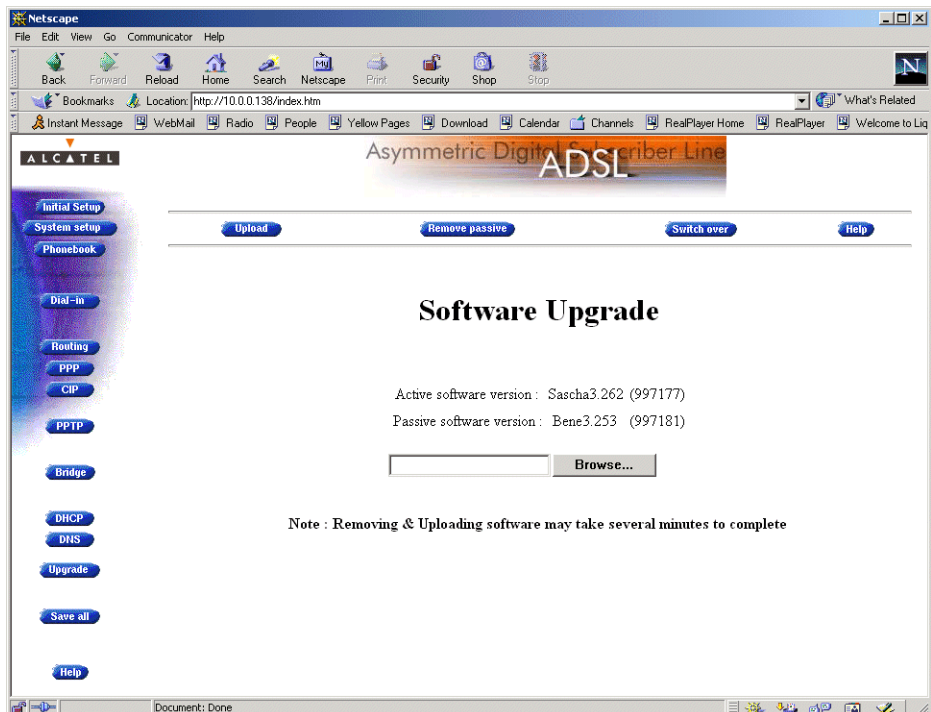

## 14.2 Software Download from the DSL WAN

**Introduction** The **STPro** supports a second software upgrade possibility: a new version of the software can be downloaded from the DSL network to your **STPro**.

This can be done via the **STPro** dedicated control VCs.

**Software Download** This feature is controlled by the SP.

At some point in time he might decide to upgrade the software in your **STPro**. Software download will happen almost unnoticed, while you are connected to the DSL line. The removal of a possible dormant software version, the download itself, and the switching of both versions is performed automatically.

**Note:** DSL service can be interrupted for a short period due to a reboot of the **STPro**.

**Result** You will notice a change in the software version if you browse to the **STPro** 'Upgrade' page:

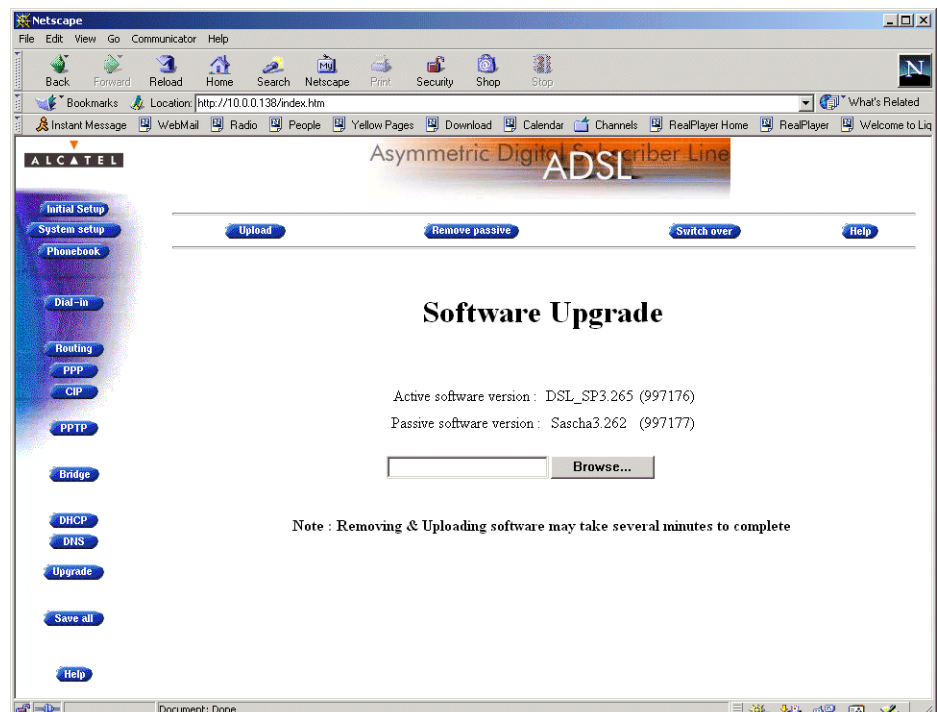



## 15 Maintenance – Speed Touch Password

---

**In this chapter** Your **STPro** is a highly advanced product, operating according to the many configurations set via the **STPro** Web interface or via the CLI.

In this way **STPro** operation is vulnerable to misconfiguration by other users.

Therefore, the **STPro** can be secured from such users by a system password to restrict access to the Web interface, or the CLI.

This chapter describes how to set such a system password.

---

**Note** Never use an obvious system password to protect the **STPro** as your name, birth date, or phone number. Moreover, you are advised to change the system password regularly.

---



### Forgetting the System Password

In case you forgot the system password you are no longer able to access the web interface or the CLI and you will be no longer able to (re)configure the **STPro** settings.

Therefore, write your system password down and keep it on a safe place.

Otherwise, a *Switch-to-Defaults* must be performed restoring all original settings of the **STPro**.

---

### Setting a system password

Proceed as follows:

1. Click **System setup** on the **STPro** pages to pop up the 'System setup' page (See section 17.2 for more information):

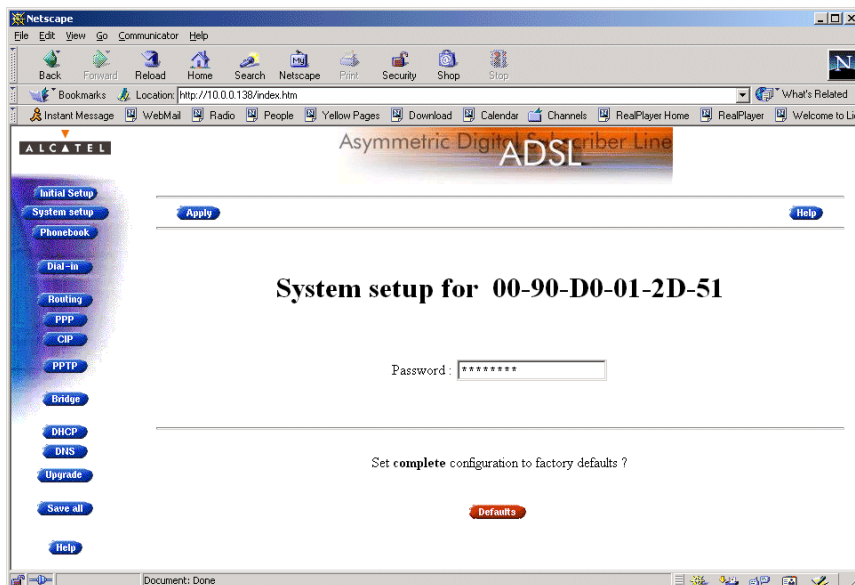

2. In the 'Password' field, fill in a password.  
**Note:** Asterisks will appear instead of the password. The number of asterisks is at random.
3. Click **Apply**.
4. To make your password permanent, click **Save all**.
5. Authenticate yourself, using the system password, you just configured.

**Result** Every time you want to access the **STPro** pages or (Telnet) CLI you must authenticate yourself, using the system password.

### Clearing a system password

To clear the **STPro** system password you must clear the 'Password' field, i.e. delete all asterisks. Click **Apply** and **Save all** to store your changes.

No authentication is required anymore to access the **STPro** pages or the (Telnet) CLI.



---

# 16 Maintenance – Speed Touch To-Defaults

---

**Introduction** Non accessibility to your **STPro** may occur if wrongly configured, simply by forgetting its IP address, or forgetting the system password.

Due to the flexible nature of the **STPro**, you may end up in a situation where restoring all of the original defaults is the only solution.

The **STPro** has tools to cope with these situations.

---

## In this chapter

Topic	See
Ping-of-Life™	16.1
<b>STPro</b> Reset	16.2

---

## 16.1 Ping-of-Life

**Introduction** The **STPro** offers a unique method to supply an IP address to the **STPro**'s Ethernet port.

This method, the *Ping-of-Life*<sup>™</sup>, allows to provide the **STPro** with an IP address without affecting other configurational settings.

**General procedure** The principle is fairly simple: a special ping packet will deliver an IP address to your **STPro**.

Generally the procedure is as follows:

Step	Action
1	Pre-configure the intended IP address and a special MAC group address in the ARP cache of one of your PCs.
2	Power cycle the <b>STPro</b> , and allow the POST to end (this takes about 30 seconds).
3	Ping this same IP address within 60 seconds after the <b>STPro</b> ended its POST.  If everything goes well, the <b>STPro</b> has assimilated this IP address.
4	Save the new IP setting via the <b>STPro</b> pages.

**Note** Most TCP/IP packages support the *ARP* and *PING* command. The *Ping-of-Life* can be executed from any PC on your local network.



### IP Addresses and Subnet Masks

Make sure that the intended **STPro** IP address and your PC share the same IP (sub)network.

If not, the ping will be submitted with the MAC address of the default router instead of the special MAC group address.

### The Ping-of-Life™ procedure

Proceed as follows:

1. Turn off the **STPro**.
2. Open a command-line (DOS) window (Windows OS), or a terminal window (UNIX, Linux) on a PC.
3. At the command prompt execute: **arp -a**  
This allows you to overview the current entries in the ARP cache.
4. Add a static entry to the ARP cache, according to following syntax:  
**arp -s <STPro IP address> 01-90-D0-80-01-01**  
**<STPro IP address>** is a placeholder for the IP address to be assigned to the **STPro**. It can be any address within your subnet as long as it is not used by any other member of your local network.
5. To verify whether this step was successful execute **arp -a** a second time.  
In the entries list, your **arp -s** command entry should be added.
6. Initiate a continuous ping, by executing following command:  
**ping -t <STPro IP address>**
7. Turn on the **STPro**.
8. After the **STPro** finished its POST, it will configure the IP address **<STPro IP address>** you are pinging.
9. You must clear the entry in the ARP cache by issuing the following command:  
**arp -d <STPro IP address>**
10. Verify connectivity by pinging the **STPro** a second time:  
**ping <STPro IP address>**  
The **STPro** should reply.
11. Browse to the **STPro** pages and click  to make the new IP address permanent.

### Ping-of-Life™ with multiple PC-NICs

If your PC is equipped with multiple PC-NICs, make sure that the procedure is applied to the one connected to the **STPro**.

In the following syntax, <Interface IP address> identifies the particular PC-NIC:

```
arp -<a,s,d> <STPro IP address> 01-90-D0-80-01-01 -N
<interface IP address>
```

### Example DOS box

In the following figure all the steps are shown as an example of setting **STPro**'s IP address to 10.0.0.145 from a PC with an MS Windows OS:

```

C:\>arp -a
No ARP Entries Found

C:\>arp -s 10.0.0.145 01-90-d0-80-01-01

C:\>arp -a

Interface: 10.0.0.130 on Interface 0x1000003
Internet Address      Physical Address      Type
10.0.0.145            01-90-d0-80-01-01    static

C:\>ping -t 10.0.0.145

Pinging 10.0.0.145 with 32 bytes of data:

Request timed out.
Request timed out.
Request timed out.
Request timed out.
Request timed out.
Request timed out.
Request timed out.
Reply from 10.0.0.145: bytes=32 time<10ms TTL=255
Reply from 10.0.0.145: bytes=32 time<10ms TTL=255
Reply from 10.0.0.145: bytes=32 time<10ms TTL=255
Reply from 10.0.0.145: bytes=32 time<10ms TTL=255
Reply from 10.0.0.145: bytes=32 time<10ms TTL=255
Reply from 10.0.0.145: bytes=32 time<10ms TTL=255
Reply from 10.0.0.145: bytes=32 time<10ms TTL=255

Ping statistics for 10.0.0.145:
    Packets: Sent = 13, Received = 7, Lost = 6 (46% loss),
    Approximate round trip times in milli-seconds:
        Minimum = 0ms, Maximum = 0ms, Average = 0ms
Control-C
^C
C:\>arp -d 10.0.0.145

C:\>ping 10.0.0.145

Pinging 10.0.0.145 with 32 bytes of data:

Reply from 10.0.0.145: bytes=32 time<10ms TTL=255
Reply from 10.0.0.145: bytes=32 time<10ms TTL=255
Reply from 10.0.0.145: bytes=32 time<10ms TTL=255
Reply from 10.0.0.145: bytes=32 time<10ms TTL=255

Ping statistics for 10.0.0.145:
    Packets: Sent = 4, Received = 4, Lost = 0 (0% loss),
    Approximate round trip times in milli-seconds:
        Minimum = 0ms, Maximum = 0ms, Average = 0ms

C:\>

```

## 16.2 Speed Touch Reset

### Overview of the To-Defaults methods

To restore **STPro**'s original settings, three methods are provided:

- ▶ Two local software methods:
  - *Browse-to-Defaults*  
Which sets all parameters to original defaults, but keeps the system password and IP address.
  - *Ping-to-Defaults*<sup>™</sup>  
Which sets all parameters to original defaults, including the system password and IP address.
- ▶ One hardware method: *Switch-to-Defaults*.



### Restoring Original Settings

Be careful when using the *Browse-to-Defaults*, *Ping-to-Defaults*<sup>™</sup>, or the *Switch-to-Defaults* procedures as these destroy changes you previously made to the **STPro** internal settings.

A reset to defaults via a *Ping-to-Defaults*<sup>™</sup>, or via a *Switch-to-Defaults*, also implies the **STPro**'s IP address is reset to 10.0.0.138.

### In this section

Topic	See
Browse-to-Defaults	16.2.1
Ping-to-Defaults <sup>™</sup>	16.2.2
Switch-to-Defaults	16.2.3

## 16.2.1 Browse-to-Defaults

**Procedure** Proceed as follows:

1. Click **System setup** on the **STPro** pages to pop up the 'System setup' page (See section 17.2 for more information):

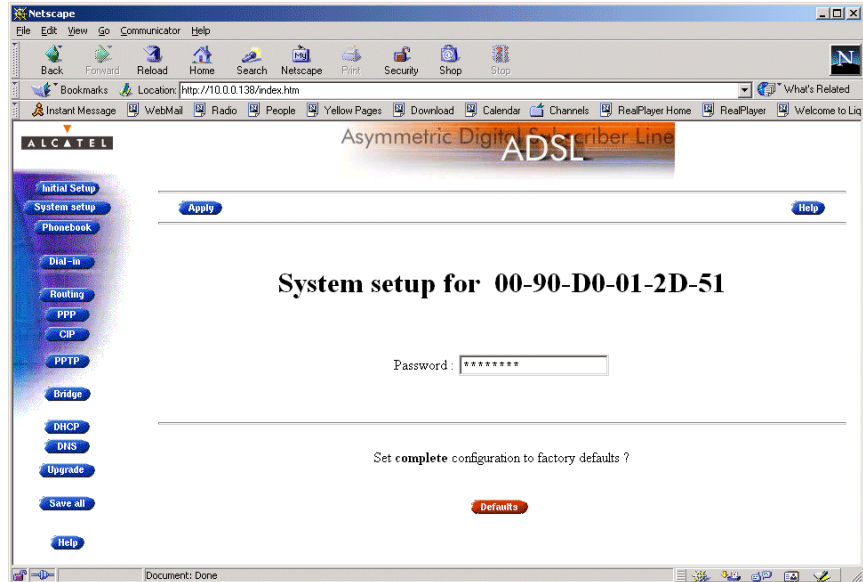

2. Click **Defaults** if you are sure to reset the **STPro** to its original defaults.
3. The **STPro** will ask to confirm the reset:

**Confirm reset to defaults of complete configuration**

OK Cancel

4. Click **OK** if you are sure. Otherwise click **Cancel**.
5. Click **Save all** to make the Browse-to-Defaults permanent.
6. Press the reload button of your Web browser.

### Browse-to-Defaults result

After reset, all original configurations of the **STPro** are restored, except the **STPro** Ethernet IP address(es).

## 16.2.2 Ping-to-Defaults

---

**Introduction** A second software method to reset all settings to the original defaults is the *Ping-to-Defaults™*.  
The technique is identical to that used for the *Ping-of-Life™*, except that another MAC address is used, i.e. **01-90-D0-80-01-FF**.

---

- Procedure** Proceed as follows:
1. Turn off the **STPro**.
  2. Open a command-line (DOS) window (Windows OS), or a terminal window (UNIX, Linux) on a PC.
  3. Add a static entry to the ARP cache, according to following syntax:  

```
arp -s <any IP address> 01-90-D0-80-01-FF
```

<any IP address> can be any address within your subnet as long as it is not used by any other member of your local network.
  4. To verify whether this step was successful execute **arp -a**
  5. Initiate a continuous pinging, by executing following command:  

```
ping -t <any IP address>
```
  6. Turn on the **STPro**.
  7. After the **STPro** finished its POST, it will perform a reset to default settings.
  8. You must clear the entry in the ARP cache by issuing the following command:  

```
arp -d <any IP address>
```
  9. If needed, reconfigure the **STPro** IP address, e.g. via a *Ping-of-Life™*.
- 

**Note** The used <any IP address> to perform a *Ping-to-Defaults™* is not assimilated by your **STPro**. The **STPro** will restart with the original defaults, including the default IP address 10.0.0.38.

---

## 16.2.3 Switch-to-Defaults

**Introduction** At the back of the **STPro** there is a set of DIP switches labeled "Config".

Via these switches a hardware reset of the **STPro**, the *Switch-to-Defaults*, is possible.

**Procedure** Proceed as follows:

1. Make sure your **STPro** is turned on.
2. Put DIP switch number 4 in the UP position:

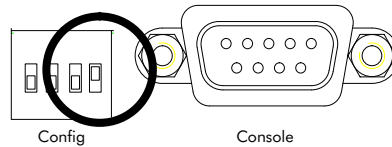

You will notice that the PWR/Alarm LED flashes amber.

3. Power cycle the **STPro** and wait to allow the POST to end. The **STPro** will come online with manufacturing defaults.
4. Reset the DIP switch in its original position. If not, the 'PWR/Alarm' LED will flash amber as a warning.
5. After a reset to original defaults a reconfiguration of **STPro's** IP address might be necessary. This because the reset to defaults also resets your **STPro's** IP address to its default value 10.0.0.138.



### DIP Switch Position

Leaving the DIP switch in the UP position, will cause unintended reset to manufacturing defaults !



# 17 Maintenance – Speed Touch Web Interface

- Introduction** The **STPro** comes with integrated local configuration capabilities. Two methods exist:
- ▶ Configuration via a Web Browser
  - ▶ Configuration through a Command Line Interface (CLI).

**The STPro web interface** The local configuration via the **STPro** web interface, is based on the HyperText Transfer Protocol (HTTP) server/Web browser concept.

It allows configuration of your **STPro** via a Web browser through HyperText Markup Language (HTML) web pages from any local PC attached to the Ethernet interfaces.

## In this chapter

Topic	See
Web Interface Preconditions	17.1
Browsing to the <b>STPro</b> Pages	17.2
<b>STPro</b> Page Structure	17.3

## 17.1 Web Interface Preconditions

---

**Preconditions** When your PC is connected to a Proxy server for accessing the Internet, you must change your Web browser preferences, because the **STPro** is a local device and its IP address cannot be resolved by the Proxy server.

Therefore, prior to access the **STPro** pages make sure that either:

- ▶ Your Web browser is not using a Proxy server
  - ▶ The **STPro** IP address is not submitted to the Proxy server.
- 

**Note** The procedures described are methods for:

- ▶ Netscape Navigator, version 2.0 or above
- ▶ Microsoft Internet Explorer, version 2.2 or above.

---

### In this section

Topic	See
Disabling Proxy Servers	17.1.1
Disabling Proxying for Local IP Addresses	17.1.2

---

## 17.1.1 Disabling Proxy Servers

---

**Introduction** This subsection describes how to disable Proxy servers for your Web browser.

As a consequence of this action, connectivity through the Proxy server to the Internet is lost.

Therefore, after configuring your **STPro**, do not forget to reset your Web browser to its original settings !

---

- Disabling Proxy servers for Netscape Navigator**
1. Select '*Edit*' from the toolbar.
  2. Select '*Preferences*'.
  3. In the '*Category*' box select *Advanced, Proxies*.
  4. Click the option button '*Direct Connection to the Internet*'.
- 

- Disabling Proxy servers for Internet Explorer**
1. Right-click the '*Internet*' icon.
  2. From the pop-up menu select '*Properties*'.
  3. Clear the '*Use Proxy Server*' check box.
- 

**Web browser versions** Since several versions of these Web browsers exist, the proxy settings might be located in other menus than the ones described above. Consult the documentation of your Web browser for more information on proxy settings.

---

## 17.1.2 Disabling Proxying for Local IP Addresses

---

**Introduction** This subsection describes how to avoid that IP addresses, you can connect to directly, as for the **STPro**, are passed over to the Proxy server.

However, this option can only be used if the Proxy servers are known by name and port, and manually configured, i.e. not automatically configured.

---

### Disabling Proxying for Netscape Navigator

1. Select 'Edit' from the toolbar.
  2. Select 'Preferences'.
  3. In the 'Category' box select *Advanced, Proxies*.
  4. Under 'Manual Proxies', click the view button.
  5. In the *Exceptions* box, add the IP address of your **STPro**, or the IP subnetwork address pool.
- 

### Disabling Proxying for Internet Explorer

1. Select 'Tools' from the toolbar.
  2. From the pop-up menu select 'Internet Options'.
  3. In the 'Internet Options' window, select the 'Connections' tab.
  4. Click the 'LAN Settings...' button.
  5. In the 'Proxy Server' box, check the 'Bypass Proxy servers for local addresses' box, and click 'Advanced'.
  6. In the 'Exceptions' settings, add the **STPro** IP address.
- 

### Web browser versions

Since several versions of these Web browsers exist, the proxy settings might be located in other menus than the ones described above. Consult the documentation of your Web browser for more information on proxy settings.

---

## 17.2 Browsing to the Speed Touch Pages

- Procedure** Proceed as follows:
1. Start the Web browser on your PC or workstation.
  2. Contact the **STPro** by entering one of the following:
    - The **STPro** IP address (default 10.0.0.138)
    - The **STPro** DNS hostname (default SpeedTouch.lan)
  3. If a system password was set (See chapter 15 for more information), an authentication window will pop up.  
Enter the system password in the 'Password' field.

**Result** As a result the 'Welcome to the World of DSL' web page pops up:

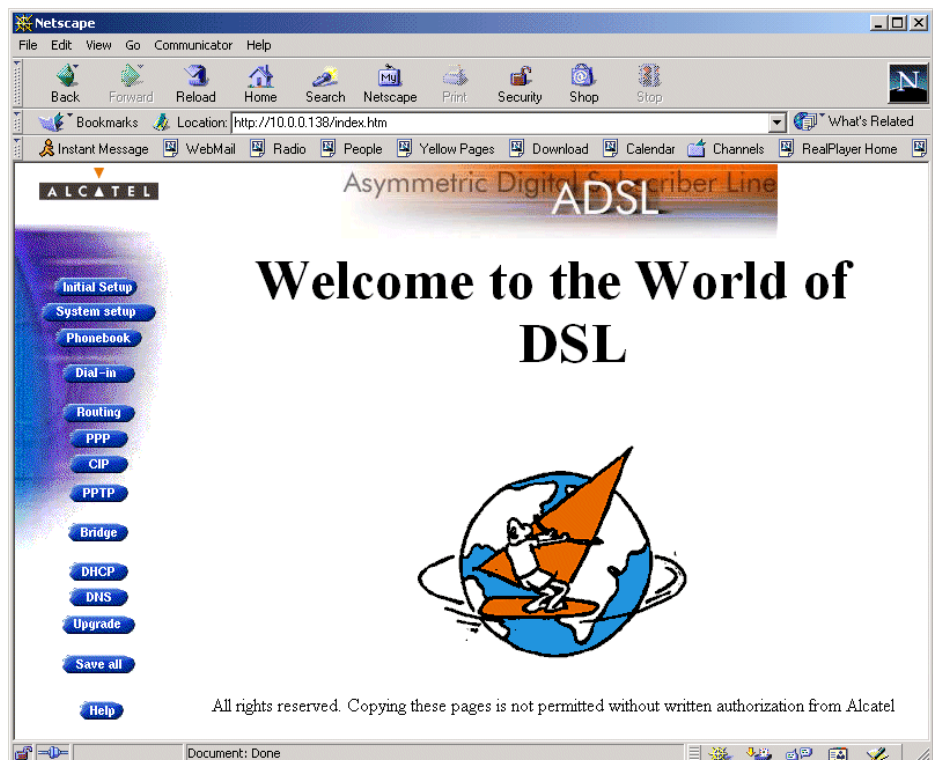

From now on the **STPro** acts as a Web server sending HTML pages/forms at your request. You can fill out these pages/forms and submit them to the **STPro**. The latter scans the pages and makes configurations accordingly.

## 17.3 Speed Touch Page Structure

**STPro page frames** All **STPro** pages can be divided into two sections:

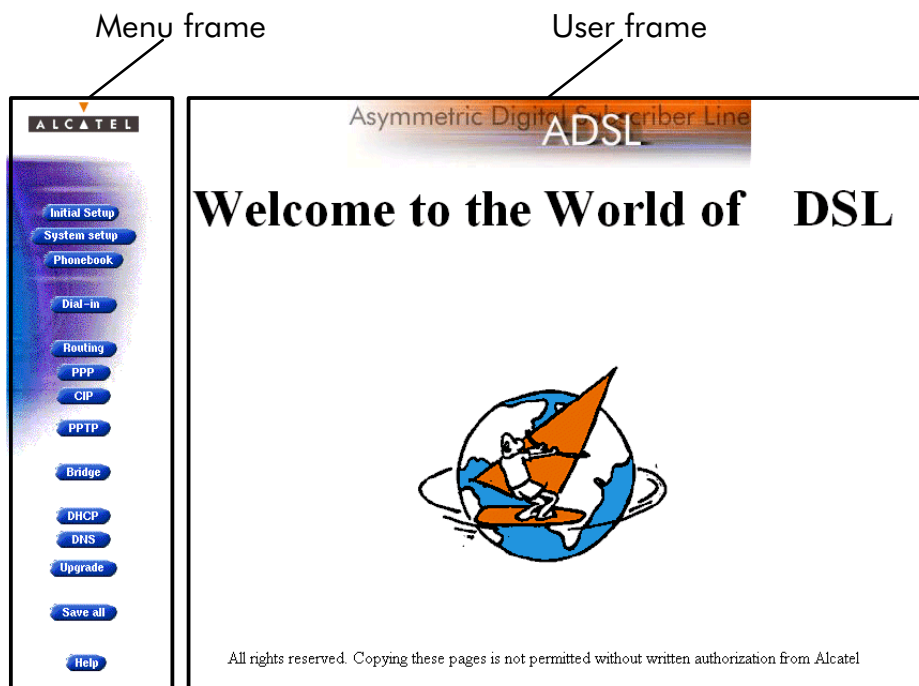

Each web page contains:













- ▶ The generic *Menu frame*
- ▶ The context related *User frame*.

**Menu frame components**

The Menu frame is generic for all **STPro**'s pages.

Each menu button represents a **STPro** configuration page, yielding all configurational possibilities related to menu subject.

The following buttons are available:

Click this button ...	To ...	See
	Return to the 'Welcome to the World of DSL' page.	17.2
	Configure user defined <b>STPro</b> IP parameters.	12.3.2
	Set a System password Perform a <i>Browse-to-Defaults</i> .	15 16.2.1
	Overview the record of all possible, and existing ATM connections.	11.3
	Dial-in page for PPP & IP Routing session.	9.2
	Configure the <b>STPro</b> IP router.	12.5
	Configure the PPP packet service.	9.3
	Configure the CIP packet service.	10.4
	Configure the PPTP packet service.	8.4
	Configure the Bridging packet service. View Bridging MAC layer data.	6.3 6.4
	Configure the <b>STPro</b> DHCP server/client.	12.4
	Configure the <b>STPro</b> DNS server/client.	13
	Upgrade <b>STPro</b> software.	14
	Save all changes made to persistent memory.	
	Pop up the <b>STPro</b> online help pages.	





---

## 18 Maintenance – Speed Touch CLI

---

**Introduction** For advanced configurations, with full control over all the **STPro** functions, the **STPro** exhibits a character based interface, i.e. the Command Line Interface (CLI).

As the CLI has far more configurational possibilities than the regular **STPro** pages, it is intended for experienced users only.

The CLI is accessible via:

- ▶ A Telnet session via Ethernet IP connectivity
- ▶ The serial 'Console' port.

---

### In this chapter

Topic	See
Native CLI Access	18.1

---

## 18.1 Native CLI Access

---

**Introduction** You can use native access via the serial port or via a basic Telnet session.

This allows configuration via a character based CLI. As a consequence the use of a web browser or even any graphical or operational environment is avoided.

---

**In this chapter**

Topic	See
CLI through a Telnet Session	18.1.1
CLI via Serial Access	18.1.2
CLI Commands Basics	18.1.3

---

---

## 18.1.1 CLI through a Telnet Session

---

**Introduction** Via a PC or terminal connected to the Ethernet interface of the **STPro** you can execute CLI commands.  
However, you must gain access to the **STPro** first, by opening a TCP/IP Telnet session.

---

- In this section**
- ▶ Telnet Features
  - ▶ Telnet Requirements
  - ▶ Using a Telnet Session to your **STPro**.
- 

**Telnet features** Telnet is:

- ▶ A fairly general, bi-directional, eight-bit byte-oriented communication facility
- ▶ A standard method of interfacing terminal devices to each other.

---

**Telnet requirements** Prior to using Telnet, you need:

- ▶ A connected, and configured **STPro** with known IP address or DNS hostname
- ▶ If applicable, the system password for accessing the **STPro**
- ▶ A PC or terminal connected to the LAN

**Note:** LAN is referred to as a network containing at least one PC or terminal, and your **STPro**.

- ▶ A TCP/IP suite installed on this PC or terminal
- ▶ A Telnet session application installed on this PC or terminal.

---



---

## 18.1.2 CLI via Serial Access

### Advantages of the CLI via serial access

The CLI via serial access:

- ▶ Provides CLI command connectivity to the **STPro**, without the need of a TCP/IP configuration
- ▶ Allows remote **STPro** configuration via an intermediate POTS modem or ISDN modem/router.

### Serial access requirements

For serial access, you need:

- ▶ A serial cable.
- ▶ An ASCII terminal (VT100) or a PC with ASCII terminal emulation, for local configuration

or

- ▶ A POTS or ISDN modem/router for remote configuration.

### Serial connection settings

Setup the serial interface of your ASCII terminal, or PC for:

- ▶ 9600 BAUD
- ▶ 8 databits
- ▶ no parity, 1 stopbit.

### Accessing the CLI

As soon the connection is made, your terminal is ready for the CLI.

Just press 'Enter' to pop up the CLI command prompt : =>

---

## 18.1.3 CLI Command Basics

---

**Introduction** Although it is not the aim of this subsection to give a complete overview of all possible configurational **STPro** items, this subsection describes some of the generalities of the native CLI environment.

---

**General CLI information** Once you accessed your **STPro** you will get the CLI prompt: `=>`. From this point you can start entering your commands. The CLI access is structured in what is called “levels”. The `=>` prompt indicates that you are in the “root” level of the CLI.

---

**CLI help** Typing **help** at the root prompt shows you the available command groups:

```
=>help
Following command groups are available :
config      system      software    ip           phonebook
nat         cip         ppp         pptp        bridge
atmf       td          dns         dhcp
=>
```

---

**Navigating through CLI levels** Entering the name of a command group, accesses you to this specific level. For example, entering `=>config` followed by pressing ‘Enter’, brings you to the “config” level. This is indicated by its own prompt: `[config]=>`

---

---

**Command group help** Typing **help** at the command group level prompt shows you the available commands.

For example , entering **help** at the “config” level generates the following output:

```
[config]=>help
Following command groups are available :
save   : Saves complete configuration.
erase  : Removes all saved data.
load   : Loads saved or factory default configuration.
flush  : Flushes complete configuration.
reset  : Flush & restore factory default configuration.
[config]=>
```

---

**Command help** Typing **help** followed by a command generates shows you a description of the command, and a parameter syntax, if applicable:

For example , entering **help reset** in the “config” level generates the following output:

```
[config]=>help reset
  [keep_ip = <{no|yes}>]
    Reset IP settings or not.  Resetting IP can break
    current telnet/http session !
[config]=>
```

---

**Command execution** Typing the command executes the command. In most cases you must also provide related parameters.

The consequences of a command execution have immediate effect. However, only after executing the **save** command, the new settings are stored in persistent memory.

---

**CLI Reference Guide** A CLI Reference Guide with detailed CLI configuration description of all the commands can be found at:

*<http://www.alcatel.com>*

*<http://www.alcateldsl.com>*

---





---

# Alcatel Speed Touch™ Pro

## Appendices

---



## Abbreviations

ACCOMP	Address and Control field COMPression
ADSL	Asymmetric Digital Subscriber Line
ASAM	ATM Subscriber Access Multiplexer
ATM	Asynchronous Transfer Mode
ATMF-25.6	ATM Forum - 25.6 Mbps
BBRAS	BroadBand RAS
CHAP	Challenge Handshake Authentication Protocol
CIP	Classical IP
CLI	Command Line Interface
DHCP	Dynamic Host Configuration Protocol
DNS	Domain Name System
DSLAM	Digital Subscriber Line Access Multiplexer
DTE	Data Terminal Equipment
FIB	Forwarding Information Base
FTP	File Transfer Protocol
GUI	Graphical User Interface
HTML	HyperText Markup Language
HTTP	HyperText Transfer Protocol
ICMP	Internet Control Message Protocol
IP	Internet Protocol
IRC	Internet Relay Chat
ISDN	Integrated Services Digital Network
ISP	Internet Service Provider
ITU	International Telecommunication Union
LAN	Local Area Network
LCP	Link Control Protocol
LIS	Logical IP Subnet
MAC	Medium Access Control
NA(P)T	Network Address and Port Translation
NAT	Network Address Translation
NIC	Network Interface Card

OS	Operating System
OSI	Open Systems Interconnection
PAP	Password Authentication Protocol
PAT	Port Address Translation
PC	Personal Computer
POST	Power On Self Test
POTS	Plain Old Telephone Service
PPP	Point-to-Point Protocol
PPPoA	PPP over ATM
PPPoE	PPP over Ethernet
PPTP	Point-to-Point Tunnelling Protocol
PVC	Permanent Virtual Channel
RAS	Remote Access Server
REN	Ringer Equivalence Number
ROW	Rest Of the World
RTSP	Real Time Stream Protocol
SELV	Safety Electronic Low Voltage
SP	Service Provider
SVC	Switched Virtual Channel
TCP	Transmission Control Protocol
TNV	Telecommunication Network Voltage
UDP	User Datagram Protocol
URL	Uniform Resource Locator
VC	Virtual Channel
VCI	Virtual Channel Identifier
VP	Virtual Path
VPI	Virtual Path Identifier
VPN	Virtual Private Network

## AppendixA Speed Touch Troubleshooting

---

**Introduction** This appendix provides information on how to identify and correct some common problems you may encounter when using and configuring the **STPro**.

If the following troubleshooting tips have not resolved the problem, contact the company from which you purchased the **STPro** for assistance.

---

**Configuration problems** In case you encounter DSL connectivity problems due to misconfiguration, you might consider a reset to original defaults as described in chapter 16. However, be aware that a reset to original defaults destroys all configurational changes you made to the **STPro** internal settings.

---

**Trouble solving table** The following table provides possible solutions to some problems:

<b>Problem</b>	<b>Solution</b>
<i>STPro does not work. (none off the LEDs lights up)</i>	Make sure the <b>STPro</b> is plugged into an electrical outlet.
	Make sure the power switch on the <b>STPro</b> modem is turned on.
<i>No ATMF-25.6 connectivity.</i>	Make sure the (correct) cable is securely connected to the ATMF-25.6 port.
<i>No Ethernet connectivity. LAN LED does not light up. Ethernet port(s) link integrity LED does not light up.</i>	Make sure the cable(s) are securely connected to the 10Base-T port(s).
	Make sure you are using the correct cable type for your Ethernet equipment.
<i>Telnet session from a Windows PC is not possible.</i>	The <b>STPro</b> system password is longer than 8 characters. Change the <b>STPro</b> system password.
<i>Poor STPro performance.</i>	Make sure the <b>STPro</b> is installed as instructed in this User's Guide and/or as instructed by the SP.
	For ADSL service, check whether a central splitter or dedicated filters are installed properly.
<i>No Line synchronization achieved. Line Sync LED keeps flashing</i>	Make sure ADSL service is enabled on the wall outlet your <b>STPro</b> is connecting to.
	Make sure an ADSL <b>STPro</b> variant is used for your ADSL service.

## AppendixB Speed Touch Specifications

### In this appendix

Topic	See
Front Panel Layout and LED Description	B.1
Power On/Off Behavior	B.2
Back Panel Layout and LED Description	B.3
Connector Pin Assignments	B.4
Power Supply Adapter	B.5
LAN Cables Layout	B.6
Physical Specifications	B.7
ADSL Specifications	B.8

## B.1 Front Panel Layout and LED Description

**Front panel layout** All **STPro** models have a similar front panel:

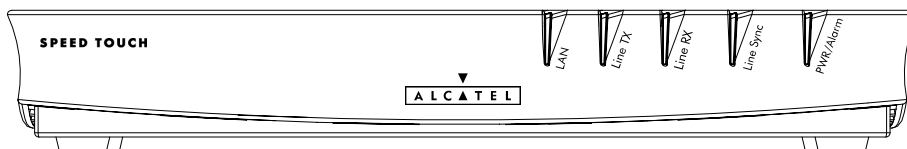

**Five front panel LEDs** The **STPro** is equipped with 5 LEDs on its front panel, indicating the state of the device:

Indicator			Description
Name	Color	State	
LAN	Green	Flashing	Data is flowing from/to the Ethernet port(s).
		Off	No activity on the Ethernet port(s).
Line TX	Green	Flashing	ATM cells are being sent over the DSL line.
		Off	No transmission activity.
Line RX	Green	Flashing	ATM cells are being received via the DSL line.
		Off	No reception activity.
Line Sync	Green	Flashing	During initialization of the DSL line.
		On	DSL line synchronization achieved.
PWR/Alarm	Green	On	Power on, normal operation.
	Amber	On	Power on, start-up failed.
	Red	Flashing	Power on, POST(*) pending.
	Red	On	Power on, POST(*) failed.

(\*) Power On Self Test (POST)



## B.2 Power On/Off Behavior

**Turning on/off the STPro** You can turn the **STPro** on (I) or off (O) with the power switch.

**POST phases** As soon your **STPro** is turned on, you can check the "PWR/Alarm" LED (See section B.1) to see how the start-up progresses.

Phase	"PWR/Alarm" LED Indication	Description
1	Flashing red	POST(*) pending
2	Solid amber	Start-up failed
	Solid red	POST(*) failed
	Solid green	Normal operation

(\*) Power On Self Test (POST)

**Checking link integrity** If the LAN devices which are directly connected to the **STPro's** Ethernet port(s) are powered on, the link integrity/activity LED of the particular port lights up green (See section B.3).

## B.3 Back Panel Layout

**Back panel differences** The back panel differs depending on the **STPro** model.

### Single port model

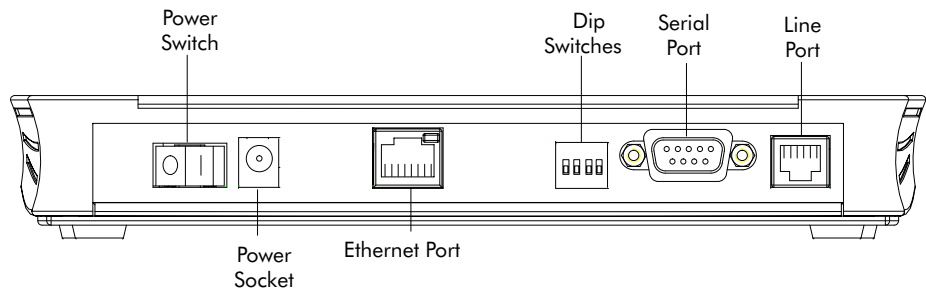

### Dual port model

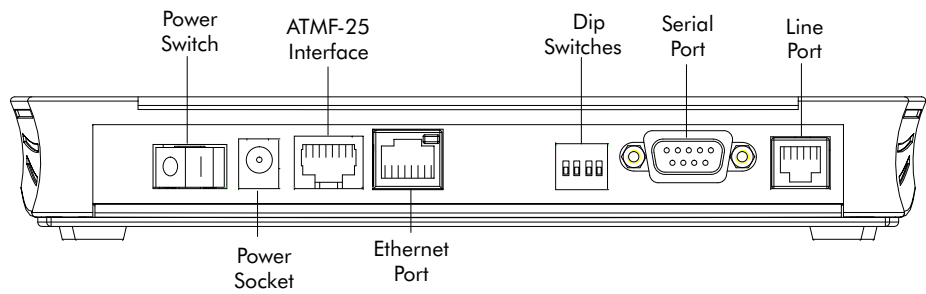

### Hub model

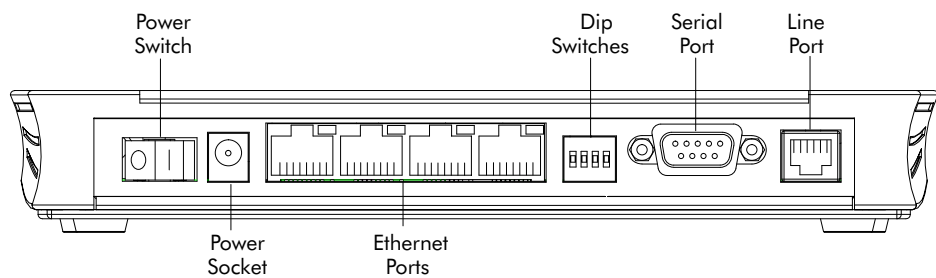

**Ethernet port(s) LED** Each of the Ethernet ports on the back panel has a LED:

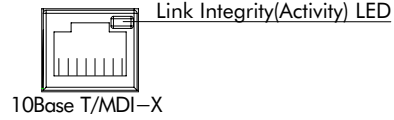

**Indication of link integrity** *For all STPro models :*

Indicator			Description
Name	Color	State	
Integrity	Green	Off	No connection on this port.
		On	Ethernet link up.

**Indication of link activity** *For the hub STPro model only :*

Indicator			Description
Name	Color	State	
Integrity Activity	Green	On	Ethernet link up.
		Flashing	No activity on this Ethernet port. Data is flowing from/to this Ethernet port. (hub only)

## B.4 Connector Pin Assignments

### STPro port description

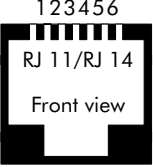
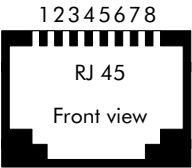
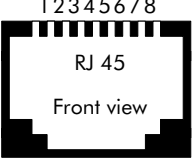
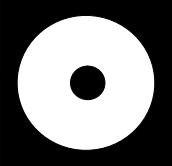
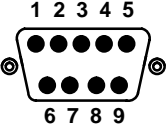
Name	Port	Pin No.	Signal Name	Function	Model Reference
Line (DSL)		2	Wire A	Subscriber line wire A	2/5 ADSL variant
		3	Wire A	Subscriber line wire A	3/4 ADSL variant
		4	Wire B	Subscriber line wire B	
		5	Wire B	Subscriber line wire B	2/5 ADSL variant
ATMF-25		1	R <sub>X+</sub>	Receive data from DTE(*) (+)	
		2	R <sub>X-</sub>	Receive data from DTE(*) (-)	
		7	T <sub>X+</sub>	Transmit data to DTE(*) (+)	
		8	T <sub>X-</sub>	Transmit data to DTE(*) (-)	
10Base-T MDI-X		1	R <sub>X+</sub>	Receive data from DTE(*) (+)	
		2	R <sub>X-</sub>	Receive data from DTE(*) (-)	
		3	T <sub>X+</sub>	Transmit data to DTE(*) (+)	
		6	T <sub>X-</sub>	Transmit data to DTE(*) (-)	
DC		Inner	+9V <sub>DC</sub>	Power supply connection (+)	
		Outer	GND	Power supply connection (ground)	
Console		2	RD [RS232-9]	Received data	
		3	SD [RS232-9]	Transmitted data	
		5	DCD [RS232-9]	Signal common	

(\*) Data Terminal Equipment (DTE)

---

**Free connector pins** Connector pins not mentioned are not connected.

---

**Ports characteristics** The external ports on the back panel are classified as follows:

- ▶ **DC input port**  
SELV circuit (\*)
- ▶ **10Base-T/MDI-X**  
SELV circuit
- ▶ **Console RS232 port**  
SELV circuit
- ▶ **Line DSL port**  
TNV-3 circuit (\*\*)

(\*) Safety Electronic Low Voltage (SELV)

(\*\*) Telecommunication Network Voltage (TNV) Category 3

---

## B.5 Power Supply Adapter

**Power adapter use** The **STPro** is equipped with one of the following pluggable power supply adapters listed in the table.

Due to the special characteristics of the output class II AC adaptor, use only the **AULT, Incorporated** types, or equivalents, listed in the table.

### Power adapter models

Model Reference	AC/DC	Plugtype	AULT, Inc. Model (or equivalent)
US model	120V/9V	North America wall plug	P48-091000-Axxxx
UK/Sing model	230V/9V	UK wall plug	F48-091000-Axxxx
ROW(*) model	230V/9V	Euro wall plug	D48-091000-Axxxx
Australia model	240V/9V	Australia wall plug	E48-091000-Axxxx
Korea Model	220V/9V	Korea wall plug	Q48-091000-Axxxx

(\*) Rest Of the World (ROW)

**Output specifications** The supplied adapter has the following output specifications:

- ▶ 9V<sub>DC</sub>/1A unregulated output voltage
- ▶ Maximum 860 mV<sub>eff</sub> ripple voltage
- ▶ Maximum 1A output current
- ▶ Limited power source (according to IEC/EN 60950, sub-clause 2.11 and UL1950).

**Note:** Do not use power adapter types with other specifications (e.g. from other Alcatel Speed Touch™ products) !

## B.6 LAN Cables Layout

### **Straight-through LAN cable**

Straight-through LAN cables with the following layout are applicable for interconnecting Ethernet ports, and ATMF-25.6 ports:

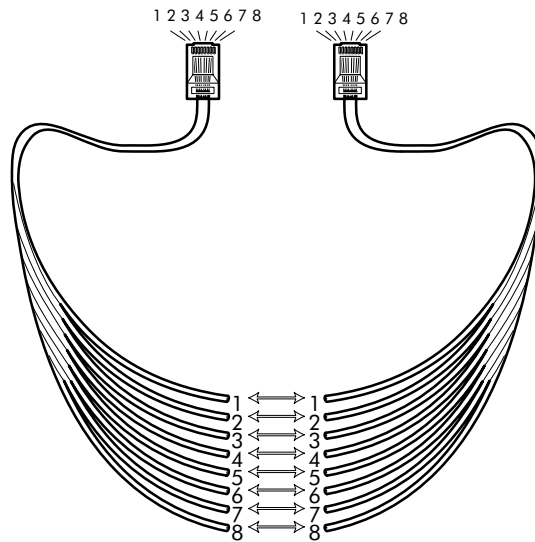

### **Crossover LAN cable**

Crossover LAN cables with the following layout are applicable for interconnecting Ethernet ports, and ATMF-25.6 ports:

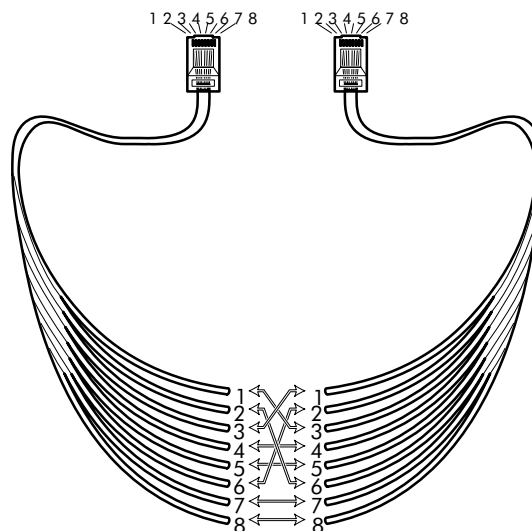

## B.7 Physical Specifications

---

**Physical dimensions** 210mm W x 185mm D x 35mm H

---

**Operating environment** Temperature: 5°C to 40°C (40F to 105F)  
Humidity: 20% to 80%

---

**Power requirements** AC voltage: 100 to 120 V<sub>AC</sub>, 220 to 240 V<sub>AC</sub>  
DC voltage: 9V/1A  
Frequency: 50/60 Hz  
Power consumption: 7W<sub>max</sub>

---



## B.8 ADSL Specifications

### ADSL router specifications

- ▶ **ADSL data rates**
  - Downstream user (payload) data rates:  
Up to 8Mbit/s, depending on provisioning
  - Upstream user (payload) data rates:  
Up to 1Mbit/s, depending on provisioning
- ▶ **ADSL/POTS standards compliance**
  - Full rate ANSI T1.413 Issue 2
  - ITU(\*) G.DMT (Full rate ITU G.992.1 Annex A)
  - ITU G.Lite (Lite rate ITU G.992.2)
  - ITU G.Handshake (Automode ITU G.994.1)
- ▶ **ADSL/ISDN (ETSI) standards compliance**
  - ETSI TS 101 388
  - ITU G.Handshake (Automode ITU G.994.1)
- ▶ **ADSL/ISDN (ETSI/ITU) standards compliance**
  - ETSI TS 101 388
  - ITU G.DMT (Full rate ITU G.992.1 Annex B)
  - ITU G.Handshake (Automode ITU G.994.1)

(\*) International Telecommunication Union (ITU)



# AppendixC Speed Touch Default Assignments

---

## In this chapter

Topic	See
General Defaults	C.1
Connection Service/ATM Encapsulation Defaults	C.2

---

## C.1 General Defaults

<b>STPro IP address</b>	10.0.0.138
<b>STPro DNS name</b>	SpeedTouch
<b>STPro domain name</b>	lan
<b>STPro DNS server</b>	Active
<b>STPro DHCP server</b>	AutoDHCP
<b>STPro master firewall</b>	Enabled
<b>STPro system password</b>	Not set

## C.2 Connection Service/ATM Encapsulation Defaults

### ATMF-25.6 port (optional)

VPI	VCI	Upper Layer Protocols	Service channel
0 ...7	0 ...511	ADSL/ATMF-25.6 X-connect	End-User defined

### Ethernet port(s)

VPI	VCI	Upper Layer Protocols	Service channel
0/8	35	<b>Bridge</b> AAL5/RFC1483/Bridged RFC1483 LLC/SNAP for Bridged PDUs (FCS not preserved)	Transparent Bridging Bridged PPPoE
0/8	36		
0/8	37		
0/8	38		
0/8	48	<b>PPTP</b> AAL5/RFC2364 RFC2364 VC-MUX for PPP PDUs	PPPoA-to-PPTP Relaying
0/8	49		
0/8	50		
0/8	51		
0/8	64	<b>PPP</b> AAL5/RFC2364 RFC2364 VC-MUX for PPP PDUs	PPP & IP Routing
0/8	65		
0/8	66		
0/8	67		
0/8	80	<b>CIP</b> AAL5/RFC1483/Routed RFC1577–RFC1483 LLC/SNAP for Routed non-ISO PDUs	CIP & IP routing
0/8	81		
0/8	82		
0/8	83		

**Note:** Default VP = 0 values will never be applicable to the **STPro** dual port model.

**Control channels**

---

VPI	VCI	Upper Layer Protocols	Service channel
0	21	-	DSL/ATM Loopback channel
1	21		
15	16	AAL5/SNMP	SNMP/ASAM agent communication channel for Alcatel ASAM
15	64	AAL5/TFTP	Software TFTP download channel

---

## AppendixD Safety and Agency Regulatory Notices

**Aim of this appendix** This appendix provides basic Safety Information on Alcatel's **Speed Touch™** product.  
Prior to using the **Speed Touch™** product, read this appendix carefully.

**Reading all instructions** Follow all warnings and instructions marked on the product.

**In this appendix** This chapter covers the following topics:

Topic	See
Safety Instructions	D.1
European Declaration of Conformity	D.2
Radio Frequency Interference Statement	D.3
Canadian Class B Notice	D.4



**STORE THESE INSTRUCTIONS CAREFULLY**



---

**Directive** Unless expressly and unambiguously approved by Alcatel, you may not:

- ▶ disassemble, de-compile, reverse engineer, trace or otherwise analyse the equipment, its content, operation, or functionality, or otherwise attempt to derive source code (or the underlying ideas, algorithms, structure or organization) from the equipment or from any other information provided by Alcatel, except to the extent that this restriction is expressly prohibited by local law;
- ▶ copy, rent, loan, re-sell, sublicense, or otherwise transfer or distribute the equipment to others;
- ▶ modify, adapt or create a derivative work of the equipment;
- ▶ remove from any copies of the equipment any product identification, copyright or other notices;
- ▶ disseminate performance information or analysis (including, without limitation, benchmarks) from any source relating to the equipment.

Such acts not expressly approved by Alcatel will result in the loss of product warranty and will invalidate the user's authority to operate this equipment.

---



## D.1 Safety Instructions

- 
- Climatic conditions** The **Speed Touch**<sup>™</sup> product equipment is intended for:
- ▶ In-house stationary desktop use; the maximum ambient temperature may not exceed 40°C (104°F).
  - ▶ It must not be mounted in a location exposed to direct or excessive solar and/or heat radiation.
  - ▶ It must not be exposed to heat trap conditions and must not be subjected to water or condensation.
  - ▶ It must be installed in a Pollution Degree 2 environment.
- 

**Cleaning** Unplug this product from the wall outlet before cleaning. Do not use liquid cleaners or aerosol cleaners. Use a damp cloth for cleaning.

---

**Water and moisture** Do not use this product near water, for example, near a bathtub, wash bowl, kitchen sink, laundry tub, in a wet basement or near a swimming pool.

---

**Power supply adapter** The **Speed Touch**<sup>™</sup> product comes with a portable power supply adapter.

Due to the special characteristics of the output of the class II AC adaptor, only use the models or equivalent listed in the power adapter table in this User's Guide.

---

**Power sources** The powering of this product must adhere to the power specifications indicated on the marking labels. If you are unsure of the type of power supply to your home, consult your product dealer or local power company.

The mains socket outlet must be close to the equipment and easily accessible.

The **Speed Touch**<sup>™</sup> product equipment is not intended to be connected to an IT-type power system.

---

---

**Power cord protection** Do not allow anything to rest on the power cord. Do not locate this product where the cord will be subject to persons walking on it.

---

**Overloading** Do not overload wall (mains) outlets and extension cords as this increases the risk of fire or electric shock.

---

**Servicing** To reduce the risk of electric shock, do not disassemble this product. None of its internal parts are user-replaceable; therefore, there is no reason to access the interior. Opening or removing covers may expose you to dangerous voltages. Incorrect reassembly could cause electric shock if the appliance is subsequently used.

If service or repair work is required, take it to a qualified service dealer.

---

**Damage requiring service** Unplug this product from the wall outlet and refer servicing to qualified service personnel under the following conditions:

- ▶ When the power supply cord or plug is damaged or frayed.
  - ▶ If liquid has been spilled into the product.
  - ▶ If the product has been exposed to rain or water.
  - ▶ If the product does not operate normally.
  - ▶ If the product has been dropped or damaged in any way.
  - ▶ If the product exhibits a distinct change in performance.
-

**Modem/Telephone use**

Avoid using a modem/telephone (other than a cordless type) during an electric storm. There is a slight risk of electric shock caused by lightning.

Do not use the telephone to report a gas leak in the vicinity of the leak.

If telephone service is required on the same line, a central splitter, or distributed filter(s) must be installed for optimal DSL performance.

Depending on your DSL configuration and type of splitter/filters, installation must be carried out by qualified service personnel.

Consult your telephone service company or DSL service provider for instructions.

---

**Modifications**

Changes or modifications not expressly approved by Alcatel could invalidate the users authority to operate this equipment.



**STORE THESE INSTRUCTIONS CAREFULLY**



## D.2 European Community Declaration of Conformity



---

Products with the **CE** marking comply with both EMC and Low Voltage Directives issued by the Commission of the European Community.

---

### **EC Declaration of Conformity**

A copy of the European Community Declaration of Conformity is provided in your **Speed Touch™** product shipping box.

---

## D.3 Radio Frequency Interference Statement

This device has been tested and found to comply with the limits for a Class B digital device, pursuant to Part 15 of the FCC Rules. These limits are designed to provide reasonable protection against such interference in a residential installation. This equipment generates, uses and can radiate radio frequency energy. If not installed and used in accordance with the instructions, it may cause harmful interference to radio communications. However, there is no guarantee that interference will not occur in a particular installation. If this equipment does cause harmful interference to radio or television reception, which can be determined by turning the equipment ON and OFF, the user is encouraged to try correct the interference by one or more of the following measures:

- ▶ Reorient or relocate the receiving antenna
- ▶ Increase the separation between the equipment and receiver
- ▶ Connect the equipment into an outlet on a circuit different from that to which the receiver is connected
- ▶ Consult the dealer or an experienced radio/television technician for help.

This equipment complies with Part 68 of the FCC Rules. On the back of this equipment is a label that contains, among other information, the FCC certification number (FCC ID) and Ringer Equivalence Number (REN) for this equipment. If requested, this information must be provided to the telephone company.

An FCC compliant telephone cord and modular plug is provided with this equipment. This equipment is designed to be connected to the telephone network or premises wiring using a compatible modular jack that is Part 68 compliant.

The Ringer Equivalence Number (REN) is used to determine the quantity of devices that may be connected to the telephone line. Excessive RENs on the telephone line may result in the devices not ringing in response to an incoming call. Typically, the sum of RENs should not exceed five (5.0). To be certain of the number of devices that may be connected to a line (as determined by the total RENs) contact the local telephone company.

If this equipment causes harm to the telephone network, the telephone company will notify you in advance that temporary discontinuance of service may be required. But if advance notice is not practical, the telephone company will notify the customer as soon as possible. Also you will be advised of your right to file a complaint with the FCC if you believe it is necessary.

The telephone company may make changes to its facilities, equipment, operations or procedures that could affect the operation of the equipment. If this happens the telephone company will provide advance notice so you can make the necessary modifications to maintain uninterrupted service.

If the equipment is causing harm to the telephone network, the telephone company may request that you disconnect the equipment until the problem is resolved. Connection to party lines is subject to state tariffs (contact the state public utility commission, public service commission or corporation commission for information).

**No repairs can be performed by the customer, if you experience trouble with this equipment for repair or warranty information, please contact: (919) 850-1231 for locations in North America.**

## D.4 Canadian DOC Class B Notice

---

### **Notification of Canadian RF Interference Statements**

This digital apparatus does not exceed the Class B limits for radio noise emissions from digital apparatus as set out in the radio interference regulations of the Canadian Department of Communication.

Le présent appareil numérique n'émet pas de bruits radioélectriques dépassant les limites applicable aux appareils numérique de classe B prescrites dans le règlement sur le brouillage radioélectrique édicté par le Ministère des Communications du Canada.

---