

★ YIE AR KUNG - FU CONVERSION KIT ★
INSTRUCTION MANUAL



Konami Inc.

1555 BRUMMEL AVENUE, ELK GROVE VILLAGE, IL 60007
TELEPHONE: (312) 364-6633 FAX: (312) 364-1368 TELEX: 6871385 KONAM UW

YIE AR KUNG-FU™ and **Konami®** are registered trademarks of Konami Industry Co., Ltd.
© 1985 Konami. All rights reserved.

TABLE OF CONTENTS

	Page
Conversion Kit Contents	Inside Cover
Table of Contents	1
Introduction	2
Game Play	2
Graphics	3
Recommended Control Panel Layouts	4
Monitor Specifications	5
Technical Information	6
Wiring Harness Color Code	7
Wiring Diagram	8
Dip Switch Setting	9
User Information Warning	Back Cover

YIE AR KUNG-FU INTRODUCTION

KONAMI CONVERSION KITS are the most complete conversion kits available today. Every detail has been carefully considered, designed and packaged to provide you the means of easily producing a professional conversion.

This kits has all the accessories to easily convert your UPRIGHT or COCKTAIL video game.

We strongly urge you to FULLY STUDY this instruction manual BEFORE you begin your conversion. It contains step-by-step instructions, schematic diagrams and suggestions on how to install your Konami Conversion Kit and maximize your profits.

YIE AR KUNG FU can be installed in any vertically mounted raster scan monitor game.

Everything you will need to construct your new game is provided in this kit. All accessory parts — wiring harness, joystick, etc. are custom made for YIE AR KUNG FU by top engineers experienced in the coin-op industry. An 8-way joystick (as provided) MUST be used.

The Player Instruction and Button Control decals are made of a non-destructible acrylic material specifically to keep the player from peeling them off. Should you convert a cocktail table game, YIE AR KUNG-FU is supplied with 2 sets of button decals.

GAME PLAY

Story: This game features Oolong trying to become a grand master of Kung-Fu in honour of his father, who died in the final match for his mastership. After a long, hard apprenticeship of Kung-Fu, he has to fight 11 deadly opponents, skilled in the art of Kung-Fu.

How to Play: Use 8-way joystick and two buttons to make Oolong use all his deadly kicks and punches.

Rules: KO meter on the upper side of the screen shows Oolong's power. When the meter reaches O, he is knocked out and the game is over. When the opponent's meter reaches 0, Oolong has defeated him and goes to the next stage to fight against his next opponent.

11 opponents will appear in total. Oolong must fight 5 fighters first and then 6 masters who are even more skilled in the arts of Kung-Fu.

Hints for Play: Seek and attack each opponent's weak point. Make Oolong jump over the opponent by levering joystick diagonally.

NEW FEATURE — DUAL CONTROL

By moving SW#2 of dip switch bank #3 to the "on" position, you are now in the dual control upright mode. This allows you to set up an upright game with two sets of controls rather than one set. The first set of controls should be hooked up to the 1P set of wires; the second set to the 2P wires (see wiring diagrams). Each player still challenges the "computer-controlled" opponent (alternating play). This does not allow simultaneous interaction of players on the video screen.

SAVE YOURSELF TIME AND MONEY

The following P.C.B.'s are interchangeable with YIE ARE KUNG-FU P.C.B.'s

Super Cobra • Scramble • Pooyan • Locomotion • Circus Charlie
L'il Hustler • Juno First • Time Pilot • Gyuss • Tutankham • Turtles
Super Basketball • Mega Zone • Pandora's Palace • Time Pilot '84 • Track 'n' Field • Hypersports
Frogger (60% — check pin print-out) • Amidar • Roc 'N Rope • The End

In other words, your YIE AR KUNG-FU will plug right into existing edge connectors of the games listed above — be sure to check your pin print-out. (Keep in mind that Yie Ar Kung-Fu is designed as a horizontal game.)

PUTTING YOUR BEST GAME FORWARD

PREPARATION:

For best results, all old graphics should be removed completely from the cabinet. "Stick-on" graphics can be removed by using a hairdryer or hot air device. The heat from the dryer will loosen the adhesive, allowing you to easily peel them off — any adhesive residue can be cleaned off with acetone and a soft dry cloth. (DO NOT USE ACETONE ON SURFACES PAINTED WITH FLAT PAINT).

TOOLS YOU NEED:

1. Foaming Aerosol (such as "Windex").
2. Soft Squeegee.
3. X-Acto Knife.

SIDE PANEL DECALS

1. Spray area of cabinet where Side Panel decals are to be applied with foaming aerosol or a mild soap solution.
2. Remove protective backing from decals.
3. Position decals into place.
4. With a soft squeegee, beginning from the center of the decal, slowly and evenly press out excess foam until you achieve a smooth finish.

5. Allow to set approximately 2 to 3 hours before handling. Maximum adherence is achieved in 48 to 72 hours.
6. Trim side decal to fit your cabinet.

CONTROL PANEL OVERLAY:

1. Refer to Recommended Control Panel Layout on page 4.
2. Drill any new holes needed.
3. Plug any holes that will not be used. (A permanent epoxy filler works well for this step.)
4. Pre-position the overlay prior to removing the backing.
5. Slowly apply the overlay — inch by inch on the control panel, removing the backing as you apply it.
6. Once it's in place, by using an X-Acto knife, cut around the button and joystick placements.

INSTRUCTION/BUTTON DECALS:

Apply the Player Instruction, Button and 1 Player/2 Player decals in their respective positions. Apply pressure liberally. Allow to set as long as possible before putting game on location.

NOTE: Maximum adherence is achieved in 48 to 72 hours.

MARQUEE

(WEAR PROTECTIVE GLASSES WHILE TRIMMING MARQUEE)

1/8" Acrylic Marquee should be cut to fit your game. DO NOT remove protective mask until this is done.

One way of cutting your Marquee is as follows: (Be sure to protect painted side of Marquee from any surface which may scratch or mar finish).

CUTTING WITH A KNIFE OR SCRIBER

Acrylic sheet up to 3/16" thick may be cut by a method similar to that used for cutting window glass. Use a scribe of some kind — a scribing knife such as the one pictured, a metal scribe, an awl, or even a sturdy craft knife — to score the sheet. Draw the scribe several times (7 or 8 times for a 3/16" thick piece) along a straight edge held firmly in place. It is best not to remove the protective masking. Make the cuts carefully using firm, even pressure. For best results make each stroke cleanly off the edge of the sheet.

Then, clamp the acrylic sheet or hold it rigidly under a straight edge with the scribe mark hanging just over the edge of a table. Protect your hands with a cloth, and apply a sharp downward pressure to the other side of the sheet. It will break along the scratch. Scrape the edges to smooth any sharp corners. This method is not recommended for long breaks or thick material.

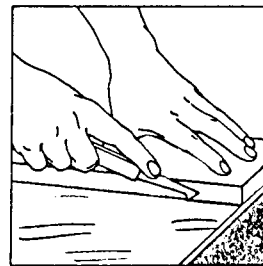

Always draw the scribing knife along a straight edge.

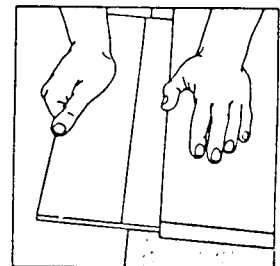

Break sheet over edge of table after scribing.

RECOMMENDED LAYOUTS FOR YIE AR KUNG-FU CONTROL PANELS

SINGLE CONTROL LAYOUT

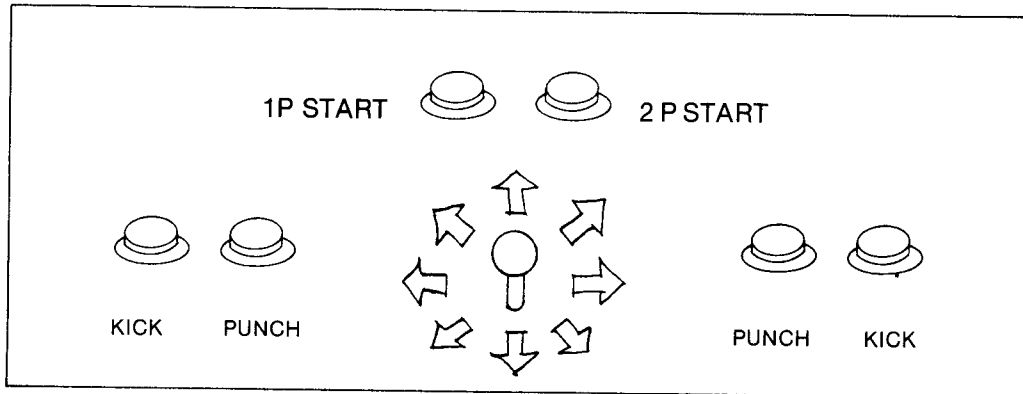

DUAL CONTROL LAYOUT

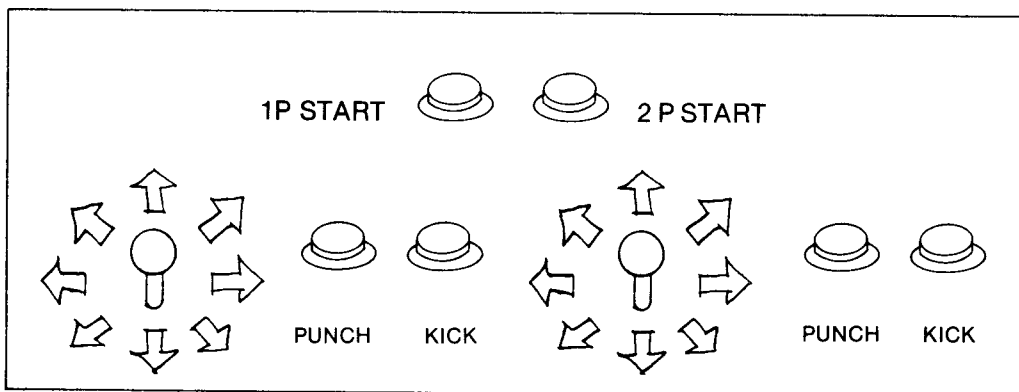

YIE AR KUNG-FU: MONITOR SPECIFICATIONS

Yie Ar Kung-Fu requires a horizontally mounted monitor. It also generates composite negative sync. If your monitor is composite positive sync, you will have to change to composite negative sync.

(1) To alternate composite positive sync to composite negative sync, use 7404 IC or 74LS04 IC. The signal on the output pin from the P.C.B. is a combination of H-sync and V-sync.

NOTE: Please refer to Figure 2.

FIGURE 2:

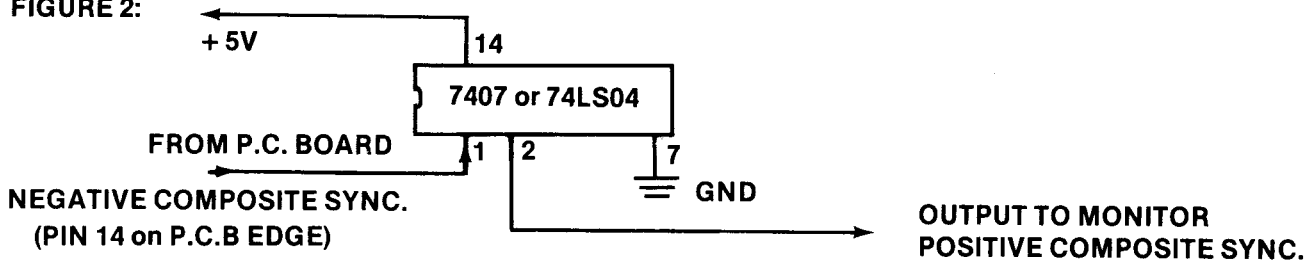

(+ 5V and GND should be taken out of the P.C. Board.)

(2) Separate Sync modification for YIE AR KUNG-FU if your monitor has "Separate Sync" input. (For example "Electrohome brand" and Wells-Gardner brand.")

Step 1

WIRING HARNESS

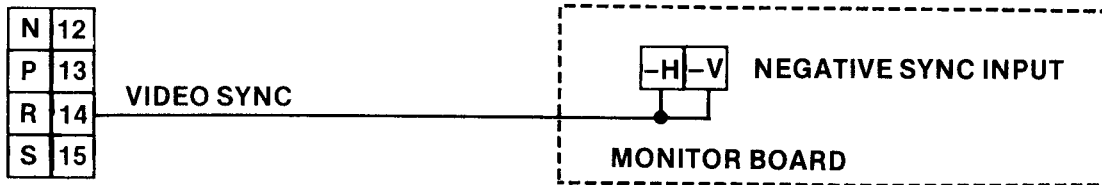

If the picture is still not stable . . .

Step 2

Prepare Hook-up wire. (For example "Electrohome brand.")

WIRING HARNESS

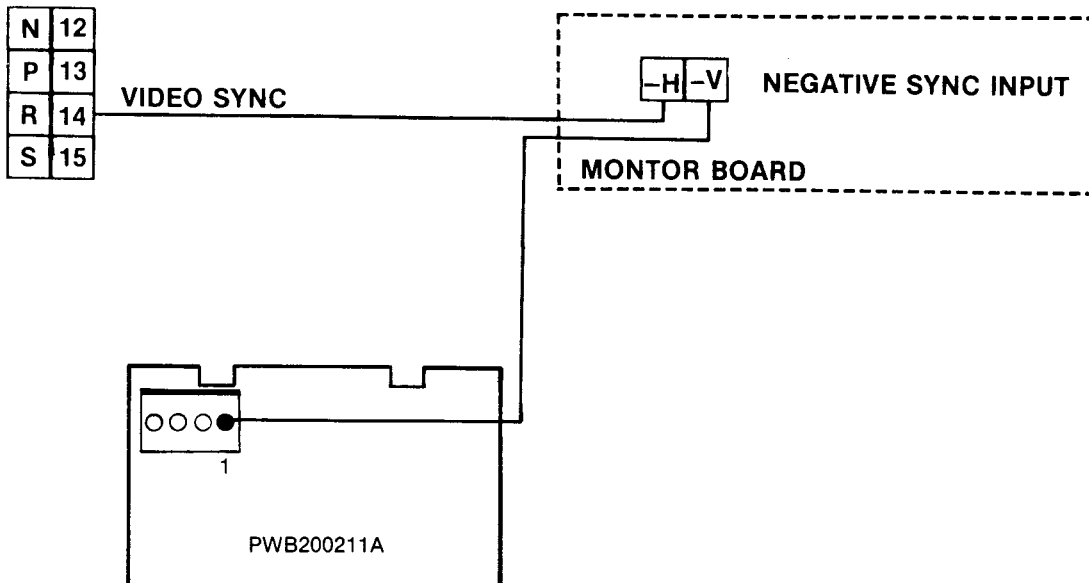

YIE AR KUNG - FU: TECHNICAL INFORMATION

(1) Required Power Capacity

- +5V DC 7A or more.
- +12V DC See Figure 1 below

Figure 1:

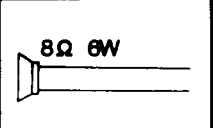
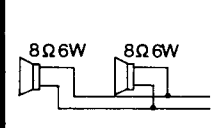
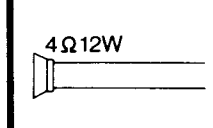
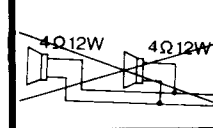
SPEAKER				
Required Power Capacity	12V 1A	12V 2A	12V 2A	Not Applicable

(2) Signal output

- R(red) analog, positive
- G(green) analog, positive
- B(blue) analog, positive
- Sync. H-V composite negative

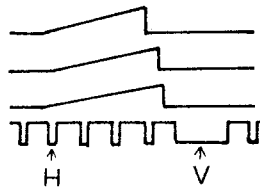

DIAGNOSTIC PROCEDURES

AUTOMATIC SELF-TEST — Upon “Power On”, this system will automatically test ROMS and VIDEO RAMS. The screen will display pass or conditions as follows:

ROM 1 OK
ROM 2 OK = TEST PASSED

RAM 1 OK
RAM 2 OK = TEST PASSED

If there is a problem, before contacting your distributor:

1. Check that all chips on board and wiring connections are tight.
2. Check output from power supply at the board. (Do not just check at the power supply as voltage drops may occur over the length of the wire.)

MANUAL TEST — A more detailed five step diagnostic may be performed by moving SW3 of Dip Switch Bank #3 to the “on” position while power to game is off. Turn power “on” and proceed as follows:

1. COLOR TEST

The screen will display eight color blocks and 4 Kung-Fu positions performed by “Star” (Villian). If a block or character shows any irregularities (e.g., lines or dots in color blocks), this could be due to a failure of VIDEO RAM, COLOR RAM, or OBJ CIRCUITS. Use these blocks to further adjust monitor focus and colors.

2. SWITCH TEST

From color test, press One Player Start and the screen will display all switches with a zero (0) to the right. When a switch is activated the zero (0) should change to a one (1).

3. COIN COUNTER TEST

From switch test, press One Player Start and the screen will display “coin counter”. While number one (1) is shown, counter one should pulse eight times. When number two (2) is shown, counter two should pulse eight times also.

4. DIP SWITCH SETTINGS

Press Player 1 and the screen will display most of the programmable features with their respective settings. These setting should correspond to the positions of the dip switches.

5. SOUND TEST

From dip switch settings, press One Player Start. The screen will automatically display one of thirty-two sound codes every few seconds with a different sound produced for each.

TO EXIT DIAGNOSTICS —

TURN POWER OFF AND RETURN SW3 TO OFF POSITION. THEN TURN POWER BACK ON.

YIE AR KUNG-FU: WIRING HARNESS

Unlettered Side (Solder Side)		Lettered Side (Parts Side)	
		A	1
	(EMPTY)	B	2
RED/GREEN	SPEAKER OUT	C	3
RED/YELLOW	* 2P PUNCH	D	4
BROWN/YELLOW	* 2P LEFT	E	5
VIOLET/WHITE	1P START	F	6
ORANGE/WHITE	1P KICK	H	7
RED/WHITE	1P PUNCH	J	8
BLUE/WHITE	1P RIGHT	K	9
BLACK/WHITE	1P UP	L	10
RED/GRAY	COIN 1	M	11
GRAY/WHITE	1P DOWN	N	12
WHITE/PINK	(NOT USED)	P	13
GREEN/BROWN	VIDEO GREEN	R	14
RED/BROWN	VIDEO RED	S	15
	(EMPTY)	T	16
BLACK	GND	U	17
BLACK	GND	V	18
RED	+ 5V DC		
			+ 12V DC
			SPEAKER OUT
			2P KICK*
			2P RIGHT*
			2P START
			2P UP*
			SERVICE SW
			1P LEFT
			2P DOWN*
			COIN 2
			COIN COUNTER 1
			COIN COUNTER 2
			VIDEO BLUE
			VIDEO SYNC
			(NOT USED)
			GND
			GND
			+ 5VDC
			ORANGE
			ORANGE/GREEN
			ORANGE/YELLOW
			BLUE/YELLOW
			VIOLET/YELLOW
			BLACK/YELLOW
			ORANGE/GRAY
			BROWN/WHITE
			GRAY/YELLOW
			BLUE/GRAY
			GREEN/GRAY
			YELLOW/GRAY
			BLUE/BROWN
			WHITE/BROWN
			YELLOW/PINK
			BLACK
			BLACK
			RED

(BASE COLOR/LINE COLOR)

*Cocktail Table or Dual Control Upright Only

YIE AR KUNG - FU WIRING DIAGRAM

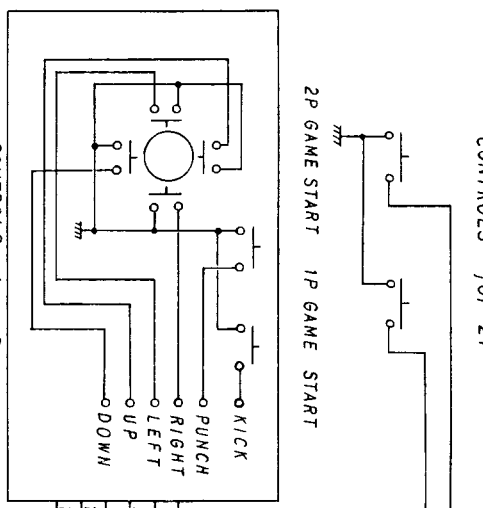
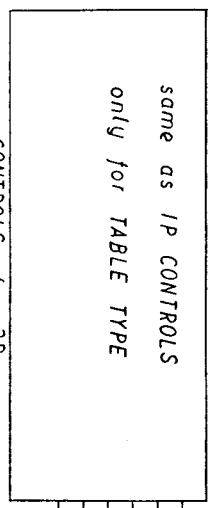
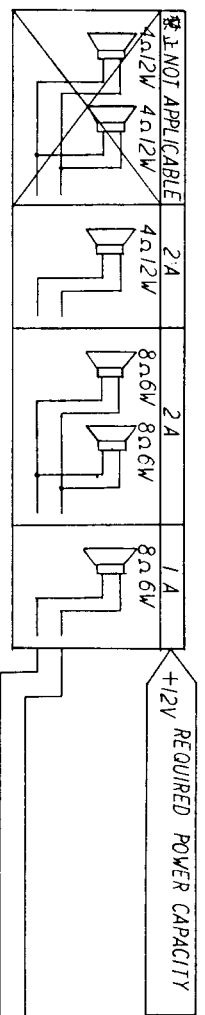

- NOTES —
- (1) 1P NO.1 player
 - 2P NO.2 player

(2) surge killer diodes for COIN COUNTER installed on the P.C.B.

*Cocktail Table or Dual Control Upright Only

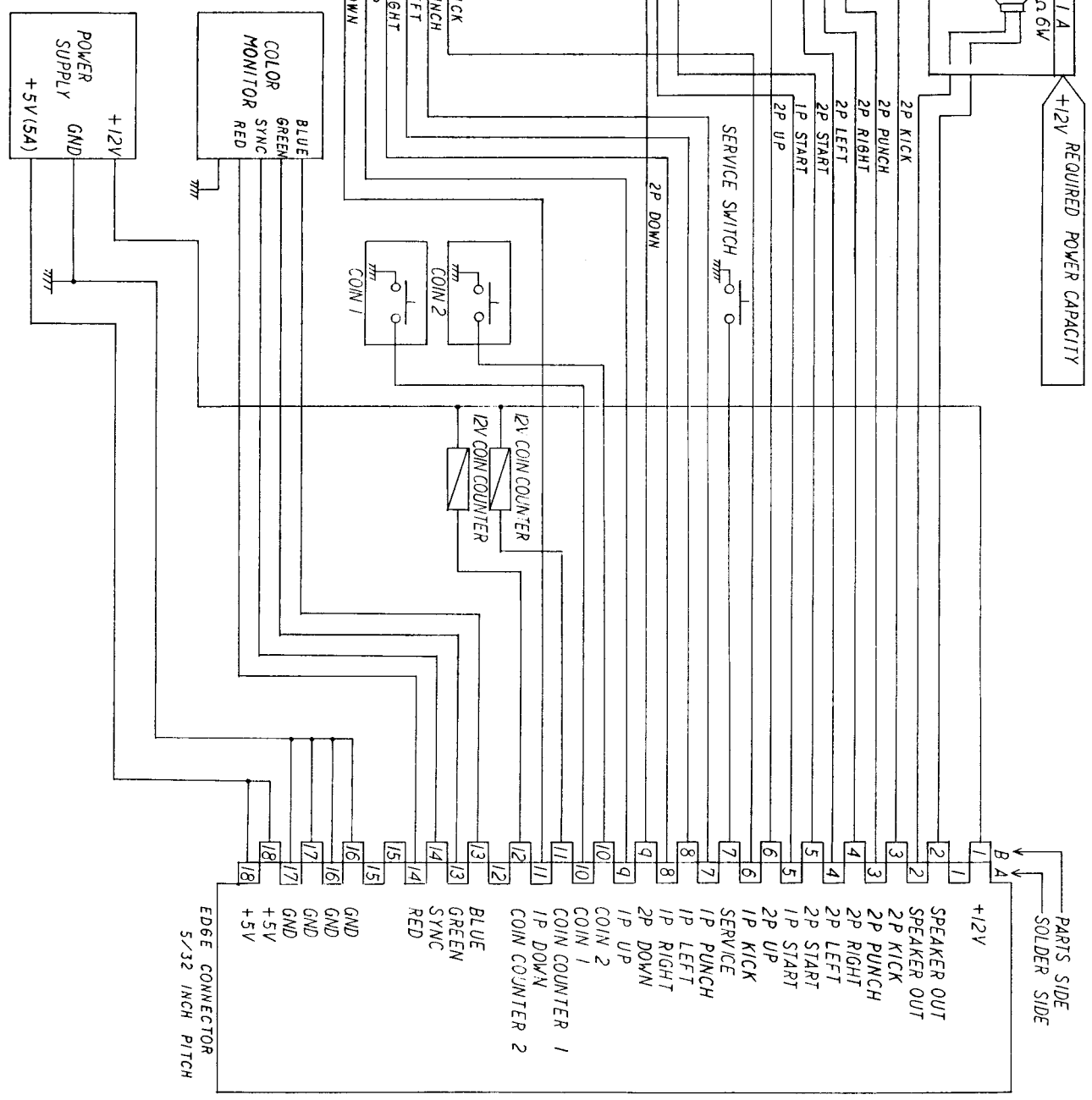

DIP SWITCH SETTINGS

DIP SW No. 1 Settings

Coin 1 Switch Set

SW	4	3	2	1	COIN	PLAY
•	OFF	OFF	OFF	OFF	1	1
			OFF	ON	1	2
			ON	OFF	1	3
			ON	ON	1	4
	OFF	ON	OFF	OFF	1	5
			OFF	ON	1	6
			ON	OFF	1	7
			ON	ON	2	1
	ON	OFF	OFF	OFF	2	3
			OFF	ON	2	5
			ON	OFF	3	1
			ON	ON	3	2
	ON	ON	OFF	OFF	3	4
			OFF	ON	4	1
			ON	OFF	4	3
			ON	ON	FREE PLAY	

Coin 2 Switch Set

SW	8	7	6	5	COIN	PLAY
•	OFF	OFF	OFF	OFF	1	1
			OFF	ON	1	2
			ON	OFF	1	3
			ON	ON	1	4
	OFF	ON	OFF	OFF	1	5
			OFF	ON	1	6
			ON	OFF	1	7
			ON	ON	2	1
	ON	OFF	OFF	OFF	2	3
			OFF	ON	2	5
			ON	OFF	3	1
			ON	ON	3	2
	ON	ON	OFF	OFF	3	4
			OFF	ON	4	1
			ON	OFF	4	3
			ON	ON	INVALIDITY	

DIP SWITCH NO. 2 SETTINGS

THE NUMBER OF PLAYER'S LIFE

SW	1	2	NUMBER
•	OFF	OFF	1
	ON	OFF	2
	OFF	ON	3
	ON	ON	5

CHANGE OF TABLE OR UP-RIGHT

SW	3	TYPE
•	OFF	TABLE
	ON	UP-RIGHT

BONUS SET

SW	4	BONUS POINTS
•	OFF	At 30,000 Pts. & Every 80,000 Pts. Thereafter
	ON	At 40,000 Pts. & Every 90,000 Pts. Thereafter

Difficulty of the Game

SW	5	6	DIFFICULTY
•	OFF	OFF	EASY
	ON	OFF	NORMAL
	OFF	ON	DIFFICULT
	ON	ON	VERY DIFFICULT

SOUND IN ATTRACT MODE

SW	8	SOUND
•	OFF	OFF
	ON	ON

DIP SWITCH NO. 3 SETTINGS

Video Screen Flip

SW	1	TYPE
•	OFF	NORMAL
	ON	UPSIDE DOWN

Single/Dual Control Upright

SW	2	TYPE
•	OFF	SINGLE UPRIGHT CONTROL
	ON	DUAL UPRIGHT CONTROL

Game Test Mode

SW	3	MODE
•	OFF	GAME MODE
	ON	CHECK MODE

*SW 4: NOT USED

*SW 7: NOT USED

•SHOWS NORMAL SETTING

