

Canon

# EOS 10D

## DIGITAL

### INSTRUCTION MANUAL



Be sure to read this Instruction Manual before using your camera for the first time. Keep this booklet handy for easy reference.



English Edition

Canon

EOS 10D DIGITAL

INSTRUCTION MANUAL

# Thank you for purchasing a Canon product.

The EOS 10D is a high-performance, single-lens reflex, AF digital camera with an ultra-fine CMOS sensor having 6.30 million effective pixels. It is compatible with all Canon EF lenses and designed for quick and easy shooting at any time. It is full-featured for all types of shooting, from fully automatic snap shooting to highly creative work. Images can also be printed directly from the camera.

CompactFlash cards serve as the camera's recording medium.

Be sure to read this Instruction Manual to familiarize yourself with the features and proper operation of this camera.

\* Using CF cards made by Canon is recommended.

## Radio and Television Interference (VCCI Statement)

This camera is an information technology device that does not exceed Class B limits for electromagnetic interference (EMI) in compliance with standards set by Japan's Voluntary Control Council for Interference by Information Technology Equipment (VCCI). This device may still cause interference with radio or television reception when placed near such an appliance.

## Test the Camera Before Shooting

Before using the camera, be sure to test it first. Check that the images are properly recorded on the CF card. If the camera or CF card is faulty and the images cannot be recorded or read by a personal computer, Canon cannot be held liable for any loss or inconvenience caused.

## Copyrights

Copyright laws in your country may prohibit the use of images of people and certain subjects for anything but private enjoyment. Shooting public performances or exhibitions may also be prohibited.

- Canon and EOS are trademarks of Canon Inc.
- Adobe and Photoshop are trademarks of Adobe Systems Incorporated.
- CompactFlash is a trademark of SanDisk Corporation.
- IBM PC/AT is a trademark or registered trademark of International Business Machines.
- Macintosh is a registered trademark of Apple Corporation in the United States and other countries.
- All other trademarks are the property of their respective owners.

# Equipment Check List

Be sure all the following equipment and accessories have been included with your camera. If anything is missing, contact your dealer.

- 
- EOS 10D camera body** (with body cap and lithium backup battery for the date and time)
  - Eyecup Eb**
  - Battery Pack BP-511** (includes protective cover)
  - Battery Charger CB-5L**
  - Power cord for battery charger**
  - Interface Cable IFC-300PCU**
  - Video Cable VC-100**
  - Neck Strap EW-100DB** (with eyepiece cover)

- 
- EOS DIGITAL Solution Disk**
  - Adobe Photoshop Elements Disk**

- 
- EOS 10D Instructions** (which you are reading now)
  - EOS 10D Software Instructions**  
Explains how to install the software for transferring images from the camera to a personal computer, processing RAW images, and image processing.
  - Battery Pack BP-511 Instructions**

- 
- Warranty card**
  - Quick Operation Guide**
  - EOS 10D Accessories**  
Introduces major accessories for the EOS 10D.

---

\* **No CF card is included.** Please purchase it separately. CF cards made by Canon are recommended.

---

This digital camera supports Exif 2.2 (also called "Exif Print"). Exif Print is a standard for enhancing the communication between digital cameras and printers. By connecting to an Exif Print-compliant printer, the camera's image data at the time of shooting is used and optimized, yielding extremely high quality prints.

# Contents

## Introduction

Equipment Check List .....	3
Handling Precautions .....	10
Quick Start Guide .....	12
Nomenclature .....	14
Conventions Used in this Manual .....	20

## 1 Before You Start ..... 21

Attaching the Strap .....	21
Recharging the Battery .....	22
Installing and Removing the Battery .....	24
Battery Level Icons .....	24
Using a Household Power Supply .....	26
Mounting and Detaching a Lens .....	27
Installing and Removing the CF Card .....	28
Basic Operation .....	30
Main Switch .....	30
Shutter Button .....	30
Using the Electronic Dials .....	31
Menu Operations .....	32
Menu Screen .....	32
Setting Procedure .....	33
Menu Selections and Default Settings .....	34
LCD Monitor .....	35
Reverting to the Default Settings .....	35
Dioptic Adjustment .....	36
Holding the Camera .....	36

## 2 Fully Automatic Shooting ..... 37

Fully Automatic Shooting .....	38
AF-Assist Beam with the Built-in Flash .....	39
Programmed Image Control Modes .....	40
Portrait .....	40
Landscape .....	40
Close-up .....	40
Sports .....	41
Night Portrait .....	41
Flash off .....	41
<b>MENU</b> Reviewing Images .....	42
Image Review .....	42
Changing the Review Time .....	43

## 3 Settings for Shooting ..... 45

<b>MENU</b> Image-Recording Quality .....	46
Processing .....	47
<b>MENU</b> Simultaneous Capture in RAW and JPEG Formats ...	48

<b>ISO</b> Setting the ISO Speed .....	49
ISO Speed in the Basic Zone Modes .....	49
ISO Speed in the Creative Zone Modes .....	49
<b>WB</b> Selecting the White Balance .....	50
White Balance .....	50
White Balance Settings .....	51
<b>MENU</b> Custom White Balance .....	52
<b>MENU</b> Setting the Color Temperature .....	53
<b>MENU</b> White Balance Auto Bracketing .....	54
<b>MENU</b> Setting Processing Parameters .....	56
<b>MENU</b> Selecting a Color Space .....	58
Selecting sRGB .....	58
Selecting Adobe RGB .....	58
<b>MENU</b> File Numbering Methods .....	59
Continuous Numbering .....	59
Auto Reset .....	59
<b>MENU</b> Setting Auto Rotation .....	61
<b>INFO.</b> Checking Camera Settings .....	62

## 4 Focusing ..... 63

<b>AF</b> Selecting AF Mode .....	64
One-Shot AF for Still Subjects .....	65
Focusing an Off-Center Subject .....	65
AI Servo AF for Moving Subjects .....	66
AI Focus AF for Automatic AF Mode Switching ...	66
<b>AF-ON</b> Selecting an AF Point .....	67
Basic Procedure for AF Point Selection .....	67
Automatic Selection .....	68
Manual Selection .....	68
<b>MENU</b> Registering and Switching an AF Point ...	69
Registering an AF Point .....	69
Switching to the Registered AF Point .....	70
When Autofocus Fails (Manual Focusing) .....	71

## 5 Selecting the Metering Mode and Drive Mode ... 73

Selecting the Metering Mode .....	74
Metering Modes .....	75
Evaluative Metering .....	75
Partial Metering .....	75
Center-weighted Average Metering .....	75
<b>DRIVE</b> Drive Mode Selection .....	76
Self-timer Operation .....	77
Using the Eyepiece Cover .....	78

## 6 Advanced Operations ..... 79

<b>P</b> Program AE .....	80
---------------------------	----

**Tv** Shutter-Priority AE ..... 82

**Av** Aperture-Priority AE ..... 84

Depth-of-field Preview ..... 85

**M** Manual Exposure ..... 86

**A-DEP** Automatic Depth-of-Field AE ..... 88

Setting Exposure Compensation ..... 89

**MENU** Auto Exposure Bracketing ..... 90

**\*** AE Lock ..... 92

Bulb Exposures ..... 93

Mirror Lockup ..... 94

**☼** LCD Panel Illumination ..... 94

**7 Shooting with a Flash ..... 95**

Using the Built-in Flash ..... 96

    Using the Built-in Flash in the Basic Zone ... 96

    Using the Built-in Flash in the Creative Zone .. 97

Using Red-eye Reduction ..... 99

**\*** FE Lock ..... 100

**☼** Flash Exposure Compensation ..... 101

Flash Shot with Speedlite 550EX ..... 102

    Full Auto Flash ..... 103

    Taking Flash Shots in Each Shooting Mode .... 103

**⚡** High-Speed Sync (FP Flash) ..... 104

    FEB (Flash Exposure Bracketing) ..... 104

**\*** FE Lock ..... 105

**☼** Flash Exposure Compensation ..... 105

    Modeling Flash ..... 105

    Wireless Multi-Flash/E-TTL Autoflash Shooting ... 105

Using Non-Canon Flash Units ..... 106

TTL and A-TTL Autoflash Speedlites ..... 106

**8 Image Playback ..... 107**

Image Playback ..... 108

**☐** Single image ..... 108

**INFO.** Image with Shooting Information ..... 109

**☒** Index Display ..... 110

**🔍 / 🔍** Magnified View ..... 111

**JUMP** Image Jump ..... 112

**MENU** Automated Playback of Images (Auto playback) ... 113

**MENU** Rotating an Image ..... 114

Connecting to a TV ..... 115

**MENU** Image Protection ..... 116

**🗑️** Erasing an Image ..... 117

    Erasing a Single Image ..... 117

    Erasing All Images ..... 118

**MENU** Formatting the CF Card ..... 119

**9 Direct Printing from the Camera ... 121**

Direct Printing ..... 122

Connect the Camera to the Printer ..... 122

**☑** Connecting to a Card Photo Printer ..... 122

**☑** Connecting to a Canon BJ Printer ..... 124

Printing ..... 125

Printing Options ..... 127

    Setting the Quantity ..... 127

    Setting the Printing Style ..... 127

    Trimming ..... 129

**10 DPOF: Digital Print Order Format ... 131**

**MENU** Print Order ..... 132

    Selecting the Images to be Printed ..... 133

    Printing Options ..... 135

Direct Printing with DPOF ..... 137

**11 Menu Settings ..... 139**

**MENU** Menu Settings ..... 140

**MENU** Setting Custom Functions ..... 145

**MENU** Custom Function Settings ..... 146

**MENU** Clearing All Custom Functions ..... 152

**12 Maintenance ..... 153**

**MENU** Setting the Date and Time ..... 154

Replacing the Date/Time Battery ..... 155

**MENU** Cleaning the Image Sensor (CMOS) ..... 156

**13 Reference ..... 159**

Basic Terminology ..... 160

Function Availability Table ..... 163

AF Modes and Drive Modes ..... 163

Exposure Warning List ..... 164

AE Lock Effects ..... 165

Program Line ..... 165

Shutter Speed and Aperture Value Readouts ... 166

On-screen Messages ..... 167

Error Codes ..... 171

Troubleshooting Guide ..... 172

Major Accessories (optional) ..... 174

System Map ..... 176

Specifications ..... 178

Index ..... 182

- 1
- 2
- 3
- 4
- 5
- 6
- 7
- 8
- 9
- 10
- 11
- 12
- 13

## Digital Camera Model DS6031

This device complies with Part 15 of the FCC Rules. Operation is subject to the following two conditions: (1) This device may not cause harmful interference, and (2) this device must accept any interference received, including interference that may cause undesired operation.

Note: This equipment has been tested and found to comply with the limits for class B digital devices, pursuant to Part 15 of the FCC Rules. These limits are designed to provide reasonable protection against harmful interference in a residential installation. This equipment generates, uses and can radiate radio frequency energy and, if not installed and used in accordance with the instructions, may cause harmful interference to radio communications. However, there is no guarantee that interference will not occur in a particular installation. If this equipment does cause harmful interference to radio or television reception, which can be determined by turning the equipment off and on, the user is encouraged to try to correct the interference by one or more of the following measures:

- Reorient or relocate the receiving antenna.
- Increase the separation between the equipment and receiver.
- Connect the equipment into an outlet on a circuit different from that to which the receiver is connected.
- Consult the dealer or an experienced radio/TV technician for help.

The cable with the ferrite core provided with the digital camera must be used with this equipment in order to comply with Class B limits in Subpart B of Part 15 of the FCC rules.

Do not make any changes or modifications to the equipment unless otherwise specified in the manual. If such changes or modifications should be made, you could be required to stop operation of the equipment.

Canon U.S.A. Inc.  
One Canon Plaza, Lake Success, NY 11042, U.S.A.  
Tel No. (516)328-5600



The **CE** Mark is a directive conformity mark of the European Community (EC).



This mark indicates that the product complies with Australia's EMC regulations.

## SAFETY PRECAUTIONS

- Before using the camera, please ensure that you have read and understood the safety precautions described below. Always ensure that the camera is operated correctly.
- The safety precautions noted as follows are intended to instruct you in the safe and correct operation of the camera and its accessories to prevent injuries or damage to yourself, other persons and equipment.
- The term “equipment” refers primarily to the camera and its power supply accessories.

## WARNINGS

- Do not aim the camera or detached lens only directly into the sun or at other intense light sources that could injure your eyesight.
- Store this equipment out of the reach of children and infants. Accidental damage to the camera or batteries by a child could result in serious injury. In addition, placement of the neck strap around a child’s neck could result in asphyxiation.
- Be particularly careful to keep the lithium battery CR2025 used in the camera out of the reach of children. Seek medical assistance immediately if a child swallows the battery.
- Do not attempt to disassemble or alter any part of the equipment. Disassembly or alteration may result in high-voltage electrical shock. Internal inspections, alterations and repairs should be conducted by qualified service personnel authorized by your camera distributor or Canon Customer Support.
- To avoid the risk of high-voltage electrical shock, do not touch internal portions of the equipment that become exposed as a result of damage. Please take the first opportunity to consult your camera distributor or Canon Customer Support immediately.
- Stop operating the equipment immediately if it should emit smoke or noxious fumes. Failure to do so may result in fire or electrical shock. Set the camera’s main switch to the OFF position and remove the camera battery or unplug the power cord from the electrical outlet immediately. Please consult your camera distributor or the closest Canon Customer Support.
- Stop operating the equipment if it is dropped or the casing is damaged. Failure to do so may result in fire or electrical shock. Set the camera’s main switch to the OFF position and remove the camera battery or unplug the power cord immediately. Please consult your camera distributor or the closest Canon Customer Support.
- Prevent the equipment from immersion in, water or other liquids. Do not allow liquids to enter the interior. The camera is not waterproof. If the exterior contacts with liquids or salt air, wipe it dry with a soft, absorbent cloth. If water or other foreign substances enter the interior, immediately set the camera’s main switch to the OFF position and remove the camera battery or unplug the power cord immediately. Continued use of the equipment may result in fire or electrical shock. Please consult your camera distributor or the closest Canon Customer Support.
- Do not use substances containing alcohol, benzene, thinners or other flammable substances to clean or maintain the equipment. The use of these substances may lead to fire.
- Do not cut, damage, alter or place heavy items on the power cord. Any of these actions may cause an electrical short circuit, which may lead to fire or electrical shock. Replace a broken or damaged power cord.

- 
- Do not handle the power cord if your hands are wet. Handling it with wet hands may lead to electrical shock. When unplugging the cord, ensure that you hold the rigid portion of the plug. Pulling the flexible portion of the cord may damage or expose the wire and insulation, creating the potential for fires or electrical shocks.
- 
- Use of power sources not expressly recommended for this equipment may lead to overheating, distortion of the equipment, fire, electrical shock or other hazards. Use only the recommended power accessories.
- 
- Power down the computer and unplug the power cord before attempting to connect the interface cable, to avoid the risk of electrical shock.
- 
- Do not place the batteries near a heat source or expose them to direct flame or heat. Neither should you immerse them in water. Such exposure may damage the batteries and lead to the leakage of corrosive liquids, fire, electrical shock, explosion or serious injury.
- 
- Do not attempt to disassemble, alter, or apply heat to the batteries. There is serious risk of injury due to an explosion. Immediately flush with water any area of the body, including the eyes and mouth, or clothing, that comes into contact with the inner contents of a battery. If the eyes or mouth contact these substances, immediately flush with water and seek medical assistance.
- 
- Avoid dropping or subjecting the batteries to severe impacts that could damage the casings. This could lead to leakage and injury.
- 
- Do not short-circuit the battery terminals with metallic objects, such as key holders. This could lead to overheating, burns and other injuries. Use the supplied battery case to transport or store the battery pack.
- 
- Before you discard a battery, cover the terminals with tape or other insulators to prevent direct contact with other objects. Contact with the metallic components of other materials in waste containers may lead to fire or explosions. Discard batteries in specialized waste facilities if available in your area.
- 
- Use of batteries not expressly recommended for this equipment may cause explosions or leaks, resulting in fire, injury and damage to the surroundings. Use only recommended batteries and accessories.
- 
- Use only the recommended battery charger to charge the Battery Pack BP-511 rechargeable batteries. Use of chargers not expressly recommended may result in overheating, distortion, fire or electrical shock.
- 
- Disconnect the AC adapter from both the camera and electrical outlet when the camera is not in use to avoid fires and other hazards.
- 
- The camera terminal of the DC coupler cord is designed for exclusive use with the EOS 10D. Do not use it with other products or batteries. There is a risk of fire and other hazards.



## CAUTIONS

- Avoid using, placing or storing the equipment in places subject to strong sunlight or high temperatures, such as the dashboard or trunk (boot) of a car. Exposure to intense sunlight and heat may cause the batteries to leak, overheat or explode, resulting in fire, burns or other injuries. High temperatures may also cause deformation of the casing. Ensure that there is good ventilation when using the battery charger to charge the battery pack.
- Do not store the equipment in humid or dusty areas. Storage in these areas could lead to fire, electrical shock or other damage.
- Be careful not to bang the camera or subject it to strong impacts or shocks that could lead to injury or damage the equipment when wearing or holding it by the wrist strap.
- Be careful not to cover the flash with your fingers when shooting. In addition, do not touch the surface of the flash after taking several pictures in rapid succession. Either action could result in burns.

## Preventing Malfunctions

### Avoid Strong Magnetic Fields

Never place the camera in close proximity to electric motors or other equipment generating strong electromagnetic fields. Exposure to strong magnetic fields may cause malfunctions or corrupt image data.

### Avoid Condensation Related Problems

Moving the equipment rapidly between hot and cold temperatures may cause condensation (water droplets) to form on its external and internal surfaces. You can avoid this by placing the equipment in an airtight, resealable plastic bag and letting it adjust to temperature changes slowly before removing it from the bag.

### If Condensation Forms Inside the Camera

Stop using the camera immediately if you detect condensation. Continued use may damage the equipment. Remove the CF card and battery or power cord (if connected) from the camera and wait until the moisture evaporates completely before resuming use.

### Extended Storage

When not using the camera for extended periods of time, remove the battery (except the CR2025 lithium button battery) and store the equipment in a safe place. Storing the camera for extended periods with a battery installed will run down the battery and may damage the camera.

## Important Safety Functions and Preventive Measures

- When the CF Card Access Lamp is blinking, do not remove the CF card from the camera. Since the card is reading and writing data when the lamp is blinking, removal of the CF card at this time will damage the card.
- Do not use any cable other than that supplied with the camera. Use the supplied interface cable to connect the camera to a computer. Use of any other cable may lead to a malfunction.

# Handling Precautions

## The Camera

- (1) This camera is a precision instrument. Do not drop it or expose it to physical shock.
- (2) The camera is not waterproof and should not be used in wet conditions or underwater. If the camera gets wet, take it to your nearest Canon dealer as soon as possible. If small amounts of water splash onto the camera, wipe it with a clean dry cloth. If the camera is exposed to salty air, wipe it thoroughly with a slightly damp cloth.
- (3) Never leave the camera close to devices that generate strong magnetic fields, such as magnets or electric motors. Do not operate or leave the camera in areas where strong electromagnetic signals are generated, such as near electronic transmission towers. Exposing the camera to strong electromagnetic signals can cause it to malfunction and destroy recorded image data.
- (4) Do not leave the camera in hot locations, such as in a car sitting in direct sunlight. High temperatures can damage the camera.
- (5) The camera contains precision circuits. Never attempt to disassemble the camera or service it yourself.
- (6) Use a commercially available blower brush to remove any dust that accumulates on the camera lens, viewfinder, mirror, or focusing screen. Do not use cleaners that contain organic solvents to wipe off the camera body or lens. If the camera is very soiled, consult your nearest Canon dealer.
- (7) Do not touch the camera's electrical contacts with your hands. Doing so could corrode the contacts and interfere with the camera's normal operation.
- (8) If the camera is suddenly brought in from the cold into a warm room, condensation may form on the camera and internal parts. To prevent condensation, first put the camera in a sealed plastic bag. Let the camera adjust to the warmer temperature before taking it out of the bag.
- (9) Do not use the camera if condensation forms on it, or you could damage it. If this occurs, remove the CF card and battery from the camera, and wait until the condensation has evaporated before using the camera.
- (10) If the camera will not be used for an extended period, remove its battery and store the camera in a cool, dry, well-ventilated location. While the camera is in storage, operate its shutter periodically to make sure that it is working.
- (11) Avoid storing the camera in locations where potentially corrosive chemicals are used, such as in a laboratory.
- (12) If the camera has been in storage for an extended period, check its components before using it. If you have not used the camera for some time or are planning to take shots you will not want to lose (overseas vacation, etc.), have the camera checked by your Canon dealer beforehand, or check for yourself that the camera components are working properly.

## LCD Panel and LCD Monitor

- (1) The LCD monitor is manufactured with very high precision technology. However, there may be a few dead pixels where a black or red pixel is always displayed. They number no more than 0.01 percent of all effective pixels. They are not a malfunction and do not affect the images recorded.
- (2) Do not press hard on an LCD display or subject it to impacts, as this can cause display flaws and damage.

- (3) If an LCD display becomes soiled, clean it with a commercially available blower brush, or wipe it with a soft cloth, taking care not to scratch the screen. If an LCD display becomes extremely soiled, consult your nearest Canon dealer.
- (4) By their nature, LCD displays react more slowly at low temperatures, and may appear dark at high temperatures. The display will return to normal at room temperature.

## Lithium Battery for the Date and Time

- (1) Store lithium batteries out of reach of small children. The chemicals in these batteries are very dangerous if the battery is accidentally swallowed. If this happens, seek medical attention at once.
- (2) Do not use metal instruments such as pliers to hold the battery, or you could cause a short circuit.
- (3) Do not disassemble or heat the battery, or you could rupture it.

## CF Card

- (1) The CF card is a precision device. Do not drop CF cards or expose them to vibrations. Doing so could lose the images recorded on them.
- (2) Do not store or use CF cards near objects that generate magnetic fields, such as TVs, speakers, or magnets, or in locations affected by static electricity. Doing so could lose the images recorded on the CF card.
- (3) Do not place CF cards in direct sunlight or close to heating appliances. Doing so can distort the cards and make them unusable.
- (4) Do not spill liquids onto CF cards.
- (5) Always store your CF cards in a case or cabinet to protect the data stored on them.
- (6) Use only CF cards specified by Canon. Otherwise, you may be unable to record or play back images.
- (7) Do not bend CF cards, or subject them to strong impacts.
- (8) Do not store CF cards in hot, dusty, or humid locations, or in locations exposed to static electricity or magnetic fields.

## Lens Electrical Contacts

After detaching the lens from the camera, attach the lens caps or put down the lens with the rear end up to avoid scratching the lens surface and electrical contacts.

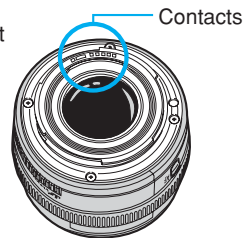

# Quick Start Guide

For detailed instructions, see the reference page indicated in parentheses.

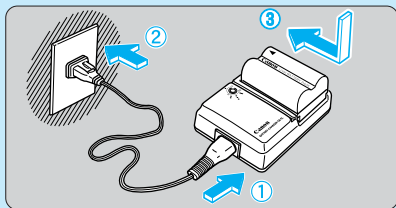

- 1 Recharge the battery.**  
Connect the power cord to the battery charger, then attach the battery. When the charge lamp stops blinking and stays lit, the battery is completely charged. A full battery charge takes approximately 90 minutes. (→p.22)

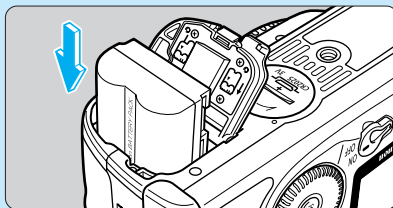

- 2 Load the battery.**  
Open the battery compartment cover and slide the battery pack into position until it locks into place. Press the cover closed until it clicks shut. (→p.24)

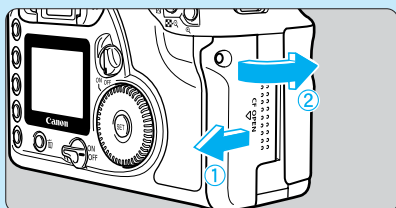

- 5 Open the CF card slot cover.**  
Slide the cover in the direction shown by the arrow, then open it. (→p.28)

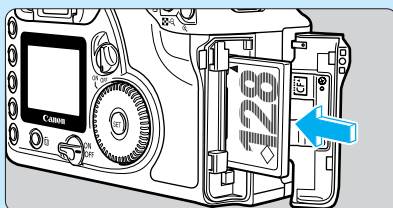

- 6 Insert a CF card (optional).**  
After inserting the CF card, close the cover. (→p.28)

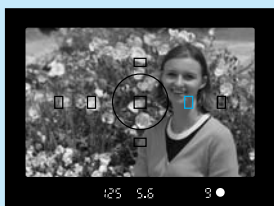

- 9 Focus on the subject.**  
Look through the viewfinder and place the AF point over the subject. Then press the shutter button halfway to focus. (→p.30)

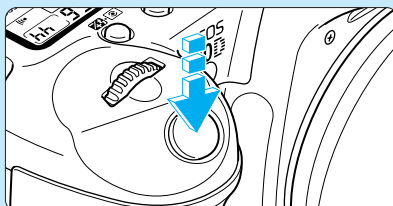

- 10 Shoot.**  
Press the shutter button fully to shoot. (→p.30)

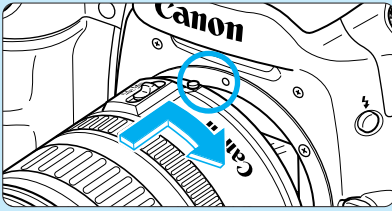

- 3 Mount the lens.**  
Align the red dots on the lens and camera and turn the lens in the direction shown by the arrow in the diagram until it clicks into place.  
(→p.27)

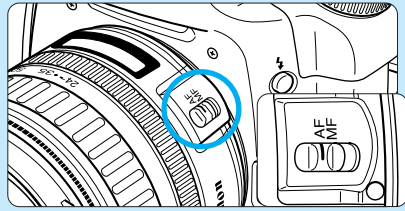

- 4 Set the focus mode switch on the lens to <AF>.**  
(→p.27)

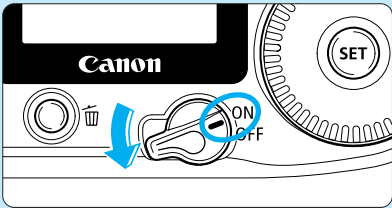

- 7 Turn the <S> switch to <ON>.**  
(→p.30)

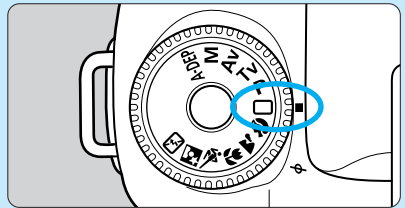

- 8 Set the Mode Dial to <□> (Full Auto).**  
(→p.38)



- 11 Review the image on the LCD monitor.**  
The image you just took will be displayed for about 2 sec. This display time can also be changed. (→p.43)



- To check other images you have taken, see “Reviewing Images” (→p.42) and “Image Playback” (→p.108).
- To erase images you have taken, see “Erasing an Image” (→p.117).

# Nomenclature

Reference page numbers are indicated by (→\*\*\*) .

⟨AF-WB⟩ AF mode selection  
/White balance button (→64/50)

⟨DRIVE/ISO⟩ Drive mode selection  
button/ISO speed set button  
(→76/49)

⟨ 

⟨

Shutter button  
(→30)

Red-eye  
reduction  
/Self-timer lamp  
(→99/77)

Grip  
(Battery  
compartment)

DC coupler cord  
hole (→26)

Mirror (→94,156)

Contacts (→11)

⟨

LCD panel (→16)

Lens mount index (→27)

Built-in flash (→96)

Flash-sync contacts

Hot shoe (→102)

Mode dial (→18)

Strap mount  
(→21)

⟨

Lens release  
button (→27)

Depth-of-field  
preview button (→85)

Lens lock pin

Lens mount

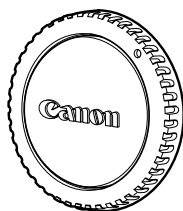

Body cap (→27)

## Cover

DIGITAL terminal  
(→123, See "EOS 10D  
Software Instructions.")

VIDEO OUT terminal  
(→115)

PC terminal (→106)

Remote control  
terminal (N3)

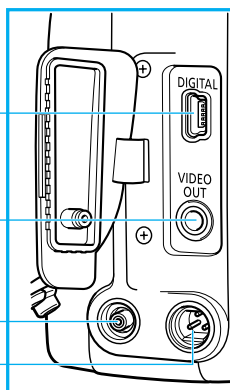

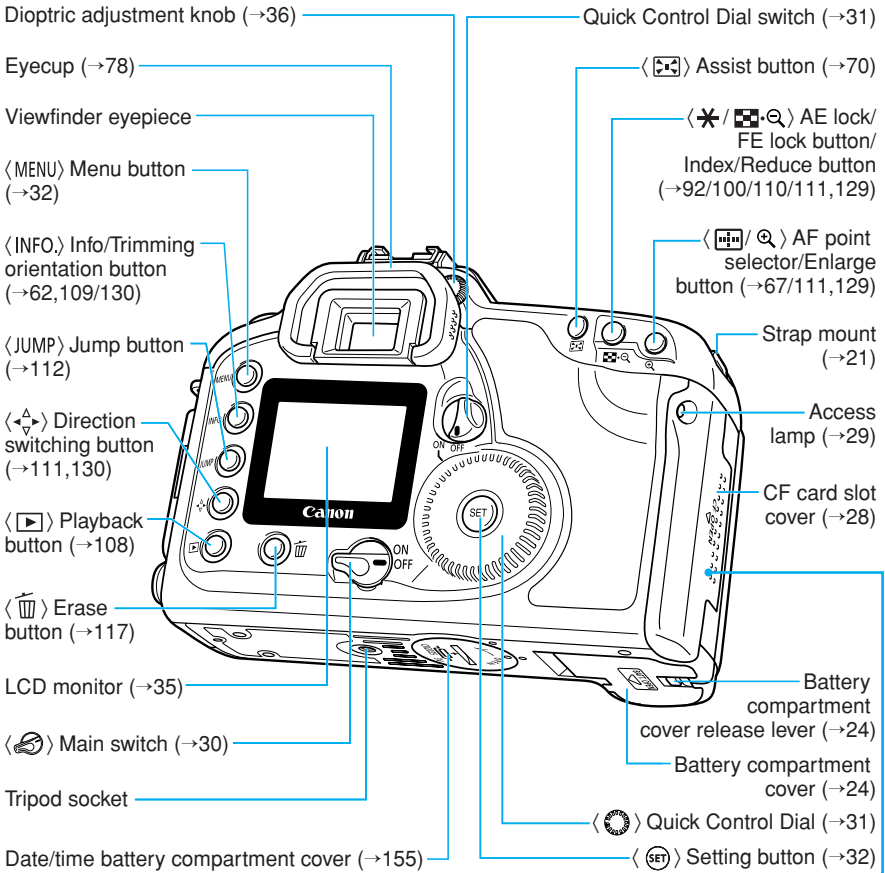

**CF card slot cover**

- CF card slot (accepts card type I and II) (→28)
- CF card eject button (→28)

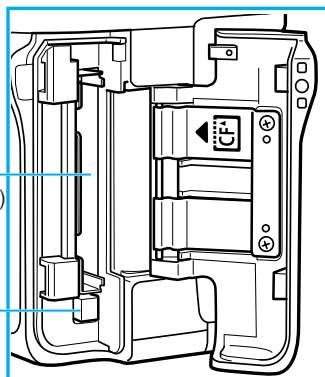

# LCD Panel

Shutter speed ( 4000 - 30', bulb )  
 Busy ( busy )  
 Date/time battery level warning ( [ b ] )  
 Processing Parameters  
 ( PR-1 - PR-3 , PR-R )  
 ISO Speed ( Auto, 100 - 1600, H )  
 Camera starting ( EOS )

Image-Recording quality  
**L** Large/Fine  
**L** Large/Normal  
**M** Medium/Fine  
**M** Medium/Normal  
**S** Small/Fine  
**S** Small/Normal  
**RAW** RAW

White balance  
**AWB** Auto  
 Daylight  
 Shade  
 Cloudy  
 Tungsten  
 Fluorescent  
 Flash  
 Custom  
**K** Color temperature

Battery level

Flash exposure compensation

AEB

Exposure level indicator  
 Exposure compensation amount  
 AEB level  
 Flash exposure compensation amount

CF card writing status

AF point selection ( [ - - - ] )  
 CF card full warning ( Full CF )  
 CF card error warning ( Err CF )  
 No CF card warning ( no CF )  
 Error indicator ( Err )  
 Cleaning image sensor ( CLEAR )

Aperture value ( 00 - 9.1 )

**ISO** ISO speed

Shots remaining  
 ( 999 - 0 )  
 Self-timer countdown  
 ( 10 - 1 )  
 Bulb exposure time  
 ( 0 - 999 )

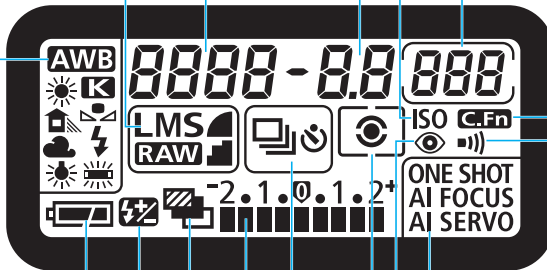

**C.Fn**  
 Custom function

Beeper

AF mode  
**ONE SHOT** One-Shot AF  
**AI FOCUS** AI Focus AF  
**AI SERVO** AI Servo AF

Red-eye reduction

Metering mode  
 Evaluative metering  
 Partial metering  
 Center-weighted average metering

Drive mode  
 Single-frame  
 Continuous  
 Self-timer

The above diagram shows the LCD panel with all icons and indicators displayed. In actual use, the items displayed differ according to the shooting situation.



# Viewfinder Information

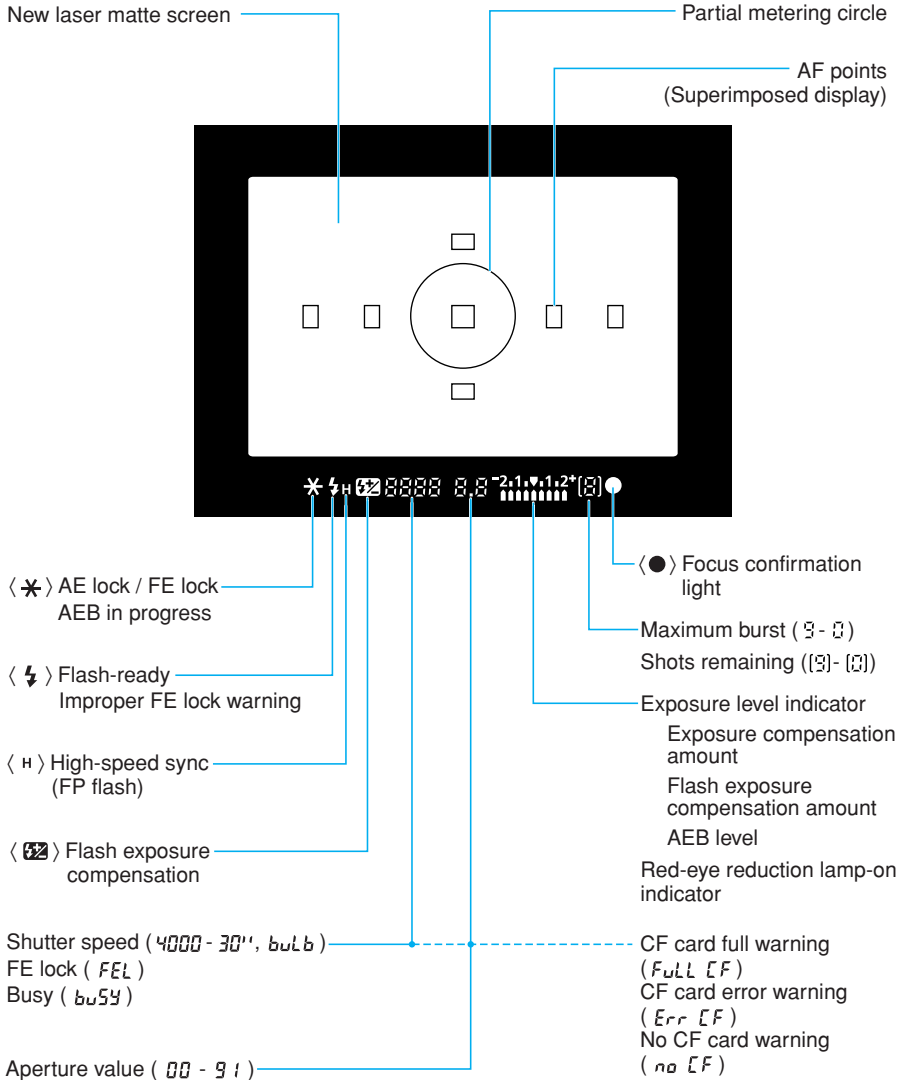

The above diagram shows the LCD panel with all icons and indicators displayed. In actual use, the items displayed differ according to the shooting situation.

# Mode Dial

The Mode Dial is divided into two functional zones.

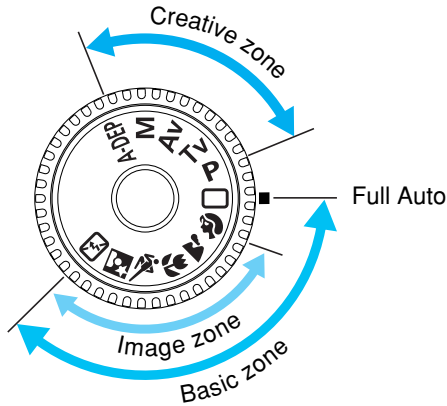

## ① Basic zone

- All you do is press the shutter button.

**□** : **Full Auto** (→p.38)  
Allows you fully automatic shooting—the camera makes all the settings.

## Image zone

Allows you fully automatic shooting in specific situations.

-  : Portrait (→p.40)
-  : Landscape (→p.40)
-  : Close-up (→p.40)
-  : Sports (→p.41)
-  : Night Portrait (→p.41)
-  : Flash off (→p.41)

## ② Creative zone

Lets you make a variety of settings.

- P** : Program AE (→p.80)
- Tv** : Shutter-priority AE (→p.82)
- Av** : Aperture-priority AE (→p.84)
- M** : Manual exposure (→p.86)
- A-DEP** : Automatic Depth-of-field AE (→p.88)

# Battery Charger CB-5L

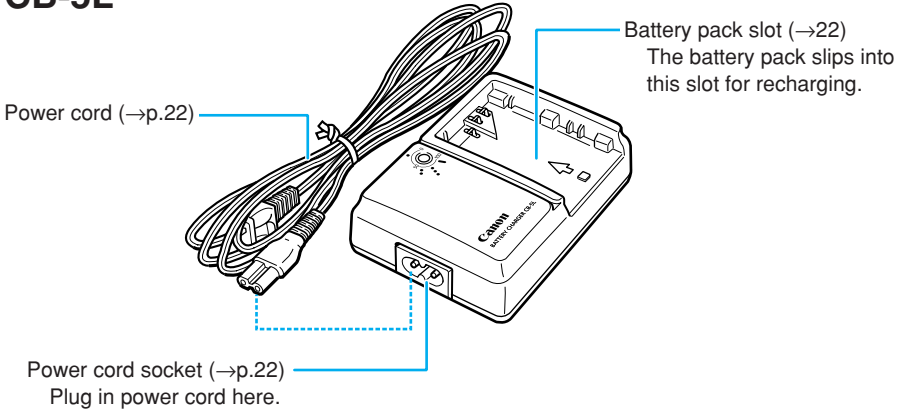

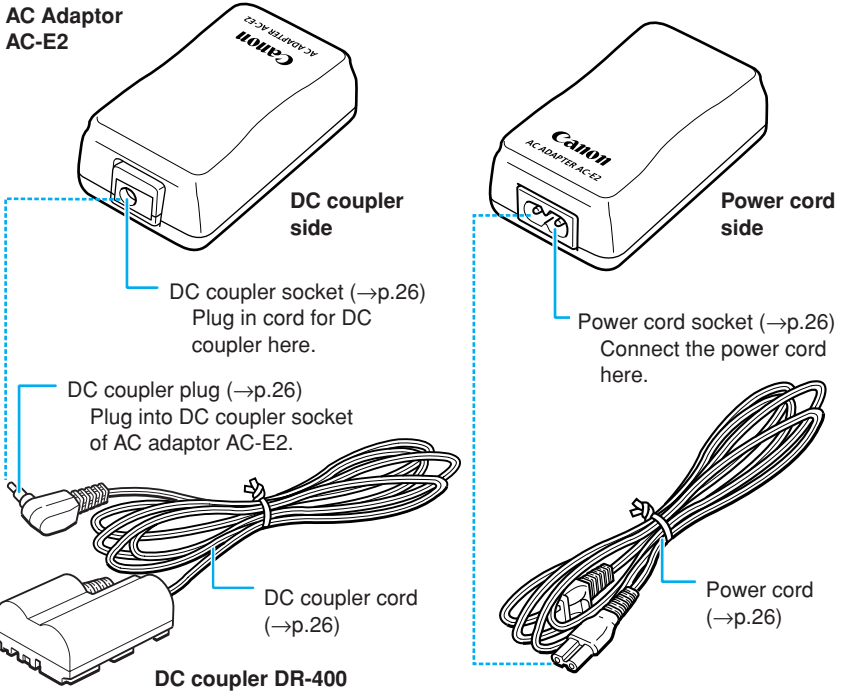

# AC Adaptor Kit ACK-E2 (optional)

AC Adaptor  
AC-E2



# Conventions Used in this Manual



- In the text, the  icon indicates the Main Switch. All operations described in this Instruction Manual assume that the  switch is already set to <ON>. Before proceeding with any operation, first turn the  switch to <ON>.

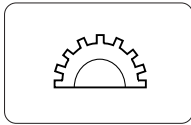

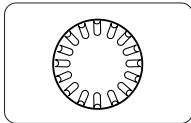

- The  icon indicates the Main Dial.



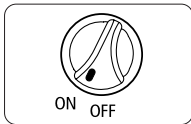







- The  icon indicates the Quick Control Dial.



- The  icon indicates the Quick Control Dial switch. Operations with the  dial assume that the  switch is already set to <ON>. Be sure it is set to <ON>.



- The  icon indicates the SET button, used to set menu functions and custom functions.

- The camera control icons and markings in this booklet correspond to the icons and markings on the camera. See “Nomenclature” on page 14.
- For more information, reference page numbers are provided in parentheses (→p.00).
- The procedures in these Instructions use a Canon EF 24-85mm f/3.5-4.5 USM lens for reference.
- The descriptions also assume that the menu functions and custom functions are set to the default settings.
- The icons ()4), ()6), and ()16) indicate that the function operates on a timer, and remains in effect after the button is released. The icons represent 4, 6, or 16 seconds respectively.
- In general, the pictures used for explaining procedures are taken with a single-lens reflex camera using 35mm film.
- These Instructions use the following alert symbols:
  -  : The Caution symbol indicates a warning to prevent shooting problems.
  -  : The Note symbol gives supplemental information.
  -  : The Light bulb symbol gives a helpful tip for operating your camera or shooting.
  -  : The Custom Function symbol indicates that there is a relevant Custom Function. For details, see “Custom Function Settings” on page 146.

This chapter explains a few preliminary steps and the basic operation of the EOS 10D camera.



# Before You Start

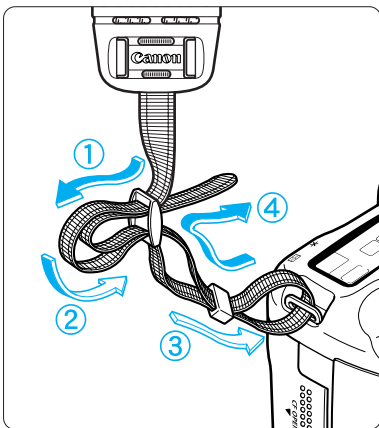

## Attaching the Strap

Pass the end of the strap through the strap mount from beneath, then back in and out of the strap clasp as shown. Pull the strap to make sure it does not slip out of the clasp.

- The eyepiece cover is attached to the strap. (→p.78)

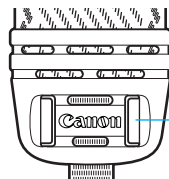

Eyepiece cover

# Recharging the Battery

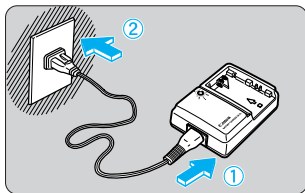

## 1 Connect the power cord.

- Connect the power cord to the charger.
- Connect the power plug to an AC outlet.

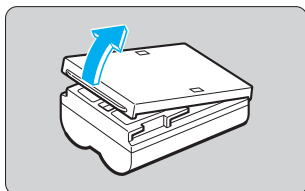

## 2 Remove the cover.

- Store the cover in a place where it will not be lost.
- If you remove the battery from the camera, be sure to reattach the cover to protect against short circuit.

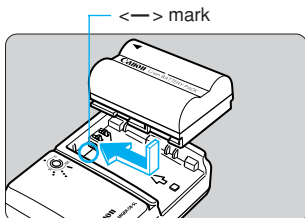

## 3 Attach the battery.

- Align the battery's top edge with the <--> mark on the charger. While pressing down the battery, slide it in the direction of the arrow.
- To detach the battery, follow the above procedure in reverse.

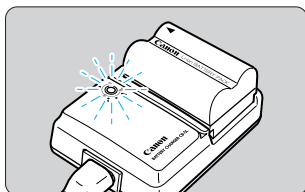

## 4 Recharge the battery.

- ▶ When the battery is attached to the charger, recharging starts automatically and the red lamp starts blinking.
- ▶ **A completely exhausted battery takes about 90 minutes to almost fully recharge.**
- The blinking frequency of the red lamp indicates the progress of the recharging.
- ▶ **After the battery recharging is almost completed, the red lamp will stop blinking and remain lit. Recharging the battery for another hour will fully recharge the battery.**
- After recharging the battery, detach it and unplug the power cord from the power outlet.

Battery charge	Red lamp
0–50%	Blinks once per second
50–75%	Blinks twice per second
Over 75%	Blinks three times per second
Almost full	Stays on



- Do not recharge any battery pack other than Battery Pack BP-511 or BP-512.
- The battery continues to discharge a low electrical current even while the camera is not used. This may lead to excessive battery discharge and a shorter battery service life.

When not using the camera, remove the battery and attach the protective cover to prevent shorting. Before using the camera again, be sure to recharge the battery.



- The time required to recharge the battery depends on the ambient temperature and battery's power level.
- If operating time is sharply reduced even after charging normally, the battery pack may have exceeded its useful life. Replace it with a new battery pack.
- The battery pack can operate in temperatures from 0°C to 40°C (32°F to 104°F), however for full operating performance, use between 10°C (50°F) and 30°C (86°F) is recommended. In cold locations such as ski areas, battery performance is temporarily decreased and operating time may be reduced.

# Installing and Removing the Battery

## Installing the Battery

Load a fully charged BP-511 battery pack into the camera.

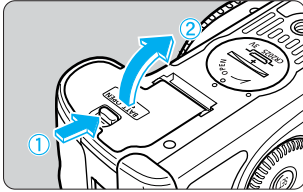

### 1 Open the battery compartment cover.

- Slide the lever in the direction shown by the arrow in the diagram, and open the cover.

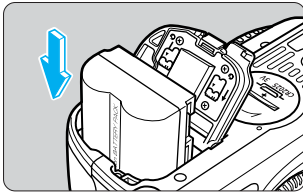

### 2 Insert the battery into the camera.

- Make sure the battery pack is facing the right way, and insert it into the battery compartment.
- Insert the battery pack until it locks into place.

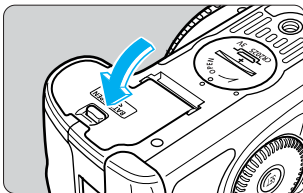

### 3 Close the cover.

- Press the cover closed until it clicks shut.



Battery Pack BP-512 can also be used.

## Battery Level Icons

The level of charge remaining is shown in three stages when the <☺> switch is set to <ON>. (→p.30)

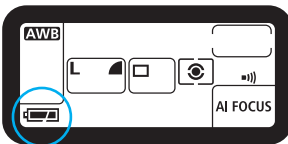

 : Charge is sufficient.

 : Charge is low.

 : Battery pack must be recharged.



## Battery Life

Temperature	Shooting conditions	
	No flash use	50% flash use
Normal (20°C/68°F)	Approx. 650	Approx. 500
Low (0°C/32°F)	Approx. 500	Approx. 400

- The figures above are based on Canon's standard testing conditions (w/fully charged battery, EF 50mm f/1.4 USM lens, image review [ON], review time of [2 sec.], and image quality at [Large ■])



- The number of shots may be less than indicated in some cases, due to differences in operating conditions.
- The number of shots is reduced by frequent use of the LCD monitor.
- Holding the shutter button halfway down for long periods to use the AF function without taking a shot can reduce the number of shots.
- Regarding the battery life (number of shots) with Battery Grip BG-ED3 (optional), refer to the BG-ED3's instructions.

## Removing the Battery

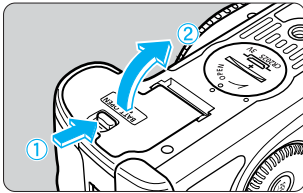

### 1 Open the battery compartment cover.

- Slide the lever in the direction shown by the arrow in the diagram, and open the cover.

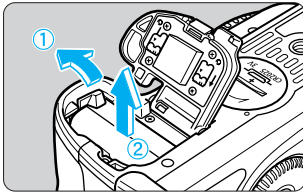

### 2 Remove the battery pack.

- Slide the battery lock lever in the direction shown by the arrow, and remove the battery.

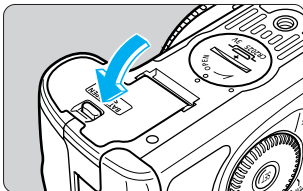

### 3 Close the cover.

- Press the cover closed until it clicks shut.

# Using a Household Power Supply

With AC Adapter Kit ACK-E2 (optional), you can connect the camera to a household power outlet. Then you do not have to worry about exhausting the battery while using the camera.

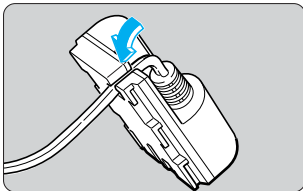

## 1 Place the cord in the groove.

- Carefully insert the cord into the groove without damaging it.

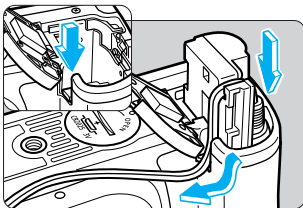

## 2 Insert the DC coupler into the camera.

- Open the cover and lower the covering on the cord hole.
- Insert the DC coupler and fit the cord into the cord hole.
- Check that the cord is placed tightly in the cord hole, and slide the DC coupler into the compartment until it locks into place.
- Push down the cover until it clicks.

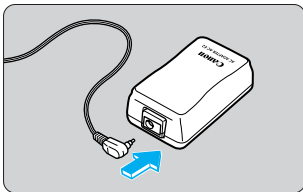

## 3 Connect the DC Coupler.

- Connect the DC Coupler's plug to the AC adapter's socket.

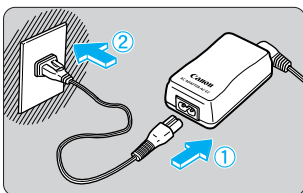

## 4 Connect the power cord.

- Connect the power cord to the AC adapter.
- Plug the cord into a power outlet.
- When you are finished, remove the plug from the power outlet.



- Do not connect or disconnect the power cord while the camera's  switch is set to <ON> .
- Do not use the DC coupler with any camera other than the EOS 10D, D60, and D30.

# Mounting and Detaching a Lens

## Mounting a Lens

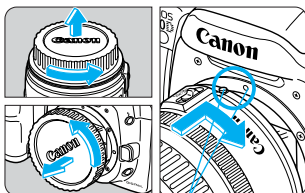

Lens mount index

1

### Remove the caps.

- Remove the rear lens cap and the body cap by turning them as shown by the arrow.

2

### Attach the lens.

- Align the red dots on the lens and camera and turn the lens as shown by the arrow until it snaps in place.

3

### On the lens, set the focus mode switch to <AF>.

- If the focus mode switch is set to <MF> (or <M> on older lenses), autofocus will not operate.

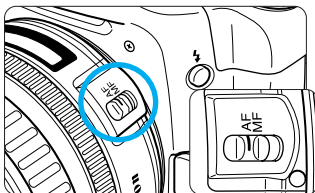

4

### Remove the front lens cap.

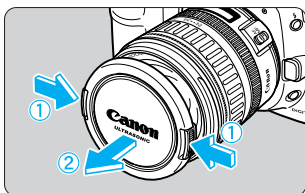

## Detaching the Lens

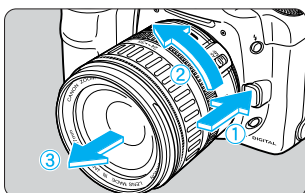

### While pressing the lens release button, turn the lens as shown by the arrow.

- Turn the lens until the red dot is at the top, then detach the lens.



- Since the EOS 10D's image coverage is smaller than the normal 35mm film format, the EF lens attached to the camera will have a telephoto effect equivalent to 1.6 times of the marked focal length.
- **AF** stands for autofocus.
- **MF** or **M** stands for manual focus.
- Be careful not to lose the lens caps or body cap.

EOS 10D image field  
(22.7 x 15.1 mm / 0.89 x 0.59 in)

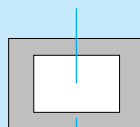

35 mm image field  
(36 x 24 mm / 1.42 x 0.94 in)

# Installing and Removing the CF Card

The captured image will be recorded onto the CF card (optional).  
The camera is compatible with Type I and Type II CompactFlash (CF) cards.

## Installing a CF Card

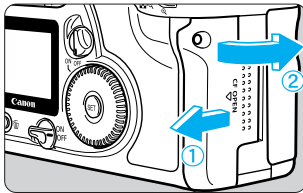

### 1 Open the cover.

- Slide the cover in the direction shown by the arrow, and open it.

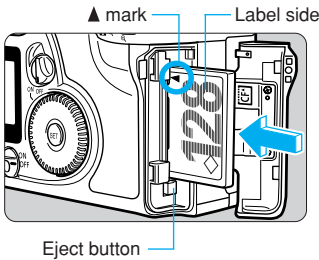

### 2 Insert the CF card.

- Using CF cards made by Canon is recommended.
- With the CF card label side (the side with the printed ▲ mark) facing toward the rear of the camera, slide the card in the direction of the ▲ mark, into the slot.
- ▶ The Eject button pops out.

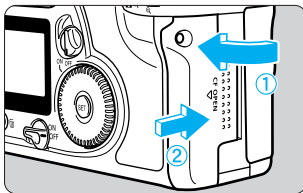

### 3 Close the cover.

- Close the cover and slide it in the direction shown by the arrow until it clicks shut.
- ▶ When you set the <Ⓢ> switch to <ON>, the number of remaining shots will be displayed on the LCD panel and in the viewfinder.

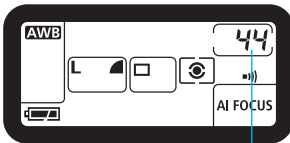

Number of remaining shots



The number of remaining shots depends on the remaining capacity of the CF card and the ISO speed setting.

## Removing the CF Card

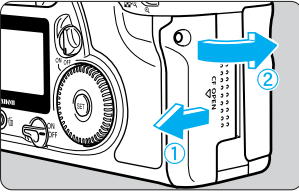

### 1 Open the cover.

- Set the <☺> switch to <OFF>.
- Check that the “busy” message is not shown on the LCD panel.
- Make sure the access lamp is off (→p.15), and open the cover.

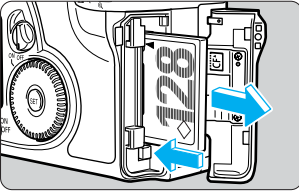

### 2 Remove the CF card.

- Press the Eject button.
- ▶ The CF card is ejected.
- Close the cover.



- While the access lamp is blinking (“busy” is displayed in the viewfinder and on the LCD panel), do not:
  - Shake or hit the camera.
  - Open the CF card slot cover.
  - Remove the battery.

#### This is to prevent damage to the image data, CF card, or camera.

- The menu cannot be used during image processing after image capture and while the image is being recorded onto the CF card (access lamp blinks). If you press the <MENU> or <▶> button during this time, “busy” will be displayed on the LCD monitor.
- If a CF card is used for the first time or “Err LF” is displayed on the LCD panel, see “Formatting a CF Card” on page 119 to format the card.
- Do not use a low-capacity CF card. If the image file size is large, the CF card may not be able to save the image.
- A microdrive is a recording medium using a hard disk. It has a large capacity and the price per megabyte is low. However, compared to a CF card equipped with a flash memory, it is vulnerable to vibration and physical shock. If you use a microdrive, be careful not to subject the camera to vibration, shake, or physical shock while it is recording or displaying images.

# Basic Operation

## Main Switch

The camera operates only after the  switch is set to <ON>.

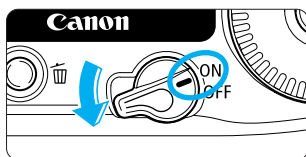

<ON> : Set to this position when the camera is in use.

<OFF> : The camera does not operate.  
Set to this position when not using the camera.



- To save battery power, the camera turns off automatically after 1 minute of non-operation (auto power off / →p.142). To turn on the camera again, just press the shutter button halfway.
- Immediately after shooting, if you turn the  switch to <OFF>, the access lamp may continue blinking for a few seconds while the CF card records the image. After the image is recorded in the CF card, the access lamp will turn off and the camera will turn off.

## Shutter Button

The shutter button has two stages. You can press it down halfway or fully. The two levels of shutter button operation are as follows:

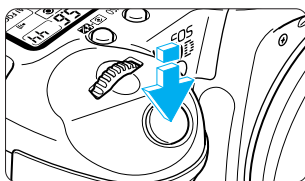

### Halfway pressing ( )

Pressing the shutter button down halfway activates autofocus (AF), and also activates the automatic exposure mechanism and sets the shutter speed and aperture value.

The exposure (the combination of shutter speed and aperture value) appears on the LCD panel and in the viewfinder.

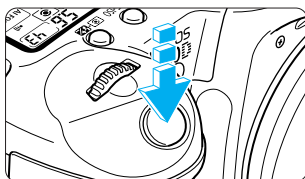

### Full pressing

This releases the shutter and shoots.



If you press the shutter button halfway and (  ) elapse, press it halfway again and wait a moment before pressing it fully to shoot. If you press the shutter button fully without pressing it halfway first or if you press the shutter button halfway and then press it fully immediately, the camera will still take a moment before it shoots.



No matter what state the camera is in (image playback, menu operation, image recording, etc., except during direct printing), pressing the shutter button halfway will instantly make it ready for shooting.

## Using the Electronic Dials

The or dial is for setting shooting settings and selecting and setting menu items. For dial operations, first turn the switch to <ON>. There are two ways to operate the electronic dial as described below.

### Operating the Dial

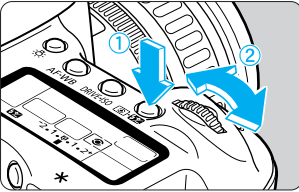

#### (1) Press a button and turn the dial.

When you press a button, its function remains active while a timer ( 6) runs. During this time you can turn the dial and view the settings on the LCD panel. When the timer runs out or you press the shutter button down halfway, the camera is ready to shoot.

- You can select or set the AF point, AF mode, drive mode, and metering mode.
- While looking at the LCD monitor, you can select a menu item, recorded image, etc.

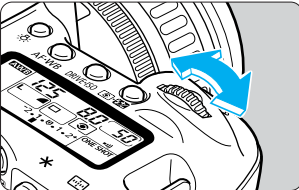

#### (2) Just turn the dial.

While referring to the LCD panel or viewfinder display, turn the dial to set the desired setting.

- Use the dial this way to set the shutter speed and aperture value.

### Operating the Dial

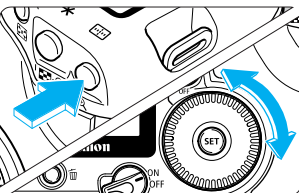

#### (1) Press a button and turn the dial.

When you press a button, its function remains active while a timer ( 6) runs. During this time you can turn the dial and view the settings on the LCD panel. When the timer runs out or you press the shutter button down halfway, the camera is ready to shoot.

- You can select the AF point or set the white balance, ISO speed, and flash exposure compensation.
- While looking at the LCD monitor, you can select a menu item, recorded image, etc.

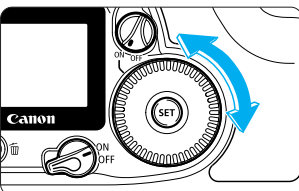

#### (2) Just turn the dial.

While looking at the LCD panel or viewfinder display, turn the dial to set the desired setting.

- In this way, you can set the exposure compensation amount, <M> mode aperture, etc.

# Menu Operations

The on-screen menus enable you to set various settings such as the image-recording quality, date and time, Custom Functions, etc. While looking at the LCD monitor, press the <MENU> button on the back of the camera and turn the <◀> or <▶> dial. Then press the <SET> button.

For details on the various menu settings, see “Menu Settings” on page 139.

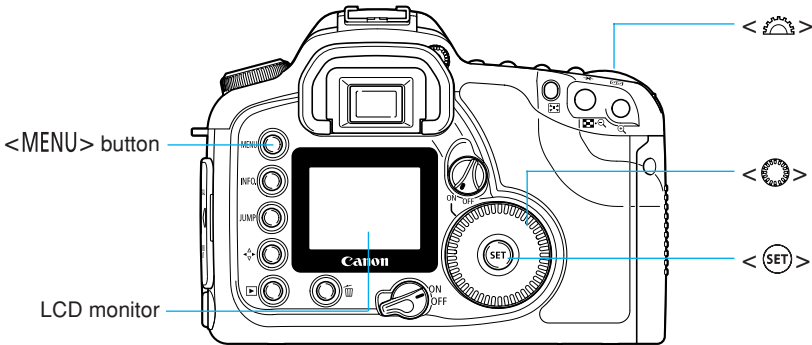

## Menu Screen

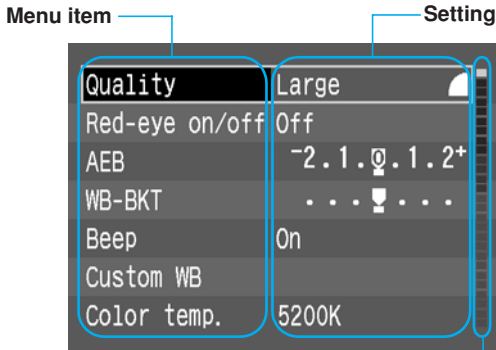

### Color-coded menu items

The menu items are color-coded according to the three menu categories. The menu item's border color matches the respective menu category.

Color	Setting type	Description
Red	Shooting	Menu items related to shooting.
Blue	Playback	Menu items related to playing back recorded images.
Yellow	Setup	Menu items related to basic camera functions.



## Setting Procedure

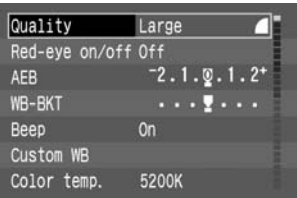

### 1 Display the menu.

- Press the <MENU> button to display the menu. To turn off the menu, press the button again.

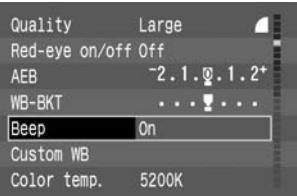

### 2 Select a menu item.

- Turn the <Q> dial to select the item, then press <SET>.

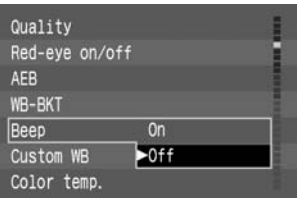
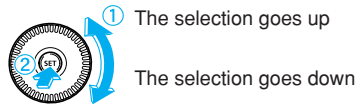

### 3 Select the desired setting.

- Turn the <Q> dial to select the desired setting.

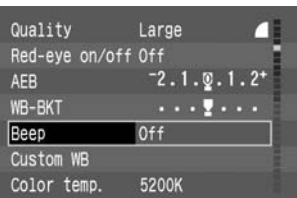
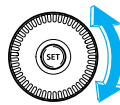

### 4 Set the desired setting.

- Press <SET>.



### 5 Exit the menu.























- Press the <MENU> button to exit.



- Even while the menu is displayed, you can immediately go back to shooting mode by pressing the shutter button halfway.
- You can use either the <Q> or <Z> dial for the menu item selection, image playback, direct printing, and printing specification.
- To exit, press the shutter button halfway.
- The menu items and menu settings follow a looping sequence during the selection.
- The menu can be displayed in one of twelve languages. (→p.143)
- Pressing the <JUMP> button while the menu is displayed switches the menu category to shooting, playback, or setup (in this order). The first menu item of the respective category will appear.

## Menu Selections and Default Settings

 : Default setting

	Menu item	Settings and Description				Ref. page	Note
Shooting (Red)	Quality	Large 	Large 	Medium 	Medium 	46	
		Small 	Small 	RAW *1			
	Red-eye on/off	Off		On		99	#2
	AEB						
							
	WB-BKT						
							
	Beep	On		Off		140	
	Custom WB	Set custom white balance				52	#1
	Color temp.	2800 K - 10000 K in 100 K increments				53	#1
Parameters	Standard		Adobe RGB		56	#1	
	Set 2		Set 3				
			Set up				
ISO expansion	Off		On		141	#1	
Playback (Blue)	Protect	Protects the image from erasure				116	
	Rotate	Rotate recorded image				114	
	Print Order	Order print of recorded image (DPOF)				131	
	Auto play	Plays the images automatically				113	
Setup (Yellow)	Auto power off	1 min.		2 min.		4 min.	
		8 min.		15 min.		30 min.	
		Off					
	Review	Off		On		On (Info)	
	Review time	2 sec.		4 sec.			
		8 sec.		Hold			
	Auto rotate	On		Off		61	
	LCD Brightness						
							
	Date/Time	mm/dd/yy		dd/mm/yy		yy/mm/dd	
	File numbering	Continuous		Auto reset		59	
	Language	English		Deutsch		Français	
		Nederlands		Dansk		Suomi	
		Italiano		Norsk		Svenska	
		Español		汉语		日本語	
	Video system	NTSC		PAL		144	
Format	Format CF card				119		
Custom Functions (C.Fn)	Custom Function settings				146	#1	
Clear settings	Clear all camera settings		Clear all Custom Functions		144	#1	
Sensor clean	Turn off the camera after sensor cleaning				156	#1	
Firmware Ver.	Camera's Firmware version.				144		

\*1: Does not appear in the menu when the Basic zone (→p.37) is selected.

\*2: Does not appear in the menu in <img alt="Red eye icon" data-bbox="205 935 225 949"/>, <img alt="AEB icon" data-bbox="235 935 255 949"/> and <img alt="WB-BKT icon" data-bbox="285 935 305 949"/> modes.

## LCD Monitor

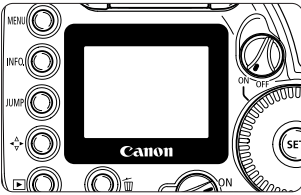

The color LCD monitor on the back of the camera enables you to review and select recorded images and set various menu settings.

- With the LCD monitor, you can use the  $\langle \text{O} \rangle$  dial even while the  $\langle \text{O} \rangle$  switch is <OFF>.
- The LCD monitor cannot be used as a viewfinder to shoot.
- The LCD monitor's brightness can be set to one of five levels. (→p.143)

1

Before You Start

## Reverting to the Default Settings

### 1 On the menu, select [Clear settings].

- Press the <MENU> button.
- Turn the  $\langle \text{O} \rangle$  dial to select [Clear settings], then press  $\langle \text{SET} \rangle$ .

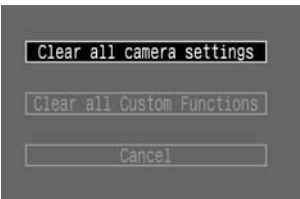

### 2 Select [Clear all camera settings].

- Turn the  $\langle \text{O} \rangle$  dial to select [Clear all camera settings], then press  $\langle \text{SET} \rangle$ .



### 3 Clear the settings.

- Turn the  $\langle \text{O} \rangle$  dial to select [OK], then press  $\langle \text{SET} \rangle$ .
- Press the <MENU> button to turn off the LCD monitor and exit the menu.
- ▶ The camera's default settings will be as shown below.

#### Shooting Settings

AF mode	One-Shot AF
AF point selection	Automatic
Metering mode	Evaluative
Drive mode	Single frame
Exposure compensation	0 (Zero)
AEB	Canceled
Flash exposure compensation	0 (Zero)
Custom Functions	Settings retained

#### Image Recording Settings

Quality	L $\blacksquare$ (Large/Fine)
ISO speed	100
White balance	AWB (Auto)
Color temp.	5200K
WB-BKT	Canceled
Parameters	Standard
Auto rotate	On
File numbering	Continuous

# Dioptric Adjustment

By adjusting the diopter to suit your eyesight (with or without eyeglasses), the viewfinder image will look clearer. The camera's adjustable dioptic range is  $-3$  to  $+1$  dpt.

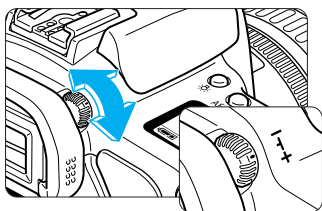

## Turn the dioptic adjustment knob.

- Turn the knob left or right so that the AF points in the viewfinder look sharp.
- The illustration shows the knob at the standard setting ( $-1$  dpt).



If the camera's dioptic adjustment still cannot provide a clear viewfinder image, using Dioptic Adjustment Lens E (10 types) is recommended. (→p.174)

# Holding the Camera

To obtain sharp images, hold the camera still to minimize camera shake.

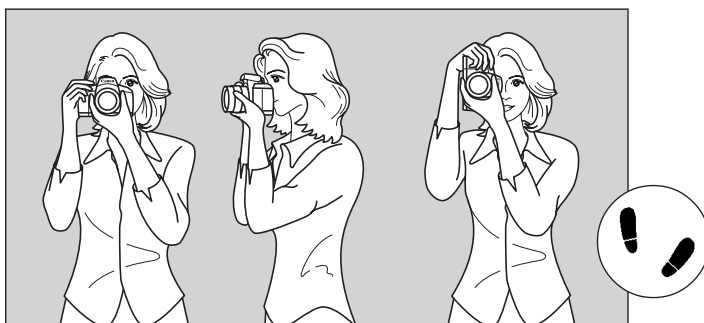

Horizontal shooting

Vertical shooting

- Firmly grasp the camera grip with your right hand, and press your both elbows lightly against your body.
- Hold the lens at the bottom with your left hand.
- Press the camera against your face and look through the viewfinder.
- To maintain a stable stance, place one foot in front of the other instead of lining up both feet.

This chapter describes how to use the camera's Basic Zone modes <O> <P> <A> <S> <L> <M> <B> for quick and easy shooting. In these modes, all you do is point and shoot.

In addition, to help prevent mistakes caused by operating the camera improperly, the <AF-WB> <ISO> <M> <A> <M> buttons do not operate so there is no need to worry about accidental errors.

# Fully Automatic Shooting

Basic Zone modes set all the camera settings automatically. All you do is point and shoot.

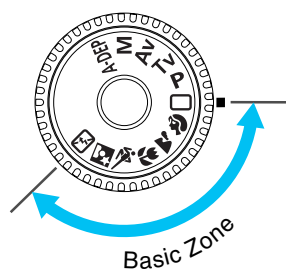

**Set the Mode Dial to <O> <P> <A> <S> <L> <M> or <B>.**

- The shooting procedure is the same as with the “<O> Full Automatic Shooting” on page 38.

# □ Fully Automatic Shooting

You can easily and confidently capture any subject, with no need to do anything but press the shutter button. The Canon EOS 10D can capture subjects at any of seven AF points, so that anybody can take great shots easily.

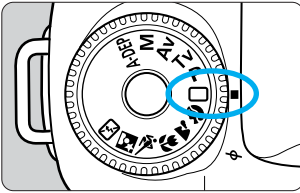

## 1 Turn the Mode dial to <□>.

- The <AI FOCUS> AF mode, <□> (single drive mode, <□> metering mode, “Auto” ISO speed, and <AWB> white balance will be set automatically.
- One of six image-recording quality settings (except RAW) can be selected. (→p.46)

## 2 Focus the subject.

- Look through the viewfinder and aim any AF point over the subject. Then press the shutter button halfway.
  - ▶ The AF point that achieves focus will flash briefly. At the same time, the beeper will sound and the focus confirmation light <●> in the viewfinder will light.
  - ▶ The exposure settings will be displayed in the viewfinder and on the LCD panel.
- The number “9” - “9” displayed on the left of the focus confirmation light <●> indicates maximum burst for continuous shooting.
- If the CF card is almost full and has room for nine or fewer shots, the remaining number of shots that can fit on the card will be displayed by “[9]” to “[9]”.

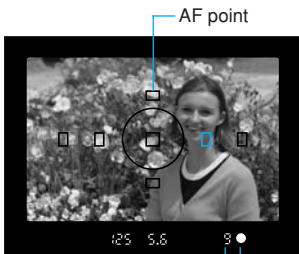

Maximum burst  
Focus confirmation light

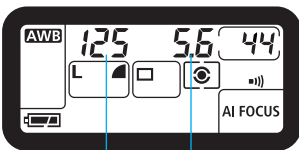

Shutter speed      Aperture

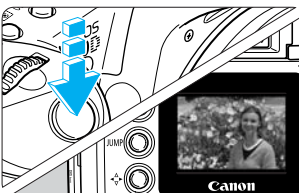

## 3 Shoot.

- Compose the shot and check that the exposure settings are not blinking. Then press the shutter button fully to shoot.
  - ▶ The captured image will be displayed for 2 sec. on the LCD monitor.



- If the CF card becomes full, the CF Full message “FULL CF” appears on the LCD panel and in the viewfinder, and the camera will not shoot any more. Replace the CF card with another CF card that has capacity available.
- When the focus confirmation light <●> is blinking, the camera will not shoot. (→p.71)
- If the automatic pop-up of the built-in flash is obstructed accidentally, error code “Err 05” will appear on the LCD panel. If this happens, set the <☞> switch to <OFF> and <ON> again.



- The focus and exposure are locked when AF focusing is complete.
- The camera automatically focuses on the AF point that is on the subject closest to the camera.
- If multiple AF points flash in red, it means that all of them have achieved focus at the respective points.
- To focus on a subject that is not at any of the seven AF points, see “Focusing an Off-Center Subject” (→p.65).
- In the Basic Zone modes (except <📷> <📷> <📷>), the built-in flash will pop up and fire automatically in low-light or backlit conditions. To retract the flash, push it back down. For more information on the flash, see “Using the Built-in Flash” on page 96.
- The self-timer can also be used. (→p.77)
- You can set the beep that indicates the subject is in focus or the beep that indicates the self-timer is operating to [On] or [Off]. (→p.140)
- The LCD panel can be illuminated. (→p.94)

## AF-Assist Beam with the Built-in Flash

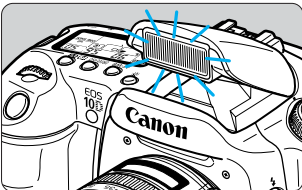

Under low-light conditions, the built-in flash fires a brief burst of flashes when you press the shutter button halfway. This is to illuminate the subject to enable easier autofocusing.



- The AF-assist beam does not function in the <📷> <📷> <📷> modes.
- The built-in flash’s AF-assist beam is effective up to about 4 meters/13.2 feet.
- In the Creative Zone modes when the built-in flash is popped up with the <📷> button, the AF-assist beam may be emitted.

# Programmed Image Control Modes

Select a shooting mode to suit the target subject, and the camera will be set to obtain the best results.



## Portrait



This mode blurs the background to make the human subject stand out.

- Holding down the shutter button executes continuous shooting.
- To improve the background blur, use a telephoto lens and fill the frame with the subject or have the subject stand farther away from the background.
- The <ONE SHOT> AF mode, <□> (continuous) drive mode, <☉> metering mode, “Auto” ISO speed, and <AWB> white balance will be set automatically.



## Landscape



This is for wide scenic views, night scenes, etc.

- Using a wide-angle lens will further enhance the depth and breadth of the image.
- The <ONE SHOT> AF mode, <□> (single) drive mode, <☉> metering mode, “Auto” ISO speed, and <AWB> white balance will be set automatically.



## Close-up



Use this mode to take close-up shots of flowers, insects, etc.

- As much as possible, focus the subject at the lens' closest focusing distance.
- To obtain a larger magnification, use the telephoto end of a zoom lens.
- For better close-ups, an EOS-dedicated macro lens and Macro Ring Lite (both optional) are recommended.
- The <ONE SHOT> AF mode, <□> (single) drive mode, <☉> metering mode, “Auto” ISO speed, and <AWB> white balance will be set automatically.





## Sports



This is for sports and fast-moving subjects when you want to freeze the action.

- The camera will first track the subject with the center AF point. Focus tracking will then continue with any of the seven AF points covering the subject. When focus is achieved, the beeper will sound softly.
- While you hold down the shutter button, focusing will continue for continuous shooting.
- The <AI SERVO> AF mode, <[continuous drive mode icon]> (continuous) drive mode, <[metering mode icon]> metering mode, “Auto” ISO speed, and <AWB> white balance will be set automatically.



## Night Portrait



This mode is for shooting of people at twilight or at night. The flash illuminates the subject while a slow sync speed capture a natural-looking exposure of the background.

- If you want to shoot only a night scene (without people), use the <[night scene mode icon]> mode instead.
- Tell the subject to keep still even after the flash fires.
- If you also use the self-timer (→p.77), the self-timer lamp will flash to indicate that the image was recorded.
- The <ONE SHOT> AF mode, <[single drive mode icon]> (single) drive mode, <[metering mode icon]> metering mode, “Auto” ISO speed, and <AWB> white balance will be set automatically.



## Flash off



You can disable the flash when you do not want it to fire.

- The built-in flash or any external Speedlite will not fire.
- The <AI FOCUS> AF mode, <[single drive mode icon]> (single) drive mode, <[metering mode icon]> metering mode, “Auto” ISO speed, and <AWB> white balance will be set automatically.



- If the shutter speed indicator blinks, the shutter speed may be too slow to keep the image from being blurred by camera shake. Be careful to hold the camera steady and press the shutter button smoothly, or use a tripod. (The shutter speed indicator still blinks when you use a tripod, but camera shake will not be a problem.)
- In the <[Flash off mode icon]> mode, use a tripod to prevent camera shake.

# MENU Reviewing Images

## Image Review

The image can be displayed on the LCD monitor immediately after you shoot. You can set one of three image review options: **[On]** to display the image, **[On (Info)]** to display both the image and shooting information, and **[Off]** to not display the image.

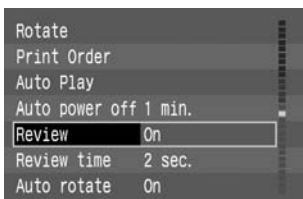

### 1 On the menu, select **[Review]**.

- Press the <MENU> button.
- Turn the <○> dial to select **[Review]**, then press <SET>.

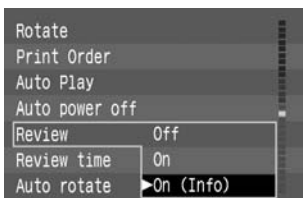

### 2 Set the Review setting.

- Turn the <○> dial to select the desired setting, then press <SET>.
- ▶ The menu will reappear.
- Press the <MENU> button to exit the menu and turn off the LCD monitor.

### 3 Shoot.

- ▶ The captured image will be displayed on the LCD monitor.
- The image will be displayed for the number of seconds set with **[Review time]**.

Review **[On]** setting



Review **[On (Info)]** setting (→p.109)

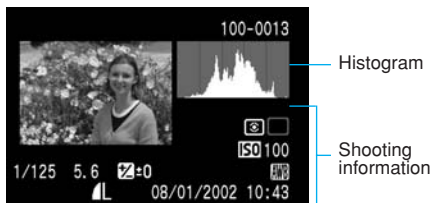

- You can also change the number of seconds the image is displayed (review time).
- For continuous shooting, the captured images will be displayed in succession automatically after image processing. If the <▶> button is pressed during that time, **[Busy...]** will be displayed.

## Changing the Review Time

You can set the image review time to [2 sec.], [4 sec.], [8 sec.], or [Hold] which keeps the image displayed on the LCD monitor.

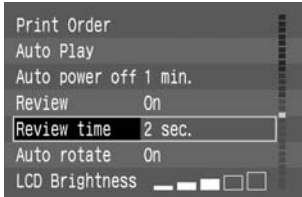

### 1 On the menu, select [Review time].

- Press the <MENU> button.
- Turn the <O> dial to select [Review time], then press <SET>.

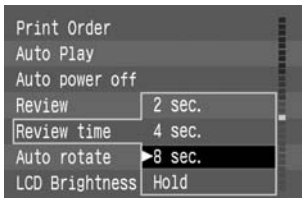

### 2 Set the Review time setting.

- Turn the <O> dial to select the desired setting, then press <SET>.
- ▶ The menu will reappear.
- Press the <MENU> button to exit the menu and turn off the LCD monitor.



- The [Hold] setting keeps displaying the image until you press the shutter button halfway. However, if auto power off has been set (→p.142), the camera will turn off automatically after the auto power off time elapses.
- The [Review time] takes effect only when the [Review] setting is [On] or [On (Info)].
- For continuous shooting, the [Review time] will apply to the last shot.
- To delete the displayed image, press the <W> button and turn the <O> dial to [OK]. Then press <SET>.
- To view images captured previously, see “Playback Images.” (→p.107)



This chapter explains the settings for shooting digital images: Image-recording quality, ISO speed, white balance, processing parameters, color space, file numbering, and auto rotation.

# 3 Settings for Shooting

For Basic Zone modes, only the image-recording quality (except <RAW>), file numbering, auto rotation, and camera setting checking will apply in this chapter.

# MENU Image-Recording Quality

You can select one of seven image-recording quality settings. (For the Basic Zone modes, <RAW> is not selectable.)

Images recorded in the <L> <L> <M> <M> <S> or <S> mode do not require image processing. However, <RAW> images to be processed with a personal computer.

## 1 On the menu, select [Quality].

- Press the <MENU> button.
- Turn the <Q> dial to select [Quality], then press <SET>.

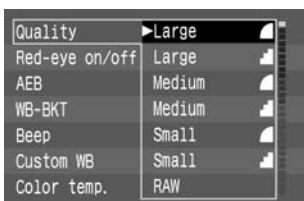

## 2 Select the image-recording quality.

- Turn the <Q> dial to select the desired image-recording quality, then press <SET>.
- ▶ The menu will reappear.
- Press the <MENU> button to exit the menu and turn off the LCD monitor.



### Large/Fine

Records a 6.3-megapixel image with low-compression JPEG. It saves the JPEG image with the highest image quality. Note that due to the large file size, fewer images can be recorded on the CF card.



### Large/Normal

Records a 6.3-megapixel image with high-compression JPEG. It saves the JPEG image with a relatively high image quality while enabling more images to be recorded on the CF card.



### Medium/Fine

Converts the approx. 6.30-megapixel image to a 2.80-megapixel image and saves it as a JPEG image via low compression. While the JPEG images have medium image quality, a reasonable number of images can be recorded on the CF card.



### Medium/Normal

Converts the approx. 6.30-megapixel image to a 2.80-megapixel image and saves it as a JPEG image via high compression. This mode enables more images than the <M> mode to be recorded on the CF card.



### Small/Fine

Converts the approx. 6.30-megapixel image to a 1.60-megapixel image and saves it as a JPEG image via low compression. Use this mode when the image size is less important than being able to record more images on the CF card.



### Small/Normal

Converts the approx. 6.30-megapixel image to a 1.60-megapixel image and saves it as a JPEG image via high compression. Use this mode when you want to record a maximum number of images on the CF card.



### RAW

Records the image with lossless compression resulting in about 6.3 megapixels. Use this mode when you want to use a personal computer to process the image afterward. Due to the large file size, fewer images can be recorded on the CF card.

## Processing

Processing is the alteration of the raw image data captured with the camera's CMOS image sensor. For example, the digital image's white balance and image quality can be altered. Images recorded in the <L> <L> <M> <M> <S> or <S> mode undergo processing by the camera before being saved as a JPEG image. <RAW> images are processed according to the white balance and processing parameters set at the time of shooting. A <RAW> image can be processed repeatedly using the provided software.

### Image File Size and CF Card Capacity According to Image-Recording Quality

Image-Recording Quality	Image Size (Pixels)	Format	Compression Rate	Image File Size (Approx.)	Max. Capacity (Approx.)
L Large/Fine	3072 x 2048 (Approx. 6.3 million)	JPEG	Low	2.4 MB	50 images
L Large/Normal			High	1.2 MB	103 images
M Medium/Fine	Low		1.3 MB	95 images	
M Medium/Normal	High		0.7 MB	184 images	
S Small/Fine	1536 x 1024 (Approx. 1.6 million)		Low	0.8 MB	145 images
S Small/Normal			High	0.4 MB	282 images
RAW RAW	RAW : 3072 x 2048 (Approx. 6.3 million)	RAW + JPEG	RAW : Lossless compression RAW	6.0 MB	19 images
				6.4 MB	18 images
				6.2 MB	18 images
				6.8 MB	16 images
				6.7 MB	17 images
				8.0 MB	14 images

- The image-recording quality (except <RAW>) can also be set in the Basic Zone modes.
- The image file size and CF card's maximum capacity are based on Canon's testing standards (at ISO 100 with [Standard] parameter settings).
- The maximum capacity applies to a 128 MB CF card.
- The image file size and the CF card's maximum capacity varies depending on the subject, shooting mode, ISO speed, and processing parameters.
- On the LCD panel, you can check how many more images the CF card can record.
- In the <RAW> mode, a JPEG image is also recorded simultaneously and embedded within the RAW image.
- The image-recording quality will be memorized in Basic Zone mode and Creative Zone mode respectively.

To open RAW images with a personal computer or to extract the JPEG image embedded in the RAW image file, you must use the dedicated software. For details, see "EOS 10D Software Instructions."

- With C.Fn-08, the image-recording quality of the JPEG image recorded simultaneously within the RAW image file can be changed. (→p.148)
- With C.Fn-01-1, you can set the [Quality] by pressing <SET> and turning the <Q> dial. (→p.146)

# MENU Simultaneous Capture in RAW and JPEG Formats

In the <RAW> image-recording quality mode, a JPEG image is recorded simultaneously and embedded within the RAW image file. With C.Fn-08 [RAW+JPEG rec.], you can set the image-recording quality of this JPEG image. To extract the JPEG image embedded in the RAW image file, you will need the dedicated software.

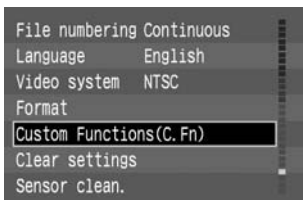

## 1 On the menu, select [Custom Functions (C.Fn)].

- Press the <MENU> button.
- Turn the <Q> dial to select [Custom Functions (C.Fn)], then press <SET>.
- ▶ The Custom Function screen will appear.

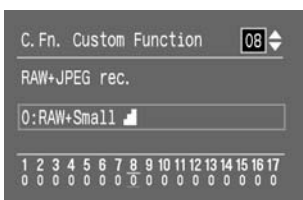

## 2 Select C.Fn-08 [RAW+JPEG rec.].

- Turn the <Q> dial to select [RAW+JPEG rec.], then press <SET>.

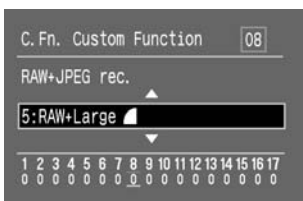

## 3 Select the image-recording quality for the JPEG image.

- Turn the <Q> dial to select the desired image-recording quality, then press <SET>.
- Press the <MENU> button to return to the menu.
- Press the <MENU> button again to turn off the LCD monitor.
- When the [Quality] is set to <RAW>, a JPEG image will be recorded simultaneously with the set quality and embedded within the RAW image file.



To extract the JPEG image embedded in the RAW image file, use the dedicated software. For details, see “EOS 10D Software Instructions.”









# ISO Setting the ISO Speed

The ISO speed is a numeric indication of the sensitivity to light (→p.158). A higher ISO speed number indicates a higher sensitivity to light. Therefore, a high ISO speed is suited for moving subjects or shooting in low-light conditions. However, the image will contain more noise to make it look coarse or grainy. On the other hand, a low ISO speed will make the image look finer, but it is not suited for freezing motion or shooting in low light.

## ISO Speed in the Basic Zone Modes

The ISO speed is set automatically.

(ISO)

							
Normal (No flash)	Varies*	100	Varies*	Varies*	400	Varies*	Varies*
With built-in flash	400**	100	—	400**	—	400**	—
With external Speedlite	100	100	100	100	400	100	—

\* Automatically set within ISO 100-400. \*\* For daytime backlit conditions, ISO 100 is set.

## ISO Speed in the Creative Zone Modes

You can set the ISO speed to “100”, “200”, “400”, “800”, or “1600”. If the menu’s [ISO expansion] is set to [On], you can also set “M” (ISO 3200).

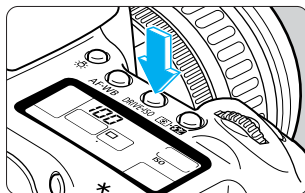

### 1 Press the <DRIVE-ISO> button. ( )

- ▶ The current ISO speed will be displayed on the LCD panel.
- In the Basic Zone modes, “*Auto*” will be displayed on the LCD panel.

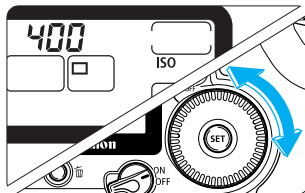

### 2 Set the ISO speed.

- While looking at the LCD panel, turn the <O> dial to set the desired ISO speed.
- To return to shooting, press the shutter button halfway.



- The higher the ISO speed and the higher the ambient temperature, the more noise the image will contain and the larger the image file size will be. Therefore, fewer images can be recorded on the CF card. On the LCD panel, you can check how many more images the CF card can hold. (→p.16)
- High temperatures, high ISO speeds, or long exposures may cause irregular colors in the image.



In step 2, turning the < > dial will set the drive mode. (→p.76)

# WB Selecting the White Balance

The following white balance settings are provided: Auto, daylight, shade, cloudy, tungsten, fluorescent, flash, custom and color temperature.

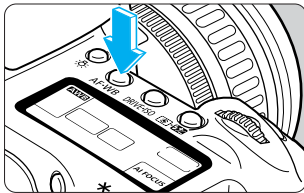

**1** Press the **<AF-WB>** button. ( 06)

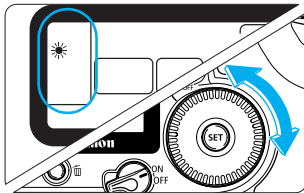

**2** Select the white balance setting.

- While looking at the LCD panel, turn the **<WB>** dial to select the desired white balance setting.
- To return to shooting, just press the shutter button halfway.

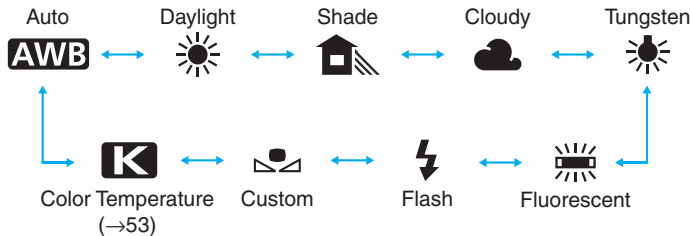

- In the Basic Zone modes, **<AWB>** will be set automatically.
- In step **2**, turning the **<WB>** dial will select the AF mode. (→p.64)









## White Balance

The three R (red), G (green), and B (blue) primary colors exist in varying proportions in a light source depending on its color temperature. When the color temperature is high, there is more blue. And when the color temperature is low, there is more red. As the color temperature increases from low to high, the color cast changes in the following sequence: red, orange, yellow, white, and bluish white. For example, if you have a white object under a lit tungsten light bulb, it will look red or orange in the image. If it is under fluorescent light, it will look greenish.

To the human eye, a white object still looks white regardless of the type of lighting. The human eye is highly adaptive to different types of lighting and color temperatures. With a film-based camera, you can attach a color compensation filter to the lens or use tungsten film to compensate for the color cast caused by the light source's color temperature. With a digital camera's white balance setting, you can digitally compensate (based on a standard white color) the color temperature so that the colors in the image look more natural.

The camera's **<AWB>** feature uses the image sensor to set the white balance.

# White Balance Settings

Icon	Application	Color Temperature (Kelvin)
	The camera sets the white balance automatically.	Approx. 3000-7000 K
	For sunny daylight outdoors.	Approx. 5200 K
	For shaded areas outdoors.	Approx. 7000 K
	For cloudy or hazy days and during sunsets.	Approx. 6000 K
	For tungsten (light bulb) light.	Approx. 3200 K
	For fluorescent light.	Approx. 4000 K
	When flash is used.	Approx. 6000 K
	First you shoot a white object to be used as the standard for the white balance setting. By using the white balance data from this image, you can set the optimum white balance. (→p.52)	Approx. 2000-10000 K
	You can manually set color temperature for 2800-10000 K (in 100 K increments). (→p.53)	Approx. 2800-10000 K



With <AWB> selected, shooting under a low color temperature such as tungsten light may result in a warm, orange color cast. If you cannot obtain the desired effect, set the white balance to <☼> or set the color temperature manually. (→p.53)

# MENU Custom White Balance

With custom white balance, you shoot a white object that will serve as the standard for the white balance. By selecting this image, you import its white balance data for the white balance setting.

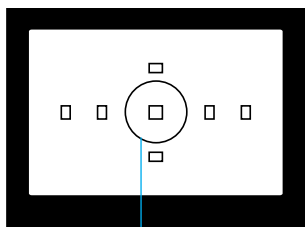

Partial metering zone

## 1 Shoot a white object.

- The white object should fill the entire partial metering circle.
- Set any white balance setting. (→p.50)
- Shoot the white object so that a standard exposure is obtained. If it is underexposed or overexposed, a correct white balance setting might not be obtained.

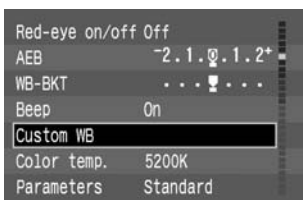

## 2 On the menu, select [Custom WB].

- Press the <MENU> button.
- Turn the <Q> dial to select [Custom WB], then press <SET>.

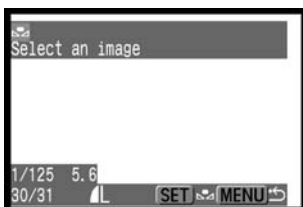

## 3 Select an image.

- Turn the <Q> dial to select the image captured in step 1, then press <SET>.
- ▶ The image's white balance data will be imported.
- After the setting is completed, the menu will reappear.
- To exit the menu and turn off the LCD monitor, press the <MENU> button.

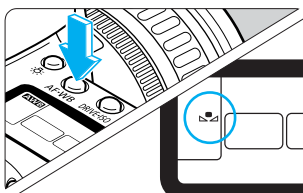

## 4 Press the <AF-WB> button. (6)

## 5 Select the "custom white balance".

- Turn the <Q> dial to select <[WB]>.



For the standard white object, a sheet of plain, white paper is recommended.



You can store on the CF card the images of the standard white object captured under various lighting. Then while shooting, you can select one of these images with the [Custom WB] menu command to easily set the white balance best suited for the current lighting condition.

# MENU Setting the Color Temperature

You can set the white balance color temperature from 2800 K to 10000 K (in 100 K increments).

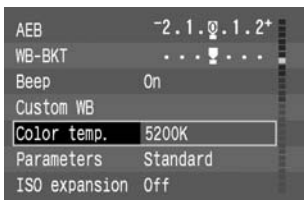

## 1 On the menu, select [Color temp.].

- Press the <MENU> button.
- Turn the <O> dial to select [Color temp.], then press <SET>.

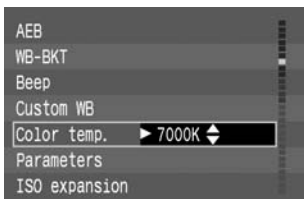

## 2 Set the color temperature.

- Turn the <O> dial to select the desired color temperature, then press <SET>.
- The color temperature can be set from 2800 K to 10000 K in 100 K increments.
- After the setting is completed, the menu will reappear.
- To exit the menu and turn off the LCD monitor, press the <MENU> button.

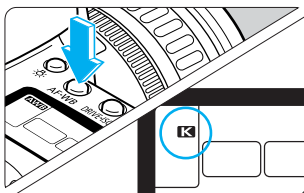

## 3 Press the <AF-WB> button. (6)

## 4 Select the "color temperature".

- Turn the <O> dial to select <K>.



- Use <K> to set the color temperature of natural light. If <K> is used to set the color temperature of artificial light, correct white balance might not be obtained.
- For <K>, if you want to use the reading taken with a color temperature meter, take test shots and adjust the setting to compensate for the difference between the color temperature meter's reading and the camera's color temperature reading.

# MENU White Balance Auto Bracketing

With just one shot, three images having a different color temperature can be recorded simultaneously. Based on the current white balance mode's standard color temperature, the white balance setting can be changed from 0 to +/-3 stops in whole-stop increments. This is called white balance bracketing. One stop is equivalent to 5 Mireds of a color conversion filter. The bracketing sequence starts with a standard color temperature, bluish tone (decreased compensation), and reddish tone (increased compensation). The images are assigned a file number and recorded in the CF card.

## 1 Set the image-recording quality to any setting except [RAW]. (→p.46)

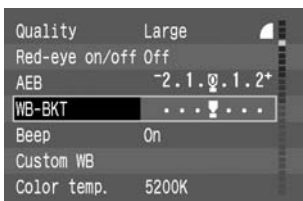

## 2 On the menu, select [WB-BKT].

- Press the <MENU> button.
- Turn the <O> dial to select [WB-BKT], then press <SET>.

## 3 Set the bracketing amount.

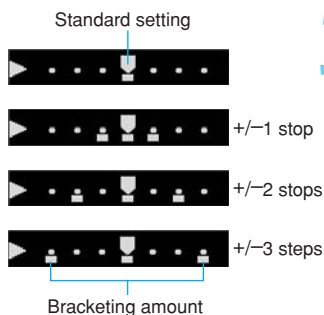

- Turn the <O> dial to select the bracketing amount, then press <SET>.
- You can bracket the white balance up to +/-3 stops in whole-stop increments.
  - ▶ After the setting is completed, the menu will reappear.
- Press the <MENU> button to exit the menu and turn off the LCD monitor.
  - ▶ During white balance bracketing, the icon for the current white balance setting will blink.
  - ▶ The number of remaining shots displayed on the LCD panel will be one-third the normal number.

## 4 Shoot.

- ▶ With a single shot, three images, each having a different color temperature, will be recorded in the CF card.
- ▶ The bracketing sequence will start with the standard color temperature followed by a bluish tone (decreased compensation) and reddish tone (increased compensation).
- The current drive mode is used during white balance bracketing. (→p.76) During continuous shooting, the number of images recorded will be three times as many as the number of shots taken.
- Since three images are recorded for one shot, the CF card will take longer to record the shot.

## Canceling White Balance Auto Bracketing

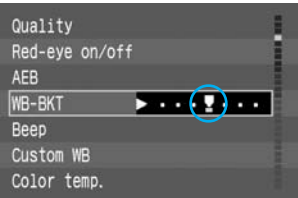

- Follow steps **2** and **3** to set the bracketing amount to <[3]!>, then press <[ENT]>.
- You can also set the <[WB]> switch to <OFF> to cancel white balance bracketing.



White balance bracketing will not work if the image-recording quality is <RAW>.



White balance bracketing can be used together with auto exposure bracketing (AEB). (→p.90) In this case, the three AEB shots will have three white balance bracketed images recorded for each shot. Therefore, a total of nine images will be recorded on the CF card.

### C.Fn

- With C.Fn-9-2/3, you can change the white balance bracketing sequence. (→p.148)
- C.Fn-9-1/3, prevents the white balance bracketing from being canceled after the <[WB]> switch is set to <OFF>. (→p.148)

# MENU Setting Processing Parameters

The image you capture can be processed automatically by the camera in accordance with the parameter settings you set (five settings each for **[Contrast]**, **[Sharpness]**, **[Saturation]**, and **[Color tone]**). You can register and save up to three sets of processing parameters. By selecting **[Standard]**, all the parameter settings will be reset to **[0]**.

## Settings

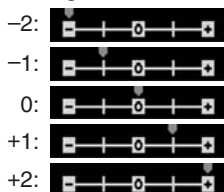

Parameter	Setting	Level	Settings
Contrast	Adjusts the contrast	-1 / -2	Low contrast
		0	Standard contrast
		+1 / +2	High contrast
Sharpness	Adjusts the sharpness	-1 / -2	Weak sharpness
		0	Standard sharpness
		+1 / +2	Strong sharpness
Saturation	Adjusts the color saturation	-1 / -2	Low saturation
		0	Standard saturation
		+1 / +2	High saturation
Color tone	Adjusts the color tone	-1 / -2	Reddish skin tone
		0	Standard color tone
		+1 / +2	Yellowish skin tone

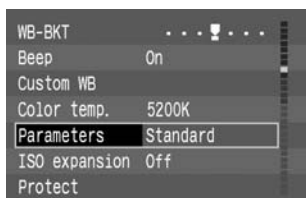

## 1 On the menu, select **[Parameters]**.

- Press the **<MENU>** button.
- Turn the **<DIAL>** to select **[Parameters]**, then press **<SET>**.

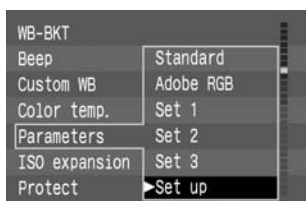

## 2 Select **[Set up]**.

- Turn the **<DIAL>** to select **[Set up]**, then press **<SET>**.
- The default parameter settings for **[Set 1]**, **[Set 2]**, and **[Set 3]** are all **[0]** (Standard).

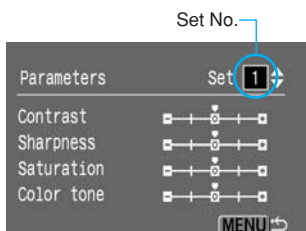

## 3 Select the Set No.

- Turn the **<DIAL>** to select **[1]**, **[2]**, or **[3]**, then press **<SET>**.



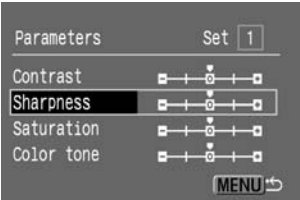

## 4 Select the parameter.

- Turn the <O> dial to select the parameter, then press <SET>.
- The parameter selection will change in the following loop:

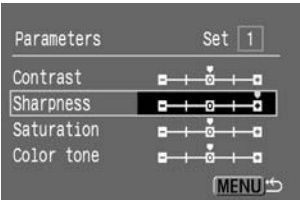
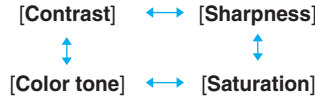

## 5 Set the parameter.

- Turn the <O> dial to set the parameter, then press <SET>.
- Each parameter can be set to one of five settings.

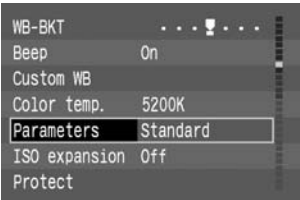

## 6 Return to the [Parameters] menu.

- Press the <MENU> button twice to return to step 1. Then press <SET>.

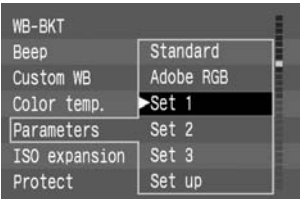

## 7 Select the Set No. that was set.

- Turn the <O> dial to select [Set 1], [Set 2], or [Set 3], then press <SET>.
- ▶ After the setting is completed, the menu will reappear.
- To exit the menu and turn off the LCD monitor, press the <MENU> button.



With the parameters already set, when you set the <ON> switch to <ON>, the camera will start up and display "EB5" on the LCD panel until it is ready for shooting. Then the parameter settings will be displayed. If [Set 1], [Set 2], or [Set 3] has been set, "PR-1", "PR-2", or "PR-3" will be displayed. And if [Adobe RGB] (→p.58) has been set, "PR-R" will be displayed.



With C.Fn-01-2, you can set [Parameters] by pressing <SET> and turning the <O> dial while looking at the LCD panel. (→p.146)

# MENU Selecting a Color Space

The color space indicates the color reproduction range. The camera is compatible with the sRGB and Adobe RGB color spaces.

## Selecting sRGB

For normal shooting, set sRGB for the color space. On the menu for **[Parameters]**, selecting any setting except **[Adobe RGB]** will set sRGB as the color space.

### 1 On the menu, select **[Parameters]**.

- Press the <MENU> button.
- Turn the <O> dial to select **[Parameters]**, then press <SET>.

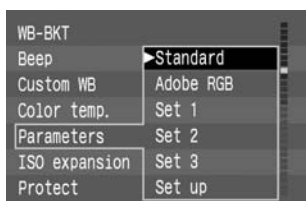

### 2 Select any setting except **[Adobe RGB]**.

(→p.57)

- Turn the <O> dial to select **[Standard]**, **[Set 1]**, **[Set 2]**, or **[Set 3]**, then press <SET>.
- ▶ After the setting is completed, the menu will reappear.
- Press the <MENU> button to exit the menu and turn off the LCD monitor.
- The captured images will then be recorded with sRGB.

## Selecting Adobe RGB

Select Adobe RGB if you want to use a personal computer to adjust the color saturation or if the image will be used for commercial printing with Adobe RGB.

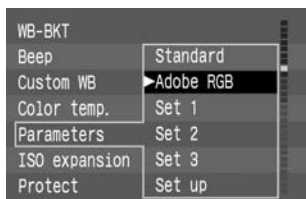

With step 2 above, select **[Adobe RGB]**.

- The image will be recorded with Adobe RGB.



- When Adobe RGB has been set, the processing parameters cannot be set. (→p.56) All the processing parameter settings will be set to **[0]**.
- Images captured with **[Adobe RGB]** will not be appended with the ICC profile. To convert the profile, Adobe RGB must be specified.
- When images captured with Adobe RGB are displayed on an sRGB-based LCD monitor, video monitor, or printed with an sRGB printer, the resulting image will look to have low chroma. The chroma must therefore be adjusted beforehand.

# MENU File Numbering Methods

The images you take are automatically assigned a file number from 0001 to 9999 and saved in a folder that can hold up to 100 images. The folders are numbered from 100 to 999 and saved in the CF card. The automatic file numbering method can be set to [Continuous] or [Auto reset].

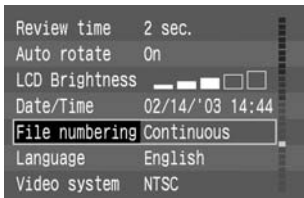

## 1 On the menu, select [File numbering].

- Press the <MENU> button.
- Turn the <O> dial to select [File numbering], then press <SET>.

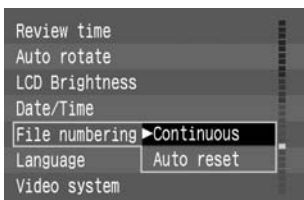

## 2 Select the file numbering method.

- Turn the <O> dial to select [Continuous] or [Auto reset], then press <SET>.
- ▶ After the setting is completed, the menu will reappear.
- Press the <MENU> button to exit the menu and turn off the LCD monitor.

## Continuous Numbering

The file numbering continues in sequence even after you replace the CF card. Since this prevents any images from having the same file number, it makes it easier to manage the images with a personal computer.

Note that if the replacement CF card already contains images captured with the camera, the file numbering will start after the highest file number in that CF card or after the last captured image's file number, whichever is higher.

### File numbering after changing the CF card

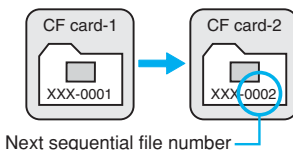

## Auto Reset

Whenever you replace the CF card, the file numbering will be reset to **XXX-0001**. Since the image file number starts from **0001** in each CF card, you can use a different CF card for each day of shooting. Then you can see how many images you shot each day. Note that if the replacement CF card already contains images, the file numbering will start after the highest file number in that CF card.

### File numbering after changing the CF card

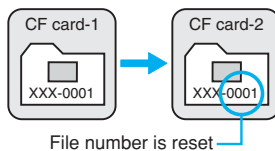



- If the 999CANON folder is created, **[Folder number full]** will appear on the LCD monitor. You can keep shooting up to file No. 9999, however, you should keep a spare CF card on hand.
- If file No. 9999 in folder No. 999 is created, “FULL CF” will be displayed on the LCD panel and in the viewfinder and no more images can be recorded even if the CF card still has room. Replace the CF card with a new one.



- The file numbers are like the frame numbers on a roll of film.
- For details on file names, see “Basic Terminology.” (→p.161)

# MENU Setting Auto Rotation

During playback, vertical images can be displayed vertically after being rotated clockwise by 90° or 270° automatically.

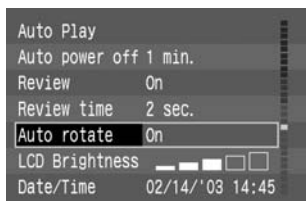

## 1 On the menu, select [Auto rotate].

- Press the <MENU> button.
- Turn the <◉> dial to select [Auto rotate], then press <SET>.

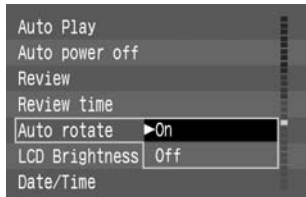

## 2 Set the Auto rotate setting.

- Turn the <◉> dial to select [On], then press <SET>.
- ▶ When the setting is completed, the menu will reappear.
- Press the <MENU> button to exit the menu and turn off the LCD monitor.

## 3 Take a vertical shot.

- For the image review right after image capture, the image will not be displayed vertically on the LCD monitor. (→p.42)

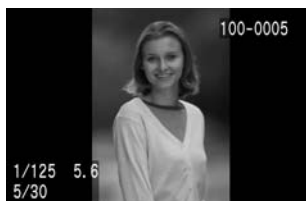

## 4 Playback the image.

- Press the <▶> button.
- ▶ The vertical shot will be displayed vertically as shown on the left.



- If a vertical image is taken while the camera is pointed up or down, the image might not rotate automatically for playback.
- If you take a vertical shot with [Auto rotate] set to [On] and use the menu's [Rotate] feature to rotate it, the image's rotate information will be overwritten.



When you change the camera's orientation between horizontal and vertical, the camera orientation sensor will make a small sound. This is not a defect.

# INFO. Checking Camera Settings

When the camera is ready to shoot, press the <INFO.> button to view the current camera settings on the LCD monitor.



## Display the camera settings.

- Press the <INFO.> button.
- ▶ The current camera settings appear on the LCD monitor.
- Press the <INFO.> button again to clear the LCD monitor.

## Camera Setting Information

The screenshot shows the camera's LCD monitor displaying the following settings:

- Date/Time 02/14/'03 11:03 → Date/time (→p.154)
- AEB -2.1.0.1.2+ → AEB amount (→p.90)
- WB-BKT . . . → WB-BKT amount (→p.54)
- Parameters Standard → Processing parameter setting (→p.57)
- Review On → Image review (→p.42)
- 2 sec. → Image review time (→p.43)
- Flash exposure compensation ±0, 1 min., On → Auto rotate (→p.61)
- Auto power off time (→p.142)
- CF card remaining capacity (→p.47)
- Flash exposure compensation amount (→p.101)
- K 5200 → Color temperature (→p.53)
- ISO 100 → ISO speed (→p.49)

 For viewing image with shooting information during playback, see “Image with Shooting Information”. (→p.109)

The viewfinder has seven AF points. By selecting the optimum AF point, autofocusing can be executed while you maintain the desired subject framing. You can also set the AF mode to suit the subject or intended effect.

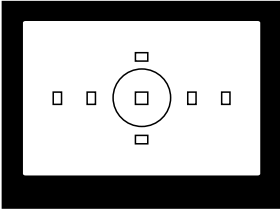

# 4

## Focusing

In the Basic Zone modes, only AF lock (→p.65) and manual focusing (→p.71) apply in this chapter.



First set the <AF-ON> switch and <AF-L/AF-ON> switch to <ON>.

# AF Selecting AF Mode

The AF mode is the autofocusing method. The camera has three AF modes: 1. One Shot AF for still subjects, 2. AI Servo AF for moving subjects, and 3. AI Focus AF that switches automatically from One-Shot AF to AI Servo AF if the subject starts to move.

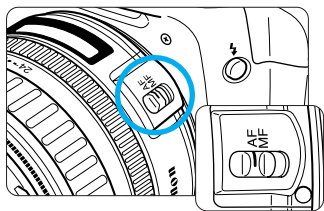

**1** Set the lens focus mode switch to <AF>.

**2** Turn the Mode dial to a Creative Zone mode.

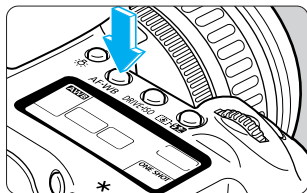

**3** Press the <AF-WB> button. (ⓘ6)

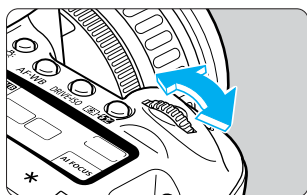

**4** Select the AF mode.

- While looking at the LCD panel, turn the <⦿> dial to select the desired AF mode.

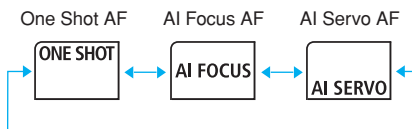

- To return to shooting, press the shutter button halfway.

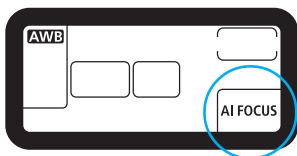

In step 4, turning the <⦿> dial will set the white balance. (→p.50)



## One-Shot AF for Still Subjects

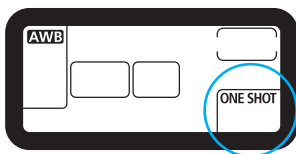

### Pressing the shutter button halfway activates AF operation and achieves focus once.

- ▶ The AF point which achieved focus will flash briefly and the focus confirmation light in the viewfinder will light at the same time.
- With evaluative metering, the exposure setting (shutter speed and aperture) will be set when focus is achieved. The exposure setting and focus will be locked as long as the shutter button is pressed halfway. You can then recompose the shot while retaining the exposure setting and point of focus.

#### C.Fn

With C.Fn-10-1, you can disable the AF point from flashing in red (superimposed display) when focus is achieved. (→p.149)

## Focusing an Off-Center Subject

To focus an off-center subject not covered by any of the seven AF points, follow the procedure below. This technique is called **focus lock**.

Focus lock works when the AF mode is set to One Shot AF.

- 1 Aim the AF point over the subject and press the shutter button halfway to focus.**
- 2 Keep pressing the shutter button halfway and recompose the image as desired.**
- 3 Shoot.**



If focus cannot be achieved, the focus confirmation light <●> in the viewfinder will blink. If this occurs, an image cannot be captured even if the shutter button is pressed fully. Reframe the shot and focus again. Also see “When Autofocus Fails (Manual Focusing)” on page 71.

## AI Servo AF for Moving Subjects

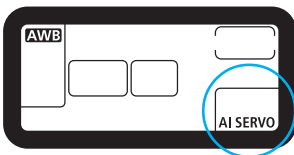

**While you press the shutter button halfway, the camera focuses continuously.**

- This AF mode suits moving subjects when the focusing distance keeps changing.
- With predictive AF\*, the camera can also focus track a subject which steadily approaches or retreats from the camera.
- The exposure settings are set immediately before the image is captured.



- When focus is achieved, the focus confirmation light <●> in the viewfinder will not light and the beeper will not sound.
- If the focus confirmation light <●> in the viewfinder blinks, it means focus has not been achieved.
- Focus lock cannot be used.

### \* Predictive AF

If the subject approaches or retreats from the camera at a constant rate, the camera tracks the subject and predicts the focusing distance immediately before the image is captured. This is for obtaining correct focus at the moment of exposure.

- When the AF point selection is automatic, the camera first uses the center AF point to focus. If the subject moves away from the center AF point, focus tracking continues as long as the subject is covered by another AF point. The active AF point will not flash in red.
- With a manually selected AF point, the selected AF point is used for predictive AF.



With C.Fn-04-2, holding down the <★> button will temporarily stop the AF operation in the AI Servo AF mode. (→p.146)

## AI Focus AF for Automatic AF Mode Switching

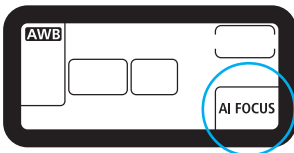

The AI Focus AF mode switches automatically from One-Shot AF to AI Servo AF if the subject starts to move.

If focus is achieved in the One Shot AF mode and the subject starts to move continuously, the camera will detect the movement and switch automatically to AI Servo AF to focus track the subject.



# Selecting an AF Point

The AF point can be selected automatically or manually. In the Basic Zone modes and <A-DEP> mode, AF point selection will be automatic. In the <P> <Tv> <Av> <M> modes, AF point selection can be set to either automatic or manual.

## • Automatic Selection

From among the seven AF points, the camera selects the AF point automatically to suit the subject.

## • Manual Selection

You can select any of the seven AF points manually. This is best when you want to be sure to focus on a particular subject, or to use the speed of the AF focusing function to help you compose a particular shot quickly.

## Basic Procedure for AF Point Selection

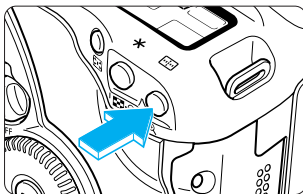

Press the <AF-ON> button. ( 6)

- After pressing the <AF-ON> button, look at the viewfinder or LCD panel and turn the <Q> or <DIAL> dial to select the desired AF point.

Shifts horizontally

Shifts vertically

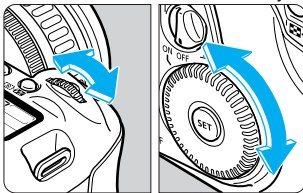

## Selecting a horizontal AF point

- Press the <AF-ON> button and turn the <Q> dial.
- ▶ The selected AF point will shift horizontally.

## Selecting a vertical AF point

- Press the <AF-ON> button and turn the <DIAL> dial.
- ▶ The selected AF point will shift vertically.
- To return to shooting, press the shutter button halfway or press the <AF-ON> button again.

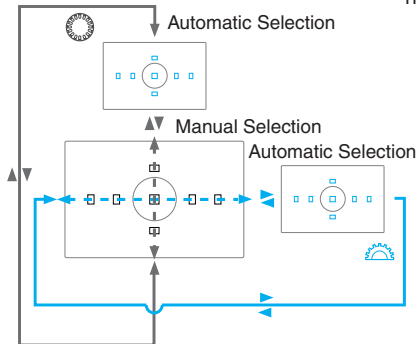

### C.Fn

With C.Fn-13-3, you can select an AF point just by turning the <Q> dial. You need not press the <AF-ON> button first. (→p.150)

## Automatic Selection

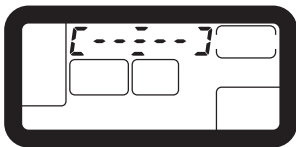
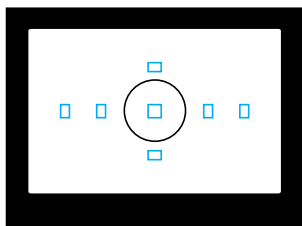

### Display all the AF points in red.

- Press the button, then turn the or dial so that the viewfinder display looks as shown in the illustration.
- When you try to select an AF point beyond a peripheral AF point, automatic focusing selection will be set.
- You can also set automatic AF point selection while looking at the LCD panel.

## Manual Selection

Center AF point selected

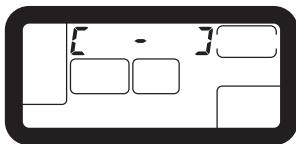
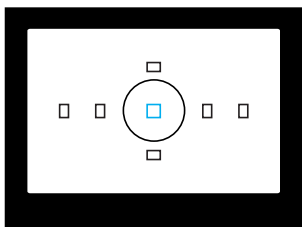

### Display the desired AF point in red.

- To select the AF point, see “Selecting an AF Point.” (→p.67)
- The selection sequence when the and dial is turned is shown below.
- You can also select the AF point manually while looking at the LCD panel.

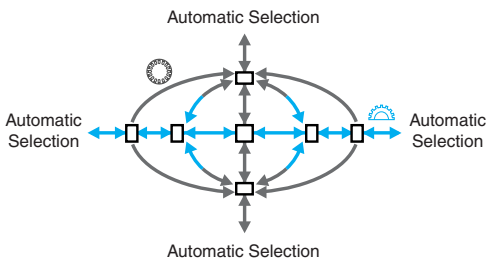

### C.Fn

With C.Fn-10-1, you can disable the AF point from flashing in red when focus is achieved. (→p.149)

# MENU Registering and Switching an AF Point ■

By registering the AF point you often use, you can switch to it instantly. You can register an off-center AF point which suits your preferred framing or automatic selection for the shooting moment priority. Any of the seven AF points can be registered. Only one AF point can be registered.

## Registering an AF Point

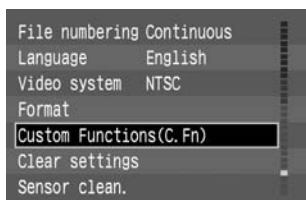

### 1 On the menu, select [Custom Functions (C.Fn)].

- Press the <MENU> button.
- Turn the <DISP> dial to select [Custom Functions (C.Fn)], then press <SET>.
- ▶ The Custom Function screen will appear.

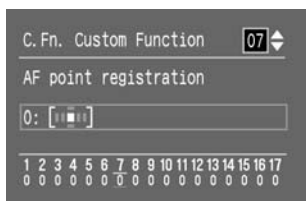

### 2 Select C.Fn-07 [AF point registration].

- Turn the <DISP> dial to select [AF point registration], then press <SET>.

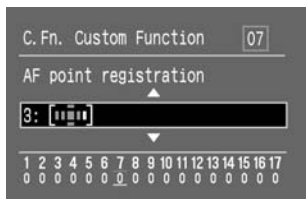

### 3 Register the AF point.

- Turn the <DISP> dial to select the desired AF point, then press <SET>.
- 4: [1 1 1 1] is automatic AF point selection.
- ▶ The selected AF point will be registered.
- Press the <MENU> button to return to the menu.
- To turn off the LCD monitor, press the <MENU> button again.



The registered AF point is called the HP, for Home Position.

## Switching to the Registered AF Point

Normally, to switch to the registered AF point, you press the  $\langle \text{AF-ON} \rangle$  button and  $\langle \text{MENU} \rangle$  button simultaneously. However, with C.Fn-13-1/2, you can just press the  $\langle \text{AF-ON} \rangle$  button to switch to the registered AF point.

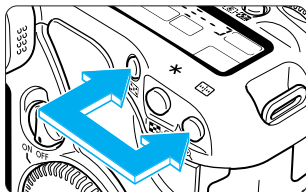

**(1) Press the  $\langle \text{AF-ON} \rangle$  button and  $\langle \text{MENU} \rangle$  button simultaneously.**

- This is the default method with C.Fn-13-0.

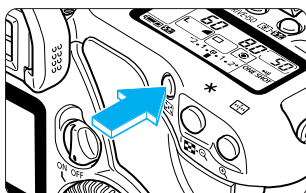

For the setting procedure, see “Setting Custom Functions” (→p.145) or see page 69.

**(2) Press only the  $\langle \text{AF-ON} \rangle$  button to switch to the registered AF point.**

**C.Fn-13-1** (→p.150)

**(3) Switch to the registered AF point only while pressing the  $\langle \text{AF-ON} \rangle$  button.**

**C.Fn-13-2** (→p.150)

- When the  $\langle \text{MENU} \rangle$  button is released, it will return to the original AF point.



If C.Fn-13-1/2 and C.Fn-04-1/3 have been set, you can press only the  $\langle \text{AF-ON} \rangle$  button to switch to the registered AF point and start autofocusing at the same time.

# When Autofocus Fails (Manual Focusing)

Autofocus can fail to achieve focus (the focus confirmation light blinks) with certain subjects such as the following:

- Low-contrast subjects (blue sky, solid-color walls, etc.).
- Subjects in low light.
- Extremely backlit reflective subjects (car with a reflective body, etc.).
- Overlapping near and far objects (animal in a cage, etc.).

In such cases, do one of the following:

- Focus an object at the same distance as the subject and lock the focus before recomposing.
- Set the lens focus mode switch to **<MF>** (or **<M>** on older lenses) and focus manually.  
(→p.27)

## Manual Focusing

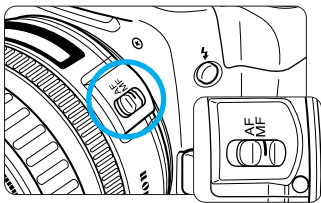

- 1** Set the lens focus mode switch to **<MF>** (or **<M>** on older lenses).

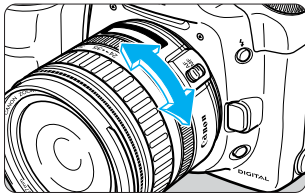

- 2** Focus by turning the lens focusing ring until the subject is in focus in the viewfinder.



- If you press the shutter button halfway during manual focusing, the active AF point and the focus confirmation light **<●>** in the viewfinder will light when focus is achieved.
- If focus cannot be achieved with an external Speedlite's AF-assist beam, select the center AF point. An off-center AF point may not be able to achieve focus.
- With USM (Ultrasonic Motor) lenses (except those not having a distance scale), you can use the focusing ring to fine focus after focus is achieved in the One-Shot AF mode (full-time manual focusing).





Evaluative, partial, and center-weighted average metering modes are provided. For the drive mode, single frame, continuous, and self-timer are provided. Select the mode which best suits the subject or your creative intentions.

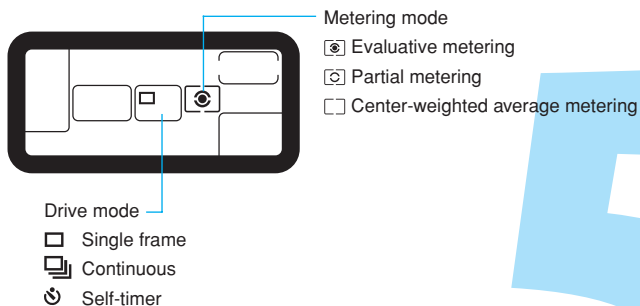

## Selecting the Metering Mode and Drive Mode

In the Basic Zone modes, the metering mode and drive mode are set automatically. Only the self-timer setting will apply in this chapter.



First set the <ON> switch to <ON>.



# Selecting the Metering Mode

The EOS 10D uses three modes for metering: Evaluative, Partial, and Center-weighted average.

The Basic Zone uses evaluative metering. In the Creative zone, any of the three modes can be selected.

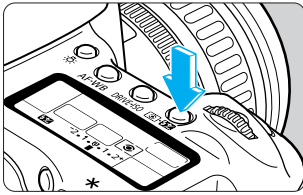

**1** Press the button. ( 6 )

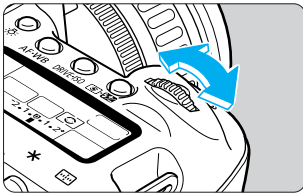

**2** Select a metering mode.

- While looking at the LCD panel, turn the dial to set the desired metering mode.

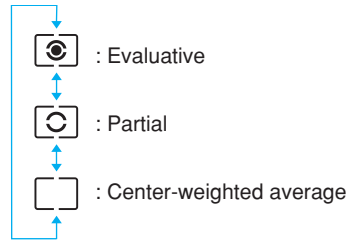
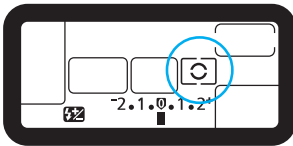

- Press the shutter button down halfway to return to shooting.



In step 2, turning the dial will set the flash exposure compensation amount for the built-in flash or external Speedlite. (→p.101)

# Metering Modes

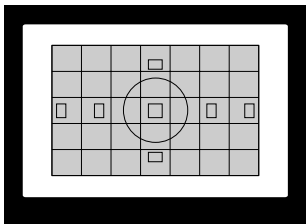

## Evaluative Metering

This is an all-around metering mode suited even for backlit subjects. The viewfinder is divided into 35 metering zones to which all the AF points are linked for evaluative metering. After detecting the main subject's position, brightness, background, front and back lighting conditions, camera orientation (horizontal or vertical), etc., the camera sets the proper exposure.

- During manual focusing, evaluative metering is based on the center AF point.
- If the subject brightness and background light level are very different (strong backlight or spotlight), partial metering () is recommended instead.

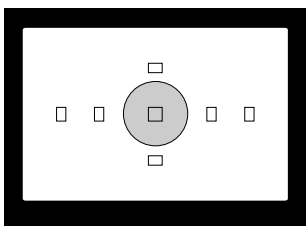

## Partial Metering

This mode is effective when the background is much brighter than the subject (due to backlighting, etc.). The metering is weighted at the center covering 9% of the viewfinder area.

- The area covered by partial metering is shown on the left.

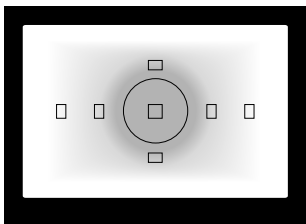

## Center-weighted Average Metering

The metering is weighted at the center and then averaged for the entire scene.

# DRIVE Drive Mode Selection

Three drive modes are provided:

- Single frame: Only one shot is taken when you press the shutter button.
- Continuous: Continuous shots are taken while you hold down the shutter button fully.
- Self-timer: The self-timer starts when you press the shutter button fully. The image is captured 10 sec. later. (→p.77)

Image-Recording Quality	Continuous Shooting Speed		Maximum Burst
	One Shot AF	AI Servo AF	
L / L / M / M / S / S	Approx. 3 fps		Approx. 9 shots
RAW			

- In the <RAW> mode, the above figures will apply regardless of the C.Fn-08 setting.
- Figures for the continuous shooting speed and maximum burst are based on Canon's standard testing conditions (1/250 sec. and faster shutter speeds and ISO 100).

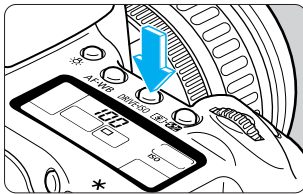

## 1 Press the <DRIVE-ISO> button. ( Ⓞ6 )

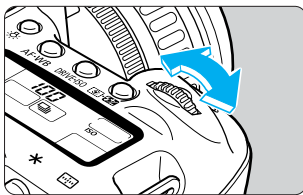

## 2 Select the drive mode.

- While looking at the LCD panel, turn the <DRIVE> dial to set the desired drive mode.

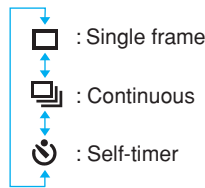
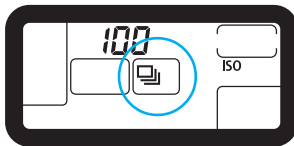

- To return to shooting, press the shutter button halfway.



- If the CF card has little room left and cannot fit more than eight images, continuous shooting might not be possible.
- During continuous shooting, the captured images are first stored in the camera's internal memory and then successively transferred to the CF card. When the internal memory becomes full during continuous shooting, "BUSY" will be displayed on the LCD panel and in the viewfinder and the camera cannot take any more shots. As the captured images are transferred to the CF card, you will be able to capture more images. Press the shutter button halfway to check in the viewfinder the current remaining number of maximum burst (9 to 1) for continuous shooting. The maximum burst number will not be displayed when there is no CF card in the camera.
- If you press the shutter button halfway before all the images in the internal memory are transferred to the CF card (while the access lamp blinks), the image transfer to the CF card will stop temporarily.
- If "FULL CF" is displayed in the viewfinder and on the LCD panel, wait until the access lamp turns off, then replace the CF card.



- The maximum burst during white balance bracketing is also 9 shots.
- In step 2, turning the <DRIVE/ISO> dial will set the ISO speed. (→p.49)

## Self-timer Operation

The self-timer is convenient for group shooting. You can use it in any Basic mode or Creative mode. We recommend using a tripod when you use the self-timer.

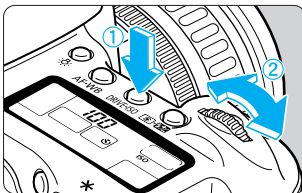

### 1 Select the self-timer.

- Press the <DRIVE/ISO> button, then look at the LCD panel and turn the <DRIVE/ISO> dial to select <Self-timer>.

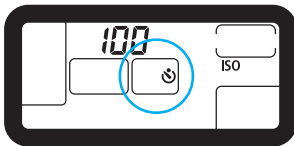

### 2 Focus the subject.

- Look through the viewfinder and press the shutter button halfway. Check that the focus confirmation light <●> and exposure settings are displayed.

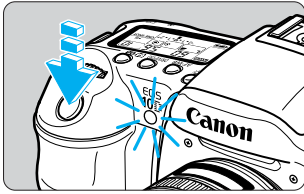

3

### Shoot.

- Press the shutter button fully.
- ▶ The self-timer lamp will start blinking and the beeper will sound to indicate that the self-timer is operating.
- ▶ After about 10 sec., the image will be captured. During the first 8 sec., the lamp blinks and the beeper beeps slowly. During the final 2 sec., the lamp stays lit and the beeper beeps faster.
- ▶ During the self-timer operation, the LCD panel counts down the seconds until the image is captured.
- To cancel the self-timer after it starts, press the <DRIVE/ISO> button.



Do not stand in front of the camera when you press the shutter button to start the self-timer. Doing so prevents the camera from focusing on the subject.



- You can set the beep that indicates the subject is in focus and the beep that indicates the self-timer is operating to [On] or [Off]. (→p.140)
- When using the self-timer to shoot only yourself, lock the focus (→p.65) on an object at about the same distance as where you will be.

## Using the Eyepiece Cover

During self-timer or remote control operation when your eye does not cover the viewfinder eyepiece, stray light may enter the eyepiece and affect the exposure when the image is captured. To prevent this, use the eyepiece cover (attached to the neck strap) to cover the eyepiece.

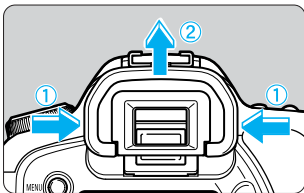

1

### Remove the eyecup.

- Grasp both sides of the eyecup and slide it up to remove.

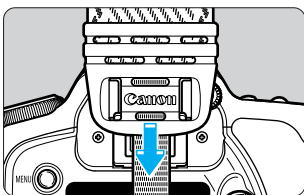

2

### Attach the eyepiece cover.

- Slide the eyepiece cover down into the eyepiece groove to attach it.

The Creative zone features shooting modes that let you select the shutter speed or aperture value and change the exposure yourself, providing you with more flexibility to set up the camera for a variety of shooting styles.

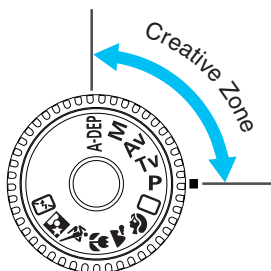

# 6

## Advanced Operations

- Press the shutter button down halfway and release, and a timer will show the exposure setting for approximately 4 seconds on the LCD panel and viewfinder.
- Depth-of-field preview, exposure compensation, AEB, AE lock, and bulb exposures are possible only in Creative Zone modes.
- The functions that can be set in Creative Zone modes are listed in the “Function Availability Table” (→p.163).



First set the <📷> switch and <👁️> switch to <ON>.

# P Program AE



Like <O> (Full Auto) mode, this is a general-purpose shooting mode. The camera automatically sets the shutter speed and aperture value to suit the scene's brightness. This is called Program AE.

- \* **P** stands for Program
- \* **AE** stands for Auto Exposure

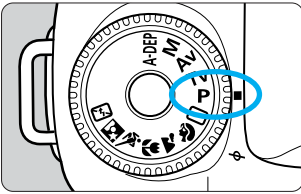

## 1 Set the Mode Dial to <P>.

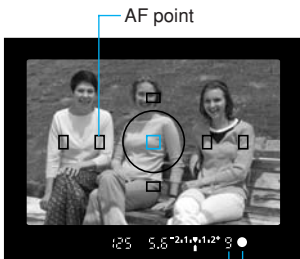

Maximum burst  
Focus confirmation light

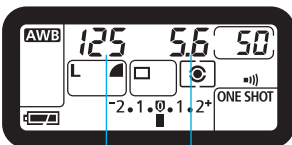

Shutter speed      Aperture



## 2 Focus the subject.

- Look through the viewfinder and aim any AF point over the subject. Then press the shutter button halfway.
- ▶ The AF point that achieves focus will flash briefly. At the same time, the beeper will sound and the focus confirmation light <●> in the viewfinder will light.
- ▶ The exposure setting will be displayed in the viewfinder and on the LCD panel.
- If the focus confirmation light <●> in the viewfinder blinks, it means focus has not been achieved. See "When Autofocus Fails" (→p.71).
- The number "3" - "9" displayed to the left of the focus confirmation light <●> indicates the maximum burst for continuous shooting.
- When the CF card is almost full and only nine or fewer shots can be taken, "[3]" to "[9]" will be displayed to indicate the remaining number of shots.

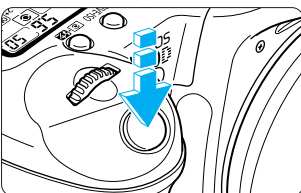

## 3 Shoot.

- Compose the shot and check that the exposure setting is not blinking. Then press the shutter button fully to shoot.
- ▶ The captured image will be displayed for 2 sec. on the LCD monitor.



## Exposure Warnings



If the shutter speed or aperture blinks, it means a correct exposure cannot be obtained. Although the image can be captured, it may come out too bright or too dark. For details, see “Exposure Warning List” on page 164.



- With automatic AF point selection (→p.68), all the AF points achieving focus will flash.

### Differences Between <P> and <□> (Full Auto)

- In both the <P> and <□> modes, the shutter speed and aperture are set automatically in the same way.
- You can select or set the following functions in the <P> mode, but not in the <□> mode.

#### Shooting Functions

AF mode selection
AF point selection
Drive mode selection
Metering mode selection
Program shift
Exposure compensation
AEB
AE lock with <★> button
Depth-of-field preview
Camera setting reset
Custom Functions (C.Fn)
Clear all Custom Functions
Image sensor cleaning

#### Built-in Flash Functions

Flash On/Off
FE lock
Flash exposure compensation

#### EX-Series Speedlite Functions

Manual/Multi-Speedlite flash
High-speed sync
FE lock
Flash ratio control
Flash exposure compensation
FEB
2nd-curtain sync
Modeling flash

#### Image-Recording Functions

<RAW> selection
ISO speed setting
White balance selection
Custom WB image selection
WB-BKT setting
Color temp. setting
Processing parameter setting

### Shifting the Program

- In Program AE mode, you can freely change the shutter speed and aperture value combination (program) set by the camera while maintaining the same exposure value. This is called shifting the program.
- To do this, press the shutter button down halfway, then turn the <☀> dial until the shutter speed or aperture value you want is displayed.
- Program shift is canceled automatically after the image is captured.
- If you are using a flash, you cannot shift the program.

# Tv Shutter-Priority AE

In this mode, you set the shutter speed and the camera automatically sets the aperture value to suit the brightness of the subject. This is called Shutter-Priority AE.

A fast shutter speed can freeze the motion of a fast-moving subject and a slow shutter speed can blur the subject to give the impression of motion.

\* Tv stands for “time value.”



Fast shutter speed



Slow shutter speed

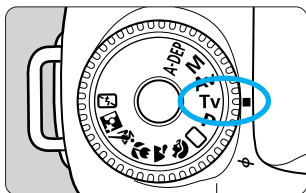

**1** Set the Mode Dial to <Tv>.

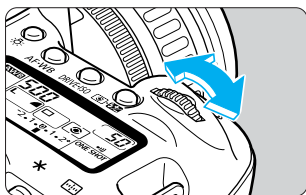

**2** Turn the <shutter speed> dial to set the desired shutter speed.

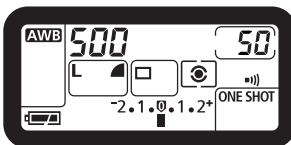

**3** Focus on the subject.

- Press the shutter button down halfway.
- ▶ The aperture value is determined automatically.



**4** Check the display, then shoot.

- If the aperture value is not blinking, the exposure is correct.
- Compose the shot, then press the shutter button down fully.

## Exposure Warnings

- If the lens' maximum aperture (lowest f/number like f/3.5) blinks, it indicates underexposure. Turn the  dial to set a slower shutter speed until the aperture display stops blinking.



- If the lens' minimum aperture (highest f/number like f/22) blinks, it indicates overexposure. Turn the  dial to set a faster shutter speed until the aperture display stops blinking.



## Shutter Speed Display

You can set the shutter speed in half-stop increments as shown below. The shutter speeds from “4000” to “4” indicate the denominator of the fractional shutter speed, so that—for example—“125” is 1/125 second. For slow speeds, “0'17” is 0.7 seconds and “15'” is 15 seconds.

4000	3000	2000	1500	1000	750	500	350	250	180				
125	90	60	45	30	20	15	10	8	6	4	0'13	0'15	0'17
1'	1'5	2'	3'	4'	6'	8'	10'	15'	20'	30'			

### C.Fn

- C.Fn-16-1 enables the safety shift feature. (→p.151)  
In the shutter-priority AE mode, if a correct exposure cannot be obtained with any aperture set by the camera, the camera automatically sets a faster or slower shutter speed. This feature is called safety shift.
- With C.Fn-06-1, you can also set the camera so that you can set the shutter speed in 1/3-stop increments. (→p.147)

# Av Aperture-Priority AE

In this mode, you set the desired aperture and the camera sets the shutter speed automatically to suit the subject brightness.

The larger or brighter the aperture (lower f/number) the more blurred the background will become. This effect is ideal for portraits. The smaller or darker the aperture (higher f/number), the clearer the focus will be for both near and far objects (wider depth of field).

\* **Av** is an abbreviation for Aperture value.



With a large aperture



With a small aperture

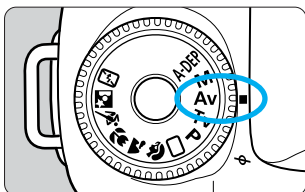

**1** Set the Mode Dial to <Av>.

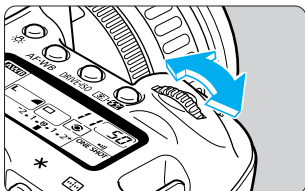

**2** Turn the <aperture> dial to set the desired aperture.

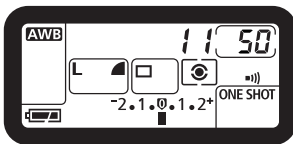

**3** Focus on the subject.

- Press the shutter button down halfway.
- ▶ The shutter speed is determined automatically.





**4** Check the display, then shoot.

- If the shutter speed is not blinking, the exposure is correct.
- Compose the shot, then press the shutter button down fully.

### Exposure Warnings

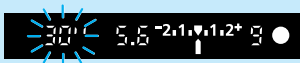
- If the “30” shutter speed blinks, it indicates underexposure. Turn the  dial to set a larger aperture (lower f/number) until the shutter speed stops blinking.



- If the “4000” shutter speed blinks, it indicates overexposure. Turn the  dial to set a smaller aperture (higher f/number) until the shutter speed stops blinking.

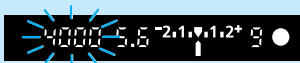

### Aperture Value Display

You can set the aperture in half stops as shown below. The higher the aperture value, the smaller the aperture opening. The range of aperture settings displayed depends on the lens mounted on the camera.

1.0	1.2	1.4	1.8	2.0	2.5	2.8	3.5	4.0	4.5	5.6	6.7	8.0	9.5
11	13	16	19	22	27	32	38	45	54	64	76	91	

If no lens is mounted on the camera, the aperture setting is displayed as “00”.



- C.Fn-16-1 enables the safety shift feature. (→p.151)  
If a correct exposure cannot be obtained in the aperture-priority AE mode with any shutter speed set by the camera, the camera automatically sets a larger or smaller aperture. This feature is called safety shift.
- With C.Fn-06-1, you can also set the camera so that you can set the aperture value in 1/3-stop increments. (→p.147)
- With C.Fn-03-1, you can fix the shutter speed at 1/200 second for shooting with a flash. (→p.146)

## Depth-of-field Preview

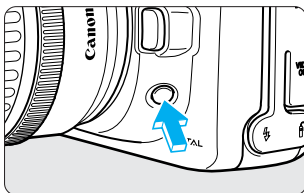

The depth of field is the range of acceptable focus in front of and behind the point of focus. (→p.160) The depth of field changes depending on the aperture. Press the depth-of-field preview button to stop down the aperture and see the range of acceptable focus in the viewfinder.



- This feature can be used in the Creative zone.
- Depth-of-field preview will work after you press the shutter button halfway and achieve focus in <A-DEP>.
- The exposure is locked (AE lock) while the Depth-of-Field Preview button is pressed.

# M Manual Exposure



In this mode, you set both the shutter speed and aperture as desired. To determine the exposure, refer to the exposure level indicator in the viewfinder or use a handheld exposure meter. This method is called manual exposure.

\* **M** stands for manual.

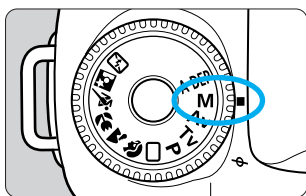

**1** Set the Mode Dial to <M>.

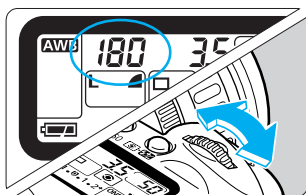

**2** Turn the <☀> dial to set the desired shutter speed.

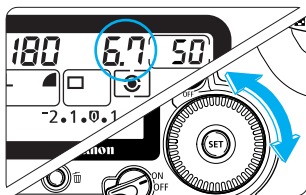

**3** Set the aperture.

- Turn the <Ⓞ> switch to <ON>, then turn the <⦿> dial to set the desired aperture.

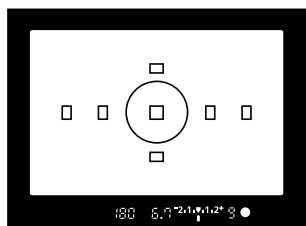

**4** Focus on the subject.

- Press the shutter button down halfway.
- ▶ The exposure level indicator appears in the viewfinder and on the LCD panel.
- The exposure level icon <▲> lets you see how far you are from the standard exposure level.



Exposure level mark

## 5 Determine the exposure.

- Set the shutter speed or aperture value manually.

Standard exposure index

**-2,1,▼,1,2+** : This is the reference point for a standard exposure.

**-2,1,▼,1,2+** : To set it to the standard exposure level, set a slower shutter speed or a larger aperture (smaller f/number).

**-2,1,▼,1,2+** : To set it to the standard exposure level, set a faster shutter speed or a smaller aperture (larger f/number).

Exposure level mark

- If the exposure level indicator <▲> is flashing at the <2+> or <-2> position, the exposure is over- or under-exposed by more than two stops.

## 6 Shoot.

- Compose the shot, then press the shutter button down fully.

### C.Fn

With C.Fn-06-1, you can set the camera so that you can set the shutter speed or aperture value in 1/3-stop increments. (→p.147)

# A-DEP Automatic Depth-of-Field AE

This mode is for obtaining a wide depth of field automatically between a near subject and far subject. It is effective for group photos and landscapes.

The camera uses the seven AF points to detect the nearest and farthest subjects to be in focus.

\* A-DEP stands for Auto-depth of field.

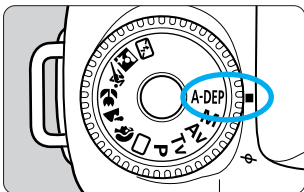

## 1 Set the Mode Dial to <A-DEP>.

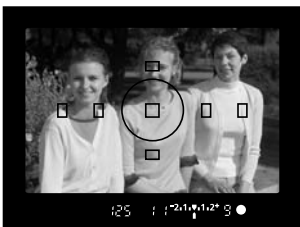

## 2 Focus the subject.

- Move the AF point over the subject and press the shutter button halfway. (☞4)
- All the subjects covered by the AF points which flashed in red will be in focus.
- If you press the depth-of-field preview button while pressing the shutter button halfway, you can see the depth of field. (→p.85)

## 3 Shoot.

- As long as the exposure setting is not blinking, a proper exposure will be obtained.
- Compose the shot and press the shutter button fully.
- In the sample image shown in step 2, all three people will be in sharp focus even though they are at different distances from the camera.



- The <A-DEP> mode cannot be used if the lens' focus mode switch is set to <MF> (or <M> on older lenses).
- If the aperture value blinks, it indicates that the exposure level is correct but the desired depth of field cannot be achieved. Either use a wide-angle lens or move further away from the subjects.



- In this shooting mode, you cannot freely change the shutter speed and aperture. If the camera sets a slow shutter speed, hold the camera steady or use a tripod.
- Regardless of the AF mode setting, ONE-SHOT AF will take effect.
- If you use a flash, the result will be the same as using <P> (Program AE) mode with flash.



# Setting Exposure Compensation

Exposure compensation is used to alter the camera's standard exposure setting. You can make the image look lighter (increased exposure) or darker (decreased exposure). The exposure compensation amount can be set up to +/-2 stops in 1/2-stop increments.

**1 Turn the Mode Dial to any Creative Zone mode except <M>.**

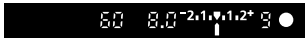

**2 Focus the subject and check the exposure level.**

- Press the shutter button halfway and check the exposure level indicator.

Increased exposure



Decreased exposure

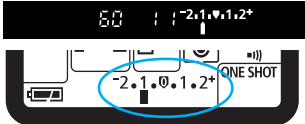

**3 Set the exposure compensation amount.**

- Turn the <ON> switch to <ON>, then look at the viewfinder or LCD panel and turn the <DIAL> dial to set the desired exposure compensation amount.
- Turn the <DIAL> dial while pressing the shutter button halfway or within 4 sec. after pressing and releasing the shutter button halfway.
- “+” indicates increased exposure, and “-” indicates decreased exposure.

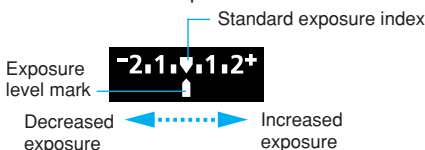

- To cancel the exposure compensation, set the exposure compensation amount to <0> or <0>.

**4 Shoot.**



- The exposure compensation amount will remain in effect even after you turn the <OFF> switch to <OFF>.
- If the standard exposure setting is 1/125 sec. and f/5.6, setting the exposure compensation amount to plus or minus one stop will be the same as setting the shutter speed or aperture as follows:

	-1 stop ←	0	→ +1 stop
Shutter speed	250	← 125	→ 60
Aperture	8.0	← 5.6	→ 4.0

- To prevent the <DIAL> dial from turning inadvertently and changing the exposure compensation amount, set the <OFF> switch to <OFF>.

**C.Fn**

- C.Fn-06-1, enables the exposure compensation amount to be set in 1/3-stop increments. (→p.147)
- With C.Fn-13-3, you can hold down the <Fn> button and turn the <DIAL> dial to set the exposure compensation amount. (→p.150)

# MENU Auto Exposure Bracketing

With autoexposure bracketing (AEB), the camera automatically changes the exposure level up to +/-2 stops in 1/2-stop increments for three successive shots.

In the <P> mode, AEB is executed by changing both the shutter speed and aperture.

In the <Tv> mode, AEB is executed by changing the aperture.

In the <Av>, <M>, or <A-DEP> mode, AEB is executed by changing the shutter speed.



Standard exposure (0)



Decreased exposure (-1/2 stop)



Increased exposure (+1/2 stop)

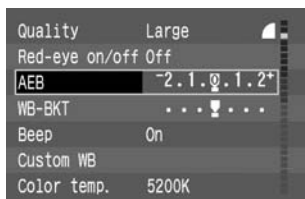

## 1 On the menu, select [AEB].

- Press the <MENU> button.
- Turn the <Q> dial to select [AEB], then press <SET>.

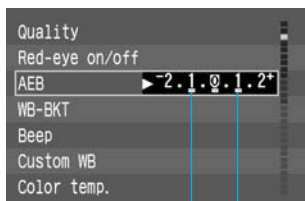

AEB range

## 2 Set the AEB amount.

- Turn the <Q> dial to set the desired AEB amount, then press <SET>.
- ▶ The menu will reappear.
- Press the <MENU> button to exit the menu and turn off the LCD monitor.
- ▶ The <AEB> and AEB level will appear on the LCD panel.

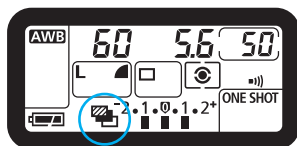

## 3 Shoot.

- ▶ The three bracketed shots will be exposed in the following sequence: standard exposure, decreased exposure, and increased exposure.
- ▶ The respective bracketing amount will be displayed as each bracketed shot is taken.
- ▶ The current drive mode will be used for the bracketing. (→p.76)
- ▶ During the AEB shooting, the <AEB> icon and AEB amount will blink.
- When AEB is used with the self-timer, the three bracketed shots will be taken in succession after the 10-second self-timer delay.

standard exposure



decreased exposure



increased exposure



## Canceling AEB

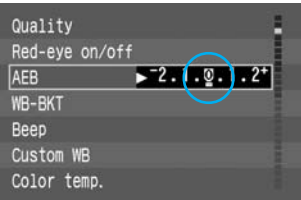

- Follow steps 1 and 2 to set the AEB amount to  $\langle \blacktriangleright -2, 0, 1, 2^+ \rangle$ .
- AEB will also be canceled automatically if you turn the  $\langle \text{OFF} \rangle$  switch to  $\langle \text{OFF} \rangle$ , change lenses, have flash-ready, replace the battery, or replace the CF card.

- Neither flash nor bulb exposures can be used in AEB mode.
- If you set mirror lockup with C.Fn-12-1 (→p.149) and then use AEB, single-frame shooting takes effect even if the drive mode is set to continuous shooting.

- If the drive mode is single frame, press the shutter button for each bracketed shot.
- AEB can also be set in combination with exposure compensation. If you set the exposure compensation amount beyond the displayable range, the indicator will look as shown below. However, the exposure compensation amount will still remain valid.

For  $\langle P \rangle \langle Tv \rangle \langle Av \rangle \langle A-DEP \rangle$ :



Exposure compensation by -2 stops and +/- 1 stop AEB

For  $\langle M \rangle$ :



-2 stops and +/- 1 stop AEB

- C.Fn-06-1, enables the exposure compensation amount to be set in 1/3-stop increments. (→p.147)  
In this case, the AEB amount will be displayed as shown below.



- C.Fn-09-2/3, changes the bracketing sequence to decreased exposure, standard exposure, and increased exposure. (→p.148)
- C.Fn-09-1/3, can prevent AEB from being canceled after you turn the  $\langle \text{OFF} \rangle$  switch to  $\langle \text{OFF} \rangle$ , change lenses, have flash-ready, replace the battery, or replace the CF card. (→p.148)

# \* AE Lock

AE lock enables you to lock the exposure at a different place from the point of focus. After locking the exposure, you can recompose the shot while maintaining the desired exposure level. This feature is useful for backlit and spotlighted subjects.

AE lock works differently depending on the selected AF point and metering mode. For details, see “AE Lock Effects” (→p.165).

## 1 Focus the subject.

- ▶ The exposure setting will be displayed in the viewfinder.

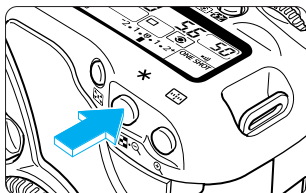

## 2 Press the < \* > button. (ⓘ4)

- ▶ The < \* > icon will light in the viewfinder to indicate that the exposure setting has been locked (AE lock).
- Aim the center of the viewfinder over the subject where the exposure is to be locked, then press the < \* > button.
- Each time you press the < \* > button, it locks the current exposure setting.

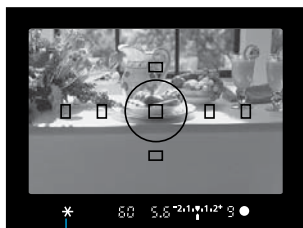

AE lock indicator

## 3 Compose the shot and shoot.

- Press the shutter button fully.



If One-Shot AF and evaluative metering are set, pressing the shutter button halfway to focus will automatically set AE lock at the same time.

### C.Fn

C.Fn-04-1 enables AE lock with the shutter button pressed halfway (instead of the < \* > button) and focusing with the < \* > button. (→p.146)

# Bulb Exposures

When bulb is set, the shutter is open during the time you keep pressing the shutter button fully. Bulb is useful when a long exposure is necessary for capturing night scenes, fireworks, the night sky, etc.

## 1 Set the Mode Dial to <M>.

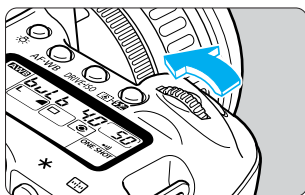

## 2 Set the shutter speed to “bulb”.

- Look at the LCD panel and turn the <☀> dial to select “bulb”.
- The next setting after “30” is “bulb”.

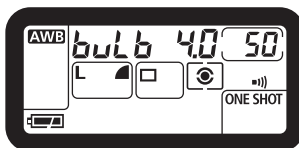

## 3 Set the aperture.

- Turn the <⦿> dial to set the desired aperture.

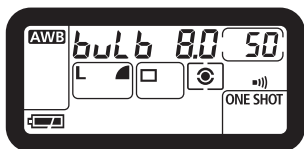

## 4 Shoot.

- Press and hold the shutter button down fully.
  - ▶ The LCD panel will show the elapsed exposure time from 1 sec. to a maximum of 999 sec.
- Exposure continues as long as you hold down the shutter button.



Since bulb exposures will have more noise than usual, the image will look rough or grainy.



With a fully-charged battery, a single bulb exposure can be as long as about 2.5 hours.



By connecting Remote Switch RS-80N3 or Timer Remote Controller TC-80N3 (both optional) to the camera's remote control terminal, you need not keep pressing the shutter button with your finger during bulb exposures. (→p.175)

# Mirror Lockup

Mirror lockup is enabled with C.Fn-12-1. (→p.149) This prevents mirror-caused vibrations which may blur the image during close-ups or when a super telephoto lens is used. To set this Custom Function, see “Setting a Custom Function” on page 145. When mirror lockup is set, the camera operates as follows.

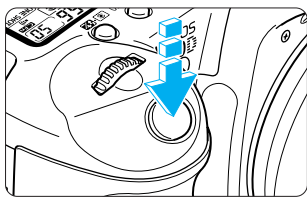

## 1 Press the shutter button fully.

- ▶ The mirror will lock up.
- After 30 seconds, it will go back down automatically.

## 2 Press the shutter button fully again.

- The image will be captured and the mirror will go back down.
- To take another shot with mirror lockup, start from step 1 again.



- In very bright light such as at the beach or ski ground on a sunny day, shoot promptly after mirror lockup.
- During mirror lockup, do not point the camera lens at the sun. The sun's heat can scorch and damage the shutter curtains.
- If you use mirror lockup with the self-timer for a bulb exposure, there will be a shutter release sound when you release the shutter button during self-timer operation. This is not the sound of the actual shutter release.



- When using mirror lockup, Remote Switch RS-80N3 (optional) is recommended. (→p.76)
- During mirror lockup, the single drive mode will take effect regardless of the current drive mode setting.
- If the self-timer is used with mirror lockup, pressing the shutter button fully the first time will lock up the mirror, then the shot will be taken 2 seconds later.

# LCD Panel Illumination

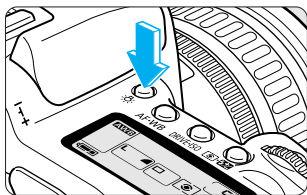

LCD panel illumination is provided.

The  button turns the illumination of the LCD panel on or off. The illumination stays on for 6 sec. If you shoot while the panel is illuminated, the illumination will turn off 2 seconds after shooting. If you take a bulb exposure while the panel is illuminated, the illumination will turn off immediately.



The illumination will remain on if you press any button for shooting or the Mode dial.



The EOS 10D can take easy, natural-looking flash shots with correct subject illumination using E-TTL autoflash (preflash evaluative metering in memory) using either the camera's built-in flash or any EOS-dedicated EX-series Speedlite. The procedure is as easy as a normal AE shot.

This chapter explains how to take flash shots with the built-in flash and EOS-dedicated Speedlite 550EX. For details on Speedlite 550EX, see the 550EX Instructions booklet.

# 7 Shooting with a Flash

7



First set the <  > switch to <ON>. If necessary, also set the <  > switch to <ON>.

# Using the Built-in Flash

The built-in flash lets you take the following kinds of flash shots with the ease of a normal AE shot.

## ● E-TTL autofocus

With E-TTL autofocus (preflash evaluative metering), optimum flash exposure is obtained for the subject in focus. In the aperture-priority AE mode, a slow sync speed is set automatically in low-light situations to obtain a natural-looking, balanced exposure between the subject and background.

## ● FE (Flash Exposure) Lock

FE (flash exposure) lock sets the correct flash exposure for a selected part of the subject. The FE lock functions as an AE lock with flash.

## ● Flash exposure compensation

This function corrects the flash level in much the same way as the Exposure compensation function. The level of compensation can be up to +/-2 stops in 1/2-stop increments.

## Using the Built-in Flash in the Basic Zone

In the Basic Zone modes (except <📷> <📷> <📷>), the built-in flash pops up and fires automatically in low-light and backlit conditions.

The following procedure applies to the <📷> (Full Auto) mode with E-TTL autofocus.

**1 Turn the Mode Dial to <📷>.**

**2 Focus the subject.**

- Press the shutter button halfway to focus.
- ▶ If necessary, the built-in flash will pop up automatically.

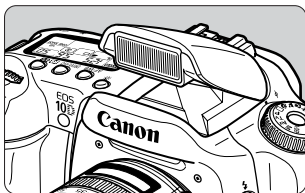

**3 Check that the <📷> icon is lit.**

- In the viewfinder, check that the <📷> icon is lit.

**4 Shoot.**

- Press the shutter button fully.
- ▶ The built-in flash will fire.
- To retract the built-in flash, push it down with your finger.



Flash-ready icon



## Using the Built-in Flash in the Creative Zone

When using a Creative zone mode, press the <⚡> button to pop up the built-in flash.

- P** : Select <P> mode for full autofocus.  
The shutter speed and aperture value are determined automatically, just as in <□> (Full Auto) mode.
- Tv** : Select <Tv> mode to manually set a shutter speed slower than 1/200 second.  
The camera then automatically sets the flash aperture value to provide the proper exposure for your shutter speed.
- Av** : Select <Av> mode to manually set the aperture value.  
In low-light conditions against a background such as a night sky, you can use automatic slow-sync settings to properly expose the main subject and the background. The main subject is captured by the flash, and the background is captured by long exposure using a slow shutter speed.
- Because automatic slow-sync shooting uses a slow shutter speed, always use a tripod.
- M** : Select <M> mode to set the shutter speed and the aperture value manually.  
The main subject is exposed properly by the flash. The background exposure varies according to the shutter speed and aperture settings.
- A-DEP** : The effect is the same as using flash in <P> mode.

## Built-in Flash Range

(using EF24-85mm f/3.5-4.5 USM lens)

ISO Speed	Wide-angle: 24 mm	Telephoto: 85 mm
100	Approx. 1-3.7 m (3.3-12.1 ft)	Approx. 1-2.9 m (3.3-9.5 ft)
200	Approx. 1-5.3 m (3.3-17.4 ft)	Approx. 1-4.1 m (3.3-13.5 ft)
400	Approx. 1-7.4 m (3.3-24.3 ft)	Approx. 1-5.8 m (3.3-19 ft)
800	Approx. 1-10.5 m (3.3-34.5 ft)	Approx. 1-8.2 m (3.3-27 ft)
1600	Approx. 1-14.9 m (3.3-48.9 ft)	Approx. 1-11.6 m (3.3-38 ft)
H: 3200	Approx. 1-21 m (3.3-69 ft)	Approx. 1-16.3 m (3.3-53.5 ft)

## Flash Sync Speed and Aperture Settings

Mode	Shutter speed setting	Aperture (flash aperture) setting
<b>P</b> (Aperture-priority AE)	Auto (1/60 to 1/200 sec.)	Auto
<b>Tv</b> (Shutter-priority AE)	Manual (30 to 1/200 sec.)	Auto
<b>Av</b> (Aperture-priority AE)	Manual (30 to 1/200 sec.)	Manual
<b>M</b> (Manual exposure)	Manual (30 to 1/200 sec.)	Manual
<b>A-DEP</b> (Auto. Depth-of-Field AE)	Auto (1/60 to 1/200 sec.)	Auto



- When using an EX-series Speedlite, press the built-in flash back into the camera before mounting the external flash.
- When using the built-in flash, keep at least 1 m/3.3 ft away from the subject. Otherwise the lens barrel may partially obstruct the flash coverage and cause part of the image to look dark.
- When using the built-in flash, detach any hood attached to the lens. A lens hood will partially obstruct the flash coverage.
- When a super telephoto lens or fast, large-aperture lens is attached, the built-in flash coverage might be obstructed.
- The built-in flash's coverage is effective with lens focal lengths as short as 18mm. Lens focal lengths shorter than 18mm will result in flash shot having a dark periphery.



- E-TTL is an abbreviation for Evaluative-Through-The-Lens.
- In **<Tv>** or **<M>** mode, if you set the shutter speed faster than 1/200 sec., the camera will automatically reset it to 1/200 sec.
- AF flash exposure is always based on the aperture value at the time the shot is taken, and controlled by E-TTL autoflash linked to the active AF point and weighted for the main subject.
- If the camera finds it difficult to focus, the AF-assist lamp (→p.39) will light automatically (except **<A>** **<S>** **<L>**).

### **C.Fn**

- C.Fn-05-3 disables the built-in flash from firing. (→p.147)
- C.Fn-15-1 enables 2nd-curtain sync with the built-in flash. (→p.150)
- With C.Fn-03-1, the flash sync speed will be fixed at 1/200 sec. in the **<Av>** mode. (→p.146)



## \* FE Lock

FE (flash exposure) Lock obtains and locks the correct flash exposure reading for any part of a subject. FE Lock is a function in the Creative zone.

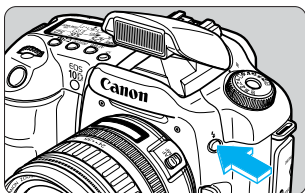

### 1 Check that the <⚡> icon is lit.

- Press the <⚡> button to pop-up the built-in flash.
- In the viewfinder, check that the <⚡> icon is lit.

### 2 Focus on the subject.

- Focus on the subject you want to lock the flash exposure on.

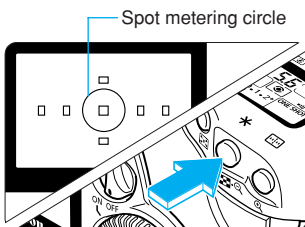

### 3 Press the <✳> button. (Ⓜ16)

- Aim the partial metering circle over the subject where you want to lock the flash exposure, then press the <✳> button.
  - ▶ The Speedlite fires a preflash and records the required flash output for this subject in memory.
  - ▶ The <✳> icon lights in the viewfinder.
  - ▶ The center AF point will flash in red.
  - ▶ In the viewfinder, the display appears as shown in ① for 0.5 seconds, then changes to ②.
- Each time you press the <✳> button the preflash fires, and the FE lock is applied at the required exposure level.



### 4 Shoot.

- Compose the shot and shoot.



⚠ If the subject is too far away and beyond the effective range of the flash, the <⚡> icon will blink. Get closer to the subject and repeat steps 2 to 4.

**C.Fn** C.Fn-13-4 enables FE lock with just the <☒> button. (→p.150)

## Flash Exposure Compensation

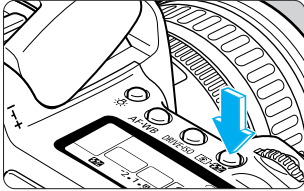

Flash exposure compensation can be set in the same way as with exposure compensation. It can be set up to +/-2 stops in 1/2-stop increments. Flash exposure compensation works in Creative Zone modes.

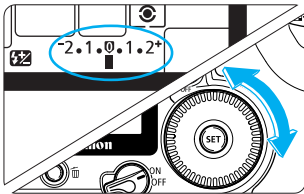

**1** Press the  button. ( 06)



**2** Set the flash exposure compensation amount.

- Turn the  switch to <ON>, then turn the  dial to set the desired flash exposure compensation amount at the viewfinder or LCD panel.
- “+” indicates increased flash exposure, and “-” indicates decreased flash exposure.

Decreased exposure



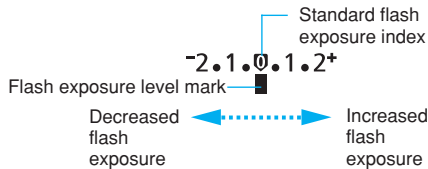

Increased exposure



- To cancel the flash exposure compensation, set the flash exposure compensation amount to .

**3** Shoot.



- The flash exposure compensation amount will remain in effect even after you turn the  switch to <OFF>.
- In step 2, turning the  dial sets the metering mode. (→p.74)



- With C.Fn-06-1, you can set the camera to adjust exposure compensation in 1/3-stop increments. (→p.147)
- With C.Fn-14-1, you can also disable the Auto reduction of fill flash function. (→p.150)

# Flash Shot with Speedlite 550EX

With Speedlite 550EX, flash shooting is as easy as any AE mode, and you can use the following features:

## ● E-TTL autoflash

With E-TTL autoflash (preflash evaluative metering), optimum flash exposure is obtained for the subject in focus. In the aperture-priority AE mode, a slow sync speed is set automatically in low-light situations to obtain a natural-looking, balanced exposure between the subject and background.



## ● High-Speed Sync (FP Flash)

High-speed sync (FP or focal-plane flash) enables flash synchronization with all shutter speeds from 30 sec. to 1/4000 sec.

## ● FE (Flash Exposure) Lock

FE lock obtains and locks the correct flash exposure for any part of the subject. This is the flash exposure lock equivalent of AE lock.

## ● Flash exposure compensation

Like normal exposure compensation, flash exposure compensation can be used to set the flash output up to  $\pm 2$  stops in 1/2-stop increments.

## ● FEB (Flash Exposure Bracketing)

As with AEB (autoexposure bracketing), flash exposures can be bracketed up to  $\pm 3$  stops in 1/2-stop increments.

## ● E-TTL wireless autoflash with multiple Speedlites

E-TTL autoflash can also be implemented with multiple wireless Speedlites. All the features listed above can be used, and no connections codes are required. Sophisticated lighting effects can be obtained as easily as using a Speedlite directly attached to the camera.



- In difficult focusing conditions, the AF-assist beam is emitted from the 550EX Speedlite, and automatically linked to the active AF point
- With an external, EOS-dedicated Speedlite, the camera will be a Type-A camera (compatible with E-TTL autoflash).

## Full Auto Flash

Using the <P> (Program AE) mode with E-TTL autoflash is described below. Regarding the operation of the 550EX, refer to the Speedlite's instructions.

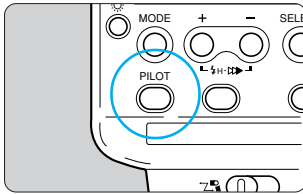

Flash-ready icon

- 1 Set the Mode Dial to <P>.
- 2 Make sure the Speedlite 550EX's pilot lamp is on.
- 3 Focus the subject, and shoot.
  - Make sure the flash-ready indicator <⚡> is on, and check the shutter speed and aperture value before shooting.

## Taking Flash Shots in Each Shooting Mode

Even in <Tv> <Av> <M> modes, E-TTL autoflash is as easy as normal shooting without flash.

- (1) Press the shutter button down halfway to have the camera automatically set the shutter speed or aperture value, just as in normal shooting without flash.

Mode	Shutter speed setting	Aperture (flash aperture) setting
<b>Tv</b> (Shutter-priority AE)	Manual (30 to 1/200 sec.)	Auto
<b>Av</b> (Aperture-priority AE)	Auto (30 to 1/200 sec.)	Manual
<b>M</b> (Manual exposure)	Manual (30 to 1/200 sec.)	Manual

\* If <Av> is set in low-light conditions, a slow shutter speed will be set. Therefore, use a tripod to prevent camera shake.

- (2) When you press the shutter button fully, the image will be captured with E-TTL autoflash based on the aperture set by preflash in (1).
- (3) The background exposure is determined by the shutter speed and aperture value.



- Flash shooting in <A-DEP> mode operates the same as in <P> mode.
- In the Basic Zone modes, it will be automatic and as easy as flash shooting with the built-in flash.

### C.Fn

- With C.Fn-05-3, you can disable the EX-series Speedlite from firing. (→p.147)
- With C.Fn-03-1, the flash sync speed will be fixed at 1/200 sec. in the <Av> mode. (→p.146)

## ⚡<sub>H</sub> High-Speed Sync (FP Flash)

When the Speedlite 550EX is set to high-speed sync <⚡<sub>H</sub>> mode, it can automatically synchronize at any shutter speed of 1/200 second or faster, thus providing high-speed sync (FP) flash operation. When high-speed sync is On, the <⚡<sub>H</sub>> icon appears in the viewfinder. High-speed sync is effective for portrait shot in the following situations:

- **When you want to use daylight sync flash for a portrait, and widen the aperture (reduce the aperture value) to blur the background.**
- **When you want to produce a catchlight in the subject's eyes.**
- **When you want to use fill flash to eliminate shadows.**



Normal flash



FP flash

## FEB (Flash Exposure Bracketing)

With the Canon Speedlite 550EX, three successive flash shots can be bracketed automatically up to +/-3 stops in 1/2-stop increments. The flash output is changed for the three shots while the background exposure remains the same.



Standard exposure (0)



Decreased exposure (-1.0)



Increased exposure (+1.0)

- FEB is applied from the 550EX Speedlite. For details, see the Instructions for your Speedlite.
- Make sure the Speedlite 550EX is ready before taking the next bracketed shot. Single-frame shooting in <□> mode is recommended.

### C.Fn

With C.Fn-06-1, you can set the camera to change FEB settings in 1/3-stop increments. (→p.147)



## ✖ FE Lock

The procedure for setting FE lock is the same as with the built-in flash (→p.100). FE lock works in both the normal flash and high-speed sync (FP flash) modes.

## ⚡ Flash Exposure Compensation

For flash shots with flash exposure compensation, see “Flash Exposure Compensation” for the built-in flash. (→p.101)



Flash exposure compensation can also be set with certain EX-series Speedlites. If flash exposure compensation is set with both the Speedlite and camera, the Speedlite's flash exposure compensation setting will override the camera's.

## Modeling Flash

Modeling flash allows you to see shadows, light balance, and other effects produced by multi-flash settings.

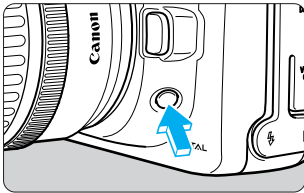

- 1 Check that the camera and Speedlite are properly set for flash shot.
- 2 Press the camera's depth-of-field preview button.

- The 550EX will fire a series of flashes for 1 sec. at 70 Hz.

## Wireless Multi-Flash/E-TTL Autoflash Shooting

Speedlite 550EX has the following three features:

- (1) **E-TTL autoflash**
- (2) **Slave unit feature**
- (3) **Master unit feature for wireless control of 550EX slave units**

By using the above features, you can set up a wireless E-TTL autoflash system with multiple Speedlite 550EXs.

You can also set a flash output ratio for up to three groups of Speedlites. Also main and sub Speedlites can create the desired flash lighting effect.

- For details, see the 550EX and ST-E2's Instructions booklet.



Macro Ring Lite MR-14EX and Macro Twin Lite MT-24EX can also be used as the master unit, and Speedlite 420EX can also be used as a slave unit.

# Using Non-Canon Flash Units

## Sync Speed

The EOS 10D can synchronize with compact, non-Canon flash units at shutter speeds of 1/200 sec. or slower. With larger studio flash units, the flash sync speed is 1/60 sec. or slower. Be sure to test the flash you are using beforehand, to make sure it synchronizes properly with the camera.

## PC Terminal

The camera's PC terminal is provided for flash units attached with a sync cord. The PC terminal is threaded to prevent the sync cord from disconnecting inadvertently.



- If the camera is used with a flash unit or flash accessory dedicated to another camera brand, the camera may not operate properly and malfunction may result.
- Some large studio flash units have a sync cord polarity that is the opposite of the EOS 10D's PC terminal. Such flash units will not work with the EOS 10D unless you change the polarity of the sync cord. Consult the manufacturer of the flash unit, or purchase a commercially-available polarity conversion cord. The camera's PC terminal polarity is shown in the figure on the right.
- Do not use a high voltage flash on the hot shoe. It might not fire.

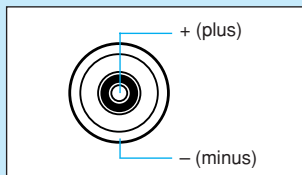

The camera can be used while a Speedlite is attached to the hot shoe and another flash unit connected to the PC terminal at the same time.

# TTL and A-TTL Autoflash Speedlites

- With TTL and A-TTL autoflash Speedlites (EZ, E, EG, ML, and TL series), the flash will not fire in the TTL or A-TTL autoflash mode. If the Speedlite has a manual mode, use the manual mode instead.
- If Speedlite 550EX's C.Fn-3-1 has been set, the flash will not fire in the TTL autoflash mode.

This chapter explains how to view and erase images and how to connect the camera to a TV monitor.

# 8

## Image Playback

### **When attempting to playback images not taken with the camera:**

The camera might not be able to properly display images captured with a different camera or edited with a personal computer for image processing or changing the file name.

# Image Playback

You can view images in different ways. Besides selecting and viewing a single image, you can view the image with shooting information, an index of thumbnails, and a magnified view. You can also rotate the image and jump to an image far ahead or back.

Single Image

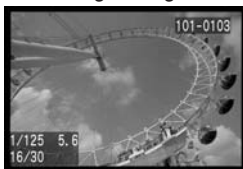
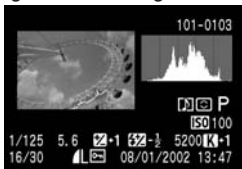

Image with shooting information



Index display



Magnified view by 1.5x

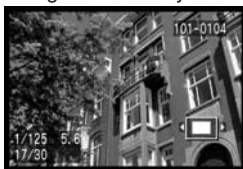

Magnified view by 10x

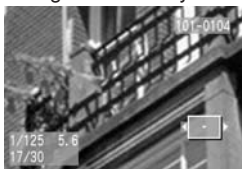

Rotated image



## ▶ Single image



### 1 Playback the image.

- Press the <◀> button.
- ▶ The last captured image will appear on the LCD monitor.

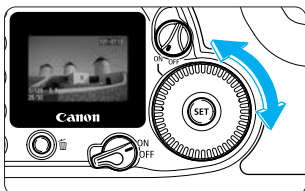

### 2 View another image.

- Turn the <◯> dial counterclockwise to view the preceding (older) image.
- Turn the <◯> dial clockwise to view the next (newer) image.
- To quit the playback, press the <▶> button. The LCD monitor will turn off.



If you leave the camera in the playback mode, the playback mode will quit automatically after the auto power off time elapses. (→p.142)

## INFO. Image with Shooting Information

While an image is displayed on the LCD monitor, press the <INFO.> button to display the image's shooting information.

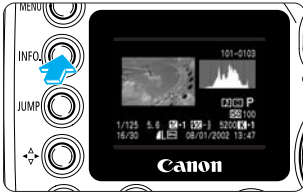

### Press the <INFO.> button.

- While a single image is displayed, press the <INFO.> button.
- You can change the displayed image by turning the <ZOOM> dial.
- Pressing the <INFO.> button toggles between the single image display and image with shooting information display.

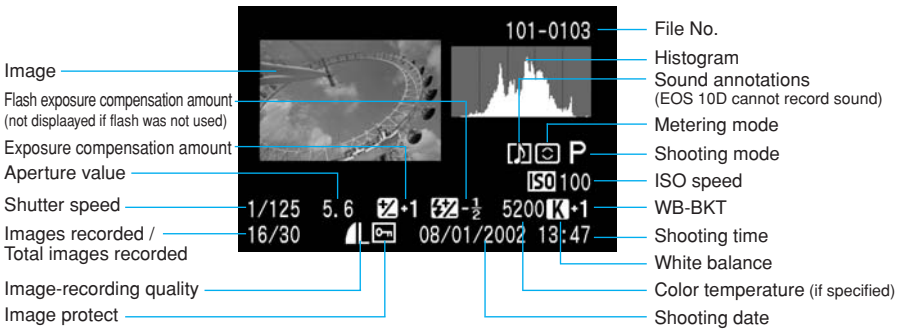

- While the camera is ready for shooting, pressing the <INFO.> button will display the camera settings as explained in “Checking Camera Settings.” (→p.62)
- The image with shooting information will also be displayed when you press the <INFO.> button during autoplay, image rotation, and image protection.

## Histogram

A histogram is a graph indicating the image's brightness. The horizontal axis indicates the brightness level, while the vertical axis indicates how many pixels exist for each brightness level. From left to right on the horizontal axis, the brightness goes from dark to bright.

The more pixels there are toward the left, the darker the image. The more pixels there are toward the right, the brighter the image.

If there are too many pixels on either side, you can set exposure compensation (→p.89) to take the shot again so that the exposure is more accurate.

### Sample histogram

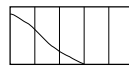

Dark image

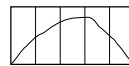

Normal image

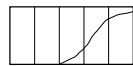

Bright image

## Highlight Alert

When shooting information display is set, the over-exposed portion will be shown with blinking warning. For better results check the histogram and adjust the exposure compensation towards the decreased exposure end, then take the shot again.

## Index Display

Nine thumbnail images are displayed on one screen.

### 1 Set the camera to the playback mode.

- Press the <▶> button.
- ▶ The last captured image will appear on the LCD monitor.



### 2 Display the index.

- Press the <☒> button.
- ▶ The selected thumbnail will be highlighted with a green border.

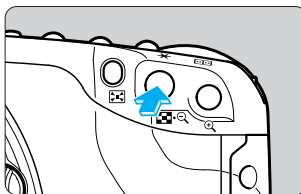

### 3 Select an image.

- Turn the <◀> dial counterclockwise to select the preceding (older) image.
- Turn the <◀> dial clockwise to select the next (newer) image.

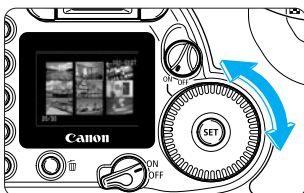

### 4 From the index display, switch to any other display mode.

- To display a single image, press the <▶> button.
- To display the image with shooting information, press the <INFO.> button.
- Pressing the <◀> button switches to the single image display and pressing it again switches to magnified view. (→p.111)



While the index is displayed, press the <JUMP> button and turn the <◀> dial to jump nine images ahead or back. (→p.112)



## Magnified View

The selected image can be magnified by 1.5x to 10x on the LCD monitor.

### 1 Display the image to be magnified.

- Display the single images or image with shooting information.

### 2 Magnify the image.

- Press the  button.
- ▶ The center of the image will be magnified.
- To increase the magnification, hold down the  button.
- Press the  button to reduce the magnification. Hold down the button to continue reducing the magnification until it reaches the size in step 1.

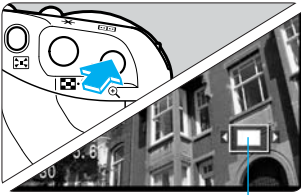

Magnified portion

1.5x





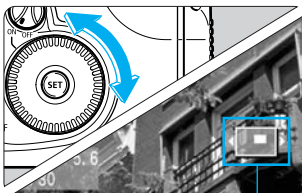
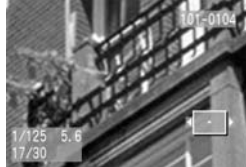



10x



Scroll direction



### 3 Scroll around.

- Turn the  dial to scroll the magnified portion horizontally over the image.
- To scroll vertically, press the  button then turn the  dial. The  button toggles between horizontal and vertical scrolling.
- The scroll direction is indicated by the  or  arrows displayed on the LCD monitor.
- To magnify a different portion of the image, repeat steps 2 and 3.
- To quit the magnified display, press the  button.



While in the magnified view, you can maintain the same magnified position and magnification when you turn the  dial to view another image.

## JUMP Image Jump

While single image, image with shooting information, index, or magnified image is displayed, you can jump images ahead or back.

### 1 Set the camera for playback.

- Display a single image, image with shooting information, index, or magnified image.



Jump bar

### 2 Set jump display.

- Press the <JUMP> button.
- ▶ The jump bar will appear at the bottom of the screen.

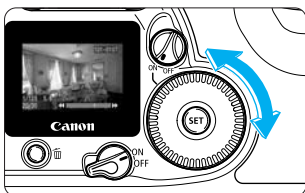

### 3 Jump forward or back.

- Turn the <DIAL> dial. (Turn the <DIAL> dial during magnified view.)

#### During single image, image with shooting information, and magnified display:

- Turn the dial counterclockwise to jump ten images backward, or turn it clockwise to jump ten images forward. During the magnified view, the magnified position and magnification will be maintained during the image jump.



#### During index display:

- Turn the dial counterclockwise to jump nine images backward, or turn it clockwise to jump nine images forward.



- To quit the image jump, press the <JUMP> button. The jump bar will disappear.

Magnified view with jump bar



Index display with jump bar

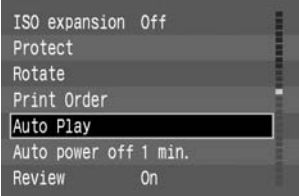

Image jump is also possible during image protection and image rotation.



## **MENU** Automated Playback of Images (Auto playback)

This function automatically and continuously displays all images recorded on the CF card. Each image is displayed for approximately 3 seconds.



### 1 On the menu, select [Auto Play].

- Press the <MENU> button.
- Turn the <DISP> dial to select [Auto Play].

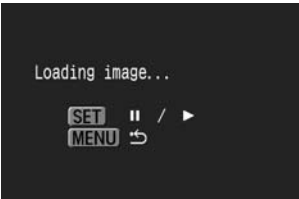

### 2 Start the auto play.

- Press <SET>.
- ▶ After the images load for 2 sec., auto play will start.
- To pause the auto play, press <SET>.
- During pause, [||] will be displayed on the upper left of the image. Press <SET> again to resume the auto play.
- To quit the auto play, press the <MENU> button.

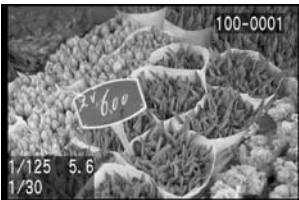

- During auto play, auto power off will not work. (→142) After you finish viewing the images, press the <MENU> button to quit the auto play.
- The display time may vary depending on the image.



During auto play pause, you can turn the <DISP> dial to display another image.

## MENU Rotating an Image

The Rotate function can rotate an image 90° or 270° clockwise. This allows you to play images with the correct orientation.

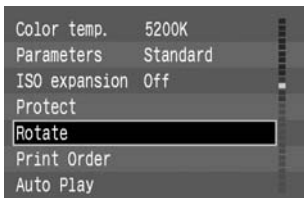

### 1 On the menu, select [Rotate].

- Press the <MENU> button.
- Turn the <DISP> dial to select [Rotate], then press <SET>.
- ▶ The image rotation screen will appear.
- Press the <DISP> button to display image rotation screen for the index display.



### 2 Rotate the image.

- Turn the <DISP> dial to select the image to be rotated, then press <SET>.
- ▶ Each time you press <SET>, the image will rotate clockwise by 90°, 270°, and 0°.
- To rotate another image, repeat step 2.
- To quit the image rotation, press the <MENU> button. The menu will reappear.



This vertical image was taken while the camera grip was pointing downward. It has been rotated by 90°.



This vertical image was taken while the camera grip was pointing upward. It has been rotated by 270°.



- If the shot was taken vertically with the camera grip pointing downward or upward, rotate the image by 90° or 270° respectively to display it upright.
- If you have set [Auto rotate] to [On] (→p.61) on the menu before taking vertical shots, you need not rotate the image as above.
- Image rotation is also possible during image with shooting information display and magnified view.

# Connecting to a TV

You can connect the EOS 10D to a television (using the video cable provided with your camera) to display your recorded images. Always turn off the camera and the television before connecting or disconnecting them.

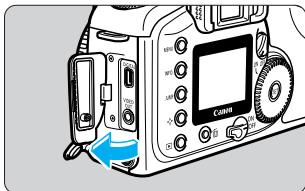

## 1 Open the cover.

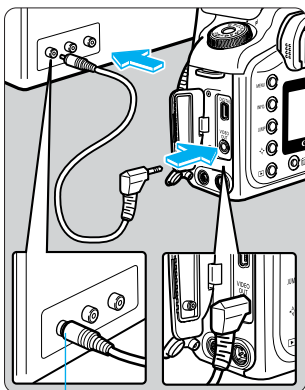

## 2 Connect the cable.

- Use the video cable (provided) to connect the camera's < VIDEO OUT > terminal to the TV monitor's VIDEO IN terminal.
- Insert the cable plug all the way, until it clicks into place.

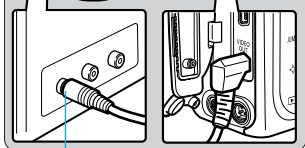

## 3 Turn the TV on, and set the input switch to Video In.

Video input terminal

## 4 Set the < [ON/OFF] > switch to < ON >.

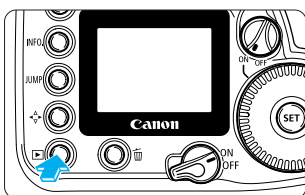

## 5 Press the < [PLAY] > button.

- ▶ The image appears on the TV screen.
- While looking at the TV monitor, you can view images and set the menu settings as you can with the LCD monitor.
- When you finish, set the < [ON/OFF] > switch to < OFF >, turn the TV off, then disconnect the video cable.



- If the camera is set to the wrong video system format (→p.144), you will not see a proper image on the TV set. Make sure the camera is set to the video system format (NTSC or PAL) compatible with the TV set.
- Depending on the TV monitor, the image periphery may appear dark similar to mirror cut-off.



- Using AC Adapter Kit ACK-E2 (optional) is recommended. (→p.174)
- Images and menus do not appear on the LCD monitor while the video cable is connected to the camera.
- You can also switch the TV video signal to [PAL] (→p.144). The default setting is for the [NTSC] signal standard.

# MENU Image Protection

You can protect images to prevent accidental erasure.

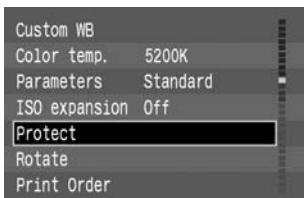

## 1 On the menu, select [Protect].

- Press the <MENU> button.
- Turn the <O> dial to select [Protect], then press <SET>.
- ▶ The protect setting screen will appear.
- Press the <+Q> button to display the protect screen for the index display.



Image protection icon

## 2 Set the image protection.

- Turn the <O> dial to select the image to be protected, then press <SET>.
- ▶ When an image is protected, the <P> icon will appear below the image.
- To cancel the image protection, press <SET> again. The <P> icon will disappear.
- To protect another image, repeat step 2.
- To quit the image protection, press the <MENU> button. The menu will reappear.



Once an image is protected, it cannot be removed by the camera's Erase function. To erase a protected image, you must first remove the protection.



- If you protect the images you need and erase all the images at once (→p.118), all non-protected images will be erased. This is handy when you want to erase all the images you do not need at once.
- Image protection is also possible during image with shooting information display and magnified view.

# Erasing an Image

You can erase images one by one or erase all the images in the CF card.

- Once an image is erased, it cannot be recovered. So be careful when erasing an image.
- To prevent important images from being erased accidentally, protect it.

## Erasing a Single Image



### 1 Set the camera for playback.

- Press the  button.
- ▶ The last captured image will appear on the LCD monitor.

### 2 Select the image to be erased.

- Turn the  dial to select the image to be erased.



### 3 Display the erase menu.



- Press the  button.
- ▶ The erase menu will appear at the bottom of the screen.



- In step 2, you can press the  button before going to step 3. This will display the index.



### 4 Erase the image.

- Turn the  dial to select [Erase], then press .
- ▶ The access lamp will blink and the image will be erased.
- To erase another image, repeat steps 2 to 4.
- To quit the playback, press the  button. The LCD monitor will turn off.

## Erasing All Images

### 1 Set the camera for playback.

- Press the  $\langle \text{▶} \rangle$  button.
- ▶ The last captured image will appear on the LCD monitor.



### 2 Display the erase menu.

- Press the  $\langle \text{⏏} \rangle$  button.
- ▶ The erase menu will appear at the bottom of the screen.

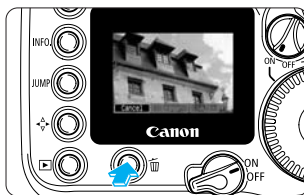

### 3 Select [All...].

- Turn the  $\langle \text{○} \rangle$  dial to select [All...], then press  $\langle \text{SET} \rangle$ .
- ▶ The confirmation dialog will appear.



### 4 Erase the images.

- Turn the  $\langle \text{○} \rangle$  dial to select [OK], then press  $\langle \text{SET} \rangle$ .
- ▶ All unprotected images will be erased.
- Press  $\langle \text{SET} \rangle$  to cancel erasure during image erasing.



Once an image is erased, it cannot be recovered. Make sure you no longer need the image before erasing it.



- If you protect the images you need (Æp.116) and erase all the images at once, all non-protected images will be erased. This is handy when you want to erase all the images you do not need at once.
- Images can be erased during image with shooting information display, index display and magnified view.

# MENU Formatting the CF Card

The CF card must be formatted before it is used in the EOS 10D camera. Also, if you see the message “Err CF” (CF card error) on the LCD panel when you load a CF card, the CF card may need to be formatted before it can be used.

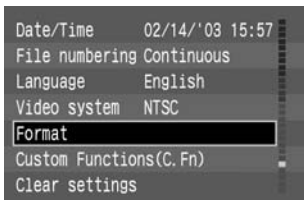

## 1 On the menu, select [Format].

- Press the <MENU> button.
- Turn the <Q> dial to select [Format], then press <SET>.
- ▶ The confirmation dialog will appear.

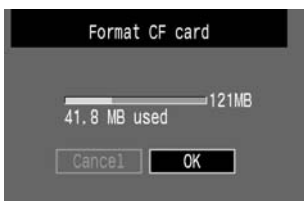

## 2 Format the CF card.

- Turn the <Q> dial to select [OK], then press <SET>.
- ▶ The CF card will be formatted (initialized).
- ▶ When the CF card formatting is completed, the menu will reappear.



 Formatting a CF card will erase all information on the card, including protected images. Be sure to carefully review the contents of a CF card before formatting.



- A non-Canon CF card or a CF card formatted with another camera or personal computer might not work with the EOS 10D camera. In such a case, format the CF card with the camera first. Then it might work with the camera.
- If you insert the CF card and the CF card error message “Err CF” appears, use a utility program such as Scan Disk to diagnose and fix the CF card.
- If the CF card error message “Err CF” appears even after you format the CF card, or you use Scan Disk or a similar utility program, use another CF card instead.





By using the dedicated cable to connect the camera to a card photo printer or Canon BJ printer compatible with direct printing, you can easily print images directly from the camera. All direct printing operations can be done with the camera.



# Direct Printing from the Camera

---

# Direct Printing

By connecting the camera to a card photo printer (optional) or Canon BJ printer (optional) compatible with direct printing, you can easily print images directly from the CF card. You control the printing operation with the camera buttons. This is called direct printing. Images having DPOF settings (→p.131) can also be printed directly from the camera.

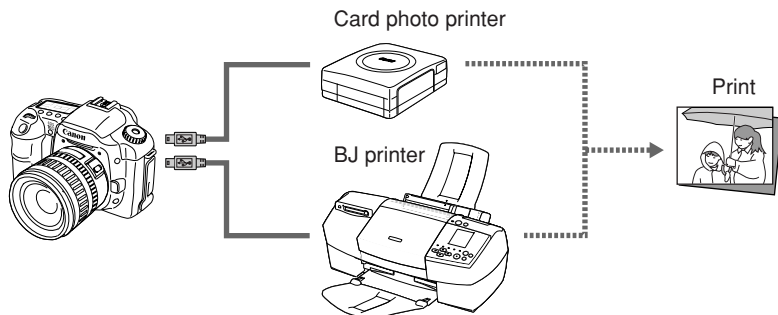

- For direct printing, using AC Adapter Kit ACK-E2 (optional) to power the camera is recommended. (→p.174)
- If a battery pack will be used to power the camera, be sure to fully recharge it first. While printing, monitor the battery level.



For instructions on how to install the ink cassette, ink tank, and paper into the printer, refer to the printer's manual.

## Connect the Camera to the Printer

### Connecting to a Card Photo Printer

To connect the camera and printer with the necessary cable, refer to the instructions that came with the printer.

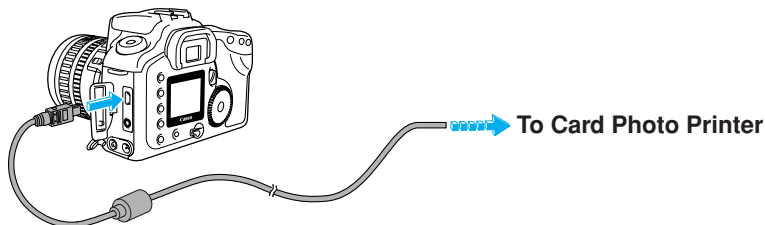

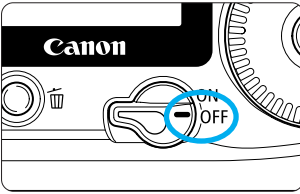

**1 Turn the <☞> switch to <OFF>.**  
(→p.30)

**2 Set up the printer.**

- For details, refer to the printer's manual.

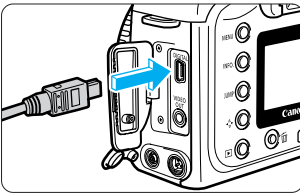

**3 Connect the camera to the card photo printer.**

- To connect the camera and printer with the necessary cable, refer to the instructions that came with the printer.
- Check the shape of cable's plug and connect the camera and printer.
- When connecting the cable plug to the camera's <DIGITAL> terminal, the cable plug's <☞> icon must face the front side of the camera.

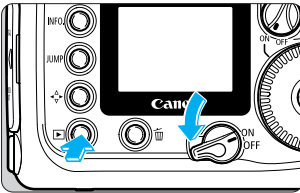

**4 Turn the camera's <☞> switch to <ON>, then press the <▶> button.**

- ▶ An image in the CF card will be displayed.

Indicates that a card photo printer is connected.



**5 Turn on the printer.**

- Press the printer's main switch to turn it on.
- ▶ The <☞> icon will appear on the upper left on the camera's LCD monitor.
- In the case of Card Photo Printer CP-10, it will turn on in step 2 when you connect the power cable.

## Connecting to a Canon BJ Printer

To connect the camera and printer with the necessary cable, refer to the manuals that came with the printer.

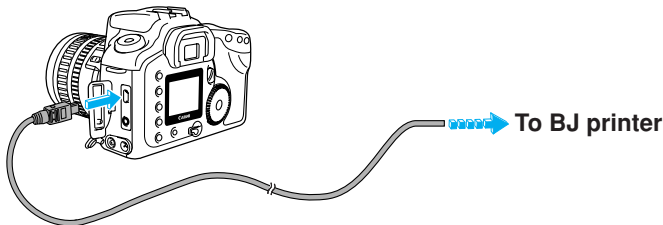



**1** Follow steps **1** to **3** in “Connecting to a Card Photo Printer” to connect the camera to the BJ printer. (→p.123)

**2** Turn the camera's  switch to **<ON>**, then press the  button.

▶ An image in the CF card will be displayed.



**3** Turn on the printer.

- Press the printer's power button to turn it on.
- ▶ The  icon will appear on the camera's LCD monitor.
- ▶ The  icon will appear on the printer's operation panel.

BJ printer-connected icon



-  • When disconnecting the cable from the camera's **<DIGITAL>** terminal, be sure to grasp the plug instead of the cord to pull it out.
- Do not use any cable other than the dedicated interface cable to connect the camera and printer.

-  • To disconnect the cable from the camera and printer, follow the procedure below:
  1. Turn off the camera.
  2. Disconnect the cable from the printer.
  3. Disconnect the cable from the camera.
- When you disconnect the camera from the printer, the  icon or  icon will disappear from the camera's LCD monitor and the camera will return to normal playback.
- Even while the camera is connected to the printer, you can instantly switch to shooting by pressing the shutter button halfway (except during actual printing).

# Printing

You do all the printing operations with the camera.

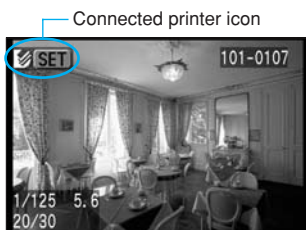

## 1 Select the image to be printed.

- Check that the or is displayed on the upper left of the camera's LCD monitor.
- Turn the dial to select the image to be printed.
- Images in the **RAW** format cannot be printed directly from the camera.

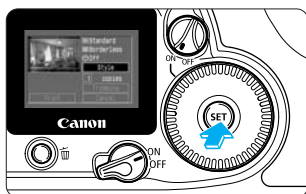

## 2 Press .

- ▶ The direct printing screen will appear.
- To change the image to be printed, press the **<MENU>** button and start from step 1.

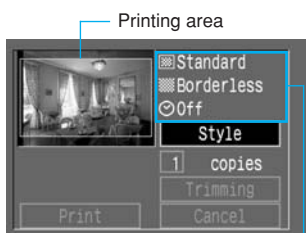

## 3 Set the printing options.

See pages 127-130 to set the printing options.

### With a card photo printer:

- On the upper right of the screen, you can check the print style settings. And on the upper left, you can check the printing area.
- If the printing paper does not match the printing settings (single or multiple images), go to the **[Style]** (→p.127) and **[Image]** menu to select the proper setting (**[Standard]** or **[Multiple]**).
- If the printing settings are okay, go to step 4.

### With a BJ printer:

- Be sure to set the **[Paper]** setting with **[Style]** (→p.127).



## 4 Print the image.

- Turn the dial to select **[PRINT]**, then press .
- ▶ Printing will start.
- If **[Stop]** is displayed on the LCD monitor, you can stop the printing.(→p.126)
- When the printing is completed properly, the screen returns to step 1.

## Stopping the Printing

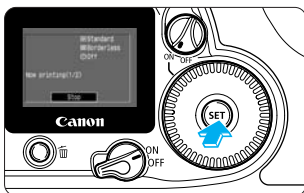

While **[Stop]** is displayed on the LCD monitor, press **<SET>**.

- ▶ The printing will stop.
- ▶ If the confirmation dialog appears, turn the **<OK>** dial to **[OK]**, then press **<SET>**.



### When Stopping the Printing

#### With a card photo printer:

If only one print is being printed, you cannot stop the printing. If multiple prints are being printed, the printing will stop after the current print is finished printing.

#### With a BJ printer:

The printing will stop and the paper being printed will be discharged.

### Resolving Printing Errors

If an error occurs during printing, the error message (→p.167) will be displayed on the LCD monitor. Turn the **<OK>** dial to select **[Stop]/[Resume]**, then press **<SET>**.

#### With a card photo printer:

Depending on the error, **[Resume]** might not be displayed. In this case, select **[Stop]**.

#### With a BJ printer:

Depending on the error, either **[Resume]** or **[Stop]** will be displayed.

The error number will be displayed on the BJ printer's operation panel. Refer to the BJ printer's manual to see the error number description and resolve the error. When the error is resolved, the BJ printer will resume printing automatically.



If the camera is connected to the printer and you do not operate it for five minutes, the camera power will turn off automatically. However, if the auto power off (→p.142) time is longer than 5 minutes, then that setting will take effect instead.



- **RAW** images cannot be printed directly.
- Images taken with **[Adobe RGB]** set as the color space will have low color saturation when printed directly from the camera with a BJ printer.

# Printing Options

For direct printing, you can set the number of copies, the printing style, and the printing area (trimming).

## Setting the Quantity



**1** On the direct printing screen, turn the <O> dial to select [copies], then press <SET>.

▶ The <◆> icon will appear beside [copies].



**2** Set the number of copies.

- Turn the <O> dial to set the number of copies, then press <SET>.
- You can set any number from 1 to 99.

## Setting the Printing Style

The available [Style] settings will differ depending on the type of printer connected to the camera.

**With a card photo printer:**

Image Display	<input checked="" type="radio"/> Single image	A single image will be printed on the paper.
	<input checked="" type="radio"/> Multiple images*	Eight images of the same shot will be printed on the paper.
Borders	<input checked="" type="radio"/> Borderless	The image will be printed on the entire paper without borders.
	<input checked="" type="radio"/> Bordered	The print will have borders.
Date Imprint	<input checked="" type="radio"/> Off	The print will not have a date imprinted.
	<input checked="" type="radio"/> On	The date recorded for the image will be imprinted.

\* Displayed only when credit card-size paper is used for printing.

**With a BJ printer:**

<input checked="" type="radio"/> Paper		Select the paper size: [Card#1], [Card#2], [Card#3], [LTR], or [A4]. Refer to the BJ printer's manual for the selectable paper sizes.
Borders	<input checked="" type="radio"/> Borderless	The image will be printed on the entire paper without borders.
	<input checked="" type="radio"/> Bordered	The print will have borders.
Date	<input checked="" type="radio"/> Off	The print will not have a date imprinted.
	<input checked="" type="radio"/> On	The date recorded for the image will be imprinted.



## 1 On the direct printing screen, select [Style].

- Turn the dial to select [Style], then press <SET>.
- ▶ The [Style] setting screen will appear.



## 2 Select the style setting.

- Turn the <O> dial to select [Image] / [Paper], [Borders], or [Date], then press <SET>.

## 3 Set the style setting.

- Turn the <O> dial to select the desired setting, then press <SET>.

### [With a card photo printer]



### [With a BJ printer]

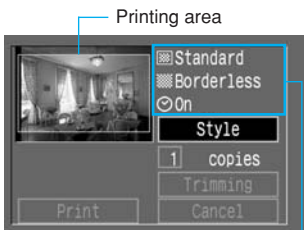
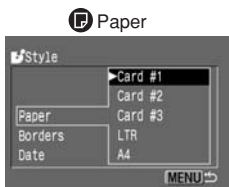

## 4 Exit the style setting screen.

- Press the <MENU> button.
- ▶ The style setting screen will quit and the direct printing screen will appear.
- On the upper right of the screen, you can check the print style settings. And on the upper left, you can check the printing area.



**!** If you select [**Multiple**], [**Borders**] will be set to [**Borderless**] and [**Date**] will be [**Off**].

- If you select [**Multiple**], part of the image will be cut off vertically and horizontally when printed.
- If you select [**Bordered**], almost all of the image area (as displayed on the LCD monitor) will be printed. The printing area frame will not be displayed.

## Trimming

You can trim the image for printing. To trim an image, first see “Setting the Printing Style” (→p.127).



### 1 On the printing style screen, select [Trimming].

- Turn the <ⓘ> dial to select [**Trimming**], then press <SET>.
- ▶ The [**Trimming**] screen will appear.

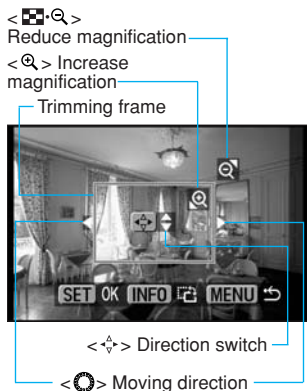

### 2 Trim the image.

- The operation icons in the image area will disappear while you trim the image. They will reappear after 5 sec. of non-operation.
- **Changing the trimming frame size**
  - Press the <⊟> or <⊞⊟> button to change the size of the trimming frame.
  - The trimming frame's horizontal dimension can be adjusted to one of eight sizes, and the vertical dimension can be adjusted to one of five sizes.
  - The trimming frame's minimum size is about half the screen size and the maximum size is almost the same as the screen size.
  - If a card photo printer is used and the trimming frame degrades the image quality, the trimming frame color will change from green to red.



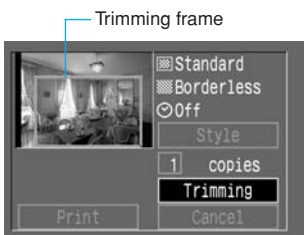

● **Moving the trimming frame**

- Turn the <O> dial to move the trimming frame horizontally or vertically.
- To move the trimming frame vertically, press the <▲> button to change the moving direction, then turn the <O> dial. Each time you press the <▲> button, the direction changes.
- The moving direction is indicated by the <◀▶> or <▲▼> arrows displayed outside the trimming frame.

● **Rotating the trimming frame**

- Press the <INFO.> button to rotate the trimming frame. The button toggles between the vertical and horizontal trimming orientation.

**3 Exit the trimming screen.**

- Press <SET>.
- ▶ The trimming screen will quit and the direct printing screen will appear.
- On the upper left, you can check the printing area of the image.



- When a BJ printer is connected to the camera, the color of the trimming frame will not change regardless of the trimming frame size (magnification).
- If you have set [Trimming] and then change the [Style] ([Image], [Borders]), the [Readjust trimming] message will appear on the LCD monitor. Set [Trimming] again or reset the [Style] settings.
- The [Trimming] setting will be canceled if you do any of the following:
  - Press the <MENU> button to quit the [Trimming] setting.
  - Set [Trimming] for another image.
  - Exit from direct printing.  
(Turn the <OFF> switch to <OFF> or press the shutter button halfway.)
  - Change the trimming frame to a size bigger than the maximum size.
- When setting [Trimming], use the camera's LCD monitor. If you use a TV monitor connected to the camera with a video cable, the trimming frame may not display correctly.



The shape of the trimming frame is determined by the [Image] and [Borders] settings.

With DPOF (Digital Print Order Format), you can specify which images in the CF card are to be printed and the quantity. This feature is very convenient when you make prints with a DPOF-compatible printer or printing lab.

# 10

## DPOF: Digital Print Order Format

### DPOF

DPOF (Digital Print Order Format) is a standard used to record (on the CF card or other recording media) the image number, number of prints, etc. of images taken by digital cameras.

- By fitting a CF card into a printer compatible with DPOF, you can make prints as specified.
- You will not need to fill out the desired numbers and quantities of prints when ordering prints from a printing lab.
- Printers capable of direct printing from the camera can print the images as specified by DPOF.

\* The camera uses DPOF Version 1.1.

# MENU Print Order

With the camera, you can select the images to be printed and the quantity. Then those images can be printed with a DPOF-compatible printer or printing lab as you have specified. Printers capable of direct printing from the camera can also print the images as specified by DPOF.

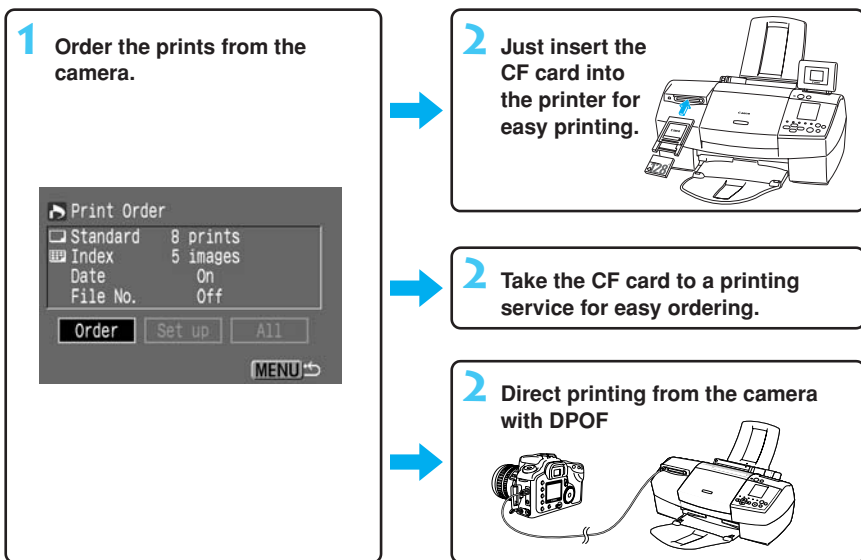

## Notes About DPOF

When printing with DPOF-compatible printers, note the following:

- Images in the **RAW** format cannot be printed. Movies and TIFF images captured with other cameras also cannot be printed.
- If DPOF was set with a different camera and the CF card is inserted in your EOS 10D camera, the <▲> icon may appear on the LCD monitor. If you then set DPOF settings, the previous DPOF settings will be completely overwritten.
- DPOF settings set with another DPOF-compatible equipment cannot be changed with your EOS 10D camera. They can only be changed with the original equipment.
- Depending on the DPOF-compatible printer and printing lab, the DPOF settings might not be applied to the printing. Refer to the printer's instruction booklet or consult the lab.

## Selecting the Images to be Printed

You can either select images individually or select all the images for printing.

### Selecting Individual Images

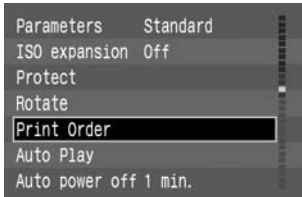

#### 1 On the menu, select [Print Order].

- Press the <MENU> button.
- Turn the <O> dial to select [Print Order], then press <SET>.
- ▶ The print order screen will appear.

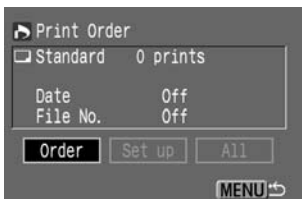

#### 2 Select [Order].

- Turn the <O> dial to select [Order], then press <SET>.
- ▶ The order screen will appear.



#### 3 Select the image to be printed.

- Turn the <O> dial to select the image, then press <SET>.
- ▶ If [Standard] or [Both] has been set for [Print Type] (→p.135), the quantity displayed on the upper left will be [1].
- ▶ If [Index] has been set for [Print Type] (→p.135), a checkmark <✓> will appear in the upper left box .
- If [Index] has been set, pressing <SET> will turn off the checkmark <✓> and the selection will be canceled.
- To display three images on the screen, press the <Q> button. Press the <Q> button to return to the previous screen.
- Images in the RAW format cannot be printed directly from the camera.

Three-image display

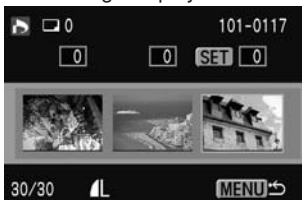



## 4 Set the printing quantity.

- While looking at the quantity on the screen, turn the <O> dial to set the desired quantity, then press <SET>.
- If [Print Type] (→p.135) has been set to [Index], the quantity cannot be set.
- To set the printing quantity of another image, repeat steps 3 and 4.
- ▶ The total quantity of prints is displayed next to the <O> icon.
- To exit the print order screen, press the <MENU> button.

## Selecting All Images

Except for RAW images, you can select all the images in the CF card to be printed.

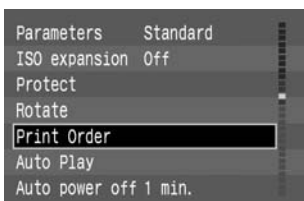

## 1 On the menu, select [Print Order].

- Press the <MENU> button.
- Turn the <O> dial to select [Print Order], then press <SET>.
- ▶ The print order screen will appear.

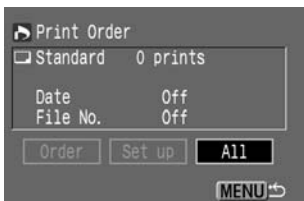

## 2 Select [All].

- Turn the <O> dial to select [All], then press <SET>.
- ▶ The All screen will appear.

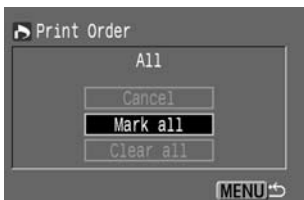

## 3 Select [Mark all].



- Turn the <O> dial to select [Mark all], then press <SET>.
- ▶ One print each will be specified for all the images, then the print order screen will reappear.
- If you select [Clear all], all the images selected for printing will be deselected.
- If you select [Cancel], the print order screen will reappear.



- The printing will start with the oldest image.
- Up to 998 images can be selected for printing.



## Printing Options

The [Set up] options are as follows:

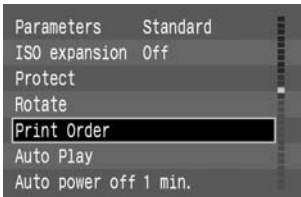
Print Type	 Standard	Prints one image on the paper.
	 Index	The images are made smaller to be printed as index images on the paper.
	 Both	Prints both the standard and index prints.
Date	Off	The print will not have a date imprinted.
	On	The date recorded for the image will be imprinted.
File No.	Off	The file No. is not imprinted on the print.
	On	The file No. is also imprinted on the print.



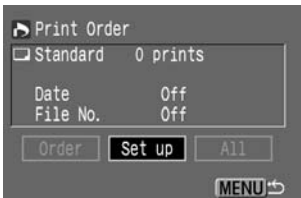

### 1 On the menu, select [Print Order].

- Press the <MENU> button.
- Turn the < > dial to select [Print Order], then press < >.
- ▶ The print order screen will appear.



### 2 Select [Set up].

- Turn the < > dial to select [Set up], then press < >.
- ▶ The set up screen will appear.

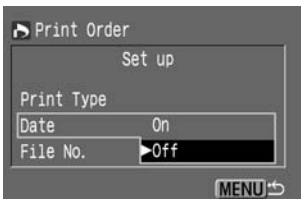

### 3 Select the set up option.

- Turn the < > dial to select [Print Type], [Date], or [File No.], then press < >.

## 4 Set the set up option.

- Turn the <O> dial to select the desired setting, then press <SET>.



### Print Type

- Select [**Standard**], [**Index**], or [**Both**].

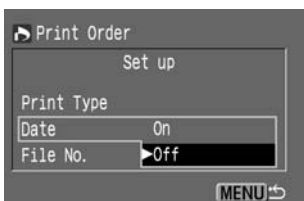

### Date

- Select [**On**] or [**Off**].

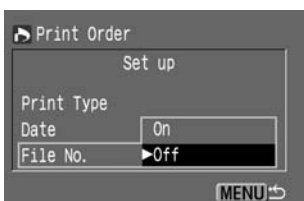

### File No.

- Select [**On**] or [**Off**].

## 5 Exit the set up screen.

- Press the <MENU> button. The print order screen will reappear.



- If [**Print Type**] has been set to [**Index**], the [**Date**] and [**File No.**] cannot both be set to [**On**] at the same time.
- If [**Print Type**] has been set to [**Both**], the [**Date**] and [**File No.**] can both be set to [**On**] at the same time. However, the index print will only have the File No. imprinted.



The imprinted date will be the date set with the menu's [**Date/time**] setting. (→p.154)



# Direct Printing with DPOF

With a printer compatible with direct printing, you can print according to the DPOF settings.

## 1 Connect the camera to the printer. (→p.122)

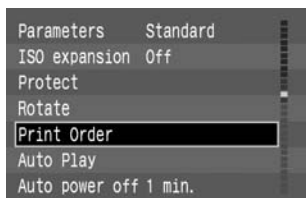

## 2 On the menu, select [Print Order].

- Press the <MENU> button.
- Turn the <O> dial to select [Print Order], then press <SET>.



## 3 Select [Print].

- Turn the <O> dial to select [Print], then press <SET>.
- If the camera is not connected to a printer, [Print] will not be displayed.
- If the printing options have not been set, [Print] will not be selectable.

Printing style settings

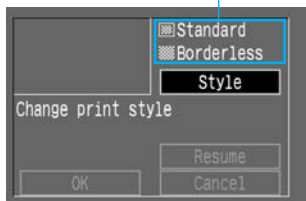

## 4 Set the printing style.

For details, see “Setting the Printing Style” (→p.127).

### With a card photo printer:

- Check the printing style settings displayed on the upper right. If the settings are okay, go to step 5.

### With a BJ printer:

- Be sure to set [Style] (→p.127) to the proper [Paper] setting.

Printing options

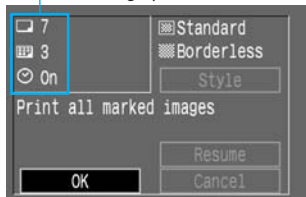

## 5 Start printing.

- Check the printing options displayed on the upper left.
- Turn the <O> dial to select [OK], then press <SET>.
- ▶ The printing will start.
- If [Stop] is displayed on the LCD monitor, you can stop the printing.(→p.126)
- When the printing ends, the screen will return to step 3 above.

## Stopping the Printing

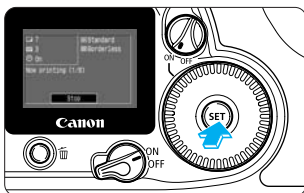

While **[Stop]** is displayed on the LCD monitor, press **< (SET) >**.

- ▶ The printing will stop.
- ▶ If the confirmation dialog appears, turn the **< (OK) >** dial to **[OK]**, then press **< (SET) >**.



### Stopping the Printing (→p.126)

#### Resuming the Printing

- On the direct printing screen, after printing is stopped, turn the **< (OK) >** dial to select **[Resume]**, then press **< (SET) >**.
- Printing cannot be resumed in the following cases:
  - Before resuming the printing, you changed the printing options.
  - Before resuming the printing, you erased an image that was to be printed.
  - When you stopped the printing, CF card's remaining capacity was low.
- If the printing stopped due to low battery power, using AC Adapter Kit ACK-E2 is recommended. Before using a battery pack, recharge it fully. (→p.174)

#### Handling Errors (→p.126)



- When the **[Print Type]** is set to **[Index]**, the number of images that can be printed on the paper depends on the paper size:
  - Credit card size: 20 images
  - L size: 42 images
  - Postcard size: 63 images
 (For a BJ printer, refer to the printer's manual for the number of images that can be printed on various papers.)



- Images taken with **[Adobe RGB]** (→p.58) set as the color space will have low color saturation when printed directly from the camera with a BJ printer.
- To imprint the date, do step **3** to select **[Set up]**, and set **[Date]** to **[On]**. In step **4**, the **[Style]** screen's **[Date]** option cannot be set. However, if the **[Print Type]** is **[Index]**, the date will not be imprinted even if **[Date]** is set to **[On]**.
- If **[Print Type]** has been set to **[Both]**, the **[Date]** and **[File No.]** can both be set to **[On]** at the same time. However, the standard printing will only have Date and the index print will only have the File No. imprinted.  
(A BJ printer does not imprint both date and the file No.)
- If **[Print Type]** is set to **[Standard]**, the file No. will not be imprinted even if **[File No.]** is set to **[On]**.

You can set the camera's various settings with on-screen menus. Especially settings for shooting are called Custom Functions (C.Fn). The **C.Fn** mark you see in this Instructions gives just a brief description of the respective Custom Function.

This chapter explains the menu settings and Custom Functions in detail. The menu setting procedure is described in "Menu Operations" on page 32.

# 11

## Menu Settings

---

# MENU Menu Settings

## Shooting Menu

Red

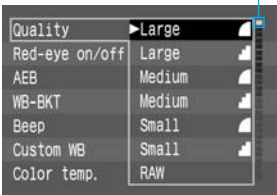

### Quality

Sets the recording quality of the image to be saved in the CF card. (→p.46)

Select any of the following: [Large ] [Large ] [Medium ] [Medium ] [Small ] [Small ] [RAW]

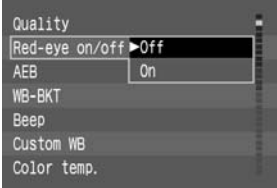

### Red-eye on/off

Enables [on] or disables [off] the red-eye reduction lamp during flash shot. (→p.99)

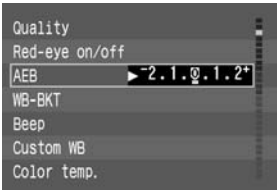

### AEB

Three consecutive shots are captured while the exposure setting is altered automatically for each shot. The exposure can be varied up to +/-2 stops in 1/2-stop increments. (→p.90)

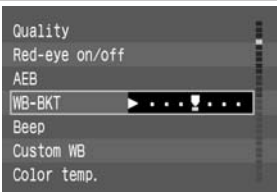

### WB-BKT (White balance bracketing)

A single shot captures three images each having a different color temperature. The white balance can be varied up to +/-3 stops in whole-stop increments based on the standard color temperature of current white balance mode. (→p.54)

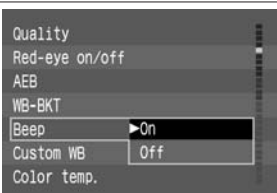

### Beep

Enables [on] or disables [off] the beeper sounding when focus is achieved and during self-timer operation.

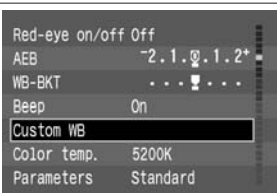

### Custom WB

Selects the reference image to be used for setting the white balance manually. (→p.52)

## Shooting Menu

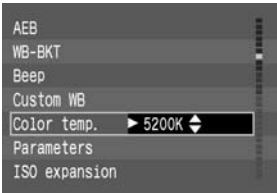
**Color temp.**

For setting the color temperature directly to match the color temperature detected by any hand-held color temperature meter. The settable range is [2800K] to [10000K] (in 100K increments). (→p.53)

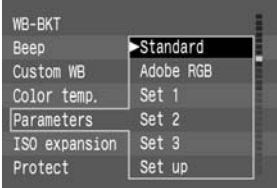
**Parameters**

Besides the [Standard] set of parameter settings (four items with five settings each), up to three other sets of parameter settings can be set and saved [Set 1] [Set 2] or [Set 3]. (→p.56)

When [Standard] [Set 1] [Set 2] or [Set 3] is selected, the color space will be set to sRGB. When [Adobe RGB] is selected, the color space can be changed to Adobe RGB. The parameters will then be set to the standard setting.

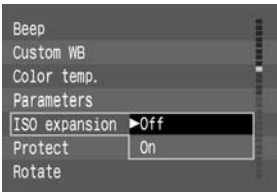
**ISO expansion**

Enables [on] or disables [off] the option of setting H (ISO 3200) when the ISO speed is set as described in “Setting the ISO Speed.” (→p.49)

## Playback Menu

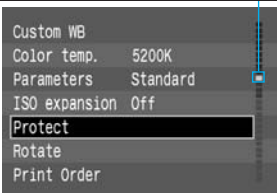

Blue

**Protect**

Prevents the protected image from being erased accidentally. (→p.116)

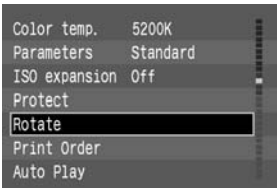
**Rotate**

The captured image can be rotated by 90° or 270°. When the image is rotated, the rotate information is saved in the image so that when the image is displayed again, it will appear in the rotated state. (→p.114)

**Playback Menu**

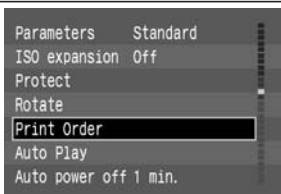

**Print Order**

Images in the CF card can be selected for printing and the printing quantity can also be specified. When this command is given, the DPOF print order information will be saved in the CF card. (→p.131)

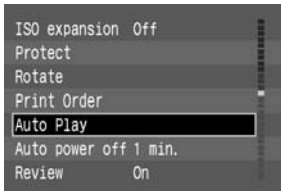

**Auto Play**

Plays back the images in the CF card at 3-sec. intervals. (→p.113)

**Setup Menu**

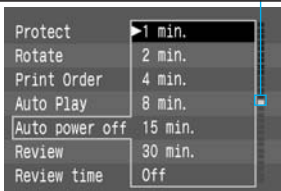

**Auto power Off**

Sets the time period after which the power turns off automatically if the camera is not used. This saves battery power. It can be set to [1 min.] [2 min.] [4 min.] [8 min.] [15 min.] [30 min.] or [Off].

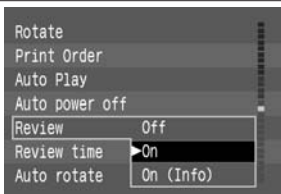

**Review**

Enables or disables the image from displaying on the LCD monitor immediately after capture. Settable to [Off] [On] or [On (Info)]. (→p.42) The display time is set with [Review time].

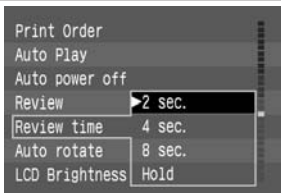

**Review time**

If [Review] has been set to [On] or [On (Info)], you can set the image review time to [2 sec.] [4 sec.] [8 sec.] or [Hold]. (→p.43)

## Setup Menu

**Auto rotate**

Enables the camera orientation (horizontal or vertical) information to be recorded together with the image onto the CF card. Settable to **[On]** or **[Off]**. When Auto rotate is **[On]**, images captured in the vertical orientation will be automatically rotated 90° or 270° clockwise and displayed vertically during playback. (→p.61)

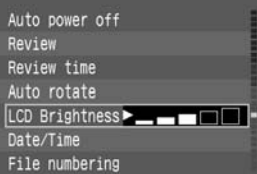
**LCD Brightness**

Sets the LCD monitor's brightness level. Turn the <⊙> dial to set it to one of five brightness levels.

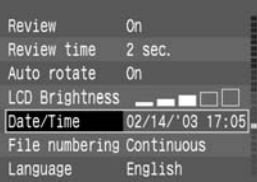
**Date/Time**

Sets the date and time. Also sets the display format of the date and time. (→p.154)

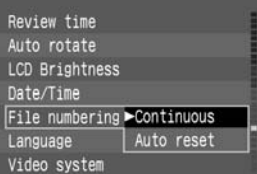
**File numbering**

Sets the automatic file numbering of the captured images. Settable to **[Continuous]** or **[Auto reset]**. (→p.59)

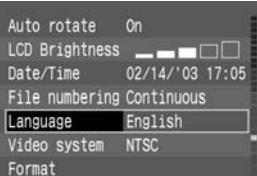
**Language**

Sets the menu's interface language. Settable to

<b>[English]</b>	<b>[Italiano]</b> (Italian)
<b>[Deutsch]</b> (German)	<b>[Norsk]</b> (Norwegian)
<b>[Français]</b> (French)	<b>[Svenska]</b> (Swedish)
<b>[Nederlands]</b> (Dutch)	<b>[Español]</b> (Spanish)
<b>[Dansk]</b> (Danish)	[ 汉语 ] (Simplified Chinese)
<b>[Suomi]</b> (Finnish)	[ 日本語 ] (Japanese)

**Setup Menu**

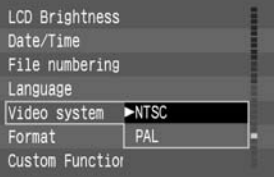

**Video system**

Sets the video format for the video output. Settable to [NTSC] or [PAL]. (→p.115)

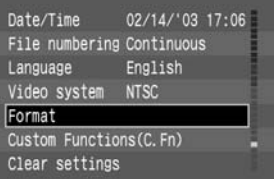

**Format**

Initializes the CF card loaded in the camera. (→p.119)

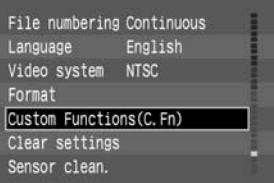

**Custom Functions (C.Fn)**

For setting Custom Functions to suit the user's preferences. (→p.145, 146)

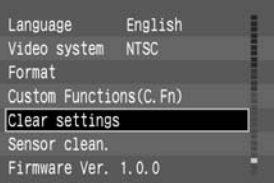

**Clear settings**

**Clear all camera settings**

Resets all the camera settings to the default settings. (→p.35)

**Clear all Custom Functions**

Resets all the Custom Function settings to [0]. (→p.152)

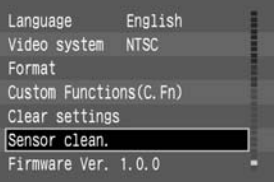

**Sensor clean.**

For cleaning any dust, etc., from the image sensor's surface. (→p.156)

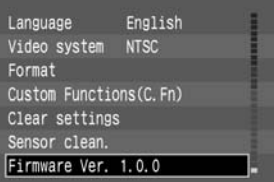

**Firmware Ver. x.x.x**

Displays the camera's firmware version. Information on new firmware and firmware updates are provided at Canon's Web site.



# MENU Setting Custom Functions

Custom Functions are camera functions which you can set to suit your shooting preferences. To set a Custom Function, select [**Custom Functions (C.Fn)**] on the menu.

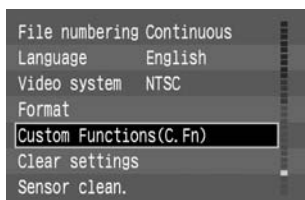

## 1 On the menu, select [**Custom Functions (C.Fn)**].

- Press the <MENU> button.
- Turn the <Q> dial to select [**Custom Functions (C.Fn)**], then press the <SET> button.

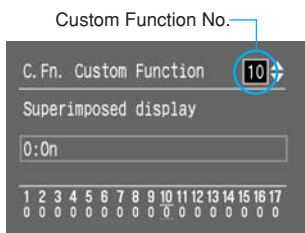

## 2 Select the Custom Function No.

- Turn the <Q> dial to select the desired Custom Function No., then press <SET>.

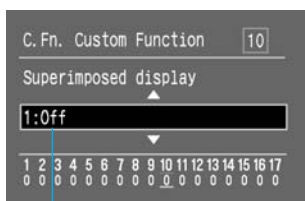

## 3 Change the setting.

- Turn the <Q> dial to select the desired setting (number), then press <SET>.
- Repeat steps 2 and 3 above to set any other Custom Functions.
- The current Custom Function settings are displayed at the bottom of the screen.

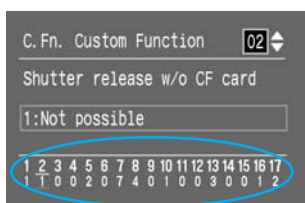

Custom Function settings

## 4 Exit.

- Press the <MENU> button to return to the main menu.
- Press the <MENU> button again to turn off the LCD monitor.

# MENU Custom Function Settings

## C.Fn-01

### SET button func. when shooting

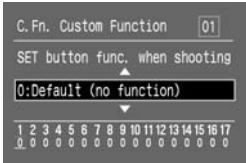

You can assign a different function to the <SET> button. In the case of C.Fn-01-1/2, you can press <SET>, then turn the <Q> dial to set the desired setting directly while looking at the LCD panel.

#### 0: Default (no function)

##### 1: Change quality

You can select the recording quality directly.

##### 2: Change parameters

You can select the processing parameters directly.

“PR-0” is for [Normal]. “PR-1”, “PR-2”, and “PR-3” are for [Set 1], [Set 2], and [Set 3] respectively. When “PR-R” is selected, the color space will be [Adobe RGB].

##### 3: Menu display

Provides the same function as the <MENU> button.

##### 4: Image replay

Provides the same function as the <▶> button.

## C.Fn-02

### Shutter release w/o CF card

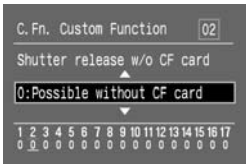

#### 0: Possible without CF card

##### 1: Not possible

The shutter release will not work if there is no CF card in the camera, so it prevents you from forgetting to load a CF card. If there is no CF card and you press the shutter button, “no CF” will blink on the LCD panel and in the viewfinder.

## C.Fn-03

### Flash sync speed in Av mode

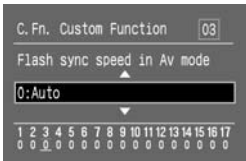

#### 0: Auto

##### 1: 1/200sec. (fixed)

For flash shot in the aperture-priority AE mode (Av), the shutter speed will be locked at 1/200 sec. This prevents a slow shutter speed from being set in very dark conditions.

## C.Fn-04

### Shutter button/AE lock button

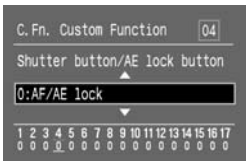

#### 0: AF/AE lock

##### 1: AE lock/AF

Convenient when you want AF and AE lock to operate separately. Pressing the <★> button focuses the subject, while pressing the shutter button halfway sets the AE lock.

**2: AF/AF lock, no AE lock**

In the AI Servo AF mode, you can press the < \* > button to stop the AF operation momentarily when there is an obstruction passing in front of the camera. This prevents the AF from being thrown off. The exposure is set when the shot is taken.

**3: AE/AF, no AE lock**

This is useful for a subject that moves and stops repeatedly. In the AI Servo AF mode, you can press the < \* > button to start or stop the AI Servo AF operation. The exposure is set when the shot is taken. Thus, the optimum focusing and exposure are always ready for the decisive moment.

**!** C.Fn-04 and C.Fn-17-0/1/2 (→p.151) both have AF start/stop and AE lock functions. If you have set both of these Custom Functions and you execute both Custom Function operations, the latter operation will not work. The only exception is when AF stop is executed after AF start.

**C.Fn-05 AF-assist beam/Flash firing**

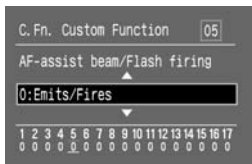

Sets the AF-assist to be emitted by the camera or external Speedlite and sets the flash to be fired by the built-in flash or external Speedlite.

**0: Emits/Fires**

Enables the AF-assist beam to be emitted and the flash to be fired.

**1: Does not emit/Fires**

Disables the AF-assist beam and enables the flash to be fired.

**2: Only ext. flash emits/Fires**

Enables the AF-assist beam to be emitted only by the external Speedlite and enables the flash to be fired.

**3: Emits/Does not fire**

Enables the AF-assist beam to be emitted and disables the flash.

**C.Fn-06 Exposure level increments**

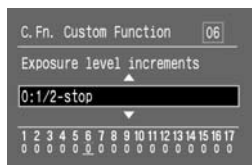

**0: 1/2-stop**

**1: 1/3-stop**

Sets the setting increment of the shutter speed, aperture, and exposure compensation amount.

## C.Fn-07 AF point registration

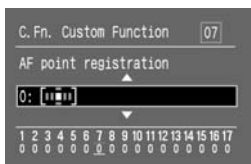

By registering a frequently-used AF point as the home position (HP), you can instantly switch to this home position AF point even while using another AF point. Automatic AF point selection can also be registered as the home position.

- 0: [Center AF point]      4: [Automatic selection]
- 1: [Bottom]
- 2: [Right]
- 3: [Extreme right]      7: [Top]
- 5: [Extreme left]
- 6: [Left]

## C.Fn-08 RAW+JPEG rec.

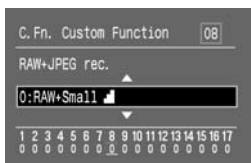

Sets the recording quality of the JPEG image recorded simultaneously and embedded in the RAW image file.

- 0: RAW+Small
- 1: RAW+Small
- 2: RAW+Medium
- 3: RAW+Medium
- 4: RAW+Large
- 5: RAW+Large

 The dedicated software is required to extract the JPEG image in the RAW image file.

## C.Fn-09 Bracket. sequence/Auto cancel.

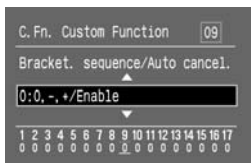

Sets the shooting sequence for AEB and white balance bracketing (WB-BKT).

If [Auto cancel] is set, the bracketing will be canceled in the following cases:

AEB: Canceled if the <AEB> switch is turned <OFF>, lens is interchanged, flash is ready, battery is replaced, or the CF card is replaced.

WB-BKT: Canceled if the <WB-BKT> switch is turned <OFF>.

- 0: 0,-,+ /Enable
- 1: 0,-,+ /Disable

Starts the bracketing sequence with the correct exposure (or white balance), and the bracketing is repetitive.

**2: -,0,+/Enable**

Starts the bracketing with a decreased exposure (or bluer white balance).

**3: -,0,+/Disable**

Starts the bracketing with a decreased exposure (or bluer white balance), and the bracketing is repetitive.

AEB	White Balance Bracketing
0: Standard exposure	0: Correct white balance
-: Decreased exposure	-: Bluish white balance
+: Increased exposure	+: Reddish white balance

**C.Fn-10**

**Superimposed display**



**0: On**

**1: Off**

Disables the AF point from flashing in red when it achieves focus. When the AF point is selected, it will still flash in red.

**C.Fn-11**

**Menu button display position**

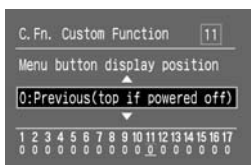

Sets the menu item to be displayed when the <MENU> button is pressed.

**0: Previous(top if powered off) menu**

Displays the preceding menu item that was set. However, if the <Fn> switch is set to <OFF> or if the battery pack or the CF card is replaced, the top menu item [Quality] will be displayed.

**1: Previous menu**

Displays the preceding menu item that was set.

**2: Top menu**

Displays the top menu item [Quality].

**C.Fn-12**

**Mirror lockup**

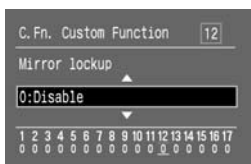

**0: Disable**

**1: Enable**

Convenient for close-up and telephoto shots to prevent camera vibration caused by the mirror's action. The mirror lockup procedure is explained on page 94.

## C.Fn-13 Assist button function

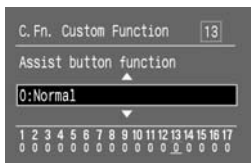

Changes the function of the <Fn> button.

### 0: Normal

Pressing the <Fn> and <Fn2> buttons simultaneously selects the registered AF point.

### 1: Select Home Position

Pressing only the <Fn> button selects the registered AF point.

### 2: Select HP (while pressing)

The registered AF point is selected only while the <Fn> button is held down. When you let go of the button, the previous AF point is selected.

### 3: Av+/- (AF point by QCD)

Assigns the exposure compensation and manual aperture setting functions to the <Fn> button. Hold down the <Fn> button and turn the <QCD> dial to set either. Or turn the <QCD> dial to select the AF point. The AF point selection sequence is shown on the left.

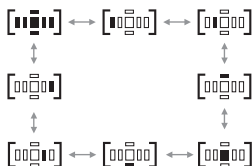

### 4: FE lock

The <Fn> button sets FE lock. When C.Fn-04-1/2/3 (→p.146) is set, FE lock will be enabled. In this case, the <Fn2> button does not set FE lock.

## C.Fn-14 Auto reduction of fill flash

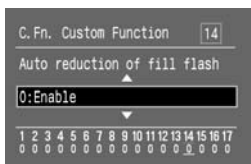

### 0: Enable

Obtains natural-looking, daylight flash shots automatically.

### 1: Disable

Prevents underexposure of a personnel subject set against a bright background such as a sunset.

## C.Fn-15 Shutter curtain sync

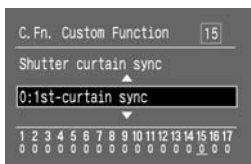

### 0: 1st-curtain sync

### 1: 2nd-curtain sync

By using a slow sync speed, you can create a light trail following a moving subject. The flash fires right before the shutter closes. This Custom Function can be used to obtain 2nd-curtain sync effects even with EX-series Speedlites which do not have this capability. If an EX-series Speedlite having this capability is set for 2nd-curtain sync, it will override this Custom Function.

## C.Fn-16 Safety shift in Av or Tv

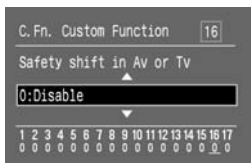

Safety shift can be set for the shutter-priority AE and aperture-priority AE modes.

**0: Disable**

**1: Enable**

If the subject's brightness changes suddenly and the current shutter-priority AE or aperture-priority AE setting becomes unsuitable, the shutter speed or aperture is shifted to obtain a proper exposure.

## C.Fn-17 Lens AF stop button function

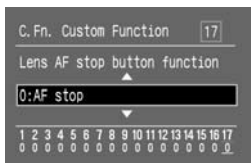

**0: AF stop**

**1: AF start**

AF operates only while the AF stop button is pressed. While you press the button, AF operation with the camera is disabled.

**2: AE lock while metering**

When you press the button while metering timer is still active, AE lock takes effect. Convenient when you want to focus and meter separately.

**3: AF point:M→Auto/Auto→ctr.**

In the manual AF point selection mode, holding down the button switches to automatic AF point selection. Holding down the button switches from manual AF point selection to automatic AF point selection immediately. Convenient when you are no longer able to focus track a moving subject with a manually-selected AF point in the AI Servo AF mode.

In the automatic AF point selection mode, holding down the button selects the center AF point.

**4: ONE SHOT ↔ AI SERVO**

In the One-Shot AF mode, holding down the button switches to AI Servo AF mode. In the AI Servo AF mode, holding down the button switches to One-Shot AF mode. Convenient when you need to keep switching between One-Shot AF and AI Servo AF for a subject that keeps moving and stopping.

**5: IS start**

With the lens' IS switch already ON, the Image Stabilizer operates only while you hold down the AF stop button.



The AF stop button is provided only on super telephoto lenses.

# MENU Clearing All Custom Functions

You can reset all the Custom Function settings to [0].

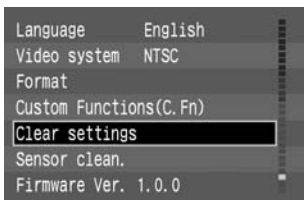

## 1 On the menu, select [Clear settings].

- Press the <MENU> button.
- Turn the <O> dial to select [Clear settings], and press <SET>.

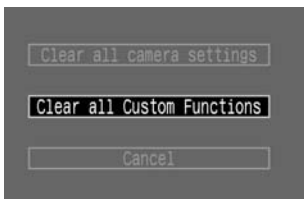

## 2 Select [Clear all Custom Functions].

- Turn the <O> dial to select [Clear all Custom Functions], and press <SET>.

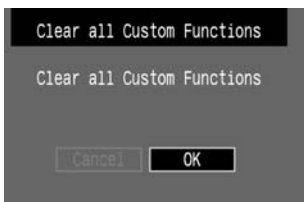

## 3 Clear all the Custom Function settings.

- Turn the <O> dial to select [OK], then press <SET>.
- ▶ All the Custom Function settings will be cleared.
- Press the <MENU> button to exit the menu and turn off the LCD monitor.



This chapter explains how to set the camera's date and time, replace the date/time battery, and clean the image sensor.

# 12

## Maintenance

---

# MENU Setting the Date and Time

Set the date and time as shown below. The date and time are recorded with the image file for each captured image.

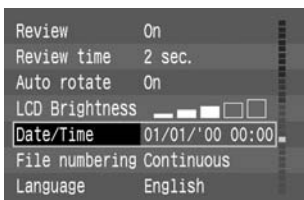

## 1 On the menu, select [Date/Time].

- Press the <MENU> button.
- Turn the <O> dial to select [Date/Time], then press <SET>.
- ▶ The Date/Time setting screen will appear.



## 2 Set the date and time.

- Turn the <O> dial to set the item, then press <SET>.
- The selection will then shift to the next item.



## 3 Set the date display format.

- Turn the <O> dial to select one of the following display formats:

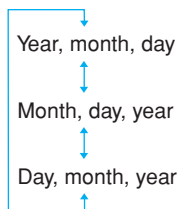

## 4 Press the <SET> button.

- ▶ The date and time will be set and the menu will reappear.
- Press the <MENU> button to turn off the LCD monitor and exit the menu.



Each captured image is recorded with the date and time it was taken. If the date and time are not set, they cannot be recorded correctly. Make sure you set the date and time correctly.

# Replacing the Date/Time Battery

The date/time battery maintains the camera's date and time. The battery's service life is about 5 years. When the date/time battery's power is low, "L bL" will appear on the LCD panel. Replace the battery with a new CR2025 lithium battery as described below.

- If a battery pack or DC coupler is attached to the camera, the camera's date and time and menu functions will be maintained while you replace the battery.

**1** Set the  switch to <OFF>.

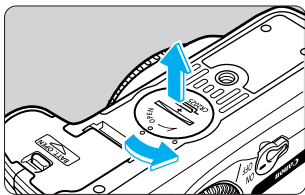

**2** Remove the date/time battery cover.

- Use a coin to turn the cover by 45 degrees as shown by the arrow.
- Do not turn the cover by more than 45 degrees.

**3** Remove the old battery.

- Point the battery compartment downward and push in the edge of the battery to take it out.

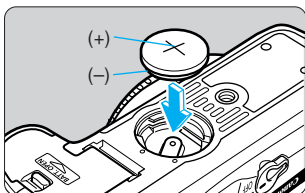

**4** Install a new battery.

- The plus side of the battery must face upward.

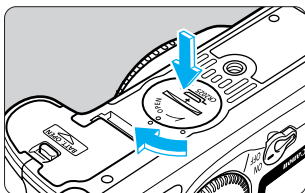

**5** Attach the battery cover.

- If necessary, set the correct date and time.



For the date/time battery, be sure to use a CR2025 lithium battery.

# MENU Cleaning the Image Sensor (CMOS)

The image sensor is like the film in a film-based camera. If any dust or other foreign matter adheres to the image sensor, it may show up as a dark speck in the images.

To avoid this, follow the procedure below to clean the image sensor. Note that the image sensor is a very delicate component. If possible, you should have it cleaned by a Canon Service Center.

- While you clean the image sensor, the camera must be turned on. Use the AC Adapter Kit ACK-E2 (optional accessory, see page 174) or a battery. If you use a battery, make sure the battery level is sufficient. Before cleaning the image sensor, detach the lens from the camera.

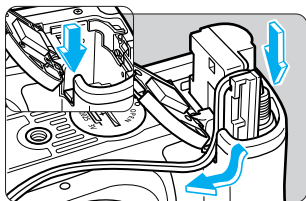

- 1 Insert the DC coupler (→p.26) or a battery into the battery compartment and set the <ON> switch to <ON>.**

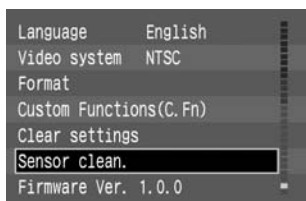

- 2 On the menu, select [Sensor clean.].**
  - Press the <MENU> button.
  - Turn the <Q> dial to select [Sensor clean.], then press <SET>.
  - ▶ If you are using a battery having enough power, the screen shown in step 3 will appear.
  - If the battery is exhausted, a warning message will appear and you will not be able to proceed further. Either recharge the battery or use a DC coupler and start from step 1 again.



- 3 Select [OK].**
  - Turn the <Q> dial to select [OK], then press <SET>.
  - ▶ The mirror will lock up and the shutter will open.
  - ▶ "[CLEAR n]" will blink on the LCD panel.

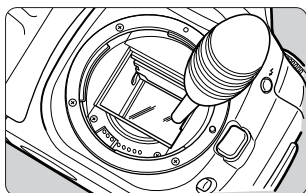

- 4 Clean the image sensor.**
  - Use a rubber blower to carefully blow away any dust, etc., on the surface of the image sensor.

## 5 Terminate the cleaning.

- Set the <⏻> switch to <OFF>.
- ▶ The camera will turn off and the shutter will close. The mirror will also go down.
- Set the <⏻> switch to <ON>. You can start shooting again.



- **During the sensor cleaning, never do any of the following that would turn off the power. If the power is cut off, the shutter will close and it may damage the shutter curtains and image sensor.**
  - **Do not turn the <⏻> switch to <OFF>.**
  - **Do not open the CF card slot cover.**
  - **Do not remove the battery.**
- Do not insert the blower tip inside the camera beyond the lens mount. If the power goes out, shutter will close and the shutter curtains and image sensor may be damaged.
- Do not use a blower brush. The brush can scratch the CMOS sensor.
- Never use cleaning sprays or blower sprays. The pressure and freezing action of the spray gas may damage the surface of the image sensor.
- When the battery is exhausted, the beeper will sound and the <⏻> icon will blink on the LCD panel. Set the <⏻> switch to <OFF> and replace the battery. Then start from step 1 again.



This section will help you understand your camera better. It covers basic shooting concepts, camera specifications, system accessories, and other reference information.

# 13

## Reference

---

# Basic Terminology

## AE

Abbreviation for auto exposure. It is an automatic metering and exposure system that sets the optimum exposure (shutter speed and/or aperture) based on the reading by the built-in exposure meter.

## AF

Abbreviation for auto focus. It enables the camera to focus the subject automatically.

## CF (CompactFlash) card

CF card is the small, card-shaped storage media used to record images taken by the EOS 10D.

## ISO speed

This indicates the film's sensitivity to light. It is expressed as a number following "ISO" such as "ISO 100." The higher the number, the higher the sensitivity to light. Digital cameras also use the same ISO speed standard used by film-based cameras.

## JPEG

Abbreviation for Joint Photographic Experts Group. It is an image file format with various compression levels. The higher the compression rate, the lower the image quality, when the file is expanded (restored).

## RAW

This is an image file format that saves the image as is when captured by the camera. It is geared for image processing with a personal computer.

The image quality is not affected when the raw image is compressed, saved, or decompressed. By using the dedicated software for image processing, the image can be optimally enhanced for the specified purpose.

## sRGB

Color matching standard jointly developed by Microsoft and Hewlett-Packard. Cameras, monitors, applications, and printers which comply with this standard are able to reproduce colors in the same way. (The "s" stands for standard.)

## Red-eye Effect

In a relatively dark room, where subjects' pupils are dilated, the light from a camera flash passes through the pupil, is reflected by the retina, and causes the subjects' pupils to appear red. Red-eye is particularly prevalent when the flash is close to the optical axis of the lens. Use the following procedure to minimize red-eye:

- ① Shoot with the Red-eye reduction function turned on. (The red-eye reduction lamp lights before the image is taken, causing the pupils to contract and thus minimizing red-eye.)
- ② Shoot with an EX-series Speedlite. (The light reflected from the pupil will not be directed along the optical axis of the lens, thus minimizing red-eye.)
- ③ Shoot from as close as possible (same effect as ②).



## Aperture

The aperture value (f/number) indicates the size of the aperture opening in the lens. It is equal to the focal length divided by the aperture diameter. It adjusts the amount of light striking the CMOS sensor. The aperture value is displayed on the camera's LCD panel and in the viewfinder. It can range anywhere from 1.0 to 91, depending on the lens attached to the camera.

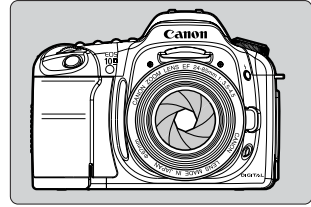

## Shutter speed

The shutter speed is the length of time the camera's shutter opens to expose the CMOS sensor to the light coming through the lens. It adjusts the amount of light striking the CMOS sensor.

## Format

When you format a CF card, it prepares the card to store data in it. It also erases any data stored on the card. Before formatting a CF card, be sure it has no valuable data.

## File numbers and folders

The captured images are automatically assigned a file number from 0001 to 9999 and stored in a folder that can contain up to 100 images. The folders are numbered from 100 to 999 and stored in the CF card.

The file name of JPEG images will be "IMG\_" appended with the ".JPG" extension. RAW image file names will be "CRW\_" appended with the ".CRW" extension. Image file names with the ".THM" extension are thumbnail image files for the index display.

Example: IMG\_0001.JPG

File name	Extension
File number	

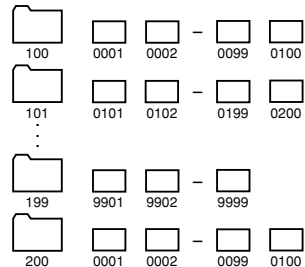

## Firmware

This is software containing various camera control instructions. The EOS 10D uses the firmware for shooting and image processing.

## Depth of field

This is the range where acceptable focus can be achieved in front of and behind the point of focus. The smaller the aperture (the higher the f/number), the deeper the depth of field. And the larger the aperture (the lower the f/number), the shallower the depth of field.

**The depth of field is affected as described below:**

- (1) A smaller aperture (a higher f/number) increases the depth of field.  
For example, stopping down to f/8 obtains a deeper depth of field than f/4.5.
- (2) A lens with a shorter focal length increases the depth of field.  
A wide-angle lens obtains a deeper depth of field than a telephoto lens.
- (3) A longer distance between the camera and subject increases the depth of field.
- (4) The depth of field behind the point of optimum focus (2) is longer than the depth of field in front of the point of optimum focus (1).

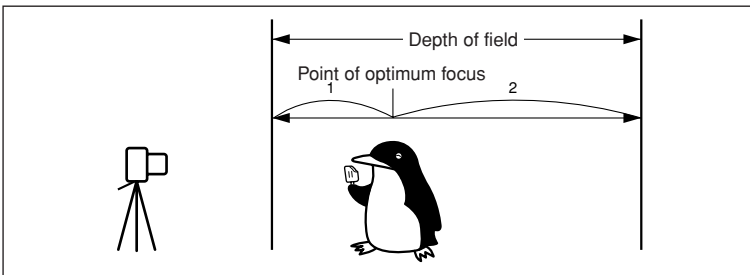

Aperture set to f/2.



Aperture set to f/22.

## Exposure

Exposure occurs when the image sensor is exposed to light. Correct exposure is obtained when the image sensor is exposed to a proper amount of light in accordance with its sensitivity to light. The correct exposure is adjusted with the camera's shutter speed and aperture.

# Function Availability Table









●: Automatic Setting ○: Selection Possible

Mode Dial									P	Tv	Av	M	A-DEP
Quality	JPEG	○	○	○	○	○	○	○	○	○	○	○	○
	RAW								○	○	○	○	○
ISO speed	Auto	●	●	●	●	●	●	●					
	Manual								○	○	○	○	○
White balance	Auto WB	●	●	●	●	●	●	○	○	○	○	○	○
	Preset WB • Custom WB Color temp. • WB-BKT								○	○	○	○	○
Parameters		● Standard							○	○	○	○	○
AF	One-Shot		●	●	●		●		○	○	○	○	●
	AI Servo					●			○	○	○	○	—
	AI Focus	●						●	○	○	○	○	—
	AF point selection	Auto	●	●	●	●	●	●	○	○	○	○	○
Manual									○	○	○	○	
Metering mode	Evaluative	●	●	●	●	●	●	○	○	○	○	○	○
	Partial								○	○	○	○	○
	Centerweighted average								○	○	○	○	○
Drive	Single frame	●		●	●		●	●	○	○	○	○	○
	Continuous		●			●			○	○	○	○	○
Built-in flash	Auto	●	●		●		●						
	Manual								○	○	○	○	○
	Red-eye reduction	○	○		○		○		○	○	○	○	○
Custom Function (C.Fn)									○	○	○	○	○

## AF Modes and Drive Modes

Drive mode	ONE SHOT AF	AI Servo AF	AI Focus AF
Single frame	An image cannot be taken unless focus is achieved. When focus is achieved, it is locked. With evaluative metering, the exposure setting is also locked. (The exposure setting is stored in memory before the shot is taken.)	Autofocus tracks the moving subject, and the exposure is set when the shot is taken.	Automatically switches between ONE SHOT AF and AI Servo AF according to the subject status.
Continuous	The above conditions apply during continuous shooting. (approx.3 fps to a max. burst of 9 images.)	The above conditions apply during continuous shooting. AF continues during continuous shooting. (approx. 3 fps, up to a max. burst of 9 images.)	

# Exposure Warning List

Mode	Blinking Warning	Indication	Solution
<b>P</b>		The subject is too dark.	1) Increase the ISO speed. 2) Use flash.
		The subject is too bright.	1) Decrease the ISO speed. 2) Attach a neutral density filter to the lens.
<b>Tv</b>	125 	The shot will be underexposed.	1) Turn the <img alt="shutter speed dial icon" data-bbox="225 270 245 290"/> to set a slower shutter speed. 2) Increase the ISO speed.
	125 	The shot will be overexposed.	1) Turn the <img alt="shutter speed dial icon" data-bbox="225 335 245 355"/> to set a faster shutter speed. 2) Decrease the ISO speed.
<b>Av</b>		The shot will be underexposed.	1) Turn the <img alt="aperture dial icon" data-bbox="225 400 245 420"/> to set a larger aperture (smaller f/number). 2) Increase the ISO speed.
		The shot will be overexposed.	1) Turn the <img alt="aperture dial icon" data-bbox="225 465 245 485"/> to set a smaller aperture (larger f/number). 2) Decrease the ISO speed.
<b>A-DEP</b>	60 	The desired depth of field cannot be obtained.	1) Move away from the subject and try again. 2) If a zoom lens is used, use the shortest focal length.
		The subject is too dark.	1) Increase the ISO speed. 2) Use a flash (the result will be the same as using Program AE <math>\langle \mathbf{P} \rangle</math>).
		The subject is too bright.	1) Decrease the ISO speed. 2) Attach a neutral density filter to the lens.



The sample warnings apply when a lens having a maximum aperture of f/3.5 and minimum aperture of f/22 is attached to the camera. The maximum and minimum aperture warning displays will differ depending on the lens attached to the camera.

# AE Lock Effects

(when using a mode in the Creative zone)

AF point selection	Auto selection	Manual selection
<b>Metering method</b>		
Evaluative metering	AE lock applied to the metered value at the active AF point.	AE lock applied to the metered value at the selected AF point.
Partial metering	AE lock applied to the metered value at the center AF point.	
Center-weighted average		

# Program Line

<P> The following program line applies when the camera is in Program AE <P> mode.

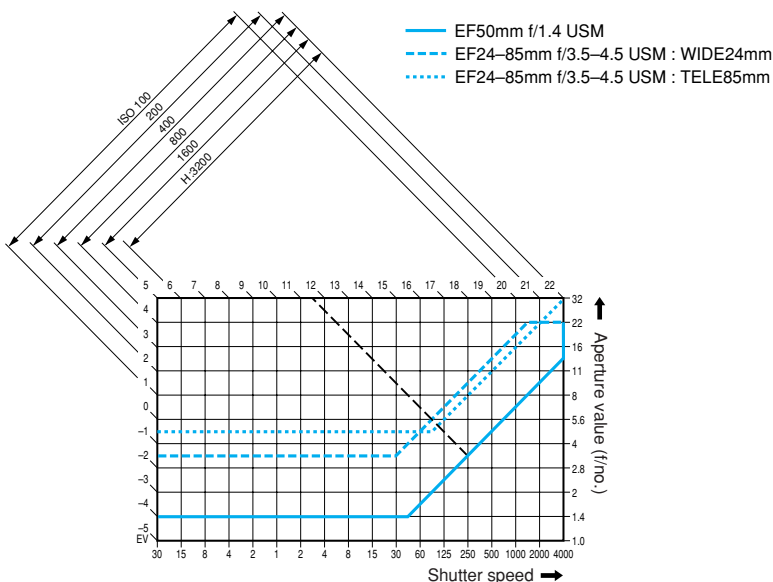

## Program Line Description

The lower horizontal axis represents the shutter speed, and the right-hand vertical axis represents the aperture value. The combinations of shutter speed and aperture value automatically determined by Program AE are shown as colored lines with respect to the subject brightness (Exposure Value) gradations on the left and top edges of the graph.

Example: Using an EF50 f/1.4 USM lens with a subject brightness of EV11.5, the point where the diagonal line from EV11.5 (on the top edge) intersects the Program AE line represents the corresponding shutter speed (1/250 second) and aperture value (f/3.5) that the program sets automatically.

The diagonal arrowed lines at the upper left indicate the metering range for each ISO speeds.

# Shutter Speed and Aperture Value Readouts

## Shutter speed readout

The shutter speed is normally displayed in 1/2-stop increments. Numbers from “4000” to “4” denote the denominator of the shutter speed fraction: for example, “125” is 1/125 seconds. In addition, “0.3” is 0.3 seconds, and “15” is 15 seconds.

## Aperture value readout

The aperture value is normally displayed in 1/2-stop increments. The larger the number, the smaller the aperture opening. The range of aperture values (f/numbers) displayed depends on the lens used.

1/2-stop increments				1/3-stop increments			
Shutter speed		Aperture value		Shutter speed		Aperture value	
4000	2"	10	9.1	4000	10	10	20
3000	3"	12		3200	8	11	22
2000	4"	14		2500	6	12	25
1500	5"	18		2000	5	14	29
1000	8"	20		1600	4	16	32
750	10"	2.5		1250	0.3	18	36
500	15"	2.8		1000	0.4	2.0	40
350	20"	3.5		800	0.5	2.2	45
250	30"	4.0		640	0.6	2.5	5.1
180		4.5		500	0.8	2.8	5.7
125		5.6		400	1"	3.2	6.4
90		6.7		320	1.3	3.5	7.2
60		8.0		250	1.6	4.0	8.1
45		9.5		200	2"	4.5	9.1
30		11		160	2.5	5.0	
20		13		125	3.2	5.6	
15		16		100	4"	6.3	
10		19		80	5"	7.1	
8		22		60	6"	8.0	
6		27		50	8"	9.0	
4		32		40	10"	10	
0.3		38		30	13"	11	
0.5		45		25	15"	13	
0.7		54		20	20"	14	
1"		64		15	25"	16	
1.5		76		13	30"	18	

### C.Fn

C.Fn-06-1, the shutter speed and aperture value can be set in 1/3-stop increments. (→p.122)

# On-screen Messages

The messages displayed on the LCD monitor are as follows.

Message	Description
<b>Busy</b>	The camera is either processing the data or writing the captured image onto the CF card. Wait until it is finished.
<b>Loading image...</b>	The camera is reading the image in the CF card. Wait until it is finished.
<b>No CF card</b>	There is no CF card. Load a proper CF card into the camera.
<b>CF card error</b>	There is a problem with the CF card. Replace the CF card.
<b>CF card full</b>	Since the CF card is full, no more images can be recorded or no more printing instructions can be saved.
<b>No Image</b>	The CF card has no displayable images. Either take a shot and save it or replace the CF card with one that has images.
<b>Image too large</b>	The image is not displayable because it is larger than 4064 x 2704 pixels.
<b>Incompatible JPEG format</b>	The JPEG image is not displayable because it is incompatible.
<b>Corrupted data</b>	The image data cannot be displayed because it is damaged.
<b>Cannot rotate</b>	The image cannot be rotated because it was captured by another camera, captured in a different format, or edited with a personal computer.
<b>Unidentified Image</b>	The image is not displayable because it was captured in an unknown format (recording format of another camera manufacturer, etc.).
<b>Protected!</b>	The image cannot be erased because it is erase-protected. To delete the image, first disable the erase protection.
<b>Unselectable image</b>	Printing of a non-JPEG image was attempted. Printing is not possible. Specification of an image captured by another camera or an image edited with a personal computer was attempted with Custom WB image selection. The white balance data cannot be loaded.
<b>Too many marks</b>	The printing specification was too many. The printing cannot be specified above this number.
<b>Cannot complete!</b>	The printing specification could not be saved.
<b>Cannot magnify!</b>	The image could not be magnified because it was captured by another camera or it is in an incompatible format or it has been edited with a personal computer.
<b>Change the battery pack</b>	There is not enough battery power for shooting or image playback. Replace the battery.
<b>CCDRAW</b>	The image is not displayable because it is a CCDRAW image captured by another camera.

Message	Description
<b>Set Date/Time</b>	The date/time has not been set. Captured images will not have the correct image capture date/time.
<b>Turn off the camera after sensor cleaning</b>	After cleaning the image sensor, turn the <  > switch to <OFF>.
<b>Battery level is too low. Cannot clean sensor</b>	If there is insufficient battery power, the shutter may close during the cleaning of the image sensor and the shutter curtains and image sensor might be damaged. To prevent this, either use a fully-charged battery or a household power outlet before starting to clean the image sensor.
<b>Folder number full</b>	Keep a new CF card on hand. Since the 999Canon folder has been created, the current CF card will soon become full. (When “IMG_9999” is created, “FULL CF” will be displayed.)

When the card photo printer for direct printing is connected to the camera, the camera's LCD monitor may display any of the messages below.

Message	Description
<b>No paper</b>	The paper cassette has not been inserted properly or there is no paper in the cassette. Or there is a problem with the paper feed operation.
<b>No ink</b>	There is no ink cassette or the ink cassette has no ink.
<b>Incompatible paper size</b>	The wrong-size paper has been loaded in the printer. Printing is not possible with paper of this size.
<b>Incompatible ink size</b>	The wrong ink cassette has been loaded in the printer.
<b>Ink cassette error</b>	Printing is not possible with this ink cassette.
<b>Paper and ink do not match</b>	The paper and ink do not match each other.
<b>Paper jam</b>	The paper jammed during printing.
<b>Paper has been changed</b>	The paper size was changed prior to printing.
<b>Recharge the printer battery</b>	The printer's battery is exhausted.
<b>Communication error</b>	Communication error occurred.
<b>Readjust trimming</b>	Printing was attempted with a style different from the trimming setting.



Message	Description
<b>Cannot print!</b>	The image was captured by another camera or in an incompatible format. Or the image has been edited with a personal computer.
<b>Could not print ** images</b>	The image was captured by another camera or it has been edited with a personal computer and printing was attempted in accordance with the DPOF setting for ** prints.
<b>** images remaining</b>	Since the printing with the DPOF setting was interrupted, ** prints still remain to be printed.
<b>Cannot trim</b>	The image was captured by another camera or it is in an incompatible format. Or the image has been edited with a personal computer. Such images cannot be trimmed.

When a BJ printer capable of direct printing is connected to the camera, the camera's LCD monitor may display any of the messages below. If any of these messages are displayed, check the error code on the BJ printer's operation panel and refer to the BJ printer's manual for the error description.

Message	Description
<b>No paper</b>	The paper has not been inserted properly or there is no paper. Or there is a problem with the paper feed operation.
<b>No ink</b>	There is no ink tank or the ink tank has no ink.
<b>Paper jam</b>	The paper jammed during printing.
<b>Printer in use</b>	Printing from the personal computer or the memory card in the printer is in progress. When the printing ends, the images in the camera's CF card will start printing automatically.
<b>Printer warming up</b>	The printer is preparing for printing. When the printer is ready, printing will start automatically.
<b>No printhead</b>	There is no print head.
<b>Printer cover open</b>	Close the printer's front cover.
<b>Media type error</b>	Paper that the printer cannot use has been selected. Select a paper that can be used with the <b>[Style]</b> setting on the camera's direct printing screen.
<b>Paper lever error</b>	Set the paper spacing lever to the proper position.
<b>Low ink level</b>	The ink tank must be replaced soon. Keep a new ink tank on hand. To resume printing, select <b>[Resume]</b> on the error message screen.

Message	Description
<b>Waste tank full</b>	To resume printing, press the BJ printer's Reset button. Have the waste ink tank replaced by your dealer or service center (see the list that came with the BJ printer) at your earliest convenience.
<b>Printer error</b>	Turn off the printer and turn it back on. If the error is still displayed, consult your nearest BJ printer service center (see the service center list in the printer's manual).
<b>Communication error</b>	An error occurred during communications. Turn off the printer and turn it back on and start printing again.
<b>Readjust trimming</b>	The style does not match the trimming that was set.
<b>Cannot print!</b>	The image was captured by another camera or in an incompatible format. Or the image has been edited with a personal computer.
<b>Could not print ** images</b>	The image was captured by another camera or it has been edited with a personal computer and printing was attempted according to the DPOF setting for ** prints.
<b>** images remaining</b>	Since the printing with the DPOF setting was interrupted, ** prints still remain to be printed.
<b>Cannot trim</b>	The image was captured by another camera or in an incompatible format. Or the image has been edited with a personal computer. Such images cannot be trimmed.

# Error Codes

If a camera error occurs, “Err xx” will be displayed on the LCD panel. Follow the instruction below according to the error code.

If the same error occurs often, something is probably wrong with the camera. Jot down the “xx” error code and take your camera to the nearest Canon Service Center (see list of service centers on the back cover).







If an error occurs after you shoot, the camera might have missed the shot. Press the <▶> button to see if the image appears on the LCD monitor.

Error code	Countermeasures
<i>Err 01</i>	Clean the lens contacts. (→p.11)
<i>Err 02</i>	There is a problem with the CF card. Do one of the following: Remove and reload the CF card, format the CF card, or use another CF card.
<i>Err 04</i>	The CF card is full. Delete unnecessary images or replace the CF card.
<i>Err 05</i>	Something obstructed the built-in flash's pop-up operation. Turn <OFF> the <🔍> switch and turn it <ON> again.
<i>Err 99</i>	An error other than the above has occurred. Remove and re-install the battery.

# Troubleshooting Guide

If there is a problem, first refer to this Troubleshooting Guide.

## Power Source

<p>The battery cannot be recharged.</p>	<p><b>You are using the wrong battery.</b> ▶ Use Battery Pack BP-511 or BP-512. (→p.7)</p> <p><b>The battery is not properly attached to the charger.</b> ▶ Attach the battery properly to the charger. (→p.22)</p>
<p>The camera does not operate even when the  switch is set to &lt;ON&gt;.</p>	<p><b>The battery is exhausted.</b> ▶ Change the battery pack. (→p.22)</p> <p><b>The battery is not installed properly.</b> ▶ Install the battery properly. (→p.24)</p> <p><b>Battery compartment cover is not closed.</b> ▶ Close the battery compartment cover tightly. (→p.24)</p> <p><b>CF card slot cover is not closed.</b> ▶ Load the CF card firmly until the CF card eject button pops out, then close the CF card slot cover tightly. (→p.28)</p>
<p>The access lamp still blinks even when the  switch is set to &lt;OFF&gt;.</p>	<p><b>If you set the  switch to &lt;OFF&gt; right after shooting, the access lamp will still blink for a few seconds while the image is recorded onto the CF card.</b> ▶ When the camera finishes recording the image to the CF card, the access lamp will stop blinking and the power will turn off.</p>
<p>The battery becomes exhausted quickly.</p>	<p><b>The battery is not fully charged.</b> ▶ Recharge the battery fully. (→p.22)</p> <p><b>The battery's service life has expired.</b> ▶ Replace the battery with a new one. (→p.174)</p>
<p>The camera turns off by itself.</p>	<p><b>Auto power off is in effect.</b> ▶ Set the  switch to &lt;ON&gt; again or set auto power off to [<b>Off</b>]. (→p.142)</p>
<p>Only the  icon is displayed on the LCD panel.</p>	<p><b>The battery has almost exhausted.</b> ▶ Recharge the battery. (→p.22)</p> <p><b>Camera is not operating properly.</b> ▶ Press the shutter button down halfway to reset the camera to normal. (→p.30) * If the  icon still appears, the camera needs repair. Take it to a Canon Service Center. (→back cover)</p>

## Shooting

No images can be shot or recorded.	<p><b>The CF card is not properly loaded.</b></p> <ul style="list-style-type: none"> <li>▶ Load the CF card properly. (→p.28)</li> </ul> <p><b>The CF card is full.</b></p> <ul style="list-style-type: none"> <li>▶ Use a new CF card or erase unnecessary images. (→p.28, 117)</li> </ul> <p><b>The battery is exhausted.</b></p> <ul style="list-style-type: none"> <li>▶ Recharge the battery. (→p.22)</li> </ul> <p><b>You did not focus well. (The focus confirmation light in the viewfinder blinked.)</b></p> <ul style="list-style-type: none"> <li>▶ Press the shutter button halfway and focus the subject. If you still cannot focus properly, focus manually. (→p.30, 71)</li> </ul>
The LCD monitor does not display a clear image.	<p><b>The LCD monitor screen is dirty.</b></p> <ul style="list-style-type: none"> <li>▶ Use a soft cloth to clean the screen.</li> </ul> <p><b>The LCD's service life has expired.</b></p> <ul style="list-style-type: none"> <li>▶ Contact your dealer or Canon Service Center.</li> </ul>
The image is out of focus.	<p><b>The lens focus mode switch is set to &lt;MF&gt; or &lt;M&gt;.</b></p> <ul style="list-style-type: none"> <li>▶ Set the lens focus mode switch to &lt;AF&gt;. (→p.27)</li> </ul> <p><b>Camera shake occurred when you pressed the shutter button.</b></p> <ul style="list-style-type: none"> <li>▶ To prevent camera shake, hold the camera still and press the shutter button gently. (→p.30, 36)</li> </ul>
The CF card cannot be used.	<p><b>The data in the CF card is damaged.</b></p> <ul style="list-style-type: none"> <li>▶ Format the CF card. (→p.119)</li> <li>▶ Use the correct CF card. (→p.6, 175)</li> </ul>
The message “ $\text{E}$ $\text{bE}$ ” appears on the LCD panel	<p><b>The date/time battery is exhausted.</b></p> <ul style="list-style-type: none"> <li>▶ Replace the battery with a new one. (→p.155)</li> </ul>

## Image Review

The image cannot be erased.	<p><b>The image is protected.</b></p> <ul style="list-style-type: none"> <li>▶ Cancel the protection first. (→p.116)</li> </ul>
The date and time is wrong.	<p><b>The correct date and time has not been set.</b></p> <ul style="list-style-type: none"> <li>▶ Set the correct date and time. (→p.154)</li> </ul>
No image appears on the TV screen	<p><b>Video cable plugs are not inserted fully.</b></p> <ul style="list-style-type: none"> <li>▶ Insert the video cable plugs firmly all the way. (→p.115)</li> </ul> <p><b>The correct video format (NTSC or PAL) has not been set.</b></p> <ul style="list-style-type: none"> <li>▶ Set the camera to the correct video format to match the TV set. (→p.144)</li> </ul>

# Major Accessories (optional)



## Battery Pack BP-511

Powerful, lithium-ion, rechargeable power pack for the EOS 10D. The rated voltage is 7.4 V. Rechargeable with Battery Charger CB-5L. When fully recharged, it enables approx. 500 shots to be taken (at 20°C/68°F with 50% flash use). Recharging time is about 90 min.



## AC Adapter Kit ACK-E2

Power source kit (AC adapter, DC coupler, power cord) for supplying power to the EOS 10D with a household power outlet. The AC adapter's rated input is AC 100 - 240 V. The rated output is DC 7.8 V. The DC coupler is inserted into the camera's battery compartment.



## Compact Power Adapter CA-PS400

Quick charger for Battery Pack BP-511 and BP-512. Recharging time for one battery pack is about 90 minutes, and two packs can be attached to it at the same time. DC Coupler DR-400 (optional) can also be connected to the CA-PS400. Compatible with AC 100 - 240 V.



## Battery Grip BG-ED3

Accommodates two Battery Pack BP-511's. Equipped with a vertical-grip shutter button, electronic dial, AE lock/FE lock button, and AF point selector. A DC coupler can also be used as the power source. Not compatible with Battery Pack BP-512.



## E-Series Dioptric Adjustment Lenses

One of ten E-series dioptric adjustment lenses (-4 to +3 diopters) can be attached to the camera's eyepiece to further expand the dioptric adjustment range.



## Shoe-mount Speedlites

Flash shot with an EX-series Speedlite is as easy as normal auto exposure shooting without flash. All EX-series Speedlites enable E-TTL autofocus, high-speed sync (FP flash), and FE lock. With the 550EX, an easy-to-use, wireless E-TTL autofocus system is possible with multiple Speedlites.



## Macro Flash

The EX-series Macro Lites are ideal for macro flash shooting.

You can fire only one or both flash tubes and control the flash ratio to easily obtain sophisticated lighting effects with E-TTL autoflash. Also, high-speed sync (FP flash), FE lock, and a multi-Speedlite, wireless system (with 550EX as a slave) are possible to achieve various macro flash effects.

## Remote Switch RS-80N3

This is a remote switch with an 80-cm/2.6-ft. cord to prevent camera shake for super-telephoto shots, macroshooting, and bulb exposures. You can use the remote switch to press the shutter button down halfway or completely. Also includes shutter release lock and a one-touch locking plug for connecting to the EOS 10D's remote control terminal.

## Timer Remote Controller TC-80N3

The remote controller attaches with an 80-cm/2.6-ft. cord and includes built-in (1) self timer, (2) interval timer, (3) long-exposure timer, and (4) shutter release count-setting function. You can set the time from 1 second to 99 hours, 59 minutes, 59 seconds, in 1-second increments. Also includes shutter release lock and a one-touch locking plug for connecting to the EOS 10D's remote control terminal.

## CF Card

Data storage device where the captured images are recorded. CF cards made by Canon are recommended.

## PC Card Adapter

Enables a CF card to be inserted into a PC card slot of a personal computer or PC card reader.

# System Map

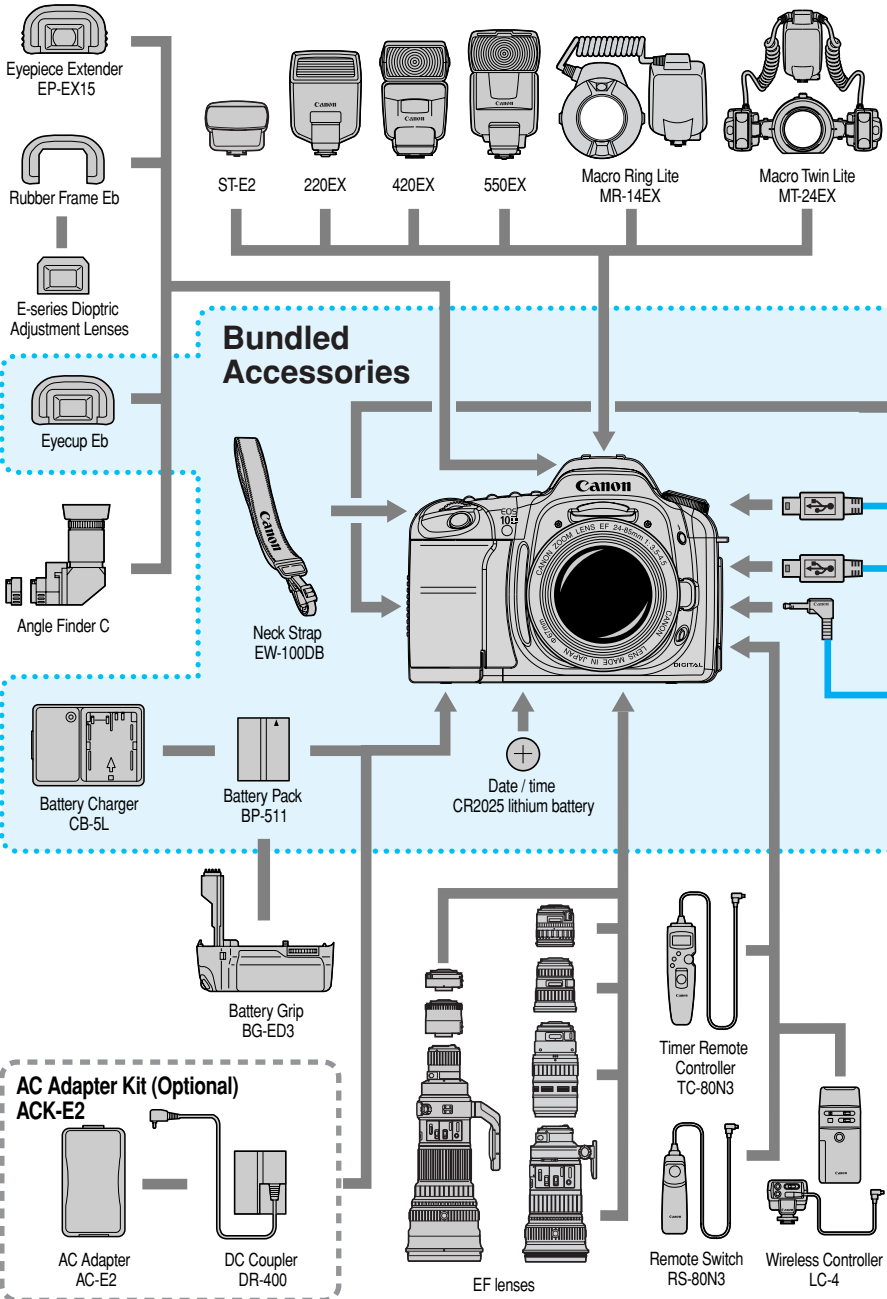



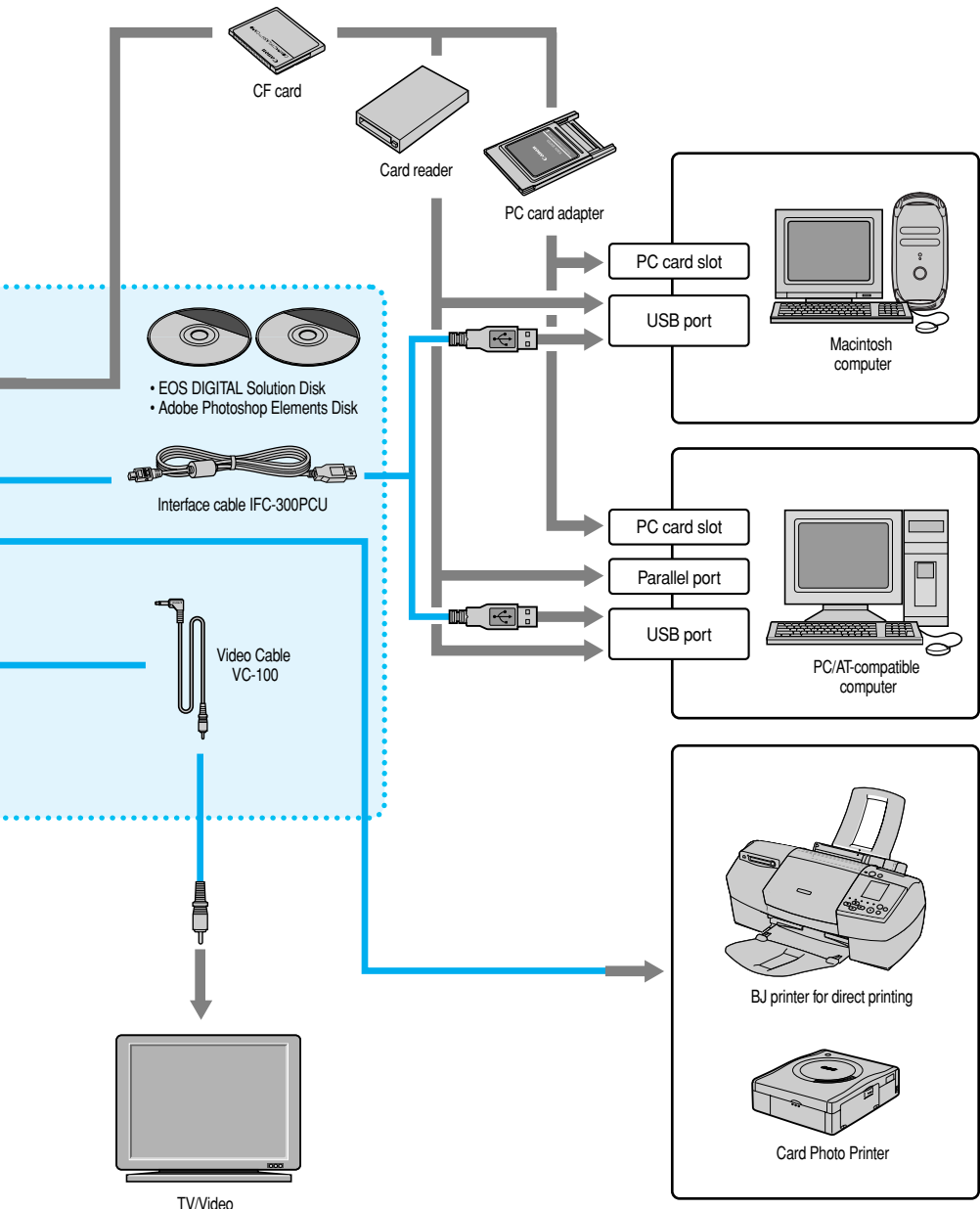

# Specifications

## • Type

Type:	Digital, single-lens reflex, AF/AE camera with built-in flash
Recording medium:	Type I and II CF card
Image size:	22.7 mm x 15.1 mm
Compatible lenses:	Canon EF lenses (35mm-equivalent focal length is equal to approx. 1.6 times the marked focal length.)
Lens mount:	Canon EF mount

## • Image Sensor

Type:	High-sensitivity, high-resolution, single-plate CMOS sensor
Pixels:	Effective pixels: Approx. 6.30 megapixels (3088x2056)
Total pixels:	Approx. 6.50 megapixels (3152x2068)
Aspect ratio:	3:2
Color filter system:	RGB primary color filter
Low-pass filter:	Located in front of the image sensor, non-removable

## • Recording System

Recording format:	JPEG (except when Adobe RGB is set) supporting Design rule for Camera File system and RAW
Image format:	JPEG and RAW (12-bit)
File size:	(1) Large/Fine: Approx. 2.4 MB (3072x2048 pixels) (2) Large/Normal: Approx. 1.2 MB (3072x2048 pixels) (3) Medium/Fine: Approx. 1.3 MB (2048x1360 pixels) (4) Medium/Normal: Approx. 0.7 MB (2048x1360 pixels) (5) Small/Fine: Approx. 0.8 MB (1536x1024 pixels) (6) Small/Normal: Approx. 0.4 MB (1536x1024 pixels) (7) RAW (3072x2048 pixels) <ul style="list-style-type: none"><li>• RAW + Small/Normal: Approx. 6.0 MB</li><li>• RAW + Small/Fine: Approx. 6.4 MB</li><li>• RAW + Medium/Normal: Approx. 6.2 MB</li><li>• RAW + Medium/Fine: Approx. 6.8 MB</li><li>• RAW + Large/Normal: Approx. 6.7 MB</li><li>• RAW + Large/Fine: Approx. 8.0 MB</li></ul> * Exact file sizes depend on the subject and ISO speed.
File numbering:	Consecutive numbering, auto reset
Color space:	sRGB, Adobe RGB
Processing parameters:	Standard parameters plus up to three sets of custom processing parameters (4 items with 5 settings each) can be set.
Interface:	USB (with dedicated cable)

## • White Balance

Settings:	Auto, daylight, shade, cloudy, tungsten light, fluorescent light, flash, manual, color temperature setting
Auto white balance:	Auto white balance with the image sensor
Color temperature compensation:	White balance bracketing: +/-3 stops in whole-stop increments

## • Viewfinder

Type:	Eye-level pentaprism
Coverage:	95% vertically and horizontally with respect to the effective pixels

Magnification:	0.88x (−1 diopter with 50mm lens at infinity)
Eye point:	20 mm
Dioptic adjustment range:	−3.0 - +1.0 diopter.
Focusing screen:	Fixed, New Laser Matte screen
Mirror:	Quick-return half mirror (Transmission:reflection ratio of 40:60, no mirror cut-off with EF 600mm f/4 or shorter lens)
Viewfinder information:	AF (AF points, focus confirmation light), exposure (shutter speed, aperture value, manual exposure, AE lock, exposure compensation amount, AEB level, partial metering area), flash (flash ready, red-eye reduction lamp on, high-speed sync, FE lock, flash exposure compensation amount), warnings (exposure warning, improper FE lock warning, CF card full warning, CF card error warning, no CF card warning, busy), maximum burst for continuous shooting, shots remaining
Depth-of-field preview:	Enabled with depth-of-field preview button

## • Autofocus

Type:	TTL-CT-SIR with a CMOS sensor (TTL secondary image-registration, phase detection)
AF points:	7
AF working range:	EV 0.5-18 (at 20°C, ISO 100)
Focusing modes:	One-Shot AF, AI Servo AF, AI Focus AF, Manual focusing (MF)
AF point selection:	Automatic selection, manual selection, home position
Active AF point indicator:	Superimposed in viewfinder and indicated on LCD panel
AF-assist beam:	Stroboscopic flash Effective range: Approx. 4.0m/13.1ft. at center, approx. 3.5m/11.5ft. off-center

## • Exposure Control

Metering system:	TTL full aperture metering with 35-zone SPC <ul style="list-style-type: none"> <li>• Evaluative metering (linkable to any AF point)</li> <li>• Partial metering (approx. 9% of viewfinder at center)</li> <li>• Centerweighted average metering</li> </ul>
Metering range:	EV 1-20 (at 20°C with 50mm f/1.4 lens, ISO 100)
Exposure control systems:	Program AE (Full Auto, Portrait, Landscape, Close-up, Sports, Night Portrait, Flash Off, Program), shutter-priority AE, aperture-priority AE, depth-of-field AE, manual exposure, E-TTL autofocus
ISO speed:	Basic Zone modes: Automatic Creative Zone modes: Equivalent to ISO 100, 200, 400, 800, 1600, and ISO 3200 with ISO speed extension.
Exposure compensation:	AEB: +/-2 stops in 1/2- or 1/3-stop increments Manual: +/-2 stops in 1/2- or 1/3-stop increments (can be combined with AEB)
AE lock:	Auto: Applied when focus is achieved in the One Shot AF mode with evaluative metering. Manual: Applied with AE lock button.

## • Shutter

Type:	Electronically-controlled focal-plane shutter
-------	---

Shutter speeds:	1/4000 - 30 sec. (1/2- or 1/3-stop increments), bulb, X-sync at 1/200 sec.
Shutter release:	Soft-touch electromagnetic release
Self-timer:	10-sec. delay
Remote control:	N3-type remote control

### • Built-in Flash

Type:	Auto pop-up E-TTL autoflash (retractable)
Guide No.:	13 (ISO 100, meters), 43 (ISO 100, ft.)
Recycling time:	Approx. 3 sec.
Flash-ready indicator:	Flash-ready icon lights in viewfinder
Flash coverage:	18mm lens angle covered
Flash metering system:	E-TTL autoflash (linked to all AF points)
Flash exposure compensation:	+/-2 stops in 1/2- and 1/3-stop increments

### • External Speedlite

EOS-dedicated Speedlites:	E-TTL autoflash set with EX-series Speedlites
PC terminal:	Provided

### • Drive System

Drive modes:	Single frame, continuous, self-timer
Continuous shooting speed:	Approx. 3 fps (at 1/250 sec. or faster speeds) Max. burst during continuous shooting: 9 shots

### • LCD Monitor

Type:	TFT color liquid-crystal monitor
Screen size:	1.8 inches
Pixels:	Approx. 118,000
Image coverage:	Approx. 100% with respect to the effective pixels
Brightness control:	5 levels

### • Playback

Image display format:	Single image, single image (Info), magnified view (approx. 1.5x - 10x in 15 steps, consecutive magnified image viewing enabled), 9-image index, autoplay, image rotation, and jump
Highlight alert:	In the single image and single image (Info) modes, any overexposed highlight areas with no image information will blink.

### • Image Protection and Erase

Protection:	Single images can be protected or cancelled.
Erase:	Single image or all images in the CF card can be erased (except protected images).

### • Direct Printing from the Camera

Compatible printers:	Canon card photo printers and BJ printers for direct printing from the camera
Printable images:	JPEG images
Settings:	Print quantity, style (image, paper, borders, date), and trimming

## • Menus

Menu categories:	Shooting menu: Red, Playback menu: Blue, Setup menu: Yellow
LCD monitor language:	12 languages provided (English, German, French, Dutch, Danish, Finnish, Italian, Norwegian, Swedish, Spanish, Simplified Chinese, and Japanese.)
Firmware update:	Update possible by the user

## • Customize Function

Custom Functions:	17 Custom Functions with 61 settings
-------------------	--------------------------------------

## • Power Source

Battery:	One Battery Pack BP-511/BP-512 * AC power can be supplied via the DC coupler.
----------	--

Battery life:	Shooting Conditions	
	No Flash	50% Flash Use
	At 20°C / 68°F	500
	At 0°C / 32°F	400

\* The above figures apply when a fully-charged Battery Pack BP-511/BP-512 is used.

Battery check:	Automatic
Power saving:	Provided. Power turns off after 1, 2, 4, 8, 15, or 30 min.
Date/time back-up battery:	One CR2025 lithium battery

## • Dimensions and Weight

Dimensions (W x H x D):	149.7 x 107.5 x 75.0 mm / 5.9 x 4.2 x 3.0 in
Weight:	790 g / 27.9 oz (body only)

## • Operating Environment

Operating temperature range:	0 - 45°C / 32 - 113°F
Operating humidity range:	85% or lower

## • Battery Charger CB-5L

Compatible batteries:	Battery Pack BP-511/BP-512
Battery mount:	1
Power cord length:	Approx. 1.8 m / 5.9 ft.
Recharging time:	Approx. 90 min.
Rated input:	AC 100-240 V (50/60 Hz)
Rated output:	DC 8.4 V
Operating temperature range:	0 - 40°C / 32 - 104°F
Operating humidity range:	85% or lower
Dimensions (W x H x D):	91.0 x 32.3 x 67.0 mm / 3.6 x 1.3 x 2.6 in
Weight:	105 g / 3.7 oz (excluding power cord)

- All the specifications above are based on Canon's testing standards.
- The camera's specifications and physical appearance are subject to change without notice.

# Index

## A

A-DEP .....	88
AC Adaptor Kit .....	19,26
Accessories .....	174
Adobe RGB .....	58
AE .....	160
AE Lock .....	92,165
AEB (Auto Exposure Bracketing) .....	90
AF .....	160
AF Mode .....	64
AF Point .....	67
AF-Assist Beam .....	39
AI Focus AF .....	66
AI Servo AF .....	66
Aperture .....	161,166
Attaching the Strap .....	21
Auto playback .....	113
Auto power off .....	30
Auto Reset .....	59
Auto Rotation .....	61
Automatic Selection .....	68
Av .....	84

## B

Basic Terminology .....	160
Basic zone .....	18
Battery .....	22
Battery Charger .....	19
Battery Level Icons .....	24
Battery Life .....	25
BJ Printer .....	124
Built-in Flash .....	96
Bulb Exposures .....	93

## C

Card Photo Printer .....	122
Center-weighted Average Metering .....	75
CF Card .....	11,28,119,160,175
C.Fn .....	146
Changing the Review Time .....	43
Checking Camera Settings .....	62
Cleaning the Imaging Element .....	156
Clearing All Custom Functions .....	152
Close-up .....	40
Color Space .....	58
Color Temperature .....	53
Compression Rate .....	47
Continuous Numbering .....	59
Continuous shooting .....	76
Creative zone .....	18
Custom Functions .....	146

Custom White Balance .....	52
----------------------------	----

## D

Date/Time .....	154
DC coupler .....	19,26
Default Settings .....	34,35
Depth-of-field Preview .....	85,162
Dioptic Adjustment .....	36
Direct Printing .....	121,137
DPOF .....	131
Drive Mode .....	76

## E

E-TTL autoflash .....	95
Equipment Check List .....	3
Erasing .....	117
Erasing All Images .....	118
Erasing a Single Image .....	117
Error Codes .....	171
Evaluative Metering .....	75
Exposure .....	162
Exposure Compensation .....	89
Exposure Warning List .....	164
Eyepiece Cover .....	78

## F

FE Lock .....	100,105
FEB (Flash Exposure Bracketing) .....	104
File Numbering .....	59,161
Firmware .....	161
Flash Exposure Compensation .....	101,105
Flash off .....	41
Focus lock .....	65
Folders .....	161
Formatting .....	119,161
Full pressing .....	30
Fully Automatic .....	38
Function Availability Table .....	163

## H

Halfway pressing .....	30
High-Speed Sync .....	104
Highlight Alert .....	109
Holding the Camera .....	36
Household Power Supply .....	26
HP (Home Position) .....	69

## I

Image Information .....	109
Image Jump .....	112
Image Review .....	42
Image zone .....	18
Image-Recording Quality .....	46

Image Sensor ..... 156  
 Index print ..... 135  
 Index Display ..... 110  
 INFO ..... 62,109  
 Interface Cable ..... 3  
 ISO expansion ..... 141  
 ISO Speed ..... 49,160

**J**

JPEG ..... 47,160

**L**

Landscape ..... 40  
 LCD Brightness ..... 143  
 LCD Monitor ..... 10,35  
 LCD Panel ..... 10,16  
 LCD Panel Illumination ..... 94  
 Lens ..... 27

**M**

Magnified View ..... 111  
 Main Dial ..... 20,31  
 Main Switch ..... 30  
 Manual ..... 86  
 Manual Focusing ..... 71  
 Manual Selection ..... 68  
 Max. Capacity ..... 47  
 Menu Operations ..... 34  
 Menu Screen ..... 32  
 Menu Settings ..... 140  
 Metering Modes ..... 75  
 MF ..... 27,71  
 Mirror Lockup ..... 94  
 Mode Dial ..... 18  
 Modeling Flash ..... 105

**N**

Night Portrait ..... 41  
 Nomenclature ..... 14  
 Non-Canon Flash Units ..... 106  
 NTSC ..... 115,144  
 Number of copies ..... 127

**O**

On-screen Messages ..... 167  
 One-Shot AF ..... 65

**P**

PAL ..... 115,144  
 Parameters ..... 56  
 Partial Metering ..... 75  
 PC Terminal ..... 106  
 Portrait ..... 40

Print Order ..... 131  
 Printing Options ..... 135  
 Printing Style ..... 127  
 Print Type ..... 135  
 Processing ..... 47  
 Program AE ..... 80  
 Program Line ..... 165  
 Protection ..... 116

**Q**

Quantity ..... 127  
 Quick Control Dial ..... 20,31

**R**

RAW ..... 46,160  
 RAW + JPEG ..... 48  
 Recharging the Battery ..... 22,24,174  
 Red-eye Effect ..... 160  
 Red-eye Reduction ..... 99  
 Registering an AF Point ..... 69  
 Replacing the Battery ..... 155  
 Rotating an Image ..... 114

**S**

Self-timer ..... 77  
 Shifting the Program ..... 81  
 Shutter Button ..... 30  
 Shutter speed ..... 161,166  
 Simultaneous Capture ..... 48  
 Single -frame shooting ..... 76  
 Single image ..... 108  
 Specifications ..... 178  
 Speedlite ..... 102  
 Sports ..... 41  
 sRGB ..... 58  
 Standard print ..... 135  
 System Map ..... 176

**T**

Timer function ..... 20  
 Trimming ..... 129  
 Tv ..... 82

**V**

Video output ..... 115  
 Viewfinder ..... 17

**W**

WB-BKT ..... 54  
 White Balance ..... 50  
 White Balance Auto Bracketing ..... 54  
 Wireless Multi-Flash ..... 105



**CANON INC.** 30-2, Shimomaruko 3-chome, Ohta-ku, Tokyo 146-8501, Japan

**U.S.A.** ————— **CANON U.S.A. INC.**

For all inquiries concerning this camera, call toll free in the U.S.  
1-800-OK-CANON or write to: Customer Relations, Canon U.S.A., Inc.  
One Canon Plaza, Lake Success, N.Y. 11042-1198

**CANADA** ————— **CANON CANADA INC. HEADQUARTERS**

6390 Dixie Road, Mississauga, Ontario L5T 1P7, Canada

**CANON CANADA INC. MONTREAL BRANCH**

5990, Côte-de-Liesse, Montréal Québec H4T 1V7, Canada

**CANON CANADA INC. CALGARY OFFICE**

2828, 16th Street, N.E. Calgary, Alberta T2E 7K7, Canada

For all inquiries concerning this camera, call toll free in Canada

1-800-OK-CANON

**EUROPE,** ————— **CANON EUROPA N.V.**

**AFRICA &**

**MIDDLE EAST**

Bovenkerkerweg 59-61, P.O. Box 2262, 1180 EG Amstelveen, The Netherlands

**CANON COMMUNICATION & IMAGE FRANCE S.A.**

102, Avenue du Général de Gaulle 92257 La Garenne-Colombes Cedex, France

**CANON UK LTD.**

Woodhatch Reigate Surrey RH2 8BF, United Kingdom

**CANON DEUTSCHLAND GmbH**

Europark Fichtenhain A10, 47807 Krefeld, Germany

**CANON ITALIA S.p.A.**

Palazzo L, Strada 6, 20089 Rozzano, Milanofiori, Milano, Italy

**CANON Benelux N.V./S.A.**

Bessenveldstraat 7, 1831 Diegem (Machelen), Belgium

**CANON Schweiz AG**

Geschäftsbereich Wiederverkauf, Industriestrasse 12, CH-8305 Dietlikon, Switzerland

**CANON G. m. b. H.**

Oberlaaerstrasse 233, 4th floor, 1100 Wien, Austria

**CANON España, S. A.**

C/Joaquín Costa, 41, 28002 Madrid, Spain

**SEQUE Soc. Nac. de Equip., Lda.,**

Praça da Alegria, 58, 2º, 1269-149 Lisboa, Portugal

**CENTRAL &** ————— **CANON LATIN AMERICA, INC. DEPTO DE VENTAS**

**SOUTH AMERICA**

703 Waterford Way Suite 400 Miami, FL 33126 U.S.A.

**CANON LATIN AMERICA, INC. CENTRO DE SERVICIO Y REPARACION**

Apartado 2019, Zona Libre de Colón, República de Panamá

**ASIA** ————— **CANON HONGKONG CO., LTD.**

9/F, The Hong Kong Club Building, 3A Chater Road, Central, Hong Kong

**CANON SINGAPORE PTE. LTD.**

79 Anson Road #09-01/06 Singapore 079906

**OCEANIA** ————— **CANON AUSTRALIA PTY. LTD.**

1 Thomas Holt Drive, North Ryde, N.S.W. 2113, Australia

**CANON NEW ZEALAND LTD.**

Akoranga Business Park, Akoranga Drive, Northcote Auckland, New Zealand

**JAPAN** ————— **CANON SALES CO., INC.**

12-15 Mita, 3-Chome, Minato-ku, Tokyo 108-8011, Japan

This Instruction Manual booklet is current as of February 2003. For information on using the camera with system accessories introduced after this date, contact your nearest Canon Service Center.