

ENGLISH



Canon

Canon

DIGITAL CAMERA

PowerShot S330
DIGITAL ELPH

DIGITAL
IXUS 330

Camera User Guide

Canon

PowerShot S330
DIGITAL ELPH

DIGITAL
IXUS 330

Camera User Guide



- Please read the *Read this First* section (p. 7).
- Please refer to the *Software Starter Guide* for information on installing the software and downloading images.
- Please refer to the *Quick Start* section for a simple explanation of shooting, replaying and erasing (p. 12).
- Please also read the *Printer User Guide* included with your Canon printer.

Exif Print



Flowchart and Reference Guides

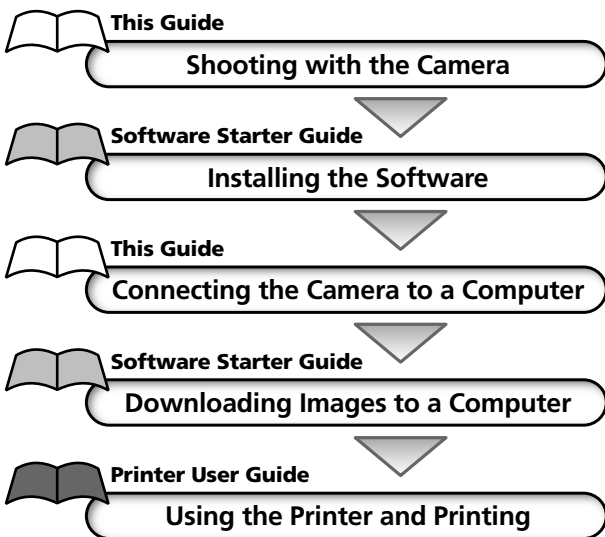

Precautions

This digital camera is designed to perform optimally when used with genuine Canon brand digital camera accessories (“Canon Brand Accessories”).

You may use non Canon Brand Accessories with this digital camera. However, Canon makes no warranties concerning, and is not responsible for damages resulting from, use of non Canon Brand Accessories.

Camera Body Temperature

If your camera is used for prolonged periods, the camera body may become warm. Please be aware of this and take care when operating the camera for an extended period.

About the LCD Monitor

The LCD monitor is produced with extremely high-precision manufacturing techniques. More than 99.99% of the pixels operate to specification. Less than 0.01% of the pixels may occasionally misfire or appear as red or black dots. This has no effect on the recorded image and does not constitute a malfunction.

Video Format





Please set the camera's video signal format to the one used in your region before using it with a TV monitor (p. 118).

Charging the Date/Time Battery

- The camera has a built-in rechargeable lithium battery that maintains the date, time and other camera settings. This battery recharges when the main battery pack is inserted into the camera. When you first purchase the camera, place a charged battery pack in it or use the AC adapter kit (sold separately) for at least 4 hours to charge the date/time battery. It will charge even when the camera power is set to Off.
- If the Set Date/Time menu appears when the camera power is turned on, it means that the date/time battery charge is depleted. Recharge it as described above.

About this Guide

Symbols Used

Icons on the right end of title bars show the operations mode. As in the example below, the mode dial should be set to , ,  or .

 **Self-timer**



White buttons indicate the button that will be pushed in the particular procedure. In the example here, for instance, you should press the **MENU** button.

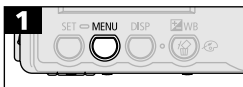

 This mark denotes issues that may affect the camera's operation.

 This mark denotes additional topics that complement the basic operating procedures.

Question? Look here first.

- How do I navigate the Menu?
Selecting Menus and Settings (p. 37)
- What settings are available under each function?
and
Will my settings remain in effect even after I've turned the camera off?
Functions Available in Each Shooting Mode (p. 76)
- How do I go about printing?
About Printing (p. 94)
- What functions are available through the menu?
Rec. Menu (p. 122)
Play Menu (p. 125)
Setup Menu (p. 127)
My Camera Settings (p. 129)

Table of Contents

Items marked with are lists or charts that summarize camera functions or procedures.

Read this First

Please Read	7
Safety Precautions	7
Preventing Malfunctions	11

Quick Start

Quick Start	12
-------------------	----

Components Guide

Front View	14
Back View	15
Operation Panel	16
Indicators	17
Mode Dial	18

Preparing the Camera

Charging the Battery Pack	19
Installing the Battery Pack	21
Installing a CF Card	23
Setting the Date / Time	25
Setting the Language	26









Basic Functions

Turning the Power On/Off	27
Using the LCD Monitor	29
Using the Viewfinder	33
Pressing the Shutter Button	34
Using the Zoom	36
Selecting Menus and Settings	37
Menu Settings and Factory Defaults	40



Customizing the Camera (My Camera Settings)

Changing My Camera Settings	43
Customizing My Camera Settings	44

Shooting

Selecting a Shooting Mode	45
Reviewing an Image Right after Shooting	46
Changing Resolution/Compression Settings	47
 Using the Flash	49
 Shooting Close-Ups/Infinity Shots	51
Using the Digital Zoom	52
 Shooting Continuously	53
 Using the Self-timer	54
 Shooting in Stitch Assist Mode	55
 Shooting a Movie	58
Locking the Focus (AF Lock)	60
Locking the Exposure Setting (AE Lock)	62
Locking the Flash Exposure Setting (FE Lock)	63
Switching between Autofocus Modes	64
 Switching between Light Metering Modes	65
 Adjusting the Exposure Compensation	66
Shooting in Long Shutter Mode	67
WB Setting the White Balance	69
Setting a Custom White Balance	70
 Changing the Photo Effect	72
Adjusting the ISO Speed	73
Setting the Auto Rotate Function	74
Resetting the File Number	75
Functions Available in Each Shooting Mode	76

Replaying

Viewing Images Individually (Single Image View)	78
 Magnifying Images	79
 Viewing Images in Sets of Nine (Index View)	80
Viewing Movies	81

Rotating Images in the Display	83
Attaching Sound Memos to Images	84
Automating Playback (Slide Shows)	86
Protecting Images	90

Erasing

 Erasing Single Images	91
Erasing All Images	92
Formatting CF Cards	93

Printing

About Printing	94
Print Menu Settings	96
Connecting a Printer	98
Printing	101
Setting the Print Settings (Direct Print Function)	103
Setting the DPOF Print Settings	107

Image Transmission Settings (DPOF Transfer Order)

Selecting Images for Transferring	116
---	-----

Shooting/Replaying with a TV Monitor

Shooting/Replaying with a TV Monitor	118
--	-----

Downloading Images to a Computer

Downloading Directly from a CF Card	119
Connecting the Camera to a Computer with a USB Cable	120

Lists of Menu Options and Messages

Rec. Menu	122
Play Menu	125
Set Up Menu	127
My Camera Menu	129
Resetting All Settings to Their Default Values	132
List of Messages	133

Appendices

Using a Household Power Source	137
Using a Car Battery Charger	138
Camera Care and Maintenance	139
Troubleshooting	140

Specifications

Specifications	144
----------------------	-----

Index

Index	150
-------------	-----

Read this First

Please Read

Test Shots

Before you try to photograph important subjects, we highly recommend that you shoot several trial images to confirm that the camera is operating and being operated correctly. Please note that Canon, its subsidiaries and affiliates, and its distributors are not liable for any consequential damages arising from any malfunction of a camera or accessory, including CompactFlash™ cards, that results in the failure of an image to be recorded or to be recorded in a format that is machine readable.

Warning Against Copyright Infringement

Please note that Canon digital cameras are intended for personal use and should never be used in a manner that infringes upon or contravenes international or domestic copyright laws and regulations. Please be advised that in certain cases the copying of images from performances, exhibitions, or commercial properties by means of a camera or other device may contravene copyright or other legal rights even if the image was shot for personal use.

Warranty Limitations

This camera's warranty is only effective in the country of sale. If a problem arises while the camera is in use abroad, please convey it back to the country of sale before proceeding with a warranty claim to a Canon Customer Support Help Desk.

For Canon Customer Support contacts, please see the Canon Limited Warranty supplied with your camera.

Safety Precautions

- Before using the camera, please ensure that you read and understand the safety precautions described below. Always ensure that the camera is operated correctly.
- The safety precautions noted on the following pages are intended to instruct you in the safe and correct operation of the camera and its accessories to prevent injuries or damage to yourself, other persons and equipment.
- In the next few pages, the term "equipment" refers primarily to the camera and its power supply accessories, such as the battery charger and optional compact power adapter or car battery charger.

 **Warnings**

- Do not aim the camera directly into the sun or at other intense light sources that could injure your eyesight.

- Do not trigger the flash in close proximity to human or animal eyes. Exposure to the intense light produced by the flash may injure eyesight. In particular, remain at least one meter (39 inches) away from infants when using the flash.

- Store this equipment out of the reach of children and infants. Accidental damage to the camera or batteries by a child could result in serious injury. In addition, placement of the strap around the child's neck could result in asphyxiation.

- Do not attempt to disassemble or alter any part of the equipment that is not expressly described in this guide. Disassembly or alteration may result in high-voltage electrical shock. Internal inspections, alterations and repairs should be conducted by qualified service personnel authorized by your camera distributor or a Canon Customer Support Help Desk.

- To avoid the risk of high-voltage electrical shock, do not touch the flash portion of the camera if it has been damaged. Similarly, never touch internal portions of the equipment that become exposed as a result of damage. There is a risk of high-voltage electrical shock. Please take the first opportunity to consult your camera distributor or the closest Canon Customer Support Help Desk.

- Stop operating the equipment immediately if it emits smoke or noxious fumes. Failure to do so may result in fire or electrical shock. Immediately turn the camera's power off, remove the camera battery and unplug the power cord from the electrical outlet. Confirm that smoke or fume emissions have ceased. Please consult your camera distributor or the closest Canon Customer Support Help Desk.

- Stop operating the equipment if it is dropped or the casing is damaged. Failure to do so may result in fire or electrical shock. Immediately turn the camera's power off, remove the camera battery and unplug the power cord from the electrical outlet. Please consult your camera distributor or the closest Canon Customer Support Help Desk.

-
- Do not allow the equipment to come into contact with, or become immersed in, water or other liquids. Do not allow liquids to enter the interior. The camera has not been waterproofed. If the exterior comes into contact with liquids or salt air, wipe it dry with a soft, absorbent cloth. If water or other foreign substances enter the interior, immediately turn the camera's power off and remove the camera battery or unplug the power cord from the electrical outlet. Continued use of the equipment may result in fire or electrical shock. Please consult your camera distributor or the closest Canon Customer Support Help Desk.
-
- Do not use substances containing alcohol, benzene, thinner or other flammable substances to clean or maintain the equipment. The use of these substances may lead to fire.
-
- Remove the power cord on a regular periodic basis and wipe away the dust and dirt that collects on the plug, the exterior of the electrical outlet and the surround area. In dusty, humid or greasy environments, the dust that collects around the plug over long periods of time may become saturated with humidity and short-circuit, leading to fire.
-
- Do not cut, damage, alter or place heavy items on the power adapter cord. Any of these actions may cause an electrical short circuit, which may lead to fire or electrical shock.
-
- Do not handle the power cord if your hands are wet. Handling it with wet hands may lead to electrical shock. When unplugging the cord, ensure that you hold the solid portion of the plug. Pulling on the flexible portion of the cord may damage or expose the wire and insulation, creating the potential for fires or electrical shocks.
-
- Use of power sources not expressly recommended for this equipment may lead to overheating, distortion of the equipment, fire, electrical shock or other hazards. Use only the recommended power accessories.
-
- Do not place the batteries near a heat source or expose them to direct flame or heat. Neither should you immerse them in water. Such exposure may damage the batteries and lead to the leakage of corrosive liquids, fire, electrical shock, explosion or serious injury.
-
- Do not attempt to disassemble, alter or apply heat to the batteries. There is serious risk of injury due to an explosion. Immediately flush with water any area of the body - including the eyes and mouth, or clothing - that comes into contact with the inner contents of a battery. If the eyes or mouth contact these substances, immediately flush with water and seek medical assistance.
-

-
- Avoid dropping or subjecting the batteries to severe impacts that could damage the casings. It could lead to leakage and injury.
-
- Do not short-circuit the battery terminals with metallic objects, such as key holders. It could lead to overheating, burns and other injuries. Use the supplied terminal cover or battery case to transport or store the battery pack.
-
- Before you discard a battery, cover the terminals with tape or other insulators to prevent direct contact with other objects. Contact with the metallic components of other materials in waste containers may lead to fire or explosions. Discard the batteries in specialized waste facilities if available in your area.
-
- Use of batteries not expressly recommended for this equipment may cause explosions or leaks, resulting in fire, injury and damage to the surroundings. Use only recommended batteries and accessories.
-
- Use the specified battery charger to charge Battery Pack NB-1LH or NB-1L. Use of other chargers may lead to overheating, distortion of the equipment, fire or electrical shock.
-
- Disconnect the battery charger and compact power adapter from both the camera and the electrical outlet after recharging and when they are not in use to avoid fire and other hazards. Continuous use over a long period may cause a unit to overheat and distort, resulting in fire.
-
- The camera terminal of the supplied compact power cord is designed for exclusive use with your camera. Do not use it with other products or batteries. There is a risk of fire and other hazards.
-

Cautions

- Avoid using, placing or storing the equipment in places subject to strong sunlight or high temperatures, such as the dashboard or trunk (boot) of a car. Exposure to intense sunlight and heat may cause the batteries to leak, overheat or explode, resulting in fire, burns or other injuries. High temperatures may also cause deformation of the casing. Ensure that there is good ventilation when using the compact power adapter to charge the battery pack or power the camera.
-
- Do not store the equipment in humid or dusty areas. Storage in such areas could lead to fire, electrical shock or other damage.
-
- Be careful not to bang the camera or subject it to strong impacts or shocks that could lead to injury or damage the equipment when wearing or holding it by the strap.
-

- Be careful not to cover the flash with your fingers when shooting. In addition, do not touch the surface of the flash after taking several pictures in rapid succession. Either action could result in burns.
- If your camera is used for prolonged periods, the camera body may become warm. Please take care when operating the camera for extended periods as your hands may experience a burning sensation.

Preventing Malfunctions

Avoid Strong Magnetic Fields

Never place the camera in close proximity to electric motors or other equipment generating strong electromagnetic fields. Exposure to strong magnetic fields may cause malfunctions or corrupt image data.

Avoid Condensation Related Problems

Moving the equipment rapidly between hot and cold temperatures may cause condensation (water droplets) to form on its external and internal surfaces. You can avoid this by placing the equipment in an airtight, resealable plastic bag and letting it adjust to temperature changes slowly before removing it from the bag.

If Condensation Forms Inside the Camera

Stop using the camera immediately if you detect condensation. Continued use may damage the equipment. Remove the CF card and battery or Compact Power Adapter (if connected) from the camera and wait until the moisture evaporates completely before resuming use.

Extended Storage

When not using the camera for extended periods of time, remove the battery pack and store the equipment in a safe place. Storing the camera for extended periods with a battery pack installed will run down the battery pack and may damage the camera. Please note, however, that the date, time and other camera settings may reset to the default settings if the battery pack has been removed for more than three weeks. Follow the instructions in this guide to reset the desired settings.

Quick Start

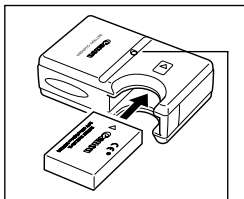

Charging Indicator

1 Charge the Battery Pack (p. 19).

Place the battery pack in the battery charger and plug the charger into an electrical outlet. The charging indicator shines red while charging and changes to green when the battery pack is charged.

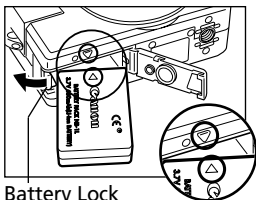

Battery Lock

2 Install the Battery Pack (p. 21).

Slide the battery cover open and press the battery lock while you insert the battery pack. Insert the battery pack correctly by aligning the arrows on the camera and battery pack.

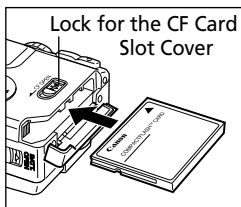

3 Install the CF Card (p. 23).

Slide the lock on the CF card cover to open it and insert the CF card.

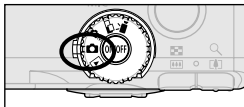

4 Turn the Mode Dial to (Auto) (p. 45).

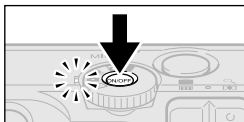

5 Turn on the Power (p. 27).

Press the ON/OFF Button until the green power lamp beside the mode dial lights.

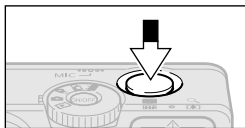

6 Focus (p. 34).

Aim the camera and lightly press (halfway) the shutter button. Two beeps will sound when the autofocus is set.

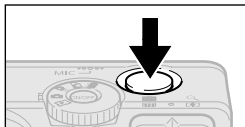

7 Shoot (p. 35).

Press the shutter button all the way. One shutter sound will sound when the shot is complete.



8 View the Recorded Image (p. 46).

The recorded image appears in the LCD monitor for approximately 2 seconds. To continue displaying the image, keep the shutter button pressed or hold the shutter button until you press the **SET** button and then release both.



- To Immediately Delete the Displayed Image

1. Press the  button while the image is displayed.
2. Confirm that [Erase] is selected and press the **SET** button.



- Set the date and time if the Set Date/Time menu appears (p. 25).
- You can change the language in which menus are displayed (p. 26).
- To view the other images you have photographed, refer to the *Replaying* section (p. 78).
- After you finish using the camera, press the ON/OFF Button to shut the power off.

Components Guide

Front View

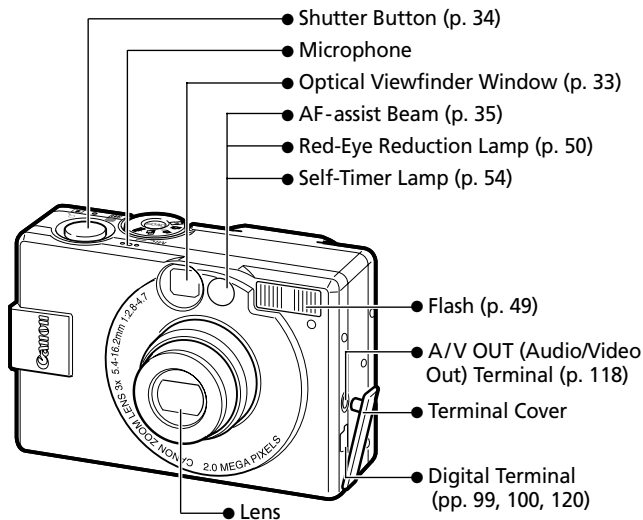

• **The following cables are used to connect the camera to a computer or printer.**

- Computer (p. 120)
USB Interface Cable IFC-300PCU (supplied with camera)
- Direct Print Function compliant printer (sold separately) (p. 98)
Direct Interface Cable DIF-100 (supplied with printer)
- Direct Print Function compliant Bubble Jet Printer (sold separately) (p. 99)
Please refer to your *Bubble Jet Printer Quick Start Guide*

Please refer to the *System Map* supplied with the camera for direct print function compatible printers.

Back View

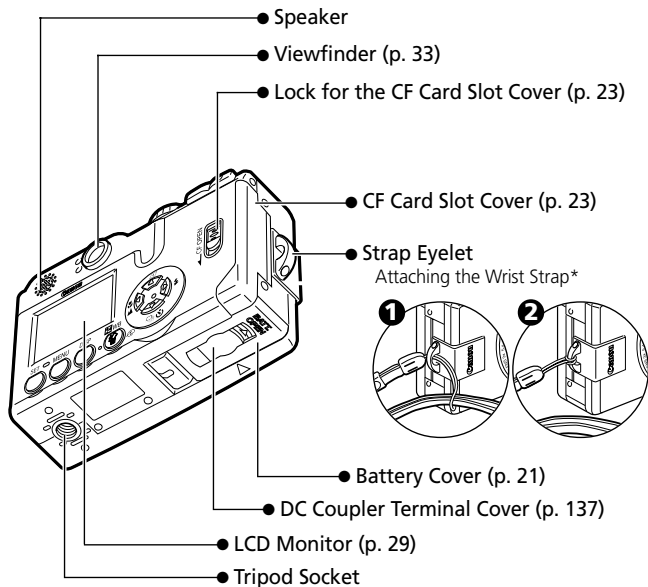

* Be careful not to wave the camera about or catch it on other items when dangling it from the wrist strap.

Operation Panel

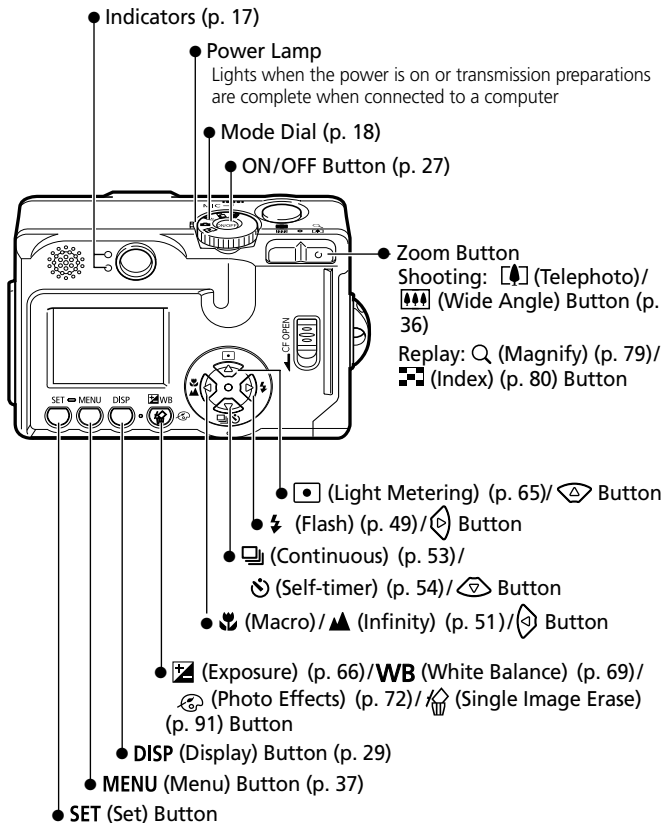

Indicators

The indicators shine or flash when the ON/OFF Button or shutter button is pressed.

Upper Indicator

Green:	Ready to shoot
Flashing Green:	Initializing camera/Recording to CF card / Reading CF card/Erasing from CF card/ Transmitting data (during a computer connection)
Orange:	Ready to shoot with slow shutter speed (flash on)
Flashing Orange:	Ready to shoot but shutter speed is slow (camera shake warning)

Lower Indicator

Yellow:	Macro mode/Infinity mode/Focus lock (Method 2, p. 60)
Flashing Yellow:	Focusing difficulty (1 beep sounds). Although you can press the shutter button, you are recommended to use the focus lock (p. 60).

Mode Dial

The mode dial is used to select shooting or replay modes.



Shooting Modes

(Auto)

- The camera selects most settings automatically (p. 45).

(Manual)

- You can set the exposure compensation, white balance and other settings manually (p. 45).

(Stitch Assist)

- Shoot images in overlapping series to create panoramas (p. 55).

(Movie)



- Shoot movie clips (p. 58).

Replay Mode

(Replay)

- Images recorded onto the CF card can be replayed or erased (pp. 78, 91).
- Recorded images can be printed when a printer (sold separately) is connected (p. 94).
- Images can be downloaded to and viewed on a computer when it is connected (p. 119).



- The  or  icon displays on the LCD monitor when a connection to a printer is opened.
- The LCD monitor shuts off while a computer is connected.

Preparing the Camera

Charging the Battery Pack

Use the following procedures to charge the battery pack the first time you use the camera or when the “Change the battery pack” message displays.

Battery charger model names and types vary by region.

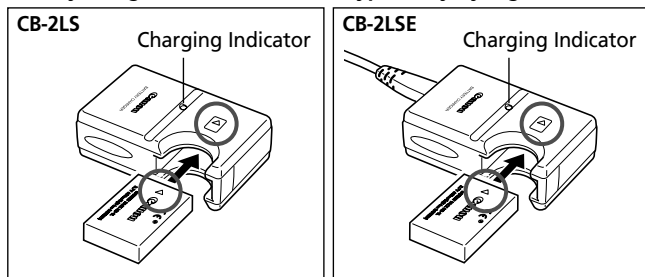

- Insert the battery pack all the way into the battery charger as shown and insert the charger's plug into an electrical outlet.
- Align the battery pack correctly with the arrows on it and the charger.
- The charging indicator will shine red while the battery pack is charging. It will change to green when the charge is complete.
- After charging, unplug the battery charger and remove the battery pack.



- To protect the battery pack and prolong its life, do not charge it for longer than 24 hours continuously.



- Since this is a lithium ion battery pack, you need not completely discharge it before recharging. It can be recharged at any point.
- It takes approximately 130 minutes to fully charge the battery pack from a fully discharged state (based on standard Canon testing criteria). Please charge it at an ambient temperature ranging between 5° and 40° C (41° and 104° F).
- Charge times may vary according to the ambient temperature and the battery pack's charge state.
- See *Battery Capacity* (p. 146).

Handling Precautions

- Keep the battery pack terminals (\oplus \ominus) clean at all times. Dirty terminals may cause poor contact between the battery pack and camera. Polish the terminals with a tissue or a dry cloth before charging or using the battery pack.
- Do not rapidly overturn or wave the battery charger around when it contains the battery pack. The battery pack could fly out.
- At low temperatures, battery pack performance may be reduced and the low battery icon may appear earlier than usual. Under these conditions, resuscitate the battery pack by warming it in a pocket immediately before use. However, ensure that there are no metallic items in the pocket that could cause a short circuit, such as a key holder, etc.
- Do not place anything, such as tablecloths, carpets, bedding or cushions, on top of the battery charger while it is charging. Heat will build up and could result in a fire.
- Do not charge batteries other than Battery Pack NB-1LH or NB-1L in this charger.
- The battery pack continues to discharge a minimal portion of its power while installed in the camera, even with the power off, or in the charger. This will shorten battery life.
- Do not allow any metal objects such as keyrings to touch the "+" and "-" terminals (Fig. A), as this can damage the battery pack. To carry the battery pack or store it during periods of disuse, always replace the terminal cover (Fig. B) or place it in the supplied case and store it in a cool, dry place. Recharge it fully before using it again.

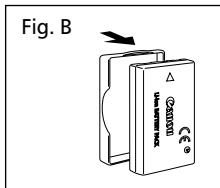
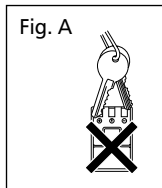

- If the performance of the battery pack diminishes substantially even when it is fully charged, its life has been exceeded and it should be replaced.

Installing the Battery Pack

Install Battery Pack NB-1LH (supplied) as shown below. Battery Pack NB-1L (optional) can also be used with the camera.



- Please recharge the battery pack (p. 19) before you use it for the first time.

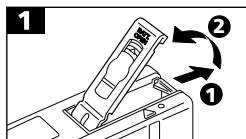

- Slide the battery cover in the direction of the arrows.

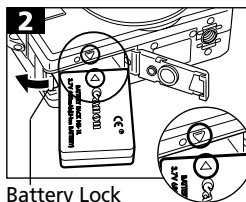

Battery Lock

- Press the battery lock while inserting the battery pack all the way in until the lock clicks.
- Insert the battery pack correctly by aligning the arrows on the camera and the battery pack.
- To remove the battery pack, press the battery lock and pull the battery pack out.

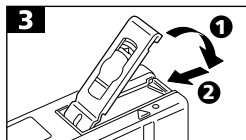

- Slide the battery cover closed.



- Do not turn off the power or open the battery cover while the camera's indicator flashes green. The camera is writing, reading, erasing or transmitting an image to or from the CF card.
- Remove the battery pack when the camera is not in use. Please note, however, that the date, time and other camera settings may reset to the default settings if the battery pack has been removed for more than three weeks.



- Please use a household power source for extended use of the camera (p. 137).

Battery Pack Charge

The following icons and messages will display when the battery pack charge is low.

	<p>Battery pack charge is low. Recharge it as soon as possible before it is required for an extended period.</p> <p>When the LCD monitor is off, this icon will display when you press the , / , / , DISP or button (CAM mode).</p>
<p>Change the battery pack</p>	<p>Battery charge is insufficient to operate the camera. Replace the battery pack immediately.</p>



- See *Battery Capacity* (p. 146).

Installing a CF Card

Turn the camera power off and insert the CF card with the following procedures.

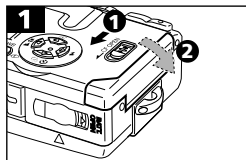

- Slide the lock down and open the CF card slot cover.

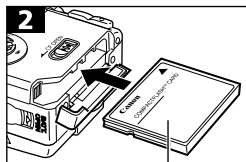

- Insert the CF card with its label facing upward until the slot's eject button fully extends. Close the CF card slot cover.

Label

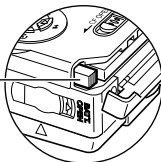

CF Card Eject Button

- To remove the CF card, push the eject button and pull the CF card out.



- Since the camera is writing, reading, erasing or transmitting data to or from the CF card when the indicator flashes green, never perform the following actions during this time. It could corrupt the image data.
 - Subject the camera body to vibration or shocks.
 - Turn the camera's power off or open the CF card slot cover.
- Please note that CF cards from other manufacturers, or CF cards which have been edited with application software using other formats, may not operate correctly in the camera.



- See *CF Cards and Estimated Capacities* (p. 147).

Handling Precautions for CF Cards

- CF cards are high-precision electronic devices. Do not bend them, apply force to them, or subject them to shocks or vibration.
- Do not attempt to disassemble or alter a CF card.
- Moving a CF card rapidly between temperature extremes will cause condensation to form in the card and lead to a malfunction. To avoid condensation, place the CF card in a sealed plastic bag before moving it into a different temperature zone and allow it to adjust slowly to the new temperature. If condensation forms on the CF card, store it at room temperature until the water droplets have evaporated naturally.
- Do not use or store CF cards in the following types of location.
 - Locations subject to dust or sand
 - Locations subject to high humidity and high temperatures

Setting the Date and Time

The Set Date/Time menu will appear the first time the camera power is turned on or whenever the built-in rechargeable lithium battery charge is low. Start from Step 3 to set the date and time.

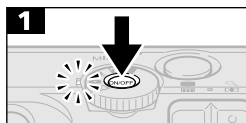

- Press the ON/OFF Button until the power lamp lights.

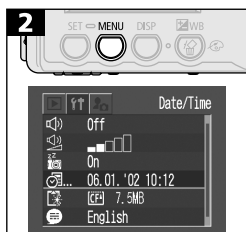

- Press the **MENU** button to display the Rec. or Play menu.
- Use the or button to select the (Set up) menu.
- Use the or button to select .

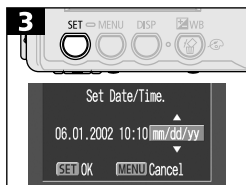

- Use the or button to select a field (year, month, day, hour, minute and date format), and the or button to change its value.



- To put the settings into effect, press the **SET** button after setting the date format.



- Press the **MENU** button to redisplay the Rec. or Play menu.



- Please note that the date and time settings may reset to the default settings if the camera battery has been removed for more than three weeks. Reset them when this occurs.

Setting the Language

The language in which menus and messages are displayed can be selected with this function.

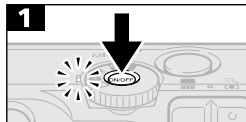

- Press the ON/OFF Button until the power lamp lights.



- Press the **MENU** button to display the Rec. or Play menu.

- Use the or button to select the (Set up) menu.
- Use the or button to select .



- Use the , , or button to select a language.



- Press the **MENU** button to redisplay the Rec. or Play menu.



- The Language menu can also be displayed in replay mode by holding down the **SET** button and pressing the **MENU** button. However, language settings cannot be adjusted while a printer is connected.

Basic Functions

Turning the Power On/Off

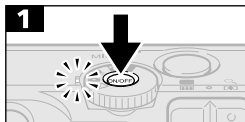

- Press the ON/OFF Button until the green power lamp lights.
 - The upper indicator beside the viewfinder will flash green.
 - The lens will extend when the mode dial is turned to the , , or position.
 - The lens will retract approximately 1 minute after the mode dial is turned to from any shooting mode.
 - When the mode dial is set to the , or position, the LCD monitor will turn on regardless of its On/Off status.
- Press the ON/OFF Button again to turn off the power.



- The Set Date/Time menu will appear the first time the camera power is turned on or whenever the charge of the built-in rechargeable lithium date/time battery is low. Reset the date and time when this occurs (p. 25).
- If the auto power save function activates, press the ON/OFF Button to restore power.



- **Power Save Function**

This camera is equipped with a power save function. The power will automatically shut down under the following circumstances when this function is set to On. Press the ON/OFF Button to restore power.

Shooting Mode

Powers down approximately 3 minutes after the last control is accessed on the camera. (The LCD monitor automatically turns off 3 minutes after the last control is accessed even if this function is set to Off. Press any button except the ON/OFF Button to turn the LCD monitor back on.)

Replay Mode

Powers down approximately 5 minutes after the last control is accessed on the camera.

Connected to a Printer (optional)

Powers down approximately 5 minutes after the last control is accessed on the camera or something is printed on a connected printer.

Connected to a Computer

A warning message displays on the computer screen approximately 5 minutes after the last control is accessed. Powers down approximately 1 minute later if no control is accessed.

- The power save function will not activate during a slide show.
 - The camera's settings can be changed to turn off the power save function (p. 127).
-

Using the LCD Monitor

The LCD monitor can be used to compose images while shooting, adjust settings menus and replay images.



- The image in the LCD monitor will darken in strong sunlight or bright light. This does not constitute a malfunction.

Shooting Mode

(, , and on the mode dial)



- The LCD monitor turns on or changes the display mode as follows with each press of the **DISP** button.

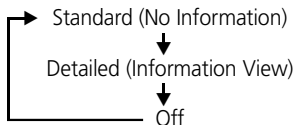

- The LCD monitor setting (On or Off) is saved by the camera when the power is turned off so that the same setting is automatically available when the power is turned on again. However, the setting may be lost when the power has been turned off after the “Change the battery pack” message has displayed, while the LCD monitor was on in shooting mode.
- In the or mode, the LCD monitor turns on regardless of its On/Off setting.



- Set the flash to [On] or affix the camera to a tripod when the upper indicator flashes orange and the camera blur warning icon () appears in the LCD monitor after the metering preparations are complete.

Replay Mode (▶ on the mode dial)



- The LCD monitor will turn on when the mode dial is set to the ▶ position.
- In replay mode, pressing the **DISP** button cycles between display modes.

Single Image Replay

Standard → Detailed → No Display



Multi Image Replay (9 Images)

Standard ↔ No Display

Information Displayed on the LCD Monitor

Shooting Mode

In shooting mode, information about the current settings and remaining image capacity will display on the LCD monitor for approximately six seconds when the actions below are taken, regardless of whether the LCD monitor is set to On or Off.

- The power is turned on.
- The **DISP**, , , / or button (CAM mode) is pressed.
- The camera settings are changed.
- The Rec., Setup or My Camera menu is closed.

While this information is displayed, you may set the flash, continuous mode, self-timer, macro and infinity settings.



- After you press the shutter button and take a shot, the recorded image appears on the LCD monitor for 2 (or 10) seconds. (It will continue to display if you press the **SET** button while it is shown on the screen.) While it is displayed, you can check the exposure with the graph (see Histogram, p. 32) that shows the distribution of the brightness data. (Press the **DISP** button if the histogram and other information is not shown) If the exposure requires adjustment, set the exposure compensation and reshoot.

In movie mode, only the resolution shows (not compression).

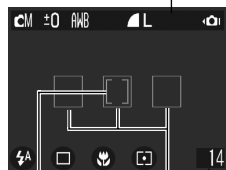

AF Frame

Recordable Images
or Recordable
Movie Time (sec.)

Spot AE
Point Frame

Information Displayed

	Shooting Mode	p. 45
	Exposure Compensation	p. 66
	Long Shutter	p. 67
	White Balance	p. 69
	Photo Effects	p. 72
	Compression	p. 47
	Resolution	p. 47
	ISO Speed	p. 73
	Auto Rotate	p. 74
	Focus Lock	p. 60
	AE Lock	p. 62
	FE Lock	p. 63
	Flash	p. 49
	Shooting Method	p. 53/54
	Macro/Infinity	p. 51
	Metering Method	p. 65
	Movie Recording	p. 58
	Digital Zoom	p. 52
	Camera Blur Warning	p. 29
	Low Battery	p. 22

- The icons in the shaded boxes above display regardless of the selected display mode.
- Zoom powers reflect the optical and digital zoom functions in combination. These figures display when the digital zoom is activated.

Replay Mode (Standard Display)

File Number



Image Number

Shooting Date

The following information is displayed in standard display mode.

	Compression	p. 47
	Resolution (still)	p. 47
	Wave Format Sound	p. 85
	Movie	p. 58
	Protection Status	p. 90

Replay Mode (Detailed Display)

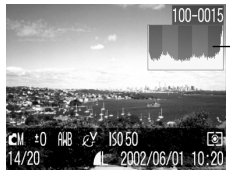

Histogram

In detailed display mode, the following supplementary information is displayed.

1" ... 15"	Long Shutter Mode	p. 67
	Shooting Mode	p. 45
-2 ... -0 ... +2	Exposure Compensation	p. 66
	White Balance	p. 69
	Photo Effects	p. 72
ISO 50 100 200 400	ISO Speed	p. 73
	Flash	p. 49
	Macro/Infinity	p. 51
	Metering Method	p. 65
640 820 1160	Resolution (Movie)	p. 47
	Movie Length Shown on Movie Files	p. 58

The following information may also be displayed with some images.

	A sound file in a format other than the WAV format is attached or the file format is not recognized.
	JPEG file with format not conforming to Design rule for Camera File System Standards
	RAW format file
	File with unrecognized format



- The image information may not display correctly if images shot with this camera are replayed on other cameras or images from other cameras are replayed on this camera.
- **Histogram Function**

The histogram is a graph that allows you to judge the brightness of the recorded image. The greater the bias toward the left, the darker the image. The more it trends to the right, the brighter the image. If the image is dark, adjust the exposure to a positive value. Similarly, adjust the exposure to a negative value to darken a bright image (p. 66).

Histogram Examples



Dark Image



Balanced Image



Bright Image

Using the Viewfinder

The optical viewfinder can be used to conserve power while shooting. Aim the square brackets (autofocus metering field) inside the viewfinder at the primary subject to shoot. The field of vision is approximately 82% at the maximum telephoto setting.

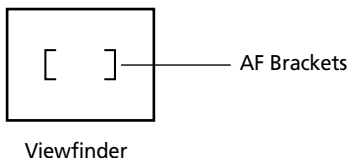

• About the Autofocus Function

This camera employs AiAF (artificial intelligence autofocus) technology which uses a broad metering field to calculate the focal distance with high precision. It delivers a crisp focus even when the photographic subject is slightly off-center.

The AiAF function can be turned off so that the autofocus is metered from a fixed AF frame at the center of the field to accommodate difficult shooting conditions (p. 64).

• Image Seen in Viewfinder vs. Recorded Image

Please note that the actual image may differ from the image seen in the optical viewfinder due to the physical separation between the viewfinder and lens. This is called the parallax phenomenon and is more noticeable the closer the subject is to the lens. In some cases, portions of images shot up close that appear in the viewfinder will not appear in the recorded image. You are recommended to use the LCD monitor to shoot images up close.

Pressing the Shutter Button

The shutter button features a two-stage action.

Pressing Halfway

Pressing halfway automatically sets the exposure, focus and white balance.

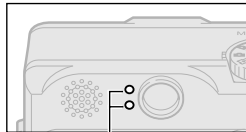
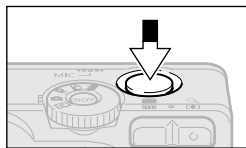

Indicator

• Indicator Status

Upper Indicator

- Green: Metering complete (two beeps sound)
- Orange: Flash will fire
- Flashing Orange: Camera shake warning/
Insufficient exposure

Lower Indicator

- Yellow: Macro mode/Infinity mode/Focus lock
(Method 2, p. 60)
- Flashing Yellow: Focusing difficulty*
(single beep sounds)

* When the indicator flashes yellow, lock the focus before shooting (p. 60).

• AF Frame Status (LCD Monitor On)

AiAF On

- Green Frame: Metering complete (AF frame when focus achieved)
- No Frame: Focusing difficulty

AiAF Off (Center AF Frame)

- Green Frame: Metering complete
- Yellow Frame: Focusing difficulty

Pressing Fully

Pressing the shutter button down fully activates the shutter and causes one shutter sound to sound.

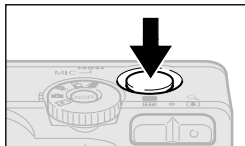

- While the image is being recorded to the CF card, the indicator flashes green.



- AF-assist Beam
 - The AF-assist Beam will sometimes emit when the shutter button is pressed halfway to assist focusing in certain conditions. i.e. dark conditions.
 - The AF-assist Beam can be turned off (p. 123). If animals are your subject, turn off the beam when shooting in the dark to avoid startling them (this may however, make it more difficult for the camera to focus).

Using the Zoom

The zoom can be adjusted to any setting in the 35 to 105 mm range in 35 mm film equivalent terms.

Telephoto/Wide Angle

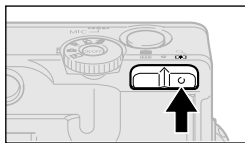

- Pressing the  button zooms in, making the subject appear larger in the composition.

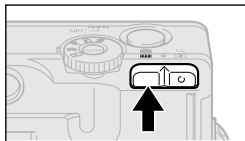

- Pressing the  button zooms out, making the subject appear smaller in the composition.

Digital Zoom

When the LCD monitor is on, you can shoot with a combined optical and digital zoom factor of up to 7.5 (p. 52).



- The digital zoom is unavailable in some modes (p. 77).



- Please note that the image appears grainier, the more the image is digitally zoomed.

Selecting Menus and Settings

Menus are used to adjust shooting and replay settings. The procedures for using menus are shown below. For a complete list of the settings and options, please see the *Menu Settings and Factory Defaults* (p. 40).

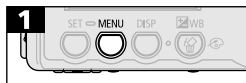

- Press the **MENU** button.

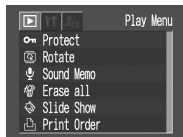

- When the Mode Dial is set to , , or .
- When the Mode Dial is set to .

- 2** • Use the or buttons to select the Rec., Play or Set up menu.

- 3** • Use the or buttons to select an option.



- With some Rec./Set up menu items, the or buttons select the options for the items.

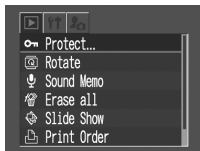

- With some Play/Set up menu items, a submenu appears after you press the **SET** button.



- Press the **MENU** button.

Selecting Menus and Settings (Cont'd)

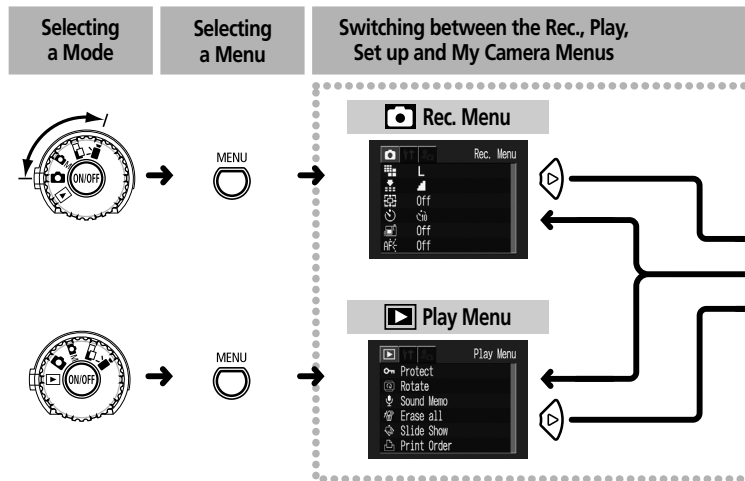

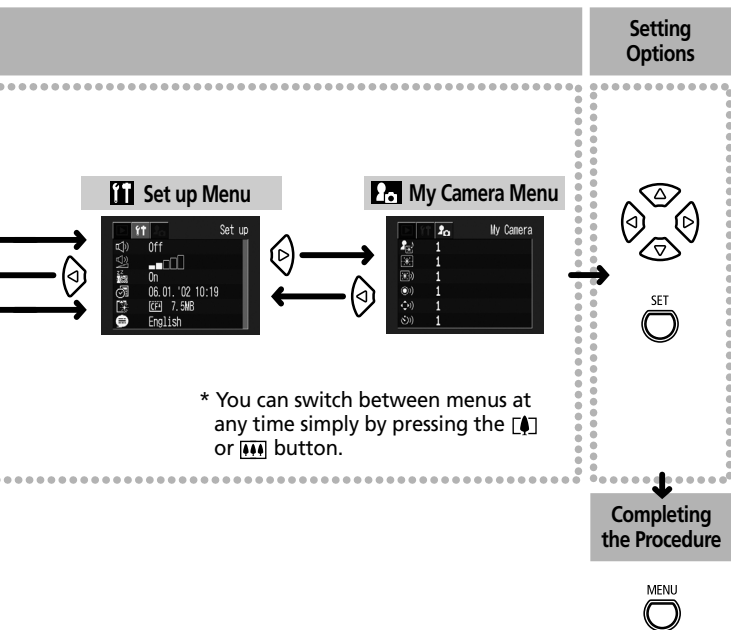





























































- See *Print Menu Settings* (p. 96) for the procedures used with the (Print Order) item in the Play menu.

Menu Settings and Factory Defaults

This chart shows the options and default settings for each menu.

	Menu Item	Available Settings	Reference Page
 Rec. Menu (Red)	 Resolution (Stills)	L 1600x1200* / M 1024x768 / S 640x480	p. 47
	 Resolution (Movies)	640 640x480 / 320 320x240* / 160 160x120	p. 47
	 Compression	S Superfine /  Fine* /  Normal	p. 47
	 ISO Speed	50* / 100 / 200 / 400 / AUTO	p. 73
	 AiAF	On*/Off	p. 33
	 Digital Zoom	On/Off*	p. 52
	 Self-timer	 */ 	p. 54
	 Image Review	Off/2 sec.* / 10 sec.	p. 46
	 AF-assist Beam	On*/Off	p. 35
	 File No. Reset	On/Off*	p. 75
	 Auto Rotate	On*/Off	p. 74
 Long Shutter	On/Off*	p. 67	
 Play Menu (Blue)	 Protect	Turns image protection On/Off.	p. 90
	 Rotate	Rotates the image in the display.	p. 83
	 Sound Memo	Allows sounds to be added to images.	p. 84
	 Erase all	Erases all images on the CF card.	p. 92
	 Slide Show	Replays selected images in a slide show.	p. 86
	 Print Order	Sets the print settings.	p. 107
	 Transfer Order	Sets the transfer settings.	p. 116

	Menu Item	Available Settings	Reference Page
 Set up Menu (Yellow)	 Beep	On*/Off	p. 127
	 Speaker Vol.	Off/1/2*/3/4/5	p. 127
	 Power Save	On*/Off	p. 28
	 Date/Time	Sets the date and time	p. 25
	 Format	Formats (initializes) the CF card	p. 93
	 Language	English* / Deutsch / Français / Nederlands / Dansk / Suomi / Italiano / Norsk / Svenska / Español / Chinese / Japanese	p. 26
	 Video System	NTSC/PAL	p. 118
 My Camera Menu (Blue)	 Theme	 / 1* /  / 	p. 43
	 Start-up Image	 / 1* /  / 	p. 43
	 Start-up Sound	 / 1* /  / 	p. 43
	 Shutter Sound	 / 1* /  / 	p. 43
	 Operation Sound	 / 1* /  / 	p. 43
	 Selftimer Sound	 / 1* /  / 	p. 43

- * Default setting. Default video system setting varies between regions.
- Some menu items are not available in certain shooting modes.
- In the My Camera menu, you can connect to a computer and download files to customize the  and  items. See the *Software Starter Guide* for details.
- The default ISO speed varies with the shooting mode.
- With the exception of the [Date/Time], [Language] and [Video System] settings, all the other menu settings and changes made with the camera buttons can be reset to the default values in a single operation (p. 132)

Customizing the Camera (My Camera Settings)

The start-up image and sound, shutter sound, operation sound and selftimer sound are collectively called the My Camera Settings. You can select between three options for the start-up image and the various sounds.

Example: Start-up Image

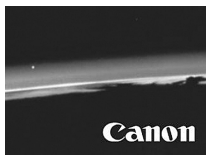
**1****2****3**

The camera comes with preset images for the **2** option (science fiction theme) and the **3** option (bird theme).

Changing My Camera Settings



- Use the or button to select the (My Camera) menu.
- Use the or button to select (Theme), , , , or .
- Use the or button to select between the , , and .



- The display will return to the Rec. or Play menu.



- If you select (Theme) in Step 1, you can select a consistent theme for each of the My Camera Settings.
- If the Beep option in the (Set up) menu is set to On, the beep sounds even if each sound item is individually set to [Off] in the My Camera menu (p. 129).

Customizing My Camera Settings

You can customize items **P2** and **P3** in the My Camera menu using your computer and the bundled software.





File Formats for the My Camera Settings

Start-up Image

- Recording Format: JPEG (Baseline JPEG)
- Sampling Rate: 4:2:0 or 4:2:2
- Image Size: 320 x 240 pixels
- File Size: 20 Kb or less

Sounds

- Recording Format: WAVE (monophonic)
- Standardizing Bit: 8 bit
- Sampling Frequency: 11.025 kHz or 8.000 kHz
- Running Time:

	11.025 kHz	8.000 kHz
 Start-up Sound	1.0 sec. or less	1.3 sec. or less
 Shutter Sound	0.3 sec. or less	0.4 sec. or less
 Operation Sound	0.3 sec. or less	0.4 sec. or less
 Selftimer Sound	2.0 sec. or less	2.0 sec. or less

- No file format other than those described above can be used with this camera.

An example of this function is to record “Say Cheese” as a selftimer sound so that the camera will replay this sound 2 seconds before the photo is taken. You can customize your camera by creating new My Camera Settings and adding them to it.







- See the *Software Starter Guide* and the *ZoomBrowser EX Software User Guide* or *ImageBrowser Software User Guide** (both in PDF format) on the supplied Solution Disk for more information on creating and adding to the My Camera Settings files.

* (May not be supplied with the camera in some regions.)

Shooting

Selecting a Shooting Mode

The camera features the following shooting modes.

	Auto	Most settings are automatically selected by the camera.
	Manual	The exposure compensation, white balance and other settings can be manually selected.
	Stitch Assist	Images are shot in overlapping series to create single panoramic images.
	Movie	Shoots movie clips.

- The settings selected in each shooting mode are saved when switching between shooting modes. Some settings are also saved when the power is turned off (p. 40).

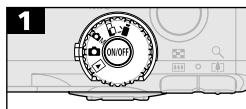

- Select a shooting mode.

In the descriptions of the shooting functions that follow, the icons beside the titles indicate the applicable shooting modes. Before you proceed with Step 1 in each case, set the mode dial to one of the shooting modes indicated by the icons in the title.

Reviewing an Image Right after Shooting

Right after a shot is taken, the image appears in the LCD monitor for 2 seconds even if you release the shutter button regardless of whether the LCD monitor is on or off. You can also review it with the following procedures.

- By keeping the shutter button pressed after a shot.
- By pressing the **SET** button while the image is displayed on the LCD monitor. Press the shutter button halfway to stop displaying it.



- You can do the following while the image is displayed.
 - Check the image brightness in the histogram (p. 32).
 - Erase the image (p. 91).

Changing the Review Duration



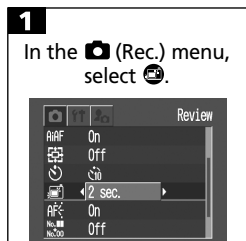



The default review time is 2 seconds. The review function can be set to Off or changed to 10 seconds.





- See *Selecting Menus and Settings* (p. 37).
- Use the or button to select [Off], [2 sec.] or [10 sec.]
- With the Off option, the image will not automatically display. However, if you keep the shutter button fully pressed after a shot, the image will display.
- With the 2 sec. or 10 sec. options, the image automatically displays for the set duration even if the shutter button is released.
- You can display the image longer than the 2- or 10-second duration by keeping the shutter button depressed or by pressing the **SET** button while the image is displayed.
- Another picture can be taken even while the last is displayed.
- The display will return to the Rec. menu.





Changing Resolution/Compression Settings

Still image resolution and compression settings and movie resolution settings can be adjusted to suit your requirements. Resolution settings get progressively higher ranging from the **S** (Small) and **M** (Medium) to the **L** (Large) settings. Use a high resolution setting to obtain the best quality for printing, but select a lower one to print on small labels, to send images by email or to fit more images on a CF card. Compression settings yield progressively higher image quality as one switches from the  (Normal) and  (Fine) settings to the  (Superfine) settings. Use the  (Superfine) setting to get higher quality images, or the  (Normal) setting to get more images on a CF card. The  (Fine) setting provides sufficient quality for most purposes.



Still Image Resolution	
L (Large)	1600 x 1200 pixels
M (Medium)	1024 x 768 pixels
S (Small)	640 x 480 pixels

Compression	
	Superfine
	Fine
	Normal

The Following resolutions are available for movies.

Movies Resolution	
	640 x 480 pixels
	320 x 240 pixels
	160 x 120 pixels

1

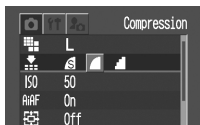
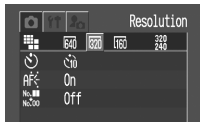
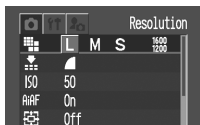

In the  (Rec.) menu, select  or .



2



- See *Selecting Menus and Settings* (p. 37).

- Use the  or  button to select an option.

-  Resolution (Still Images)
Select **L**, **M** or **S**.

-  Resolution (Movies)
Select **640**, **620** or **1160**.

-  Compression
Select **S**, **L** or **F**.

- The display will return to the Rec. menu.



- See *Functions Available in Each Shooting Mode* (p. 76).
- See *Approximate Image File Sizes* (p. 147).
- See *CF Cards and Estimated Capacities* (p. 147).

⚡ Using the Flash



	Auto	The flash fires automatically as required by the light level.
	Red-Eye Reduction Auto	The red-eye reduction lamp fires with each shot, automatically adjusting the intensity to suit lighting levels.
	On	A flash fires with every shot.
	Off	A flash will not fire.
	Slow-Synchro	The flash timing is adjusted to slow shutter speeds. This reduces the chance that the background will be dark when shots are taken at night or in rooms with artificial lighting. The red-eye reduction lamp fires with each shot. Use of a tripod is recommended.

	●	●	—
	●	●	—
	—	●	▲
	●	●	▲
	—	●	▲

- Setting available
- ▲ Can be selected for the first image only.

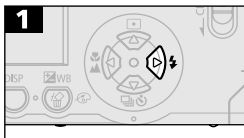

- Press the button to cycle through the flash settings.





- When you use flash photography at higher ISO speeds, the chances of white streaks appearing in the image increase the closer you approach to the subject.
- A slow shutter speed is selected in dark surroundings when the flash is set to Off or Slow-Synchro. Be careful to avoid camera blur under these conditions.

- Shooting in Mode

Be careful to hold the camera still to avoid camera blur.



- Shooting in M or Mode

Fix the camera to a tripod to shoot in these modes since the shutter speed will be slower than in the  mode. If an image is dark in  mode, reshooting it in M mode will make it brighter.











- The flash can be fired when the upper indicator shines a steady orange.
- The flash may take up to approximately 10 seconds to charge. The recharging time will vary with such factors as the shooting conditions and battery charge.
- The flash fires twice. The main flash follows a preparatory pre-flash. The exposure reading obtained from the subject with the pre-flash are used to set the optimal flash intensity for the main flash, which is used to capture the image.

Red-Eye Reduction

- Light reflecting back from eyes can make them appear red when the flash is used in dark areas. Under these conditions, use the red-eye reduction mode. For this mode to be effective, the subject must be looking right at the red-eye reduction lamp. Try asking them to look directly at the lamp. Even better results can be obtained by shooting with the lens set to a wide angle, increasing the lighting in indoor settings or approaching closer to the subject.
- The shutter will not activate for approximately 1 second after the red-eye reduction lamp fires in order to improve the effect. If you wish a more immediate shutter response, set the flash to ,  or .

Shooting Close-Ups/Infinity Shots

	Macro	Use this mode to record subjects in the range of 16 to 76 cm (6.3 in. to 2.5 ft.) from the lens tip when at maximum wide angle and in the range of 26 to 76 cm (10.2 in. to 2.5 ft.) when at the maximum telephoto setting.
	Infinity	Use this mode to record landscapes and distant objects. It can also be used for compositions combining both near and distant objects.

				
	●	●	▲	●
	—	●	▲	●

● Setting available.

▲ Selectable for first image only.



• Display  or .



- Use the LCD monitor to compose close-ups in macro mode since the parallax phenomenon may cause images composed with the optical viewfinder to be off-center.
- The exposure may not be optimal when the flash is used in macro mode in the range of 16 to 26 cm (6.3 to 10.2 in.).



Image Area in Macro Mode

	Distance from Lens to Subject	Image Area
Maximum Telephoto	26 cm (10.2 in.)	90 x 67 mm (3.5 x 2.6 in.)
Maximum Wide Angle	16 cm (6.3 in.)	163 x 121 mm (6.4 x 4.8 in.)

Using the Digital Zoom



When the LCD monitor is on, images can be zoomed to approximately 3.8, 4.7, 6.0 or 7.5 times with the combined optical and digital zoom functions.



- Turn the LCD monitor on.

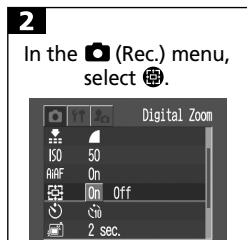

In the (Rec.) menu, select .

- See *Selecting Menus and Settings* (p. 37).
- Use the or button to select [On].



- The display will return to the Rec. menu.

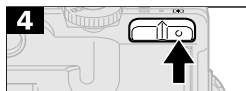

- Press the button until the lens reaches the maximum optical telephoto setting and stops. Press it again to activate the digital zoom and to advance through the settings.
- Press the button to zoom back out.

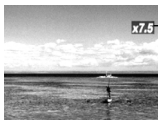

The combined optical and digital zoom factor displays.



- The digital zoom is unavailable in some modes (p. 77).



- Images become coarser the more they are digitally zoomed.

Shooting Continuously



In this mode, the camera shoots continuously at approximately 2.5 images per second* (Large/Fine, LCD monitor off) while the shutter button is held down. Recording ceases when the shutter button is released.

* This figure reflects standard shooting criteria established by Canon. Actual figures may vary according to the subject and shooting conditions.

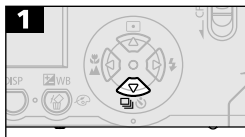

- Display .



- The interval between shots may lengthen slightly when the camera's built-in memory fills.
- If the flash is firing, the interval between shots will lengthen to accommodate the flash's charging requirements.

Using the Self-timer







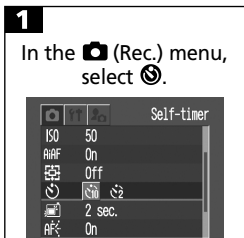

- Display .
- When the shutter button is pressed, the self-timer will activate and the self-timer lamp will flash.

Changing the Self-timer Countdown Time



- See *Selecting Menus and Settings* (p. 37).

In the  (Rec.) menu, select .

- Use the  or  button to select  (10 sec.) or .
- When  is selected, the self-timer sounds and the flashing gets faster 2 seconds before the shutter activates.
- When  is selected, the self-timer sounds at the same time as the shutter button is pressed. The shutter activates in 2 seconds.

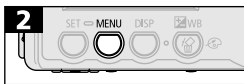

- The display will return to the Rec. menu.



- The selftimer sound can be changed with the  (My Camera) menu (p. 44).

Shooting in Stitch Assist Mode



Stitch Assist mode can be used to shoot images, which overlap, and which can later be merged to create one panoramic image on a computer.

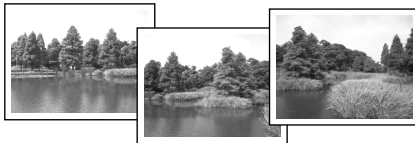

The overlapping seams of several adjacent images can be joined into a single panoramic image.



- To merge the images on the computer, use PhotoStitch, one of the supplied programs.

Framing a Subject

The PhotoStitch program detects the overlapping portions of adjoining images and merges them. When shooting, try to include a distinctive item (landmark) in the overlapping portions.





- Compose each frame so that it overlaps 30 - 50% of the adjoining image. Try to keep the vertical misalignment to less than 10% of the image height.
- Do not include moving items in the overlap.

- Do not try to stitch images that include both distant and close items. These items may appear warped or doubled up in the merged image.
- Make the brightness in each image consistent. The final image will appear unnatural if the contrast in brightness is too great.
- To shoot landscapes, swivel (pan) the camera around its own vertical axis.
- To shoot close-ups, slide the camera over the subject, keeping it parallel to the subject as you move it.

Shooting

Images can be shot in two sequences in Stitch Assist mode.

	Left to right horizontally
	Right to left horizontally

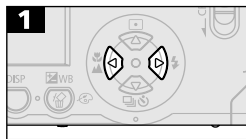

- Use the  or  button to select the sequence.

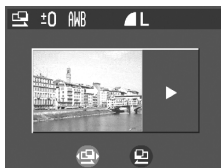

 Left to right horizontally

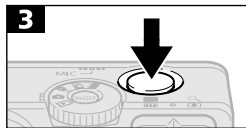

- Shoot the first frame in the sequence.
- The exposure and white balance are set and locked with the first image. Successive images use the same settings.

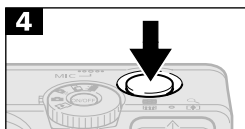

Second Image

- Compose the second image so that it overlaps a portion of the first and shoot.



- Use the ◀ or ▶ button to check or retake the recorded images.
- Minor discrepancies in the overlapping portions can be corrected when the images are stitched together.

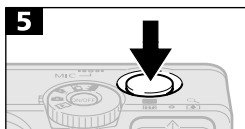

Third Image

- Repeat the procedure for additional images. A sequence may contain up to 26 images.







- Press the **SET** button to close Stitch Assist mode.



- See the *Functions Available in Each Shooting Mode* (p. 76) for the settings available in this mode.
- A custom white balance setting cannot be set in □ mode. To use a custom white balance setting, first set it in another shooting mode.
- The settings for the first image are used to take subsequent images in the sequence.
- It is not possible to display images on the TV monitor when shooting in Stitch Assist mode.

Shooting a Movie



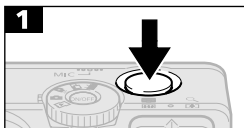

Use the movie mode to shoot movie clips. Select a resolution in the  (Rec.) menu from the  (640 x 480),  (320 x 240) (Default) and  (160 x 120) options (p. 47).

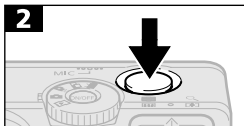

- Press the shutter button fully to start recording images and sounds.
- During shooting the recording time (in seconds) and a red dot appear on the LCD monitor.



- Press the shutter button again to stop recording.
- The maximum length of a movie clip (at approximately 20 frames/sec.) is approximately 4 seconds () , 10 seconds () or 30 seconds () according to standard Canon testing criteria. These times may vary with the subject and shooting conditions. Recording will automatically stop when the maximum is reached or when the CF card runs out of free capacity.



- Be careful not to touch the microphone while recording.
- The AE, AF, white balance and zoom settings remained fixed for subsequent frames at the values selected for the first frame.
- After a clip is shot, the upper indicator will flash green while the clip is being written to the CF card. You cannot shoot again until the flashing stops.
- See the *Functions Available in Each Shooting Mode* (p. 76) for the settings available in this mode.



- Sound is recorded monaurally.
 - The shutter sound will not sound when you fully press the shutter button to record a movie clip.
 - QuickTime 3.0 or a higher is required to replay movie files (AVI / Motion JPEG) on a computer. QuickTime 5.0 is included on the Canon Digital Camera Solution Disk.
-

Locking the Focus (AF Lock)



It may be difficult to focus on the following types of subject. Use the focus lock in these situations.

- Subjects with extremely low contrast to the surroundings
- Subjects with extremely bright objects at the center of the composition
- Subjects that are moving quickly
- Subjects through glass
 - Try to shoot as close to the glass as possible to reduce the chances of light reflecting back off the glass.

Shooting with the Focus Lock

Method 1



1. Aim the camera so that an object at the same focal distance as the main subject is centered in the AF frame in the viewfinder or LCD monitor.
2. Press the shutter button halfway and wait until two beeps sound.
3. Re-aim the camera to compose the shot as desired and press the shutter button all the way.

Method 2

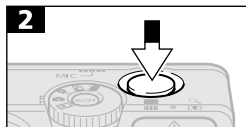

- Turn the LCD monitor on.
- Aim the camera so that an object at the same focal distance as the main subject is centered in the AF frame.





- Press and hold the shutter button halfway until two beeps sound. Without releasing your finger, press the  /  button.

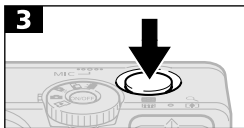

- The **AF-L** icon will display and the lower indicator will light yellow.



- Re-aim the camera to compose the shot as desired and press the shutter button all the way.
- Release the focus lock by pressing either the  / , **DISP**, **MENU** or zoom buttons.
- Turning the mode dial also releases the focus lock.



- Method 2 is convenient because you can let go of the shutter button to recompose the image. Moreover, the focus remains locked after the picture is taken, allowing you to capture a second image with the same focus.

Locking the Exposure Setting (AE Lock)



You can set the exposure and focus separately. This is effective when the contrast is too strong between the subject and background or when a subject is backlit.



- You must set the flash to . The AE lock cannot be set if the flash fires.



- 1
- Turn on the LCD monitor.
 - Focus the camera on the subject on which you wish to lock the exposure setting.

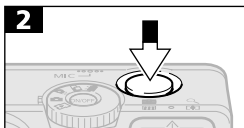

- Press the shutter button halfway and wait until two beeps sound.

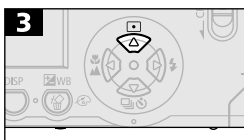

- Keep the shutter button pressed halfway and press the button.
- The **AEL** icon will display.

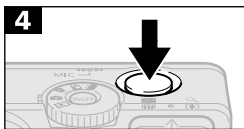

- Re-aim the camera to compose the shot.
- To release the AE lock, press the button.



- The AE lock may release if you press any button other than the button.

Locking the Flash Exposure Setting (FE Lock)



You can adjust and lock the flash output to suit a specific portion of the subject.



- Turn on the LCD monitor.
- Set the flash to and focus on the part of the subject on which you wish to lock the flash exposure setting.

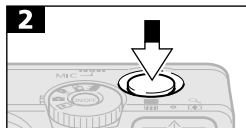

- Press the shutter button halfway and wait until two beeps sound.

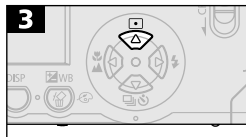

- Keep the shutter button pressed halfway and press the button.
- The **FEL** icon will display.
- The flash will fire a pre-flash and lock the flash exposure to the required intensity to illuminate the subject.

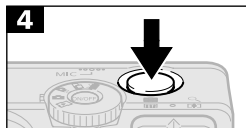

- Re-aim the camera to compose the shot and press the shutter button all the way.
- To release the FE lock, press the button.



- The FE lock may release if you press any button other than the button.

Switching between Autofocus Modes



Although the autofocus function is preset to the AiAF setting, you can switch modes to one that uses a fixed AF frame at the center of the field. The AF frames will appear in the LCD monitor if it is turned on (p. 31).

<input type="checkbox"/> <input type="checkbox"/> <input type="checkbox"/>	On	The camera focuses using the AF frame that it selects to suit the shooting conditions.
<input type="checkbox"/>	Off	The camera focuses using the center AF frame. This is convenient for focusing on a specific part of a subject with greater certainty.

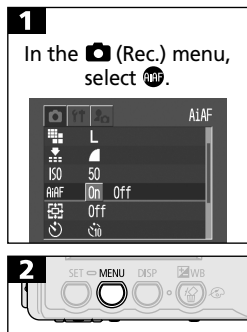

- The symbol represents the AF frames as they appear in the LCD monitor.



- See *Selecting Menus and Settings* (p. 37).
- Use the or button to select [On] or [Off].
- A shot can be taken immediately after.
- The display will return to the Rec. menu.

● Switching between Light Metering Modes

You can switch between metering modes to shoot.

 Evaluative Light Metering	<p>Appropriate for standard shooting conditions, including backlit scenes. The camera divides images into several zones for light metering. It evaluates the complex lighting conditions, such as the position of the subject, the brightness, the direct light, and the backlighting, and adjusts the settings to the correct exposure for the main subject.</p>
 Spot AE Point	<p>Meters the area within the spot AE point at the center of the LCD monitor. Use this mode when the subject is backlit or surrounded by strong light.</p>

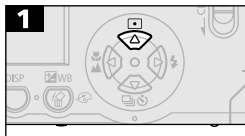



- Display  or .

Adjusting the Exposure Compensation

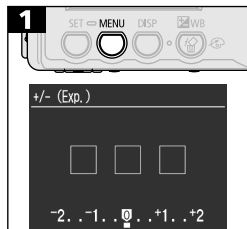
Adjust the exposure compensation setting to avoid making the subject too dark when it is backlit or shot against a bright background or to avoid making lights appear too bright in night shots.



- Use the  or  button to adjust the exposure compensation.
- The settings can be adjusted in 1/3 steps in the range of -2EV to +2EV.
- You can confirm the effect of the exposure compensation setting in the LCD monitor image when the LCD monitor is on.
- A shot can be taken immediately after. The menu will reappear after the shot, allowing you to further adjust the setting.



- Reset the exposure compensation by returning the setting to 0.

Shooting in Long Shutter Mode



You can set the shutter speed to a slow setting to make dark subjects appear brighter.



- See *Selecting Menus and Settings* (p. 37).

- Use the or button to select [On].



- The display will return to the Rec. menu.



Long Shutter Menu

- Use the or button to select the long shutter menu and the or button to select a shutter speed.

- A shot can be taken immediately after. The menu will reappear after the shot, allowing you to further adjust the setting.

- While the menu is displayed, press the button to release the long shutter mode and finish the procedure.





- The nature of CCD image sensors is such that noise in the recorded image increases at long shutter speeds. This camera, however, applies special processing to images shot at shutter speeds slower than 1.3 seconds to eliminate the noise, thereby producing high-quality images. Nevertheless, a certain amount of processing time may be required before the next image can be shot.



- Use the LCD monitor to confirm that the image was recorded at the desired brightness.
- Use of the flash may result in an over-exposed image. If that occurs, shoot with the flash set to
- The following are unavailable:
 - Exposure Compensation
 - Light Metering
 - AE Lock
 - ISO speed [AUTO]
- **Available Shutter Speeds**
The following shutter speeds (in seconds) are available.
1, 1.3, 1.6, 2, 2.5, 3.2, 4, 5, 6, 8, 10, 13, 15

WB Setting the White Balance



Setting the white balance to match the dominant light source when shooting will adjust the image coloring to the correct settings for that type of light. Set the white balance mode to a natural or artificial light setting according to the circumstances.

	Auto	The camera sets the white balance automatically according to shooting conditions.
	Daylight	For recording outdoors on a bright day.
	Cloudy	For recording under overcast, shady or twilight skies.
	Tungsten	For recording under tungsten and bulb-type 3-wavelength fluorescent lighting.
	Fluorescent	For recording under warm-white, cool-white or warm-white (3-wavelength) fluorescent lighting.
	Fluorescent H	For recording under daylight fluorescent, or daylight fluorescent-type 3-wavelength fluorescent lighting.
	Custom	For setting a custom value with a white sheet of paper, etc., to obtain the optimal white balance for the conditions.

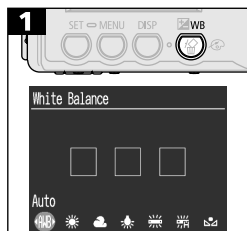

- Press the **WB** button repeatedly until the White Balance Settings menu displays.
- Use the or button to select a setting. (See the next page for)
- You can confirm the effect of the setting in the LCD monitor image when the LCD monitor is on.
- A shot can be taken immediately after. The menu will reappear after the shot, allowing you to further adjust the setting.





- This setting cannot be adjusted when the (Sepia) or (B/W) photo effects are selected.

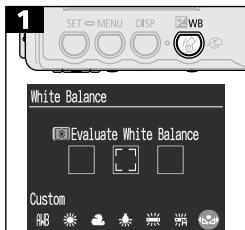

Setting a Custom White Balance

You can set a custom white balance to obtain the optimal setting for the shooting conditions by having the camera evaluate an object, such as a piece of white paper or cloth, or a photo-quality gray card that you wish to establish as the standard white color.



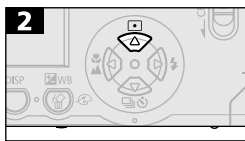

- Press the **WB** button repeatedly until the White Balance Settings menu displays.
- Use the  or  button to select .



- Aim the camera at the white paper or cloth, or gray card and press the  button.
- Aim the camera so that the white paper or cloth, or gray card completely fills the frame on the LCD monitor or the entire viewfinder before pressing the  button. The camera reads the white balance data when you press the  button.
- A shot can be taken immediately after. The menu will reappear after the shot, allowing you to further adjust the setting.











- You are recommended to set the shooting mode to M and the exposure compensation setting to zero (± 0) before setting a custom white balance. The correct white balance may not be obtained when the exposure setting is incorrect (image appears completely black or white).
- It is also advisable to use the LCD monitor to compose the shot and to zoom in to the maximum telephoto setting.
- Since the white balance data cannot be read in mode, preset the white balance in another shooting mode first before selecting the mode.
- If the flash fires when setting a custom white balance with the flash set to or , make sure that you also use the flash when you go to shoot. The correct white balance cannot be obtained unless the flash is used consistently. To ensure consistency, set the flash to  or  as appropriate.



Changing the Photo Effect

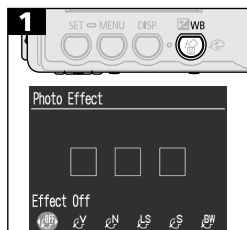

You can shoot with different photo effects.

	Photo Effect Off	Records with no effect.
	Vivid	Emphasizes the contrast and color saturation to record in bold color.
	Neutral	Tones down the contrast and color saturation to record neutral hues.
	Low Sharpening	Records subjects with softened outlines.
	Sepia	Records in sepia tones.
	B/W	Records in black and white.



- Press the  button repeatedly until the Photo Effect Setup menu displays.
- Use the  or  button to select [Photo Effect].
- You can confirm the effect of the setting in the LCD monitor image when the LCD monitor is on.
- A shot can be taken immediately after. The menu will reappear after the shot, allowing you to further adjust the setting.



Adjusting the ISO Speed



Adjust the ISO speed when you wish to shoot in a dark area or use a fast shutter speed.

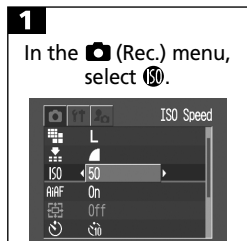

- See *Selecting Menus and Settings* (p. 37).



- Use the or button to select a setting.
- The display will return to the Rec. menu.



- When [AUTO] is selected, the camera automatically adjusts the ISO speed to a range of 50 to 150.
- Higher ISO speeds increase image noise. To take clean images, use as low an ISO speed as possible.

Setting the Auto Rotate Function



The camera is equipped with an Intelligent Orientation sensor that detects the orientation of an image shot with the camera on end and automatically rotates it to the correct viewing orientation in the display. You can set this function on/off.

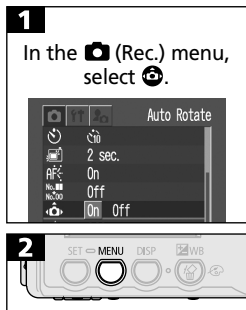

- See *Selecting Menus and Settings* (p. 37).
- Use the or button to select [On] or [Off].
- The display will return to the Rec. menu.
- When the Auto Rotate function is set to On and the LCD monitor is set to the detailed display mode, the icon (normal), icon (right end is down) or icon (left end is down) will appear in the upper right of the display.



- When the camera is held on end to shoot, the Intelligent Orientation sensor judges the upper end to be “up” and the lower end to be “down.” It then only uses the upper two of the three AF frames (when the AiAF function is On) to raise the accuracy of the focus, exposure and white balance metering. The bottom AF frame disappears. This function operates regardless of the On / Off status of the Auto Rotate function.



- This function may not operate correctly when the camera is pointed straight up or down. Check that the arrow is pointing in the right direction and if it is not, then set the Auto Rotate function to Off.
- Even if the Auto Rotate function is set to on, the orientation of images downloaded to a computer will depend upon the software used to download the images.

Resetting the File Number



You can select the way file numbers are assigned.

On	The file number is reset to the start (100-0001) each time a new CF card is inserted. New images recorded on CF cards with existing files are assigned the next available number.
Off	The file number of the last images to be shot is memorized so that images recorded to a new CF card start from the next number.

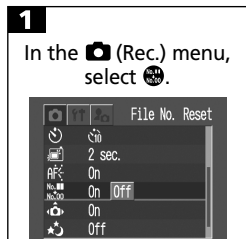

- See *Selecting Menus and Settings* (p. 37).

- Use the or button to select [On] or [Off].



- The display will return to the Rec. menu.





























- Setting the [File No. Reset] to [Off] is useful for avoiding file name duplication when images are downloaded to a Computer





• About File Numbers

Images are assigned file numbers from 0001 to 9900 and organized in folders generally containing up to 100 images. Folders are assigned numbers from 100 to 998 (a folder with 99 in the last two digits cannot be created). Since images shot in the or mode are always saved in the same folder, some folders may contain 101 or more images.

Functions Available in Each Shooting Mode

The chart below is a reference for the settings available for various shooting conditions. The settings selected in each shooting mode are saved after you finish shooting, and when you switch between shooting modes.

Function		 Auto	 Manual	 Stitch Assist	 Movie	Reference Page
Resolution	Large 	●*	●*	▲*	—	p. 47
	Medium 	●	●	▲	—	p. 47
	Small 	●	●	▲	—	p. 47
	Movie 	—	—	—	●	p. 47
	Movie 	—	—	—	●*	p. 47
	Movie 	—	—	—	●	p. 47
Compression	Superfine 	●	●	▲	—	p. 47
	Fine 	●*	●*	▲*	—	p. 47
	Normal 	●	●	▲	—	p. 47
Flash	Auto 	●	●	—	—	p. 49
	Red-Eye Reduction Auto 	●*	●*	—	—	p. 49
	On 	—	●	▲	—	p. 49
	Off 	●	●	▲*	●	p. 49
	Slow-Synchro 	—	●	▲	—	p. 49
Macro Mode 	●	●	▲	●	p. 51	
Infinity Mode 	—	●	▲	●	p. 51	
Focus Lock 	—	●	—	—	p. 60	
AE Lock 	—	●	—	—	p. 62	
FE Lock 	—	●	—	—	p. 63	
Shooting Method	Single 	●*	●*	▲*	●*	—
	Continuous 	—	●	—	—	p. 53
	Selftimer 	●	●	▲	●	p. 54
Autofocus Frame	—	●	—	—	p. 64	

Function	 Auto	 Manual	 Stitch Assist	 Movie	Reference Page
AF-assist Beam	●	●	▲	●	p. 35
Light Metering	—	●	—	—	p. 65
Digital Zoom	●	●	—	—	p. 52
Exposure Compensation	—	●	▲	●	p. 66
Long Shutter	—	● ⁽²⁾	—	—	p. 67
White Balance	—	●	▲	●	p. 69
Photo Effect	—	●	▲	●	p. 72
ISO Speed	— ⁽¹⁾	●	— ⁽¹⁾	— ⁽¹⁾	p. 73
Auto Rotate	●	●	▲	—	p. 74

* Default setting.

● Setting available.

▲ Setting can only be selected for the first image.

■ (Shaded Area): Setting is memorized even when the camera power is shut off.

- With the exception of the [Date/Time], [Language] and [Video System] settings, all the other menu settings and changes made with the camera buttons can be reset to the default values in a single operation. (p. 132)

(1) The ISO speed is automatically set between the equivalent of 50 and 150.

(2) The ISO speed cannot be set to [AUTO].

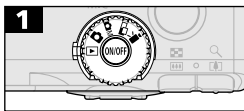

Replaying

Viewing Images Individually (Single Image View)

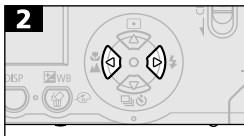

- Turn the mode dial to the  position.
- The last recorded image will appear in the display (single image replay).



- Use the  button to move to the previous image and the  button to move to the next. Holding the button down advances the images more rapidly, but the images will not appear as clearly.

Q Magnifying Images

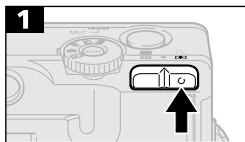

- Images can be magnified up to approximately 10 times.



Approximate Location
of the Magnified Area



- Use the / / / buttons to move around the image.
- Hold the **SET** button down and press the **Q** button to cycle through each setting, from approximately 2.5 times, to approximately 5 and 10 times.
- Press the button to reset the magnify settings.



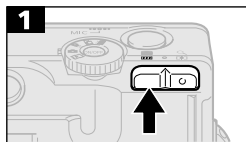

- Movie frames and index replayed image cannot be magnified.

Viewing Images in Sets of Nine (Index View)

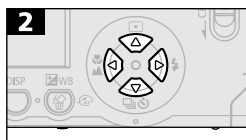

- Up to nine images can be viewed at once in index replay.







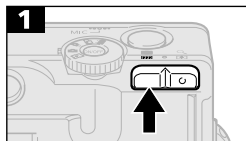

- Use the  /  /  /  buttons to change the image selection.
- Press the  button to display the selected image in single image replay.

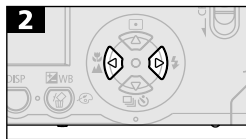
Switching between Sets of Nine Images



- Successive sets of nine images can be shown in the display.



- Use the  button to move to the previous set and the  button to move to the next.
- Hold the **SET** button down and press the  or  button to jump to the first or last set.
- Press the  button to return to standard index replay.

Viewing Movies



Movie clips can be replayed with the following procedures.



- Movies cannot be played in the index replay mode.

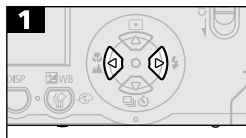

- Use the or button to select a movie.
- Images with an **SET** icon are movies.



- The movie panel will display.
- Use the or button to select (Play).



- The movie images and sound will play.
- Use the or button to adjust the volume.
- When a movie is finished, it stops and displays its last frame.



Pausing and Resuming Play









- Press the **SET** button to pause the movie. Press it again to resume.

Fast Forwarding/Rewinding



- Use the  or  button to select one of the following.

-  Play
-  Previous Frame/Rewind
-  Next Frame/Fast Forward
-  First Frame
-  Last Frame
-  Return to Single Image View



- Please adjust the sound volume on the TV set when viewing movie files on a TV (p. 118).



- You may experience frame dropping and audio breakup when replaying a movie on a computer with insufficient system resources.
- Movies shot with other cameras may not replay on this camera. See the *List of Messages* (p. 133).

Rotating Images in the Display



Images can be rotated clockwise 90° or 270° in the display.



0°(Original)



90°



270°

1

In the (Play) menu, select .

- See *Selecting Menus and Settings* (p. 37).

2



3



- Cycle through the 90°/270°/0° orientations with each press of the **SET** button.

4



- Press the **MENU** button repeatedly until the replay screen reappears to finish the procedure.



- Movies cannot be rotated.
- When images are downloaded to a computer, the orientation of images rotated by the camera will depend upon the software used to download the images.



- Images taken vertically with the Auto Image Rotate (p. 74) is set to [On] will automatically be rotated to the vertical position when viewed on the camera's LCD monitor.

Attaching Sound Memos to Images



In replay mode (including single image replay, index replay, magnified replay and review of an image immediately after shooting), you can attach a sound memo of up to 60 seconds to an image. The data is saved in a WAVE format file.



- See *Selecting Menus and Settings* (p. 37).

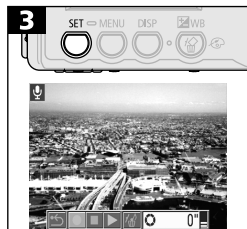

- The Sound Memo panel will display.
- Use the or button to select .



- The recording will start and the LCD monitor will show the elapsed and the remaining times. Speak toward the camera's microphone.
- Press the **SET** button to stop recording. Press the **SET** button again to continue recording.
- Additional memos can be added until the total time adds up to 60 seconds for any one image.

Playing/Deleting Sound Memos

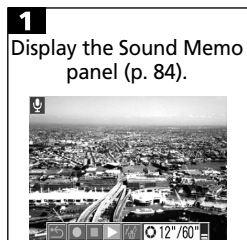

- To play a sound memo, use the or button to select .
- Select to erase a sound memo.
- Images with sound memos display the icon.
- The sound memo will play or be erased.
- Press the **SET** button to stop a sound memo when it is playing. Press the **SET** button again to continue the playback.
- Use the or button to adjust the volume.



- You cannot attach sound memos to movies.
- If there is no space for recording on the CF card, the message "CF card full" will appear and you will not be able to continue recording.
- You cannot record or playback sound notes for images that already have an incompatible sound file attached. If you attempt to record to or play an image with the icon, the "Incompatible WAVE format" message will display.



- The playback volume of sound memos can also be adjusted in the (Set up) menu (p. 127).

Automating Playback (Slide Shows)



Starting a Slide Show

A selection of images or all the images on a CF card can be displayed one-by-one in an automated slide show.

Slide show image settings are based on DPOF standards (p. 94).

All Images	Plays all images on the CF card in order.
Slide Show 1-3	Plays the images selected for each slide show in order.

1

In the (Play) menu, select .

- See *Selecting Menus and Settings* (p. 37).

2

- The Slide Show menu will display.

- Use the or button to select [Program] and the or button to select [All Images], [Show 1], [Show 2] or [Show 3].
- Use the or button to select [Start].

3

- The slide show will start and automatically stop at the end of the show.

4

- Press the **MENU** button repeatedly until the replay screen reappears to finish the procedure.



- Movies play for their entire recorded length regardless of the time set in the slide show settings.
- The power save function does not activate during a slide show (p. 28).



Pausing / Resuming a Slide Show

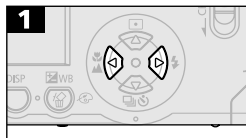

- Press the **SET** button to pause the slide show. Press the **SET** button again to restart it.

Fast Forwarding / Rewinding a Slide Show



- Use the  or  button to display the previous or next image. Hold down the button to advance through the images more rapidly.

Stopping a Slide Show







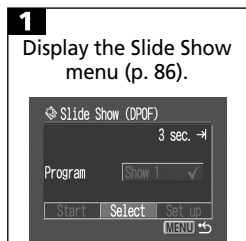

- Press the **MENU** button to stop the slide show and redisplay the Slide Show menu.

Selecting Images for Slide Shows

You can mark images for inclusion in slide shows 1-3. Up to 998 images may be marked per slide show. Images display in the order of their selection.



- Use the  or  button to select [Program] and the  or  button to select [Show 1], [Show 2] or [Show 3].
- Use the  button and the  or  button to choose [Select].



- A checkmark will appear beside a show already containing images.
- Use the or button to move between images and the or button to select or deselect them. Selected images display a number corresponding to their selection order.



- You can press the button to switch to the index mode (3 images) and use the same procedures to select images.



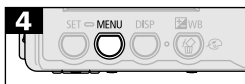

- In index mode, you can deselect all images by pressing the **SET** button, using the or button to select [Clear all], and pressing the **SET** button again.
- Press the **MENU** button repeatedly until the replay screen reappears to finish the procedure.



Adjusting the Play Time and Repeat Settings

You can change the play time for all the images in a show and have the show repeat continuously.

	Play Time	Sets the duration that each image displays. Choose between 3-10 seconds, 15 seconds, 30 seconds and Manual.
	Repeat	Sets whether the slide show stops when all the slides have been displayed or continues until stopped.

1



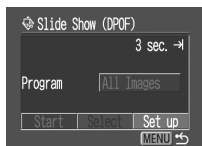



Display the Slide Show menu (p. 86).



- Use the  or  button to select [Set up].

2



- Use the  or  button to select  or  and the  or  button to select an option.

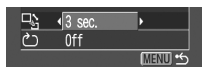

Select a play time.



Select [On] or [Off].

3



- Press the **MENU** button repeatedly until the replay screen reappears to finish the procedure.



- The display interval may vary slightly from the set time for some images when played.
- Slide shows are easy to arrange on a computer with the supplied software. See the *Software Starter Guide*.

Protecting Images



You can protect important images from accidental erasure.

1

In the (Play) menu, select .

- See *Selecting Menus and Settings* (p. 37).

2



3



- Use the or button to select an image to protect.
- Press the **SET** button to protect the image. Press the **SET** button again to remove the protection.
- You can make the selection of images easier by toggling between single image replay and index replay with either the or button.



Protection Icon

4



- Press the **MENU** button repeatedly until the replay screen reappears to finish the procedure.



- Please note that formatting (initializing) a CF card erases all data, including protected images.

Erasing

Erasing Single Images



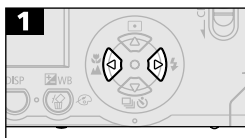

- Please note that erased images cannot be recovered. Exercise adequate caution before erasing a file.
- Protected images cannot be erased with this function.



- Use the  or  button to select an image for deletion.



- Use the  or  button to select [Erase].
- To exit instead of erasing, select [Cancel].



Erasing All Images



- Please note that erased images cannot be recovered. Exercise adequate caution before erasing a file.
- Protected images cannot be erased with this function.

1

In the (Play) menu, select .

- See *Selecting Menus and Settings* (p. 37).

2

- Use the or button to select [OK].
- To exit instead of erasing, select [Cancel].

3

Formatting CF Cards



New CF cards must be formatted with the following procedures before use.



- Please note that formatting (initializing) a CF card erases all data, including protected images and other file types.



1

In the  (Play) menu, select .

- See *Selecting Menus and Settings* (p. 37).

2



- Use the  or  button to select [OK].
- To exit instead of formatting, select [Cancel].

3



- When the camera is malfunctioning, a corrupted CF card might be the cause. Reformatting the CF card may solve the problem.
- When a non-Canon brand CF card is malfunctioning, reformatting it may solve the problem.
- CF cards formatted in other cameras, computers, or peripheral devices may not operate correctly in this camera. When that happens, reformat the CF card with this camera. If formatting in the camera doesn't work properly, turn the camera off and re-insert the CF card. Then turn the camera back on and format again.

Printing

About Printing

This camera supports direct printing. By connecting the camera to an optional printer or Bubble Jet printer (sold separately) that supports the camera's direct print function, you can send the images from the CF card directly to the printer using the camera buttons. In addition, you can have prints made to specification by a photo developing service by sending your CF card with the DPOF (Digital Print Order Format) print settings set in advance on your camera.

Please refer to the *System Map* supplied with your camera for direct print function compatible printer information.



Digital Camera

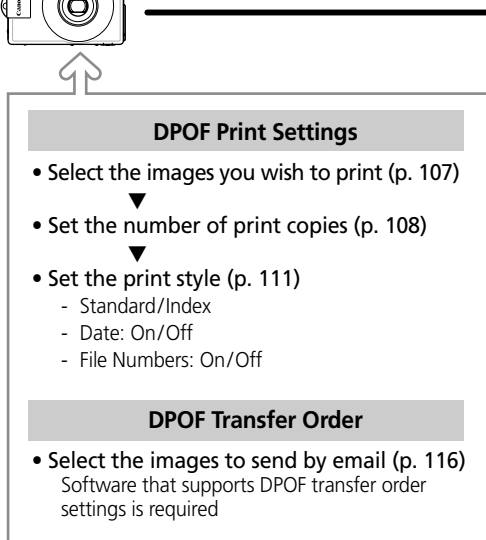

CF Card



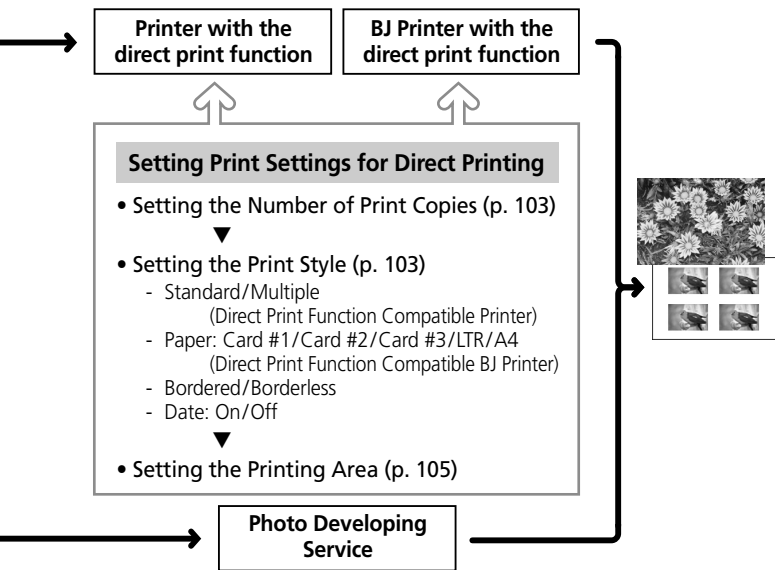

Print Menu Settings

Use the Print menu to set print related settings. The following diagrams illustrate how to use the Print menu.

Direct Print Function

Set the Mode Dial to 

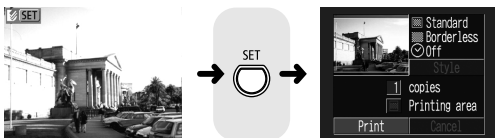

DPOF Print Settings

Set the Mode Dial to 

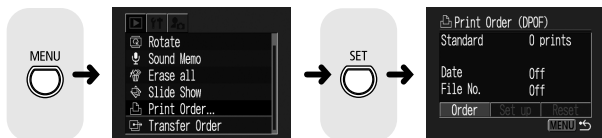



Turn the menu On/Off



Selects items and settings



Sets items and setting.

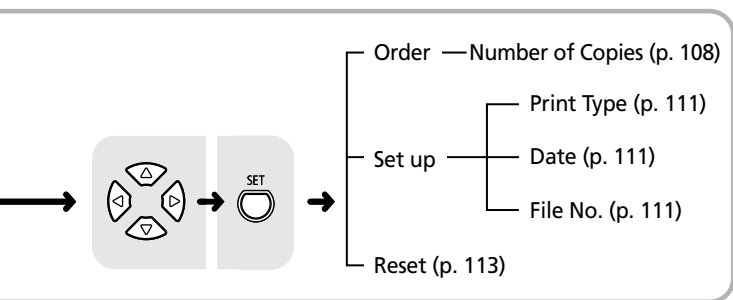
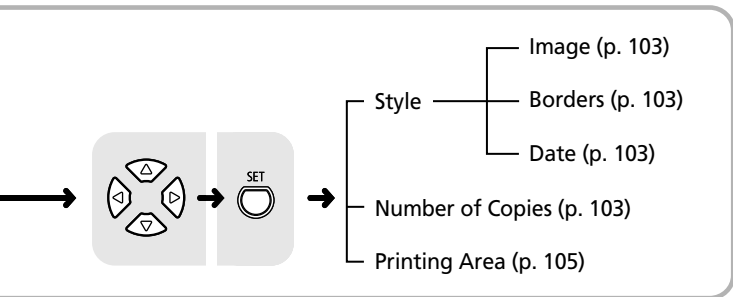

Connecting a Printer

You can make clear prints swiftly and easily when you connect the camera to a direct print function compatible printer. You can also print using DPOF print settings.



- You are recommended to use a household power source rather than the battery pack to power the camera when it is connected to a printer. If you do use a battery pack, ensure that it is fully charged and monitor the battery charge while printing.



- Please see the *System Map* supplied with your camera for the list of direct print function compatible printers.
- Please see your printer's user guide for information about installing paper and ink cassettes/tanks.

Connecting to a Direct Print Function Compatible Printer

Your printer should come equipped with two direct interface cables. To connect to this camera, please use the cable (DIF-100) that has the  symbol on its connector.

1

Shut the camera's power off (p. 27).

2

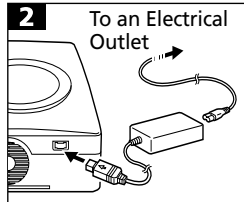

- Attach the power cable to the printer and insert its plug into an electrical outlet.
- You can also power the printer with a rechargeable battery if it is so equipped. Please see your printer's user guide.

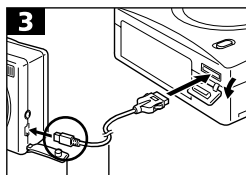



Direct Interface Cable

The  symbol appears on the connector.

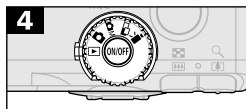
- Attach the direct interface cable to the printer.
- Open the terminal cover on the camera and insert the cable's connector into the camera's DIGITAL terminal. Orient the cable so that the connector's  symbol faces the camera's rear panel.



This shows when a direct print compatible printer is connected.

- Turn the mode dial to the  position and power up the camera.
-  will display when the printer is correctly connected.



Connecting to a Bubble Jet Printer



- Please read the user guide supplied with your BJ printer to see if it is compatible with the camera's direct print function, and for instructions on connection cables and general operations.

1

Shut the camera's power off (p. 27).

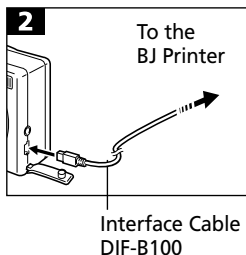

- Attach the interface cable to the BJ printer.
- Open the terminal cover on the camera and insert the cable's connector into the camera's DIGITAL terminal. Orient the cable so that the word Canon on the connector faces the camera's front panel.

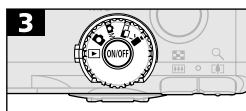

- Turn on the camera's power and set the mode dial to the position.
- will display when the printer is correctly connected.

This shows when
a BJ printer is
connected.



- Ensure that you grip the sides of the connector to remove the cable from the camera's DIGITAL terminal.



- The following cannot be conducted while the printer is connected.
 - Playing movies
 - Setting the language with the **SET** and the **MENU** button combination.
- When the printer is disconnected, the or symbol will disappear from the LCD monitor and the camera will revert to the standard replay mode.

Printing

- The following illustrations show examples from a direct print function compatible printer. Options for the Style category will differ slightly for BJ printers.

Print images displayed in single image view or index view mode.

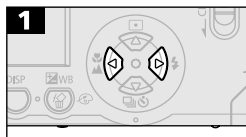

- Use the or button to select the images you wish to print.



- Specify the print copies, print style and print area as required.
 - Setting the Number of Print Copies (p. 103)
 - Setting the Print Style (p. 103)
 - Setting the Printing area (p. 105)
- Use the , , , and buttons to select [Print].
- To quit the procedure instead, select [Cancel].



- Press the **SET** button to start printing.
- The replay screen will reappear when printing is successfully concluded.



- Movies cannot be printed.



- **Canceling Printing**

Press the **SET** button to stop printing. A confirmation message will display. Use the \odot or \odot button to select [OK] and press the **SET** button.

- **Direct Print Function Compatible Printers**

A print in progress cannot be stopped. The printer will stop after the current print is complete and the camera will display its replay screen at that point.

- **BJ Printers**

The printer will stop printing the current image and eject the paper.

- **Printing Errors**

An error message will display if an error occurs while printing (pp. 135, 136). Use the \odot or \odot button to select [Stop] or [Resume] and press the **SET** button. (With a BJ printer, the print will automatically restart if the error is resolved.)

- **Direct Print Function Compatible Printers**

The Resume option may not appear with some types of error. In that case, select Stop.

- **BJ Printers**

The type of error will determine whether the Continue or Stop options appear. An error number will appear on the BJ printer's operation panel. See the printer's user guide for the recommended course of action for each error type.

Setting the Print Settings (Direct Print Function)

Setting the Number of Copies

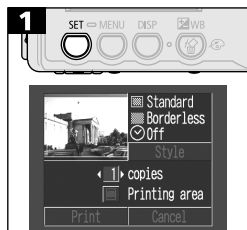

- Use the or button to select [Copies] and the or button to select the number. Up to 99 copies may be specified.

Setting the Print Style

You can select from among the following print styles.

Direct Print Function Compatible Printer

Image	Standard	Prints one image per page.
	Multiple*	Prints eight copies of the same image on one page.
Borders	Borderless	Prints right to the edges of the paper.
	Bordered	Prints with a border.
Date		Prints the image's creation date.

* This option is only available for printing on card-size paper.

BJ Printer

Paper		Select a paper size from the following: Card #1, Card #2, Card #3, LTR and A4. See the printer's user guide for its media specifications.
Borders	Borderless	Prints right to the edges of the paper.
	Bordered	Prints with a border.
Date		Prints the image's creation date.

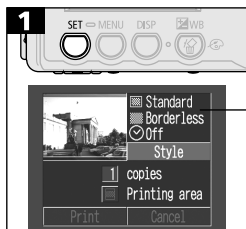

Current print style selection

- Use the or button to select [Style].



- Use the or button to select , , , or and the or button to select an option.

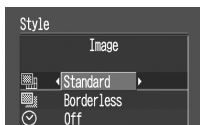

(Image Settings)

(Direct Print Function Compatible Printer)
Select [Standard] or [Multiple].

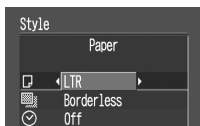

(Paper)

(BJ Printer)
Select [Card #1], [Card #2], [Card #3], [LTR] or [A4].



(Borders)

Select [Borderless] or [Bordered].



(Date)

Select [On] or [Off].



- Press the **MENU** button to finish the procedure.
- Practically all of the image area is printed on Bordered prints.
- With borderless or multiple prints, the center portion of the image (as shown in the LCD monitor) is slightly enlarged to fill the space. Consequently, the top, bottom and sides of the image may be cropped slightly.



- The date settings are overridden by the DPOF print settings if you are using them to print (p. 111).
- If you are using a direct print function compatible printer, the date and borders settings cannot be selected when the Multiple option is selected. (Images are printed without a date or border.)

Setting the Printing Area

You can select between the following three options to set the printing area for an image.

	Top	Prints the upper portion of the image.
	Center	Prints the center portion of the image.
	Bottom	Prints the lower portion of the image.



- Set the print style (image, borders, date, etc.) before setting the printing area (p. 103).
- The printing area can be set when the [Borderless] and [Multiple] options have been selected.
- The printing area may shift right or left if the paper size is set to L or the image setting in the print style is set to Multiple.



- Use the or button to select [Printing area] and the or button to select , or .



- The printing area setting only applies to one image.
- The printing area setting is canceled with the following operations:
 - When the image is printed,
 - When a print area is set for another image,
 - When the print mode is closed (camera power shut off, mode dial is turned, cancel is selected without printing after the printing area is set, or the direct interface cable is detached).

Setting the DPOF Print Settings

You can select images on a CF card for printing and specify the number of print copies in advance using the camera. This is extremely convenient for sending the images to a photo developing service or for printing on a direct print function compatible printer or a direct print function compatible BJ printer.



Selecting Images for Printing

There are two ways to select images.

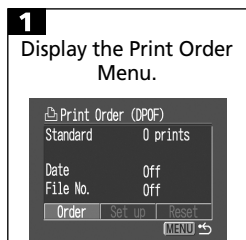
- Singly
- All images on a CF card (the number of print copies is set to one per image)





- See *Print Menu Settings* (p. 96).

- Use the  or  button to select [Print Order].



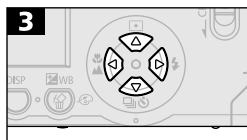



Single Images



- As shown below, selection methods differ according to the options chosen for the  (Print Type) settings (p. 111).





(Standard) / (Both)

- Use the  or  button to select an image and the  or  button to select the number of print copies (up to maximum of 99).

Number of Print Copies



(Index)

- Use the  or  button to move to an image and the  or  button to select or deselect it. A checkmark displays on selected images.

Selected for
an Index Print



- You can use the same procedures to select images in index view (3 images). Press the  button to switch between single image view and index view.

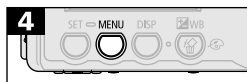

- Press the **MENU** button repeatedly until the replay screen reappears to complete the procedure.

All the Images on a CF Card

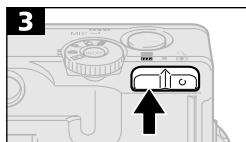

- Switch to index view (3 images).



- Use the or button to select [Mark all].
- Selecting [Mark all] selects all of the card's images.



- Press the **SET** button to set the number of print copies to 1 for each image.
- When the print type is set to Standard or Both, the number of print copies can be set individually for each image. When Index is selected, the print settings can be deleted (p. 108).

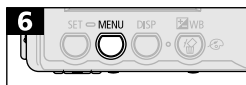

- Press the **MENU** button repeatedly until the replay screen reappears to complete the procedure.









- The symbol will display on images that have had print settings set by other DPOF-compliant cameras. These settings will be overwritten by those set by your camera.
- The output of some printers or photo developing services may not reflect the specified print settings.
- Print settings cannot be set for movie images.



- Images are printed in order from oldest to newest by the shooting date.
 - A maximum of 998 images can be selected per CF card.
 - When [Both] is selected, the number of print copies can be set, but it applies to Standard prints only. The Index setting only produces one print copy.
 - Print settings can also be assigned to images with the bundled software programs on a computer.
-

Setting the Print Style



The following print settings can be selected.

 Print Type	 Standard	Prints one image per page.
	 Index	Prints the selected images together at a reduced size in an index format.
	 Both	Prints the images in both the standard and index formats.
 Date	Adds the date to the print.	
 File No.	Adds the file number to the print.	

1

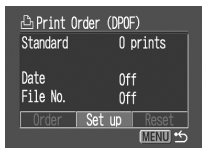
Display the Print Order Menu.



- See *Print Menu Settings* (p. 96).
- Use the  or  button to select [Set up].

2

- Use the or button to select , or , and the or button to select an option.

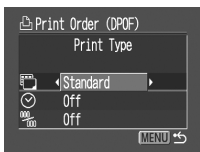

(Print Type)

- Select [Standard], [Index] or [Both].

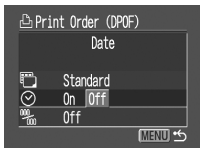

(Date)

- Select [On] or [Off].

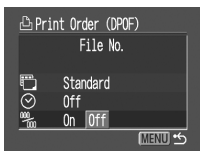

(File No.)

- Select [On] or [Off].



- Press the **MENU** button repeatedly until the replay screen reappears to complete the procedure.



- When the print type is set to Index, only one or the other of the [Date] and [File No.] options can be set to [On] at the same time.



- The date prints as the date and time in the format specified in the Set Date/Time menu (p. 25).



Resetting the Print Settings

The print settings can all be removed at once. The print type resets to Standard and the Date and File No. options to Off.

1

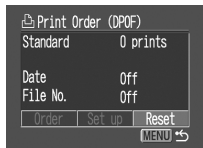
Display the Print Order Menu.



- See "Print Menu Settings" (p. 96).
- Use the  or  button to select [Reset].

2

- Use the  or  button to select [OK].
- To exit without resetting, select [Cancel].

3

Printing with DPOF Print Settings

The DPOF print settings can be used to print on a direct print function compatible printer or a direct print function compatible BJ printer.

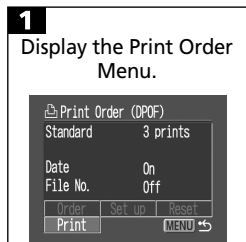

- See *Print Menu Settings* (p. 96).
- Use the / / / button to select [Print].

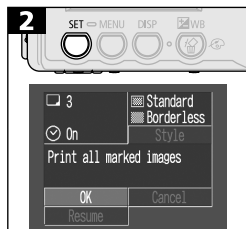

- Set the print style as required (p. 111).
- The print style cannot be set for images that have had the print type set to Index in the DPOF print settings. (You can also select the type of paper when printing with a BJ printer.)
- Use the / / / buttons to select [OK].

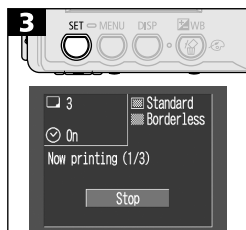

- Press the **SET** button to start printing.
- The replay screen will reappear when printing is successfully concluded.



- To include the date in the prints, set the Date setting in the Set up menu in Step 1 above to [On]. You cannot set the date to print with the Style menu in Step 2 above. Please note however, that the date will not print if the print type is set to Index even if it is turned On in Step 1.
- When the print type is set to Both, it is possible to have both the [Date] and [File No.] options set to [On], but only the file number will print on the Index print.
- When the print type is set to [Standard], file numbers will not be printed even if they are set to [On].





- The maximum number of images printed on one page in the Index print type depends upon the selected paper size.
 - Card Size: 20 images
 - L Size: 42 images
 - Postcard Size: 63 images

(Please refer to your *Bubble Jet Printer Quick Start Guide* for an explanation of the number of images printed with a Bubble Jet printer.)

- **Canceling Printing**

See page 102.

- **Restarting Printing**

In the Print Order menu, use the  or  button to select [Resume] and press the SET button. The remainder of the selected images will print.

Printing cannot be resumed under the following circumstances:

- If the print settings were changed before printing is restarted,
- If images with print settings were deleted before printing is restarted,
- If there was insufficient spare capacity on the CF card when printing was halted.

Under these circumstances, you can select [OK] in the Print menu and reprint starting from the first image.

If printing was stopped because of a low battery charge, you are recommended to resume printing using a household power source. If you do use a battery pack, ensure that it is fully charged. Remember to turn the camera power On again before printing.

- **Printing Errors**

See page 102.

Image Transmission Settings (DPOF Transfer Order)

You can use the camera to specify settings for images that you wish to send by email. Please use the software supplied with the camera to actually transfer the images to an email program. The settings used on the camera comply with the Digital Print Order Format (DPOF) standards.



- The  symbol will display on images that have had print settings set by other DPOF-compliant cameras. These settings will be overwritten by those set by your camera.



Selecting Images for Transferring

1

In the  (Play) menu, select .

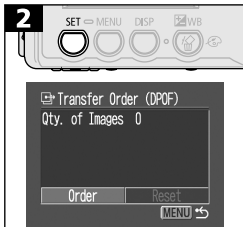
- See *Selecting Menus and Settings* (p. 37).

2

- The Transfer Order menu will display.
- Use the  or  button to select [Order].
- Pressing [Reset] cancels the transfer settings for all images on the CF card.

3

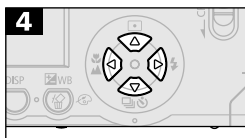
Selected for Transfer

- Use the or button to move to an image and the or button to select or deselect it. A checkmark displays on selected images.



- You can press the button to switch to the index mode (3 images) and use the same procedures to select images.
- While in index view, you can select all of the images by pressing the **SET** button, using the or button to select [Mark all] and pressing the **SET** button again.
- Press the **MENU** button to complete the transfer settings and redisplay the Transfer Order menu.





- Images are transferred in order from oldest to newest by the shooting date.
- A maximum of 998 images can be selected per CF card.
- Transfer settings can also be assigned to images with the supplied software programs on a computer.

Shooting/Replaying with a TV Monitor

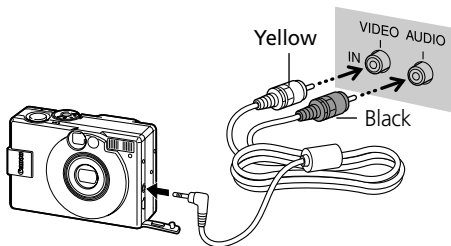
You can use a video-compatible television as a monitor to shoot or replay images when it is connected to the camera with the supplied AV Cable AVC-DC100. You must shut the TV and camera power off before you attach or detach the AV cable.



- After you have attached the AV cable at both ends, turn on the TV and set its TV/Video switch to Video.
- Turn the camera power on and set the mode dial to  or . You can shoot or replay images using the normal procedures.
- If the images are not appearing on the TV when shooting, press the **DISP** button.



- A TV monitor cannot be used in  mode.
- No image will appear on the LCD monitor when the camera is connected to a TV.
- If the TV is a stereo model, you can plug the audio plug into either the left or right Audio In jack. Please refer to the TV's manual for details.



- The video output signal can be switched (NTSC or PAL) to accommodate different regional standards. The default setting varies between regions.
 NTSC: Japan, U.S.A., Canada, Taiwan, etc.
 PAL: Europe, Asia (excluding Taiwan), Oceania, etc.
 If the video system is set incorrectly, the camera output may not display properly.

Downloading Images to a Computer

Download images taken with the camera to a computer in one of the following ways:

- Directly from the CF card.
- Connecting the camera to a computer with the USB cable.

After installing the supplied software, download images automatically by simply connecting the camera to a computer with the supplied USB cable.

- For information about system requirements and for more details about how to download images, refer to the *Software Starter Guide*.

Downloading Directly from a CF Card

Images can be loaded directly from a CF card if you have a slot-equipped notebook computer, a PC card reader or a CF card reader.

- 1** Eject the CF card from the camera and insert it into a CF card reader connected to the computer.

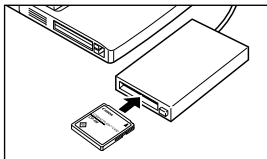

If you are using a PC card reader, first insert the CF card into a PC card adapter (optional), and then insert the PC card adapter into the computer's PC card reader.

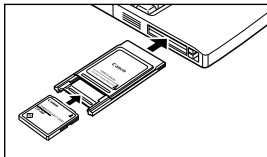

- 2** Double-click the icon of the drive containing the CF card.
- 3** Copy the CF card's images to the desired folder on the hard disk. The images are contained in the [XXXCANON] folder, which is a subfolder of the [DCIM] folder on the CF card. The XXX represents a number from 100 to 998.



- Some computers or memory card readers require the power to be off when the CF card is inserted into the slot. Since this requirement varies between products, please consult the manual for your equipment.

Connecting the Camera to a Computer with a USB Cable

- 1** Use the supplied USB cable to connect the computer's USB port to the DIGITAL Terminal on the camera.

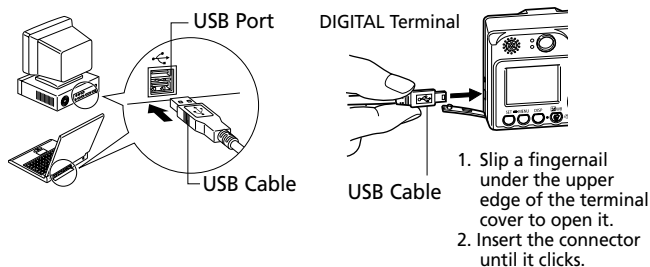

- You do not need to shut off the camera or computer to attach or detach USB interface cables.
- Please refer to your computer's manual for the locations of the computer's USB ports.

2 Turn the camera's mode dial to the  position.

The LCD monitor will turn on in replay mode and then blank out when the connection to the computer is complete.



- Ensure that you grip the sides of the connector to remove the cable from the camera's DIGITAL terminal.

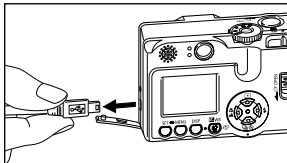

- It is recommended to power the camera from a household power outlet with the optional AC Adapter Kit ACK500 when connected to a computer.
- If the USB cable is detached while the camera power is on, the camera will power down.
- If no controls have been accessed for approximately 5 minutes, a warning message displays on the computer screen. The camera powers down approximately 1 minute later if no control is accessed.





Please refer to the *Software Starter Guide* for the subsequent procedures.

Lists of Menu Options and Messages

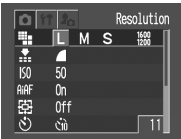

The following charts list the various menu contents. See “Selecting Menu and Settings” (p. 37) to learn how to select a setting.

Rec. Menu

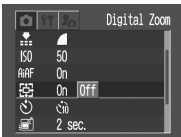

* Default setting

Item/Menu Screen	Options	Reference Page
<p data-bbox="174 425 342 454">Resolution (Stills)</p> 	<p data-bbox="412 429 770 476">Sets the number of pixels used to record images to CF cards.</p> <ul data-bbox="418 486 687 648" style="list-style-type: none"> • L (Large)* 1600 x 1200 pixels • M (Medium) 1024 x 768 pixels • S (Small) 640 x 480 pixels 	<p data-bbox="845 511 895 539">p. 47</p>
<p data-bbox="159 676 356 705">Resolution (Movies)</p> 	<p data-bbox="412 678 770 725">Sets the number of pixels used to record movies to CF cards.</p> <ul data-bbox="418 735 629 825" style="list-style-type: none"> • 640 640 x 480 pixels • 320 320 x 240 pixels* • 160 160 x 120 pixels 	<p data-bbox="845 759 895 788">p. 47</p>
<p data-bbox="194 902 322 931">Compression</p> 	<p data-bbox="412 903 785 951">Sets the relative compression ratio used to record images to CF cards.</p> <ul data-bbox="418 961 553 1051" style="list-style-type: none"> • S Superfine • Fine* • Normal 	<p data-bbox="845 985 895 1013">p. 47</p>
<p data-bbox="208 1128 308 1156">ISO Speed</p> 	<p data-bbox="412 1129 757 1176">Sets the sensitivity at which images are recorded.</p> <ul data-bbox="418 1186 491 1305" style="list-style-type: none"> • 50* • 100 • 200 • 400 • AUTO 	<p data-bbox="845 1210 895 1239">p. 73</p>

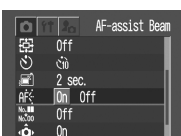
* Default setting

Item/Menu Screen	Options	Reference Page
<p style="text-align: center;">AiAF</p> 	<p>Sets whether or not the camera automatically selects one of three AF frames or a fixed center AF frame.</p> <ul style="list-style-type: none"> • On* • Off 	p. 64
<p style="text-align: center;">Digital Zoom</p> 	<p>Sets the whether or not the optical zoom is supplemented by digital processing.</p> <ul style="list-style-type: none"> • On • Off* 	p. 52
<p style="text-align: center;">Self-timer</p> 	<p>Sets the duration before the self-timer releases the shutter.</p> <ul style="list-style-type: none"> • 10 seconds* • 2 seconds 	p. 54
<p style="text-align: center;">Review</p> 	<p>Sets the duration images display on the LCD monitor after the shutter button releases.</p> <ul style="list-style-type: none"> • Off • 2 seconds* • 10 seconds 	p. 46
<p style="text-align: center;">AF-assist Beam</p> 	<p>Sets the AF-assist Beam to on or off.</p> <ul style="list-style-type: none"> • On* • Off 	p. 35

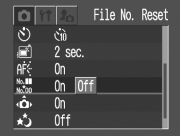
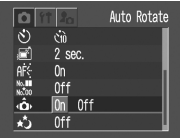
* Default setting

Item/Menu Screen	Options	Reference Page
<p data-bbox="189 215 325 237">File No. Reset</p> 	<p data-bbox="410 215 770 265">Sets how file numbers are assigned to images when new CF cards are inserted.</p> <ul data-bbox="418 272 474 322" style="list-style-type: none"> • On • Off * 	p. 75
<p data-bbox="194 442 320 464">Auto Rotate</p> 	<p data-bbox="410 442 795 512">Sets whether or not images shot with the camera on end are automatically rotated in the display.</p> <ul data-bbox="418 519 474 571" style="list-style-type: none"> • On* • Off 	p. 74
<p data-bbox="189 664 325 685">Long Shutter</p> 	<p data-bbox="410 664 757 691">Sets the shutter speed to slow settings.</p> <ul data-bbox="418 698 474 749" style="list-style-type: none"> • On • Off * 	p. 67

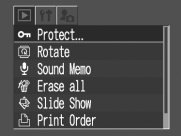
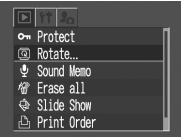
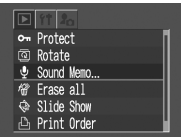
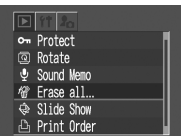
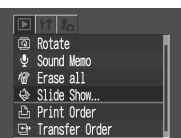

Play Menu

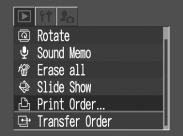
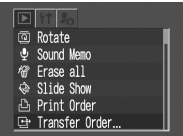
Item/Menu Screen	Options	Reference Page
<p style="text-align: center;">Protect</p> 	Prevents images from accidental erasure.	p. 90
<p style="text-align: center;">Rotate</p> 	Rotates images clockwise 90° or 270° in the display.	p. 83
<p style="text-align: center;">Sound Memo</p> 	Adds sound memo to images.	p. 84
<p style="text-align: center;">Erase all</p> 	Deletes all images from a CF card (except for protected images).	p. 92
<p style="text-align: center;">Slide Show</p> 	Plays images in automated slide shows.	p. 86

Item/Menu Screen	Options	Reference Page
<p data-bbox="200 177 314 199">Print Order</p> 	<p data-bbox="410 177 812 251">Selects images and the number of print copies for output to a direct print compatible printer or a photo developing service.</p>	<p data-bbox="843 262 905 285">p. 107</p>
<p data-bbox="184 399 329 422">Transfer Order</p> 	<p data-bbox="410 399 812 448">Selects the images that will be transferred to your email software.</p>	<p data-bbox="843 482 905 505">p. 116</p>

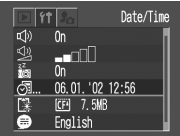

Set up Menu

* Default setting



Item/Menu Screen	Options	Reference Page
<p style="text-align: center;">Beep</p> 	<p>Sets whether or not a beep sounds when the shutter button is pressed or a menu operation is performed.*¹</p> <ul style="list-style-type: none"> • On* • Off <p>A beep still sounds to warn of errors even when Off is selected.</p>	p. 34
<p style="text-align: center;">Speaker Vol.</p> 	<p>Adjusts the audio volume for the start-up sound, shutter sound, operation sound and selftimer sound, movies and sound annotations.</p> <ul style="list-style-type: none"> • □□□□ (Off) • ■□□□ (1) • ■■□□ (2)* • ■■■□□ (3) • ■■■■□ (4) • ■■■■■ (5) 	p. 81
<p style="text-align: center;">Power Save</p> 	<p>Sets whether or not the camera automatically powers down after a set period of time elapses without something being pressed.</p> <ul style="list-style-type: none"> • On* • Off 	p. 28
<p style="text-align: center;">Date/Time</p> 	<p>Sets the date and time and the date format.</p>	p. 25

*¹ See also how this item and each sound setting in the  (My Camera) menu interact (p. 129).















* Default setting

Item/Menu Screen	Options	Reference Page
<p style="text-align: center;">Format</p> 	<p>Formats (initializes) CF cards.</p>	<p>p. 93</p>
<p style="text-align: center;">Language</p> 	<p>Sets the language used in menus and messages on the LCD monitor.</p> <ul style="list-style-type: none"> • English* • Italiano • Deutsch • Norsk • Français • Svenska • Nederlands • Español • Dansk • Chinese • Suomi • Japanese <p>You can also change the language in replay mode by holding the SET button and pressing the MENU button.</p>	<p>p. 26</p>
<p style="text-align: center;">Video System</p> 	<p>Sets the video output signal standard.</p> <ul style="list-style-type: none"> • NTSC • PAL 	<p>p. 118</p>

My Camera Menu













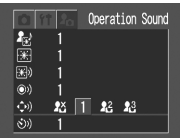

You can select the start-up image and sound, shutter sound, operation sound and selftimer sound used on this camera. These are called the My Camera Settings. You can also customize the  and  options for each item using the supplied software. See the *Software Starter Guide* for details.

* Default setting

Item/Menu Screen	Options	Reference Page
<p style="text-align: center;">Theme</p> 	<p>Selects a common theme for each My Camera Settings item.*¹</p> <ul style="list-style-type: none"> •  (Off) •  * •  •  	<p>p. 43</p>
<p style="text-align: center;">Start-up Image</p> 	<p>Sets the image displayed when the camera power is turned on.</p> <ul style="list-style-type: none"> •  (Off) •  * •  •  	<p>p. 43</p>
<p style="text-align: center;">Start-up Sound</p> 	<p>Sets the sound emitted when the camera power is turned on.*¹</p> <ul style="list-style-type: none"> •  (Off) •  * •  •  	<p>p. 43</p>



*¹ See also how this item and the beep interact (p. 131).

* Default setting













Item/Menu Screen	Options	Reference Page
<p data-bbox="184 211 332 235">Shutter Sound</p> 	<p data-bbox="412 211 812 287">Sets the sound emitted when the shutter button is pressed. There is no shutter sound for movies.*¹</p> <ul data-bbox="422 294 526 421" style="list-style-type: none"> •  (Off) •  * •  * •  * 	p. 43
<p data-bbox="174 446 342 471">Operation Sound</p> 	<p data-bbox="412 446 795 501">Sets the sound emitted when any button other than the shutter button is pressed.*¹</p> <ul data-bbox="422 508 526 635" style="list-style-type: none"> •  (Off) •  * •  * •  * 	p. 43
<p data-bbox="179 668 337 692">Selftimer Sound</p> 	<p data-bbox="412 668 816 722">Sets the sound emitted 2 seconds before the shutter releases in self-timer mode.*¹</p> <ul data-bbox="422 729 526 856" style="list-style-type: none"> •  (Off) •  * •  * •  * 	p. 43

*¹ See also how this item and the beep interact (p. 131).

How the Beep in the (Set up) Menu and Sounds in the (My Camera) Menu Interact

To turn off each sound, such as the start-up sound, shutter sound, operation sound and selftimer sound, the beep must first be set to [Off] in the  (Set up) menu and then each sound item must be set individually to [Off]. If the beep is set to On, a beep will sound for each item even if it is set to Off in the  (My Camera) menu.

The table below shows the relationship.

		Beep Setting in the  (Set up) Menu	
		On	Off
Sounds in the  (My Camera) Menu (Start-up, shutter, operation, selftimer)		● Beep	—
		● 	● 
		● 	● 
		● 	● 

● Sound emitted

— Sound not emitted

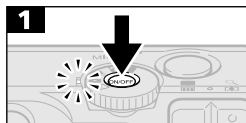

Resetting All Settings to Their Default Values

You can reset all the menu and button settings to the default settings in one operation except for the [Date/Time], [Language] and [Video System] settings.

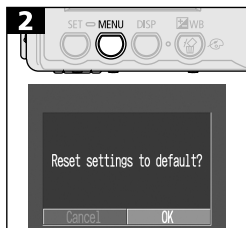

- Press the On/Off Button until the green power lamp lights.
- Set the mode dial to any position.



- Press and hold the **MENU** button for more than 5 seconds.
- Use the  or  button to select [OK].
- To exit without resetting, select [Cancel].



- The following settings will not return to the default settings.
 - White balance data recorded with the manual white balance function (p. 70)
 - Customized My Camera Settings (p. 42)

List of Messages

The following messages may appear on the LCD monitor while shooting or replaying.

Busy...	Image is being recorded to, or read from, CF card
No CF card	You attempted to shoot or replay images without a CF card installed.
Cannot record!	You attempted to shoot an image without a CF card installed.
CF card error!	CF card has experienced an anomaly.
CF card full	CF card is too full to accommodate more images or print settings.
Naming error!	The file could not be created because there is a file with the same name as the directory that the camera is attempting to create, or the highest possible file number has already been reached. In the Rec. Menu, set the File Reset option to On. Save all the images you wish to retain onto a computer, then reformat the CF card. Please note that formatting will erase all the existing images and other data.
Change the battery pack	Battery charge is insufficient to operate the camera. Replace it at once with a charged one or recharge the battery pack.
No image	No images recorded on CF card.
Image too large	You attempted to replay an image larger than 3200 x 2400 pixels or a movie clip recorded by another camera.
Incompatible JPEG format	You attempted to replay an incompatible JPEG file.

Corrupted Data	You attempted to replay an image with corrupted data.
RAW	You attempted to replay an image recorded in the RAW format.
Unidentified Image	You attempted to replay an image that was recorded in a special format (proprietary format used by the camera of another manufacturer, etc.) or a movie clip recorded by another camera.
Cannot magnify!	You attempted to magnify an image which was photographed with another camera, recorded in a different format, or edited on a computer.
Cannot rotate	You attempted to rotate an image which was photographed with another camera, recorded in a different format, or edited on a computer.
Incompatible WAVE format	Format of recorded sound annotation is incorrect so it cannot be added to this image.
Protected!	You attempted to erase a protected image.
Too many marks	Too many images have been marked with print settings, transfer settings or slide show settings. Cannot process any more.
Unselectable image	You attempted to set the print settings for a non-JPEG file.
Exx:	(xx: number) Camera malfunction. Turn the power off and then back on, then shoot or replay. A problem exists if the error code reappears. Note the number and contact your Canon Customer Support Help Desk. If an error code displays directly after taking a picture, the shot may not have been recorded. Check image in replay mode.

List of Messages Displayed while a Direct Print Function Compatible Printer is Connected

The following messages may appear on the camera's LCD monitor while a direct print compatible printer (sold separately) is connected.

No Paper	Paper cassette is empty or incorrectly installed. Paper feed may not be operating correctly.
No Ink	The ink cassette is empty or missing.
Incompatible paper size	You attempted to print with a paper size incompatible with this camera.
Incompatible ink size	You attempted to print with an ink cartridge type incompatible with this camera.
Ink Cassette Error	There is a problem with the ink cassette.
Paper and ink do not match	The paper size and ink type are from different sets.
Paper Jam	Paper jammed during printing.
Paper has been changed	The paper size was changed between the time the Print Style menu was displayed and the time printing started.
Ink has been changed	The ink type was changed between the the time the Print Style menu was displayed and the time printing started.
Recharge the printer battery	The printer's battery is out of power.
Communication Error	A communication error has occurred.
Cannot print!	You attempted to print an image shot by a different camera, one recorded in an incompatible format, or one downloaded to and edited with a computer.
Could not print XX images	You attempted to print XX number of images with DPOF print settings that were shot by a different camera, recorded in an incompatible format, or downloaded to and edited with a computer.

List of Messages Displayed while a Direct Print function Compatible Bubble Jet Printer is Connected

The following messages may appear on the camera's LCD monitor while a direct print compatible Bubble Jet printer (sold separately) is connected.

Please also check the *Quick Start Guide* for the Bubble Jet printer, checking the error number displayed on the printer's control panel against those listed in the guide.

Printer in use	Printer is busy printing from memory card in computer or printer. Printer will automatically start printing from camera when the current print queue empties.
Printer warming up	Printer is warming up. When it is ready, the printer will start printing automatically.
No printhead	No printhead installed in printer.
Printer cover open	Secure the printer cover.
Media type error	You selected a paper type incompatible with the printer. Select a compatible paper type in the Print Style menu.
Paper lever error	Adjust the paper selection lever to the proper position.
Low ink level	Ink tank needs replacement soon. Prepare a new ink tank. Select [Continue] in the error message to resume printing.
Waste tank full	Restart printing by pressing RESUME/CANCEL button on printer, but request a replacement waste ink tank from retailer or service center (see printer manual) soon.
Printer error	Turn printer off and on again. If error persists, consult service center listed in printer manual.

Appendices

Using the Household Power Source

It is best to power the camera with AC Adapter Kit ACK500 (sold separately) when you are using it for long periods of time or connecting it to a computer.



- Turn the camera power off before connecting or disconnecting the AC adapter.

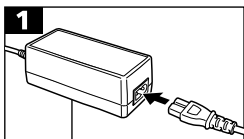

Compact Power Adapter
CA-PS500

- Connect the power cord to the compact power adapter first and then plug the other end into the electrical outlet.

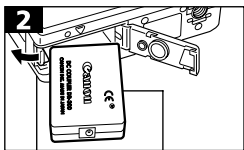

Battery Lock DC Coupler
Lock DR-500

- Open the battery cover and press the battery lock in the direction shown while inserting DC Coupler DR-500. Insert the DC coupler all the way in until the battery lock clicks. Slide the battery cover closed.

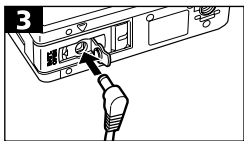

- Open the DC coupler terminal cover and attach the cord to the DC terminal.
- After you have finished using the camera, unplug the AC adapter from the electrical outlet.



- Use of an AC adapter kit other than ACK500 may cause a malfunction in the camera or kit.

Using a Car Battery Charger (Optional)

Car Battery Charger CBC-NB1 (sold separately) can be used to charge battery packs from an automobile's cigarette lighter socket.



- Always ensure that the automobile's engine is running when you use the car battery charger. Use of it with the engine off may flatten the battery in some automobiles. Always unplug the car battery charger before turning off the engine.

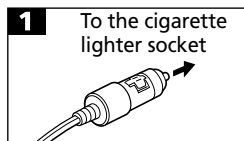

- With the engine running, plug the car battery cable into the cigarette lighter socket and the battery charger.

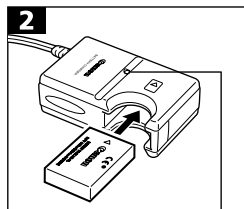

Charging Indicator

- Insert the battery pack all the way into the battery charger as shown.
- The charging indicator will shine red while the battery pack is charging. It will change to green when the charge is complete.
- After charging, unplug the car battery cable from the cigarette lighter socket and remove the battery pack.



- The battery will stop charging whenever you turn the engine off, so be sure to unplug the car battery cable from the cigarette lighter socket.
- Wait until the engine is running again to plug the car battery cable into the cigarette lighter socket.
- The car battery charger can only be used in a negative ground car. It cannot be used in a positive ground car.

Camera Care and Maintenance

Use the following procedures to clean the camera body, lens, viewfinder and LCD monitor.



- Never use thinners, benzene, synthetic cleansers or water to clean the camera. These substances may distort or damage the equipment.

Camera Body

Gently wipe dirt off the camera body with a soft cloth or eyeglass lens wiper.

Lens

First use a lens blower brush to remove dust and dirt, then remove any remaining dirt by wiping the lens lightly with a soft cloth.



- Never use synthetic cleansers on the camera body or lens.
- If dirt remains, contact the closest Canon Customer Support Help Desk as listed on the separate Canon Customer Support leaflet.





Viewfinder and LCD Monitor

Use a lens blower brush to remove dust and dirt. If necessary, gently wipe with a soft cloth or an eyeglass lens wiper to remove stubborn dirt.





- Never rub or press strongly on the LCD monitor. These actions may damage it or lead to other problems.

Troubleshooting

Problem	Cause	Solution
Camera will not operate	Power is not turned on	<ul style="list-style-type: none"> • Press the ON/OFF button for a moment.
	Battery cover or CF card slot cover is open	<ul style="list-style-type: none"> • Confirm that the battery cover and CF card slot cover are securely closed.
	Insufficient battery voltage	<ul style="list-style-type: none"> • Insert a fully charged battery into the camera. • Use a household power source.
	Poor contact between camera and battery terminals	<ul style="list-style-type: none"> • Wipe the terminals with a clean dry cloth.
Camera will not record	Mode dial is set to  (Replay)	<ul style="list-style-type: none"> • Turn the mode dial to the , M,  or  position.
	Flash is charging	<ul style="list-style-type: none"> • Wait until the flash charges. You can press the shutter button when the indicator glows a steady orange.
	CF card is full	<ul style="list-style-type: none"> • Insert a new CF card. • If required, download the images to a computer and erase them from the CF card to make space.
	CF card is not formatted correctly	<ul style="list-style-type: none"> • Format CF card (See <i>Formatting CF Cards</i>, p. 93). • If reformatting doesn't work, the CF card logic circuits may be damaged. Consult the nearest Canon Customer Support Help Desk.

Problem	Cause	Solution
Lens will not retract	Battery cover or CF card slot cover was opened with power on	<ul style="list-style-type: none"> • First close the battery cover or CF card slot cover and then turn the power off.
	Battery cover or CF card slot cover was opened while recording to the CF card (warning signal sounds)	<ul style="list-style-type: none"> • First close the battery cover or CF card slot cover and then turn the power off.
Battery pack consumed quickly	Battery life exceeded if battery pack loses its charge quickly at room temperature (23° C/73° F)	<ul style="list-style-type: none"> • Replace the battery pack with a new one.
Battery pack will not charge	Battery pack life exceeded	<ul style="list-style-type: none"> • Replace the battery pack with a new one.
	Poor contact between battery pack and battery charger	<ul style="list-style-type: none"> • Insert battery pack securely into battery charger. • Ensure that battery charger plug is securely plugged into the electrical outlet.
Image is blurred or out of focus	Camera moved	<ul style="list-style-type: none"> • Be careful not to move the camera while pressing the shutter button.
	Autofocus function hampered by obstruction to AF-assist Beam	<ul style="list-style-type: none"> • Be careful not to block the AF-assist Beam with fingers or other items.

Problem	Cause	Solution
Image is blurred or out of focus	AF-assist Beam is set to off	<ul style="list-style-type: none"> • Set the AF-assist Beam to [On]. (p. 35)
	Subject is out of focal range	<ul style="list-style-type: none"> • Ensure there is at least 76 cm (2.5 ft.) between the camera lens and subject. • Use the Macro mode to shoot close-ups between 16 and 76 cm (6.3 in. to 2.5 ft.) from the lens when set to wide angle and between 26 and 76 cm (10.2 in. to 2.5 ft.) when set to telephoto. • Use the Infinity mode to shoot distant subjects.
Subject in recorded image is too dark	Insufficient light for shooting	<ul style="list-style-type: none"> • Set the flash to [On].
	Subject is dark in contrast to the background	<ul style="list-style-type: none"> • Set the exposure compensation to a positive (+) setting or use the spot metering function.
	Subject is too far away for flash to reach	<ul style="list-style-type: none"> • Shoot within 3.5 m (11.5 ft.) of the subject at the maximum wide angle or 2 m (6.6 ft.) of the subject at the maximum telephoto setting when using the flash.
Subject in recorded image is too bright	Subject is too close, making the flash too strong	<ul style="list-style-type: none"> • When using the flash, stay at least 26 cm (10.2 in.) from the subject.
	Subject is bright in contrast to the background	<ul style="list-style-type: none"> • Set the exposure compensation to a negative (-) setting or use the spot metering function.

Problem	Cause	Solution
Subject in recorded image is too bright	Light is shining directly on the subject or reflected off the subject into the camera	<ul style="list-style-type: none"> • Change the shooting angle.
	Flash is set to on	<ul style="list-style-type: none"> • Set the flash to [Off].
Flash does not fire	Flash is set to off	<ul style="list-style-type: none"> • Set the flash to [On].
Image not showing on TV monitor	Incorrect video system setting	<ul style="list-style-type: none"> • Set the video system to the appropriate setting, NTSC or PAL, for your TV (p. 118).
	Shooting mode set to  (Stitch Assist)	<ul style="list-style-type: none"> • The output will not appear on a TV monitor in  (Stitch Assist) mode. Shoot in a different mode.
Zoom does not work	Zoom button pressed during movie recording	<ul style="list-style-type: none"> • Adjust the zoom before shooting a movie.

Specifications

All data is based on Canon's standard testing methods.
Subject to change without notice.

PowerShot S330 DIGITAL ELPH / DIGITAL IXUS 330

Camera Effective Pixels:	Approx. 2 million
Image Sensor:	1/2.7 in. CCD (Total number of pixels: approx. 2.1 million)
Lens:	5.4 (W) - 16.2 (T) mm (35 mm film equivalent: 35-105 mm) F2.7 (W) - 4.7 (T)
Digital Zoom:	Maximum 2.5 x (Maximum 7.5 x with optical zoom)
Optical Viewfinder:	Primary imaging real-image optical zoom viewfinder
LCD Monitor:	1.5 in. low-temperature polycrystalline silicon TFT color LCD, approx. 120,000 pixels
Autofocus:	TTL 3-point AiAF/TTL 1-point center AF Focus lock possible
Focusing Range:	Normal: 76 cm (2.5 ft.) - ∞ Macro AF: 16-76 cm (6.3 in. - 2.5 ft.) (W) 26-76 cm (10.2 in. - 2.5 ft.) (T)
Shutter:	Mechanical + electronic
Shutter Speed:	15 - 1/1500 sec. <ul style="list-style-type: none"> • 1-1/6 sec. possible at flash-off or slow-synchro in manual mode • 15-1 sec. possible in long shutter mode • Noise reduction processing on speeds between 15-1.3 sec.
Light Metering Method:	Evaluative metering (linked to focusing point)/ Spot metering
Exposure Control:	Program AE
Exposure Compensation:	± 2 EV (in 1/3-stop increments)
Sensitivity:	ISO 50/100/200/400 equivalent and Auto (in Auto mode, camera automatically adjusts sensitivity in the range of ISO 50 to ISO 150 equivalent)

(W): wide angle (T): telephoto

White Balance:	TTL auto/preset (daylight, cloudy, tungsten, fluorescent, fluorescent H) or custom white balance
Flash:	Red-eye reduction auto/auto/on/off/slow-synchro
Flash Range:	Normal mode: 76 cm - 3.5 m (2.5 - 11.5 ft.) (W) 76 cm - 2.0 m (2.5 - 6.6 ft.) (T) Macro Mode: 26 - 76 cm (10.2 in. - 2.5 ft.) (W/T)
Shooting Modes:	Auto/manual/stitch assist/movie
Continuous Shooting:	Approx. 2.5 images/sec. (Large/Fine mode, LCD monitor off)
Self-Timer:	Shoots after approx. 10 sec. or approx. 2 sec.
PC Connected Shooting:	Available (USB connection only. Exclusive software program "Remote Capture" is included in the camera kit.)
Recording Media:	CompactFlash™ card (Type I)
File Format:	Design rule for Camera File System, DPOF compliant
Image Recording Format	Still images: JPEG (Exif 2.2) * Movies: AVI - Image data: Motion JPEG - Audio data: WAVE (monaural)
Compression:	Superfine/fine/normal
Number of Recording Pixels:	Still images: large 1600 x 1200 pixels medium 1024 x 768 pixels small 640 x 480 pixels Movies: 640 x 480 pixels (Approx. 4 sec.) 320 x 240 pixels (Approx. 10 sec.) 160 x 120 pixels (Approx. 30 sec.) Approx. 20 frames/sec <ul style="list-style-type: none"> The data in parentheses refer to the maximum movie length per shooting
Replay Modes:	Single image view/index view (9 thumbnails)/ zoomed view (LCD monitor zooms images up to 10 x)/slide show/printing with Card Photo Printer CP-100, CP-10 or Bubble Jet Printer (Direct Print Function)
Display Languages:	English, Deutsch, Français, Nederlands, Dansk, Suomi, Italiano, Norsk, Svenska, Español, Chinese and Japanese

(W): wide angle (T): telephoto

My Camera Settings:	Start-up image, Start-up sound, Shutter sound, Operation sound and Selftimer sound. Customizing is possible by downloading data from your computer using the supplied software.
Interface:	Universal Serial Bus (USB), Audio/Video output (NTSC or PAL selectable, Monaural audio)
Power Source:	Rechargeable Lithium-ion battery (type: NB-1LH/NB-1L) Compact Power Adapter CA-PS500 Car Battery Charger CBC-NB1
Operating Temperatures:	0 - 40° C (32 - 104° F)
Operating Humidity:	10% - 90%
Dimensions (w x h x d):	94.8 x 62.5 x 31.5 mm (3.7 x 2.5 x 1.2 in.) (excluding protrusions)
Weight:	Approx. 245 g (8.6 oz.) (camera body only)

- * This digital camera supports Exif 2.2 (also called "Exif Print"). Exif Print is a standard for enhancing the communication between digital cameras and printers. By connecting to an Exif Print-compliant printer, the camera's image data at the time of shooting is used and optimized, yielding extremely high quality prints.

Battery Capacity

Battery Pack NB-1LH (fully charged)













Number of recordable images	LCD monitor on	Approximately 150 images
	LCD monitor off	Approximately 420 images
Replay	Approximately 100 minutes	









- Excludes movie data.
- At low operating temperatures, the battery performance may drop and the low battery icon may appear sooner than at high temperature. To improve performance at these temperatures, warm the battery in your pocket just before using it in the camera.

Test Criteria







- Shooting:** Room temperature (23° C / 73° F), alternating between wide angle and telephoto every 20 second, flash used one in four shots, power turned off and on again after every eighth shot.
- Replaying:** Room temperature (23° C / 73° F), continuous replay at 3 seconds per image.

CF Cards and Estimated Capacities (Recordable Images)

		FC-8M	FC-16M	FC-32M	FC-64M	FC-128M
L (1600 x 1200 pixels)		7	15	31	64	128
		11	24	49	100	200
		24	48	99	200	401
M (1024 x 768 pixels)		16	32	67	135	271
		24	49	102	205	412
		46	92	189	379	760
S (640 x 480 pixels)		35	70	143	288	577
		50	99	206	415	831
		87	172	353	707	1417
MOVIE	 (640 x 480 pixels)	6 sec.	13 sec.	27 sec.	56 sec.	113 sec.
	 (320 x 240 pixels)	18 sec.	36 sec.	75 sec.	152 sec.	305 sec.
	 (160 x 120 pixels)	48 sec.	97 sec.	198 sec.	399 sec.	799 sec.

- The maximum length of a movie clip recording is approximately: 4 sec. () , 10 sec. () or 30 sec. () . The time shown are the maximum continuous recording times.
- **L** (Large), **M** (Medium), **S** (Small), ,  and  indicate the recording resolution.
-  (Superfine),  (Fine) and  (Normal) indicate the compression setting.

Approximate Image File Sizes (Estimated)

Resolution	Compression		
			
L (1600 x 1200 pixels)	957 KB	611 KB	302 KB
M (1024 x 768 pixels)	450 KB	294 KB	155 KB
S (640 x 480 pixels)	208 KB	141 KB	79 KB
Movies	 (640 x 480 pixels)	900 KB/sec.	
	 (320 x 240 pixels)	380 KB/sec.	
	 (160 x 120 pixels)	130 KB/sec.	

Battery Pack NB-1LH

Type:	Rechargeable Lithium Ion Cell
Nominal Voltage:	3.7 V
Typical Capacity:	840 mAh
Cycle Life:	Approx. 300 times
Operating Temperatures:	0-40 °C (32-104 °F)
Dimensions:	32.3 x 49.8 x 10.6 mm (1.3 x 1.9 x 0.4 in.)
Weight:	Approx. 29 g (1.0 oz.)

Battery Charger CB-2LS/CB-2LSE

Rated Input:	100-240 V AC (50/60 Hz) 0.075 A (100 V)-0.045 A (240 V)
Rated Output:	4.2 V DC/0.5 A
Charging Time:	Approx. 130 minutes *
Operating Temperatures:	0-40 °C (32-104 °F)
Dimensions:	90.4 x 56.0 x 28.0 mm (3.6 x 2.2 x 1.1 in.)
Weight:	Approx. 78 g (2.8 oz.)

* When charging Battery Pack NB-1LH

CompactFlash™ Card

Card Slot Type:	Type I
Dimensions:	36.4 x 42.8 x 3.3 mm (1.4 x 1.7 x 0.1 in.)
Weight:	Approx. 10 g (0.4 oz.)

Compact Power Adapter CA-PS500

(Included with the optional AC Adapter Kit ACK500)

Rated Input:	AC 100-240 V (50/60 Hz) 0.17 A
Rated Output:	4.3 V DC/1.5 A
Operating Temperatures:	0-40 °C (32-104 °F)
Dimensions:	42.6 x 104.4 x 31.4 mm (1.7 x 4.1 x 1.2 in.)
Weight:	Approx. 180 g (6.3 oz.)

Car Battery Charger CBC-NB1 (Optional)

Rated Input:	DC 12 - 24 V, 4.3 W
Rated Output:	4.2 V DC, 0.55 A
Charging Time:	Approx. 130 Minutes*
Operating Temperatures:	0 - 40°C (32 - 104°F)
Dimensions:	90.4 x 56.0 x 28.0 mm (3.6 x 2.2 x 1.1 in.)
Weight:	Approx. 106 g (3.7 oz.)

* When charging Battery Pack NB-1LH

Index

A

AC Adapter Kit (ACK500) 137
 AE Lock 62
 AF Frame 31, 64
 AF-assist Beam 35
 AF Lock 60
 AiAF 33
 Autofocus 33, 64
 Autofocus Lock 60
 Auto Mode 18
 Auto Rotate 74
 AV Cable AVC-DC100 118

B

Battery
 Battery Pack Charge 22
 Capacities 146
 Handling 20
 Installing 21
 Recharging 19
 Battery Pack 19

C

Care and Maintenance 139
 CF Card
 Capacities 147
 Formatting 93
 Handling 24
 Installing 23
 Car Battery Charger 138
 Compression 47
 Continuous Shooting 53
 Customizing the Camera 42

D

Date/Time 25
 DIGITAL Terminal 99, 100, 120
 Digital Zoom 36, 52
 Direct Interface Cable
 DIF-100 98

Direct Print Function Compatible
 BJ Printer 99
 Direct Print Function Compatible
 Printer 98
 Direct Print Function 94
 DPOF 94, 96, 107, 116
 DPOF Print Order 94
 Printing 107
 Print Style 111
 Resetting 113
 Selecting Images 107
 DPOF Transfer Order 116
 Downloading Images to a Computer
 119

E

Erasing
 All Images 92
 Single Images 91
 Exposure 63, 66

F

FE Lock 63
 File Number 75
 File Sizes 147
 Flash 49
 Focus Lock 60
 Formatting 93

H

Household Power Source 137
 Histogram 32

I

Image File Sizes 147
 Index View 80
 Indicator 17
 ISO Speed 73

L

Language 26
 LCD Monitor
 Information Displayed 30
 Using the LCD Monitor 29

M

- Macro Mode 51
- Magnify 79
- Manual Mode 18
- Manual White Balance 70
- Menu
 - My Camera 129
 - Play 125
 - Rec. 122
 - Set up 127
- Messages
 - List of Messages 133
 - Messages Displayed while a Direct Print Compatible Bubble Jet Printer is Connected 136
 - Messages Displayed while a Direct Print Compatible Printer is Connected 135
- Metering Method 65
- Mode Dial 18, 45
- Movie
 - Movie Mode 18, 58
 - Viewing 81
- My Camera Menu 129
- My Camera Settings 42
 - Adding 44
 - Changing 43
 - File Format 44

O

- On/Off Button 27
- Optical Viewfinder 33

P

- Photo Effect 72
- Play Menu 125
- Power On/Off 27
- Power Lamp 16
- Power Save 28
- Print Settings (Direct Print Function)
 - Number of Print Copies 103
 - Printing Area 105
 - Print Style 103
- Protect 90

R

- Rec. Menu 122
- Red-Eye Reduction Function 50
- Replay Mode 18
- Resolution 47
- Review Duration 46
- Rotate 83

S

- Self-Timer 54
- Set up Menu 127
- Shooting Mode 18, 45
 - Functions Available in Each Shooting Mode 76
- Shutter Button 34
 - Pressing Fully 35
 - Pressing Halfway 34
- Shutter Speed 67
- Single Image View 78
- Slide Show 86
 - Play Time 89
 - Repeat Settings 89
- Sound Memo 84
- Spot AE Point Frame 31, 65
- Stitch Assist Mode 18, 55

T

- Telephoto 36

U

- USB Cable 120

V

- Video Output System 118
- Viewfinder 33
- Viewing
 - Single Image View 78
 - Index View 80
- White Balance 69
- Wide Angle 36
- Wrist Strap 15

Disclaimer

- While every effort has been made to ensure that the information contained in this guide is accurate and complete, no liability can be accepted for any errors or omissions. Canon reserves the right to change the specifications of the hardware and software described herein at any time without prior notice.
- No part of this guide may be reproduced, transmitted, transcribed, stored in a retrieval system, or translated into any language in any form, by any means, without the prior written permission of Canon.
- Canon makes no warranties for damages resulting from corrupted or lost data due to a mistaken operation or malfunction of the camera, the software, the CompactFlash™ cards (CF cards), personal computers, peripheral devices, or use of non-Canon CF cards.

Trademark Acknowledgments

- Canon and PowerShot are trademarks of Canon, Inc.
- CompactFlash is a trademark of SanDisk Corporation.
- iBook and iMac are trademarks of Apple Computer, Inc.
- Macintosh, PowerBook, Power Macintosh and QuickTime are trademarks of Apple Computer, Inc, registered in the United States and/or other countries.
- Microsoft, Windows and Windows NT are either registered trademarks or trademarks of Microsoft Corporation in the United States and/or other countries.
- Other names and products not mentioned above may be registered trademarks or trademarks of their respective companies.

FCC Notice

(Digital Camera, Model PC1026)

This device complies with Part 15 of the FCC Rules. Operation is subject to the following two conditions;

(1) this device may not cause harmful interference, and

(2) this device must accept any interference received, including interference that may cause undesired operation.

Note: This equipment has been tested and found to comply with the limits for Class B digital devices, pursuant to Part 15 of the FCC rules. These limits are designed to provide reasonable protection against harmful interference in a residential installation. This equipment generates, uses and can radiate radio frequency energy and, if not installed and used in accordance with the instructions, may cause harmful interference to radio communications. However, there is no guarantee that interference will not occur in a particular installation. If this equipment does cause harmful interference to radio or television reception, which can be determined by turning the equipment off and on, the user is encouraged to try to correct the interference by one or more of the following measures:

- Reorient or relocate the receiving antenna.
- Increase the separation between the equipment and receiver.
- Connect the equipment into an outlet on a circuit different from that to which the receiver is connected.
- Consult the dealer or an experienced radio/TV technician for help.

The cable with the ferrite core provided with the digital camera must be used with this equipment in order to comply with Class B limits in Subpart B of Part 15 of the FCC rules.

Do not make any changes or modifications to the equipment unless otherwise specified in the manual. If such changes or modifications should be made, you could be required to stop operation of the equipment.

Canon U.S.A. Inc.

One Canon Plaza, Lake Success, NY 11042, U.S.A.

Tel No. (516) 328-5600

Canadian Radio Interference Regulations

THIS CLASS B DIGITAL APPARATUS MEETS ALL REQUIREMENTS OF THE CANADIAN INTERFERENCE CAUSING EQUIPMENT REGULATIONS.

Réglementation canadienne sur les interférences radio

CET APPAREIL NUMERIQUE DE LA CLASSE B RESPECTE TOUTES LES EXIGENCES DU REGLEMENT SUR LE MATERIEL BROUILLEUR DU CANADA.