

ENGLISH



CDI-E093

Canon

PowerShot A70 PowerShot A60

DIGITAL CAMERA

Camera User Guide



DiGiC

- Please start by reading the Precautions on page 7 of this manual.
- Please refer to the *Software Starter Guide* for information on installing the software and downloading images.
- Please also read the printer user guide included with your Canon printer.

Exif Print



Canon

Canon DIGITAL CAMERA PowerShot A70/A60

Camera User Guide

Flowchart and Reference Guides

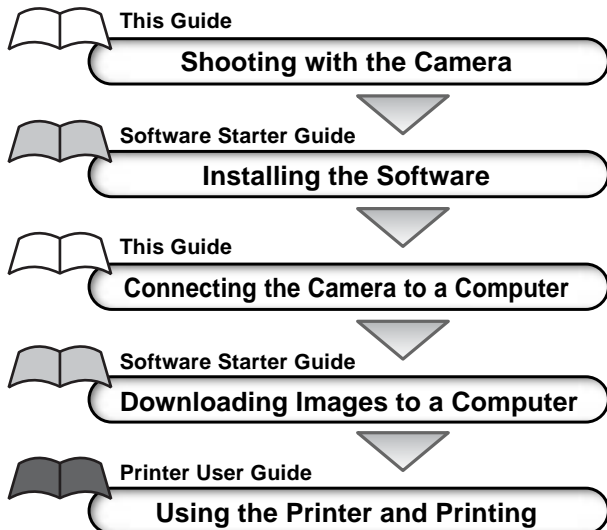

				P	Tv	Av	M	Reference Page
●	●	—	—	●	●	●	●	85
●*	●*	—	—	●*	●*	●*	●*	101
●	●	▲	●	●	●	●	—	99
●	●	●	●	●*	●*	●*	●*	103
—	—	—	—	●	●	●	●	108
●	●	▲	●	●	●	●	●	110
— ⁽⁵⁾	— ⁽⁵⁾	— ⁽⁵⁾	— ⁽⁵⁾	●	●	●	● ⁽⁶⁾	

This digital camera is designed to perform optimally when used with genuine Canon brand digital camera accessories (“Canon Brand Accessories”).

You may use non Canon Brand Accessories with this Digital Camera. However, Canon makes no warranties concerning, and is not responsible for damages resulting from, use of non Canon Brand Accessories.

Camera Body Temperature

If your camera is used for prolonged periods, the camera body may become warm. Please be aware of this and take care when operating the camera for an extended period.

About the LCD Monitor

The LCD monitor is produced with extremely high-precision manufacturing techniques. More than 99.99% of the pixels operate to specification. Less than 0.01% of the pixels may occasionally misfire or appear as red or black dots. This has no effect on the recorded image and does not constitute a malfunction.

Video Format

Please set the camera's video signal format to the one used in your region before using it with a TV monitor (p. 181).

Language Setting

Please see page 28 to change the language setting.

Please read through the "Read This First" section (p. 6) before using your camera.

Disclaimer







- While every effort has been made to ensure that the information contained in this guide is accurate and complete, no liability can be accepted for any errors or omissions.
- Canon Inc. reserves the right to change the specifications of the hardware and software described herein at any time without prior notice.
- No part of this guide may be reproduced, transmitted, transcribed, stored in a retrieval system, or translated into any language in any form, by any means, without the prior written permission of Canon Inc.
- Canon Inc. makes no warranties for damages resulting from corrupted or lost data due to a mistaken operation or malfunction of the camera, the software, the CompactFlash™ cards (CF cards), personal computers, peripheral devices, or use of non-Canon CF cards.

Trademark Acknowledgements

- Canon and PowerShot and Bubble Jet are trademarks of Canon, Inc.
- CompactFlash is a trademark of SanDisk Corporation.
- iBook and iMac are trademarks of Apple Computer, Inc.
- Macintosh, PowerBook, Power Macintosh and QuickTime are trademarks of Apple Computer, Inc, registered in the United States and other countries.
- Microsoft, Windows, and Windows NT are either registered trademarks or trademarks of Microsoft Corporation in the United States and/or other countries.
- Other names and products not mentioned above may be registered trademarks or trademarks of their respective companies.

About this Camera User Guide

Symbols Used

Icons under title bars show the operations mode. As in the example below, the mode dial should be set to **AUTO**, **P**, **Tv**, **Av**, **M**, , , , ,  or .

Using the Flash



: This mark denotes issues that may affect the camera's operation.



: This mark denotes additional topics that complement the basic operating procedures.

Question? Look here first.

- How do I navigate the menus?

Selecting Menus and Settings (p. 43)

- What settings are available under each function?
and

Will my settings remain in effect even after I've turned the camera off?

Functions Available in Each Shooting Mode (p. 224)

- How do I go about printing?

About Printing (p. 136)

- What functions are available through the menus?

FUNC. Menu (p. 172)

Rec. Menu (p. 174)

Replay Menu (p. 176)

Set up Menu (p. 178)

My Camera Menu (p. 181)

The above sections are shaded on the right edges to make them easy to find.

About the Thumb Index

A quick introduction intended for new users who want to shoot first and learn more later. Tells you how to get the camera running and how to begin shooting and playing back images.

Quick Start

Introduces you to all of the camera components, and explains how to load batteries and use the shutter button, among other basic functions. Also explains how to set the camera's start-up image, start-up sound and shutter sound.

**Preparing the Camera,
Basic Functions**

Describes shooting with the camera, from each shooting mode to using the camera's various shooting features.

Shooting

Explains how to review recorded images or select replay settings, how to protect images or erase them, and how to edit movies.

Replaying, Erasing

Explains how to print and make print settings, and how to select images for transferring to e-mail.

**Printing,
Transferring**

Explains how to transfer images to a computer. Also explains how you can connect the camera to a TV set for shooting and reviewing images. **You must read this section before connecting your camera to a computer.**





Connecting









Shows the menus and error messages at a glance. Also explains how to replace the date battery and how to use various accessories, such as the lenses and the AC adapter kit.

Appendix



Table of Contents

 : Functions and operations tables. These pages are shaded on the right edges to make them easy to find.



Read this First	6
Quick Start	14
Components Guide	16
Preparing the Camera	20
Installing the Batteries	20
Installing a CF Card	24
Setting the Date/Time	26
Setting the Language	28
Basic Functions	30
Turning the Power On	30
Switching between Shooting and Replaying	32
Using the LCD Monitor	33
Using the Viewfinder to Shoot	38
Pressing the Shutter Button	40
Using the Zoom (Focal Length)	42
Selecting Menus and Settings	43
Customizing the Camera (My Camera Settings)	52
Changing My Camera Settings	52
Registering My Camera Settings	55
Shooting-Letting the Camera Select Settings	60
 Auto Mode	60
Reviewing an Image Right After Shooting	62
Changing the Resolution and Compression	64
 Using the Flash	67
 Portrait Mode	70
 Landscape Mode	71

 Night Scene Mode	72
 Fast Shutter	73
 Slow Shutter	74
 Stitch Assist Mode	75
 Movie Mode	79
 Macro Mode	81
 Self-Timer	83
Digital Zoom	85
 Continuous Shooting	87

Shooting-Selecting Particular Effects 89

P Program AE	89
Tv Setting the Shutter Speed	91
Av Setting the Aperture	94
M Manually Setting the Shutter Speed and Aperture	96
Switching Between Autofocus Modes	98
Switching Between Light Metering Modes	99
 Adjusting the Exposure	101
WB Setting the White Balance	103
 Changing the Photo Effect	108
ISO Changing the ISO Speed	110
Adjusting the Flash Output	112
Shooting Problem Subjects for the Autofocus	113
Resetting the File Numbers	116

Replaying 118

Displaying Images Individually	118
 Magnifying Images	119
 Viewing Images in Sets of Nine (Index Replay)	120
JUMP Jumping Between Images	121
Viewing Movies	122
Editing Movies	124
Rotating Images in the Display	127
Attaching Sound Memos to Images	128
Auto Play	130

Protecting Images	131
Erasing	132
Erasing Images Individually	132
Erasing All Images	133
Formatting a CF Card	134
Printing	136
About Printing	136
Selecting from the Print Order Menu	138
Connecting the Camera to a Printer	140
Printing	144
Setting the Print Settings (Direct Print Function)	146
Print Settings (DPOF Print Settings)	154
Printing with DPOF Print Settings	160
Image Transfer Settings (DPOF Transfer Order)	163
Selecting Images for Transferring	163
Viewing Images on a TV Set	165
Downloading Images to a Computer	167
Connecting the Camera to a Computer	
Via the USB Cable	167
Downloading Directly from a CF Card	171
List of Menu Options and Messages	172
Function Menu	172
Rec. Menu	174
Replay Menu	176
Set up Menu	178
My Camera Menu	181
Resetting the Settings to Default	184
List of Messages	186

Appendices	191
Replacing the Date Battery	191
Using the Optional Battery Kits	193
Using the Optional Lenses and Lens Adapter	197
Camera Care and Maintenance	203
Troubleshooting	204
Specifications	211
Index	220
Functions Available in Each Shooting Mode	224

Read this First

Please Read

Test Shots

Before you try to photograph important subjects, we highly recommend that you shoot several trial images to confirm that the camera is operating and being operated correctly. Please note that Canon Inc., its subsidiaries and affiliates, and its distributors are not liable for any consequential damages arising from any malfunction of a camera or accessory, including CompactFlash™ cards, that results in the failure of an image to be recorded or to be recorded in a format that is machine sensible.

Warning Against Copyright Infringement

Please note that Canon digital cameras are intended for personal use and must be used in a manner that respects international and domestic copyright laws and regulations. Please be advised that in certain cases the copying of images from performances, exhibitions, or commercial properties by means of a camera or other device may contravene copyright or other legal rights even if the image was recorded for personal use.

Warranty Limitations

This camera's warranty is only effective in the country of sale. If a problem arises while the camera is in use abroad, please convey it back to the country of sale before proceeding with a warranty claim to a Canon Customer Support Help Desk.

For Canon Customer Support contacts, please see the Canon Limited Warranty supplied with your camera.

Safety Precautions

- Before using the camera, please ensure that you have read and understood the safety precautions described below. Always ensure that the camera is operated correctly.
- The safety precautions noted on the following pages are intended to instruct you in the safe and correct operation of the camera and its accessories to prevent injuries or damage to yourself, other persons and equipment.
- In the next few pages, the term “equipment” refers primarily to the camera, its power supply accessories and an optional compact power adapter.

WARNINGS

- **Do not aim the camera directly into the sun or at other intense light sources which could damage your eyesight.**
- **Do not trigger the flash in close proximity to human or animal eyes.** Exposure to the intense light produced by the flash may damage eyesight. In particular, remain at least one meter (39 inches) away from infants when using the flash.
- **Store this equipment out of the reach of children and infants.** Accidental damage to the camera or batteries by a child could result in serious injury. In addition, placement of the strap around a child's neck could result in asphyxiation.
- **Be particularly careful to keep the date battery used in the camera away from children.** Seek medical assistance immediately if a child swallows a battery.
- **Do not attempt to disassemble or alter any part of the equipment that is not expressly described in this guide.** Disassembly or alteration may result in high-voltage electrical shock. Internal inspections, alterations and repairs should be conducted by qualified service personnel authorized by your camera distributor or a Canon Customer Support Help Desk.
- **To avoid the risk of high-voltage electrical shock, do not touch the flash portion of the camera if it has been damaged.** Similarly, never touch internal portions of the equipment that become exposed as a result of damage. There is a risk of high-voltage electrical shock. Please take the first opportunity to consult your camera distributor or a Canon Customer Support Help Desk.
- **Stop operating the equipment immediately if it emits smoke or noxious fumes. Failure to do so may result in fire or electrical shock.** Immediately turn the camera's power off, remove the camera batteries and unplug the power cord from the Power outlet. Confirm that smoke or fume emissions have ceased. Please consult your camera distributor or the closest Canon Customer Support Help Desk.

-
- **Stop operating the equipment if it is dropped or the casing is damaged.** Failure to do so may result in fire or electrical shock. **Immediately turn the camera's power off, remove the camera batteries or unplug the power cord from the Power outlet.** Please consult your camera distributor or the closest Canon Customer Support Help Desk.
-
- **Do not allow the equipment to come into contact with, or become immersed in, water or other liquids.** Do not allow liquids to enter the interior. The camera has not been waterproofed. If the exterior comes into contact with liquids or salt air, wipe it dry with a soft, absorbent cloth. In the event that water or other foreign substances enter the interior, immediately turn the camera's power off and remove the camera batteries or unplug the power cord from the electrical outlet. Continued use of the equipment may result in fire or electrical shock. Please consult your camera distributor or the closest Canon Customer Support Help Desk.
-
- **Do not use substances containing alcohol, benzene, thinners or other flammable substances to clean or maintain the equipment.** The use of these substances may lead to fire.
-
- **Remove the power cord on a regular periodic basis and wipe away the dust and dirt that collects on the plug, the exterior of the electrical outlet and the surrounding area.** In dusty, humid or greasy environments, the dust that collects around the plug over long periods of time may become saturated with humidity and short-circuit, leading to fire.
-
- **Do not cut, damage, alter or place heavy items on the power adapter cord.** Any of these actions may cause an electrical short circuit, which may lead to fire or electrical shock.
-
- **Do not handle the power cord if your hands are wet.** Handling it with wet hands may lead to electrical shock. When unplugging the cord, ensure that you hold the solid portion of the plug. Pulling on the flexible portion of the cord may damage or expose the wire and insulation, creating the potential for fires or electrical shocks.
-

-
- **Use of power sources not expressly recommended for this equipment may lead to overheating, distortion of the equipment, fire, electrical shock or other hazards.** Use only the recommended power accessories.
-
- **Do not place the batteries near a heat source or expose them to direct flame or heat.** Neither should you immerse them in water. Such exposure may damage the batteries and lead to the leakage of corrosive liquids, fire, electrical shock, explosion or serious injury.
-
- **Do not attempt to disassemble, alter or apply heat to the batteries.** There is serious risk of injury due to an explosion. Immediately flush with water any area of the body, including the eyes and mouth, or clothing, that comes into contact with the inner contents of a battery. If the eyes or mouth contact these substances, immediately flush with water and seek medical assistance.
-
- **Avoid dropping or subjecting the batteries to severe impacts that could damage the casings.** It could lead to leakage and injury.
-
- **Do not short-circuit the battery terminals with metallic objects, such as key holders.** It could lead to overheating, burns and other injuries.
-
- **Before you discard a battery, cover the terminals with tape or other insulators to prevent direct contact with other objects.** Contact with the metallic components of other materials in waste containers may lead to fire or explosions. Discard the batteries in specialized waste facilities if available in your area.
-
- **Use of batteries not expressly recommended for this equipment may cause explosions or leaks, resulting in fire, injury and damage to the surroundings.** Use only recommended batteries and accessories.
-
- **If using AA-size NiMH batteries, use only Canon AA-size NiMH batteries and charger recommended for use with these batteries.** Use of another charger may cause batteries to overheat or deform, posing risk of fire or electric shock.
-

-
- **Disconnect the battery charger or the compact power adapter from both the camera and power outlet after recharging and when the camera is not in use to avoid fires and other hazards.**
 - **The camera terminal of the battery charger cord and the compact power cord is designed for exclusive use with your camera.** Do not use it with other products or batteries. There is a risk of fire and other hazards.
 - **Exercise due caution when screwing on the separately sold wide converter, tele-converter, close-up lens and conversion lens adapter.** If they loosen, fall off and shatter, the glass shards may cause an injury. Never aim the lenses at the sun or strong light sources. There is a risk of damage to eyesight.
-

CAUTIONS

-
- **Avoid using, placing or storing the equipment in places subject to strong sunlight or high temperatures, such as the dashboard or trunk (boot) of a car.** Exposure to intense sunlight and heat may cause the batteries to leak, overheat or explode, resulting in fire, burns or other injuries. High temperatures may also cause deformation of the casing. Ensure that there is good ventilation when using the compact power adapter to charge the battery pack or power the camera.
 - **Do not store the equipment in humid or dusty areas.** Storage in such areas could lead to fire, electrical shock or other damage.
 - **Be careful not to bang the camera or subject it to strong impacts or shocks that could lead to injury or damage the equipment when wearing or holding it by the strap.**
 - **Be careful not to cover the flash with your fingers when shooting.** In addition, do not touch the surface of the flash after taking several pictures in rapid succession. Either action could result in burns.
-

-
- **Do not operate the flash with dirt, dust or other items stuck to its lens.** The resulting heat build-up could damage the flash.
 - **If your camera is used for prolonged periods, the camera body may become warm.** Please take care when operating the camera for an extended period as your hands may experience a burning sensation.
-

Preventing Malfunctions

Avoid Strong Magnetic Fields

Never place the camera in close proximity to electric motors or other equipment generating strong electromagnetic fields. Exposure to strong magnetic fields may cause malfunctions or corrupt image data.

Avoid Condensation Related Problems

Moving the equipment rapidly between hot and cold temperatures may cause condensation (water droplets) to form on its external and internal surfaces. You can avoid this by placing the equipment in an airtight, resealable plastic bag and letting it adjust to temperature changes slowly before removing it from the bag.

If Condensation Forms Inside the Camera

Stop using the camera immediately if you detect condensation. Continued use may damage the equipment. Remove the CF card and battery or power cord (if connected) from the camera and wait until the moisture evaporates completely before resuming use.

Extended Storage

When not using the camera for extended periods of time, remove the battery from the camera or battery charger and store the equipment in a safe place. Storing the camera for extended periods with batteries installed will run down the battery and may damage the camera.

Quick Start

1 Install the batteries (p. 20).

Slide the battery cover lock, then open the cover and insert the batteries.

- For important information about batteries, see *Proper Battery Handling* (p. 21).

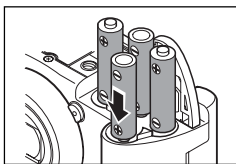

2 Install the CF card (p. 24).

Open the CF card slot cover and insert a CF card. Push the CF card all the way into the slot, so that the CF card eject button pops all the way out.

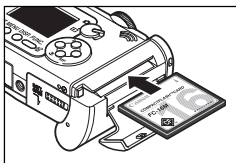

3 Press the ON/OFF button to turn the camera on (p. 30).

Hold the ON/OFF button down until the indicator next to the viewfinder starts blinking green.

- If the LCD monitor displays the Set Date/Time menu, set the date and time (p. 26).
- For information about how to change the language, see *Setting the Language* (p. 28).

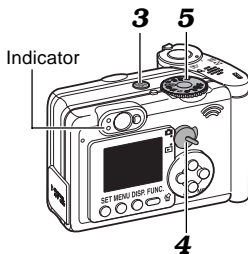

4 Set the mode switch to (Shooting) (p. 32).

5 Turn the mode dial to **AUTO** (p. 60).



6 Focus (p. 40).

Aim the camera at the subject, and lightly press and hold the shutter button halfway down. The camera beeps twice when the focus is set.

7 Shoot (p. 40).

Press the shutter button all the way. You will hear the sound of the shutter close when the shot is complete.

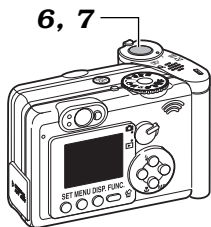

8 View the recorded image.

The recorded image displays on the LCD monitor for approximately 2 seconds (p. 62).

For information about how to view other images that you

have already taken, see *Replaying* (p. 118).



.....

To Immediately Erase the Displayed Image

- 1 Press the  button while the image is displayed.
- 2 Confirm that [Erase] is selected and press the **SET** button.



Components Guide

Zoom Lever (p. 42, 85, 118, 119)

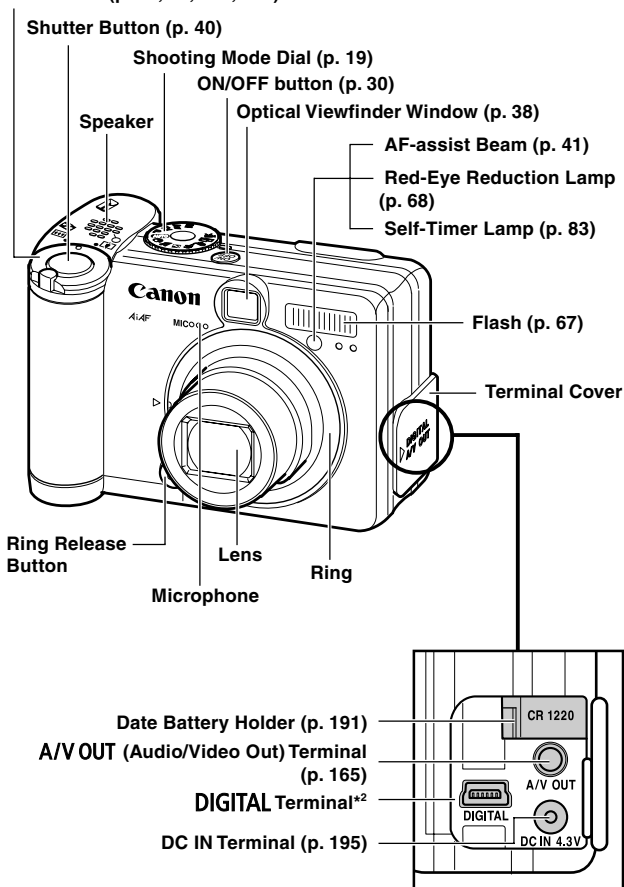

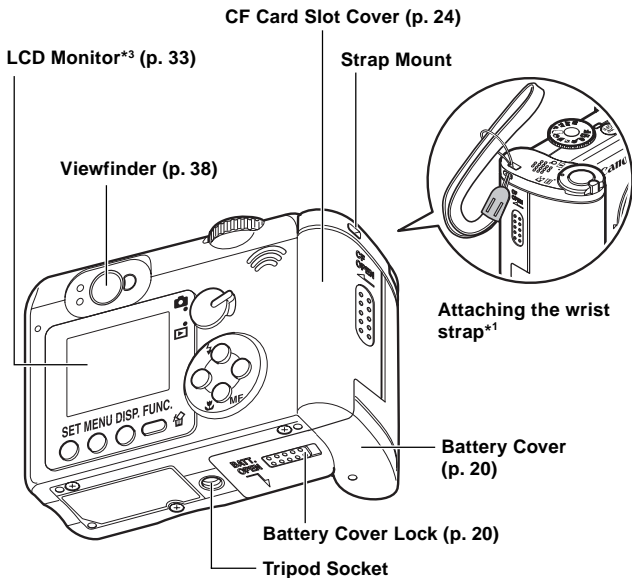

*1 Be careful not to wave the camera about or catch it on other items when dangling it from the wrist strap.

*2 To connect the camera to a computer or printer, use one of the following cables.

- **Computer:** USB Interface Cable IFC-300PCU (supplied with this camera)
- **Direct Print Compatible Printer (CP series, optional):** Direct Interface Cable DIF-100 (supplied with Direct Print compatible printers)
- **Bubble Jet Printer with the direct print function (optional):** Please refer to the Bubble Jet Printer user guide.

Please refer to your *System Map* to find out which direct print function compatible printer can be used with this camera.

*3 The LCD monitor is covered with a thin plastic sheet for protection against scratches during shipment. Remove it before using the camera.

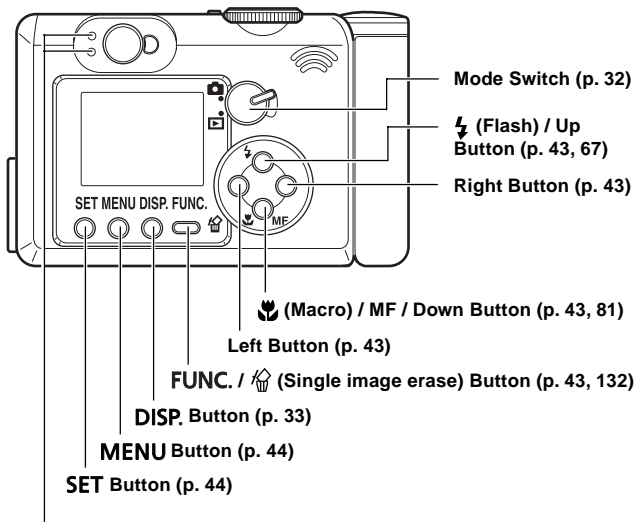

Indicators

The indicators light or blink when the ON/OFF button or the shutter button is pressed.

Upper Indicator

- | | |
|------------------|--|
| Green: | Ready to record / Ready to communicate (during a computer connection) |
| Blinking Green: | Starting up / Recording to CF card / Reading CF card / Erasing from CF card / Transmitting data (during a computer connection) |
| Orange: | Ready to record (flash on) |
| Blinking Orange: | Ready to record (camera shake warning) |

Lower Indicator

- | | |
|------------------|--|
| Yellow: | Macro mode / Manual focus mode |
| Flashing Yellow: | Focusing difficulty (although you can press the shutter button, try using focus lock or adjusting the focus manually, p.113) |

Shooting Mode Dial

Use the shooting mode dial to select a Shooting mode.

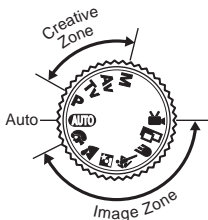







- **AUTO** : Auto (p. 60)

The camera automatically selects settings.

- **Image Zone**

The camera automatically selects settings according to the image composition type.

-  : Portrait (p. 70)
-  : Landscape (p. 71)
-  : Night Scene (p. 72)
-  : Fast Shutter Speed (p. 73)
-  : Slow Shutter Speed (p. 74)
-  : Stitch Assist (p. 75)
-  : Movie (p. 79)

- **Creative Zone**

The user selects exposure, aperture or other settings to achieve special effects.

- P** : Program AE (p. 89)
- Tv** : Shutter Speed-Priority AE (p. 91)
- Av** : Aperture-Priority AE (p. 94)
- M** : Manual Exposure (p. 96)

Preparing the Camera

Installing the Batteries

The camera uses four AA-size alkaline batteries supplied with the camera. You may use optional nickel metal hydride (NiMH) batteries.

- 1** Be sure that the camera power is off.
- 2** Slide the battery cover lock in the direction of the arrow, and push the battery cover slightly forward. Then open the cover.

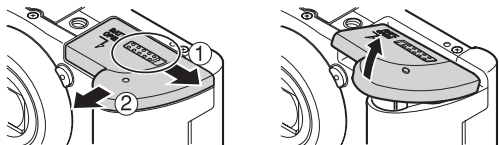

- 3** Insert the batteries as shown.

Positive end (+)

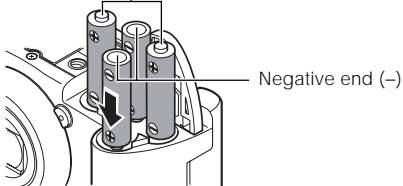

- 4** Close the battery cover.

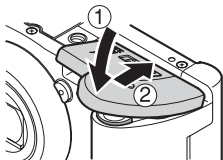



When the camera's indicator blinks green, do not turn off the power or open the battery cover. The camera is writing, reading, erasing or transmitting an image to or from the CF card.



- We recommend that you use the optional AC Adapter Kit ACK600 to power the camera during long usage sessions (p. 195).
- The optional battery charger kit lets you use rechargeable NiMH batteries to power the camera (p. 193).
- For important information, see *Battery Performance* (p. 214).
- For information about the Battery and Charger Kit and AA-size rechargeable NiMH batteries, see the *System Map* (separate from this guide).

Proper Battery Handling

- Use AA-size alkaline or Canon AA-size NiMH batteries only. For information on handling the AA-size rechargeable NiMH batteries, see *Using the Optional Battery Kits* (p. 193).
- Never use manganese or lithium batteries, as these battery types may overheat in the camera.
- Since the performance of alkaline batteries may differ according to brand, the operating time of the batteries you purchase may not be as long as the batteries that came with the camera.
- Camera operating time may shorten at low temperatures when alkaline batteries are used. Also due to their specifications, alkaline batteries may expire faster than NiMH batteries. If you are using the camera in cold areas or for a long time, we recommend using Canon AA-size NiMH Battery Kit (a four-piece set).
- While it is possible to use AA-size nickel-cadmium batteries, performance is unreliable and their use is not recommended.
- **Never mix unused and partially used batteries. Always load four fresh (or fully recharged) batteries at the same time.**

- **Be careful to load the batteries with their positive (+) and negative (-) ends in the right direction.**
- **Never mix batteries of different types or from different manufacturers. All four batteries should be identical.**
- Before inserting the batteries, wipe the battery terminals well with a dry cloth. Oil from one's skin or other dirt may cause a considerable reduction in the number of recordable images or reduced usage time.
- Battery performance deteriorates at low temperatures (especially with alkaline batteries). If you are using the camera in cold areas and batteries are running down faster than they should, you may be able to restore performance by placing batteries in an inner pocket to warm them up prior to use. But be careful that you don't put the batteries into a pocket together with a metal key chain or other metallic objects, as these objects may cause batteries to short-circuit.
- If you do not plan to use the camera for a long time, remove the batteries from the camera and store them in a safe place. Batteries may leak and damage the camera if left installed during prolonged periods of non-use.

⚠ WARNING

Never use damaged batteries or batteries whose outer seal is completely or partially missing or peeled off, as there is risk that such batteries may leak, overheat, or burst. Always check the seals on store-bought batteries before loading them, as some batteries may come with defective seals. Do not use batteries with defective seals.

Never use batteries that look like this.



Batteries with all or part of the seal (electrical insulation sheath) peeled off.





The positive electrode (plus terminal) is flat.



The negative terminal is correctly formed (protruding from the metal base), but the seal does not extend up over the edge of the metal base.

Battery Status Indications

The LCD monitor displays an icon or message to let you know when batteries are low or depleted.

	Batteries are beginning to run low. Replace (or recharge) batteries promptly. If the LCD monitor is off, this icon will appear when you press any of the following buttons: DISP.  or  / MF .
Change the batteries	Batteries are fully depleted and the camera can no longer operate. You should replace the batteries immediately.

Installing a CF Card

1 Be sure that the camera is turned off.

2 Slide the CF card slot cover in the direction of the arrow, and open it.

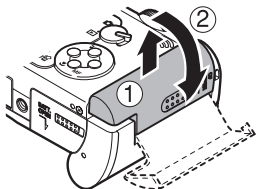

3 Insert the CF card with the label facing out and the arrow pointing in.

- Insert the CF card all the way into the slot, so that the CF card eject button pops all the way out.

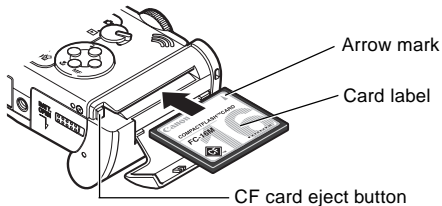

- To remove the CF card, press the CF card eject button.

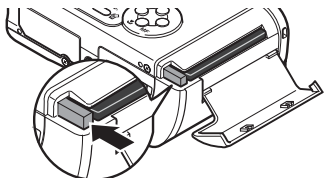

4 Close the CF card slot cover securely.



- When the indicator on the left side of the viewfinder blinks green, the camera is writing, reading, erasing or transmitting an image to or from the card. Do not perform the following, for image data may be lost or corrupted:
 - Do not shake the camera.
 - Do not turn off the power or open the CF card slot cover.
- Be aware that use of CF cards whose contents have been edited at another camera or with another company's software may cause the camera to operate incorrectly.



For more information on CF cards, see *CF Cards and Estimated Capacities (Recordable Images)* (p. 215).

About CF Cards...

- CF cards are high-precision electronic devices. Do not bend them, apply force to them, or subject them to shocks or vibration.
- Do not attempt to disassemble or alter a CF card.
- Moving a CF card rapidly between temperature extremes will cause condensation to form in the card and lead to a malfunction. To avoid condensation, place the CF card in a sealed plastic bag before moving it into a different temperature zone and allow it to adjust slowly to the new temperature. If condensation forms on the CF card, store it at room temperature until the water droplets have evaporated naturally.
- Do not use or store CF cards in the following types of location.
 - Locations subject to dust or sand
 - Locations subject to high humidity and high temperatures

Setting the Date/Time

The Set Date/Time menu will appear when the camera is first turned on or the date battery has run down. Replace the date battery, then reset the date and time starting from step 5 below.

1 Press the **ON/OFF** button to turn on the camera (p. 30).

2 Press the **MENU** button.

The [ (Rec.)] or [ (Replay)] menu appears.



[ (Rec.)] menu shown

3 Select the [ (Set up)] menu using the left or right button.



- 4** Press the up or down button to select  (Date / Time), and then press the **SET** button.



- 5** Set the date and time.

- Use the up or down button to change the value of the highlighted field.
- Press the left or right button to highlight another field.
- The date can be set up to the year 2030.



- 6** Press the **SET** button.

After adjusting the settings, press the **MENU** button to close the menu window.





- The Date/Time cannot be inserted in the actual image even if the Date/Time have been set.
- For printing images with the date on them, refer to page 146.
- For information on how to replace the date battery, refer to page 191.

Setting the Language

Use this feature to select the language for the LCD monitor display.

1 Press the **ON/OFF** button to turn on the camera (p. 30).

2 Press the **MENU** button.

The [ (Rec.)] or [ (Replay)] Menu will display.



[ (Rec.)] menu shown

3 Select the [ (Set up)] menu using the left or right button.

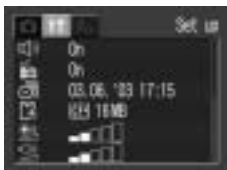

- 4** Select  (Languages) using the up or down button and press the **SET** button.



- 5** Select a language using the up, down, left or right button.



- 6** Press the **SET** button.

After adjusting the settings, press the **MENU** button.



.....

In replay mode, you can change the language by holding the **SET** button while you press the **MENU** button. (This function cannot be used while an optional direct print function compatible printer (CP series) or the direct print function compatible Bubble Jet Printer is connected to the camera, or while replaying movies.)

.....

Basic Functions

Turning the Power On

- 1** Press the ON/OFF button until the green indicator begins blinking.

Shooting Mode

Current shooting settings will appear in the LCD monitor for about 6 seconds.



.....
If you turn the mode switch to , the lens will retract after approximately 1 minute.
.....

Replaying mode

The LCD monitor displays an image.

Turning the Camera Off

Press the ON/OFF button again to turn the power off.



- You will hear a start-up sound and see the start-up image when the power comes on. (To change the start-up sound and image, see below and pages 52 and 181.)
- The start-up image does not appear when the LCD monitor is off or the **A/VIDEO** terminal is connected to a TV.

Turning on the camera without the start-up sound and image

Press and hold the **SET** button, then turn on the power.

Power-saving Function

When the camera's power-saving function is turned on and it activates, restore power by pressing the ON/OFF button.

Shooting Mode

The power will automatically shut off approximately 3 minutes after the last function is accessed. Even if the power-saving function is turned off, the LCD monitor will shut off approximately 3 minutes after the last function is accessed. Press any button other than the ON/OFF button to restore the LCD monitor.

Replay Mode

The power will automatically shut off approximately 5 minutes after the last function is accessed.

While Connected to a Printer

The power will automatically shut off approximately 5 minutes after the last camera function is accessed or printer (sold separately) ceases to print an image.

- The power-saving function will not activate while the camera is in auto play mode or during a computer connection (p. 130, 167).
- You can turn off the power-saving function in the [ (Set up)] menu (p. 178).

Switching between Shooting and Replaying

You can quickly switch between Shooting mode and Replaying mode. This is convenient when you wish to shoot again after checking or deleting an image immediately after it is shot.

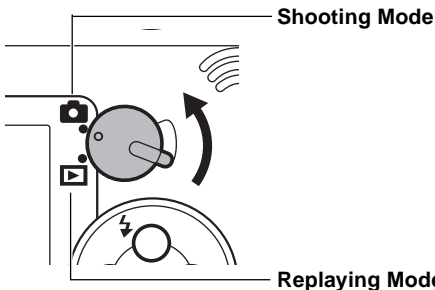

Replaying Mode
The lens does not retract right away when the camera switches to Replaying mode.

Using the LCD Monitor

The LCD monitor can be used to compose images while shooting, adjust settings menus and replay images.



The image in the LCD monitor may darken when the monitor is used under sunlight or other strong lighting. This is not a defect.

Shooting Mode

Pressing the **DISP.** button cycles the LCD monitor to the next mode each time the button is pressed.

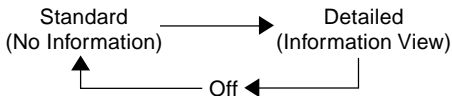

- The on/off setting of the LCD monitor display mode is memorized when the camera is turned off. When the camera is turned on again it assumes the last mode. However, when the LCD monitor is turned on and the “Change the Battery Pack” message appears, the LCD monitor may not automatically turn on the next time the camera is started.
- When the LCD monitor is set to Standard or Off, shooting information appears for approximately 6 seconds (The shooting information may not appear depending on the setting contents of the camera at that moment.)
- Setting the mode dial to or modes turns the LCD monitor on regardless of whether it is set to on or off.



Set the flash to on or affix the camera to a tripod when the upper indicator blinks orange and the camera shake warning icon () appears in the LCD monitor after the metering preparations are complete.

Replaying Mode

- The LCD monitor always comes on when you turn the mode switch to .
- Pressing the **DISP.** button cycles the information view mode each time the button is pressed.

Single Image Replay

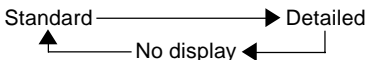

Index Replay (9 images)



Information Displayed on the LCD Monitor

The LCD monitor displays information in Shooting or Replaying mode, such as the camera settings, remaining image capacity and shooting date / time.

Shooting Mode

The following displays in information view.

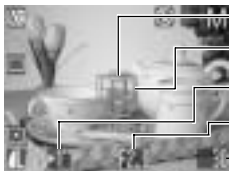

- AF Frame
- Spot AE Point Frame
- Shutter Speed
- Aperture Setting
- Recordable Images or Recordable Movie Time (sec.)

	Shooting Mode	p. 19
-2 ... +2	Exposure Compensation	p. 101
	White Balance	p. 103
	Drive Mode	p. 83/87
	ISO Speed	p. 110
	Photo Effects	p. 108
	Light Metering Mode	p. 99
	Compression	p. 64
(PowerShot A70) L M1 M2 S (PowerShot A60) L M S	Resolution	p. 64
	Flash	p. 67
	Red-Eye Reduction	p. 68
	Macro Mode	p. 81
MF	Manual Focus	p. 115
● (red)	Movie Recording Mode	p. 79
(PowerShot A70) 3.8× 4.8× 6.0× 7.4× 9.6× (PowerShot A60) 3.8× 4.7× 6.0× 7.5×	Digital Zoom Setting*	p. 85
	Camera Shake Warning	p. 34
	Low Battery	p. 23





- The icons in the shaded boxes above appear even when the information view is turned off.
- In addition to the above, the AF frame, spot light metering frame (**P**, **Av** and **Tv** mode), shutter speed, aperture setting (**Av**, **Tv** and **M** mode), recordable images or recordable movie time are displayed as in the example to the left.

* Zoom powers reflect the combined optical and digital zoom effects. These figures appear when the digital zoom is activated.

Replaying Mode

In simple display mode, the following information appears.



	Compression	p. 64
(PowerShot A70) L M1 M2 S (PowerShot A60) L M S	Resolution (Still images)	p. 64
	Sound memo (wave file)	p. 128
	Movie	p. 122
	Protection Status	p. 131

In detailed display mode, the following information appears.

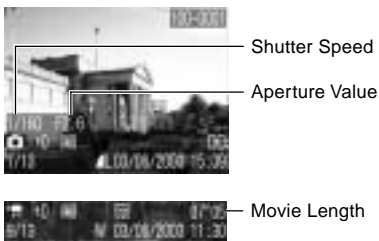

	Shooting Mode	p. 19
-2 ... ±0 ... +2	Exposure Compensation	p. 101
	White Balance	p. 103
	Photo Effects	p. 108
	ISO Speed	p. 110
	Flash	p. 67
	Macro Mode	p. 81
MF	Manual Focus	p. 115
	Light Metering Mode	p. 99
PowerShot A70 PowerShot A60 	Resolution (Movies)	p. 64

In addition to the above, the shutter speed, aperture setting and recorded movie time are displayed as in the example on the previous page.

The following information may also appear with some image files.

	An audio file other than a wave file, or a file with an unrecognized format, is attached.
	A JPEG file not supported by "Design rule for Camera File system" (DCF) standards.
RAW	RAW format file
	A file with an unrecognized format.



.....

Please note that image information recorded by this camera may not display correctly on other cameras and image information recorded by other cameras may not display correctly on this camera.

.....

Using the Viewfinder to Shoot

Setting the LCD monitor to Off (p. 33) and using the optical viewfinder can help conserve power while shooting.

- 1** Align the square brackets (autofocus metering field) inside the viewfinder on the primary subject to compose the image.

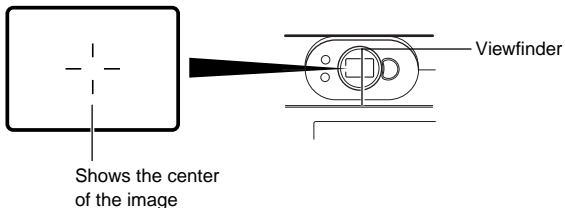



.....

About the Autofocus Function

This camera employs AiAF (artificial intelligence autofocus) technology which uses a broad metering field to calculate the focal distance with high precision. It delivers a crisp focus even when the photographic subject is slightly off-center.

Image Seen in Viewfinder vs. Recorded Image

Please note that the actual image may differ from the image seen in the optical viewfinder due to the physical separation between the viewfinder and lens. This is called the parallax phenomenon and is more noticeable the closer the subject is to the lens. In some cases, portions of images shot up close that appear in the viewfinder will not appear in the recorded image. Please use the LCD monitor to shoot images up close.

.....

Pressing the Shutter Button

The shutter button features a two-stage action.

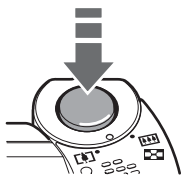

Pressing Halfway

Pressing halfway automatically sets the exposure, focus and white balance.

The indicators light or blink as follows.

Upper Indicator

- Green: Metering complete (two beeps sound)
- Orange: Flash will fire
- Blinking Orange: Camera shake warning / Insufficient exposure

Lower Indicator

- Yellow: Macro Mode / Manual Focus
- Blinking Yellow: Focusing difficulty* (single beep sounds)

* When the indicator blinks yellow, lock the focus before shooting (p. 113).



The AF frame appears as follows when the LCD monitor is on.

- Green: Metering complete
- Yellow: Focusing difficulty (When AiAF is turned on (p. 98))



Pressing Fully

Pressing fully releases the shutter.

- You will hear the shutter sound when the shot is complete. Do not move the camera until you hear this sound.
- The upper indicator blinks green while the image is recording onto the CF card.



- If the orange or yellow indicator blinks while you press halfway, you can still press fully to take the shot.
- Images are first saved into the camera's internal memory before being recorded onto the CF card, allowing the next images to be taken immediately as long as sufficient space is available in the internal memory.
- The beep and shutter sound can be set On / Off in the Set up menu (p. 178).
- When the shutter sound is set to Off, but the beep is set to On, one beep will sound when the shutter button is fully pressed.
- There is no shutter sound in movie mode.
- Shots cannot be taken while the flash is charging.

AF-Assist Beam

- The AF-assist beam will sometimes emit when the shutter button is pressed halfway to assist focusing in certain conditions, i.e. dark conditions.
- The AF-assist beam can be turned off (p. 175).
If animals are your subject, turn off the beam when shooting in the dark to avoid startling them. However, please keep in mind the following facts.
 - Turning the AF-assist beam off may make it more difficult for the camera to focus.
 - The red-eye reduction lamp may emit when you press the shutter button halfway even if the AF-assist beam is turned off.

In order to prevent any lamp from emitting before the flash fires, set both the red-eye reduction function and the AF-assist beam to [Off] in the Shooting menu.

Using the Zoom (Focal Length)

The zoom can be adjusted to any setting in the 35 to 105 mm range in 35 mm film equivalent terms.

Telephoto/Wide Angle

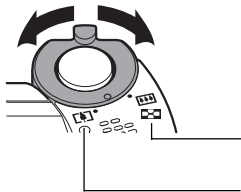

 : Press the zoom lever left to zoom out for a wide-angle shot.

 : Press the zoom lever right to zoom in for a telephoto shot.

Digital Zoom

When the LCD monitor is on, you can digitally zoom in on a subject with the zoom button. Images can be zoomed up to approx. 9.6 times (PowerShot A70), or 7.5 times (PowerShot A60), which combines the effect of the optical zoom (p. 85).



.....
Digital zoom is unavailable in some modes (p. 224).



.....
Note that the image appears grainier, the more the image is digitally zoomed.
.....

Selecting Menu and Settings

Menus are used to adjust shooting, replaying, date / time and electronic sound settings. Menus can be displayed by either pressing the **FUNC.** button or the **MENU** button. Watch the LCD monitor while performing the following procedures.

Selecting Settings by Pressing the FUNC. Button (Only in Shooting Mode)

1 Press the FUNC. button.



- Icons of the selectable settings appear on the left side of the LCD monitor.
- The current settings icons appear.

2 Select a menu item using the up or down button.

3 Select setting contents using the left or right button.

Some menu items can only be selected after pressing the **SET** button and displaying the next menu. Press the **SET** button again to confirm the setting.



4 Press the FUNC. button.

- The menu closes.
- Images can be shot immediately with the selected settings after Step 3 by pressing the shutter button.



Selecting Settings by Pressing the MENU Button

1 Press the MENU button.

In Shooting mode, the [ (Rec.)] menu appears. In Replaying mode, the [ (Replay)] menu appears.

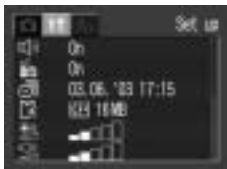
2 Switch between menu tabs using the left or right button.



- The menu switches as follows:
[ (Rec.)] or [ (Replay)] ↔ [ (Set up)] ↔ [(My Camera)]
- Pressing the zoom lever also switches between the menu tabs.

3 Select a menu item using the up or down button.



4 Select setting contents using the left or right button.

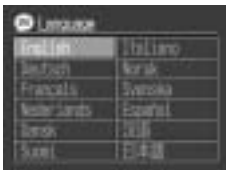

- Press the **SET** button for items followed by an ellipsis (...) then select a setting. Press the **SET** button again to confirm the setting.
- The items followed by and ellipsis (...) can also be selected by using the left and right buttons as well as the up and down buttons.

5 Press the **MENU** button.

- The menu closes.
- In Shooting mode, the menu can be closed by pressing the shutter button halfway.

Selecting Menu and Settings (continued)

Displaying a MENU

Switching

Shooting Mode



FUNC.



FUNC. Menu

Shooting Mode



MENU



Rec. Menu*
Selectable items
vary according to
each mode.

Replaying Mode



MENU

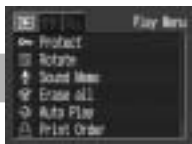

Replay Menu*

between Menus

Setting
Options

Completing
the Procedure



Set up Menu*



My Camera
Menu*



SET

MENU

* Use the zoom lever to switch between menus anytime.

Preparing the Camera, Basic Functions

Menu Settings and Default Settings















This chart shows the options for each menu and the default settings.

FUNC. button

Menu Item	Available Settings	Reference Page
Exposure Compensation	-2 to +2	101
Flash Output	Low / Medium / Strong*	112
White Balance	AWB* / / / / / / /	103
Drive Mode	* / / /	83, 87
ISO Speed	AUTO / 50* / 100 / 200 / 400	110
Photo Effect	* / / / / / /	108
Light Metering System	Evaluative Metering* / Center-Weighted Averaging/Spot Metering	99
Resolution, File Format, Compression	(Still picture) (PowerShot A70) L* / M1 / M2 / S (PowerShot A60) L* / M / S (Movie) (PowerShot A70) / * / (PowerShot A60) * / (Compression) / * /	64

* Default setting

MENU button

	Menu Item	Available Settings	Reference Page
 Rec. Menu (Red)	 AiAF	On*/Off	98
	 Red-eye	On*/ Off	68
	 AF-assist Beam	On*/ Off	175
	 Digital Zoom	On / Off*	85
	 Review	Off / 2* to 10 sec.	63
 Replay Menu (Blue)	 Protect	Turns image protection on and off	131
	 Rotate	Rotates the image in the display	127
	 Sound Memo	Adds sound memos to images	128
	 Erase all	Erases all images on the CF card	133
	 Auto Play	Replays selected images in a slide show	130
	 Print Order	Sets the print settings	154
	 Transfer Order	Sets the transfer settings	163

* Default setting

	Menu Item	Available Settings	Reference Page
Set up Menu (Yellow)	Beep	On* / Off	178
	Auto Power Down	On* / Off	178
	Date/Time	Sets the date and time	26
	Format	Formats the CF card	134
	Shutter Volume	Off / 1 / 2* / 3 / 4 / 5	179
	Playback Vol.	Off / 1 / 2* / 3 / 4 / 5	179
	Start-up Vol.	Off / 1 / 2* / 3 / 4 / 5	179
	Operation Vol.	Off / 1 / 2* / 3 / 4 / 5	179
	Selftimer Vol.	Off / 1 / 2* / 3 / 4 / 5	180
	File No. Reset	On / Off*	116
	Distance Units	m/cm* / ft/in	180
	Language	English* / Deutsch / Français / Nederlands / Dansk / Suomi / Italiano / Norsk / Svenska / Español / Chinese / Japanese	28
	Video System	NTSC* / PAL	181
My Camera Menu (Purple)	Theme	/ 1 * / /	52, 181
	Start-up Image	/ 1 * / /	52, 182
	Start-up Sound	/ 1 * / /	52, 182
	Operation Sound	/ 1 * / /	52, 182
	Selftimer Sound	/ 1 * / /	52, 182
	Shutter Sound	/ 1 * / /	52, 183

* Default values. Default video system settings vary between regions.

- Some menu items are not available in certain Shooting modes (p. 224).
- You can apply a desired image and sound to **[2]** and **[3]** in the My Camera menu. For details, see *Registering My Camera Settings* (p. 55) or the *Software Starter Guide*.
- The default of the settings changed by the menu and button operations except for [Date/Time], [Language] and [Video System] can be restored all at once (p. 184).

Customizing the Camera (My Camera Settings)

My Camera allows you to customize the start-up image and start-up, shutter, operation and self-timer sounds. Each menu item has three choices.

e.g. Start-up image



[1]

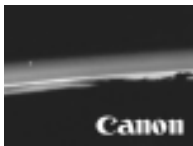

[2]

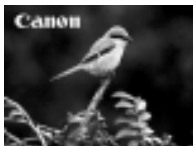

[3]

As default settings, My Camera setting [2] has a science fiction theme and My Camera setting [3] has an animal theme.

Changing My Camera Settings

1 Turn on the camera (p. 24).

2 Press the **MENU** button.



The [ (Rec.)] or [ (Replay)] menu appears.

- 3** Select the [ (My Camera)] menu using the left or right button.

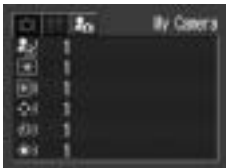





- 4** Select a menu item using the up or down button.

- 5** Select setting content using the left or right button.





- 6** Press the **MENU** button.
- Pressing the **MENU** button closes the menu and makes the settings take effect.
 - In Shooting mode, the menu can be closed by pressing the shutter button halfway.



- If you select [Theme] in Step 4, you can select a consistent theme for each of the My Camera settings.
- If  (Beep) in the [ (Set up)] menu is set to [On], the beep sounds even if each sound item such as [Start-up Sound], [Operation Sound], [Selftimer Sound] and [Shutter Sound] in the [ (My Camera)] menu is set to [ (Off)] (p. 178).

Registering My Camera Settings

Images recorded onto the CF card and newly recorded sounds can be added as My Camera settings to the [] and [] menu items. You can also use the supplied software to upload your computer's images and sounds to the camera.

The following menu items can be saved to the camera.

- Start-up Image
- Operation Sound
- Shutter Sound
- Start-up Sound
- Selftimer Sound

Registering CF Card Images and Sounds

1 Turn on the camera (p. 30).

2 Set the mode switch to .

The camera switches to Replaying mode.

3 Press the **MENU** button.

The [] (Replay) menu appears.



- 4** Select the [ (My Camera)] menu using the right button.

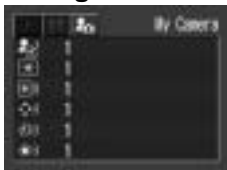

- 5** Select the menu item you wish to register using the up or down button.

- 6** Select  or  using the right or left button.

  appears.



- 7** Press the **DISP.** button.

An image appears.



[Start-up Image] → Step 8a, 9a
[Start-up Sound], [Shutter Sound], [Selftimer Sound] → Step 8b, 9b

8a Select the image you wish to register using the left or right button.



9a Press the SET button.

8b Select (Record) using the left or right button and press the SET button.



- Recording starts.
- Recording stops when the set amount of time has passed.
Start-up Sound: 1 second, Operation Sound: 0.3 second, Selftimer Sound: 2 seconds, Shutter Sound: 0.3 second.

9b Select  (Register) using the left or right button.

10 Select [OK] using the left or right button and press the **SET** button.



- Sounds recorded with the movie (p. 79) and sound memo (p. 128) functions cannot be added as My Camera settings.
- When you register new My Camera settings, the previously registered settings are erased.

File Format of My Camera Settings

My Camera settings should conform to the below file formats. However, CF card images shot with this camera can be registered as My Camera settings regardless of the below formats.

- Start-up Image
 - Recording image format JPEG (Base line JPEG)
 - Sampling rate 4:2:0 or 4:2:2
 - Image size 320 x 240 pixels
 - File capacity 20 KB or less

- Start-up Sound, Operation Sound, Selftimer Sound and Shutter Sound

- Recording format WAVE (monaural)
- Quantization bit 8 bit
- Sampling frequency 11.025 kHz and 8.000 kHz
- Recording time

	11.025 kHz	8.000 kHz
Start-up Sound	1.0 sec. or less	1.3 sec. or less
Operation Sound	0.3 sec. or less	0.4 sec. or less
Selftimer Sound	2.0 sec. or less	2.0 sec. or less
Shutter Sound	0.3 sec. or less	0.4 sec. or less

Any file format other than those described above cannot be used with this camera.

An example of this function is to record "Say cheese" as the self-timer sound so the camera will replay this sound 2 seconds before the photo is taken. You could also record cheerful music to bring out the natural smiles of your subjects, or so they can strike a pose fitting the music. In these ways you can customize your camera by creating and adding new My Camera settings.

See the supplied *Software Starter Guide* for more information on creating and adding to the My Camera Settings files.

5 Press the shutter button halfway (p. 40).

- Two beeps will sound when the camera has finished metering, and the indicator will light green or orange. If the LCD monitor is on, the AF frame will appear green.
- The yellow indicator will blink and the beep will sound one time if the subject is difficult to focus on.



AF Frame

6 Press the shutter button all the way (p. 40).

- You will hear the sound of the shutter when the shutter activates.
- The picture appears for two seconds on the LCD monitor, if it is on.



- For functions available in this mode, see page 224.
- With the Review function, you can change the length of time images show on the LCD monitor after shooting, or set it so they do not show at all (p. 63).

Reviewing an Image Right After Shooting



After a photo is taken, the image displays on the LCD monitor for two seconds (To change, see *Changing the Image Display Duration* (p. 63)). There are two ways to display the image for longer.

- **Keeping the Shutter Button Pressed**

The image continues to appear on the LCD monitor as long as you keep the shutter button fully depressed.

- **Pressing the SET button while the image is displayed**

If you press the **SET** button while the image is displayed on the LCD monitor, it will continue to display even after the shutter button is released. Press the shutter button halfway again to stop displaying it.



.....
You can perform the following while images are displayed.

- Erasing Images Individually (p. 15, 132)
 - Magnifying Images (p. 119)
-

Changing the Image Display Duration

The length of time images are displayed after a photo has been taken can be changed from 2 seconds to 10 seconds or turned off.

1 In the [ (Rec.)] menu, select  (Review).

See *Selecting Menus and Settings* (p. 43)

2 Select a Review setting and press the **MENU** button.





- With the [Off] option, the image will not automatically display.
- With the [2 sec.] to [10 sec.] options, the image will appear for the time selected.
- You can continue to display the image as long as the shutter button is fully held pressed regardless of the Review setting.
- Another picture can be taken even while the last is displayed.

Changing the Resolution and Compression







You can change the resolution and compression (excluding movies) settings to suit the purpose of the image you are about to shoot.



Resolution				Purpose
	PowerShot A70	PowerShot A60		
L (Large)	2048 x 1536 pixels	1600 x 1200 pixels	High   Low	(2048 x 1536 pixels) • Print A4 size*1 210 x 297 mm (8.3 x 11.7 in.) prints • Print letter size*1 216 x 279 mm (8.5 x 11 in.) prints (1600 x 1200 pixels) • Print postcard size 148 x 100 mm (6 x 4 in.) prints • Print L size 119 x 89 mm (4.7 x 3.5 in.) prints
M1 (Medium 1)	1600 x 1200 pixels	-		Print card size 86 x 54 mm (3.4 x 2.1 in.) prints
M2 *2 (Medium 2)	1024 x 768 pixels	1024 x 768 pixels		• Send images as e-mail attachments • Shoot more images
S (Small)	640 x 480 pixels	640 x 480 pixels		

*1 Paper sizes vary according to region.

*2 Appears as **M** (Medium) with the PowerShot A60

Compression			Purpose
	Superfine	High Quality  Normal	Shoot higher quality images
	Fine		Shoot normal quality images
	Normal		Shoot more images

- Movies can be shot with the following resolution.

Resolution		
	PowerShot A70	PowerShot A60
	640 x 480 pixels	–
	320 x 240 pixels	320 x 240 pixels
	160 x 120 pixels	160 x 120 pixels

- 1** Turn the shooting mode dial to the desired Shooting mode.
- 2** Press the FUNC. button.
- 3** Select  L* (2048 x 1536 or 1600 x 1200) using the up or down button.



PowerShot A70
screen shown

* The current setting is displayed.

- 4** Select the resolution you wish to set using the left or right button.

Excluding 



PowerShot A70
screen shown

Number of recordable images
(Only displayed when the resolution,
compression or file format is selected)

- 5** Press the SET button.

6 Select the compression you wish to set using the left or right button.



You can shoot the image right after selecting settings by pressing the shutter button. This screen will appear again, once the image is shot.

7 Press the FUNC. button.

8 Shoot the image.



- Some settings are not available with certain Shooting modes. Please refer to *Functions Available in Each Shooting Mode* (p. 224)
- Size of an image file (approximate) (p.216)
- Types of CF cards and resolution (p. 215)
- The resolution and compression settings are affected by the Shooting mode selection as follows (only the resolution in 'M' mode).

Initial Shooting Mode	Next Shooting Mode	Resolution and Compression after Change
AUTO	AUTO P Tv Av M	Settings change to those of the next mode
		Settings do not change
	AUTO P Tv Av M	Settings change to those of the next mode
P Tv	P Tv Av M	Settings do not change
Av M	AUTO	Settings change to those of the next mode

⚡ Using the Flash



Use the flash according to the guidelines below.

⚡ ^A ⊙	Red-eye reduction, Auto	The flash fires automatically as required by the lighting level, and the red-eye reduction lamp fires each time the main flash fires.
⚡ ^A	Auto	The flash fires automatically as required by the lighting level.
⚡ ⊙	Red-eye reduction, Flash on	The red-eye reduction lamp and the flash always fire.
⚡	Flash on	The flash always fires.
⊕	Flash off	The flash does not fire.

1 Press the ⚡ button to switch between flash modes.



- The selected flash mode appears on the LCD monitor.
- You can switch between settings by pressing the ⚡ button.

When the red-eye reduction function is on

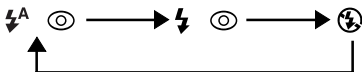

When the red-eye reduction function is off

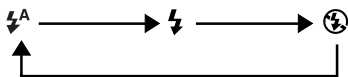

2 Shoot the image.

- The flash will fire if the indicator beside the viewfinder lights orange when the shutter button is pressed halfway. (Does not fire in )
- Shooting procedures are the same as for the **AUTO** mode (p. 60).

Setting the Red-eye Reduction Function

The red-eye reduction lamp fires when the flash is used in dark areas. This prevents light from reflecting back from the eyes and making them appear red.

1 In the [(Rec.)] menu, set (Red-eye) to [On].

 appears on the LCD monitor.



Red-Eye Reduction

When shooting with the red-eye reduction function, the subjects must look right at the red-eye reduction lamp for this mode to be effective. Try asking them to look directly at the lamp. Even better results can be obtained by shooting with the lens set to a wide angle, increasing the lighting in indoor settings or approaching closer to the subject.



When shooting with a high ISO sensitivity and using the flash, there is more of a chance of overexposure the closer you are to the subject.



- Some settings are not available with certain Shooting modes. Please refer to *Functions Available in Each Shooting Mode* (p. 224).
- The flash fires twice. A pre-flash will fire and will be followed by the main flash. The pre-flash is used by the camera to obtain the subject's exposure data so that the main flash can be set to the optimal intensity for the shot.
- The fastest shutter speed for flash synchronization is 1/500 second. The camera automatically resets the shutter speed to 1/500 second if a faster speed is selected.
- The flash fires with automatic adjustments when shooting in modes other than the **M** mode. When shooting in **M** mode, the flash fires with the manually set adjustments.
- In **M** mode, the [Flash Output] option can be changed (p. 112).
- Shots cannot be taken while the flash is charging.
- The flash may take up to approximately 10 seconds to charge in some cases. Actual times will vary according to usage and the battery charge.
- The flash setting is saved when the camera is turned off in the **P**, **Tv**, **Av** and **M** Shooting modes.

Portrait Mode



Use this mode when you want the subject to appear sharp and the background to blur.

1 Turn the shooting mode dial to .



Shooting procedures are the same as for the **AUTO** Mode (p. 60).



- For functions available in this mode, see page 224.
- To best achieve the effect of the background gradually fading, compose the image so that the upper half of the subject's body fills most of the viewfinder or LCD monitor.
- The background gets increasingly indistinct the more you adjust the focal length toward telephoto.

Landscape Mode





Use this mode to shoot expansive landscape scenes.

1 Turn the shooting mode dial to .



Shooting procedures are the same as for the **AUTO** Mode (p. 60).



- For functions available in this mode, see page 224.
- Since a slow shutter speed is often selected in  mode, use a tripod to shoot if the  (camera shake warning) icon appears on the LCD monitor.

Night Scene Mode



Use this mode to capture human subjects against the backdrop of an evening sky or night scene. The people are illuminated with light from the flash while the backdrop is captured at a slow shutter speed so that both appear correctly exposed.

1 Turn the shooting mode dial to .



Shooting procedures are the same as for the **AUTO** mode (p. 60).



.....
Always use a tripod to prevent camera shake in this mode.



-
- For functions available in this mode, see page 224.
 - Warn people to stay still for a few seconds after the flash fires because of the slow shutter speed.
 - Using the  mode in daylight will produce an effect similar to that of the **AUTO** mode.
-

Fast Shutter



Use this mode to shoot fast moving objects.

1 Turn the shooting mode dial to  .



Shooting procedures are the same as for the **AUTO** mode (p. 60).



- For functions available in this mode, see page 224.
- Noise in the recorded image may increase if you shoot dark subjects.

Slow Shutter



Use this mode to shoot moving objects to make them appear blurred such as river rapids.

1 Turn the shooting mode dial to .



Shooting procedures are the same as for the  mode (p. 60).



.....
Always use a tripod to prevent camera shake in this mode.



.....
For functions available in this mode, see page 224.
.....

Stitch Assist Mode



Use this mode when taking shots that you want to combine into a panorama. To create the panorama itself, you must stitch the images together at your computer.

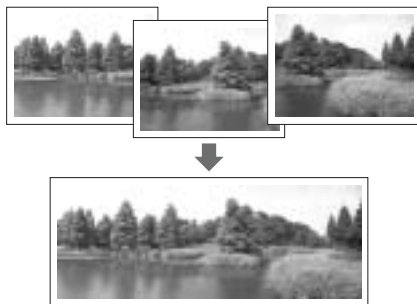

To create the panorama at your computer, use the PhotoStitch software that came with your camera.

Framing a Subject

The PhotoStitch program detects the overlapping portions of adjoining images and merges them. When shooting, try to include a distinctive item (landmark) in the overlapping portions.

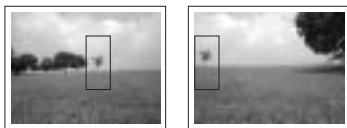



- Compose each frame so that it overlaps 30 to 50 % of the adjoining image. Try to keep the vertical misalignment to within 10 % of the image height.
- Do not include moving items in the overlap.
- Do not try to stitch images that include both distant and close items. Objects may appear warped or doubled up.
- Make the brightness in each image consistent. The final image will appear unnatural if the difference in brightness is too great.
- For good results, pan (swivel) the camera to take successive shots.
- To shoot close-ups, slide the camera over the subject, keeping it parallel as you move.

Shooting

1 Turn the shooting mode dial to .



The LCD monitor will turn on.

2 Select the shooting sequence using the left or right button and press the **SET** button.



You can also press the shutter button directly to shoot without pressing **SET**.

3 Shoot the first image.

The exposure and white balance settings are set and locked with the first image.

4 Compose and shoot the second image so that it overlaps the first.



- Minor discrepancies in the overlap can be corrected with the software.
- An image can be retaken. Press the left or right button to return to that frame.

5 Use the same procedures to shoot the remaining frames.

A maximum of 26 images can be recorded either horizontally or vertically.

6 Press the **SET** button after the last shot.





- A custom white balance setting (p. 103) cannot be set in  mode. To use a custom white balance setting, first set it in another Shooting mode.
- The settings in place for the first image are locked in and cannot be changed for subsequent shots.
- A TV cannot be used as the monitor for shooting in this mode.



For functions available in this mode, see page 224.

Movie Mode



Use this mode to shoot movie frames. The resolution can be set to either [ (640 × 480)] (PowerShot A70 only) or [ (320 × 240)] or [ (160 × 120)] (p. 64).

1 Turn the shooting mode dial to .





The LCD monitor turns on and displays the maximum recording time (in seconds).

2 Press the shutter button all the way.

- Shooting and sound recording starts simultaneously.
- During the shooting a red circle appears in the upper right of the LCD monitor.

3 Press the shutter button all the way to stop recording the movie.

- The maximum length of individual movie clips (approximately 15 frames/second) is about 30 seconds* at the  setting (PowerShot A70 only), 3 minutes at the  setting and about 3 minutes* at the  setting.

* Using and optional Canon FC-256MH CF Card (not sold in some regions)

When using the CF card supplied with the camera, the maximum length is approximately 14 sec.

These times may vary with the subject and shooting conditions. Recording will automatically stop when the maximum is reached or when the CF cards runs out of free capacity.

Filming may stop unexpectedly with certain types of CF card (if it is a slow-recording card, if it has been formatted on a different camera or a computer, or if images have been shot and erased repeatedly).



- You are recommended to use a CF card that has been formatted in your camera to shoot movies (p. 134). The card supplied with the camera may be used without further formatting. In addition, you are recommended to use the optional FC-256MH CF Card (not sold in some regions) to shoot movies with the  setting.
- Be careful not to touch the microphone while shooting.
- The AE, AF, white balance and zoom settings are set and locked to the settings of the first frame.
- If the indicator on the left side of the viewfinder blinks green after a shot, this indicates that the movie is being written to the CF card. You cannot shoot again until it stops blinking.



- For functions available in this mode, see page 224.
- Sound is recorded monaurally.
- There is no shutter sound in movie mode.
- QuickTime 3.0 or higher is required to replay movie files (AVI / Motion JPEG) on a computer. (QuickTime (for Windows) is bundled on the supplied Digital Camera Solution Disk. On the Macintosh platform, QuickTime 3.0 or later is generally bundled with Mac OS 8.5 or later operating system.)

Macro Mode





Use the macro mode to shoot close-ups of subjects in the range of 5 to 46 cm (2.0 in. to 1.5 ft.) at wide angle end and 26 to 46 cm (10 in. to 1.5 ft.) at telephoto end.

1 Press the **DISP.** button to turn the LCD monitor on.

2 Press the  button.

- The  icon appears on the LCD monitor.



- Pressing the  button until the  icon on the LCD monitor disappears cancels the macro mode.

3 Shoot the image.

- The indicator beside the viewfinder will light yellow when the shutter button is pressed halfway.
- Shooting procedures are the same as for the **AUTO** Mode (p. 60).



- Some settings are not available with certain Shooting modes. Please refer to *Functions Available in Each Shooting Mode* (p. 224).
- Always use the LCD monitor to compose images in macro mode. Shooting with the viewfinder is possible, though, the parallax phenomenon may cause images composed with the optical viewfinder to be off-center (p. 33).
- When the lens is zoomed out to the wide angle end, the recordable area is 55×41 mm (2.2 in. \times 1.6 in.)^{*1}, and at telephoto end, it is 92×69 mm (3.6 in. \times 2.7 in.)^{*2}
- The exposure may not be optimal when the flash is used in macro mode.

^{*1} Closest focal distance.

^{*2} Maximum optical telephoto setting.

Self-Timer

AUTO P Tv Av M 

You can take pictures with the self-timer in any Shooting mode.



1 Press the **FUNC.** button.

2 Select * (Drive Mode) using the up or down button.





* The current setting is displayed.

3 Select  or  using the left or right button and press the **FUNC.** button.

When  is selected, the shutter release will be delayed for 10 seconds, and when  is selected, the shutter release will be delayed for 2 seconds, after you press the shutter button.

4 Shoot the image.

- When  is selected, the self-timer lamp starts blinking when the shutter button is pressed all the way. The self-timer sounds and the blinking gets faster two seconds before the shutter activates.
- When  is selected, the self-timer lamp blinks fast from the beginning. The shutter activates in two seconds.
- Shooting procedures are the same as for the **AUTO** mode (p. 60).



.....

You can change the self-timer sound by changing the setting in [Selftimer Sound] in the [ (My Camera)] menu (p. 181).

.....





Digital Zoom

AUTO P Tv Av M 

When the LCD monitor is on, images can be zoomed with the combined optical and digital zoom functions as follows (figures are approximate.)

PowerShot A70: 3.8 times, 4.8 times, 6.0 times, 7.4 times, and 9.6 times

PowerShot A60: 3.8 times, 4.7 times, 6.0 times, and 7.5 times



- 1** Press the **DISP.** button to turn the LCD monitor on.
- 2** Turn the shooting mode dial to any Shooting mode except for  or .
- 3** In the [ (Rec.)] menu, select  (Digital Zoom).

See *Selecting Menus and Settings* (p. 43).



- 4** Select [On] using the left or right button and press the **MENU** button.

5 Press the zoom lever toward and hold it.

- The lens will zoom to the maximum optical telephoto setting and stop. Release the lever and press it toward  again to further zoom the image digitally.
- Press the lever toward  to zoom back out.



The combined magnifications of the optical zoom and digital zoom are displayed.

6 Shoot the image.

Shooting procedures are the same as for the **AUTO** mode (p. 60).



.....
The digital zoom cannot be used when the LCD monitor is off.



.....
Images become coarser the more they are digitally zoomed.
.....

Continuous Shooting

P Tv Av M     

The camera will shoot continuously at the speed of approx. 2.2 images per second* (PowerShot A70) or approx. 2.6 images per second* (PowerShot A60) (When the LCD monitor is OFF in Large/Fine mode).

* These figures reflect Canon's testing standard, the actual figures will vary according to the subject and shooting conditions. The actual figures will vary according to the subject and shooting conditions.

- 1 Press the FUNC. button.**
- 2 Select * (Drive Mode) using the up or down button.**

* The current setting is displayed.



- 3 Select  using the left or right button and press the FUNC. button.**
- 4 Press the shutter button halfway to lock the focus.**
- 5 Press the shutter button all the way to shoot.**

Shooting will stop when the shutter button is released.



- The interval between frames may lengthen somewhat when the internal memory becomes full.
- The flash can be used, but the interval between images will lengthen to accommodate the flash recharge time.

Shooting-Selecting Particular Effects

Camera settings such as shutter speed and aperture can be freely changed for shooting.

See *Functions Available in Each Shooting Mode* (p. 224) at the end of this manual to find out which settings can be changed in which Shooting modes.



.....
Please see **AUTO** Mode (p. 60) for shooting procedures once you have changed a setting.
.....

P Program AE

P

Use the program AE mode to have the camera automatically set the shutter speed and aperture value to match the brightness of the scene.

1 Turn the shooting mode dial to **P**.

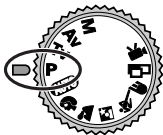

2 Shoot the image.



- The shutter speed and aperture value will automatically appear on the LCD monitor if it is on.
- The correct exposure has been set if the shutter speed and aperture value show in white.



-
- For functions available in this mode, see page 224.
 - If a correct exposure cannot be obtained, the shutter speed and aperture value show in red on the LCD monitor. Use the following methods to obtain the correct exposure and make them show in white.
 - Use the flash.
 - Change the ISO speed setting.
 - Change the light metering mode.

Differences and Similarities between the **P** and **AUTO** Modes.

- Both modes automatically select the shutter speed and aperture value.
- The following settings can be adjusted in **P** mode, but not in **AUTO** mode.

- Exposure Compensation	- White Balance
- ISO Speed	- Flash (Flash on)
- Photo Effects	- Continuous Shooting
- Light Metering Mode	- Manual Focus
- Auto Focus	
- For the correlation between aperture value and shutter speed, see page 93.

Tv Setting the Shutter Speed

Tv

When you set the shutter speed in the shutter speed-priority AE mode, the camera automatically selects an aperture value to match the brightness. Faster shutter speeds allow you to catch an instantaneous image of a moving subject while slower speeds create a flowing effect and allow you to shoot without a flash in dark areas.

1 Turn the shooting mode dial to Tv.

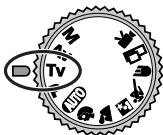

The shutter speed appears on the LCD monitor if it is on.

2 Select a speed using the left or right button.



3 Shoot the image.



The correct exposure has been set if the shutter speed and aperture value show in white.



- If the aperture value shows in red, the image is under exposed (insufficient light) or overexposed (too much light). Adjust the shutter speed using the left and right buttons until the aperture value display turns to white.
- The nature of CCD image sensors is such that noise in the recorded image increases at slow shutter speeds. This camera, however, applies special processing to images shot at shutter speeds slower than 1.3 seconds to eliminate the noise, thereby producing high-quality images. Nevertheless, a certain amount of processing time may be required before the next image can be shot.



- For functions available in this mode, see page 224.
- Please note that camera shake becomes a factor at low shutter speeds. If the camera shake warning  appears in the center of the LCD monitor, secure the camera to a tripod before shooting.
- The aperture value and shutter speed change according to the zoom state as follows.

	Aperture	Shutter Speed (seconds)
Wide Angle	F 2.8	to 1/1250
	F 3.2 - 4.0	to 1/1600
	F 4.5 - 8.0	to 1/2000
Telephoto	F 4.8	to 1/1250
	F 5.6 - 7.1	to 1/1600
	F 8.0	to 1/2000

- The fastest shutter speed for flash synchronization is 1/500 second. The camera automatically resets the shutter speed to 1/500 second if a faster speed is selected (p. 69).

Shutter Speed Display

The numbers in the table below indicate the shutter speed in seconds. For slower speeds, quote marks indicate the decimal place, so that 0"3 indicates 0.3 second and 2" indicates 2 seconds.

1/2000	1/1600	1/1250	1/1000	1/800	1/640				
1/500	1/400	1/320	1/250	1/200	1/160				
1/125	1/100	1/80	1/60	1/50	1/40	1/30			
1/25	1/20	1/15	1/13	1/10	1/8	1/6	1/5		
1/4	0"3	0"4	0"5	0"6	0"8	1"	1"3	1"6	
2"	2"5	3"2	4"	5"	6"	8"	10"	13"	15"

Av Setting the Aperture

Av

The aperture adjusts the amount of light that passes through the lens. Selecting a lower aperture value (opening the aperture) allows you to fade the background. A higher aperture value (closing it) brings the entire range from foreground to background into focus.

1 Turn the shooting mode dial to Av.



The aperture value appears on the LCD monitor if it is on.

2 Select a value using the left or right button.



3 Shoot the image.



The correct exposure has been set if the shutter speed and aperture value show in white.



- If the shutter speed shows in red on the LCD monitor, the image is under exposed (insufficient light) or overexposed (too much light). Adjust the aperture value using the left and right buttons until the shutter speed display turns white.
- Some aperture values may not be available with certain zoom positions.



- For functions available in this mode, see page 224.
- Please note that camera shake becomes a factor at low shutter speeds. If the camera shake warning  appears in the LCD monitor, secure the camera to a tripod before shooting.
- In this mode, the shutter speed range with synchronized flash is 1/60 second to 1/500 second. The aperture value setting may therefore be changed automatically to match the synchronized flash speed even if its value was set previously.

Aperture Value Display

The larger the aperture value, the smaller the lens aperture.

F2.8 F3.2 F3.5 F4.0 F4.5 F4.8 F5.0 F5.6 F6.3 F7.1 F8.0

- For the correlation between aperture value and shutter speed, see page 93.

M Manually Setting the Shutter Speed and Aperture

M

You can manually set the shutter speed and aperture to achieve a particular effect. This is convenient for shooting fireworks and other images where it is difficult to set the correct exposure automatically.

1 Turn the shooting mode dial to M.

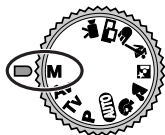

The shutter speed and aperture value appears on the LCD monitor if it is on.

2 Select a shutter speed using the left or right button.



3 Press the SET button.



4 Select an aperture value using the left or right button.

5 Shoot the image.

When you press the shutter button halfway, a number indicating the difference between the standard exposure* and the selected exposure appears on the LCD monitor. If the difference is more than ± 2 steps, “-2” or “+2” appears in red.

* The standard exposure is calculated by the AE function according to the selected metering mode.





- For functions available in this mode, see page 224.
- If you wish to change the exposure, select the shutter speed or the aperture with the **SET** button and change the value using the left or right button.
- The LCD monitor's brightness matches the selected shutter speed and aperture value. When you select a fast shutter speed or shoot a subject in a dark place and set the flash to   (Red-Eye Reduction, Flash On) or  (Flash On) the LCD monitor will always light up.
- For the correlation between aperture value and shutter speed, see page 93.

Switching Between Light Metering Modes

P Tv Av M

You can switch between metering modes to shoot.

	Evaluative Light Metering	Appropriate for standard shooting conditions, including backlight scenes. The camera divides images into several zones for light metering. The camera evaluates the complex lighting conditions, such as the position of the subject, the brightness, the background, the direct light, and the backlighting, and adjusts the settings to the correct exposure for the main subject.
	Center-Weighted Averaging	Averages the exposure from the entire image, but places more weight on the subject at the center. Use this mode when the subject is backlit or surrounded by bright light.
	Spot AE Point	Meters the area within the spot AE point frame at the center of the LCD monitor. Use this setting when you want to set the exposure on the subject in the center of the monitor.

1 Press the **DISP.** button to turn on the LCD monitor.

2 Press the **FUNC.** button.



- 3** Select * (Evaluative) using the up or down button.

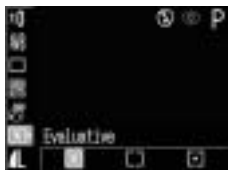

* The current setting is displayed.

- 4** Select a light metering mode using the left or right button.



- 5** Press the **FUNC.** button.

- 6** Shoot the image.



Some settings are not available with certain Shooting modes. Please refer to *Functions Available in Each Shooting Mode* (p. 224)

Adjusting the Exposure

P Tv Av      

Adjust the exposure compensation setting to avoid making the subject too dark when it is backlit or shot against a bright background.

1 Press the **DISP.** button to turn on the LCD monitor.

2 Press the **FUNC.** button.



3 Select **±0*** (+/- (Exp.)) using the up or down button.



* The current setting is displayed.

4 Select a setting using the left or right button.



- The settings can be adjusted in 1/3 steps in the range of -2EV to +2EV.
- You can shoot the image right after selecting settings by pressing the shutter button. This screen will appear again, once the image is shot.

5 Press the FUNC. button.







- To cancel the exposure compensation, return the setting to 0 using the left or right button.

6 Shoot the image.

WB Setting the White Balance

P Tv Av M        

When the white balance mode is set to match the light source, the camera can reproduce colors more accurately. Set the white balance mode to a natural or artificial light setting according to the circumstances.

	Auto	The camera sets the white balance automatically according to shooting conditions.
	Daylight	Use when shooting outdoors in sunlight on a clear day.
	Cloudy	Use when shooting outdoors and the sunlight is not enough such as under cloudy skies, in shade or at dusk.
	Tungsten	For recording under tungsten and bulb-type 3-wavelength fluorescent lighting.
	Fluorescent	For recording under warm-white, cool-white or warm-white (3-wavelength) fluorescent lighting.
	Fluorescent H	For recording under daylight fluorescent, or daylight fluorescent-type 3-wavelength fluorescent lighting.
	Custom	For setting a custom value with a white sheet of paper, etc., to obtain the optimal white balance for the conditions.

1 Press the FUNC. button.

2 Select **AWB*** (Auto) using the up or down button.



* The current setting is displayed.

3 Select the desired setting using the left or right button.





- Please see the next page regarding the  custom setting.
- You can shoot the image right after selecting settings by pressing the shutter button. This screen will appear again, once the image is shot.

4 Press the **FUNC.** button.

5 Shoot the image.



The white balance cannot be adjusted when the photo effect is set to  (Sepia) or  (B/W).

Setting a Custom White Balance

You can set a custom white balance to obtain the optimal setting for the shooting conditions by having the camera evaluate a subject such as a white piece of paper or cloth, or a photo-quality gray card.

- 1** Press the **FUNC.** button.
- 2** Select * (**Auto**) using the up or down button.



* The current setting is displayed.

- 3** Select  (**Custom**) using the left or right button.



4 Aim the camera at the white paper or cloth, or gray card and press the **SET** button.







- Aim the camera so that the white paper or cloth, or gray card, completely fills the frame on the LCD monitor screen or the entire viewfinder before pressing the **SET** button. When you press the **SET** button, the camera reads the white balance data.
- You can shoot the image right after selecting settings by pressing the shutter button. This screen will appear again, once the image is shot.

5 Press the **FUNC.** button.

6 Shoot the image.









- Some settings are not available with certain Shooting modes. Please refer to *Functions Available in Each Shooting Mode* (p. 224)
- To set and use a custom white balance setting, it is advisable to select the **P** Shooting mode and set the exposure compensation and flash exposure compensation to zero (± 0). The correct white balance may not be obtained when the exposure is incorrect (image is completely black or white).
- It is also advisable to use the LCD monitor to compose the shot and to zoom in to the telephoto end setting.
- Since the white balance data cannot be read in  mode, preset the white balance in another Shooting mode first before selecting  mode.
- Set the flash on or off when setting a custom white balance.
The white balance may not be accurate if the setting conditions and shooting conditions are not the same. If the flash fires when setting a custom white balance with the flash set to  or , ensure that you also use the flash when you go to shoot.
- The custom white balance setting is not cancelled even if settings are reset to default settings (p. 184)

Changing the Photo Effect

P Tv Av M       

You can shoot with different photo effects.

	Photo Effect Off	Records with no effect.
	Vivid	Emphasizes the contrast and color saturation to record in bold color.
	Neutral	Tones down the contrast and color saturation to record neutral hues.
	Low Sharpening	Records subjects with softened outlines.
	Sepia	Records in sepia tones.
	B/W	Records in black and white.

1 Press the **FUNC.** button.

2 Select * (Effect Off) using the up or down button.



* The current setting is displayed.

3 Select the desired setting using the left or right button.



- If the LCD monitor is on, you can check the results by viewing the image on the LCD monitor.
- A shot can be taken immediately after by pressing the shutter button. The menu will reappear after the shot, allowing you to adjust the setting.

4 Press the **FUNC.** button.

5 Shoot the image.

ISO Changing the ISO Speed

P Tv Av M

Change the ISO speed when shooting in dark places or when you want to shoot with a faster shutter speed. You can choose from the following speeds: Auto, 50, 100, 200 and 400.

1 Press the **FUNC.** button.

2 Select **ISO AUTO*** (ISO Speed) using the up or down button.



* The current setting is displayed.

3 Select the desired setting using the left or right button.



You can shoot the image right after selecting settings by pressing the shutter button. This screen will appear again, once the image is shot.

4 Press the **FUNC.** button.

5 Shoot the image.



-
- Higher ISO speeds increase the image noise. To take clean images, use as low an ISO speed as possible.
 - Although the AUTO setting selects the optimal speed, it will automatically raise the speed when the shooting condition limits are reached. It will also raise the speed when the light from the flash is insufficient to illuminate the subject matter.
-

Adjusting the Flash Output

M

In **M** mode, the flash output can be controlled in three steps, starting from FULL, when shooting.

1 Press the **FUNC.** button.

2 Select  (Flash Output) using the up or down button.



3 Adjust the flash output using the left or right button.

You can shoot the image right after selecting settings by pressing the shutter button. This screen will appear again, once the image is shot.

4 Press the **FUNC.** button.

5 Shoot the image.

Shooting Problem Subjects for the Autofocus



The autofocus may not work well on the following types of subjects.

- Subjects with extremely low contrast to the surroundings
- Subjects mixing close and far objects
- Subjects with extremely bright objects at the center of the composition
- Subjects that are moving quickly

To shoot these subjects, first aim the camera at an object at a similar distance, lock the focus and recompose the image with the desired subject, or use manual focus.

Shooting with Focus Lock

Focus Lock Method 1

- 1** Press the **DISP.** button to turn on the LCD monitor.
- 2** Aim the **AF** frame at an object at a similar distance to the subject you wish to shoot.
- 3** Press the shutter button halfway to lock the focus.

The AE setting will also lock when you do this. The exposure may occasionally be incorrect if the difference between the two items is too great. Use Method 2 when this happens.

4 Keep it pressed while you recompose the image and press the shutter button all the way to shoot the image.

Focus Lock Method 2

1 Press the **DISP.** button to turn on the LCD monitor.

2 Press the shutter button halfway to lock the focus. Keep it pressed and press the **MF** button.

- The **MF** icon appears on the LCD monitor.
- The focus setting will lock even if the shutter button and the **MF** button are released.
- The manual focus setting will cancel if the **MF** button is pressed again.

3 Recompose the image and press the shutter button all the way to shoot the image.



.....
Focus lock method 2 cannot be used while the Shooting mode is set to **AUTO**.



-
- Method 2 is convenient because you can let go of the shutter button to recompose the image.
 - When shooting through glass, get as close as possible to avoid reflection off the glass.
-

Shooting in Manual Focus Mode

The focus can be manually set.

1 Press the **DISP.** button to turn on the LCD monitor.

2 Press the **MF** button until **MF** appears.

- The **MF** indicator appears.
- The **MF** indicator shows approximate figures. Use them as a shooting guideline only.

3 Use the left or right button to focus.

- Adjust the focus using the left or right button until the image appears focused on the LCD monitor.
- Pressing the **MF** button a second time cancels the manual focus mode.

4 Shoot the image.



- In manual focus, the AF frame locks on the center frame.
- You can use manual focus in the macro focal distance 5 to 46 cm (2.0 in. to 1.5 ft.) at wide angle end and 26 to 46 cm (10 in. to 1.5 ft.) at telephoto end. In this case, the fine scale is adopted.
- You can change the **MF** indicator displayed distance units (p. 180).

Resetting the File Numbers

You can select the way file numbers are assigned.

On	The file numbers are reset to the start (100-0001) each time a new CF card is inserted. New images recorded on CF cards with existing files are assigned the next available number.
Off	The file number of the last image to be shot is memorized so that images recorded to a new CF card start from the next number.

1 In the [(Set up)] menu, select (File No. Reset).

See *Selecting Menus and Settings* (p. 43).



2 Select [On] or [Off] using the left or right button.

3 Press the **MENU** button.



Setting the [File No. Reset] to [Off] is useful for avoiding file name duplication when images are downloaded to a computer.

About File and Folder Numbers

Images are assigned file numbers from 0001 to 9900, and folders are assigned folder numbers from 100 to 998 (Folder numbers cannot contain 99 in the last two digits).

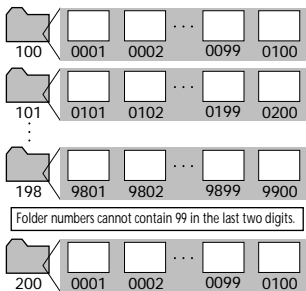

Folder File Capacity

Each folder usually contains up to 100 images. However, since images shot in Continuous mode and Stitch Assist mode are always saved into the same folder, a folder may contain more than 100 images. The number of images may also exceed 100 if a folder contains images copied from a computer or images shot with other cameras.

Please note, however, that the images in folders containing 2001 or more images cannot be replayed in this camera.

Replaying

Displaying Images Individually

You can view the recorded images on the LCD monitor.

1 Set the mode switch to .

The last recorded image appears (single image replay).



2 Move between images using the left or right button.

Use the left button to move to the previous image and the right button to move to the next. Holding the left or right button moves more rapidly between images, but the images will not appear as clearly.



- Press the **DISP.** button to show the data for the displayed image (p. 34).
- Press the  button to quickly delete the displayed image (p. 132).

Q Magnifying Images

Images can be magnified up to approximately 10 times.

1 Set the mode switch to .

2 Press the zoom lever toward .



Approximate position

- You can move around the magnified image using the left, right, up or down button.
- Hold the **SET** button down and press the zoom lever toward  to cycle through each setting, approximately 2.5 times, to approximately 5 times and 10 times.

Canceling the Magnified Display

1 Press the zoom lever toward .



.....
Movie frames and index replayed images cannot be magnified.



.....
You can magnify an image while it is displayed on the LCD monitor in Shooting mode immediately after the image is shot (p. 62).
.....

Viewing Images in Sets of Nine (Index Replay)

Up to nine images can be viewed at once in index replay.

1 Set the mode switch to .

2 Press the zoom lever toward .

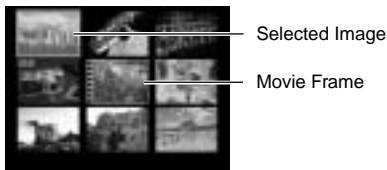

Nine images appear at once (index replay).

3 Change the image selection using the left, right, up or down button.

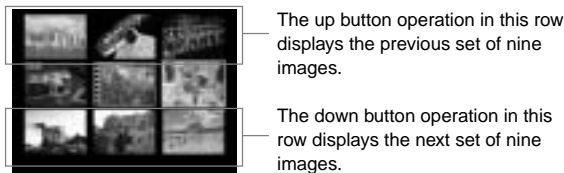

4 Press the zoom lever toward .

Index replay cancels and the display reverts to single image replay.





Press the **DISP.** button to show the data for the displayed image (p. 34).

JUMP Jumping Between Images

The display can be advanced or set back 9 images in either single image replay or index replay.

1 Display the JUMP bar.

- Press the zoom lever twice toward  while in single replay (p. 118).
- Press the zoom lever once toward  while in index replay (p. 120).

2 The displayed image(s) change.

Jump 9 images behind or ahead using the left and right buttons.



3 Press the zoom lever toward .

- The jump bar disappears and the camera returns to index replay.
- If you press the zoom lever once more toward , the camera returns to single replay.

Viewing Movies

You can replay the images shot in **REPLAY** mode.

1 Set the mode switch to **REPLAY**.

Movies cannot be viewed in index replay.

2 Select a movie using the left or right button and press the **SET** button.



- A movie displays with the **SET** **REPLAY** icon on it.
- The movie replay panel appears.

3 Select **PLAY** using the left or right button and press the **SET** button.

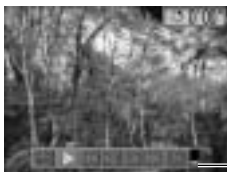

Volume

- The movie images and sound will play.
- You can adjust the volume using the up or down button.
- When a movie has finished playing, it will display the last frame. If the **SET** button is pressed in this state, the camera will revert to the movie replay panel. If the **SET** button is pressed again, the movie will start playing from the first frame.

Pausing and Resuming Play

- Press the **SET** button to pause the movie. Press it again to resume.

Fast Forwarding / Rewinding

- Select one of the following operations using the left or right button and press the **SET** button.

 : Return to Single Image View

 : First Frame

 : Previous Frame (Rewinds if the **SET** button is held down)

 : Next Frame (Fast forwards if the **SET** button is held down)

 : Last Frame



.....
 You may experience frame dropping and audio breakup when replaying a movie on a computer with insufficient system resources.



-
- The volume at which movies replay can also be adjusted in the Replay menu (p. 179).
 - Please adjust the audio sound level on the TV when viewing movie files on a TV.
-

Editing Movies

You can delete unwanted portions from the first or second half of a movie clip.

- 1** Select the movie you wish to edit and press the **SET** button.

See *Viewing Movies* (p. 122).



- 2** Select  (Edit) using the left or right button and press the **SET** button.



The movie editing panel and the movie editing bar appear.

- 3** Select an editing method using the up or down button.



-  : Deletes frames in the first half of the movie
-  : Deletes frames in the second half of the movie
-  : Reverts to the movie replay panel

4 Select the range you wish to edit using the left or right button.



5 Select **▶** (play) using the up or down button and press the **SET** button.

- The temporarily edited movie will start playing.
- The movie will stop if you press the **SET** button while it is playing.

6 Select **⏮** (Save) using the up or down button.



When **⏮** is selected, the edited movie is not saved and the camera reverts to replay.

7 Select [Overwrite] or [New File] using the left or right button.



- [Overwrite] : Saves the edited movie under the same file name as the original movie. The original data is deleted.
- [New File] : Saves the edited movie under a new file name. The original data is not deleted.
- When there is not enough space left on the CF card, only the overwrite function is available. If this happens, a small ▲ appears on the counter of the movie editing bar.



-
- Protected movies cannot be edited.
 - It may take approximately 3 minutes to save an edited movie. If the batteries run out of charge partway through, edited movie clips cannot be saved. When editing movies, use fully charged NiMH batteries, unused alkaline batteries or the optional AC Adapter Kit ACK600 (p.195).



-
- Movies with an original length of 2 seconds or more can be edited.
 - The minimum length for movie clips is 1 second.
-

Rotating Images in the Display

Images can be rotated 90° and 270° clockwise on the LCD monitor.



0° (Original)



90°



270°

1 Select (Rotate) from the [(Replay)] menu.

See *Selecting Menus and Settings* (p. 43).

2 Select an image you want to rotate using the left or right button and press the **SET** button.

The image cycles to the next orientation (90° → 270° → original) each time the **SET** button is pressed.

3 Press the **MENU** button.

The Replay menu appears again. Press the **MENU** button again to close the menu.



- Movie images cannot be rotated.
- When images are downloaded to a computer, the orientation of images rotated by the camera will depend upon the software used to download the images.



Images can be magnified when rotated (p. 119).

Attaching Sound Memos to Images

In replay mode (including single replay, index replay and magnifying replay) you can attach sound memos (up to 60 seconds) to an image. The sound data is saved in WAVE format.

- 1** Select  (Sound Memo) in the [ (Replay)] menu.

See *Selecting menus and Settings* (p. 43).



 appears.

- 2** Select the image to which you wish to add a sound memo using the left or right button, then press the **SET** button.





The A/V panel appears.

- 3** Select  (Record) using the left or right button, then press the **SET** button.

- The recording starts and the elapsed time is displayed. Speak towards the microphone of the camera.
- To stop recording, press the **SET** button. To restart recording press the **SET** button again.
- You can add as many sound memos as you like until their total time reaches 60 seconds.

Playing back the Sound memos

Select  (Replay) in step 2 on the previous page. Images with sound memos are displayed with the  mark (simple display or detailed display). To start playback, press the **SET** button. To stop playback, press the **SET** button again. You can adjust the volume using the up or down button.

Erasing the Sound Memos

Select  (Erase) in step 2 on the previous page.

Ending the Sound Memos Settings

Press the **MENU** button in step 2 on the previous page.



- You cannot attach sound memos to movies.
- You cannot record or playback sound notes for images that already have an incompatible sound file attached. If you attempt to record or play such images the “Incompatible Wave format” message will display. Incompatible sound files can be deleted with this camera.
- Sound memos for protected images cannot be erased. (p. 131).



The volume can be adjusted in the Setup menu (p. 179).

Auto Play

Use this feature to automatically replay all of the images in the CF card (Auto Play). The LCD monitor displays each image for approximately 3 seconds.

1 In the [(Replay)] menu, select (Auto Play).

- See *Selecting Menus and Settings* (p. 43).
- Once you have selected it, Auto Play starts.
- As with the single image display mode, pressing the left or right button during auto play will advance through the images more rapidly.

Pausing and Resuming Auto Play

You can pause Auto Play at any time by pressing the **SET** button. You can then restart it by pressing the **SET** button again.

Stopping Auto Play

To stop Auto Play, press the **MENU** button.



- The display interval may vary for some images.
- Movie images play for the length of time that they were recorded.
- The power-saving function is disabled during Auto Play (p. 31).

Protecting Images

You can protect important images from accidental erasure.

1 In the [ (Replay)] menu, select  (Protect).

See *Selecting Menus and Settings* (p. 43).

2 Select an image you want to protect using the left or right button and press the **SET** button.



Protected Icon

- The  icon appears on protected images.
- To remove the protection, press the **SET** button again (in protection mode).
- You can make the selection of images easier by toggling between single replay and index replay. (p. 120)

3 Press the **MENU** button.

The camera returns to the menu screen. Press the **MENU** button again to exit the menu screen.



.....
Please note that formatting (initializing) a CF card erases all data, including protected images (p. 134) and other file types. Please check the contents of a CF card before formatting it.
.....

Erasing



Please note that erased images cannot be recovered.
Exercise caution before erasing a file.

Erasing Images Individually

- 1** Select the image you wish to erase using the left or right button and press the  button.

A confirmation screen appears.



- 2** Select [Erase] using the left or right button and press the **SET** button.

To cancel instead of erasing, select [Cancel] and press the **SET** button.



Protected images cannot be erased with the erase function (p. 131).

Erasing All Images

- 1** In the [ (Replay)] menu, select  (Erase all) and press the **SET** button.

A confirmation screen appears.

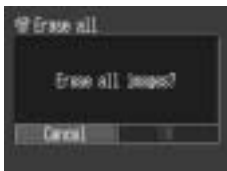

- 2** Select [OK] using the left or right button and press the **SET** button.

To cancel instead of erasing, select [Cancel] and press the **SET** button.



.....
Protected images cannot be erased with the erase function (p. 131).
.....

Formatting a CF Card

You should format a new CF card or one from which you wish to erase all images and other data.



.....

Please note that formatting (initializing) a CF card erases all data, including protected images and other file types. Please check the contents of the CF card before formatting it.

.....

- 1** In the [ (Set up)] menu, select  (Format) and press the **SET** button.



- 2** Select [OK] using the left or right button and press the **SET** button.



To cancel formatting instead, select [Cancel] and press the **SET** button.



- If the camera does not work properly, the inserted CF card may be malfunctioning. Reformatting the CF card may solve the problem.
- When a non-Canon brand CF card is malfunctioning, reformatting it may solve the problem.
- CF cards formatted in another camera, computer or peripheral device may not operate correctly. When that happens, reformat the CF card with this camera.

Printing

About Printing

This camera supports direct printing. By connecting the camera to an optional direct print compatible printer (CP Series)*¹ or a Bubble Jet printer (sold separately) that supports the direct print function, you can send the images from the CF card directly to the printer using the camera buttons. Or, you can specify the images on your CF card you want to print and how many copies you want (DPOF*² Print Settings), and then take the CF card to a participating photo lab to have them printed out later.

*¹ The direct print  icon appears on direct print compatible CP Series printers.

*² Digital Print Order Format

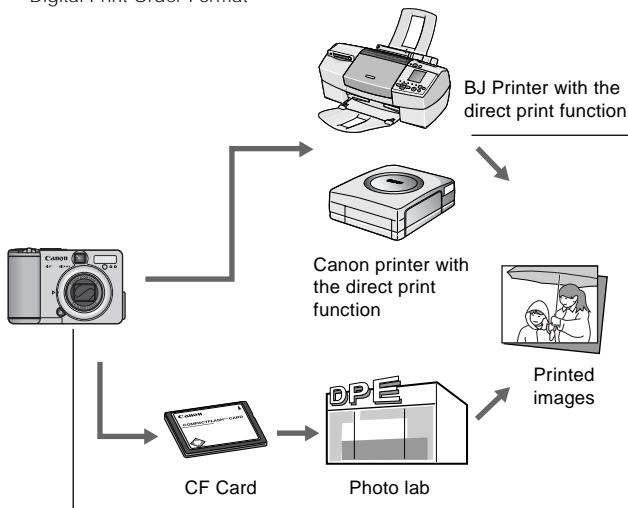

Please refer to the *System Map* supplied with your camera for direct print function compatible printer (CP Series) information.

Print Settings for Direct Print Function

- Select how many copies you want (p.146)



- Select the print style (p.146)
 - Standard / Multiple
 - Bordered / Borderless
 - Date On / Off



- Select the print area (Trimming) (p.149, 152)

DPOF Print Settings

- Select the image you want to print (p. 154)



- Select how many copies you want (p. 155)



- Select the print style (p. 156)
 - Standard / Index
 - Date On / Off
 - File Numbers On / Off

Transfer Settings

- Select the image you want to send through e-mail (p. 163)
The DPOF-compliant software is needed for actually transferring the images.

Selecting from the Print Order Menu

Use the Print Order Menu as shown below to select all print settings.

Direct Print Function

Mode switch 



PowerShot A70

DPOF Settings

Mode switch 

MENU 



MENU



: Turns the menu on/off



: Selects items and settings

SET



: Sets items and settings

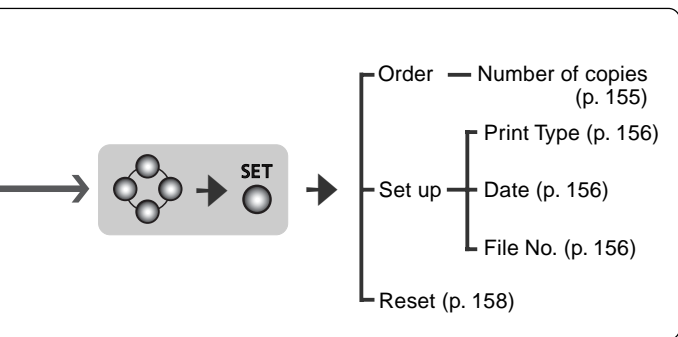
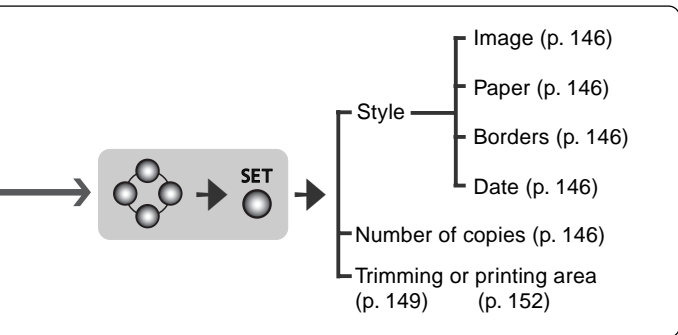

Connecting the Camera to a Printer

You can make clear prints swiftly and easily when you connect the camera to an optional direct print function compatible printer (CP Series) or a direct print function compatible Bubble Jet printer (sold separately). It can also be used with DPOF print settings.



.....

You are recommended to use the optional AC Adapter Kit ACK600 (p. 195) to power the camera when it is connected to the printer or else load fully charged NiMH batteries (p. 193) or unused alkaline batteries.



-
- Please refer to the *System Map* supplied with your camera for direct print function compatible printer (CP Series) information.
 - Please see your printer's user guide for instructions on loading paper and installing ink cartridges.
-

Connecting to a Direct Print Function Compatible Printer (CP Series)

Two direct interface cables are supplied with the printer. Use the cable (DIF-100) that has a ⇄ symbol on the connector to connect to this camera.

- 1 Turn off the camera (p. 30).**
- 2 Attach the power cable to the printer and plug the other end into power supply, or install the printer's rechargeable battery.**

Depending on the type of printer you have, it may or may not use rechargeable batteries. Refer to your printer's user guide.

3 Connect the camera and printer using the direct interface cable.

When you insert the cable, make sure the “Canon” mark of the cable faces up.

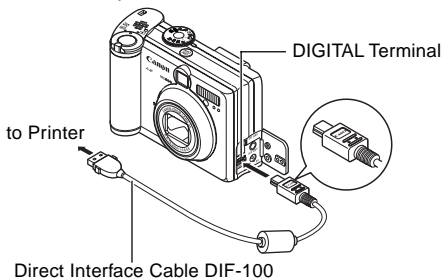

4 Press the printer's ON/OFF button to turn on the power.

With the Card Photo Printer CP-10, the power turns on when the power cord is connected to the printer as shown in step 2.

5 Set the mode switch to and turn the camera on.



When the printer is properly connected to the camera,  appears on the camera LCD monitor.

Connecting Bubble Jet Printer to the Camera



.....

Please read the user guide supplied with your BJ printer to see if it is compatible with the direct print function, and for instructions on connection cables and general operations.

.....

- 1** Turn off the camera (p. 30).
- 2** Turn the BJ printer's power on after you have connected the power cord to the BJ printer and inserted the other end in a power outlet.
- 3** Connect the camera and printer using the cable.

When you insert the cable, make sure the "Canon" logo on the cable faces up.

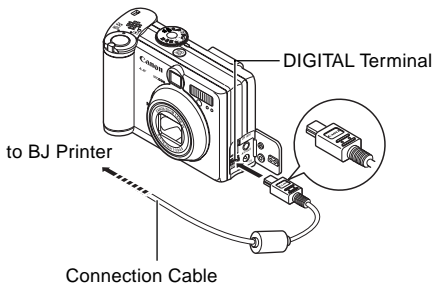



4 Set the mode switch to and turn the camera on.



 appears on the camera LCD monitor when the BJ printer is properly connected to the camera.



- On Bubble Jet printers with operation panels, images cannot be printed through the operation panel while the camera is connected.
- The following operations cannot be performed while the printer is connected.
 - Replaying movies
 - Setting the language using the **SET** and the **MENU** button combination.
- When the printer is disconnected, the  or  symbol will disappear from the LCD monitor and the camera will revert to standard replay mode.
- Please use the following procedures when you detach the cable from the printer and the camera.
 1. Detach the cable from the printer.
 2. Turn off the camera power.
 3. Detach the cable from the camera.
- When you detach the cable from the camera, hold the plug and do not pull by the cable.

Printing

* The following illustrations show examples from a direct print function compatible printer (CP Series). Options for the Style category will differ slightly for BJ printers.

An image can be printed when displayed in single replay or selected in index replay.

1 Choose an image using the left or right button and press the SET button.

2 Set the number of prints, the print style and cropping settings (printing area) as required.

- *Selecting the Number of Copies* (p. 146)
- *Setting the Print Style* (p. 146)
- *Trimming* (PowerShot A70) (p. 149)
- *Specifying the Printing Area* (PowerShot A60) (p. 152)

3 Choose [Print].

The image will start to print and, when it is completely finished, the display will revert to standard replay mode.



PowerShot A70 screen



.....
You cannot print movies.
.....



Cancel Printing

- To cancel printing between images printed, press the **SET** button. A confirmation dialog appears. Select [OK] using the left and right buttons and press the **SET** button.
 - Direct Print Function Compatible Printers (CP Series)
A print in progress cannot be stopped. The printer will stop after the current print is complete and the camera will display its replay screen at that point.
 - BJ Printers
The printer will stop printing the current image and eject the paper.

Printing Errors

- An error message appears if an error occurs for some reason during the printing process (p. 188). Use the left or right button to select [Stop] or [Resume] and press the **SET** button (with a BJ printer, the print will automatically restart if the error is resolved).
 - Direct Print Function Compatible Printers (CP Series)
The [Resume] option may not appear with some types or error. In that case, select [Stop].
 - BJ Printers with the Direct Print Function
 - The [Continue] and [Stop] options may appear with some error messages.
 - On BJ printers equipped with an operation panel, an error number displays on the panel. Please refer to the Bubble Jet Printer Quick Start Guide for the remedies corresponding to the error numbers.
-

Setting the Print Settings (Direct Print Function)

Selecting the Number of Copies

- 1** In Replaying mode, press the **SET** button and select the [Copies] option using the up or down button.







- 2** Specify the desired number of copies using the left or right button.

You can specify from 1 to 99 prints.

Setting the Print Style

You can select from among the following print styles.

Direct Print Function Compatible Printer (CP Series)

Image	 Standard	Prints one image per page.
	 Multiple*	Prints eight copies of the same image on one page.
Borders	 Borderless	Prints right to the edges of the page.
	 Bordered	Prints with a border.
Date		Prints the image's creation date.

* Only selectable when printing with credit-card size paper.

Direct Print Function Compatible BJ Printer

<input type="checkbox"/> Paper		Select the paper size from the following. [Card #1], [Card #2], [Card #3], [LTR] or [A4] For the usable paper type, please refer to the Bubble Jet Printer User Guide.
<input type="checkbox"/> Borders	<input type="checkbox"/> Borderless	Prints right to the edges of the page.
	<input type="checkbox"/> Bordered	Prints with a border.
<input checked="" type="checkbox"/> Date		Prints the image's creation date.

- 1** In the print setting menu, choose [Style] using the up or down button and press the **SET** button again.

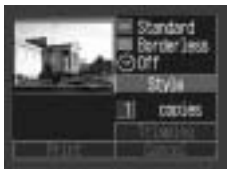

- 2** Choose [Image] (or [Paper]), [Borders] or [Date] using the up or down button.



3 Select settings using the left or right button.

 **Image Settings**
(Direct print compatible
CP series printer)



Select [Standard] or
[Multiple].

 **Paper**
(Direct print compatible
BJ printer)



Select [Card #1], [Card #2],
[Card #3], [LTR] or [A4].

 **Borders**



Choose [Borderless] or
[Bordered].

 **Date**



Choose [On] or [Off].

4 Press the MENU button.

If [Borderless] or [Multiple] is selected as the print style, the center portion of the recorded image (the image displayed on the LCD monitor) is printed at an enlarged size. As a result, the image's top, bottom and sides may be cropped slightly. The area of the image that will be printed will appear lighter than the rest of the image allowing you to check the portion that will be cropped.



- When printing multiple prints, the borders and the date cannot be set. (Images are printed without any date or borders)
- With the [Bordered] option, the border is printed in practically the same space as the recorded image.

Trimming (PowerShot A70)

You can specify which portion for an image gets printed.



Prior to Trimming

Please set the Print Style (Image Settings, Paper, Borders and Date) first before setting the trimming settings (p. 146).

1 In Replaying mode, press the SET button, choose [Trimming] using the up or down button and press the SET button again.

The trimming frame will appear at the center of the image. If a trimming setting has already been selected for the image, the frame will appear around the previously selected portion.

2 Trim the image.



Changing the Size of the Trimming Frame

- Turn the zoom lever toward **Q** or **■**.
- The trimming frame can be changed to a minimum selection of approximately half the displayed image or a maximum selection that is virtually the same size as the image.
- You can cancel the trimming setting by turning the zoom lever toward **■** again when the trimming frame is already set to the maximum size.
- When printing an image that has been magnified using the trimming option, the image quality may become coarser and grainier depending on the magnifying rate. With direct print function compatible printers, the trimming frame displays in red.

Setting the Portion of the Trimming Frame

Move the trimming frame using the up, down, left or right button.

Rotating the Trimming Frame

You can rotate the trimming frame by pressing the **DISP.** button.

3 Press the **SET** button to close the setting menu.



Trimming Frame





- The trimming setting only applies to one image.
- The trimming setting is cancelled with the following operations.
 - When you set the trimming settings for another image.
 - When you close the Print mode (when you turn the camera power off, change the camera mode, or detach the direct interface cable).
 - When you press the **MENU** button while in the trimming setting screen.
 - When you try to expand the trimming frame beyond its maximum size.



- The selected Image Settings, Paper and Border setting determine the shape of the trimming frame.
- Please use the LCD monitor to set the trimming settings. The trimming frame may not display correctly on a TV monitor.

Specifying the Printing Area (PowerShot A60)

Choose from three printing area options.

	Top	Prints the top area of an image.
	Middle	Prints the middle area of an image.
	Bottom	Prints the bottom area of an image.



Prior to Setting the Printing Area

- Please set the Print Style (Image Settings, Paper, Borders and Date) first before setting the printing area (p. 146).
- Can be set with the [Multiple] and [Borderless] options.

1 In replaying mode, press the SET button and choose [Printing area] using the up or down button.

The ◀▶ marks appear, indicating that you can now set the printing area for that image.

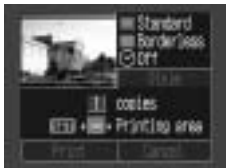

2 Select a printing area from , or using the left or right button.

When printing on L size paper, or when [Order] is set to [Multiple], the selectable print area may move left or right.



- The printing area setting only applies to one image.
- The printing area setting is cancelled with the following operations.
 - Printing
 - When you set the printing area setting for another image.
 - When you close the Print mode, i.e.
 - Turn the camera off
 - Change the camera mode
 - After setting the printing area, you select [Cancel] and don't print
 - Detach the DIF-100 direct interface cable



Print Settings (DPOF Print Settings)

You can select images on a CF card for printing and specify the number of print copies in advance using the camera. This is extremely convenient for sending the images to a photo developing service or for printing on a direct print function compatible printer (CP Series) or a direct print function compatible BJ printer.



- The  mark appears on images that have had print marks set by another DPOF-compliant camera. These settings will be overwritten by any print marks set by your camera.
- The output of some digital printers or photo lab services may not reflect the specified print settings.
- Print settings cannot be set for movie images.

Selecting Images for Printing

1 In the [ (Replay)] menu, select  (Print Order) and press the **SET** button.

See *Selecting Menus and Settings* (p. 43).

2 Select [Order] using the left or right button and press the **SET** button.



3 Select images for printing.

Single Images

- When the print type (p. 156) is set to [Standard] or [Both], select an image using the left or right button. You can set the number of copies (up to 99) to be printed using the up or down button.
- When the print type (p. 156) is set to [Index], select an image using the left or right button and mark or remove marks from images using the up or down button.
- You can use the same procedures to select images in index replay (3 images).

All the Images on a CF Card

- Switch to index replay (three images).
- You can set one copy of each image to print by pressing the **SET** button, then selecting [Mark All] using the up or down button, and pressing the **SET** button again.
- When the print type is set to [Standard] or [Both], the setting for the number of print copies can be changed for each image. When [Index] is selected, the print settings can be deleted. For the instructions on changing settings, please reread Step 3 from the beginning.
- You can cancel all the settings by selecting [Clear all].

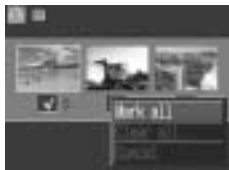







4 Press the MENU button.



- Images are printed in order from oldest to newest by the shooting date.
- A maximum of 998 images can be marked per CF card.
- Press the zoom lever in step 3 to switch between single and 3-image index replay for selecting an image.
- When [Print Type] is set to [Both], the number of copies can be set. When it is set to [Index], the number of copies cannot be set (only one copy will be printed).
- Print settings can also be assigned to images with the supplied software programs on a computer.

Setting the Print Style

The following print settings can be selected.



 Print Type	 Standard	Prints one image per page
	 Index	Prints index prints (multiple reduced-size images per page)
	  Both	Prints the images in both the standard and index formats
 Date		Adds the date to the print
 File No.		Adds the file number to the print

1 In the [ (Replay)] menu, select  (Print Order) and press the SET button.

See *Selecting Menus and Settings* (p. 43).

- 2** Select [Set up] using the left or right button and press the **SET** button.



- 3** Select  (Print Type),  (Date) or  (File No.) using the up or down button.

- 4** Select a setting using the left or right button.



 **(Print Type)**
Select [Standard], [Index],
or [Both].



 **(Date)**
Select [On] or [Off].



 **(File No.)**
Select [On] or [Off].

5 Press the MENU button.

The set up menu will close and the Print Order menu will reappear.



- When [Print Type] is set to [Index], the [Date] and [File No.] cannot be set to [On].
- If [Print Type] is set to [Both], both [Date] and [File No.] can be set to [On], however, only the file number is printed for the index print.



The date prints as the date and time in the format specified in the Set Date/Time menu (p. 26).

Resetting the Print Settings

The print settings can all be removed at once. The print type is reset to [Standard] and the date and file number options are set to [Off].

1 In the [(Replay)] menu, select (Print Order) and press the SET button.

See *Selecting Menus and Settings* (p. 43).

2 Select [Reset] using the left or right button and press the SET button.





3 Select [OK] using the left or right button and press the **SET** button.

If you decide you don't want to reset the settings, select [Cancel] and press the **SET** button.

Printing with DPOF Print Settings

You can use the DPOF print settings to print with an optional direct print function compatible printer (CP Series) or with a direct print function compatible BJ printer.

- 1** In the [ (Replay)] menu, select  (Print Order) and press the **SET** button.

See *Selecting Menus and Settings* (p. 43).

- 2** Select [Print] using the up, down, left or right button and press the **SET** button.



- 3** Set the print style settings as required.

- See *Setting the Print Settings* (p. 146).
- A print style cannot be set if the print type is set to [Index] in the DPOF print setting. (You can also select the type of paper when printing with a BJ printer)

4 Select [OK] using the up, down, left or right button and press the SET button.

The image will start to print and, when it is completely finished, the display will revert to the standard replay mode.



- To print the date, set the [Date] setting in the print order menu in Step 2 on the previous page to [On]. You cannot set the date to print with the [Style] menu in Step 3 on the previous page. If the print type is set to [Index], the date will not print even if the [Date] setting is set to [On] in Step 2.
- When the print type is set to [Both], it is possible to have both the [Date] and [File No.] options set to [On], but only the file number will print on the Index print. (With a BJ printer, the file number and the date cannot be printed in the [Index] option)
- When the print type is set to [Standard], file numbers will not be printed even if they are set to [On].



- The maximum number of images printed on one page in the Index print type depends upon the selected paper size.

- Card Size: 20 images
- L Size: 42 images
- Postcard Size: 63 images

(Please refer to your Bubble Jet's user guide for an explanation of the number of images printed with a Bubble Jet printer.)

Cancel Printing (p. 145)

Restarting Printing

- In the Print Order menu, select [Resume] using the left and right buttons and press the **SET** button. The remaining images can be printed.
- Printing cannot be restarted under the following circumstances.
 - If the print settings have been changed before restarting.
 - If the image for which the print settings were set has been deleted before restarting.
 - If there was very little free space on the CF card when the printing was cancelled.

If these circumstances apply, you can select [OK] in the Print Order menu and reprint starting from the first image. If printing was cancelled because the camera battery became discharged, you are recommended to power the camera with the AC Adapter Kit ACK600 or switch to AA size fully charged nickel metal hydride (NiMH) or unused alkaline batteries. After replacing the spent batteries, turn the camera power on again.

Printing Errors (p. 145)



Image Transfer Settings (DPOF Transfer Order)

Using the camera, you can make marks on images you wish to transfer and attach to e-mails. (Please use the supplied software for actually transferring images.) These settings are compatible with the Digital Print Order Format (DPOF) standards.



The  mark will display on images that have had transfer marks set by another DPOF-compliant camera. These settings will be overwritten by any marks set by your camera.

Selecting Images for Transferring

- 1** In the [ (Replay)] menu, select  (Transfer Order) and press the **SET** button.

See *Selecting Menus and Settings* (p. 43).

- 2** Select [Order] using the left or right button and press the **SET** button.



Pressing [Reset] cancels the transfer settings for all images on the CF card.

3 Select images for transferring.

Single Images

- Select an image using the left or right button and mark or remove marks from images using the up or down button.
- You can use the same procedures to select images in index replay (3 images).



All the Images on a CF Card

- Switch to index replay (three images).
- Press the **SET** button, select [Mark All] using the up or down button and press the **SET** button again. (If you select [Clear All] instead of [Mark All], you can remove marks from all the images.)
- You can mark or remove a mark from each image after marking or removing marks from all the images.

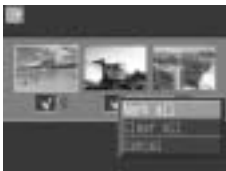

4 Press the MENU button.

The selection mode will turn off and the Transfer Order menu will reappear.



- Images are transferred in order from oldest to newest by the shooting date.
- A maximum of 998 images can be marked per CF card.

Viewing Images on a TV Set

A video-compatible television connected via the supplied AV cable AVC-DC100 can be used to view images as you shoot or replay them.

- 1 Turn off the camera (p. 30).**
- 2 Attach the AV Cable to the terminal on the camera.**

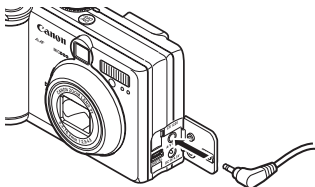

- 3 Plug the other ends of the AV cable to the video in and audio in jacks on the TV.**

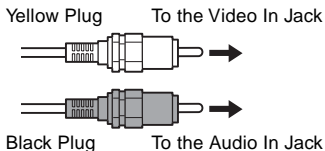

- 4 Turn on the TV and switch it to Video mode.**
- 5 Turn on the camera in Shooting mode or Replaying mode (p. 32).**
 - The image will appear on the TV. Shoot or replay images as usual.
 - If the images are not appearing on the TV when shooting, press the **DISP.** button.



- No image will appear on the LCD monitor when the camera is connected to a TV monitor.
- The video output signal can be switched (NTSC or PAL) to accommodate different regional standards (p. 181). The default setting will vary between regions.
NTSC: Japan, U.S.A., Canada, Taiwan, etc.
PAL: Europe, Asia (excluding Taiwan), Oceania, etc.
If an incorrect video system is set, the output image will not display properly.
- If the TV is a stereo model, you can plug the audio plug into either the left or right Audio In jack. Please refer to the TV's manual for details.
- A TV set cannot be used in  mode.

Downloading Images to a Computer

Download images taken with the camera to a computer in one of the following ways:

- **Connect the camera to a computer with the USB cable**

You can then download images directly from the camera to a computer.

- **Directly from the CF card**

Using a laptop computer or a card reader, you can download images directly from the CF card.

Connecting the Camera to a Computer Via the USB Cable

After the software is installed, you can use it to easily download images and print them or send them by email.

IMPORTANT

You must install the software and driver bundled on the supplied Canon Digital Camera Solution Disk onto your computer if you are using any of the following operation systems:

Windows 98 (including Second Edition)/Windows 2000/Windows Me
Mac OS 9.0 - 9.2



.....
The camera will not operate correctly if you connect it to your computer before installing the driver and software. If this happens, please refer to the *Troubleshooting* section of the *Software Starter Guide*.
.....

1 Install the driver and the software applications bundled on the Canon Digital Camera Solution Disk.

Please see the *Software Starter Guide* for information on system requirements and installation instructions.

2 Connect the supplied USB interface cable to the computer's USB port and the camera's DIGITAL terminal.

- You do not need to turn off the computer or camera when making a USB connection.
- Please refer to your computer manual for information regarding the location of the USB port.

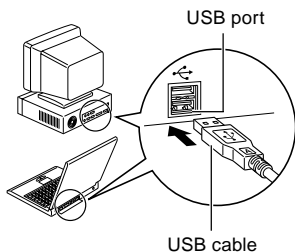

DIGITAL terminal

1. Open the terminal cover with your fingernail.
2. Insert the connector until it clicks.

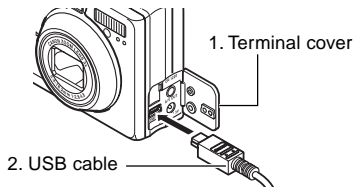

3 Set the camera's mode switch to  and press the **ON/OFF** button until the indicator next to the viewfinder starts **blinking green**.

The LCD monitor displays in replay mode.

When the connection to the computer is complete, the LCD monitor turns off and the green indicator lights steady.

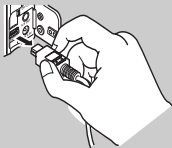

To disconnect the cable from the camera: Hold the cable connector firmly at both sides and pull it straight out.

For information about what to do after making the connection, please refer the *Software Starter Guide*.

Downloading Images without Installing the Software (Windows XP and Mac OS X (10.1 or 10.2) only)

If you are using Windows XP or Mac OS X (10.1 or 10.2), you can use the software distributed with these operating systems to download images (JPEG format only) without installing the software bundled on the Canon Digital Camera Solution Disk. This is useful for downloading images to a computer in which the software is not installed.

However, please note that there are certain limitations to downloading images with this method. For more details, please refer to the supplied *For Windows® XP and Mac OS X Users Leaflet*.

- 1** Connect the supplied USB interface cable to the computer's USB port and the camera's DIGITAL terminal. (Refer to step 2 on page 168)
- 2** Follow the onscreen instructions to download the images.



- It is recommended to power the camera with the optional AC Adapter Kit ACK600 when connected to a computer (p. 195).
- If you disconnect the USB cable while the camera is on, the camera will automatically turn off.
- All procedures performed with a connection to a USB 2.0 compliant board are not guaranteed.

Downloading Directly from a CF Card

- 1 Eject the CF card from the camera, and insert it into a CF card reader connected to the computer.**

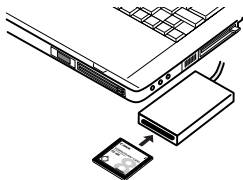

- If you are using a PC card reader, first insert the CF card into a PC card adapter (optional), and then insert the PC card adapter into the computer's PC card reader.

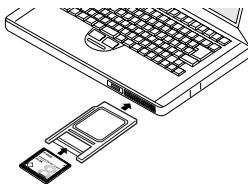





- 2 Double-click the icon of the drive with the CF card.**
- 3 Copy images from the card into a folder of your choice on the hard disk.**













The images are stored in the [xxxCANON] folders located under the [DCIM] folder (where xxx is a three-digit number from 100 to 998).









List of Menu Options and Messages

FUNC. Menu

* Default setting





Item/ Menu Screen	Setting Content	Reference Page
Exposure Compensation 	Sets the exposure compensation. -2 ... 0 ... +2	101
Flash Output 	Adjusts the flash output in M mode.	112
White Balance 	Sets the white balance. <ul style="list-style-type: none"> • AWB (Auto)* • ☀ (Day Light) • ☁ (Cloudy) • ⚡ (Tungsten) • ⚡ (Fluorescent) • ⚡ (Fluorescent H) • 🎨 (Custom) 	103
Drive Mode 	Sets Continuous shooting settings and the self-timer. <ul style="list-style-type: none"> • □ (Standard Shooting)* • 📄 (Continuous Shooting) • ⌚ (Self-timer, 10 sec.) • ⌚ (Self-timer, 2 sec.) 	83 87

Item/ Menu Screen	Setting Content	Reference Page
ISO Speed 	Sets the sensitivity at which images are recorded. <ul style="list-style-type: none"> • 50* • 100 • 200 • 400 • AUTO 	110
Photo Effect 	Switches between photo effects. <ul style="list-style-type: none"> •  (Effect Off)* •  (Vivid) •  (Neutral) •  (Low Sharpening) •  (Sepia) •  (B/W) 	108
Light Metering System 	Switches between light metering modes. <ul style="list-style-type: none"> •  (Evaluative)* •  (Center Weighted Avg.) •  (Spot) 	99
Resolution (Stills) 	Sets the number of pixels used for images. <p>(PowerShot A70)</p> <ul style="list-style-type: none"> • L Large (2048 x 1536 pixels)* • M1 Medium 1 (1600 x 1200 pixels) • M2 Medium 2 (1024 x 768 pixels) • S Small (640 x 480 pixels) <p>(PowerShot A60)</p> <ul style="list-style-type: none"> • L Large (1600 x 1200 pixels)* • M Medium (1024 x 768 pixels) • S Small (640 x 480 pixels) 	64

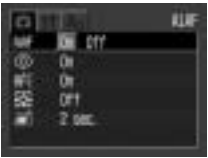







Item/ Menu Screen	Setting Content	Reference Page
Resolution (Movies) 	Sets the number of pixels used for images. <ul style="list-style-type: none"> •  (640 x 480 pixels) (PowerShot A70 only) •  (320 x 240 pixels)* •  (160 x 120 pixels) 	64
Compression 	Sets the relative compression ratio used for images. <ul style="list-style-type: none"> •  Superfine •  Fine* •  Normal 	64

Rec. Menu



Item/ Menu Screen	Setting Content	Reference Page
	Sets the AiAF to on (the camera automatically selects the AF frame when taking a picture) or off (AF frame is set to the middle frame). <ul style="list-style-type: none"> • On* • Off 	98

Item/ Menu Screen	Setting Content	Reference Page
 <p>Red-eye</p>	<p>Sets whether or not the red-eye reduction lamp fires.</p> <ul style="list-style-type: none"> • On* • Off 	68
 <p>AF-assist Beam</p>	<p>Sets the output of the AF-assist beam according to shooting conditions when using the auto focus.</p> <ul style="list-style-type: none"> • On* • Off 	41
 <p>Digital Zoom</p>	<p>Sets whether or not the digital zoom combines with the optical zoom to zoom images.</p> <ul style="list-style-type: none"> • On • Off* 	85
 <p>Review</p>	<p>Sets the duration images display on the LCD monitor after the shutter button is released.</p> <ul style="list-style-type: none"> • Off • 2 sec.* to 10 sec. 	63



Replay Menu





Item/ Menu Screen	Setting Content	Reference Page
<p> Protect</p> 	<p>Protects images from accidental erasure.</p>	<p>131</p>
<p> Rotate</p> 	<p>Rotates images 90 or 270 degrees clockwise in the display.</p>	<p>127</p>
<p> Sound Memo</p> 	<p>Adds sound memos to images.</p>	<p>128</p>
<p> Erase all</p> 	<p>Erases all images from a CF card (excluding protected images).</p>	<p>133</p>



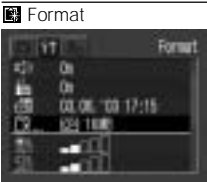

* Default setting

Item/ Menu Screen	Setting Content	Reference Page
 <p>The image shows a menu screen with the following options: Rotate, Sound Menu, Erase all, Auto Play (highlighted), Print Order, and Transfer Order.</p>	Plays images automatically one after the other.	130
 <p>The image shows a menu screen with the following options: Rotate, Sound Menu, Erase all, Auto Play, Print Order (highlighted), and Transfer Order.</p>	Sets which images and how many copies will be printed on a printer with the direct print function or at a photo lab service.	154
 <p>The image shows a menu screen with the following options: Rotate, Sound Menu, Erase all, Auto Play, Print Order, and Transfer Order (highlighted).</p>	Sets the images that will be transferred with your e-mail software.	163

Set up Menu



Item/ Menu Screen	Setting Content	Reference Page
 <p>The Beep menu screen shows the 'Beep' option set to 'Off'. The screen also displays camera status information such as '17', '00:00:00 03:17:15', and '100%'.</p>	<p>Sets whether or not the beep sounds when the shutter button is pressed or when a menu operation is performed. See also "How the [Beep] setting in the [17] (Set up)] menu and each sound setting in the [25] (My Camera)] menu are related" on page 183.</p> <ul style="list-style-type: none"> • On* • Off (still beeps to warn of an error even when set to Off) 	<p>–</p>
 <p>The Auto Power Down menu screen shows the 'Auto Power Down' option set to 'Off'. The screen also displays camera status information such as '17', '00:00:00 03:17:15', and '100%'.</p>	<p>Sets whether or not the camera automatically powers down after a specified period of time elapses without something being pressed.</p> <ul style="list-style-type: none"> • On* • Off 	<p>31</p>
 <p>The Date/Time menu screen shows the 'Date/Time' option set to 'Off'. The screen also displays camera status information such as '17', '00:00:00 03:17:15', and '100%'.</p>	<p>Sets the date, time and date format.</p>	<p>26</p>
 <p>The Format menu screen shows the 'Format' option set to 'Off'. The screen also displays camera status information such as '17', '00:00:00 03:17:15', and '100%'.</p>	<p>Formats (initializes) a CF card.</p>	<p>134</p>





Item/ Menu Screen	Setting Content	Reference Page
	Adjusts the sound volume when the shutter button is pressed all the way. There is no shutter sound in Movie mode. <ul style="list-style-type: none"> • □□□□ (Off) • ■□□□ (1) • ■■□□ (2)* • ■■■□□ (3) • ■■■■□□ (4) • ■■■■■ (5) 	40
	Adjusts the sound volume when a sound memo or a movie is played. <ul style="list-style-type: none"> • □□□□ (Off) • ■□□□ (1) • ■■□□ (2)* • ■■■□□ (3) • ■■■■□□ (4) • ■■■■■ (5) 	122 128
	Adjusts the sound volume when the camera powers up. <ul style="list-style-type: none"> • □□□□ (Off) • ■□□□ (1) • ■■□□ (2)* • ■■■□□ (3) • ■■■■□□ (4) • ■■■■■ (5) 	30
	Adjusts the sound volume of the Operation Sound. <ul style="list-style-type: none"> • □□□□ (Off) • ■□□□ (1) • ■■□□ (2)* • ■■■□□ (3) • ■■■■□□ (4) • ■■■■■ (5) 	-



















Item/ Menu Screen	Setting Content	Reference Page
	<p>Adjusts the sound volume of the Selftimer Sound.</p> <ul style="list-style-type: none"> • □□□□ (Off) • ■□□□ (1) • ■■□□ (2)* • ■■■□□ (3) • ■■■■□ (4) • ■■■■■ (5) 	83
	<p>Sets how file numbers are assigned to images when new CF cards are inserted.</p> <ul style="list-style-type: none"> • On • Off* 	116
	<p>Sets the format of the MF indicator's displayed distance units.</p> <ul style="list-style-type: none"> • m/cm* • ft/in 	115
	<p>Sets the language used in the menus and messages on the LCD monitor. The menu may appear differently in some regions.</p> <ul style="list-style-type: none"> • English* • Deutsch • Français • Nederlands • Dansk • Suomi • Italiano • Norsk • Svenska • Español • Chinese • Japanese <p>You can change the language during image replay by holding the SET button and pressing the JUMP button. (Except the camera is connected to a printer)</p>	28



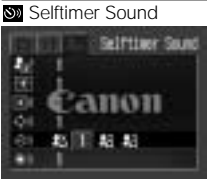

Item/ Menu Screen	Setting Content	Reference Page
	Sets the video output signal standard. <ul style="list-style-type: none"> • NTSC* • PAL 	165

My Camera Menu



You can select the theme, start-up image and sound, shutter sound, operation sound and selftimer sound used on this camera. These are called My Camera settings. You can also customize the [] and [] options for each item with images recorded on the CF card and newly recorded sounds or by using the supplied software. See the *Software Starter Guide* for details.

Item/ Menu Screen	Setting Content	Reference Page
	Selects a common theme for each My Camera settings item. *1 <ul style="list-style-type: none"> •  (Off) •  * •  •  	52













Item/ Menu Screen	Setting Content	Reference Page
 <p>Start-up Image</p>	<p>Sets the start-up image when you turn on the camera.</p> <ul style="list-style-type: none"> •  (Off) •  * •  •  	52
 <p>Start-up Sound</p>	<p>Sets the start-up sound when you turn on the camera.*1</p> <ul style="list-style-type: none"> •  (Off) •  * •  •  	52
 <p>Operation Sound</p>	<p>Sets the sound when the multicontroller or any button other than the shutter button is operated.*1</p> <ul style="list-style-type: none"> •  (Off) •  * •  •  	52
 <p>Selftimer Sound</p>	<p>Sets the sound informing you that the photo will be taken in 2 seconds.*1</p> <ul style="list-style-type: none"> •  (Off) •  * •  •  	52

Item/ Menu Screen	Setting Content	Reference Page
	Sets the shutter sound when you depress the shutter button. There is no shutter sound while a movie is being shot.*1 •  (Off) •  * •  • 	52

*1 How the [Beep] setting in the [(Set up)] menu and each sound setting in the [(My Camera)] menu are related

To actually turn off the sound of the start-up sound, shutter sound, operation sound, and self-timer sound individually, [Beep] in the [ (Set up)] menu must be set to [Off]. If [Beep] is set to [On], the beep sounds even if each sound item in the [ (My Camera)] menu is set to [Off].

For details, see the table below.

		The settings of [Beep] in the [ (Set up)] menu	
		[On]	[Off]
The settings of each sound item in the [ (My Camera)] menu ([Start-up Sound]/[Shutter Sound]/[Operation Sound]/[Selftimer Sound])		● [Beep]	–
		● 	● 
		● 	● 
		● 	● 

●: The sound specified in [] sounds.

–: No sound

Resetting the Settings to Default

You can reset all of the menu and button operation settings to default except for [Date/Time], [Language], and [Video System].

1 Turn on the camera.

The mode dial can be turned to any setting.

2 Press the **MENU** button for longer than 5 seconds.

The message "Reset settings to default?" appears on the LCD monitor.



3 Select **[OK]** using the left and right buttons, then press the **SET** button.

- The screen below appears while resetting. The normal screen resumes when resetting is complete.

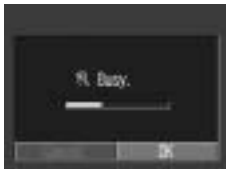

- To cancel resetting, select [Cancel] instead of [OK].



- The custom white balance is not cancelled even if settings are reset to default settings. (p. 105)
- Settings cannot be reset when the camera is connected to a computer, to an optional direct print function compatible printer (CP series) or to a direct print function compatible BJ printer (optional).

List of Messages

The following messages may appear on the LCD monitor.

Busy...:	Image is being recorded to, or read from, CF card. Resetting settings to default.
No Memory card:	You attempted to shoot or replay images without a CF card installed.
Cannot record!:	You attempted to shoot an image without a CF card installed.
Memory card error:	CF card has experienced an anomaly.
Memory card full:	CF card is too full to save more images or print settings.
Naming error!:	The file could not be created because there is a file with the same name as the directory that the camera is attempting to create, or the highest possible file number has already been reached. In the Rec. menu, please set [File No.] Reset to [On]. After you save all the images you wish to retain onto a computer, format the CF card (p. 136). Please note that formatting will erase all the existing images and other data.
Change the batteries:	Battery charge is insufficient to operate the camera. Replace with new AA-size alkaline batteries or fully charged batteries (Be sure to replace all batteries at the same time.).
No image:	No images recorded on CF card.
Image too large:	You attempted to replay an image larger than 3200 x 2400 pixels.
Incompatible	
JPEG format:	You attempted to replay an incompatible JPEG file.
Corrupted data:	You attempted to replay an image with corrupted data.
RAW:	You attempted to replay an image recorded in an incompatible RAW format.

Unidentified Image:	You attempted to replay an image that was recorded in a special format (proprietary format used by the camera of another manufacturer, etc.).
Cannot magnify!:	You attempted to magnify an image that was photographed with another camera, recorded in a different format, or edited on a computer.
Cannot rotate:	You attempted to rotate an image that was photographed with another camera, recorded in a different format, or edited on a computer.
Incompatible Wave format:	Cannot attach sound memo to the image because the image has some sound file recorded in an inappropriate format.
Cannot register this image!:	You attempted to register an image recorded with another camera as a start-up image.
Protected!:	You attempted to erase a protected image.
Too many marks:	Too many images have been marked for printing or for inclusion in a slide show. Cannot process any more.
Cannot mark image:	You attempted to set the print settings for a non-JPEG file.
Exx:	(xx: number) Camera malfunction. Turn the power off and then back on, then shoot and replay. A problem exists if the error code reappears. Note the number and contact our Canon Customer Support Help Desk. If an error code displays directly after taking a picture, the shot may not have been recorded. Check image in replay mode.

The following messages may appear on the camera's LCD monitor when a direct print compatible printer is printing. Depending on the printer model, some messages may not display.

No Paper:	Paper cassette is incorrectly inserted or out of paper. Or the paper feed isn't operating correctly.
No Ink:	The ink cartridge has not been inserted or has run out of ink.
Incompatible paper size:	Wrong paper size is loaded in the printer.
Incompatible ink size:	Wrong ink cassette size is loaded in the printer.
Ink Cassette Error:	The ink cassette is experiencing a problem.
Paper and ink do not match:	The paper and ink are from different sets.
Paper Jam:	The paper jammed during printing.
Paper has been changed:	Paper was changed after the print menu was displayed.
Recharge the printer battery:	The printer's battery pack is depleted.
Communication Error:	The printer is experiencing a data transmission error.
Readjust trimming:	You attempted to print the image with a different style than the one used when the trimming settings were set.
Cannot Print!:	You attempted to print an image from another camera, one recorded in a different format, or one that has been edited on a computer.

Could not print xx images:	You attempted to use the DPOF print settings to print xx images that are from another camera, that have been recorded in a different format, or that have been edited on a computer.
-----------------------------------	--

The following messages may appear when the camera is connected to the direct print compatible Bubble Jet Printer.

Check the error number displayed on the control panel of Bubble Jet Printer and refer to the Bubble Jet Printer *Quick Start Guide*.

(The message or error code may not display with some models.)

Printer in use:	The printer is printing the data from the memory card inserted in the computer or printer. The printer automatically starts printing the images from the camera after completing the current printing.
Printer warming up:	Printer is warming up. When it is ready, the printer starts printing automatically.
No print head:	No print head is installed in the printer.
Printer cover open:	Close the printer cover securely.
Media type error:	You selected a paper type incompatible with the printer. Select a compatible paper type in the Print Style menu.
Paper lever error:	Adjust the paper selection lever to the proper position.
Low ink level:	The ink tank needs to be replaced soon. Prepare a new ink tank. If you select [Continue] in the error screen, you can restart printing. (This message will not appear on some models)

Waste tank full: You can restart printing by pressing the RESUME/CANCEL button on Bubble Jet Printer. Please request replacement of the waste tank at your nearest Canon customer support center listed in the Bubble Jet Quick Start Guide.

Printer error: Turn off the printer, then turn it on again. If the error persists, please consult your nearest Canon customer support center listed in the Bubble Jet Quick Start Guide.

Appendices

Replacing the Date Battery

The camera uses a special Date battery to power its internal clock. If the LCD monitor displays the Set Date/Time menu when you turn on the camera, this means that the Date battery has run down and the clock has stopped running. Please purchase a replacement battery (battery type CR1220) and install it as follows. **(The date battery is preinstalled at the factory and may therefore expire earlier than its rated lifespan after the camera has been purchased.)**



Be particularly careful to keep the date batteries out of the reach of children. Seek medical assistance immediately if a child swallows a battery since corrosive battery fluids could damage the stomach or intestinal wall.

- 1** Be sure that the camera is turned off.
- 2** Open the DIGITAL terminal cover.
- 3** Pull out the date battery holder.

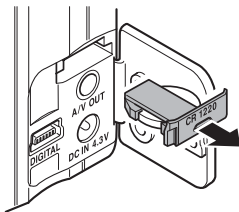

- 4** Pull the battery out of the holder, as shown.

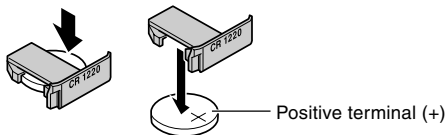

- 5** Insert the new date battery into the holder, with the positive terminal (+) facing up.

- 6** Replace the date battery holder back into its original position, and close the **DIGITAL** terminal cover.

- 7** When the LCD monitor displays the Set Date/Time menu, proceed to set the current date and time (p. 26).



.....
The LCD monitor also displays the Set Date/Time menu the very first time you turn on the camera. This is normal, and does not mean that the date battery is depleted.
.....

If you should dispose of your camera, first remove the date battery for recycling according to the recycling system of your country.



Using the Optional Battery Kits

Using Rechargeable Batteries (Battery and Charger Kit CBK100)

Included are the battery charger and four rechargeable AA-size NiMH (nickel metal hydride) batteries. Charge batteries as shown below.

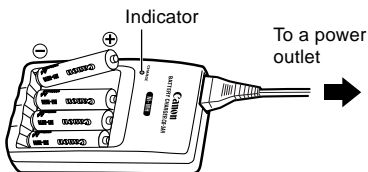

- The indicator blinks while charging, then comes on solid when charging is finished.



- This charger can be used only to charge Canon AA-size NiMH batteries. Please do not attempt to charge any other type of batteries with this charger.
- Never mix new batteries together with batteries that have been used in other devices.
- When recharging batteries from the camera, always recharge all four of them at the same time.
- All batteries you place in the charger should be at approximately the same charge state, and should have been purchased at the same time. Don't mix batteries with different purchase dates or different charge states.
- Do not attempt to recharge fully charged batteries, as doing so may reduce or impair battery performance. Also, do not charge batteries for more than 24 consecutive hours.
- Do not recharge batteries in enclosed areas that tend to retain heat.

- Repeatedly recharging batteries before they become fully depleted may cause batteries to lose capacity. Do not recharge the batteries until the LCD monitor displays the “Change the batteries” message.
- Wipe the battery terminals well with a dry cloth in the following situations, as the terminals may be soiled with oil from one’s skin or other dirt:
 - If the battery usage time has considerably diminished
 - If the number of recordable images has considerably diminished
 - When charging the batteries (insert and remove the batteries two or three times before charging)
 - When charging completes in a matter of a few minutes (the battery charger indicator remains lit)
- You may not be able to fully charge the batteries due to their specifications right after purchase or after long periods of non-use. If this happens, use the batteries until their charge is depleted before charging them again. After doing this several times, battery performance will be restored.
- Since storing a fully charged battery pack for long periods of time (about 1 year) can shorten its lifecycle or affect performance, you are recommended to use the battery pack in the camera until it is completely discharged and to store it at normal temperature (23° C/73° F) or less. If you do not use the battery pack for long periods of time, charge it fully and discharge it fully in the camera at least once a year before returning it to storage.
- If battery usage time is considerably low despite their terminals’ being wiped and the battery charger’s indicator remaining lit, it is possible that the batteries have reached the end of their lifespan. Switch to different, unused batteries. If you are purchasing new batteries, look for Canon’s AA-size NiMH batteries (four-piece set).
- Leaving batteries in the camera or charger may damage it causing battery leakage. Remove batteries from the camera or charger and store in a dry cool location when not in use.



- It takes approximately 220 minutes for the charger to fully recharge the batteries (as determined by testing at Canon facilities). Please do not charge batteries in areas where the temperature is outside the range of 0 to 35 °C (32 to 95 °F).
- Charging time varies according to ambient temperature and to the batteries' initial charge state.

Using the AC Adapter Kit ACK600

This optional adapter kit allows you to operate the camera continuously without worrying about having to stop and replace the batteries. Use of the kit is recommended when you are planning long sessions with the camera, and whenever you connect the camera to a computer.



Be sure that the camera is turned off before connecting or disconnecting the compact power adapter.

1 Connect the power cord to the compact power adapter, and then plug the other end into the power outlet.

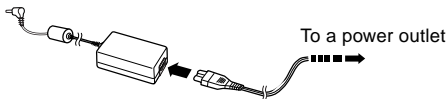

- 2 Open the **DIGITAL** terminal cover, and connect the adapter's DC plug into the camera's DC IN terminal.

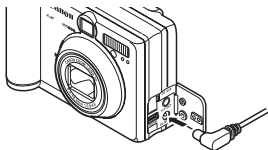

Please unplug the adapter from the power outlet when you have finished using the camera.



.....
Please do not attempt to use any AC adapter other than AC Adapter Kit ACK600 with your camera. Use of a different adapter may result in damage to the camera or to the adapter.
.....

Using the Optional Lenses and Lens Adapter

The camera supports use of the optional Wide Converter WC-DC52, Tele-converter TC-DC52 and Close-up Lens 250D (52 mm). In order to attach any of these lenses, you also need to use the optional Conversion Lens Adapter LA-DC52C.



- When attaching the wide converter, tele-converter or close-up lens, be sure to screw it on securely. If they come loose they may fall from the lens adapter, posing risk of injury from shattered glass.
- Never look into the sun or into strong light through the wide converter, tele-converter or the close-up lens, as this can result in blindness or impairment of vision.

Wide Converter WC-DC52

Use this converter for taking wide-angle shots. The wide converter changes the focal length of the camera body's lens by a factor of 0.7 (The thread diameter is 52 mm.).



Tele-converter TC-DC52

This 52 mm-threaded diameter magnifying conversion lens is for taking telephoto shots. The lens changes the focal length of the camera body's lens by a factor of 2.4x.



Close-Up Lens 250D (52 mm)

This lens makes it easy to take macro shots. With the camera set to Macro mode, you can use this option to shoot subjects that are 3 to 25 cm (1.2 to 9.8 in.) at wide angle end and 13 to 25 cm (5.1 to 9.8 in.) at telephoto end from the lens tip.





- It is not possible to attach a lens hood or filter to the wide converter or tele-converter.
- If you use the flash when shooting with the wide converter, the outer area of the recorded image (and especially the lower right corner) will come out relatively dark.
- The wide converter blocks part of the view through the viewfinder.
- When using the wide converter, please set the camera to wide angle end.
- When using the tele-converter, please set the focal length to telephoto end. At other zoom settings, the image will appear as if its corners have been cut off.

Shooting Ranges in Macro Mode

	Distance between Lens tip and Subject	Field Coverage
At maximum telephoto	13 cm (5.1 in.)	48 × 36 mm (1.9 × 1.4 in.)
	25 cm (9.8 in.)	82 × 61 mm (3.2 × 2.4 in.)
At maximum wide angle	3 cm (1.2 in.)	49 × 37 mm (1.9 × 1.5 in.)
	25 cm (9.8 in.)	230 × 173 mm (9.1 × 6.8 in.)

Conversion Lens Adapter LA-DC52C (52 mm)

This optional adapter is required for attaching the wide converter, tele-converter and close-up lens (all optional).



Attaching a Lens

- 1** Be sure that the camera is turned off.
- 2** Press the ring release button and hold it down, and turn the ring in the direction of the arrow.

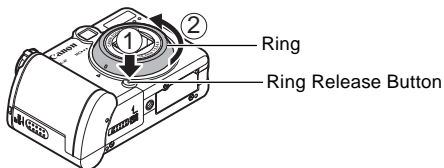

- 3** When the • marks on the ring and the camera are aligned, lift off the ring.

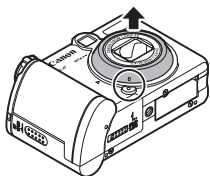

- 4** Align the ● marks on the Conversion Lens Adapter and the camera, and turn the adapter in the direction of the arrows as far as the ▲ mark on the camera.

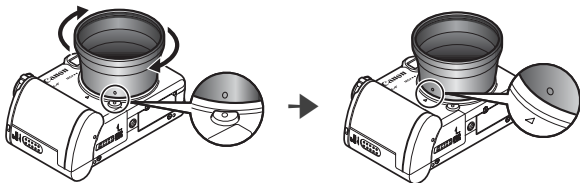

- 5** Set the lens on the adapter, and attach it securely by turning it in the indicated direction.

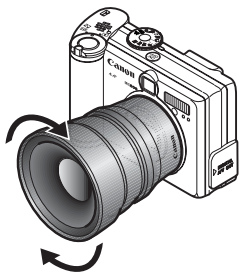



- Completely remove all dust and dirt from conversion lenses with a lens blower brush before use. The camera may focus on any dirt that remains.
- Exercise due caution when handling the lenses since it is easy to dirty them with finger prints.
- Be careful not to drop the camera or adapter when removing the ring.
- When shooting with these attachments, please use the LCD monitor to compose your shots. The attachments block part of the view through the viewfinder, and the area shown in the viewfinder does not match the area of the shot that is actually recorded.
- You should not shoot images in  mode when using these attachments. Although it is possible to select this mode at the camera, the PhotoStitch software will not be able to stitch the images together at the computer.

Camera Care and Maintenance

Use the following procedures to clean the camera body, lens, viewfinder, LCD monitor and other parts.

Camera Body	Wipe the camera body with a soft cloth or eyeglass lens wiper.
Lens	First use a lens blower brush to remove dust and dirt, then remove any remaining dirt by wiping the lens lightly with a soft cloth. <ul style="list-style-type: none">• Never use synthetic cleansers on the camera body or lens. If dirt remains, contact the closest Canon Customer Support Help Desk as listed on the separate Canon Customer Support leaflet.
Viewfinder, LCD monitor	Use a lens blower brush to remove dust and dirt. If necessary, gently wipe the viewfinder and LCD monitor with a soft cloth or an eyeglass lens wiper to remove stubborn dirt. <ul style="list-style-type: none">• Never rub or press forcefully on the LCD monitor. These actions may damage it or lead to other problems.



.....
Never use water, paint thinner, benzene, or detergents to clean the camera, as these may cause damage or deformation.
.....

Troubleshooting

Problem	Cause	Solution
Camera will not operate	Power is not turned on	Press the ON/OFF button for a few moments.
	CF card slot cover or battery cover opened	Confirm that the CF card slot cover or battery cover is securely closed.
	Batteries are loaded in the wrong direction.	Reload the batteries in the correct direction.
	Insufficient battery voltage	<ul style="list-style-type: none"> • Replace with unused alkaline or fully recharged batteries (four AA-size batteries.) • Use an AC adapter.
	Batteries are not the right type.	Use only unused AA-size alkaline batteries or Canon AA-size NiMH batteries. (For information about alkaline batteries, see <i>Proper Battery Handling</i> (p. 21))
	Poor contact between camera and battery terminals	Wipe the terminals with a clean, dry cloth.
Camera will not record	The mode switch is set to  (Replay).	Switch the camera to Shooting mode.



Problem	Cause	Solution
Camera will not record	Flash is charging	Wait until the orange indicator stops blinking and lights steadily, signaling that the flash is charged, then press the shutter button.
	CF card full	<ul style="list-style-type: none"> • Insert a new CF card. • If required, download the images to a computer and erase them from the CF card to make space.
	CF card not formatted correctly	<ul style="list-style-type: none"> • Format CF card. ➔ See <i>Formatting a CF card</i> (p. 134). • If reformatting doesn't work, the CF card logic circuits may be damaged. Contact the nearest Canon Customer Support Help Desk.
Lens will not retract	CF card slot cover or battery cover opened with camera on	Close the CF card slot cover or battery cover, then turn off the camera.
	CF card slot cover or battery cover opened while camera was recording to CF card (warning signal)	Close the covers, and then use the ON/OFF button to turn the power off correctly.

Problem	Cause	Solution
Battery pack consumed quickly	Batteries are not the right type.	Use only unused AA-size alkaline batteries or Canon AA-size NiMH batteries. (For information about alkaline batteries, see <i>Proper Battery Handling</i> (p. 21))
	The batteries are cold.	Battery performance deteriorates at low temperatures. If shooting in a cold area, keep the batteries warm (by placing them in an inner pocket, etc.) until ready to use them.
	Battery terminals are dirty.	Wipe them well with a dry cloth before use.
	The batteries have not been used for over a year.	If batteries are rechargeable: Performance should return to normal after several charging cycles.
	If rechargeable batteries: The batteries have lost their effectiveness.	Discard all 4 batteries and replace with new ones.
	If using rechargeable batteries: Batteries do not charge.	Batteries were placed in the charger in the wrong direction.

Problem	Cause	Solution
If using rechargeable batteries: Batteries do not charge.	Poor electrical contact.	<ul style="list-style-type: none"> • Be sure to set batteries firmly into the charger. • Be sure that the power cord is firmly connected to the charger, and is firmly plugged in to the power outlet.
	Battery terminals are dirty.	Wipe them well with a dry cloth before charging.
	Battery life exceeded.	Replace all 4 batteries with new ones.
Shots are blurry or unfocused.	The camera was moving when you took the shot.	Hold the camera steady when shooting.
	Autofocus function hampered by obstruction to AF-assist beam.	Be careful not to block the AF-assist beam with your finger or other items.
	The AF-assist beam has been set to [Off] through the menu.	Set the AF-assist beam to [On].

Problem	Cause	Solution
Shots are blurry or unfocused.	The subject was outside the range over which the camera can focus.	<ul style="list-style-type: none"> • Ensure that there is at least 46 cm (1.5 ft.) between the camera lens and subject. • Use the macro mode to shoot close-ups between 5 to 46 cm (2.0 in. to 1.5 ft.) from the lens when set to wide angle and between 26 to 46 cm (10 in. to 1.5 ft.) when set to telephoto.
	Subject is hard to focus on.	Use the focus lock or the manual focus to shoot the image. ➔ See <i>Shooting Problem Subjects for the Autofocus</i> (p. 113)
The subject comes out underexposed (too dark).	Insufficient light for shooting.	Set the flash on.
	The subject is darker than the surroundings.	Set exposure compensation to a positive value or use spot AE point light metering.
	The subject is beyond the range of the flash.	When flash is used, the distance between lens and subject should not exceed 4.2 m (14 ft.) at wide angle end or 2.5 m (8.2 ft.) at telephoto end setting.

Problem	Cause	Solution
The subject comes out overexposed (too bright).	The subject is too close to the flash.	When flash is used, the distance between lens and subject should be no less than 26 cm (10 in.).
	The subject is brighter than the surroundings.	Set exposure compensation to a negative value.
	Light is shining or reflecting into the camera.	Adjust the camera angle.
	The flash mode is set so that the flash always fires.	Set the flash to any other mode except On.
A red bar of light appears on the upper part of the LCD monitor	Subject is too bright	This is a normal occurrence in devices containing CCDs and does not constitute a malfunction. (This red bar of light will not be recorded when shooting still photos, but it will be recorded when shooting movies.)

Problem	Cause	Solution
White dots or white asterisks appear on the image	Light from the flash has reflected off dust particles or insects in the air. This occurs more frequently in the following conditions: - When shooting at the wide-angle end. - When shooting with a high aperture value in the aperture-priority AE mode.	This is a phenomenon that occurs with digital cameras and does not constitute a malfunction.
The flash doesn't fire.	The flash mode is set to Off.	Set the flash to any other mode except Off.
Image not showing on TV.	Incorrect video system setting.	Set the video system to the appropriate setting, NTSC or PAL, for your TV.
	The mode dial is turned to  (stitch assist).	Turn the mode dial to any mode other than  .
Zoom does not operate.	Zoom button was pressed while shooting in movie mode.	Operate the zoom before shooting in movie mode.
Reading images from CF card is slow	CF card was formatted in another device	Use a CF card formatted in your camera. See <i>Formatting a CF Card</i> (p. 134)
Recording images to CF card takes a long time		

Specifications

All data is based on Canon's standard testing methods.
Subject to change without notice.

PowerShot A70 / PowerShot A60	
Camera effective pixels	A70 : Approx. 3.2 million A60 : Approx. 2 million
Image Sensor	A70 : 1/2.7 in. CCD (Total number of pixels: approx. 3.3 million) A60 : 1/2.7 in. CCD (Total number of pixels: approx. 2.1 million)
Lens	: 5.4 (W) – 16.2 (T) mm (35 mm film equivalent: 35 – 105 mm), F 2.8 (W) – 4.8 (T)
Digital Zoom	A70 : Maximum approx. 3.2× (Maximum approx. 9.6× with optical zoom) A60 : Maximum 2.5× (Maximum 7.5× with optical zoom)
Optical Viewfinder	: Real-image zoom viewfinder
LCD Monitor	: 1.5-inch, low-temperature polycrystalline silicon TFT color LCD, approx. 78,000 pixels, picture coverage=100%
Autofocus	: TTL Autofocus 5-point AiAF/1-point AF 1-point AF: center
Focusing Range	: Normal : 46 cm (1.5 ft.) – ∞ Macro : 5 – 46 cm (2.0 in. – 1.5 ft.) (W)/ 26 – 46 cm (10 in. – 1.5 ft.) (T)
Shutter	: Mechanical + electronic
Shutter Speed	: 15 – 1/2000 sec. • 15 – 1.3 sec. in Shutter-priority AE mode or manual mode only • Noise reduction processing on speeds slower than 1.3 sec.
Light Metering Method	: Evaluative metering (linked to focusing point) / Center-weighted average metering / Spot metering
Exposure Control	: Program AE, Shutter-priority AE, Aperture-priority AE or Manual exposure
Exposure Compensation	: +/- 2 stops in 1/3-stop increments

(W): wide angle (T): telephoto

Sensitivity	: AUTO/ISO 50/100/200/400 equivalent
White Balance	: TTL auto/preset (daylight, cloudy, tungsten, fluorescent, fluorescent H) or Custom white balance
Flash	: Auto, On, Off Red-eye reduction On: Red-eye reduction auto/Red-eye reduction On/Flash Off Red-eye reduction Off: On/Off
Flash Range	: Normal Mode: 46 cm – 4.2 m (1.5 – 14 ft.) (W), 46 cm – 2.5 m (1.5 – 8.2 ft.) (T) Macro Mode: 26 – 46cm (10 in. – 1.5 ft.) (W/T)
Shooting Modes	: Auto Creative zone: Program, Shutter Speed Priority, Aperture Priority and Manual Image zone: Portrait, Landscape, Night Scene, Fast Shutter, Slow Shutter, Stitch Assist and Movie
Continuous Shooting	: PowerShot A70: Approx. 2.2 images/sec. PowerShot A60: Approx. 2.6 images/sec. (Large/Fine mode, LCD monitor off)
Self-Timer	: Shoots after approx. 2 sec. or approx.10 sec.
PC Connected Shooting	: Available (USB connection only. Exclusive software program "RemoteCapture" is included in the camera kit.)
Recording Media	: CompactFlash card (Type I)
File Format	: Design rule for Camera File System, DPOF compliant
Image Recording Format	Still images : JPEG (Exif 2.2)*1
	Movies : AVI (Image data : Motion JPEG, Audio data:WAVE [monaural])
Compression	: Superfine/fine/normal
Number of Recording Pixels (A70)	Still images : Large: 2048 x 1536 pixels
	Medium 1: 1600 x 1200 pixels
	Medium 2: 1024 x 768 pixels
	Small: 640 x 480 pixels
	Movies*2 : 640 x 480 pixels (Approx. 30 sec.) 320 x 240 pixels (Approx. 3 min.) 160 x 120 pixels (Approx. 3 min.)

(A60)	Still images : Large: 1600 x 1200 pixels Medium: 1024 x 768 pixels Small: 640 x 480 pixels Movies* ² : 320 x 240 pixels (Approx. 3 min.) 160 x 120 pixels (Approx. 3 min.)
Replay Modes	: Single image replay/index replay (9 thumbnails)/ zoomed view (LCD monitor zooms images up to maximum of approx. 10×)/ auto play / sound memos (up to 60 sec.) / Image output to Card Photo Printer CP-100/CP-10 and Bubble Jet Printer with the direct print function
Display languages	: English, Deutsch, Français, Nederlands, Dansk, Suomi, Italiano, Norsk, Svenska, Español, Chinese or Japanese (depending on the region)
My Camera Settings (customizing)	: The Start-up image, Start-up Sound, Shutter Sound, Operation Sound and Selftimer Sound can be customized using the following methods. 1. Using the images and sounds recorded on the camera. 2. Using downloaded data from your computer using the supplied software.
Interface	: Universal Serial Bus (USB) (mini-B, PTP [Picture Transfer Protocol]), Audio/Video Output (NTSC or PAL selectable, monaural audio)
Power Source	: Four AA alkaline batteries (included) Four AA rechargeable NiMH batteries (optional) AC Adapter Kit ACK600 (optional)
Operating Temperatures	: 0 – 40 °C (32 – 104 °F)
Operating Humidity	: 10 – 90 %
Dimensions (w × h × d)	: 101.0 × 64.0 × 31.5 mm (4.0 × 2.5 × 1.2 in.) (excluding protrusions)
Weight	: Approx. 215 g (7.6 oz.) (excluding batteries and CF card)

*¹This digital camera supports Exif 2.2 (also called “Exif Print”). Exif Print is a standard for enhancing the communication between digital cameras and printers. By connecting to an Exif Print-compliant printer, the camera’s image data at the time of shooting is used and optimized, yielding extremely high quality prints.

*²This is the maximum recording time per movie clip for the optional Canon FC-256MH CF card (not sold in some regions).

Battery Performance

	Number of Shots		Replay Time
	LCD Monitor ON	LCD Monitor OFF	
AA Alkaline Batteries (included with the camera)	Approx. 250 shots	Approx. 800 shots	Approx. 280 min.
AA NiMH Battery NB-1AH	Approx. 350 shots	Approx. 1000 shots	Approx. 280 min.

* The data above reflects standard Canon testing conditions. The actual figures will vary according to the shooting conditions and settings.

<Test Conditions>















Shooting: Normal temperature (23° C, 73° F), alternating wide angle end and telephoto end shots at 20-second intervals with flash fired once every four shots and camera power turned off and on every eighth shot.

Replaying: Normal temperature (23° C, 73° F), continuous playback at one image per 3 seconds.







See pages 21 and 193 for battery handling information.



CF Cards and Estimated Capacities (Recordable Images)

PowerShot A70







		FC-16M	FC-32M	FC-64M	FC-128M	FC-256MH
L		8	18	38	76	154
		16	33	68	137	276
		32	67	136	274	548
M1		14	30	61	122	246
		26	54	109	219	440
		52	108	217	435	868
M2		25	53	107	215	431
		46	94	189	379	762
		84	174	349	700	1390
S		58	120	241	482	962
		94	196	393	788	1563
		165	337	676	1355	2720
Movie (in seconds)		14	30	61	124	249
		44	91	183	368	735
		118	242	486	973	1954



PowerShot A60

		FC-16M	FC-32M	FC-64M	FC-128M	FC-256MH
L		14	30	61	122	246
		26	54	109	219	440
		52	108	217	435	868
M		25	53	107	215	431
		46	94	189	379	762
		84	174	349	700	1390
S		58	120	241	482	962
		94	196	393	788	1563
		165	337	676	1355	2720
Movie (in seconds)		44	91	183	368	735
		118	242	486	973	1954



- The following are the approximate maximum recording times for movie clips: : approx. 30 seconds* (PowerShot A70 only), , : approx. 3 minutes. Shown are the maximum continuous recording times.

* When used with the FC-256MH CF card (sold separately)



-  (Superfine),  (Fine) and  (Normal) indicate the relative compression ratio.
- L (Large), M1 (Medium), M2 (Medium), S (Small) and ,  and  indicate the following resolutions.
- The FC-256MH CF card is not sold in some regions.

	PowerShot A70	PowerShot A60
L (Large)	2048 × 1536 pixels	1600 × 1200 pixels
M1 (Medium 1)	1600 × 1200 pixels	–
M2 (Medium 2)	1024 × 768 pixels	1024 × 768 pixels
S (Small)	640 × 480 pixels	640 × 480 pixels
	640 × 480 pixels	–
	320 × 240 pixels	320 × 240 pixels
	160 × 120 pixels	160 × 120 pixels

Approximate Image File Size (Estimated) PowerShot A70

			
L (2048 × 1536)	1602KB	893KB	445KB
M1 (1600 × 1200)	1002KB	558KB	278KB
M2 (1024 × 768)	570KB	320KB	170KB
S (640 × 480)	249KB	150KB	84KB

PowerShot A60

			
L (1600 × 1200)	1002KB	558KB	278KB
M (1024 × 768)	570KB	320KB	170KB
S (640 × 480)	249KB	150KB	84KB

NiMH Battery NB-1AH

Supplied with the optional NiMH Battery NB4-100 set and the Battery/Charger Kit CBK100.

Type	Rechargeable nickel metal hydride battery
Nominal Voltage	1.2 V DC
Typical Capacity	1600 mAh (Lowest : 1550mAh)
Cycle Life	Approx. 300 times
Operating Temperature	0 – 35 °C (32 – 95 °F)
Dimensions	Diameter: 14.5 mm (0.6 in.) Length: 50 mm (2 in.)
Weight	Approx. 27 g (0.95 oz.)

Battery Charger CB-3AH

Supplied with the optional Battery and Charger Kit CBK100.

Rated Input	100 – 240 V AC (50/60 Hz), 8 W
Rated Output	1.6 V DC/2 A
Charging Time	Approx. 220 minutes*
Operating Temperature	0 – 35 °C (32 – 95 °F)
Dimensions	113 × 74 × 27.5 mm (4.4 × 2.9 × 1.1 in.)
Weight (body)	Approx. 100 g (3.5 oz.)

* To charge four NB-1AH NiMH Batteries

Compact Power Adapter CA-PS500

Supplied with the optional AC Adapter Kit ACK600.

Rated Input	100 – 240 V AC (50/60 Hz), 0.17 A
Rated Output	4.3 V DC/1.5 A
Operating Temperature	0 – 40 °C (32 – 104 °F)
Dimensions	42.5 × 104.4 × 31.4 mm (1.7 × 4.1 × 1.3 in.)
Weight (body)	Approx. 180 g (6.4 oz.)

CompactFlash™ Card

Card Slot Type	Type I
Dimensions	36.4 × 42.8 × 3.3 mm (1.4 × 1.7 × 0.1 in.)
Weight	Approx. 10 g (0.4 oz.)

Wide Converter WC-DC52 (optional)

Magnification	Approx. 0.7× (35 mm film equivalent at wide angle end: approx. 24.5 mm)
Focusing Range (from tip of lens)	Approx. 60 mm (2.4 in.) – ∞ (when mounted on PowerShot A70 or A60, at wide angle end)
Thread Diameter	52 mm standard filter thread (Conversion Lens Adapter LA-DC52C is required for mounting to PowerShot A70 or A60)
Dimensions	Diameter: 58 mm (2.3 in.) Length: 30.5 mm (1.2 in.)
Weight	Approx. 74 g (2.6 oz.)

Tele-converter TC-DC52 (optional)

Magnification	Approx. 2.4× (35 mm film equivalent at telephoto end: approx. 252 mm)
Focusing Range (from tip of lens)	Approx. 200 mm (Approx. 7.9 in.) – ∞ (when mounted on PowerShot A70 or A60, at wide angle end)
Thread Diameter	52 mm standard filter thread (Conversion Lens Adapter LA-DC52C is required for mounting to PowerShot A70 or A60)
Dimensions	Diameter: 67 mm (2.6 in.) Length: 57 mm (2.2 in.)
Weight	Approx. 74 g (2.6 oz.)

Close-Up Lens 250D 52mm (optional)

Focal Length	250 mm
Focusing Range (from tip of lens)	30 – 250 mm (1.2 – 9.8 in.) (W)/130 – 250 mm (5.1 – 9.8 in.) (T) (when mounted on PowerShot A70 or A60)
Thread Diameter	52 mm standard filter thread (Conversion Lens Adapter LA-DC52C is required for mounting to PowerShot A70 or A60)
Dimensions	Diameter: 54 mm (2.1 in.) Length: 10.2 mm (0.4 in.)
Weight	Approx. 55 g (1.9 oz.)

Conversion Lens Adapter LA-DC52C (optional)

Thread Diameter	52 mm standard filter thread
Dimensions (from tip of lens)	Diameter: 55.6 mm (2.19 in.) Length: 28.7 mm (1.13 in.)
Weight (body)	Approx. 11 g (0.39 oz.)

Index

A

- AC Adapter Kit 195
- AF Frame
 - Auto Selection 98
 - Manual Selection 98
- Aperture-Priority AE (**Av**) 94
- Aperture Value 89, 91, 94, 96
- Auto Mode (**AUTO**) 60
- Auto Play 130
- A/V Out Terminal 165

B

- Batteries
 - Battery Cover 17
 - Change 20
 - Handling Precautions 21
 - Installing 20
 - Low Status 23
 - Performance 214
 - Rechargeable Batteries 193
 - Status 23
- Beep 178, 179, 183
- Black and White Mode 110

C

- Care 203
- CF Card 24
 - CF Card Reader 171
 - Downloading Images 167
 - Formatting 134
 - Handling 25
 - Installing 24
 - Recording Capacity 215
 - Slot Cover 17
- Cleaning 203
- CompactFlash™ Card 24, 25, 131, 215
- Components 16
- Compression 64, 215

- Continuous Shooting () 87
- Creative Zone 19

D

- Date/Time 26, 178
- Default Settings 48 - 50
- Digital Terminal 16, 141, 165
- Digital Zoom 42, 85, 175
- Display Modes 33 - 37
 - Detailed 33, 34
 - Simple 33, 34
- DPOF
 - Print Settings 154, 158
 - Transfer Order 163

E

- Erasing
 - All Images 133
 - Displayed Images 15
 - Single Images 132
- Exposure
 - Aperture-Priority AE (**Av**) 94
 - Compensation 101
 - Shutter Speed-Priority AE (**Tv**) 91
 - White Balance 103
- Exposure Compensation 101

F

- Fast Shutter 73
- File No. Reset 116
- File Numbers 116
- Flash 67
- Focal Length 42
- Focus
 - Lock 113
 - Manual 115
- Format 134

H

- Household Power Source 193

I

- Image Zone 19
- Index Replay 120
- Indicators 18
- Information View 33 - 37
- Interface
 - Cables 17, 141, 165
- ISO Speed 110

J

- Jump 121

L

- Landscape Mode () 71
- Language 28, 180
- LCD Monitor 33 - 37
- Lens 16
 - Close-up Lens 198
 - Conversion Lens Adapter 200
 - Tele-converter 198
 - Wide Converter 197
- Light Metering
 - Center-Weighted Averaging 99
 - Evaluative 99
 - Spot AE Point 99

M

- Macro Mode () 81
- Magnifying Images 119
- Manual
 - Exposure (**M**) 96
 - Focus (**MF**) 115
 - Shooting Mode 96
- Menu
 - FUNC. 172
 - List of Options 172
 - Rec 174
 - Replay 176
 - Selecting 43
 - Set up 178 - 181

- Messages 186
- Microphone 16
- Movie ()
 - Shooting 79
 - Replaying 122
 - Editing 124
- My Camera
 - Menu 181
 - Settings 52
 - Registering 55

N

- Night Scene Mode () 72

O

- Operation Sound 52 - 54, 182

P

- Photo Effect 108
- Play 118
- Portrait Mode () 70
- Program AE (**P**) 89
- Protect 131, 176
- Printing 136, 144, 160
 - Settings 146, 154
 - Selecting Images 146
 - Print Style 146
 - Resetting 158
- Power On/Off 30 - 31
- Power Saving 31, 178
- Power Source 30
 - AC Adapter 193
 - Rechargeable Batteries 193

R

- Recordable Images 215
- Recordable Movie Time 216
- Red-Eye Reduction 68
- Replaying
 - Auto Play 130

Index Replay 120
Jumping 121
LCD Monitor 33
Magnifying Images 119
Movies 122
Rotating 127
Single Image Replay 118
Resolution 64
Resetting the settings to default 184
Ring Release Button 16, 200
Rotate 127

S

Self-Timer 83
 Sound 52 - 54, 179, 182
Shooting 32, 60
 Checking Images 62
 Switching from Replaying Mode 32
 TV Set 165
Shooting Mode 224
 Dial 19
 Functions Available 224
Shutter
 Sound 52 - 54, 179, 183
 Shutter Speed Priority AE (Tv) 91
 Speed 89, 91, 94, 96
 Volume 179
Shutter Button 40
 Pressing Halfway 40
 Pressing Fully 40
Single Image Replay 118
Slow Shutter 74
Sound Memos 128
Speaker 16
Specifications 211 - 219
Spot Light Metering 99
Start-up
 Image 30, 52 - 54, 182
 Sound 30, 52 - 54, 182
Stitch Assist Mode (□) 75

Framing Subjects 75
Shooting 76
Strap 17

T

Telephoto 42
Transfer Order
 Reset 163
 Selecting Images 163
Troubleshooting 204 - 210

V

Video System 165, 181
Viewfinder
 LCD Monitor 17, 33
 Optical 17, 38
Volume
 Replay 179
 Shooting 179

W

WAVE Files 36, 37, 128
White Balance 103
Wide Angle 42

Z

Zoom 42, 85, 119

FCC Notice

(Digital Camera, Model PC1043 and PC1044)

This device complies with Part 15 of the FCC Rules. Operation is subject to the following two conditions;

- (1) this device may not cause harmful interference, and
- (2) this device must accept any interference received, including interference that may cause undesired operation.

Note: This equipment has been tested and found to comply with the limits for Class B digital devices, pursuant to Part 15 of the FCC rules. These limits are designed to provide reasonable protection against harmful interference in a residential installation. This equipment generates, uses and can radiate radio frequency energy and, if not installed and used in accordance with the instructions, may cause harmful interference to radio communications. However, there is no guarantee that interference will not occur in a particular installation. If this equipment does cause harmful interference to radio or television reception, which can be determined by turning the equipment off and on, the user is encouraged to try to correct the interference by one or more of the following measures:

- Reorient or relocate the receiving antenna.
- Increase the separation between the equipment and receiver.
- Connect the equipment into an outlet on a circuit different from that to which the receiver is connected.
- Consult the dealer or an experienced radio/TV technician for help.

The cables with the ferrite core provided with the digital camera must be used with this equipment in order to comply with Class B limits in Subject B of Part 15 on the FCC rules.

Do not make any changes or modifications to the equipment unless otherwise specified in the manual. If such changes or modifications should be made, you could be required to stop operation of the equipment.

Canon U.S.A. Inc.

One Canon Plaza, Lake Success, NY 11042, U.S.A.

Tel No. (516) 328-5600

Canadian Radio Interference Regulations























THIS CLASS B DIGITAL APPARATUS MEETS ALL REQUIREMENTS OF THE CANADIAN INTERFERENCE CAUSING EQUIPMENT REGULATIONS.





Réglementation canadienne sur les interférences radio











CET APPAREIL NUMERIQUE DE LA CLASSE B RESPECTE TOUTES LES EXIGENCES DU REGLEMENT SUR LE MATERIEL BROUILLEUR DU CANADA.

Functions Available in Each Shooting Mode

This chart shows the functions available in each shooting mode

						
Resolution	Large	L	●*	●*	●*	●*
	Medium 1 ⁽¹⁾	M1	●	●	●	●
	Medium 2 ⁽¹⁾	M2	●	●	●	●
	Medium ⁽²⁾	M	●	●	●	●
	Small	S	●	●	●	●
Resolution	Movie ⁽¹⁾		—	—	—	—
	Movie		—	—	—	—
	Movie		—	—	—	—
Compression	Superfine		●	●	●	●
	Fine		●*	●*	●*	●*
	Normal		●	●	●	●
Flash	Auto		●*	●*	●	●*
	On		—	●	●	●
	Off		●	●	●*	●
Red-Eye Reduction			●	●	●	●
Flash Output			—	—	—	—
AF-assist Beam			●	●	●	●
Drive Mode	Single Shot		●*	●*	●*	●*
	Continuous Mode		—	●	●	●
	Self-timer (10 sec.)		●	●	●	●
	Self-timer (2 sec.)		●	●	●	●
AF Frame			—	●	●	●
Manual Focus			—	●	●	●
Macro Mode			●	●	—	●

				P	Tv	Av	M	Reference Page
●*	●*	▲*	—	●*	●*	●*	●*	64
●	●	▲	—	●	●	●	●	
●	●	▲	—	●	●	●	●	
●	●	▲	—	●	●	●	●	
●	●	▲	—	●	●	●	●	
—	—	—	●	—	—	—	—	
—	—	—	●*	—	—	—	—	
—	—	—	●	—	—	—	—	
●	●	▲	—	●	●	●	●	64
●*	●*	▲*	—	●*	●*	●*	●*	
●	●	▲	—	●	●	●	●	
●*	●	—	—	●	—	—	—	67
●	●	▲	—	●	●	●	●	
●	●*	▲*	—	●*	●*	●*	●*	
●	●	▲	—	●	●	●	●	68
—	—	—	—	—	—	—	●	112
●	●	▲	●	●	●	●	●	41
●*	●*	▲*	●*	●*	●*	●*	●*	—
●	●	—	—	●	●	●	●	87
●	●	▲	●	●	●	●	●	83
●	●	▲	●	●	●	●	●	
●	●	—	—	●	●	●	●	98
●	●	—	●	●	●	●	●	115
●	●	▲	●	●	●	●	●	81

					
Digital Zoom 	On	●	●	●	●
	Off	●*	●*	●*	●*
Exposure Compensation 		—	●	●	●
Light Metering System	Evaluative Metering 	●	●	●	●
	Center-Weighted Averaging 	—	—	—	—
	Spot Metering 	—	—	—	—
White Balance ⁽³⁾	WB	— ⁽⁴⁾	●	●	●
Photo Effect		—	●	●	●
ISO Speed	ISO	— ⁽⁵⁾	— ⁽⁵⁾	— ⁽⁵⁾	— ⁽⁵⁾

* : Default, ● : Available, ▲ : Available, but cannot be changed after taking the first shot, — : Not available

 : Setting is retained even after power off.

The default for the settings changed by the menu and button operations can be restored all at once except for [Date/Time], [Language] and [Video System] (p. 184)

(1) Available only with PowerShot A70.

(2) Available only with PowerShot A60.

(3) The photo effect [Sepia] and [B/W] cannot be selected.

(4) The white balance is set to [AUTO].

(5) The ISO speed is automatically set by the camera.

(6) ISO [AUTO] cannot be selected.