

ENGLISH



Canon

Canon

DIGITAL CAMERA

PowerShot S50

Camera User Guide

PowerShot S50

DIGITAL CAMERA

Camera User Guide

Canon



DiG!C

- Please start by reading the Precautions on page 4 of this manual.
- Please refer to the *Software Starter Guide* for information on installing the software and downloading images.
- Please also read the printer user guide included with your Canon printer.

Exif Print



Flowchart and Reference Guides

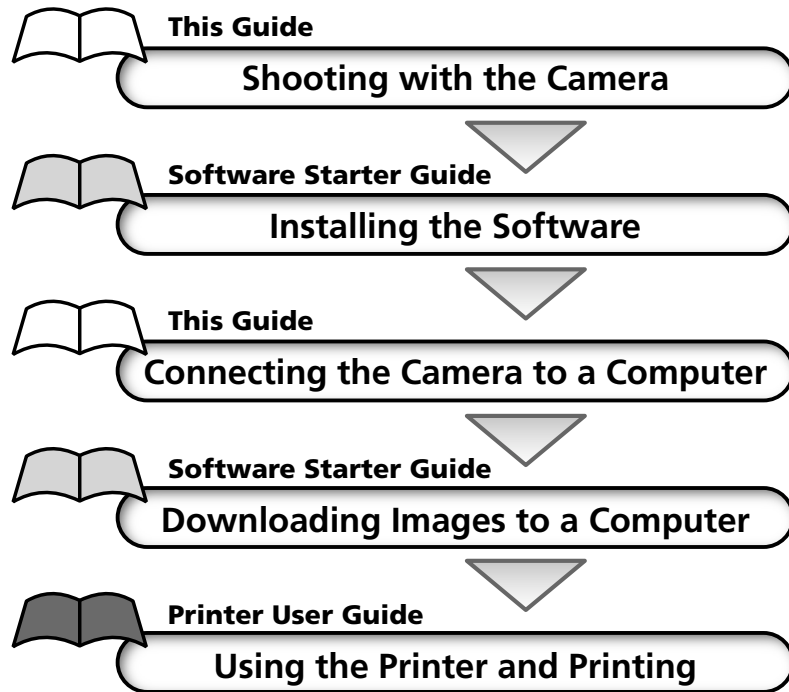

		AUTO										P	Tv	Av	M	Reference Page	
AF Frame	Auto	● ⁽¹⁾	● ⁽¹⁾	● [*]	● ⁽¹⁾	● ⁽¹⁾	● ⁽¹⁾	● ⁽¹⁾	● ⁽¹⁾	● ⁽¹⁾	● ⁽¹⁾	—	—	—	—	74	
	Center Point	●	●	●	●	●	●	●	●	●	●	● [*]	● [*]	● [*]	● [*]		
	Manual	—	—	—	—	—	—	—	—	—	—	●	●	●	●		
Manual Focus	MF	—	●	●	●	●	●	●	●	●	●	●	●	●	●	100	
Macro Mode		●	●	—	●	●	●	●	●	●	●	●	●	●	●	63	
Digital Zoom	On	●	●	●	●	●	●	●	●	—	—	●	●	●	●	65	
	Off	● [*]	● [*]	● [*]	● [*]	● [*]	● [*]	● [*]	● [*]	—	—	● [*]	● [*]	● [*]	● [*]		
Exposure Compensation		—	●	●	●	●	●	●	●	▲	●	●	●	●	—	79	
Light Metering System	Evaluative Metering	●	●	●	●	●	●	●	●	●	●	● [*]	● [*]	● [*]	● ⁽²⁾	77	
	Center-Weighted Averaging	—	—	—	—	—	—	—	—	—	—	●	●	●	● ⁽²⁾		
	Spot Metering	—	—	—	—	—	—	—	—	—	—	●	●	●	● ⁽²⁾		
	Center	—	—	—	—	—	—	—	—	—	—	● [*]	● [*]	● [*]	● [*]		
	AF Point	—	—	—	—	—	—	—	—	—	—	●	●	●	●		
AE Lock/FE Lock		—	—	—	—	—	—	—	—	—	—	●	●	●	—	90/92	
Bracket	AEB	—	—	—	—	—	—	—	—	—	—	●	●	●	—	86	
	Focus-BKT	—	—	—	—	—	—	—	—	—	—	● ⁽³⁾	● ⁽³⁾	● ⁽³⁾	● ⁽³⁾	88	
White Balance ⁽⁴⁾	WB	— ⁽⁵⁾	●	●	●	●	●	●	●	▲	● ⁽⁶⁾	●	●	●	●	80	
Photo Effect		—	●	●	●	●	●	●	●	▲	●	●	●	●	●	83	
	Contrast/Sharpness/Saturation	—	—	—	—	—	—	—	—	—	—	●	●	●	●	84	
ISO Speed	ISO	— ⁽⁷⁾	— ⁽⁷⁾	— ⁽⁷⁾	— ⁽⁷⁾	— ⁽⁷⁾	— ⁽⁷⁾	— ⁽⁷⁾	— ⁽⁷⁾	— ⁽⁷⁾	— ⁽⁷⁾	●	●	●	● ⁽⁸⁾	85	
Auto Rotate	On	● [*]	● [*]	● [*]	● [*]	● [*]	● [*]	● [*]	● [*]	▲ [*]	—	● [*]	● [*]	● [*]	● [*]	103	
	Off	●	●	●	●	●	●	●	●	▲	—	●	●	●	●		

- * Default setting.
- Setting selection is possible.
- ▲ Setting can only be selected for the first image.
- Setting selection is not possible.
- (Shaded Area) Setting remains in effect even when the camera is turned off.

The default for the settings changed by the menu and button operations can be restored all at once except for [Date/Time], [Language] and [Video System] (p. 157).

- (1) In Macro mode, the AF frame is set to the center.
- (2) The light metering system cannot be set in **M** mode. In **P**, **Tv** or **Av** mode, the last selected light metering system will take effect.
- (3) Settable only in manual focus.
- (4) The photo effect [Sepia] and [B/W] cannot be selected.
- (5) The white balance is set to [AUTO].
- (6) The white balance flash cannot be set.
- (7) The ISO speed is automatically set by the camera.
- (8) ISO [AUTO] cannot be selected.

This digital camera is designed to perform optimally when used with genuine Canon brand digital camera accessories ("Canon Brand Accessories"). You may use non Canon Brand Accessories with this Digital Camera. However, Canon makes no warranties concerning, and is not responsible for damages resulting from, use of non Canon Brand Accessories.

Camera Body Temperature

If your camera is used for prolonged periods, the camera body may become warm. Please be aware of this and take care when operating the camera for an extended period.

About the LCD Monitor

The LCD monitor is produced with extremely high-precision manufacturing techniques. More than 99.99% of the pixels operate to specification. Less than 0.01% of the pixels may occasionally misfire or appear as red or black dots. This has no effect on the recorded image and does not constitute a malfunction.

Video Format

Please set the camera's video signal format to the one used in your region before using it with a TV monitor (p. 154).

Language Setting

Please see page 23 to change the language setting.

Please read through the "Read This First" section (p. 4) before using your camera.

Charging the Date/Time Battery

- The camera has a built-in rechargeable lithium battery that maintains the date, time and other camera settings. This battery recharges when the main battery pack is inserted into the camera. When you first purchase the camera, attach a charged battery pack in it or use the AC adapter kit (sold separately) for at least 4 hours to charge the date/time battery. It will charge even when the camera power is set to Off.
- If the Set Date/Time menu appears when the camera power is turned on, it means that the date/time battery charge is depleted. Recharge it as described above.

Disclaimer

- While every effort has been made to ensure that the information contained in this guide is accurate and complete, no liability can be accepted for any errors or omissions.
- Canon Inc. reserves the right to change the specifications of the hardware and software described herein at any time without prior notice.
- No part of this guide may be reproduced, transmitted, transcribed, stored in a retrieval system, or translated into any language in any form, by any means, without the prior written permission of Canon Inc.
- Canon Inc. makes no warranties for damages resulting from corrupted or lost data due to a mistaken operation or malfunction of the camera, the software, the CompactFlash™ cards (CF cards), personal computers, peripheral devices, or use of non-Canon CF cards.

Trademark Acknowledgements

- Canon, PowerShot and Bubble Jet are trademarks of Canon, Inc.
- CompactFlash is a trademark of SanDisk Corporation.
- iBook and iMac are trademarks of Apple Computer, Inc.
- Macintosh, PowerBook, Power Macintosh and QuickTime are trademarks of Apple Computer, Inc, registered in the United States and other countries.
- Microsoft, Windows, and Windows NT are either registered trademarks or trademarks of Microsoft Corporation in the United States and/or other countries.
- Other names and products not mentioned above may be registered trademarks or trademarks of their respective companies.

About this Camera User Guide

Symbols Used



: This mark denotes issues that may affect the camera's operation.



: This mark denotes additional topics that complement the basic operating procedures.

Question? Look Here First.

- How do I navigate the menus?

Selecting Menus and Settings (p. 36)

- What settings are available under each function?
and

Will my settings remain in effect even after I've turned the camera off?

Functions Available in Each Shooting Mode (p. 180)

- How do I go about printing?

About Printing (p. 122)

- What functions are available through the menus?

Rec. Menu (p. 148)

Replay Menu (p. 150)

Set up Menu (p. 151)

My Camera Menu (p. 155)

About the Thumb Index

A quick introduction intended for new users who want to shoot first and learn more later. Tells you how to get the camera running and how to begin shooting and playing back images.

Quick Start

Introduces you to all of the camera components, and explains how to load batteries and use the shutter button, among other basic functions. Also explains how to set the camera's start-up image, start-up sound and shutter sound.

Preparing the Camera, Basic Functions

Describes shooting with the camera, from each shooting mode to using the camera's various shooting features.

Shooting

Explains how to review recorded images or select replay settings, how to protect images or erase them, and how to edit movies.

Replaying, Erasing

Explains how to print and make print settings, and how to select images for transferring to e-mail.

Printing, Transferring

Explains how to transfer images to a computer. Also explains how to use a TV set for shooting and reviewing images.
You must read this section before connecting your camera to a computer.





Connecting



















Shows the Rec. and Replay menus, the Setup menu and the My Camera menu at a glance and error messages. Also explains how to use the Battery and Charger Kit.

Appendix

Table of Contents

■ : Functions and operations tables. These pages are shaded on the right edges to make them easy to find.

Read This First	4
Quick Start	8
Components Guide	10
Front View	10
Back / Bottom View	11
Controls	12
Shooting Mode Dial	13
Operating the Multicontroller	14
Preparing the Camera	15
Charging the Battery Pack	15
Installing the Battery Pack	17
Installing a CF Card	19
Setting the Date / Time	21
Setting the Language	23
Basic Functions	24
Turning the Power On / Off	24
Switching between Shooting and Replaying	26
Using the LCD Monitor	28
Using the Viewfinder to Shoot	32
Pressing the Shutter Button	33
Using the Zoom (Focal Length)	35
Selecting Menus and Settings	36
Customizing the Camera (My Camera Settings)	40
Changing My Camera Settings	40
Registering My Camera Settings	42
Shooting - Letting the Camera Select Settings	45
 Auto Mode	45
Reviewing an Image Right after Shooting	47
Changing the Resolution and Compression	49
Changing the File Format	52
 Using the Flash	54
 Portrait Mode	56
 Landscape Mode	56
 Night Scene Mode	57

	Fast Shutter	57
	Slow Shutter	58
	Stitch Assist Mode	59
	Movie Mode	62
	Macro Mode	63
	Self-Timer	64
	Digital Zoom	65
	Continuous Shooting	66
Shooting - Selecting Particular Effects		67
P	Program AE	67
Tv	Setting the Shutter Speed	69
Av	Setting the Aperture	71
M	Manually Setting the Shutter Speed and Aperture	73
	Selecting an AF frame	74
	Switching Between Light Metering Modes	77
	Adjusting the Exposure	79
WB	Setting the White Balance	80
	Changing the Photo Effect	83
ISO	Changing the ISO Speed	85
	Auto Exposure Bracketing (AEB Mode)	86
	Focus Bracketing (Focus-BKT Mode)	88
	Locking the Exposure Setting (AE Lock)	90
	Locking the Flash Exposure Setting (FE Lock)	92
	Switching between the Built-in Flash Adjustment Settings	93
	Switching the Timing at which the Flash Fires	95
	Shooting Images at Set Intervals (Intervalometer)	96
	Shooting Problem Subjects for the Autofocus	98
C	Saving Custom Settings	102
	Setting the Auto Rotate Function	103
	Resetting the File Numbers	104
Replaying		105
	Displaying Images Individually	105
	Magnifying Images	106
	Viewing Images in Sets of Nine (Index Replay)	107
JUMP	Jumping Between Images	108
	Viewing Movies	109
	Editing Movies	110
	Rotating Images in the Display	112
	Attaching Sound Annotations to Images	113

Automated Playback (Slide Show)	114
Protecting Images	118
Erasing	119
Erasing Images Individually	119
Erasing All Images	120
Formatting a CF Card	121
Printing	122
About Printing	122
Selecting from the Print Order Menu	124
Connecting the Camera to a Printer	126
Printing	129
Setting the Print Settings (Direct Print Function)	131
Print Settings (DPOF Print Settings)	135
Printing with DPOF Print Settings	140
Image Transfer Settings (DPOF Transfer Order)	142
Selecting Images for Transferring	142
Viewing Images on a TV Set	144
Downloading Images to a Computer	145
Connecting the Camera to a Computer via the USB Cable	145
Downloading Directly from a CF Card	147
List of Menu Options and Messages	148
Rec. Menu	148
Replay Menu	150
Set up Menu	151
My Camera Menu	155
Resetting the Settings to Default	157
List of Messages	158
Appendices	162
Using an AC Adapter Kit (Optional)	162
Using a Car Battery Charger (Optional)	164
Using the Waterproof Case (Optional)	165
Camera Care and Maintenance	166
Troubleshooting	167
Specifications	170
Index	176
Functions Available in Each Shooting Mode	180

Read This First

Please Read

Test Shots

Before you try to photograph important subjects, we highly recommend that you shoot several trial images to confirm that the camera is operating and being operated correctly. Please note that Canon Inc., its subsidiaries and affiliates, and its distributors are not liable for any consequential damages arising from any malfunction of a camera or accessory, including CompactFlash™ cards, that results in the failure of an image to be recorded or to be recorded in a format that is machine sensible.

Warning Against Copyright Infringement

Please note that Canon digital cameras are intended for personal use and should never be used in a manner that infringes upon or contravenes international or domestic copyright laws and regulations. Please be advised that in certain cases the copying of images from performances, exhibitions, or commercial properties by means of a camera or other device may contravene copyright or other legal rights even if the image was shot for personal use.

Warranty Limitations

This camera's warranty is only effective in the country of sale. If a problem arises while the camera is in use abroad, please convey it back to the country of sale before proceeding with a warranty claim to a Canon Customer Support Help Desk.

For Canon Customer Support contacts, please see the Canon Limited Warranty supplied with your camera.

Safety Precautions

- Before using the camera, please ensure that you read and understand the safety precautions described below. Always ensure that the camera is operated correctly.
- The safety precautions noted on the following pages are intended to instruct you in the safe and correct operation of the camera and its accessories to prevent injuries or damage to yourself, other persons and equipment.
- In the next few pages, the term "equipment" refers primarily to the camera, its power supply accessories and an optional compact power adapter.

Warnings

- **Do not aim the camera directly into the sun or at other intense light sources** which could damage your eyesight.
- **Do not trigger the flash in close proximity to human or animal eyes.** Exposure to the intense light produced by the flash may damage eyesight. In particular, remain at least one meter (39 inches) away from infants when using the flash.
- **Store this equipment out of the reach of children and infants.** Accidental damage to the camera or batteries by a child could result in serious injury. In addition, placement of the strap around the child's neck could result in asphyxiation.
- **Do not attempt to disassemble or alter any part of the equipment that is not expressly described in this guide.** Disassembly or alteration may result in high-voltage electrical shock. Internal inspections, alterations and repairs should be conducted by qualified service personnel authorized by your camera distributor or a Canon Customer Support Help Desk.
- **To avoid the risk of high-voltage electrical shock, do not touch the flash portion of the camera if it has been damaged.** Similarly, never touch internal portions of the equipment that become exposed as a result of damage. There is a risk of high-voltage electrical shock. Please take the first opportunity to consult your camera distributor or a Canon Customer Support Help Desk.
- **Stop operating the equipment immediately if it emits smoke or noxious fumes.** Failure to do so may result in fire or electrical shock. Immediately turn the camera's power off, remove the camera battery and unplug the power cord from the power outlet. Confirm that smoke or fume emissions have ceased. Please consult your camera distributor or the closest Canon Customer Support Help Desk.
- **Stop operating the equipment if it is dropped or the casing is damaged.** Failure to do so may result in fire or electrical shock. Immediately turn the camera's power off, remove the camera battery or unplug the power cord from the power outlet. Please consult your camera distributor or the closest Canon Customer Support Help Desk.
- **Do not allow the equipment to come into contact with, or become immersed in, water or other liquids.** Do not allow liquids to enter the interior. The camera has not been waterproofed. If the exterior comes into contact with liquids or salt air, wipe it dry with a soft, absorbent cloth. In the event that water or other foreign substances enter the interior, immediately turn the camera's power off and remove the camera battery or unplug the power cord from the power outlet. Continued use of the equipment may result in fire or electrical shock. Please consult your camera distributor or the closest Canon Customer Support Help Desk.
- **Do not use substances containing alcohol, benzene, thinners or other flammable substances to clean or maintain the equipment.** The use of these substances may lead to fire.

- **Remove the power cord on a regular periodic basis and wipe away the dust and dirt that collects on the plug, the exterior of the power outlet and the surrounding area.** In dusty, humid or greasy environments, the dust that collects around the plug over long periods of time may become saturated with humidity and short-circuit, leading to fire.

- **Do not cut, damage, alter or place heavy items on the power adapter cord.** Any of these actions may cause an electrical short circuit, which may lead to fire or electrical shock.

- **Do not handle the power cord if your hands are wet.** Handling it with wet hands may lead to electrical shock. When unplugging the cord, ensure that you hold the solid portion of the plug. Pulling on the flexible portion of the cord may damage or expose the wire and insulation, creating the potential for fires or electrical shocks.

- **Use only the recommended power accessories.** Use of power sources not expressly recommended for this equipment may lead to overheating, distortion of the equipment, fire, electrical shock or other hazards.

- **Do not place the batteries near a heat source or expose them to direct flame or heat.** Neither should you immerse them in water. Such exposure may damage the batteries and lead to the leakage of corrosive liquids, fire, electrical shock, explosion or serious injury.

- **Do not attempt to disassemble, alter or apply heat to the batteries.** There is serious risk of injury due to an explosion. Immediately flush with water any area of the body, including the eyes and mouth, or clothing, that comes into contact with the inner contents of a battery. If the eyes or mouth contact these substances, immediately flush with water and seek medical assistance.

- **Avoid dropping or subjecting the batteries to severe impacts that could damage the casings.** It could lead to leakage and injury.

- **Do not short-circuit the battery terminals with metallic objects, such as key holders.** It could lead to overheating, burns and other injuries. Use the supplied terminal cover to transport or store the battery pack.

- **Before you discard a battery, cover the terminals with tape or other insulators to prevent direct contact with other objects.** Contact with the metallic components of other materials in waste containers may lead to fire or explosions. Discard the batteries in specialized waste facilities if available in your area.

- **Use NB-2L battery pack only.** Use of other batteries may cause explosions or leaks, resulting in fire, injury and damage to the surroundings.

- **Use the designated battery charger to charge the NB-2L battery pack.** Use of other battery chargers may cause the unit to overheat and distort, resulting in fire or electrical shock.

- **Disconnect the battery charger or the compact power adapter from both the camera and power outlet after recharging and when the camera is not in use** to avoid fires and other hazards.

- **The battery charger and the camera terminal of the optional compact power adapter are designed for exclusive use with this camera.** Do not use it with other products. There is a risk of fire and other hazards.

- **Always keep the terminals of the battery charger clean. Do not place metal objects on top of the terminals.** There is a risk of fire and other hazards.
-

Cautions

- **Avoid using, placing or storing the equipment in places subject to strong sunlight or high temperatures, such as the dashboard or trunk (boot) of a car.** Exposure to intense sunlight and heat may cause the batteries to leak, overheat or explode, resulting in fire, burns or other injuries. High temperatures may also cause deformation of the casing. Ensure that there is good ventilation when using the compact power adapter to charge the battery pack or power the camera.
 - **Do not store the equipment in humid or dusty areas.** Storage in such areas could lead to fire, electrical shock or other damage.
 - **Be careful not to bang the camera or subject it to strong impacts or shocks that could lead to injury or damage the equipment when wearing or holding it by the strap.**
 - **Be careful not to cover the flash with your fingers when shooting.** In addition, do not touch the surface of the flash after taking several pictures in rapid succession. Either action could result in burns.
 - **Do not operate the flash with dirt, dust or other items stuck to its lens.** The resulting heat build-up could damage the flash.
 - **If your camera is used for prolonged periods, the camera body may become warm.** Please take care when operating the camera for an extended period as your hands may experience a burning sensation.
-

Preventing Malfunctions

■ **Avoid Strong Magnetic Fields**

Never place the camera in close proximity to electric motors or other equipment generating strong electromagnetic fields. Exposure to strong magnetic fields may cause malfunctions or corrupt image data.

■ **Avoid Condensation Related Problems**

Moving the equipment rapidly between hot and cold temperatures may cause condensation (water droplets) to form on its external and internal surfaces. You can avoid this by placing the equipment in an airtight, resealable plastic bag and letting it adjust to temperature changes slowly before removing it from the bag.

■ **If Condensation Forms Inside the Camera**

Stop using the camera immediately if you detect condensation. Continued use may damage the equipment. Remove the CF card, and battery or a household power source, from the camera and wait until the moisture evaporates completely before resuming use.

Quick Start

1

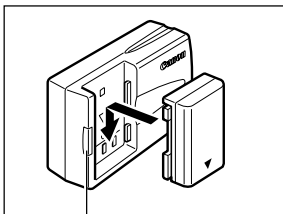

Charge indicator

Charge the Battery (p. 15).

Charge the battery using the supplied battery charger. The charging is complete when the charge indicator turns from red to green.

- Please note that the battery charger shape varies between regions.

2

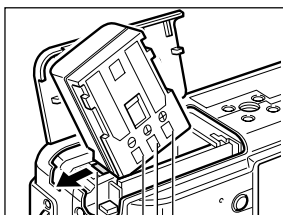

Battery lock

Terminals

Install the Battery (p. 17).

Open the CF card slot/battery cover. Hold back the battery lock in the direction of the arrow using the corner of the battery pack, then insert the battery pack into the compartment until it is locked.

3

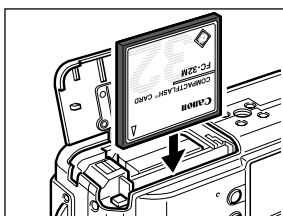

Install the CF card (p. 19).

Push the card in until the CF card eject button fully extends.

4

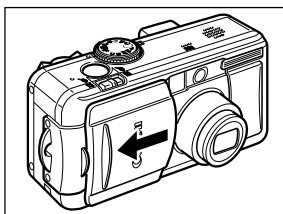

Open the lens cover (p. 24).

The camera powers up into Shooting mode. If the [Set Date/Time] menu appears on the LCD monitor, set the date and time (p. 21).

5

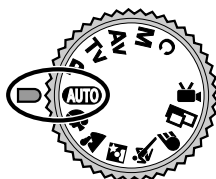

Turn the Shooting Mode dial to **AUTO** (p. 45).

6

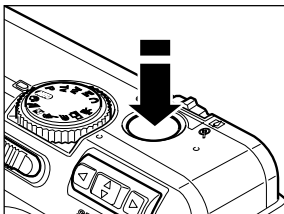
**Focus (p. 33).**

Aim the camera and lightly press the shutter button halfway. Two beeps will sound when the autofocus is set.

7

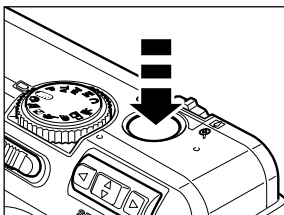
**Shoot (p. 33).**

Press the shutter button all the way. You will hear the sound of the shutter close when the shot is complete.

8

**View the recorded image (p. 47).**

The recorded image appears in the LCD monitor for approximately 2 seconds. Keep your finger on the shutter button, or press **SET** on the multicontroller while the image is displayed to continue to display the image after the shutter button is released.

**To Immediately Delete the Displayed Image**

1. Press the  button while the image is displayed.
2. Confirm that [Erase] is selected and press **SET** on the multicontroller.



Components Guide

Front View

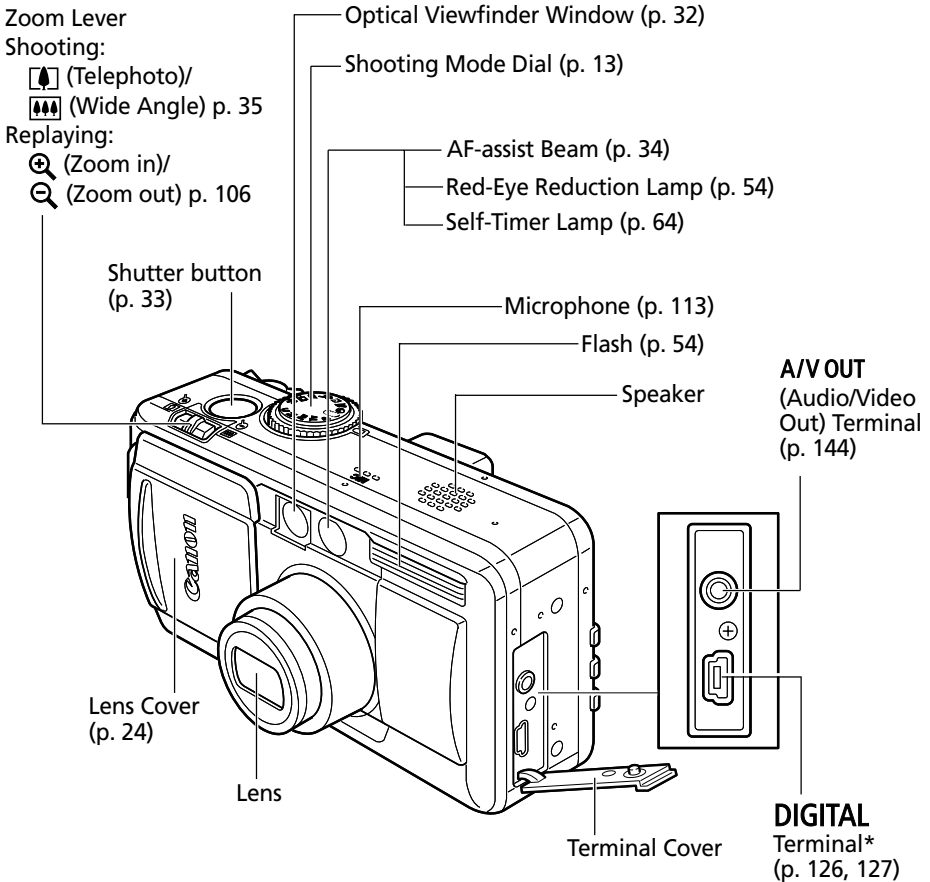

* To connect the camera to a computer or printer, use one of the following cables.

- Computer: USB Interface Cable IFC-300PCU (supplied with this camera)
- Direct Print Compatible Printer (CP series, optional): Direct Interface Cable DIF-100 (supplied with Direct Print compatible printers)
- Bubble Jet Printer with the direct print function (optional): Please refer to the Bubble Jet Printer user guide.

Please refer to your *System Map* to find out which direct print function compatible printer can be used with this camera.

Back / Bottom View

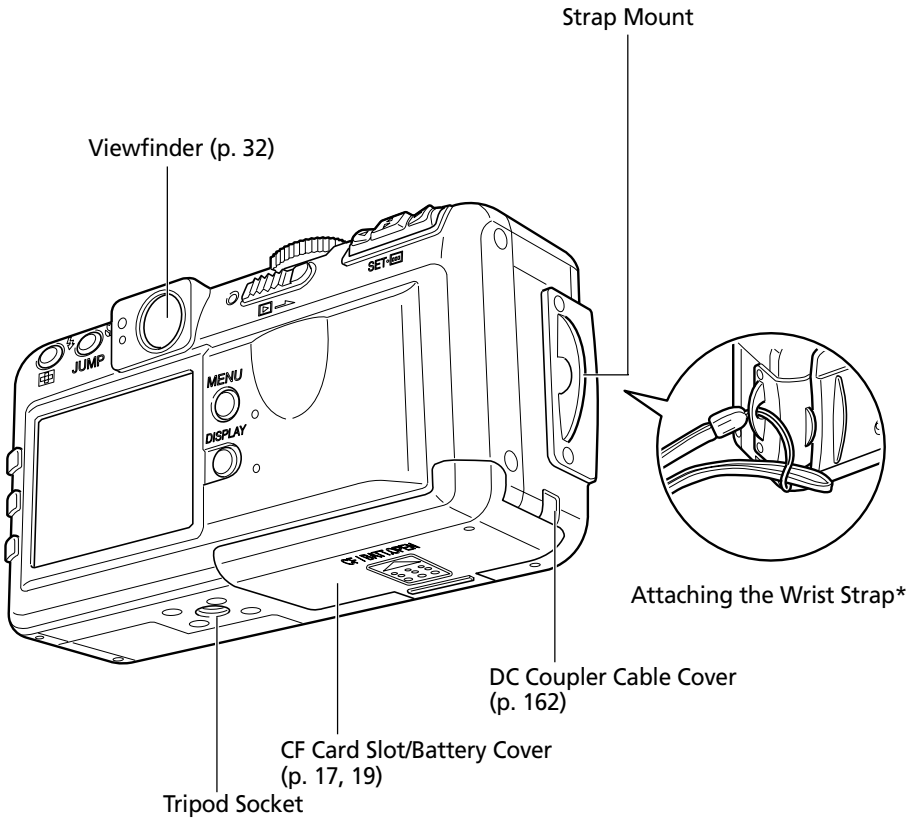

* Be careful not to wave the camera about or catch it on other items when dangling it from the wrist strap.





The LCD monitor is covered with a thin plastic film for protection against scratches during shipment. Remove it before using the camera.

Controls

 (Exposure) / **WB** (White Balance) / **FUNC.** (Function) Button (p. 36, 79, 80)

Power/Mode Indicator (p. 24)



 (Flash) /  (Index) Button (p. 54, 107)

Power/Replay Lever (p. 24, 26)

 (Macro) / **JUMP** (Jump) Button (p. 63, 108)

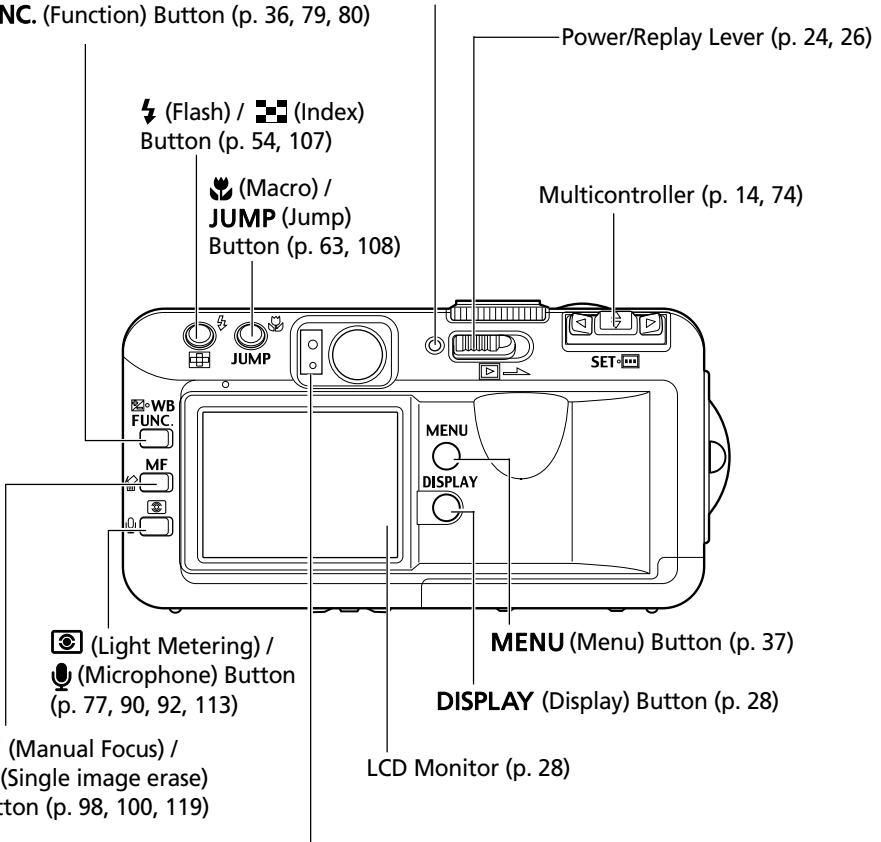
Multicontroller (p. 14, 74)



 (Light Metering) /  (Microphone) Button (p. 77, 90, 92, 113)

MENU (Menu) Button (p. 37)

DISPLAY (Display) Button (p. 28)

MF (Manual Focus) /  (Single image erase) Button (p. 98, 100, 119)

LCD Monitor (p. 28)

● Upper Indicator

The indicators light or blink when the shutter button is pressed or the following operations are underway.

- Green: Ready to record
- Blinking Green: Recording to CF card / Reading CF card / Erasing from CF card / Transmitting data (during a computer connection)
- Orange: Ready to record (flash on)
- Blinking Orange: Ready to record (camera shake warning)

● Lower Indicator

- Yellow: Macro mode / Manual focus mode
- Blinking Yellow: Focusing difficulty (although you can press the shutter button, try using focus lock or adjusting the focus manually, p. 100)

Shooting Mode Dial

Use the shooting mode dial to switch between the Shooting modes.

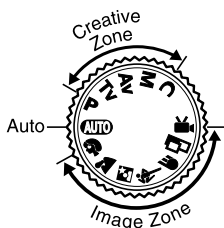

- **AUTO : Auto (p. 45)**

The camera automatically selects settings.

- **Image Zone**

The camera automatically selects settings according to the image composition type.

- Portrait (p. 56)
- Landscape (p. 56)
- Night Scene (p. 57)
- Fast Shutter Speed (p. 57)
- Slow Shutter Speed (p. 58)
- Stitch Assist (p. 59)
- Movie (p. 62)

- **Creative Zone**

The user selects exposure, aperture or other settings to achieve special effects.

- P : Program AE (p. 67)
- Tv : Shutter Speed-Priority AE (p. 69)
- Av : Aperture-Priority AE (p. 71)
- M : Manual Exposure (p. 73)
- C : Custom (p. 102)

Operating the Multicontroller

The multicontroller is used to select choices, images and menus on the LCD monitor and confirm the selection.

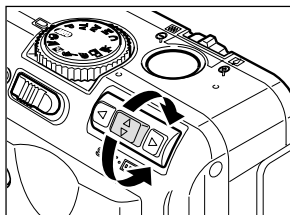

Moving the cursor on the LCD monitor up and down.

Use ▲ or ▼ to select a menu item on the LCD monitor.

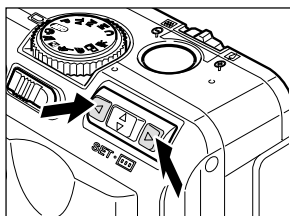

Moving the cursor on the LCD monitor left and right.

Use ◀ or ▶ to select a menu item on the LCD monitor.

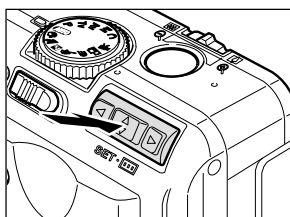

Confirming a menu selection or moving the AF frame.

Press SET or .

Preparing the Camera

Charging the Battery Pack

Recharge Battery Pack NB-2L (supplied) with Battery Charger CB-2LT or CB-2LTE before you use the camera for the first time and subsequently when the "Charge the battery pack" message is displayed.

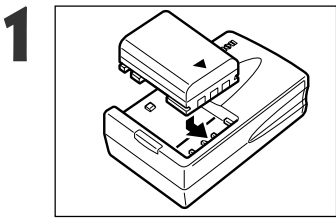

1 Align the edge of the battery pack with the line on the battery charger, then slide the battery in the direction of the arrow.

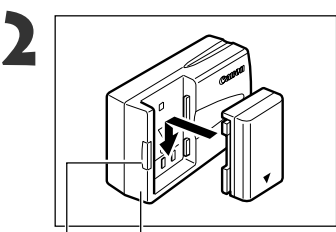

CB-2LT
Charge Indicator

Battery charger model names and types vary by region.

(For CB-2LT)

Plug the battery charger into a power outlet.

(For CB-2LTE)

Attach the power cord to the battery charger and plug it into a power outlet.

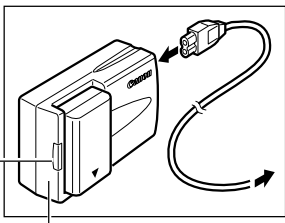

CB-2LTE
Charge Indicator

(For CB-2LT and CB-2LTE)

- The charge indicator will light red while the battery pack is charging. It will change to a steady green when the charge is complete.
- After charging, unplug the battery charger and remove the battery pack from it.



To protect and prolong the life of the battery pack, do not charge it for 24 hours or longer at a time.



- This is a lithium ion battery pack so there is no need to completely use or discharge it before recharging. It can be recharged at any time.
- It takes approximately 80 minutes to bring a fully discharged battery pack to full charge (based on Canon's testing standard). Charging it within a temperature range of 5 to 40° C (41 to 104° F) is recommended.
- Charging times will vary according to the surrounding humidity and battery pack charge state.
- You may hear a noise during charging. This is not a malfunction.

Preparing the Camera, Basic Functions

Charging the Battery Pack (continued)

Battery Pack Handling Precautions

- Keep the battery pack and camera terminals (\oplus Ⓜ \ominus) clean at all times. Dirty terminals may cause a poor contact between the battery pack and camera. Polish the terminals with a tissue or a dry cloth before charging or using the battery pack.
- Do not cover the battery charger with anything, such as a tablecloth, cushion or blanket, when it is charging. Heat will build up internally and possibly lead to fire.
- Do not charge batteries other than Battery Pack NB-2L with the supplied battery charger.
- The battery pack continues to discharge a small amount when left in the camera (even with the power turned off) or battery charger. This shortens the battery life. Remove the battery pack when the camera is not in use.
- Do not allow any metal objects such as keyrings to touch the "+" and "-" terminals (Fig. A), as this can damage the battery pack. To carry the battery pack, or store it during periods of disuse, always replace the terminal cover (Fig. B) or place it in the supplied case and store it in a cool, dry place. Recharge it fully before using it again.

Fig.A

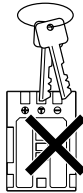
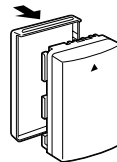

Fig.B



- Even charged battery packs continue to discharge naturally. You are advised to charge the battery on the day of use, or one day before, to ensure a full charge.
- Since storing a fully charged battery pack for long periods of time (about 1 year) can shorten its lifecycle or affect performance, you are recommended to use the battery pack in the camera until it is completely discharged and to store it at normal temperature (23° C / 73° F) or lower. If you do not use the battery pack for long periods of time, charge it fully and discharge it fully in the camera at least once a year before returning it to storage.
- The camera consumes the battery charge when the power is on even when a function is not being used. To conserve the battery charge, be particularly attentive in turning the camera off.
- Although the battery pack's maximum operating range is 0 to 40° C (32 to 104° F), the optimal range is 10 to 30° C (50 to 86° F). At cold temperatures, such as those experienced when skiing, performance will temporarily decline, reducing the usable time before recharging.
- If the usable time of a battery pack diminishes substantially even when fully charged, it should be replaced.

Installing the Battery Pack

Install Battery Pack NB-2L (supplied) into the camera as follows. We recommend that you use the AC Adapter Kit ACK700 (optional) to power the camera for extended periods (p. 162).

1 Turn off the camera (p. 24).

Check that the power/mode indicator is not lit.

2

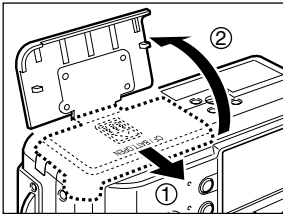

Slide the CF card slot/battery cover in the direction of the arrow to open the cover.

3

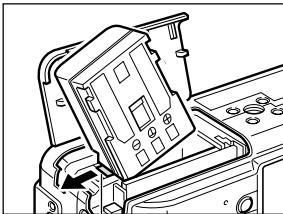

Battery lock

Hold back the battery lock in the direction of the arrow with the corner of the battery pack, then insert the battery pack into the compartment until it is locked.

To remove the battery pack, release the battery lock.

4

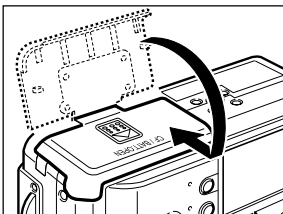

Close the CF card slot/battery cover then slide it to the original position until it clicks.







- Charge the battery pack before using it the first time (p. 15).
- When the upper indicator on the left side of the viewfinder is blinking green, the CF card is being written to, read, erased or transmitted to. Therefore, never turn off the camera or open the CF card slot/battery cover while this indicator is blinking green.
- Remove the battery pack when the camera is not in use.

Installing the Battery Pack (continued)

Battery Low Status

The following icon and/or message appears when the battery becomes low.

	Battery pack charge is low. Recharge it as soon as possible before it is required for an extended period. When the LCD monitor is off, this icon will display when you press the DISPLAY ,  ,  , FUNC. , MF or  button.
Change the battery pack	Battery charge is insufficient to operate the camera. Replace the battery pack immediately.



See *Battery Performance* (p. 172).

Installing a CF Card

- 1** Turn off the camera (p. 24).
Check that the power/mode indicator is not lit.

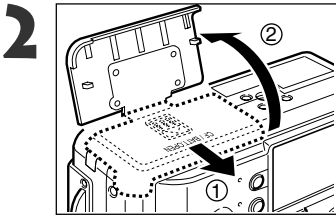

Slide the CF card slot/battery cover in the direction of the arrow to open the cover.

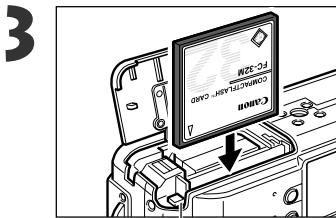

CF card Eject Button

Insert the CF card with the label facing out and the arrow pointing in.

- Push the card in until the CF card eject button fully extends.
- To remove the CF card, push the CF card eject button and pull the card out.



- When the indicator on the left side of the viewfinder blinks green, the camera is writing, reading, erasing or transmitting an image to or from the card. Do not perform the following, for image data may be lost or corrupted:
 - Do not shake the camera.
 - Do not turn off the power or open the CF card slot/battery cover.
- Please note that CF cards formatted in or edited with computers, other manufacturer's cameras or application programs may not operate correctly in the camera.



See *CF Cards and Estimated Capacities* (p. 173).

Installing a CF Card (continued)

CF Card Handling Precautions

- CF cards are high-precision electronic devices. Do not bend, force, or subject them to shocks or vibration.
- Do not attempt to disassemble or alter a CF card.
- Moving a CF card rapidly between temperature extremes may cause condensation to form in the card, leading to potential malfunctions. To avoid condensation formation, place the CF card in a sealed plastic bag before moving it into a different temperature zone and allow it to adjust slowly to the new temperature. If condensation forms on the CF card, put it aside until the water droplets have evaporated completely.
- Place the CF card in the supplied case for storage.
- Do not use or store CF cards in the following types of locations.
 - Locations subject to dust or sand
 - Locations subject to high humidity and high temperatures

Microdrives are a recording medium with a hard disk. Their merits are a large capacity and a low price per megabyte of capacity. However, they can be more susceptible to vibrations and shocks than CF cards, which use durable flash memories. Please be careful, therefore, not to subject the camera to vibrations or shocks when using a microdrive, especially while recording or replaying.

Using the Soft Case (Optional)

Use the soft case SC-PS900 (optional) for storing the camera, batteries and CF card.

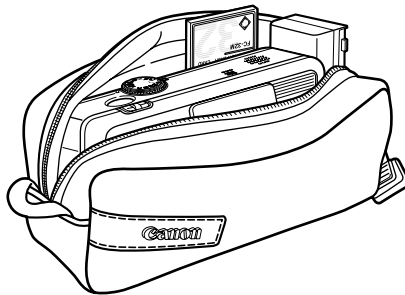

- Soft case appearance may differ in some regions.

Setting the Date / Time

The Set Date/Time menu will appear the first time the camera power is turned on or whenever the built-in rechargeable lithium battery charge is low. Start from Step 5 to set the date and time.

1 Turn on the camera (p. 24).

2 Press the **MENU** button.
The [📷] (Rec.) or [▶] (Replay) menu appears.

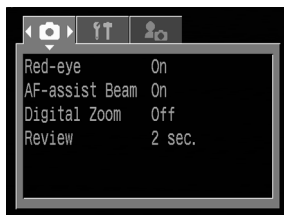

[📷] (Rec.) Menu.

3 Select the [⚙️] (Set up) menu using ▶ on the multicontroller.
Pressing the **JUMP** button also switches between menus.



4 Select [Date/Time] using ▲ or ▼ on the multicontroller, then press **SET**.
The factory default for the date format may differ from that shown here in some regions.

5 Set the date and time.
• Select the item using ◀ or ▶ on the multicontroller.
• Set the values using ▲ or ▼ on the multicontroller.
• The date can be set up to the year 2030.

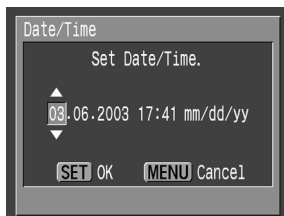

6 Press **SET**.
After adjusting the settings, press the **MENU** button to close the menu window.

Setting the Date / Time (continued)





- You may need to reset the date and time if the battery pack is removed for about three weeks.
- The Date/Time cannot be inserted in the actual image even if the Date/Time have been set.





- Charging the Date/Time Battery
 - The camera has a built-in rechargeable lithium battery that maintains the date, time and other camera settings. This battery recharges when the main battery pack is inserted into the camera. When you first purchase the camera, place a charged battery pack in it or use the AC Adapter Kit ACK700 (sold separately) for at least 4 hours to charge the date/time battery. It will charge even when the camera power is set to Off.
 - If the Set Date/Time menu appears when the camera power is turned on, it means that the date/time battery charge is depleted. Recharge it as described above.
- For printing images with the date on them, refer to page 131.

Setting the Language

1 Turn on the camera (p. 24).

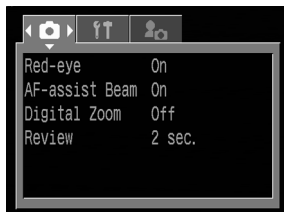
2 Press the **MENU** button.
The  (Rec.) or  (Replay) menu appears.



 (Rec.) Menu.

3 Select the [ (Set up)] menu using **▶** on the multicontroller.
Pressing the **JUMP** button also switches between menus.



4 Select [Language] using **▲** or **▼** on the multicontroller and press **SET**.

5 Select a language using **◀**, **▶**, **▲** or **▼** on the multicontroller.



6 Press **SET**.
After adjusting the settings, press the **MENU** button to close the menu window.



In replay mode, you can change the language by holding **SET** while you press the **JUMP** button. (This function cannot be used while an optional direct print function compatible printer (CP series) or the direct print function compatible Bubble Jet Printer (optional) is connected to the camera or while replaying movies.)

Basic Functions

Turning the Power On / Off

The power/mode indicator remains lit while the power of the camera is on. The power/mode indicator indicates the state of the camera as follows.

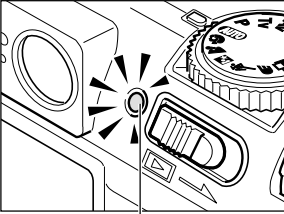

Power/Mode Indicator

- Orange: Shooting mode
- Green: Replaying mode/Printer connection mode*
- Yellow: Computer connection mode*
- Off: The power of the camera is off.

* For printer connection mode, see *Connecting the Camera to a Printer* (p. 126).
For computer connection mode, see the *Software Starter Guide* supplied with the camera.

Turning On/Off the Camera in Shooting Mode

1

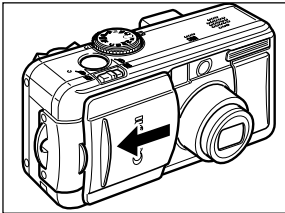

Open the lens cover.

- The camera powers up in Shooting mode.
- The power/mode indicator lights orange.

Close the lens cover.

The power goes off.

Turning On/Off the Camera in Replaying Mode

1

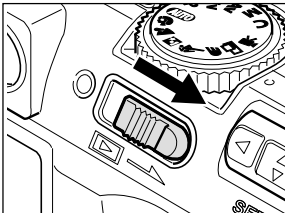

Slide the power/replay lever to the right and hold its position until an image appears on the LCD monitor, then release it.

- The camera powers up in Replaying mode.
- The power/mode indicator lights green.

Slide the power/replay lever to the right again.

The power goes off.



- You will hear a start-up sound and see the start-up image when the power comes on. (To change the startup sound and image, see below and pages 40 and 156.)
- The start-up image does not appear when the LCD monitor is off or the **A/V OUT** terminal is connected to a TV.

Turning on the camera without the start-up sound and image

Press and hold the  button, then turn on the power.

Power-saving Function

The camera is equipped with a power-saving function. If [Auto Power Down] is set to [On], the power goes off according to the following conditions.

- Shooting Mode: Powers down approximately three minutes after the last time a camera control is accessed. The LCD monitor will shut off approximately three minutes after the last time a camera control is accessed even if the power-saving function is turned off.
 - Replaying Mode: Powers down approximately five minutes after the last time a camera control is accessed.
 - Printer Connection Mode: Powers down approximately five minutes after the last time a camera control is accessed on the camera or something is printed on the printer.
- The following are the ways to restore the power.
 - If the power-saving function is activated while the camera is in Shooting mode, press the shutter button halfway.
 - If the power-saving function is activated while the camera is in Replaying mode, slide the power/replay lever to the right again.
 - Please note that the camera continues to consume a minimal amount of power even when the power-saving function shuts it down.
 - The power-saving function is disabled while a slide show plays on the camera or during a computer connection (p. 114).
 - You can turn off the power-saving function in the [ (Set up)] menu (p. 151).

Switching between Shooting and Replaying

You can quickly switch between Shooting mode and Replaying mode. This is convenient when you wish to shoot again after checking or deleting an image immediately after it is shot.

● Shooting Mode

- 1** Slide the power/replay lever to the right (p. 24).
 - The camera switches to Replaying mode. In this case, the lens does not retract.
 - To return to Shooting mode, slide the power/replay lever to the right again or press the shutter button halfway.

● Replaying Mode (With the Lens Cover Closed)

- 1** Open the lens cover (p. 24).

The camera switches to Shooting mode.



Relationship of the Three States (Power Off/Shooting Mode/Replaying Mode) of the Camera

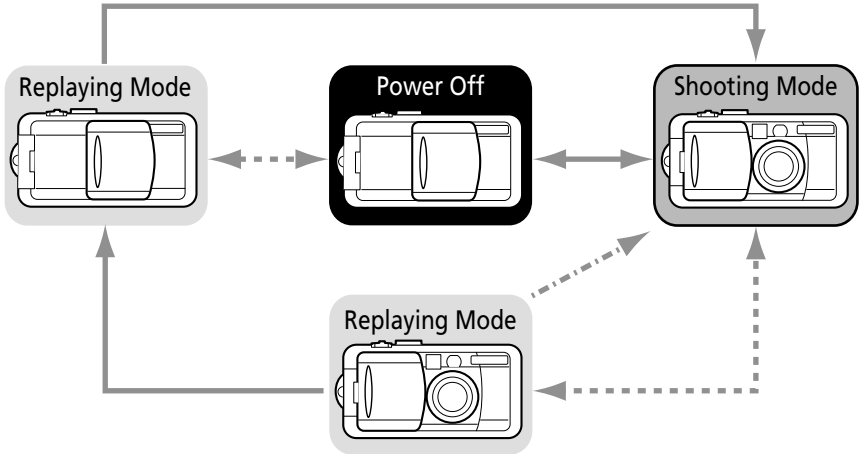

- : Sliding the Power/Replay lever to the right
- : Opening/Closing the lens cover
- : Pressing the shutter button halfway

Using the LCD Monitor

The LCD monitor can be used to confirm an image during shooting, to replay recorded images or to adjust menu settings. Pressing the **DISPLAY** button switches the LCD monitor display mode.

● Shooting Mode

Pressing the **DISPLAY** button cycles the LCD monitor to the next mode each time the button is pressed.

On (No Information) → On (Information View) → Off
↑



- The on/off setting of the LCD monitor display mode is memorized when the camera is turned off. When the camera is turned on again it assumes the last mode. However, when the LCD monitor is turned on and the “Change the Battery Pack” message appears, the LCD monitor may not automatically turn on the next time the camera is started.
- When the LCD monitor is set to On (No Information) or Off, shooting information appears for approximately 6 seconds when you take any of the following actions.
 - The power is turned on.
 - The , or button is pressed.
 - The focus is set with the manual focus.
 - The aperture value and the shutter speed have been set with the multicontroller's buttons.
 - The Shooting mode is changed.
- Setting the mode dial to or turns on the LCD monitor regardless of whether it is set to on or off.



The camera shake warning icon will appear on the LCD monitor in low light conditions while the camera is preparing to shoot. When this icon appears, set the flash to On or Auto, or fix the camera to a tripod to shoot.

● Replaying Mode

- The LCD monitor turns on when you turn on the camera in Replaying mode.
- Pressing the **DISPLAY** button cycles the information view mode each time the button is pressed.

Single Replay (p. 105): Simple Display → Detailed Display → No Display
↑

Index Replay (p. 107): Simple Display ↔ No Display

Information Displayed on the LCD Monitor

The LCD monitor displays information in Shooting or Replaying mode, such as the camera settings, remaining image capacity and shooting date / time.

● Shooting Mode

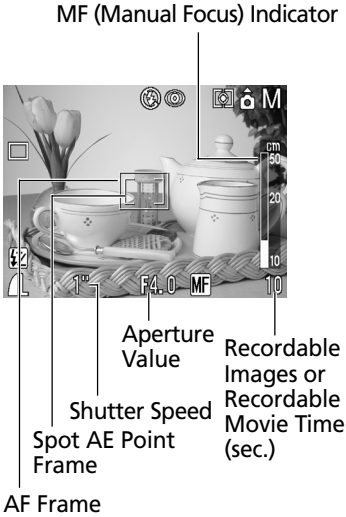

The following displays in information view.

-2 ... +2	Exposure Compensation	p. 79
☀ ☁ ☂ ☃ ☄ ⚡	White Balance (WB)	p. 80
📷 📹 📺 📻 📼	Drive Mode	p. 64, 66
ISO 50 ISO 100 ISO 200 ISO 400	ISO Speed	p. 85
📷 📹 📺 📻 📼	Photo Effects	p. 83
📷 📹	Bracket	p. 86, 88
⚡	Flash Exposure Compensation / Flash Output	p. 93
📷 📹 📺	Compression Settings	p. 49
L M1 M2 S [K20] [160]	Resolution Settings	p. 49
RAW	File Format	p. 52
3.8x 4.9x 6.1x 7.6x 9.3x 12x	Digital Zoom Setting*	p. 65
🔋	Low Battery	p. 18
⚡ ⚡ ⚡	Flash	p. 54
👁	Red-eye Reduction	p. 54
🌸	Macro Mode	p. 63
📷 📷 📷	Light Metering Mode	p. 77
📷 📷 📷	Auto Rotate	p. 103
📷 📷 📷 📷 📷 📷	Shooting Mode	p. 13
📷	Camera Shake Warning	p.28
* 📷	AE Lock/FE Lock	p. 90, 92
MF	Manual Focus	p. 100, 101
● (Red)	Movie Recording Mode	p.62

- The icons in the shaded boxes above appear even when the information view is turned off.
- In addition to the above, the message, shutter speed, AF frame , Spot Light Metering Frame, aperture value and MF indicator (when manual focus is selected) are shown as in the example to the upper left.
- * Zoom powers reflect the combined optical and digital zoom effects. These figures appear when the digital zoom is activated.

Using the LCD Monitor (continued)

● Replaying Mode

File Number



Image Number and Total
(Display Image/
Total)

Shooting
Date / Time

In simple display mode, the following information appears.

	Compression Settings	p. 49
L M1 M2 S	Resolution Settings (still image)	p. 49
RAW	File Format	p. 52
	Sound annotation (wave file)	p. 113
AVI	Movie	p. 109
	Protection Status	p. 118

In detailed display mode, the following information also appears.

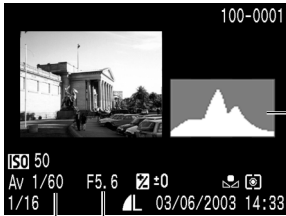

Aperture Value

Shutter Speed

Histogram

ISO 50 100 200 400	ISO Speed	p. 85
	Photo Effects	p. 83
	Shooting Mode	p. 13
	Resolution Settings (Movie)	p. 49
	Exposure level	p. 79
	Flash Exposure Compensation	p. 93
	White Balance	p. 80
	Light Metering Mode	p. 77
	Macro Mode	p. 63
MF	Manual Focus	p. 100, 101

- In addition to the above, the ISO speed, shutter speed, aperture setting, movie length, histogram and overexposure warning appear.

The following information may also appear with some image files.

	An audio file other than a wave file, or a file with an unrecognized format, is attached.
	JPEG file with format not conforming to Design rule for Camera File System Standards.
	File with unrecognized format.



Please note that image information recorded by this camera may not display correctly on other cameras and image information recorded by other cameras may not display correctly on this camera.



About the Histogram

The histogram is a graph that allows you to judge the brightness of the recorded image. The greater the bias toward the left in the graph, the darker the image. The greater the bias toward the right, the brighter the image. If the image is dark, adjust the exposure compensation to a positive number. Similarly, adjust the exposure compensation to a negative number if the image is bright (p. 79).

Histogram Examples



Dark Image



Balanced Image

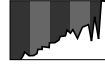

Bright Image

Overexposure Warning

In detailed display mode, overexposed portions of the image blink.

Using the Viewfinder to Shoot

Setting the LCD monitor to Off (p.28) and using the optical viewfinder can help conserve power while shooting.

- The viewfinder has a field of vision of approximately 82% of the actual shooting image.

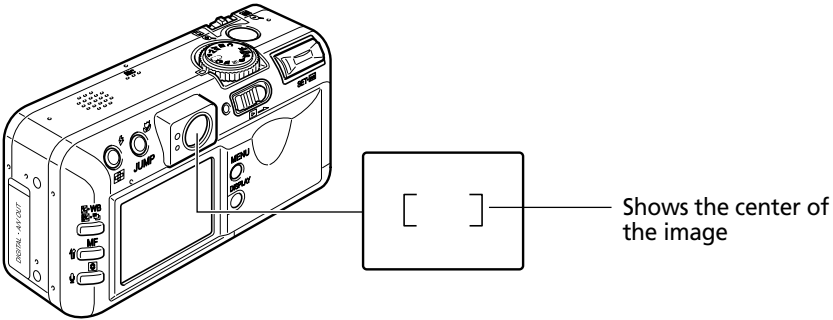

Image Seen in Viewfinder vs. Recorded Image

Please note that the actual image may differ from the image seen in the optical viewfinder due to the physical separation between the viewfinder and lens. This is called the parallax phenomenon and is more noticeable the closer the subject is to the lens. In some cases, portions of images shot up close that appear in the viewfinder will not appear in the recorded image. Please use the LCD monitor to shoot images up close.

Shooting with an Off-Center AF Frame Selected

You should always use the LCD monitor to compose images when you have selected an off-center AF frame. When setting the AF frame to the desired position to shoot an image, please use the LCD monitor (See *Selecting an AF Frame*, p. 74).

Pressing the Shutter Button

The shutter button features a two-stage action.

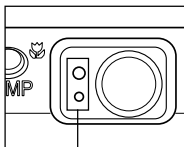
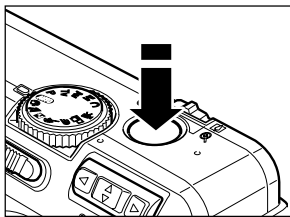

Indicators



AF Frame

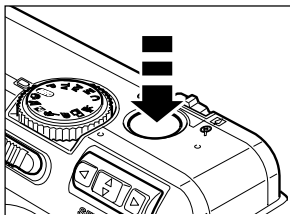

● Pressing Halfway

Pressing halfway automatically sets the exposure, focus and white balance.

- The indicators light or blink as follows.

Upper indicator

- Green: Metering complete (two beeps sound)
- Orange: Flash will fire
- Blinking Orange: Camera shake warning / Insufficient exposure

Lower indicator

- Yellow: Macro mode/Manual focus mode
- Blinking Yellow: Focusing difficulty* (single beep sounds)

* Use the focus lock, or focus manually, to shoot when the indicator blinks yellow (p. 98).

- The AF frame appears as follows when the LCD monitor is on.

- Green: Metering complete
- Yellow: Focusing difficulty*

* The AF frame will not appear on the LCD monitor when it is set to Auto Selection.

● Pressing Fully

Pressing fully releases the shutter.

- The upper indicator blinks green while the image is recording onto the CF card.
- You will hear the shutter sound when the shot is complete. Do not move the camera until you hear this sound.

Pressing the Shutter Button (continued)



- If the orange or yellow indicator blinks while you press halfway, you can still press fully to take the shot.
- Images are first saved into the camera's internal memory before being recorded onto the CF card, allowing the next images to be taken immediately as long as sufficient space is available in the internal memory.
- The beep and shutter sound can be set On / Off in the Set up menu (p. 151).
- When the shutter sound is set to Off, but the beep is set to On, one beep will sound when the shutter button is fully pressed.
- There is no shutter sound in movie mode.
- Shots cannot be taken while the flash is charging.

AF-assist Beam



- The AF-assist beam will sometimes emit when the shutter button is pressed halfway to assist focusing in certain conditions, i.e. dark conditions.
- The AF-assist beam can be turned off (p. 149).
If animals are your subject, turn off the beam when shooting in the dark to avoid startling them. However, please keep in mind the following facts.
 - Turning the AF-assist beam off may make it more difficult for the camera to focus.
 - The red-eye reduction lamp may emit when you press the shutter button halfway even if the AF-assist beam is turned off.In order to prevent any lamp from emitting before the flash fires, set both the red-eye reduction function and the AF-assist beam to [Off] in the Shooting menu.

Using the Zoom (Focal Length)

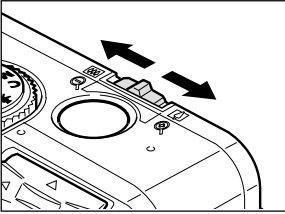
The zoom can be adjusted from 35 to 105 mm (equivalent to 35 mm film format).



Telephoto / Wide Angle

- Slide the zoom lever toward  to zoom in (telephoto).
- Slide the zoom lever toward  to zoom out (wide angle).



Digital Zoom

An image already zoomed with the optical zoom lens can be further zoomed up digitally to an approximate factor of 12 for shooting (p. 65).

.....
 The digital zoom cannot be used with certain Shooting modes (p.180).

.....
 The more the image is zoomed digitally, the coarser its image quality becomes.

Selecting Menus and Settings

Menus are used to adjust shooting, replaying, date / time and electronic sound settings. Menus can be displayed by either pressing the  / **WB / FUNC.** button or the **MENU** button. Watch the LCD monitor while performing the following procedures.

Selecting Settings by Pressing the FUNC. Button (Only in Shooting Mode)

1 Press the / **WB / FUNC.** button.

- Icons of the selectable settings appear on the left side of the LCD monitor.
- The current settings icons appear.



2 Select a menu item using **▲** or **▼** on the multicontroller.



3 Select setting contents using **◀** or **▶** on the multicontroller.

Some menu items can only be selected after pressing **SET** and displaying the next menu. Press **SET** again to confirm the setting.

4 Press the / **WB / FUNC.** button.

- The menu closes.
- Images can be shot immediately with the selected settings after Step 3 by pressing the shutter button.

Selecting Settings by Pressing the MENU Button

1 Press the **MENU** button.

In Shooting mode, the [📷 (Rec.)] menu appears. In Replaying mode, the [▶ (Replay)] menu appears.

2 Switch between menu tabs using ◀ or ▶ on the multicontroller.

- The menu switches as follows:
[📷 (Rec.)] or [▶ (Replay)] ↔ [f (Set up)] ↔ [📷 (My Camera)]
- Pressing the **JUMP** button or the zoom lever also switches between the menu tabs.



3 Select a menu item using ▲ or ▼ on the multicontroller.

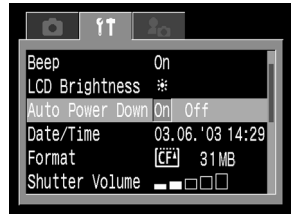

4 Select setting contents using ◀ or ▶ on the multicontroller.

Press **SET** for items followed by an ellipsis (...) then select a setting. Press **SET** again to confirm the setting.

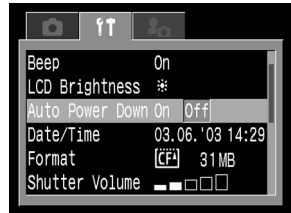

5 Press the **MENU** button.







- The menu closes.
- In Shooting mode, the menu can be closed by pressing the shutter button halfway. (In Replaying mode, the menu closes when the shutter button is pressed halfway and the camera switches to Shooting mode if the lens cover is open.)

Selecting Menus and Settings (continued)



Menu Settings and Factory Defaults

This chart shows the options for each menu and the default settings.

Menu Items Selectable with the FUNC. Button

Menu Item	Available Settings	Reference Page
Exposure Compensation	-2 ~ ±0* ~ +2	79
White Balance		80
Drive Mode		64, 66
ISO Speed	AUTO / 50 / 100 / 200 / 400	85
Photo Effect		83
Bracket		86, 88
Flash Exposure/Flash Output	-2 to +2 1 ~ 3 (FULL)	93
Resolution, File Format, Compression	(Still picture) L* / M1 / M2 / S / RAW (Movie)  (Compression) 	49, 52

Menu Items Selectable with the MENU Button

Menu Item	Available Settings	Reference Page
Flash Sync	1st-curtain*, 2nd-curtain	95
Slow Synchro	On/Off*	55
Flash Adjust	Auto*/ Manual	93
Red-eye	On*/ Off	54
 Spot AE Point	Center* / AF Point	77
Rec. Menu (Red)		
MF-Point Zoom	On*/ Off	100
AF-assist Beam	On*/ Off	149
Digital Zoom	On / Off*	65
Review	Off / 2* to 10 sec.	47
Intervalometer	Automatically shoots images at a set time interval	96
Save Settings...	Saves customized settings	102
 Protect	Turns image protection on and off	118
Replay Menu (Blue)		
Rotate	Rotates the image in the display	112
Erase all	Erases all images on the CF card	120
Slide Show	Replays selected images in a slide show	114
Print Order	Sets the print settings	135
Transfer Order	Sets the transfer settings	142

	Menu Item	Available Settings	Reference Page
f Set up Menu (Yellow)	Beep	On* / Off	151
	LCD Brightness	* /	151
	Auto Power Down	On* / Off	151
	Date/Time	Sets the date and time	21
	Format	Formats the CF card	121
	Shutter Volume	Off / 1 / 2* / 3 / 4 / 5	152
	Playback Vol.	Off / 1 / 2* / 3 / 4 / 5	152
	Start-up Vol.	Off / 1 / 2* / 3 / 4 / 5	152
	Operation Vol.	Off / 1 / 2* / 3 / 4 / 5	153
	Selftimer Vol.	Off / 1 / 2* / 3 / 4 / 5	153
	File No. Reset	On / Off*	104
	Auto Rotate	On* / Off	103
	Distance Units	m/cm* / ft/in	153
	Language	English* / Deutsch / Français / Nederlands / Dansk / Suomi / Italiano / Norsk / Svenska / Español / Chinese / Japanese	23
	Video System	NTSC / PAL	154
My Camera Menu (Purple)	Theme	/ 1 * / /	40, 155
	Start-up Image	/ 1 * / /	40, 155
	Start-up Sound	/ 1 * / /	40, 155
	Operation Sound	/ 1 * / /	40, 155
	Selftimer Sound	/ 1 * / /	40, 156
	Shutter Sound	/ 1 * / /	40, 156

* Default values. Default video system settings vary between regions.

- Some menu items are not available in certain Shooting modes (p. 180).
- You can apply a desired image and sound to and in the My Camera menu. For details, see *Registering My Camera Settings* (p. 42) or the *Software Starter Guide*.
- The default of the settings changed by the menu and button operations except for [Date/Time], [Language] and [Video System] can be restored all at once (p. 157).

Customizing the Camera (My Camera Settings)

My Camera allows you to customize the start-up image and start-up, shutter, operation and self-timer sounds. Each menu item has three choices.

e.g. Start-up image

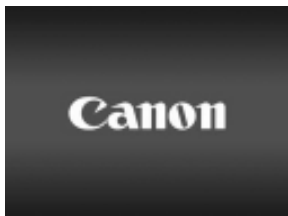

[1]

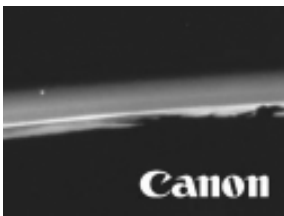

[2]

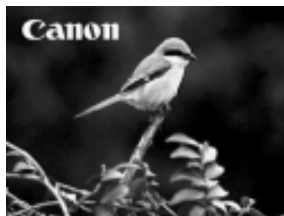

[3]

As default settings, My Camera setting [2] has a science fiction theme and My Camera setting [3] has an animal theme.

Changing My Camera Settings

1 Turn on the camera (p. 24).

2 Press the **MENU** button.
The [Rec.] or [Replay] menu appears.

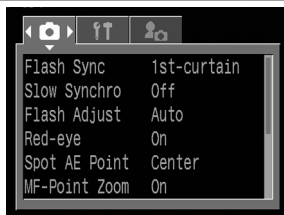

3 Select the [My Camera] menu using ► on the multicontroller.

Pressing the **JUMP** button also switches between the menu tabs.

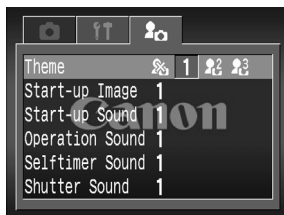

4 Select a menu item using ▲ or ▼ on the multicontroller.

5 Select setting content using ◀ or ▶ on the multicontroller.



6 Press the **MENU** button.

- Pressing the **MENU** button closes the menu and makes the settings take effect.
- In Shooting mode, the menu can be closed by pressing the shutter button halfway. (In Replaying mode, the menu closes when the shutter button is pressed halfway and the camera switches to Shooting mode if the lens cover is open.)



- If you select [Theme] in Step 4, you can select a consistent theme for each of the My Camera Settings.
- If [Beep] in the [SETUP] (Set up) menu is set to [On], the beep sounds even if each sound item such as [Start-up Sound], [Operation Sound], [Selftimer Sound] and [Shutter Sound] in the [CAMERA] (My Camera) menu is set to [OFF] (Off) (p. 151).

Registering My Camera Settings

Images recorded onto the CF card and newly recorded sounds can be added as My Camera settings to the **[M]** and **[S]** menu items. You can also use the supplied software to upload your computer's images and sounds to the camera.

The following menu items can be saved to the camera.

- Start-up Image
- Start-up Sound
- Operation Sound
- Selftimer Sound
- Shutter Sound

Registering CF Card Images and Sounds

1 Turn on the camera (p. 24).

2 Slide the power/replay lever.
The camera switches to Replaying mode.

3 Press the **MENU** button.
The **[M]** (Replay) menu appears.

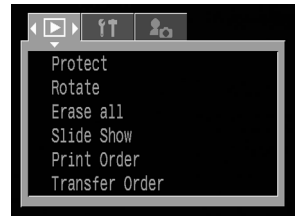

4 Select the **[M]** (My Camera) menu using **▶** on the multicontroller.
Pressing the **JUMP** button also switches between the menu tabs.



5 Select the menu item you wish to register using **▲** or **▼** on the multicontroller.

6 Select **[M]** or **[R]** using ◀ or ▶ on the multicontroller.

DISPLAY  appears.

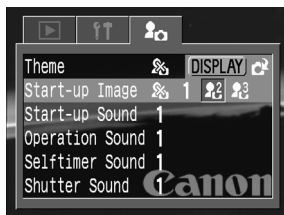

7 Press the **DISPLAY** button.

An image appears.

[Start-up Image] → Step 8a, 9a

[Start-up Sound], [Shutter Sound], [Selftimer Sound] → Step 8b, 9b



8a Select the image you wish to register using ◀ or ▶ or on the multicontroller.



9a Press **SET**.

8b Select  (Record) using ◀ or ▶ on the multicontroller and press **SET**.

- Recording starts.
- Recording stops when the set amount of time has passed.

Start-up Sound: 1 second, Operation Sound: 0.3 second, Selftimer Sound: 2 seconds, Shutter Sound: 0.3 second.

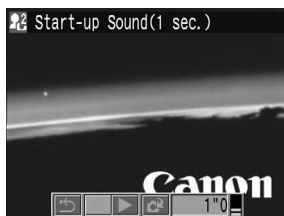

9b Select **[R]** (Register) using ◀ or ▶ or on the multicontroller.

10 Select **[OK]** using ◀ or ▶ or on the multicontroller and press **SET**.



Registering My Camera Settings (continued)



- Sounds recorded with the movie (p.62) and sound annotation (p.113) functions cannot be added as My Camera settings.
- When you register new My Camera settings, the previously registered settings are erased.

File Format of My Camera Settings

My Camera settings should conform to the below file formats. However, CF card images shot with this camera can be registered as My Camera settings regardless of the below formats.

● Start-up Image

- Recording image format JPEG (Base line JPEG)
- Sampling rate 4:2:0 or 4:2:2
- Image size 320 x 240 pixels
- File capacity 20 KB or less

● Start-up Sound, Operation Sound, Selftimer Sound and Shutter Sound

- Recording format WAVE (monaural)
- Quantization bit 8 bit
- Sampling frequency 11.025 kHz and 8.000 kHz
- Recording time

	11.025 kHz	8.000 kHz
Start-up Sound	1.0 sec. or less	1.3 sec. or less
Operation Sound	0.3 sec. or less	0.4 sec. or less
Selftimer Sound	2.0 sec. or less	2.0 sec. or less
Shutter Sound	0.3 sec. or less	0.4 sec. or less

Any file format other than those described above cannot be used with this camera.

An example of this function is to record "Say cheese" as a self-timer sound so the camera will replay this sound 2 seconds before the photo is taken. You could also record cheerful music to bring out the natural smiles of your subjects, or so they can strike a pose fitting the music. In these ways you can customize your camera by creating and adding new My Camera settings.

See the supplied *Software Starter Guide* for more information on creating and adding to the My Camera Settings files.

Shooting - Letting the Camera Select Settings

See *Functions Available in Each Shooting Mode* (p. 180) at the end of this manual to find out which settings can be changed in which Shooting modes.

AUTO Auto Mode

In this mode, all you have to do is press the shutter button and let the camera do everything else.

1 Check that the camera is in Shooting mode (p. 24).

2 Turn the shooting mode dial to **AUTO**.

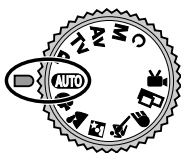

3 Aim the camera at the subject.

4 Use the zoom lever to achieve the desired composition (relative subject size in the viewfinder).

5 Press the shutter button halfway (p. 33).

- Two beeps will sound when the camera has finished metering, and the indicator beside the viewfinder will light green or orange. If the LCD monitor is on, the AF frame will light green.
- The shutter speed and aperture value are automatically determined and show on the LCD monitor if it is on.
- The yellow indicator will blink and the beep will sound one time if the subject is difficult to focus on. The AF frame will also appear yellow. (When the AF frame is set to Auto selection it will not appear)



AF Frame

6 Press the shutter button all the way (p. 33).

- You will hear the sound of the shutter when the shutter activates.
- The picture appears for two seconds on the LCD monitor, if it is on.

Auto Mode (continued)



- *Functions Available in Each Shooting Mode* (p. 180)
- You can change the length of time images show on the LCD monitor after shooting, or set it so they do not show at all (p. 48).

Reviewing an Image Right after Shooting

Reviewing the Image

After a photo is taken, the image displays on the LCD monitor for two seconds. (To change this setting, see page 48.) There are two ways to display the image for longer.

● Keeping the Shutter Button Pressed

The image continues to appear on the LCD monitor as long as you keep the shutter button fully depressed.

● Pressing **SET** while the image is displayed

If you press **SET** while the image is displayed on the LCD monitor, it will continue to display even after the shutter button is released.

Press the shutter button halfway again to stop displaying it and shoot an image.

.....



You can perform the following while images are displayed.

- Erasing Images Individually (p. 9, 119)
- Displaying Images in detailed display mode (p. 28)
- Magnifying Images (p. 106)
- Changing the Recording Format (p. 52)
- Attaching Sound Annotations (p. 113)

Changing the Recording Format Right after Shooting

By following the below instructions, you can save images shot in the JPEG format in the RAW format (p. 52) right after shooting if the camera is set to **P**, **Tv**, **Av**, **M**, or **C***. You can easily process images saved in the RAW format using a computer to edit the resolution, photo effect and white balance without any loss of quality.

* The JPEG format image will not be saved.

1 Right after shooting, press the  / **WB / FUNC.** button while the image is displayed on the LCD monitor.

2 Select [OK] using ◀ or ▶ on the multicontroller and press **SET**.

- The image is recorded in the RAW format.
- When you press the shutter button halfway, the camera returns to the shooting screen.



Reviewing an Image Right after Shooting (continued)



The above operations cannot be performed if the image was shot with the digital zoom or when **RAW** is already selected as the recording format.

Changing the Image Display Duration

The length of time images are displayed after a photo has been taken can be changed anywhere from 2 seconds to 10 seconds or turned off.

1 In the [CAM (Rec.)] menu, select [Review].

See *Selecting Menus and Settings* (p. 36).

2 Select a Review setting and press the **MENU** button.

- With the [Off] option, the image will not automatically display.
- With the [2 sec.] to [10 sec.] options, the image will appear for the time selected even if the shutter button is released.
- You can continue to display the image as long as the shutter button is fully held pressed regardless of the Review setting.
- Another picture can be taken even while the last is displayed.

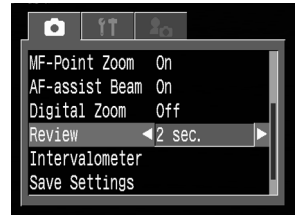



Changing the Resolution and Compression



You can change the resolution and compression (excluding movies) settings to suit the purpose of the image you are about to shoot. To record the CCD output without compression, select the RAW file format (p. 52).

Resolution			Purpose
L (Large)	2592 x 1944 pixels		High ↑↓ Low
M1 (Medium 1)	1600 x 1200 pixels	<ul style="list-style-type: none"> • Print postcard size 148 x 100 mm (6 x 4 in.) prints • Print L size 119 x 89 mm (4.7 x 3.5 in.) prints 	
M2 (Medium 2)	1024 x 768 pixels	Print card size 86 x 54 mm (3.4 x 2.1 in.) prints	
S (Small)	640 x 480 pixels	<ul style="list-style-type: none"> • Send images as e-mail attachments • Shoot more images 	

*Paper sizes vary according to region.



Compression			Purpose
	Superfine		High Quality ↑↓ Normal
	Fine	Shoot normal quality images	
	Normal	Shoot more images	

- Movies can be shot with the following resolution.

Resolution	
	320 x 240 pixels
	160 x 120 pixels

1 Turn the shooting mode dial to the desired Shooting mode.

2 Press the  / **WB / FUNC.** button.

3 Select  **L*** (2592 x 1944) using  or  on the multicontroller.

* The current setting is displayed.



Changing the Resolution and Compression (continued)

- 4 Select the resolution you wish to set using ◀ or ▶ on the multicontroller.

Excluding 



Number of recordable images _____
(Only displayed when the resolution, compression or file format is selected)

- 5 Press **SET**.

- 6 Select the compression you wish to set using ◀ or ▶ on the multicontroller.

You can shoot the image right after selecting settings by pressing the shutter button. This screen will appear again, once the image is shot.



- 7 Press the  / **WB** / **FUNC.** button.

- 8 Shoot the image.



- Some settings are not available with certain Shooting modes. Please refer to *Functions Available in Each Shooting Mode* (p. 180)
- Size of an image file (approximate) (p.173)
- Types of CF cards and resolution (p. 173)
- The resolution and compression settings are affected by the Shooting mode selection as follows (only the resolution in 'M' mode).

Initial Shooting Mode	Next Shooting Mode	Resolution and Compression after Change
AUTO C	AUTO P Tv Av M C	Settings change to those of the next mode
		Settings do not change
	AUTO P Tv Av M C	Settings change to those of the next mode
P Tv Av M	P Tv Av M	Settings do not change
	AUTO C	Settings change to those of the next mode

Changing the File Format

The recording file format can be switched to the RAW format before shooting the image.

With the standard JPEG file format, the camera processes images after capturing them to produce optimal results. The JPEG format compresses images so that more can be stored on a single CF card. However, the compression is irreversible, meaning that the original image data cannot be recovered after processing. In contrast, the RAW format records the image data as captured by the camera's CCD without further processing. RAW images are compressed, but the compression is reversible** so that a high-quality image can be obtained from the decompressed file without any loss of image quality. In addition, although a RAW file is larger than an equivalent JPEG file, it is still only approximately one-quarter the size* of an uncompressed RGB TIFF format file, making it relatively compact.

With standard uncompressed file formats, such as RGB TIFF, images are processed in the camera and require further processing by retouching software to adjust the image parameters, which reduces image quality. With the RAW format, however, the original data can be used in special software** to adjust the image parameters (white balance, contrast, sharpness and saturation) making it possible to maintain the image quality while making changes. The resolution (2592 x 1944) and compression settings cannot be adjusted for these images.

* As measured by Canon's testing standard.

** The bundled software can be used to open or adjust the parameters of images recorded in the RAW file format. Please consult the *Software Starter Guide* for details.

1 Turn the shooting mode dial to **P**, **Tv**, **Av**, **M** or **C**.

2 Press the  / **WB / FUNC.** button.

3 Select  **L*** (2592 x 1944) using **▲** or **▼** on the multicontroller.

* The current setting is displayed.



4 Select RAW using ◀ or ▶ on the multicontroller.

You can shoot the image right after selecting settings by pressing the shutter button. The previous screen will appear again, once the image is shot.

5 Press the / **WB / FUNC.** button.

6 Shoot the image.

.....



Images shot in the JPEG format can also be changed to the RAW format while they are displayed right after shooting (p. 47).

⚡ Using the Flash

Use the flash according to the guidelines below.

⚡ ^A 👁	Red-eye reduction, Auto	The flash fires automatically as required by the lighting level, and the red-eye reduction lamp fires each time the main flash fires
⚡ ^A	Auto	The flash fires automatically as required by the lighting level.
⚡ 👁	Red-eye reduction, Flash on	The red-eye reduction lamp and the flash always fire.
⚡	Flash on	The flash always fires.
🚫	Flash off	The flash does not fire.

1 Press the ⚡ button to switch between flash modes.

- The selected flash mode appears on the LCD monitor.
- You can switch between settings by pressing the ⚡ button.



When the red-eye reduction function is on

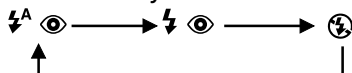

When the red-eye reduction function is off

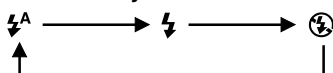

2 Shoot the image.

- The flash will fire if the indicator beside the viewfinder lights orange when the shutter button is pressed halfway. (In 🚫, the flash does not fire.)
- Shooting procedures are the same as for the **AUTO** mode (p. 45).

Setting the Red-eye Reduction Function

The red-eye reduction lamp fires when the flash is used in dark areas. This prevents light from reflecting back from the eyes and making them appear red.

1 In the [Ⓜ (Rec.)] menu, set [Red-eye] to [On].

👁 appears on the LCD monitor.



When shooting with the red-eye reduction function, the subjects must look right at the red-eye reduction lamp for this mode to be effective. Try asking them to look directly at the lamp. Even better results can be obtained by shooting with the lens set to a wide angle, increasing the lighting in indoor settings or approaching closer to the subject.

Setting the Slow Synchro

You can shoot images using the flash with a slow shutter speed. This helps avoid dark backgrounds when shooting night scenes or with indoors lighting conditions.

1 In the [Ⓜ (Rec.)] menu, set [Slow Synchro] to [On].



When shooting with a high ISO sensitivity and using the built-in flash, there is more of a chance of overexposure the closer you are to the subject.



- Some settings are not available with certain Shooting modes. Please refer to *Functions Available in Each Shooting Mode* (p. 180)
- The flash fires twice. A pre-flash will fire and will be followed by the main flash. The pre-flash is used by the camera to obtain the subject's exposure data so that the main flash can be set to the optimal intensity for the shot.
- The fastest shutter speed for flash synchronization is 1/250 second. The camera automatically resets the shutter speed to 1/250 second if a faster speed is selected.
- The flash fires with automatic adjustments when [Flash Adjust] is set to [Auto] in the [Ⓜ (Rec.)] menu. When shooting in **M** mode, or with [Flash Adjust] set to [Manual], the flash fires with the manually set adjustments.
- Shots cannot be taken while the flash is charging.
- The flash may take up to approximately 10 seconds to charge in some cases. Actual times will vary according to usage and the battery charge.
- The [Ⓜ (Flash)] (flash exposure) and the [Flash Output] can be changed (p. 93).
- The flash setting is saved when the camera is turned off in the **P**, **Tv**, **Av**, **M** and **C** Shooting modes.
- When shooting with [Slow Synchro] set to [On], we recommend the use of a tripod to prevent camera shake.

Portrait Mode

Use this mode when you want the subject to appear sharp and the background to blur.



1



Turn the shooting mode dial to .

Shooting procedures are the same as for the **AUTO** Mode (p. 45).



- *Functions Available in Each Shooting Mode* (p. 180)
- To best achieve the effect of the background gradually fading, compose the image so that the upper half of the subject's body fills most of the viewfinder or LCD monitor.
- The background gets increasingly indistinct the more you adjust the focal length toward telephoto.

Landscape Mode

Use this mode to shoot expansive landscape scenes.



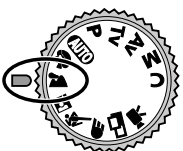

1



Turn the shooting mode dial to .

Shooting procedures are the same as for the **AUTO** Mode (p. 45).





- *Functions Available in Each Shooting Mode* (p. 180)
- Since a slow shutter speed is often selected in  mode, use a tripod to shoot if the  (camera shake warning) icon appears on the LCD monitor.

Night Scene Mode

Use this mode to capture human subjects against the backdrop of an evening sky or night scene. The people are illuminated with light from the flash while the backdrop is captured at a slow shutter speed so that both appear correctly exposed.

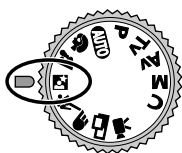
1





Turn the shooting mode dial to .

Shooting procedures are the same as for the **AUTO** mode (p. 45).



Always use a tripod to prevent camera shake in this mode.



- *Functions Available in Each Shooting Mode* (p. 180)
- Warn people to stay still for a few seconds after the flash fires because of the slow shutter speed.
- Using the  mode in daylight will produce an effect similar to that of the **AUTO** mode.
- With the  mode, the slow synchro function automatically turns on.



Fast Shutter

Use this mode to shoot fast moving objects.

1

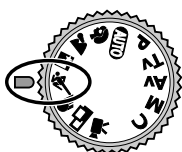

Turn the shooting mode dial to .

Shooting procedures are the same as for the **AUTO** mode (p. 45).



- *Functions Available in Each Shooting Mode* (p. 180)
- Noise in the recorded image may increase if you shoot dark subjects.

Slow Shutter

Use this mode to shoot moving objects to make them appear blurred such as river rapids.



1

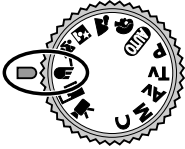

Turn the shooting mode dial to **S**.

Shooting procedures are the same as for the **AUTO** mode (p. 45).



- *Functions Available in Each Shooting Mode* (p. 180)
- Always use a tripod to prevent camera shake in this mode.



Stitch Assist Mode

Use this mode to shoot a series of overlapping frames for merging (stitching) into a large panoramic image using a computer.

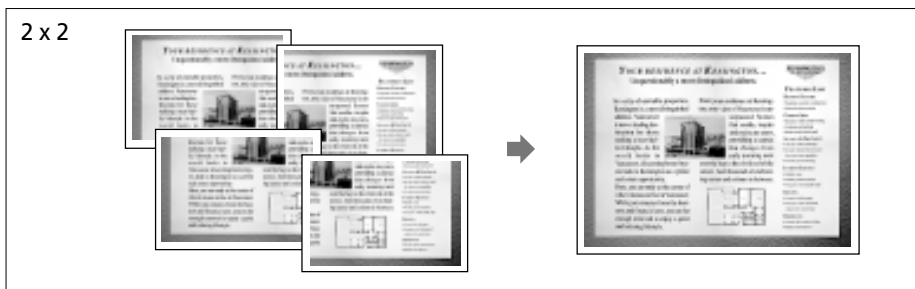
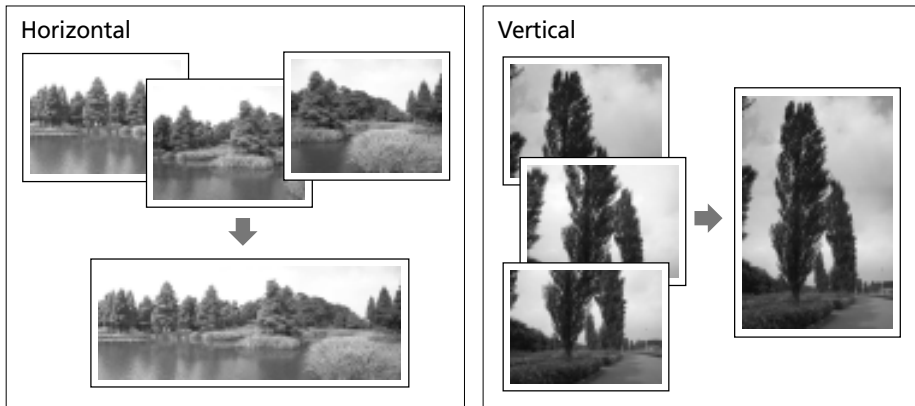

.....



Please use the bundled PhotoStitch program to merge the images on a computer.

Framing a Subject

PhotoStitch detects the overlapping portions of adjoining images and merges them. When composing shots, try to include a distinctive item (landmark, etc.) in the overlapping portions.

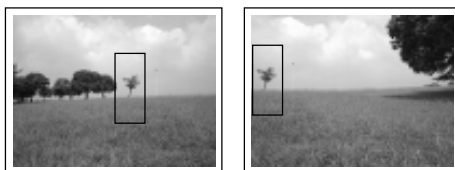





Stitch Assist Mode (continued)



- Compose each frame so that it overlaps 30 to 50% of the adjoining image. Try to keep the vertical misalignment to within 10% of the image height.
- Do not include moving items in the overlap.
- Do not try to stitch images that include both distant and close subjects. Objects may appear warped or doubled up.
- Make the brightness in each image consistent. The final image will appear unnatural if the difference in brightness is too great.
- For good results, pan (swivel) the camera to take successive shots.
- To shoot close-ups, slide the camera over the subject, keeping it parallel as you move.

Shooting

Images can be shot in the following 5 sequences in Stitch Assist mode.

	Horizontally, left to right
	Horizontally, right to left
	Vertically, bottom to top
	Vertically, top to bottom
	Clockwise starting at the top left

1

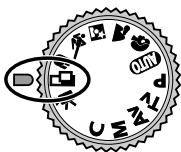

Turn the shooting mode dial to  .
The LCD monitor will turn on.

2

Select the shooting sequence using **◀** or **▶** on the multicontroller and press **SET**.

You can also press the shutter button directly to shoot without pressing **SET**.





3

Shoot the first image.

The exposure and white balance settings are set and locked with the first image.

4 Compose and shoot the second image so that it overlaps the first.

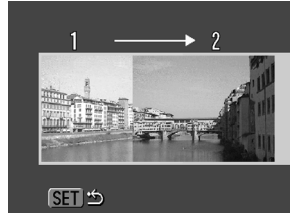
- Minor discrepancies in the overlap can be corrected with the software.
- An image can be retaken. Press ◀ or ▶ on the multicontroller to return to that frame.

Sequence Sequence 

5 Use the same procedures to shoot the remaining frames.

A maximum of 26 images can be recorded either horizontally or vertically.

6 Press **SET** after the last shot.





- A custom white balance setting (p. 80) cannot be set in  mode. To use a custom white balance setting, first set it in another Shooting mode.
- The settings in place for the first image are locked in and cannot be changed for subsequent shots.
- A TV cannot be used as the monitor for shooting in this mode.



Functions Available in Each Shooting Mode (p. 180)

Movie Mode

Use this mode to shoot movie frames. The resolution can be set to either [ (320 × 240 (default setting))] or [ (160 × 120)] (p. 49).

1



Turn the shooting mode dial to .

The LCD monitor turns on and displays the maximum recording time (in seconds).



2

Press the shutter button all the way.

- Shooting and sound recording starts simultaneously.
- During the shooting a red circle appears in the upper right of the LCD monitor.

3

Press the shutter button all the way to stop recording the movie.

The maximum length of individual movie clips (approximately 15 frames/second) is about 3 minutes* at the  setting and about 3 minutes* at the  setting. The clip will end automatically after this time elapses or when the CF card becomes full.

* The data reflects Canon's testing standard. The actual figures will vary according to the shooting objects and conditions.



- Be careful not to touch the microphone while shooting.
- The AE, AF, white balance and zoom settings are set and locked to the settings of the first frame.
- If the indicator on the left side of the viewfinder blinks green after a shot, this indicates that the movie is being written to the CF card. You cannot shoot again until it stops blinking.





- *Functions Available in Each Shooting Mode* (p. 180)
- Sound is recorded monaurally.
- There is no shutter sound in movie mode.
- QuickTime 3.0 or higher is required to replay movie files (AVI / Motion JPEG) on a computer. (QuickTime (for Windows) is bundled on the supplied Digital Camera Solution Disk. On the Macintosh platform, QuickTime 3.0 or later is generally bundled with Mac OS 8.5 or later operating system.)

Macro Mode

Use the macro mode to shoot close-ups of subjects in the range of 10 to 50 cm (3.9 in. to 1.6 ft.) at wide angle end and 30 to 50 cm (1.0 ft. to 1.6 ft.) at telephoto end.

1 Press the **DISPLAY** button to turn the LCD monitor on.

2 Press the  button.

- The  icon appears on the LCD monitor.
- Press the  button again to cancel the macro mode.

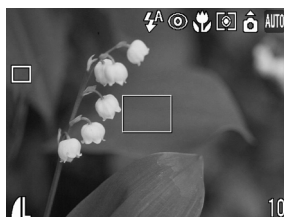

3 Shoot the image.

- The indicator beside the viewfinder will light yellow when the shutter button is pressed halfway.
- Shooting procedures are the same as for the **AUTO** Mode (p. 45).



- Some settings are not available with certain Shooting modes. Please refer to *Functions Available in Each Shooting Mode* (p. 180).
- Always use the LCD monitor to compose images in macro mode. Shooting with the viewfinder is possible, though, the parallax phenomenon may cause images composed with the optical viewfinder to be off-center (p. 32).
- When the lens is zoomed out to the wide angle end, the recordable area is 110 × 80 mm (4.33 in. × 3.15 in.) at the closest focal distance, and at telephoto end, it is 113 × 83 mm (4.45 in. × 3.27 in.).
- The exposure may not be optimal when the flash is used in macro mode.



Self-Timer



You can take pictures with the self-timer in any Shooting mode.

1 Press the  / **WB / FUNC.** button.

2 Select * (Drive mode) using **▲** or **▼** on the multicontroller.



* The current setting is displayed.

3 Select  or  using **◀** or **▶** on the multicontroller and press the  / **WB / FUNC.** button.

When  is selected, the shutter release will be delayed for 10 seconds, and when  is selected, the shutter release will be delayed for 2 seconds, after you press the shutter button.



4 Shoot the image.

- When  is selected, the self-timer lamp starts blinking when the shutter button is pressed all the way. The self-timer sounds and the blinking gets faster two seconds before the shutter activates.
- When  is selected, the self-timer lamp blinks fast from the beginning. The shutter activates in two seconds.
- Shooting procedures are the same as for the **AUTO** mode (p. 45).





- Some settings are not available with certain Shooting modes. Please refer to *Functions Available in Each Shooting Mode* (p. 180)
- You can change the self-timer sound by changing the setting in [Selftimer Sound] in the  (My Camera) menu (p. 156).

Digital Zoom

With the combined optical and digital zoom functions, images can be zoomed as follows.

3.8 times, 4.9 times, 6.1 times, 7.6 times, 9.3 times and 12 times

1 Press the **DISPLAY** button to turn the LCD monitor on.

2 Turn the shooting mode dial to any Shooting mode except for  or .

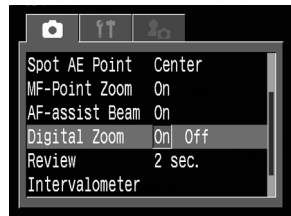

3 In the [ (Rec.)] menu, select [Digital Zoom].

See *Selecting Menus and Settings* (p. 36).



4 Select [On] and press the **MENU** button.

5 Slide the zoom lever toward  and hold it.

- The lens will zoom to the maximum optical telephoto setting and stop. Release the lever and slide it toward  again to further zoom the image digitally.
- Slide the lever toward  to zoom back out.



The combined magnifications of the optical zoom and digital zoom are displayed.

6 Shoot the image.

Shooting procedures are the same as for the **AUTO** mode (p. 45).

.....



The digital zoom cannot be used when the LCD monitor is off or with the RAW file format.

.....



- Some settings are not available with certain Shooting modes. Please refer to *Functions Available in Each Shooting Mode* (p. 180)
- Images become coarser the more they are digitally zoomed.



Continuous Shooting

Use this mode to shoot successive frames while the shutter button is fully pressed.

	Standard Continuous Shooting	Use this mode to view the images as you shoot continuously. The shutter interval is longer in this mode than in mode.
	High Speed Continuous Shooting	Use this mode to shoot continuously with a short shutter interval. You cannot check images while shooting continuously.

1 Press the / **WB / FUNC.** button.

2 Select * (Drive mode) using **▲** or **▼** on the multicontroller.

* The current setting is displayed.

3 Select or and press the / **WB / FUNC.** button.



4 Press the shutter button halfway to lock the focus.

5 Press the shutter button all the way to shoot.

- Shooting will stop when the shutter button is released.
- The shooting speed is as follows.*
When is selected: Approx. 1.5 frames per second
When is selected: Approx. 2.0 frames per second

* Large/Fine, LCD monitor off mode. (These figures reflect Canon's testing standard. The actual figures will vary according to the shooting conditions and settings.)



- Some settings are not available with certain Shooting modes. Please refer to *Functions Available in Each Shooting Mode* (p. 180)
- The interval between frames may lengthen somewhat when the internal memory becomes full.
- The flash can be used, but the interval between images will lengthen to accommodate the flash recharge time.

Shooting - Selecting Particular Effects

Camera settings such as shutter speed and aperture can be freely changed for shooting.

See *Functions Available in Each Shooting Mode* (p. 180) at the end of this manual to find out which settings can be changed in which Shooting modes.



Please see **AUTO** Mode (p. 45) for shooting procedures once you have changed a setting.

P Program AE

Use the program AE mode to have the camera automatically set the shutter speed and aperture value to match the brightness of the scene.

1

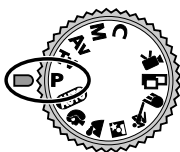

Turn the shooting mode dial to **P**.

2

Shoot the image.

- The shutter speed and aperture value will be set automatically. They appear on the LCD monitor if it is on.
- The correct exposure has been set if the shutter speed and aperture value show in white.



P Program AE (continued)



- *Functions Available in Each Shooting Mode* (p. 180)
- If a correct exposure cannot be obtained, the shutter speed and aperture value show in red on the LCD monitor. Use the following methods to obtain the correct exposure and make them show in white.
 - Use the flash.
 - Change the ISO speed setting.
 - Change the light metering mode.

Differences and Similarities between the P and **AUTO** Modes.

- Both modes automatically select the shutter speed and aperture value.
- The following settings can be adjusted in **P** mode, but not in **AUTO** mode.
 - Exposure Compensation
 - ISO Speed
 - Flash Exposure Compensation
 - Flash (Flash on, Slow Synchro, 2nd-curtain flash)
 - Continuous Shooting
 - Light Metering Mode
 - AF frame (manual selection)
 - FE Lock
 - White Balance
 - Bracket
 - Photo Effects
 - File Format Settings
 - Manual Focus
 - AE Lock
- For the correlation between aperture value and shutter speed, see page 70.

Tv Setting the Shutter Speed

When you set the shutter speed in the shutter speed-priority AE mode, the camera automatically selects an aperture value to match the brightness. Faster shutter speeds allow you to catch an instantaneous image of a moving subject while slower speeds create a flowing effect and allow you to shoot without a flash in dark areas.

1

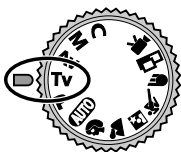

Turn the shooting mode dial to Tv.

The shutter speed appears on the LCD monitor if it is on.

2

Select a speed using ◀ or ▶ on the multicontroller.



3

Shoot the image.

The correct exposure has been set if the shutter speed and aperture value show in white.



- If the aperture value shows in red, the image is under exposed (insufficient light) or overexposed (too much light). Adjust the shutter speed using ◀ or ▶ on the multicontroller until the aperture value display turns to white.
- The nature of CCD image sensors is such that noise in the recorded image increases at slow shutter speeds. This camera, however, applies special processing to images shot at shutter speeds slower than 1.3 seconds to eliminate the noise, thereby producing high-quality images. Nevertheless, a certain amount of processing time may be required before the next image can be shot.

Tv Setting the Shutter Speed (continued)



- *Functions Available in Each Shooting Mode* (p. 180)
- Please note that camera shake becomes a factor at low shutter speeds. If the camera shake warning  appears in the center of the LCD monitor, secure the camera to a tripod before shooting.
- The aperture value and shutter speed change according to the zoom state as follows.

	Aperture	Shutter Speed (seconds)
Wide Angle	F 2.8 - 3.5	to 1/1000
	F 4.0 - 8.0	to 1/1500
Telephoto	F 4.9 - 6.3	to 1/1000
	F 7.1 - 8.0	to 1/1500

- The fastest shutter speed for flash synchronization is 1/250 second. The camera automatically resets the shutter speed to 1/250 second if a faster speed is selected (p. 55).

Shutter Speed Display

The numbers in the table below indicate the shutter speed in seconds. For slower speeds, quote marks indicate the decimal place, so that 0"3 indicates 0.3 second and 2" indicates 2 seconds.

1/1500	1/1250	1/1000	1/800	1/640	1/500	1/400	1/320				
1/250	1/200	1/160	1/125	1/100	1/80	1/60	1/50	1/40			
1/30	1/25	1/20	1/15	1/13	1/10	1/8	1/6	1/5	1/4		
0"3	0"4	0"5	0"6	0"8	1"	1"3	1"6	2"	2"5	3"2	4"
5"	6"	8"	10"	13"	15"						

Av Setting the Aperture

When you set the aperture in the aperture-priority AE mode, the camera automatically selects a shutter speed to match the brightness. Selecting a lower aperture value (opening the aperture) allows you to fade the background and create a beautiful portrait. A higher aperture value (closing it) brings the entire range from foreground to background into focus. The larger the aperture value, the greater the range of the image brought into clear focus.

1

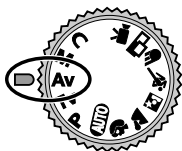

Turn the shooting mode dial to **Av**.

The aperture value appears on the LCD monitor if it is on.

2

Select a value using ◀ or ▶ on the multicontroller.



3

Shoot the image.

The correct exposure has been set if the shutter speed and aperture value show in white.



Av Setting the Aperture (continued)



- If the shutter speed shows in red on the LCD monitor, the image is under exposed (insufficient light) or overexposed (too much light). Adjust the aperture value using ◀ or ▶ on the multicontroller until the shutter speed display turns white.
- Some aperture values may not be available with certain zoom positions.



- *Functions Available in Each Shooting Mode* (p. 180)
- Please note that camera shake becomes a factor at low shutter speeds. If the camera shake warning  appears in the LCD monitor, secure the camera to a tripod before shooting.
- In this mode, the shutter speed with synchronized flash is 1/60 second to 1/250 second. The aperture value setting may therefore be changed automatically to match the synchronized flash speed even if its value was set previously.

Aperture Value Display

The larger the aperture value, the smaller the lens aperture.

F2.8	F3.2	F3.5	F4.0	F4.5	F5.0	F5.6	F6.3	F7.1	F8.0
------	------	------	------	------	------	------	------	------	------

- For the correlation between aperture value and shutter speed, see page 70.

M Manually Setting the Shutter Speed and Aperture

You can manually set the shutter speed and aperture to achieve a particular effect. This is convenient for shooting fireworks and other images where it is difficult to set the correct exposure automatically.

1

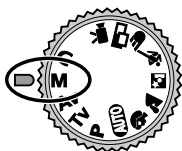

Turn the shooting mode dial to **M**.

The shutter speed and aperture value appears on the LCD monitor if it is on.

2

Select a shutter speed using ◀ or ▶ on the multicontroller.

3

Select an aperture value using ▲ or ▼ on the multicontroller.



4

Shoot the image.

When you press the shutter button halfway, a number indicating the difference between the standard exposure* and the selected exposure appears on the LCD monitor. If the difference is more than ± 2 steps, “-2” or “+2” appears in red.

* The standard exposure is calculated by the AE function according to the selected metering mode.



- *Functions Available in Each Shooting Mode* (p. 180)
- If you wish to change the exposure, adjust the shutter speed using ◀ or ▶ on the multicontroller, or adjust the aperture using ▲ or ▼ on the multicontroller.
- The LCD monitor's brightness matches the selected shutter speed and aperture value. When you select a fast shutter speed or shoot a subject in a dark place and set the flash to ⚡👁 (Red-Eye Reduction, Flash On) or ⚡ (Flash On) the LCD monitor will always light up.
- For the correlation between aperture value and shutter speed, see page 70.



Selecting an AF Frame

The AF frame indicates the area of the composition on which the camera focuses. You can set the AF frame in the following way.

When the Shooting Mode dial is set to **AUTO, **P**, **M**, **S**, **L** or **F****

You can set the AF frame to Auto Selection (AiAF) or to center-point. When Auto Selection (AiAF) is selected, the camera automatically selects an AF frame from 9 points to focus according to the shooting conditions. With the digital zoom, the center-point AF-frame is always selected.

1 Press .

The AF frame appears in green on the LCD monitor.

2 Select the auto selection or center-point AF frame using **▲▼◀** or **▶** on the multicontroller.



e.g. Auto Selection



e.g. Center-point

3 Press .

You can immediately shoot the image using the selected AF frame by pressing the shutter button instead of pressing .

4 Shoot the image.

When the Shooting Mode dial is set to P, Tv, Av or M

You can set the focusing frame manually to the desired position (Manual Selection). This is convenient for focusing accurately on your chosen subject to obtain the composition you desire. The AF frame is fixed to center-point when an image is shot using the viewfinder with the LCD monitor off or when using the digital zoom, even if you previously set the AF frame to the position you desire.

-
- 1** Press .
The AF frame appears in green on the LCD monitor.

-
- 2** Move the focusing frame to the position you wish to set using ▲▼◀ or ▶ on the multicontroller.



-
- 3** Press .
You can immediately shoot the image using the selected AF frame by pressing the shutter button instead of pressing .

-
- 4** Shoot the image.

☰ Selecting an AF Frame (continued)



- Some settings are not available with certain Shooting modes. Please refer to *Functions Available in Each Shooting Mode* (p. 180)
- Turn the LCD monitor on to set the AF frame to the position you desire before shooting.
- The AF frame is locked to center-point when using the digital zoom.
- When the Spot AE Point is selected as the light metering mode, you can use the selected AF frame as the Spot AE Point (p. 77).
- When the AF frame is set to manual selection, it will move to the center if you continuously press ☰.
- For an explanation of the AF frame colors, please refer to page 33.
- If the Shooting mode is changed, the AF frame may also change depending on the Shooting mode. See the table below.

Initial Shooting Mode	Next Shooting Mode	AF frames after change
		Auto Selection
P Tv Av M	P Tv Av M	No change
P Tv Av M		Auto Selection
	P Tv Av M	Center-Point

If you switch to **C** mode, the AF frame will change to the setting previously saved with the [Save Settings] function. When switching to any other Shooting mode, the AF frame settings will change to the settings of the mode you switched to.

Regarding the AF Frame

AiAF* has a wide range of measuring for accurate focusing. AiAF focuses on the object even if it is not exactly in the center of the frame.

* "Ai" stands for "Artificial intelligence" and "AF" stands for "Auto Focus."



Switching between Light Metering Modes

Evaluative metering is the default light metering mode. This can be switched to another metering mode.

	Evaluative Light Metering	Appropriate for standard shooting conditions, including backlight scenes. The camera divides images into several zones for light metering. The camera evaluates the complex lighting conditions, such as the position of the subject, the brightness, the background, the direct light, and the backlighting, and adjusts the settings to the correct exposure for the main subject.
	Center-Weighted Averaging	Averages the exposure from the entire image, but places more weight on the subject at the center. Use this mode when the subject is backlit or surrounded by bright light.
	Center	Meters the area within the spot AE point frame at the center of the LCD monitor.
	AF Point	Meters the spot AF point corresponding to the selected AF frame.

1 Press the **DISPLAY** button to turn on the LCD monitor.

2 Press the button to select the metering mode.

- Each press of the button changes the metering mode as follows.

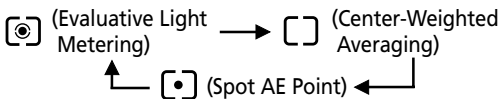

- The icon of the currently selected light metering mode appears on the LCD monitor.

If you have selected (Spot AE Point), go to step 3.

If you have selected (Evaluative Light Metering) or (Center-Weighted Averaging), go to step 5.

Switching between Light Metering Modes (continued)

3 In the [ (Rec.)] menu, select [Spot AE Point].

See *Selecting Menus and Settings* (p. 36).

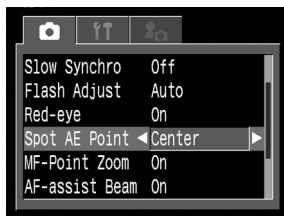

4 Select the [Center] or [AF Point] option, then press the **MENU** button.

When [Spot AE Point] is set to [Center], the spot AE point frame appears at the center of the LCD monitor, and when [Spot AE Point] is set to [AF Point], it appears inside the selected AF frame.

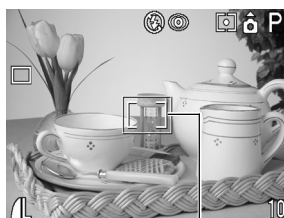

e.g. Center

Spot AE Point Frame

5 Shoot the image.

.....



Some settings are not available with certain Shooting modes. Please refer to *Functions Available in Each Shooting Mode* (p. 180)



Adjusting the Exposure

Adjust the exposure compensation setting to avoid making the subject too dark when it is backlit or shot against a bright background.

1 Press the  / **WB / FUNC.** button.

2 Select * (+/- (Exp.)) using **▲** or **▼** on the multicontroller.
* The current setting is displayed.

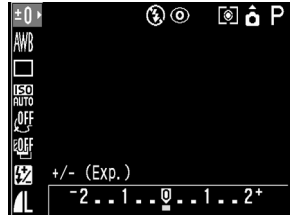

3 Select a setting using **◀** or **▶** on the multicontroller.

- The settings can be adjusted in 1/3 steps in the range of -2EV to +2EV.
- You can shoot the image right after selecting settings by pressing the shutter button. This screen will appear again, once the image is shot.

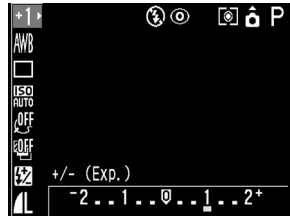

4 Press the  / **WB / FUNC.** button.

To cancel the exposure compensation, return the setting to  using **◀** or **▶** on the multicontroller.









5 Shoot the image.





Some settings are not available with certain Shooting modes. Please refer to *Functions Available in Each Shooting Mode* (p. 180)

WB Setting the White Balance



When the white balance mode is set to match the light source, the camera reproduces colors more accurately.

AWB	Auto	Settings are automatically set by the camera
	Daylight	For recording outdoors on a bright day
	Cloudy	For recording under overcast, shady or twilight skies
	Tungsten	For recording under tungsten and bulb-type 3-wavelength fluorescent lighting
	Fluorescent	For recording under warm-white, cool-white or warm-white (3-wavelength) fluorescent lighting
	Fluorescent H	For recording under daylight fluorescent, or daylight fluorescent-type 3-wavelength fluorescent lighting
	Flash	For flash photography
	Custom1	For setting a custom value with a white sheet of paper, etc., to obtain the optimal white balance for the conditions. There are two custom values: custom1 and custom2.
	Custom2	

1 Press the  / **WB / FUNC.** button.

2 Select **AWB*** (Auto) using  or  on the multicontroller.

* The current setting is displayed.

3 Select the desired setting using  or  on the multicontroller.



- Please see the next page regarding the  custom setting.
- You can shoot the image right after selecting settings by pressing the shutter button. This screen will appear again, once the image is shot.



4 Press the  / **WB / FUNC.** button.

5 Shoot the image.

.....

 The white balance cannot be adjusted when the photo effect is set to  (Sepia) or  (B/W).

📷 Setting a Custom White Balance

You can set a custom white balance to obtain the optimal setting for the shooting conditions by having the camera evaluate a subject such as a white piece of paper or cloth, or a photo-quality gray card. You can set two types of settings.

1 Press the **WB / FUNC.** button.

2 Select **AWB*** (Auto) using **▲** or **▼** on the multicontroller.

* The current setting is displayed.



3 Select **Custom1** or **Custom2** using **◀** or **▶** on the multicontroller.

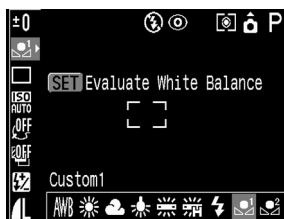

4 Aim the camera at the white paper or cloth, or gray card and press **SET**.

- Aim the camera so that the white paper or cloth, or gray card, completely fills the frame on the LCD monitor screen or the entire viewfinder before pressing **SET**. When you press **SET**, the camera reads the white balance data.
- You can shoot the image right after selecting settings by pressing the shutter button. This screen will appear again, once the image is shot.

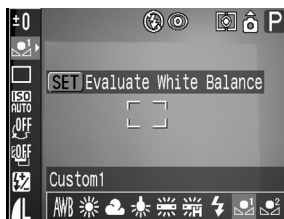





5 Press the **WB / FUNC.** button.

6 Shoot the image.

WB Setting the White Balance (continued)



- Some settings are not available with certain Shooting modes. Please refer to *Functions Available in Each Shooting Mode* (p. 180)
- To set and use a custom white balance setting, it is advisable to select the **P** Shooting mode and set the exposure compensation and flash exposure compensation to zero (± 0). The correct white balance may not be obtained when the exposure is incorrect (image is completely black or white).
- It is also advisable to use the LCD monitor to compose the shot and to further zoom in.
- Since the white balance data cannot be read in  mode, preset the white balance in another Shooting mode first before selecting  mode.
- Set the flash on or off when setting a custom white balance. The white balance may not be accurate if the setting conditions and shooting conditions are not the same. If the flash fires when setting a custom white balance with the flash set to  or , ensure that you also use the flash when you go to shoot.



Changing the Photo Effect

You can shoot with different photo effects.

	Photo Effect Off	Records with no effect.
	Vivid	Emphasizes the contrast and color saturation to record in bold color.
	Neutral	Tones down the contrast and color saturation to record neutral hues.
	Low Sharpening	Records subjects with softened outlines.
	Sepia	Records in sepia tones.
	B/W	Records in black and white.
	Custom Effect	You can freely set the contrast, sharpness and color saturation.

1 Press the / **WB / FUNC.** button.

2 Select * (Effect Off) using **▲** or **▼** on the multicontroller.

* The current setting is displayed.



3 Select the desired setting using **◀** or **▶** on the multicontroller.

When is selected

A screen allowing you to set the contrast, sharpness and color saturation appears when you press **SET**.

In this screen, select the item you wish to set using the **▲▼** buttons and set it using the **◀▶** buttons.



Changing the Photo Effect (continued)

Contrast

- Select from - (Weak), 0 (Neutral) and + (Strong).
- This function allows you to adjust the degree of brightness.



Sharpness

- Select from - (Weak), 0 (Neutral) and + (Strong).
- This function allows you to adjust how sharply outlines are defined.

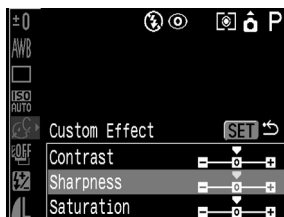

Saturation

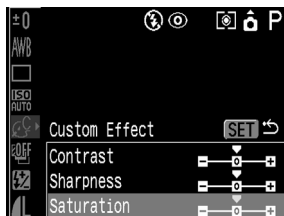

- Select from - (Weak), 0 (Neutral) and + (Strong).
- This function allows you to adjust the color depth.



- You can shoot the image right after selecting settings by pressing the shutter button. This screen will appear again, once the image is shot.

4 Press the  / **WB / FUNC.** button.

5 Shoot the image.

.....
 The white balance cannot be set when  (sepia) or  (B&W) mode is selected.

.....
 Some settings are not available with certain Shooting modes. Please refer to *Functions Available in Each Shooting Mode* (p. 180)

ISO Changing the ISO Speed

Raise the ISO speed when shooting in dark places or when you want to shoot with a faster shutter speed. You can choose from the following speeds: Auto, 50, 100, 200 and 400.

1 Press the  / **WB / FUNC.** button.

2 Select * (ISO Speed) using **▲** or **▼** on the multicontroller.

* The current setting is displayed.

3 Select the desired setting using **◀** or **▶** on the multicontroller.

You can shoot the image right after selecting settings by pressing the shutter button. This screen will appear again, once the image is shot.

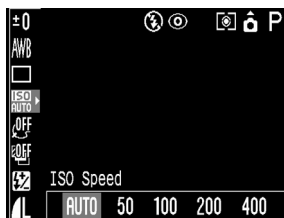

4 Press the  / **WB / FUNC.** button.

5 Shoot the image.



- Higher ISO speeds increase the image noise. To take clean images, use as low an ISO speed as possible.
- Although the AUTO setting selects the optimal speed, it will automatically raise the speed when the shooting conditions limits are reached. It will also raise the speed when the light from the flash is insufficient to illuminate the subject matter.



Some settings are not available with certain Shooting modes. Please refer to *Functions Available in Each Shooting Mode* (p. 180)



Auto Exposure Bracketing (AEB Mode)



In this mode, the camera automatically changes the exposure within a set range to take three shots after you press the shutter button once. You can adjust AEB settings in 1/3EV steps within the range of -2EV to +2EV of the standard exposure setting. AEB settings can be combined with exposure compensation settings (p. 79) to extend the adjustment range. The images are shot in the following order: Standard exposure, underexposure and overexposure.

1 Press the  / **WB / FUNC.** button.

2 Select * (BKT-Off) using **▲** or **▼** on the multicontroller.

* The current setting is displayed.



3 Select  (AEB ) using **◀** or **▶** on the multicontroller and press **SET**.



4 Expand or contract the range using **◀** or **▶** on the multicontroller.

- Use **▶** to expand the range and **◀** to contract it.
- You can shoot the image right after selecting settings by pressing the shutter button. This screen will appear again, once the image is shot.



5 Press the  / **WB / FUNC.** button.

Select  (BKT-Off) in Step 3 to cancel the AEB mode.

6 Shoot the image.



The AEB mode cannot be used for flash photography. If the flash fires, only one image gets recorded.



Some settings are not available with certain Shooting modes. Please refer to *Functions Available in Each Shooting Mode* (p. 180)

Focus Bracketing (Focus-BKT Mode)

You can shoot three images while the focus changes automatically when shooting with the manual focus. Three ranges -small, medium or large- can be selected. Images are shot with the focus position changing in the following order: current position, backwards and forward.

1 Press the  / **WB / FUNC.** button.

2 Select * (BKT-Off) using **▲** or **▼** on the multicontroller.

* The current setting is displayed.



3 Select  (Focus-BKT) using **◀** or **▶** on the multicontroller and press **SET**.



4 Select a range using **◀** or **▶** on the multicontroller.

You can shoot the image right after selecting settings by pressing the shutter button. This screen will appear again, once the image is shot.



5 Press the  / **WB / FUNC.** button.
The selected setting is saved.

6 Shoot the image in manual focus (p. 100).



The Focus-BKT mode is not available when shooting with the flash on. The camera will revert to shooting only one image when the flash is on.



Some settings are not available with certain Shooting modes. Please refer to *Functions Available in Each Shooting Mode* (p. 180)





Locking the Exposure Setting (AE Lock)

You can set the exposure and focus separately. This is effective when the contrast is too strong between the subject and background or when a subject is backlit.

1 Press the **DISPLAY** button to turn on the LCD monitor.

2 Focus the AF frame or the spot metering frame on the subject on which you wish to lock the exposure setting and press the shutter button halfway.

- *Selecting an AF frame* (p. 74)
- *Switching Between Light Metering Modes* (p. 77)

3 While pressing the shutter button halfway, press the  button.

- The exposure setting locks (AE Lock) and the * icon appears on the LCD monitor.
- Using any button, lever or switch other than ◀, ▶, ▲ or ▼ on the multicontroller cancels the AE lock.



AE Lock Icon

4 Recompose the image and shoot.





The AE lock function cannot be used when the LCD monitor is off.



- Some settings are not available with certain Shooting modes. Please refer to *Functions Available in Each Shooting Mode* (p. 180).
- The automatically selected combinations of shutter speeds and aperture values can be freely changed without altering the exposure with the following procedures.
 - 1 Turn the mode dial to **P**, **Tv** or **Av**.
 - 2 Press the **DISPLAY** button to turn on the LCD monitor.
 - 3 Focus on the subject on which you wish to lock the exposure.
Press the shutter button halfway.
 - 4 Press the  button.
The exposure setting will lock and the ***** icon will appear in the display panel and LCD monitor.
 - 5 Press **◀** or **▶** on the multicontroller until the desired shutter speed or aperture value is reached.
 - 6 Recompose the image and shoot.
The setting will cancel after the shot is taken.



Locking the Flash Exposure Setting (FE Lock)

You can obtain the correct exposure regardless of the location of your subject in the composition.

- 1 Press the **DISPLAY** button to turn on the LCD monitor.
- 2 Press the **⚡** (Flash) button and set the flash to fire (p. 54).
- 3 Focus the AF frame or the spot metering frame on the subject on which you wish to lock the flash exposure setting and press the shutter button halfway.
- 4 While pressing the shutter button halfway, press the **📷** button.
 - The flash exposure compensation setting locks (FE lock) and the **✖** icon appears on the LCD monitor.
 - The flash will fire a pre-flash and lock the flash exposure to the required intensity to illuminate the subject. (Each time you press the **📷** button, the flash exposure locks at the required intensity for that composition).
 - Using any button, lever or switch other than **◀**, **▶**, **▲** or **▼** on the multicontroller cancels the FE lock.
- 5 Recompose the image and shoot.



- Some settings are not available with certain Shooting modes. Please refer to *Functions Available in Each Shooting Mode* (p. 180).
- The FE lock function is not available when [Flash Adjust] is set to [Manual].

Switching between the Built-in Flash Adjustment Settings

The flash fires with automatic flash adjustments (except in the **M** mode), but it is possible to set it so that it fires without any adjustments.

- 1 Select [Flash Adjust] from the [ (Rec.)] menu.
See *Selecting Menus and Settings* (p. 36).

- 2 Select [Auto] or [Manual] and press the **MENU** button.

Compensating the Flash Adjustment (+/- (Flash))

The flash adjustment can be changed when [Flash Adjust] is set to [Auto]. The settings can be adjusted in 1/3-stop increments in the range of -2EV to +2EV. You can enjoy flash photography with exposure adjustments with the combined use of the camera's exposure compensation function.

- 1 Press the  / **WB / FUNC.** button.

- 2 Select  (+/- (Flash)) using **▲** or **▼** on the multicontroller.

- 3 Adjust the compensation using **◀** or **▶** on the multicontroller.

You can shoot the image right after selecting settings by pressing the shutter button. This screen will appear again, once the image is shot.



e.g. Flash Adjustment Settings

- 4 Press the  / **WB / FUNC.** button.

- 5 Shoot the image.

Compensating the Flash Output.

In **M** mode or when [Flash Adjust] is set to [Manual], the flash output can be controlled in three steps, starting from FULL, when shooting. This setting is also active with slave flash photography where multiple flashes are fired at the subject from different positions because the pre-flash does not fire.

1 Press the  / **WB / FUNC.** button.

2 Select  (Flash Output) using **▲** or **▼** on the multicontroller.

3 Adjust the compensation using **◀** or **▶** on the multicontroller.

You can shoot the image right after selecting settings by pressing the shutter button. This screen will appear again, once the image is shot.

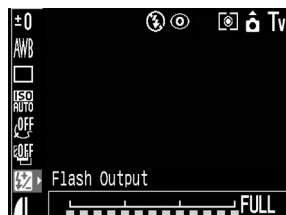

e.g. Flash Output

4 Press the  / **WB / FUNC.** button.

5 Shoot the image.

.....



Some settings are not available with certain Shooting modes. Please refer to *Functions Available in Each Shooting Mode* (p. 180).

Switching the Timing at which the Flash Fires

1st-curtain	The flash fires right after the shutter opens, regardless of the shutter speed. Usually, the 1st-curtain is used when shooting.
2nd-curtain	The flash fires right before the shutter closes, regardless of the shutter speed. Compared with the 1st-curtain, the flash fires later and this allows you to shoot images in which, for example, a car's rear lamps seem to trail off behind.



Image shot with the 1st-curtain setting



Image shot with the 2nd-curtain setting.

- 1 From the [] (Rec.) menu, select [1st-curtain] or [2nd-curtain] in [Flash Sync].



Some settings are not available with certain Shooting modes. Please refer to *Functions Available in Each Shooting Mode* (p. 180).

Shooting Images at Set Intervals (Intervalometer)

You can shoot images at a set interval. This function can be used for fixed-point observation of plants and blooming flowers. The shooting interval time can be set from 1 to 60 minutes and 2 to 100 images can be shot.



Since the camera may shoot continuously for an extended period of time, the use of the AC Adapter Kit ACK700 (optional) is recommended (p. 162).

1 Select [Intervalometer] from the [📷 (Rec.)] menu.

See *Selecting Menus and Settings* (p. 36).

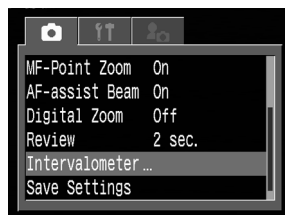

2 Select an interval time using ◀ or ▶ on the multicontroller.

If you press the multicontroller continuously, the interval time increases by units of 5 minutes at a time.

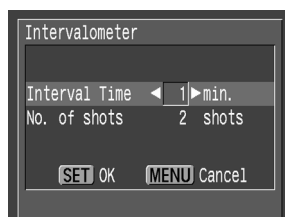

3 Press ▼ on the multicontroller.

4 Select the number of shots using ◀ or ▶ on the multicontroller.

- If you press the multicontroller continuously, the number of shots increase by units of 5 shots at a time.
- The maximum number of shots is determined according to the CF card's remaining capacity.

5 Press **SET**.

The camera exits the menu screen and **Int.** appears at the lower right of the LCD monitor.

6 Press the shutter button.

- The first image is shot and the interval shooting session starts.
- Once the set number of shots is taken the camera automatically powers down regardless of the power-saving function settings.
- If the below operations are accessed while the interval shooting is in process, the interval shooting session will be cancelled.
 - Turning the mode dial while the camera is waiting to shoot the next image
 - Pressing the shutter button halfway while the camera is waiting to shoot the next image
 - Opening the CF card slot/battery cover
 - Switching to Replay mode
 - Turning off the power



- Once the interval shooting session is started, all operation buttons become inactive. Turning the shooting mode dial cancels the interval shooting session.
- The lens stays extended until the next image is shot.
- Images are not displayed on the LCD monitor right after being shot.
- Interval shooting is not available when the date and time are not set.
- Continuous Shooting (normal, high-speed) and Self-timer are not available.
- AEB mode and the Focus-BKT mode settings cannot be set.



Some settings are not available with certain Shooting modes. Please refer to *Functions Available in Each Shooting Mode* (p. 180).

Shooting Problem Subjects for the Autofocus

The autofocus may not work well on the following types of subjects.

- Subjects with extremely low contrast to the surroundings
- Subjects mixing close and far objects
- Subjects with extremely bright objects at the center of the composition
- Subjects that are moving quickly

To shoot these subjects, first aim the camera at an object at a similar distance, lock the focus and recompose the image with the desired subject, or use the manual focus.

Shooting with Focus Lock

Focus Lock Method 1

- 1** Press the **DISPLAY** button to turn on the LCD monitor.
- 2** Aim the AF frame at an object at a similar distance to the subject you wish to shoot.
- 3** Press the shutter button halfway to lock the focus.
The AE setting will also lock when you do this. The exposure may occasionally be incorrect if the difference between the two items is too great. Use Method 2 or the AE lock procedure when this happens.
- 4** Keep it pressed while you recompose the image and press the shutter button all the way to shoot the image.

Focus Lock Method 2

1 Press the **DISPLAY** button to turn on the LCD monitor.

2 Press the shutter button halfway to lock the focus. Keep it pressed and press the **MF** button.

- The **MF** icon appears on the LCD monitor.
 - The focus setting will lock even if the shutter button and the **MF** button are released.
 - The manual focus setting will cancel if the **MF** button is pressed again.
-

3 Recompose the image and press the shutter button all the way to shoot the image.

.....
 Focus lock cannot be used while the Shooting mode is set to **AUTO**.

.....

- Some settings are not available with certain Shooting modes. Please refer to *Functions Available in Each Shooting Mode* (p. 180).
- Method 2 is convenient because you can let go of the shutter button to recompose the image.
- When shooting through glass, get as close as possible to avoid reflection off the glass.

Shooting Problem Subjects for the Autofocus (continued)

Shooting in Manual Focus Mode

The focus can be manually set.

1 Press the **DISPLAY** button to turn on the LCD monitor.

2 Press and hold the **MF** button, then use **▲** or **▼** on the multicontroller.

- The focus will lock and the **MF** icon and the MF indicator will appear on the LCD monitor.
- When the [] (Rec.) menu's [MF-Point Zoom] is set to [On], if a particular AF frame has been manually selected, the portion of the image in that frame will appear magnified.*

* Except in the [] modes, when the digital zoom is activated or a TV is used as the display.

* Can also be set so that the image displayed is not magnified.

- The center of the LCD monitor is magnified when the AF frame is set to Auto Selection.
- The MF indicator shows approximate figures. Use them as a shooting guideline only.
- Adjust the focus using **▲** or **▼** on the multicontroller until the image appears focused on the LCD monitor.
- Pressing the **MF** button a second time cancels the manual focus mode.



MF indicator

3 Shoot the image.

The indicator beside the viewfinder lights yellow when the shutter button is pressed halfway.

Using the Manual Focus in Combination with the Auto Focus

The camera automatically searches for a more suitable focusing point from the current manually focused location.

1 Focus the camera with the manual focus.

2 Press **SET**.

The camera focuses automatically to a more accurate focusing point near the current focusing point.



You cannot change the AF frame setting while focusing manually. Cancel the manual focus mode, then change the AF frame setting. With the changed AF frame setting, you can resume the manual focus mode.



- Some settings are not available with certain Shooting modes. Please refer to *Functions Available in Each Shooting Mode* (p. 180).
- You can use manual focus in the macro focal distance 10 to 50 cm (3.9 in. to 1.6 ft.) at wide angle end and 30 to 50 cm (11.8 in. to 1.6 ft.) at telephoto end. In this case, the fine scale is adopted.
- You can change the MF indicator displayed distance units (p. 153).

C Saving Custom Settings

You can save frequently used Shooting modes and various shooting settings to the **C** (custom) mode. When necessary, you can then shoot images with previously saved settings by simply turning the shooting mode dial to **C**. Settings that are usually forgotten when the Shooting mode is changed or when the power is turned off (such as macro mode or drive mode) are also remembered.

Settings that can be saved to the C mode

- Shooting mode (**P**, **Tv**, **Av**, **M**)
- **P**, **Tv**, **Av** and **M** mode items that can be saved (p. 180)
- Shooting menu settings
- Zoom location • Manual Focus location

1 Turn the shooting mode dial to **P**, **Tv**, **Av**, **M** or **C**.

2 Set the setting contents you wish to save.

3 Select [Save settings] from the [RECORD] (Rec.) menu.

See *Selecting Menus and Settings* (p. 36).

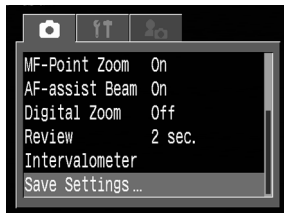

4 Select [OK] and press **SET**.



5 Press the **MENU** button.



- When you wish to re-save partially modified settings (except Shooting mode) that were previously saved in the **C** mode, select **C** in Step 1.
- The setting contents do not influence other Shooting modes.
- Saved settings can be reset (p. 157).

Setting the Auto Rotate Function

This camera is equipped with an Intelligent Orientation sensor that detects the orientation of an image shot with the camera on end and automatically rotates it to the correct viewing orientation in the display. You can set this function on/off.

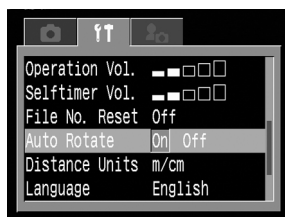

1 Select [Auto Rotate] in the [M] (Set up) menu.

See *Selecting Menus and Settings* (p. 36).



2 Select [On] and press the MENU button.

When this function is on, an icon showing the orientation of the camera appears at the upper right corner of the LCD monitor display (when information display is on).

	Normal
	Camera on right end
	Camera on left end



- This function may not operate correctly when the camera is pointed straight up or down. Check that the arrow is pointed in the right direction and if it is not, then set the Auto Rotate function to Off.
- Even if the Auto Rotate function is set to on, the orientation of images downloaded to a computer will depend upon software used to download the images.



- When the camera is held on end to shoot, the Intelligent Orientation sensor judges the upper end to be “up” and the lower end to be “down”. It then regulates the optimal white balance, exposure and focus for vertical photography. This function operates regardless of the On/Off status of the Auto Rotate function.
- When changing the camera's orientation between the horizontal and vertical positions, you may hear noise coming from the orientation detection mechanism. This is not a malfunction.

Resetting the File Numbers

You can select the way file numbers are assigned.

On	The file numbers are reset to the start (100-0001) each time a new CF card is inserted. New images recorded on CF cards with existing files are assigned the next available number.
Off	The file number of the last image to be shot is memorized so that images recorded to a new CF card start from the next number.

1 In the **[M] (Set up)** menu, select **[File No. Reset]**.

See *Selecting Menus and Settings* (p. 36).

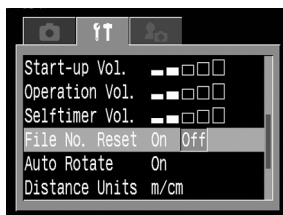

2 Select **[On]** or **[Off]** and press the **MENU** button.

.....



- Setting the **[File No. Reset]** to **[Off]** is useful for avoiding file name duplication when images are downloaded to a computer.

About File and Folder Numbers

- Images are assigned file numbers from 0001 to 9900, and folders are assigned folder numbers from 100 to 998 (Folder numbers cannot contain 99 in the last two digits).

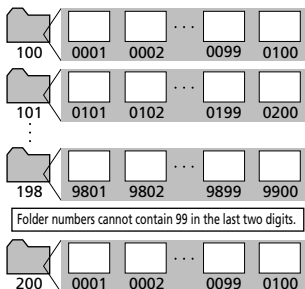

Folder File Capacity

- Each folder usually contains up to 100 images. However, since images shot in Continuous mode or Stitch Assist mode are always saved into the same folder, a folder may contain more than 100 images. The number of images may also exceed 100 if a folder contains images copied from a computer or images shot with other cameras. Please note, however, that the images in folders containing 2001 or more images cannot be replayed in this camera.

Displaying Images Individually

You can view the recorded images on the LCD monitor.

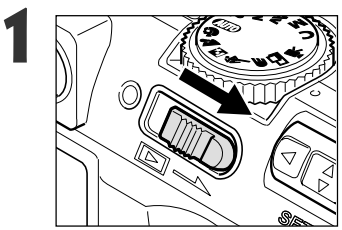

1 Slide the power/replay lever to the right.

The last recorded image appears (single image replay).

2 Move between images using ◀ or ▶ on the multicontroller.

- Use ◀ to move to the previous image and ▶ to move to the next. Holding ◀ or ▶ moves more rapidly between images, but the images will not appear as clearly.
- When you press ◀ or ▶ on the multicontroller after having pressed the **JUMP** button, the camera jumps 10 images behind or ahead. If you press the **JUMP** button once more, the camera returns to the single image replay screen.



Replaying, Erasing



- Press the **DISPLAY** button to show the data for the displayed image (p. 28).
- Press the  button to quickly delete the displayed image (p. 119).

Magnifying Images

Images can be magnified up to approximately 10 times.

1 Slide the power/replay lever to the right.

2 Slide the zoom lever toward .



Magnified approximately 5 times
Approximate position





Magnified approximately 10 times
Approximate position

- You can move around the magnified image using ◀, ▶, ▲ or ▼ on the multicontroller.
- Hold the **SET** button down and slide the zoom lever toward  to cycle through each setting, approximately 2.5 times, to approximately 5 times and 10 times.

Canceling the Magnified Display

1 Slide the zoom lever toward .

When you press the  button, the image switches to its original size.

.....
 Movie frames and index replayed images cannot be magnified.

.....
 You can magnify an image while it is displayed on the LCD monitor in Shooting mode immediately after the image is shot (p. 47).

Viewing Images in Sets of Nine (Index Replay)

Up to nine images can be viewed at once in index replay.

1 Slide the power/replay lever to the right.

2 Press the  button.

- Nine images appear at once (index replay).
- The same display appears even if you slide the zoom lever once towards .

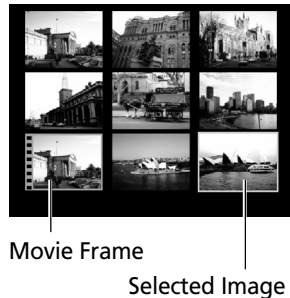

3 Change the image selection using , ,  or  on the multicontroller.



← The  operation in this row displays the previous set of nine images.

← The  operation in this row displays the next set of nine images.

4 Press the  button.

- Index replay cancels and the display reverts to single image replay.
- The same display appears even if you slide the zoom lever once towards .



Press the **DISPLAY** button to show the data for the displayed image (p. 28).

JUMP Jumping Between Images

The display can be advanced or set back 9 images in either single image replay or index replay.

1 Press the **JUMP** button while in single replay (p. 105) or index replay (p. 107).

The jump bar appears.

2 The displayed image(s) change.

Single Replay

- Jump 10 images behind or ahead using ◀ or ▶ on the multicontroller.



Jump Bar

Index Replay

- Jump to the previous or next set of nine images using ◀ or ▶ on the multicontroller.



Jump Bar



3 Press the **JUMP** button.

The jump bar disappears and the jump mode cancels.





Viewing Movies

You can replay the images shot in  mode.

- 1** Slide the power/replay lever to the right.
Movies cannot be viewed in index replay.

- 2** Select a movie using  or  on the multicontroller and press **SET**.
 - A movie displays with the instruction  on it.
 - The movie replay panel appears.



- 3** Select  using  or  on the multicontroller and press **SET**.
 - The movie images and sound will play.
 - You can adjust the volume using  or  on the multicontroller.
 - When a movie has finished playing, it will display the last frame. If **SET** is pressed in this state, the camera will revert to the movie replay panel. If **SET** is pressed again, the movie will start playing from the first frame.









sound volume

Pausing and Resuming Play

Press **SET** to pause the movie. Press it again to resume.

Fast Forwarding / Rewinding

Select one of the following operations using  or  on the multicontroller and press **SET**.

-  : Return to Single Image View
-  : First Frame
-  : Previous Frame (Rewinds if **SET** is held down)
-  : Next Frame (Fast forwards if **SET** is held down)
-  : Last Frame



You may experience frame dropping and audio breakup when replaying a movie on a computer with insufficient system resources.



- The volume at which movies replay can also be adjusted in the Replay menu (p. 152).
- Please adjust the audio sound level on the TV when viewing movie files on a TV.

Editing Movies

You can delete unwanted portions from the first or second half of a movie clips.

1 Select the movie you wish to edit and press **SET**.



See *Viewing Movies* (p. 109).

2 Select (Edit) using or on the multicontroller and press **SET**.

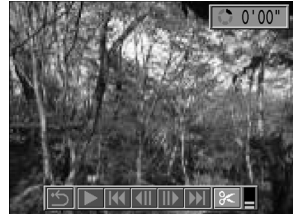
The movie editing panel and the movie editing bar appear.



3 Select an editing method using or on the multicontroller.

-  : Deletes frames in the first half of the movie
-  : Deletes frames in the second half of the movie
-  : Reverts to the movie replay panel

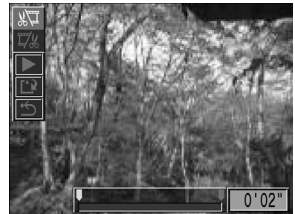

4 Select the range you wish to edit using or on the multicontroller.



5 Select (play) using or on the multicontroller and press **SET**.

- The temporarily edited movie will start playing.
- The movie will stop if you press **SET** while it is playing.

6 Select (Save) using ▲ or ▼ on the multicontroller.

When  is selected, the edited movie is not saved and the camera reverts to replay.



7 Select [Overwrite] or [New File] using ◀ or ▶ on the multicontroller.

- [Overwrite] : Saves the edited movie under the same file name as the original movie. The original data is deleted.
- [New File] : Saves the edited movie under a new file name. The original data is not deleted.
- When there is not enough space left on the CF card, only the overwrite function is available. If this happens, ▲ appears on the counter of the movie editing bar.



- Protected movies cannot be edited.
- It may take approximately 3 minutes to save an edited movie. If the battery pack runs out of charge partway through, edited movie clips cannot be saved. When editing movies, use a fully charged battery pack or the optional AC Adapter Kit ACK700 (p.162).



- Movies with an original length of 2 seconds or more can be edited.
- The minimum length for movie clips is 1 second.

Rotating Images in the Display

Images can be rotated 90° and 270° clockwise on the LCD monitor.

Original



90°



270°



- 1 Select [Rotate] from the [▶] (Replay) menu.

See *Selecting Menus and Settings* (p. 36).

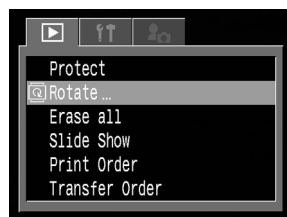

- 2 Select an image you want to rotate using ◀ or ▶ on the multicontroller and press **SET**.

The image cycles to the next orientation (90° → 270° → original) each time **SET** is pressed.



- 3 Press the **MENU** button.

The Replay menu appears again. Press the **MENU** button again to close the menu.



- Movie images cannot be rotated.
- When images are downloaded to a computer, the orientation of images rotated by the camera will depend upon the software used to download the images.





- Images can be magnified when rotated (p. 106).
- Images taken vertically with the auto rotate function (p. 103) set to [On] will automatically be rotated to the vertical position when viewed on the LCD monitor.

Attaching Sound Annotations to Images

In replay mode (including single replay, index replay, magnifying replay and the replay immediately after shooting in Shooting mode) you can attach sound annotations (up to 60 seconds) to an image. The sound data is saved in WAVE format.





- 1** Press the  button while replaying images.
The A / V panel appears.



- 2** Select  (Record) using  or  on the multicontroller, then press **SET**.
- The recording starts and the elapsed time is displayed. Speak towards the microphone of the camera.
 - To stop recording, press **SET**. To restart recording, press **SET** again.
 - You can add as many sound annotations as you like until their total time reaches 60 seconds.



Playing back the Sound Annotations

Select  (Replay) in step 2 above. Images with sound annotations are displayed with the  mark (simple display or detailed display). To start playback, press **SET**. To stop playback, press **SET** again. You can adjust the volume using  or  on the multicontroller.

Erasing the Sound Annotations

Select  (Erase) in step 2 above.

Exiting the Sound Annotations Menu

Press the **MENU** button.



-  • You cannot attach sound annotation to movies.
- You cannot record or playback sound notes for images that already have an incompatible sound file attached. If you attempt to record or play such images, the "Incompatible WAVE format" message will display. Incompatible sound files can be deleted with this camera.
- Sound annotations for protected images cannot be erased. (p. 118).



 The volume can be adjusted in the Setup menu (p. 152).

Replaying, Erasing

Automated Playback (Slide Show)

Slide show image settings are based on DPOF standards (p. 122).

Starting a Slide Show

All images, or a selection of images, can be displayed one-by-one in an automated slide show.

All Images	Plays all the images on the CF card in order
Slide Show 1 - 3	Plays the images selected for each show in order (p. 115)

- 1 In the **[REPLAY]** menu, select **[Slide Show]** and press **SET**.

See *Selecting Menus and Settings* (p. 36).

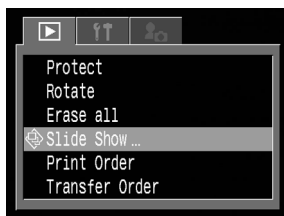

- 2 Select **[Program]** using **▲** or **▼** on the multicontroller. Then select between **[All Images]** or one of **[Show 1]-[Show 3]** using **◀** or **▶** on the multicontroller.



- 3 Select **[Start]** using **▲** or **▼** on the multicontroller and press **SET**.

The slide show will start and automatically stop when the show is done.

Pausing and Resuming a Slide Show

Press **SET** to pause the show. Press it again to resume.

Fast Forward / Rewinding a Slide Show

Use **◀** or **▶** on the multicontroller to move to the previous or next image.

Stopping a Slide Show

Press the **MENU** button during a slide show to stop it and display the slide show menu.

- 4 When the slide show is over, press the **MENU** button.

The slide show menu appears again. Press the **MENU** button again to close the menu.

.....



- Movie images play for the length of time that they were recorded regardless of the time set in the slide show settings.
- The power-saving function is disabled while a slide show plays on the camera (p. 25).

Selecting Images for Slide Shows

You can mark images for inclusion in slide shows 1-3. Up to 998 images may be marked per slide show. Images display in the order of their selection.

1 Display the slide show menu (p. 114).

2 Select [Program] using **▲** on the multicontroller. Then select [Show 1], [Show 2] or [Show 3] using **◀** or **▶** on the multicontroller.

A checkmark will appear beside a show already containing images.

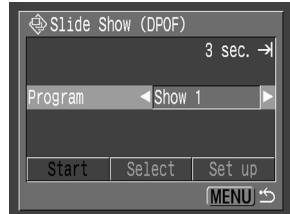

3 Choose [Select] using **▼**, and **◀** or **▶** on the multicontroller and press **SET**.

4 Mark images to include in the show.
Single Replay

- Move between images using **◀** or **▶** on the multicontroller and mark or remove marks from images using **▲** or **▼** on the multicontroller.
- The selection number and a check mark appear at the top of selected images.



Index Replay

- Press the  button to switch to index replay (3 images).
- Select an image using **◀** or **▶** on the multicontroller and mark or remove marks from images using **▲** or **▼** on the multicontroller.
- A check mark and the selection order number appear at the bottom of selected images.
- You can deselect all the images in a show by pressing **SET**, selecting [Clear all] using **▲** or **▼** on the multicontroller and pressing **SET** again.



5 Press the **MENU** button.

The image selection screen will close.

Automated Playback (Slide Show) (continued)

Adjusting the Play Time and Repeat Settings

You can change the play time for all the images in a show and have the show repeat itself continuously.

Play Time	Sets the duration that each image in a slide show is displayed. The options are any one of 3-10 seconds, 15 seconds, 30 seconds and Manual.
Repeat	Sets whether the slide show stops when all the slides have been displayed or continues to display until stopped.

1 Display the slide show menu.

2 Select [Set up] using ◀ or ▶ on the multicontroller and press **SET**.

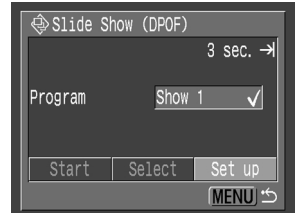

3 Select [Play Time] or [Repeat] using ▲ or ▼ on the multicontroller.

4 Select a setting using ◀ or ▶ on the multicontroller.

Play Time

Select a play time.



Repeat

Select [On] or [Off].



5 Press the **MENU** button.
The set up menu closes.



- The display interval may vary somewhat for some images.
- Slide shows can be easily edited on a computer with the supplied software. See the *Software Starter Guide*.

Protecting Images

You can protect important images from accidental erasure.

- 1** In the **[REPLAY]** menu, select **[Protect]** and press **SET**.
See *Selecting Menus and Settings* (p. 36).

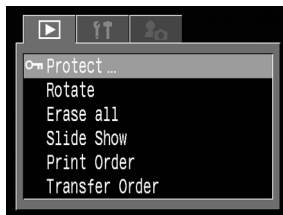

- 2** Select an image you want to protect using **◀** or **▶** on the multicontroller and press **SET**.

- The **[LOCK]** icon appears on protected images.
- To remove the protection, press **SET** again (in protection mode).
- You can make the selection of images easier by toggling between single replay and Index replay with the **[INDEX]** button.



- 3** Press the **MENU** button.
The protect window closes.



! Please note that formatting (initializing) a CF card erases all data, including protected images (p. 121) and other file types. Please check the contents of a CF card before formatting it.

Erasing

Erasing Images Individually



Please note that erased images cannot be recovered. Exercise caution before erasing a file.

1 Set the camera to the replay mode (p. 26).

2 Select the image you wish to erase using ◀ or ▶ on the multicontroller and press the  button.

3 Select [Erase] using ◀ or ▶ on the multicontroller and press **SET**.

To cancel instead of erasing, select [Cancel] and press **SET**.



Protected images cannot be erased with the erase function (p. 118).

Replaying, Erasing

Erasing All Images



Please note that erased images cannot be recovered. Exercise caution before erasing a file.

1 In the [▶] (Replay) menu, select [Erase all] and press **SET**.

See *Selecting Menus and Settings* (p. 36).

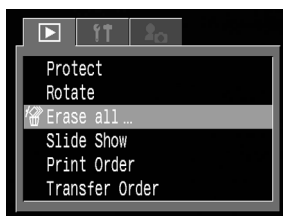

2 Select [OK] using ◀ or ▶ on the multicontroller and press **SET**.

To cancel instead of erasing, select [Cancel] and press **SET**.

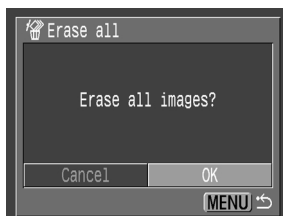

Protected images cannot be erased with the erase function (p. 118).

Formatting a CF Card

You should format a new CF card or one from which you wish to erase all images and other data.



Please note that formatting (initializing) a CF card erases all data, including protected images and other file types. Please check the contents of the CF card before formatting it.

1

In the **[M] (Set up)** menu, select **[Format]** and press **SET**.

See *Selecting Menus and Settings* (p. 36).

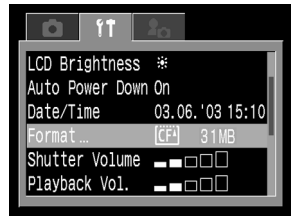

2

Select **[OK]** using **◀** or **▶** on the multicontroller and press **SET**.

To cancel formatting instead, select **[Cancel]** and press **SET**.

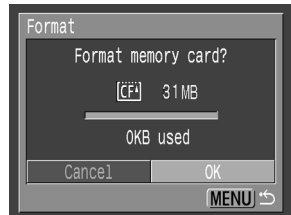

Replaying, Erasing



- If the camera does not work properly, the inserted CF card may be malfunctioning. Reformatting the CF card may solve the problem.
- When a non-Canon brand CF card is malfunctioning, reformatting it may solve the problem.
- CF cards formatted in another camera, computer or peripheral device may not operate correctly. When that happens, reformat the CF card with this camera.

About Printing

This camera supports direct printing. By connecting the camera to an optional direct print compatible printer (CP series)*¹ or Bubble Jet printer (sold separately) that supports the direct print function, you can send the images from the CF card directly to the printer using the camera buttons. Or, you can specify the images on your CF card you want to print and how many copies you want (DPOF*² Print Settings), and then take the CF card to a participating photo lab to have them printed out later.

*¹ The direct print  icon appears on direct print compatible CP series printers.

*² Digital Print Order Format

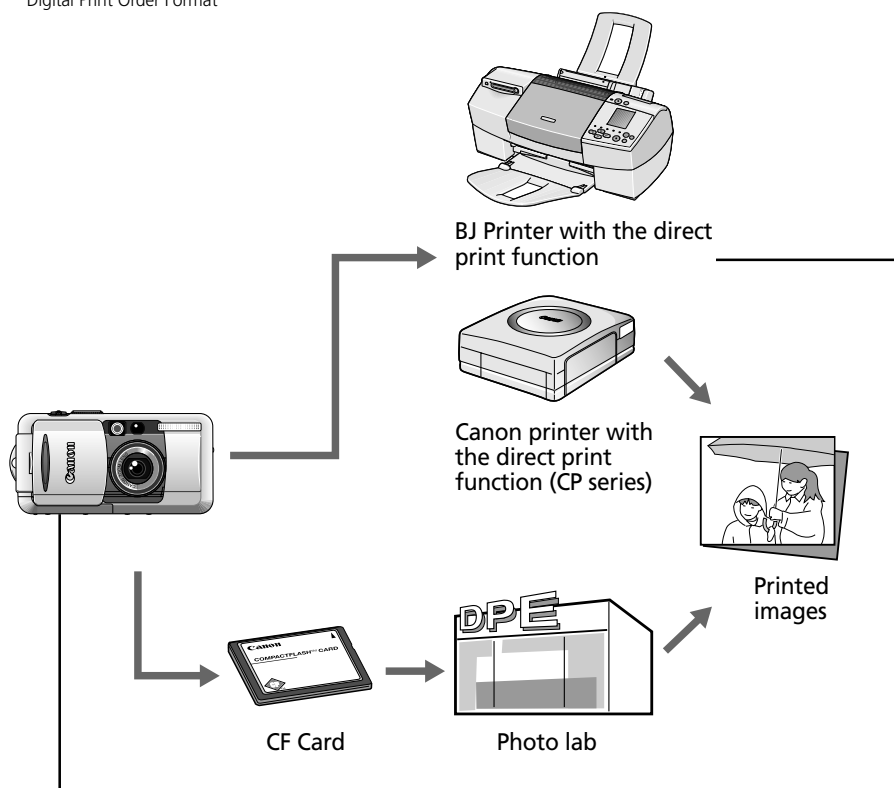

Please refer to the *System Map* supplied with your camera for direct print function compatible printer (CP series) information.

Print Settings for Direct Print Function

- Select how many copies you want (p.131)



- Select the print style (p.131)

- Standard / Multiple
- Bordered / Borderless
- Date On / Off



- Select the print area (Trimming) (p.133)

DPOF Print Settings

- Select the image you want to print (p. 135)



- Select how many copies you want (p. 135)



- Select the print style (p. 137)

- Standard / Index
- Date On / Off
- File Numbers On / Off

Transfer Settings

- Select the image you want to send through e-mail* (p. 142)

* The DPOF-compliant software is needed for actually transferring the images.

Selecting from the Print Order Menu

Use the Print Order Menu as shown below to select all print settings. However, set the camera to replay mode beforehand.

Direct Print Function

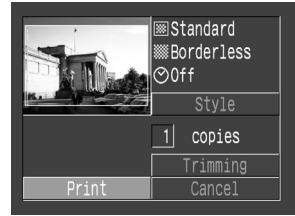
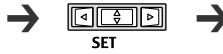

DPOF Settings

MENU

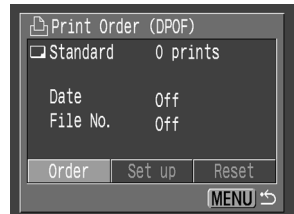
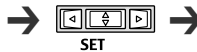
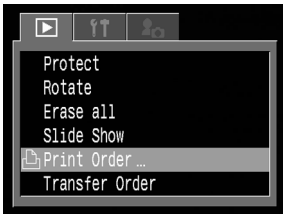

MENU



: Turns the menu on/off



: Selects items and settings

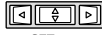

: Sets items and settings

SET

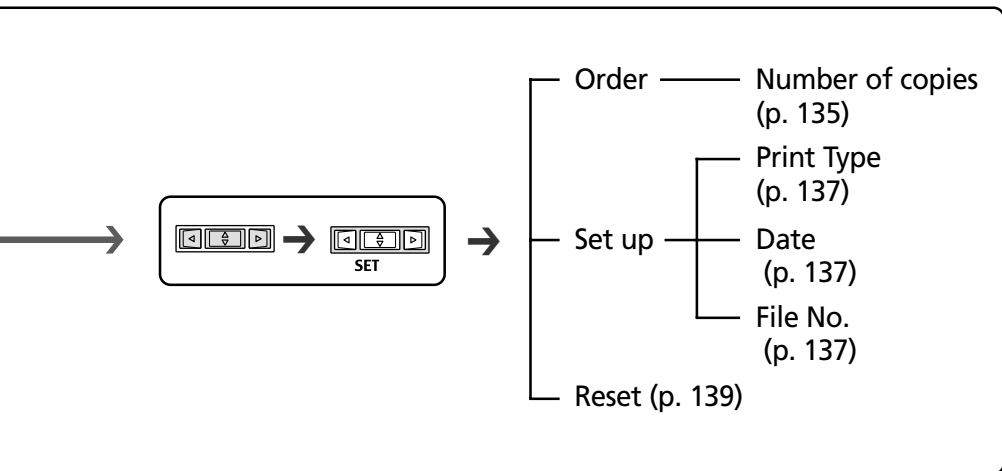
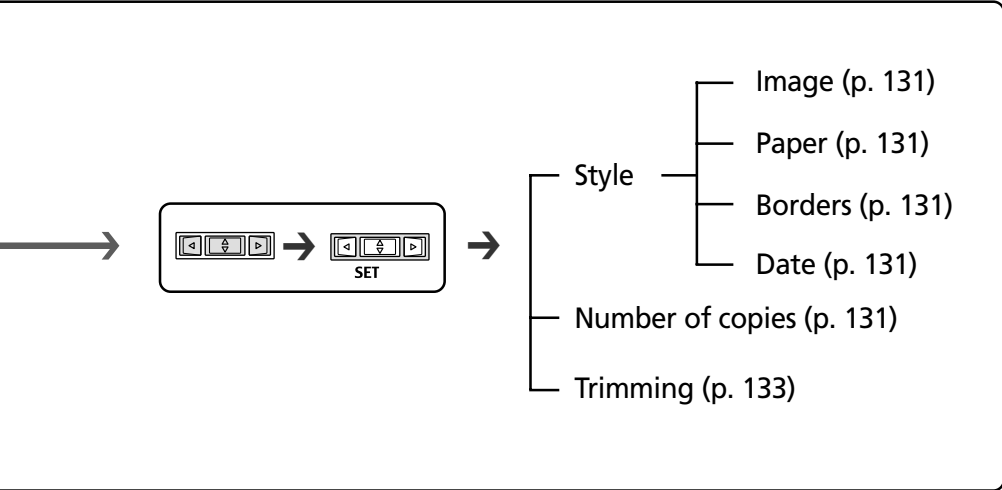

Connecting the Camera to a Printer

You can make clear prints swiftly and easily when you connect the camera to an optional direct print function compatible printer (CP series) or a direct print function compatible Bubble Jet printer (optional). It can also be used with DPOF print settings.



You are recommended to use the optional AC Adapter Kit ACK700 to power the camera when it is connected to the printer. If you are using a battery pack, ensure that it is fully charged.



- Refer to the *System Map* included with this camera kit for information on direct print compatible printers (CP series).
- Please see your printer's user guide for instructions on loading paper and installing ink cartridges.

Connecting to a Direct Print Function Compatible Printer (CP Series)

Two direct interface cables are supplied with the printer. Use the cable (DIF-100) that has a ⇐ symbol on the connector to connect to this camera.

1 Turn off the camera (p. 24).

2 Attach the power cable to the printer and plug the other end into power supply, or install the printer's rechargeable battery.

Depending on the type of printer you have, it may or may not use rechargeable batteries. Refer to your printer's user guide.

3

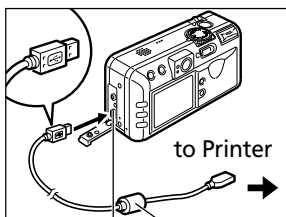

DIGITAL Terminal
Direct Interface Cable DIF-100

Connect the camera and printer using the direct interface cable.

When you insert the cable, make sure the ⇐ mark of the cable faces the rear of the camera (monitor side).

4 Press the printer's ON/OFF button to turn on the power.

- When the printer is properly connected to the camera, it powers up,  appears on the camera LCD monitor and the power/mode indicator is lit in green.
- With the Card Photo Printer CP-10, the power turns on when the power cord is connected to the printer as shown in Step 2.



Connecting Bubble Jet Printer to the Camera



Please read the user guide supplied with your BJ printer to see if it is compatible with the direct print function, and for instructions on connection cables and general operations.

1 Turn off the camera (p. 24).

2 Turn the BJ printer's power on after you have connected the power cord to the BJ printer and inserted the other end in a power outlet.

3

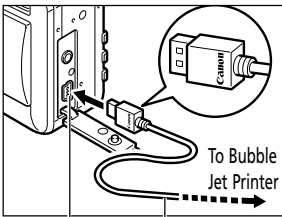

DIGITAL Terminal Connection cable

Connect the camera and printer using the connection cable.



- When you insert the cable, make sure the "Canon" logo on the cable faces the front of the camera (lens side).
-  appears on the camera LCD monitor and the power/mode indicator is lit green when the BJ printer is properly connected to the camera.

Connecting the Camera to a Printer (continued)



When you detach the cable from the camera, hold the plug and do not pull by the cable.



- On Bubble Jet printers with operation panels, images cannot be printed through the operation panel while the camera is connected.
- The following operations cannot be performed while the printer is connected.
 - Replaying movies
 - Setting the language using the **SET** and the **JUMP** button combination.
- When the printer is disconnected, the  or  symbol will disappear from the LCD monitor and the camera will revert to standard replay mode.
- Please use the following procedures when you detach the cable from the printer and the camera.
 1. Detach the cable from the printer.
 2. Turn off the camera power.
 3. Detach the cable from the camera.

Printing

* The following illustrations show examples from a direct print function compatible printer (CP series). Options for the Style category will differ slightly for BJ printers.

An image can be printed when displayed in single replay or selected in index replay.

1 Choose an image using ◀ or ▶ on the multicontroller and press **SET**.

2 Set the number of prints, the print style and cropping settings as required.

- *Selecting the Number of Copies* (p. 131)
- *Setting the Print Style* (p. 131)
- *Trimming (Printing a Portion of an image)* (p. 133)

3 Choose [Print] using ▲, ▼, ◀ or ▶ on the multicontroller and press **SET**.

- You can also select [Print] by pressing the **JUMP** button.
- The image will start to print and, when it is completely finished, the display will revert to standard replay mode.



Printing (continued)



You cannot print movies or images recorded in the RAW format.



Cancel Printing

- To cancel printing between images printed, press **SET**. A confirmation dialog appears. Select [OK] using ◀ or ▶ on the multicontroller and press **SET**.
 - Direct Print Function Compatible Printers (CP Series)
A print in progress cannot be stopped. The printer will stop after the current print is complete and the camera will display its replay screen at that point.
 - BJ Printers
The printer will stop printing the current image and eject the paper.

Printing Errors

- An error message appears if an error occurs for some reason during the printing process (p. 158). Use ◀ or ▶ on the multicontroller to select [Stop] or [Resume] and press **SET** (with a BJ printer, the print will automatically restart if the error is resolved).
 - Direct Print Function Compatible Printers (CP Series)
The [Resume] option may not appear with some types or error. In that case, select [Stop].
 - BJ Printers with the Direct Print Function
 - The [Continue] and [Stop] options may appear with some error messages.
 - On BJ printers equipped with an operation panel, an error number displays on the panel. Please refer to the Bubble Jet Printer Quick Start Guide for the remedies corresponding to the error numbers.

Setting the Print Settings (Direct Print Function)

Selecting the Number of Copies

1 In Replaying mode, press **SET** and select the [Copies] option using **▲** or **▼** on the multicontroller.

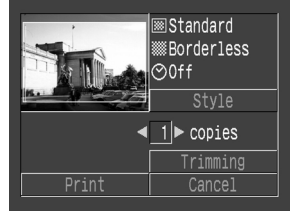

2 Specify the desired number of copies using **◀** or **▶** on the multicontroller.

You can specify from 1 to 99 prints.

Setting the Print Style

You can select from among the following print styles.

Direct Print Function Compatible Printer (CP Series)

Image	Standard	Prints one image per page.
	Multiple*	Prints eight copies of the same image on one page.
Borders	Borderless	Prints right to the edges of the page.
	Bordered	Prints with a border.
Date		Prints the image's creation date.

* Only selectable when printing with credit-card size paper.

Direct Print Function Compatible BJ Printer

Paper		Select the paper size from the following. [Card #1], [Card #2], [Card #3], [LTR] or [A4] For the usable paper type, please refer to the Bubble Jet Printer User Guide.
Borders	Borderless	Prints right to the edges of the page.
	Bordered	Prints with a border.
Date		Prints the image's creation date.

Setting the Print Settings (Direct Print Function) (continued)

- 1 In the print setting menu, choose [Style] using **▲** or **▼** on the multicontroller and press **SET** again.

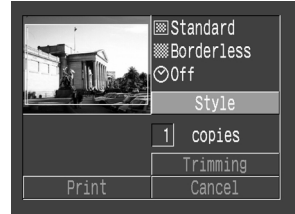

- 2 Choose [Image] (or [Paper]), [Borders] or [Date] using **▲** or **▼** on the multicontroller.



- 3 Select settings using **◀** or **▶** on the multicontroller.

Image Settings
(Direct print compatible
CP series printer)



Select [Standard] or [Multiple].

Paper
(Direct print compatible
BJ printer)

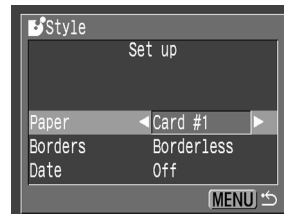

Select [Card #1], [Card #2], [Card #3], [LTR] or [A4].

Borders



Choose [Borderless] or [Bordered].

Date



Choose [On] or [Off].

4 Press the **MENU** button.

With borderless or multiple prints, the top, bottom and sides of the image may be cropped slightly. If you have not specified a trimming setting, a frame will appear around the area of the image that will be printed, allowing you to check the portion that will be cropped.



Print Area Frame



- The date settings are overridden by the DPOF settings if you are using them to print (p. 135)
- When printing multiple prints, the borders and the date cannot be set. (Images are printed without any date or borders)
- With the [Bordered] option, the border is printed in practically the same space as the recorded image.

Setting the Printing Area (Trimming)

You can specify which portion for an image gets printed.



Prior to Trimming

Please set the Print Style (Image Settings, Paper, Borders and Date) first before setting the trimming settings (p. 131).

1 In Replaying mode, press **SET** and choose [Trimming] using **▲** or **▼** on the multicontroller and press **SET** again.



The trimming frame will appear at the center of the image. If a trimming setting has already been selected for the image, the frame will appear around the previously selected portion.



Setting the Print Settings (Direct Print Function) (continued)

2 Trim the Image.

Changing the Size of the Trimming Frame

- Slide the zoom lever toward  or .
- The trimming frame can be changed to a minimum selection of approximately half the displayed image or a maximum selection that is virtually the same size as the image.
- When printing an image that has been magnified using the trimming option, the image quality may become coarser and grainier depending on the magnifying rate. With direct print function compatible printers, the trimming frame displays in red.



Setting the Portion of the Trimming Frame

Move the trimming frame using , ,  or  on the multicontroller.

Rotating the Trimming Frame

You can rotate the trimming frame by pressing the **DISPLAY** button.

Canceling the Trimming Frame

You can cancel the trimming setting by pressing the **MENU** button or by sliding the zoom lever toward  again when the trimming frame is already set to the maximum size.

3 Press **SET** to close the setting menu.

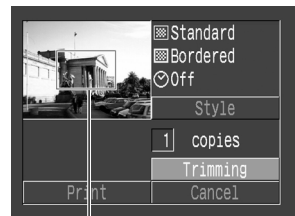

Trimming Frame



- The trimming setting only applies to one image.
- The trimming setting is cancelled with the following operations.
 - When you set the trimming settings for another image.
 - When you close the Print mode (when you turn the camera power off, change the camera mode, or detach the direct interface cable).
 - When you try to expand the trimming frame beyond its maximum size.



- The selected Image Settings, Paper and Border setting determine the shape of the trimming frame.
- Please use the LCD monitor to set the trimming settings. The trimming frame may not display correctly on a TV monitor.

Print Settings (DPOF Print Settings)

You can select images on a CF card for printing and specify the number of print copies in advance using the camera. This is extremely convenient for sending the images to a photo developing service or for printing on a direct print function compatible printer (CP series) or a direct print function compatible BJ printer.

.....





- The  mark appears on images that have had print marks set by another DPOF-compliant camera. These settings will be overwritten by any print marks set by your camera.
- The output of some digital printers or photo lab services may not reflect the specified print settings.
- Print settings cannot be set for movie images or RAW images.

Selecting Images for Printing

1 In the [ (Replay)] menu, select [Print Order] and press **SET**.

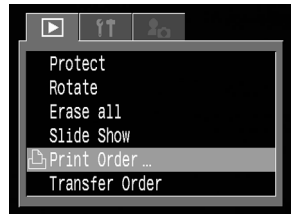
See *Selecting Menus and Settings* (p. 36).



2 Select [Order] using  or  on the multicontroller and press **SET**.

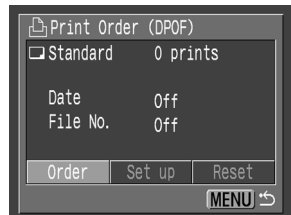

Print Settings (DPOF Print Settings) (continued)

3 Select images for printing.

Single Images

- When the print type (p. 137) is set to [Standard] or [Both], select an image using ◀ or ▶ on the multicontroller. You can set the number of copies (up to 99) to be printed using ▲ or ▼ on the multicontroller.

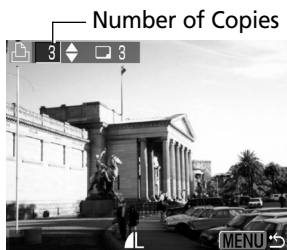

- When the print type (p. 137) is set to [Index], select an image using ◀ or ▶ on the multicontroller and mark or remove marks from images using ▲ or ▼ on the multicontroller.
- You can use the same procedures to select images in index replay (3 images). Press the [] button to switch between single replay and index replay.



All the Images on a CF Card

- Press the [] button to switch to index replay (three images).
- You can set one copy of each image to print by pressing **SET**, then selecting [Mark All] using ▲ or ▼ on the multicontroller, and pressing **SET** again.
- When the print type is set to [Standard] or [Both], the setting for the number of print copies can be changed for each image. When [Index] is selected, the print settings can be deleted. For the instructions on changing settings, please reread Step 3 from the beginning.
- You can cancel all the settings by selecting [Clear all].

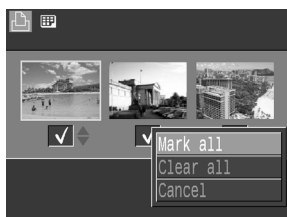

4 Press the **MENU** button.



The selection mode will turn off and the Print Order menu will reappear.



- Images are printed in order from oldest to newest by the shooting date.
- A maximum of 998 images can be marked per CF card.
- When [Print Type] is set to [Both], the number of copies can be set. When it is set to [Index], the number of copies cannot be set (only one copy will be printed).
- Print settings can also be assigned to images with the supplied software programs on a computer.

Setting the Print Style



Always select a print style after having selected the image you wish to print. The following print settings can be selected.

Print Type	 Standard	Prints one image per page
	 Index	Prints the selected images together at a reduced size in an index format
	 Both	Prints the images in both the standard and index formats
Date		Adds the date to the print
File No.		Adds the file number to the print

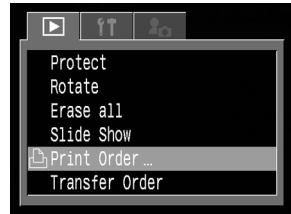

1 In the  (Replay) menu, select [Print Order] and press **SET**.



See *Selecting Menus and Settings* (p. 36).

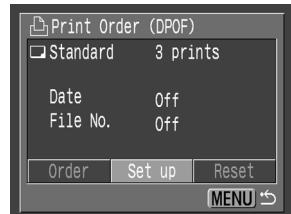

2 Select [Set up] using  or  on the multicontroller and press **SET**.



3 Select [Print Type], [Date] or [File No.] using  or  on the multicontroller.

4 Select a setting using  or  on the multicontroller.

Print Type
Select [Standard], [Index] or [Both].

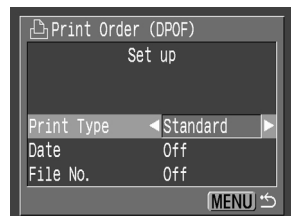

Print Settings (DPOF Print Settings) (continued)

Date

Select [On] or [Off].

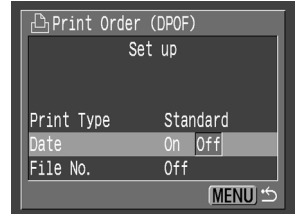

File No.

Select [On] or [Off].

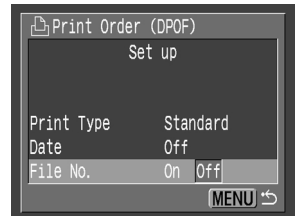

5 Press the **MENU** button.

The set up menu will close and the Print Order menu will reappear.



- When [Print Type] is set to [Index], the [Date] and [File No.] cannot be set to [On].
- If [Print Type] is set to [Both], both [Date] and [File No.] can be set to [On], however, only the file number is printed for the index print.



The date prints as the date and time in the format specified in the Set Date/Time menu (p. 21).

Resetting the Print Settings

The print settings can all be removed at once. The print type is reset to [Standard] and the date and file number options are set to [Off].

- 1 In the [▶] (Replay) menu, select [Print Order] and press **SET**.

See *Selecting Menus and Settings* (p. 36).

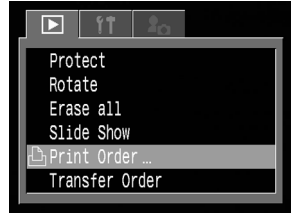

- 2 Select [Reset] using ◀ or ▶ on the multicontroller and press **SET**.

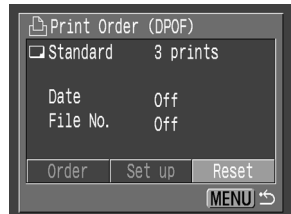

- 3 Select [OK] using ◀ or ▶ on the multicontroller and press **SET**.

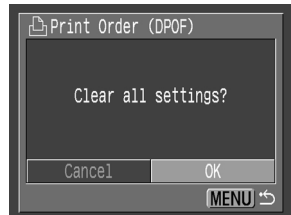

Printing with DPOF Print Settings

You can use the DPOF print settings to print with an optional direct print function compatible printer (CP series) or with a direct print function compatible BJ printer (optional).

- 1** In the [ (Replay)] menu, select [Print Order] and press **SET**.

See *Selecting Menus and Settings* (p. 36).

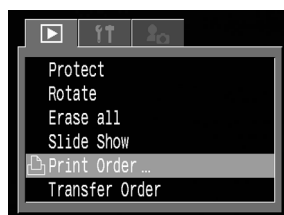

- 2** Select [Print] using **▲**, **▼**, **◀** or **▶** on the multicontroller and press **SET**.

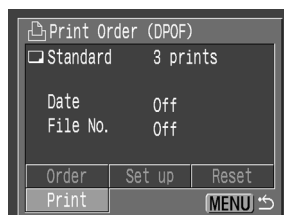

- 3** Set the print style settings as required.

- See *Setting the Print Settings* (p. 131).
- A print style cannot be set if the print type is set to [Index] in the DPOF print setting. (You can also select the type of paper when printing with a BJ printer)

- 4** Select [OK] using **▲**, **▼**, **◀** or **▶** on the multicontroller and press **SET**.

The image will start to print and, when it is completely finished, the display will revert to the standard replay mode.

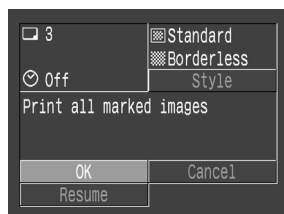



- To print the date, set the [Date] setting in the print order menu in Step 2 on the previous page to [On]. You cannot set the date to print with the [Style] menu in Step 3 on the previous page. If the print type is set to [Index], the date will not print even if the [Date] setting is set to [On] in Step 2.
- When the print type is set to [Both], it is possible to have both the [Date] and [File No.] options set to [On], but only the file number will print on the Index print. (With a BJ printer, the file number and the date cannot be printed in the [Index] option)
- When the print type is set to [Standard], file numbers will not be printed even if they are set to [On].



- The maximum number of images printed on one page in the Index print type depends upon the selected paper size.
 - Card Size: 20 images
 - L Size: 42 images
 - Postcard Size: 63 images(Please refer to your Bubble Jet's user guide for an explanation of the number of images printed with a Bubble Jet printer.)
- Cancel Printing (p. 130)

Restarting Printing

- In the Print Order menu, select [Resume] using ◀ or ▶ on the multicontroller and press **SET**. The remaining images can be printed.
- Printing cannot be restarted under the following circumstances.
 - If the print settings have been changed before restarting.
 - If the image for which the print settings were set has been deleted before restarting.
 - If there was very little free space on the CF card when the printing was cancelled.If these circumstances apply, you can select [OK] in the Print Order menu and reprint starting from the first image. If printing was cancelled because the camera battery became discharged, you are recommended to power the camera with the AC Adapter Kit ACK700. If you must use a battery pack, ensure that it is fully charged for printing. After replacing the spent battery pack, turn the camera power on again.
- Printing Errors (p. 130)

Image Transfer Settings (DPOF Transfer Order)

Using the camera, you can make marks on images you wish to transfer and attach to e-mails. (Please use the supplied software for actually transferring images. Refer to the *Software Starter Guide* for instructions on how to transfer images.) These settings are compatible with the Digital Print Order Format (DPOF) standards.



The  mark will display on images that have had transfer marks set by another DPOF-compliant camera. These settings will be overwritten by any marks set by your camera.

Selecting Images for Transferring

- 1** In the [ (Replay)] menu, select [Transfer Order] and press **SET**.
See *Selecting Menus and Settings* (p. 36).

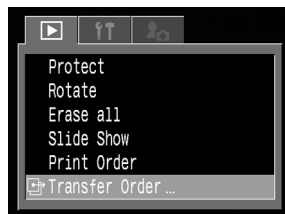

- 2** Select [Order] using **◀** or **▶** on the multicontroller and press **SET**.
Pressing [Reset] cancels the transfer settings for all images on the CF card.

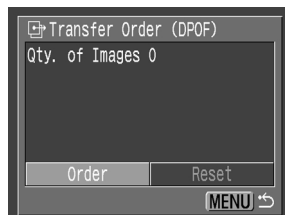

3 Select images for transferring.

Single Images

- Select an image using ◀ or ▶ on the multicontroller and mark or remove marks from images using ▲ or ▼ on the multicontroller.
- You can use the same procedures to select images in index replay (3 images). Press the  button to switch between single replay and index replay.



All the Images on a CF Card

- Press the  button to switch to index replay (three images).
- Then press **SET**, and select [Mark All] using ▲ or ▼ on the multicontroller and press **SET** again. (If you select [Clear All] instead of [Mark All], you can remove marks from all the images.)
- You can mark or remove a mark from each image after marking or removing marks from all the images.

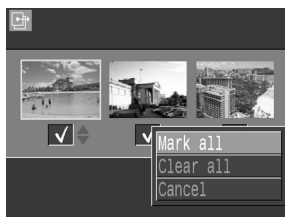

4 Press the **MENU** button.

The selection mode will turn off and the Transfer Order menu will reappear.



- Images are transferred in order from oldest to newest by the shooting date.
- A maximum of 998 images can be marked per CF card.

Viewing Images on a TV Set

A video-compatible television connected via the supplied AV cable AVC-DC100 can be used to view images as you shoot or replay them.

1 Turn off the camera (p. 24).

2

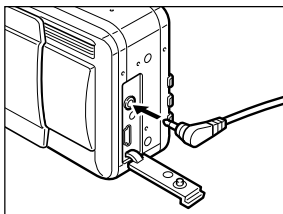

Attach AV Cable AVC-DC100 to the **A/V OUT** terminal on the camera.

3

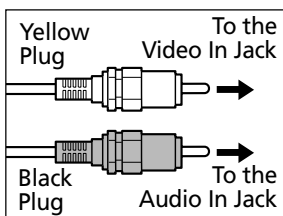

Plug the other ends of the AV cable to the video in and audio in jacks on the TV.

4

Turn on the TV and switch it to Video mode.

5

Turn on the camera in Shooting mode or Replaying mode (p. 24).

- The image will appear on the TV. Shoot or replay images as usual.
- If the images are not appearing on the TV when shooting, press the **DISPLAY** button.

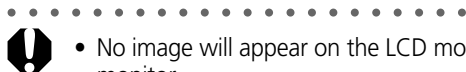

- No image will appear on the LCD monitor when the camera is connected to a TV monitor.
- The video output signal can be switched (NTSC or PAL) to accommodate different regional standards (p. 154). The default setting will vary between regions.
NTSC: Japan, U.S.A., Canada, Taiwan, etc.
PAL: Europe, Asia (excluding Taiwan), Oceania, etc.
If an incorrect video system is set, the output image will not display properly.
- If the TV is a stereo model, you can plug the audio plug into either the left or right Audio In jack. Please refer to the TV's manual for details.
- A TV set cannot be used in  mode.

Downloading Images to a Computer

Download images taken with the camera to a computer in one of the following ways:

- Connect the camera to a computer with the USB cable
You can then download images directly from the camera to a computer.
- Directly from the CF card
Using a laptop computer or a card reader, you can download images directly from the CF card.

Connecting the Camera to a Computer Via the USB Cable

After the software is installed, you can use it to easily download images and print them or send them by e-mail.

IMPORTANT

You must install the software and driver bundled on the supplied Canon Digital Camera Solution Disk onto your computer if you are using any of the following operation systems:

**Windows 98 (including Second Edition)/Windows 2000/Windows Me
Mac OS 9.0 or 9.2**



The camera will not operate correctly if you connect it to your computer before installing the driver and software. If this happens, please refer to the *Troubleshooting* section of the *Software Starter Guide*.

1 Install the driver and the software applications bundled on the Canon Digital Camera Solution Disk.

Please see the *Software Starter Guide* for information on system requirements and installation instructions.

2 Connect the supplied USB interface cable to the computer's USB port and the camera's DIGITAL terminal.

- You do not need to turn off the computer or camera when making USB connection.
- Please refer to your computer manual for information regarding the location of the USB port.
- The camera's LCD monitor will blank out when the connection to the computer is complete and the power/mode indicator will light yellow.

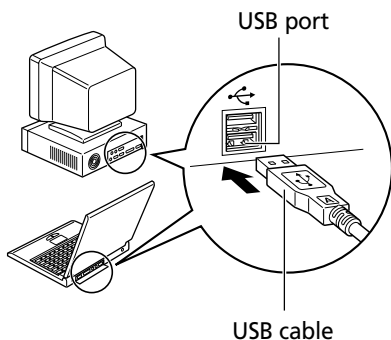

DIGITAL Terminal

1. Open the terminal cover with your fingernail.
2. Insert the connector until it clicks.

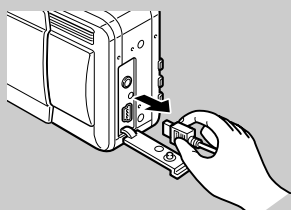
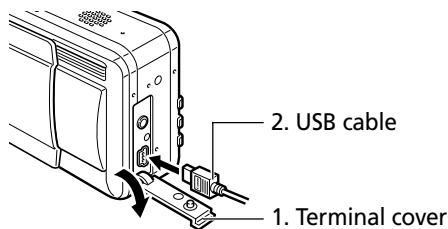

To disconnect the cable from the camera:
Hold the cable connector firmly at both sides and pull it straight out.

For information about what to do after making the connection, please refer the *Software Starter Guide*.

Downloading Images without Installing the Software (Windows XP and Mac OS X (10.1 or 10.2) only)

If you are using Windows XP or Mac OS X (10.1 or 10.2), you can use the software distributed with these operating systems to download images (JPEG format only) without installing the software bundled on the Canon Digital Camera Solution Disk. This is useful for downloading images to a computer in which the software is not installed.

However, please note that there are certain limitations to downloading images with this method. For more details, please refer to the supplied *For Windows® XP and Mac OS X Users* leaflet.

- 1 Connect the supplied USB interface cable to the computer's USB port and the camera's DIGITAL terminal. (Refer to step 2 of page 145)
- 2 Follow the onscreen instructions to download the images.



- It is recommended to power the camera with the optional AC Adapter Kit ACK700 when connected to a computer (p. 162).
- If you disconnect the USB cable while the camera is on, the camera will automatically turn off.
- All procedures performed with a connection to a USB 2.0 compliant board are not guaranteed.

Downloading Directly from a CF Card

1

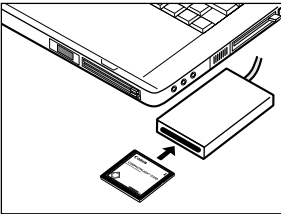

Eject the CF card from the camera, and insert it into a CF card reader connected to the computer.

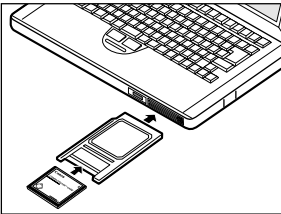

- If you are using a PC card reader, first insert the CF card into a PC card adapter (optional), and then insert the PC card adapter into the computer's PC card reader.

2

Double-click the icon of the drive with the CF card.

3

Copy images from the card into a folder of your choice on the hard disk.

The images are stored in the [xxxCANON] folders located under the [DCIM] folder (where xxx is a three-digit number from 100 to 998).

List of Menu Options and Messages

Rec. Menu

* Some items may not appear in certain Shooting modes (p. 180).



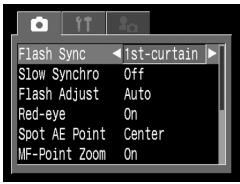
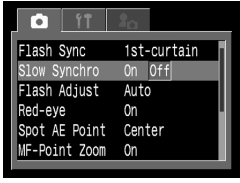
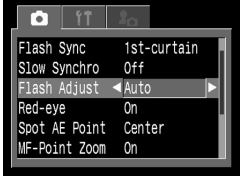
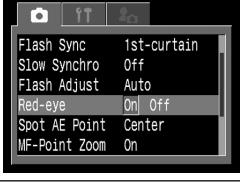
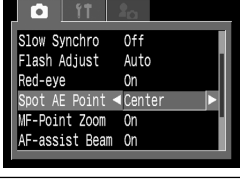
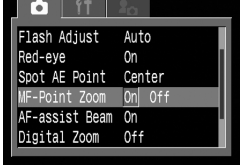

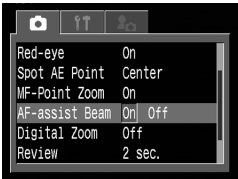
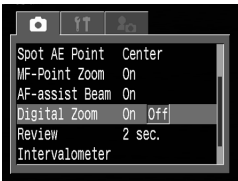
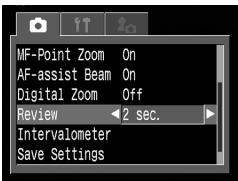
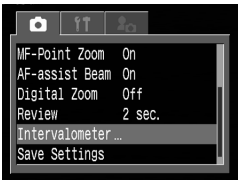
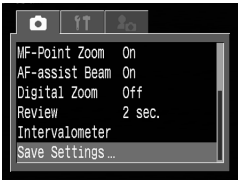



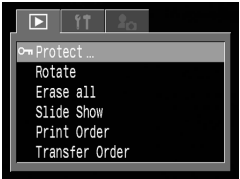

*Default setting

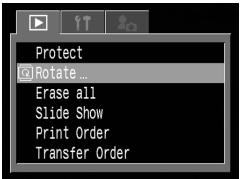
Item	Menu Screen	Settings Content	Reference Page
Flash Sync		Sets the timing at which the flash fires. <ul style="list-style-type: none"> • 1st-curtain* • 2nd-curtain 	95
Slow Synchro		Sets the slow synchro. <ul style="list-style-type: none"> • On • Off* 	55
Flash Adjust		Sets whether or not the flash is adjusted automatically. <ul style="list-style-type: none"> • Auto* • Manual 	93
Red-eye		Sets whether or not the red-eye reduction lamp fires. <ul style="list-style-type: none"> • On* • Off 	54
Spot AE Point		Sets the Spot AE Point option, Center (the AE point is fixed to the center) or AF Point (the AE point corresponds to the AF point). <ul style="list-style-type: none"> • Center* • AF Point 	77
MF-Point Zoom		Sets whether or not the focusing point is magnified when using the manual focus. <ul style="list-style-type: none"> • On* • Off 	100

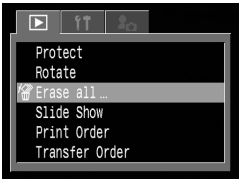
Item	Menu Screen	Settings Content	Reference Page
AF-assist Beam		Sets the output of the AF-assist beam according to shooting conditions when using the auto focus. <ul style="list-style-type: none"> • On* • Off 	34
Digital Zoom		Sets whether or not the digital zoom combines with the optical zoom to zoom images. <ul style="list-style-type: none"> • On • Off* 	65
Review		Sets the duration images display on the LCD monitor after the shutter button is released. <ul style="list-style-type: none"> • Off • 2 sec.* to 10 sec. 	48
Intervalometer		Shoots automatically at set intervals.	96
Save Settings		Saves settings selected in the shooting menu and the function menu to the shooting mode dial's C mode.	102

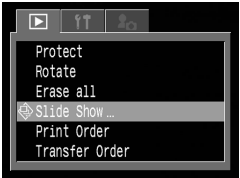

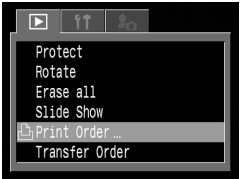

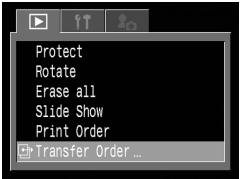
Replay Menu

*Default setting

Item	Menu Screen	Settings Content	Reference Page
 Protect		Protects images from accidental erasure.	118
 Rotate		Rotates images 90 or 270 degrees clockwise in the display.	112
 Erase all		Erases all images from a CF card (excluding protected images).	120
 Slide Show		Plays images in an automated slide show.	114
 Print Order		Sets the images that will be printed on a DPOF-compatible printer or at a photo lab service, the number of copies and other parameters.	135
 Transfer Order		Sets the images that will be transferred with your e-mail software.	142

Set up Menu

*Default setting

Item	Menu Screen	Settings Content	Reference Page
Beep		<p>Sets whether or not the beep sounds when the shutter button is pressed or when a menu operation is performed. See also "How the [Beep] setting in the [] (Set up)] menu and each sound setting in the [] (My Camera)] menu are related" on page 156.</p> <ul style="list-style-type: none"> • On* • Off (Still beeps to warn of an error even when set to Off) 	33
LCD Brightness		<p>Sets the brightness level of the LCD monitor.</p> <ul style="list-style-type: none"> • [] (Normal)* • [] (Bright) 	-
Auto Power Down		<p>Sets whether or not the camera automatically powers down after a specified period of time elapses without something being pressed.</p> <ul style="list-style-type: none"> • On* • Off 	25
Date/Time		<p>Sets the date, time and date format.</p>	21
Format		<p>Formats (initializes) a CF card.</p>	121

Set up Menu (continued)

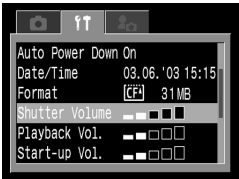
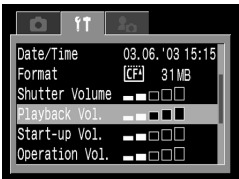
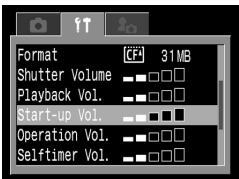

*Default setting

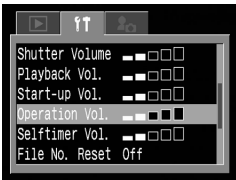
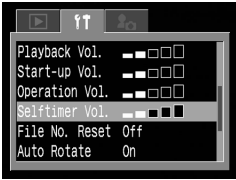
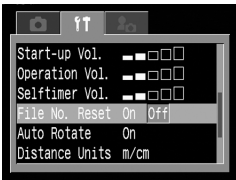
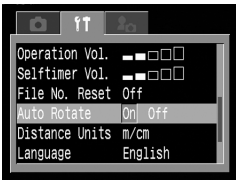
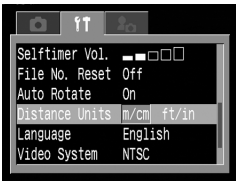
Item	Menu Screen	Settings Content	Reference Page
Shutter Volume		<p>Adjusts the sound volume when the shutter button is pressed all the way. There is no shutter sound in Movie mode.</p> <ul style="list-style-type: none"> • □□□□□ (Off) • ■□□□□ (1) • ■■□□□ (2)* • ■■■□□□ (3) • ■■■■□□ (4) • ■■■■■□ (5) 	33
Playback Vol. (Replay)		<p>Adjusts the sound volume when a sound annotation or a movie is played.</p> <ul style="list-style-type: none"> • □□□□□ (Off) • ■□□□□ (1) • ■■□□□ (2)* • ■■■□□□ (3) • ■■■■□□ (4) • ■■■■■□ (5) 	109, 113
Start-up Vol.		<p>Adjusts the sound volume when the camera powers up.</p> <ul style="list-style-type: none"> • □□□□□ (Off) • ■□□□□ (1) • ■■□□□ (2)* • ■■■□□□ (3) • ■■■■□□ (4) • ■■■■■□ (5) 	25

Item	Menu Screen	Settings Content	Reference Page
Operation Vol.		<p>Adjusts the sound volume of the Operation Sound.</p> <ul style="list-style-type: none"> • □□□□ (Off) • ■□□□ (1) • ■■□□ (2)* • ■■■□□ (3) • ■■■■□ (4) • ■■■■■ (5) 	34
Selftimer Vol.		<p>Adjusts the sound volume of the Selftimer Sound informing you that the photo will be taken in 2 seconds.</p> <ul style="list-style-type: none"> • □□□□ (Off) • ■□□□ (1) • ■■□□ (2)* • ■■■□□ (3) • ■■■■□ (4) • ■■■■■ (5) 	64
File No. Reset		<p>Sets how file numbers are assigned to images when new CF cards are inserted.</p> <ul style="list-style-type: none"> • On • Off* 	104
Auto Rotate		<p>Sets whether or not images shot with the camera on end are automatically rotated in the display.</p> <ul style="list-style-type: none"> • On* • Off 	103
Distance Units		<p>Sets the format of the MF indicator's displayed distance units.</p> <ul style="list-style-type: none"> • m / cm* • ft / in 	100

Set up Menu (continued)











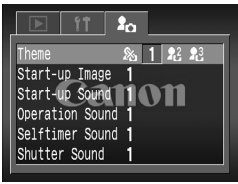



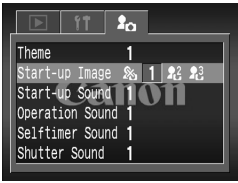

*Default setting

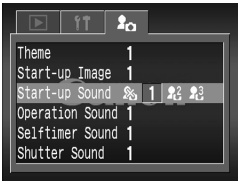
Item	Menu Screen	Settings Content	Reference Page
Language	 <p>The screenshot shows a camera menu with the following items: Selftimer Vol. (with a progress bar), File No. Reset Off, Auto Rotate On, Distance Units m/cm, Language... English (highlighted), and Video System NTSC.</p>	<p>Sets the language used in the menus and messages on the LCD monitor. The menu may appear differently in some regions.</p> <ul style="list-style-type: none"> • English* • Deutsch • Français • Nederlands • Dansk • Suomi • Italiano • Norsk • Svenska • Español • Chinese • Japanese <p>You can change the language during image replay by holding the SET button and pressing the JUMP button. (Except when the camera is connected to a printer)</p>	23
Video System	 <p>The screenshot shows the same camera menu as above, but with 'Video System' set to 'NTSC' and 'PAL' also visible next to it.</p>	<p>Sets the video output signal standard.</p> <ul style="list-style-type: none"> • NTSC* • PAL 	144

My Camera Menu

You can select the theme, start-up image and sound, shutter sound, operation sound and selftimer sound used on this camera. These are called My Camera settings. You can also customize the [22] and [23] options for each item with images from the CF card and newly recorded sounds or by using the supplied software. See the *Software Starter Guide* for details.

*Default setting

Item	Menu Screen	Settings Content	Reference Page
Theme		<p>Selects a common theme for each My Camera settings item. *¹</p> <ul style="list-style-type: none"> •  (Off) • 1 * •  •  	40
Start-up Image		<p>Sets the start-up image when you turn on the camera.</p> <ul style="list-style-type: none"> •  (Off) • 1 * •  •  	40
Start-up Sound		<p>Sets the start-up sound when you turn on the camera.*¹</p> <ul style="list-style-type: none"> •  (Off) • 1 * •  •  	40
Operation Sound		<p>Sets the sound when the multicontroller or any button other than the shutter button is operated.*¹</p> <ul style="list-style-type: none"> •  (Off) • 1 * •  •  	40

My Camera Menu (continued)

*Default setting

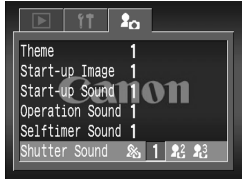
Item	Menu Screen	Settings Content	Reference Page
Selftimer Sound		Sets the sound informing you that the photo will be taken in 2 seconds.* ¹ <ul style="list-style-type: none"> • (Off) • * • • 	40
Shutter Sound		Sets the shutter sound when you depress the shutter button. There is no shutter sound while a movie is being shot.* ¹ <ul style="list-style-type: none"> • (Off) • * • • 	40

*¹ How the [Beep] setting in the [] (Set up)] menu and each sound setting in the [] (My Camera)] menu are related

- To actually turn off the sound of the start-up sound, shutter sound, operation sound, and self-timer sound individually, [Beep] in the [] (Set up)] menu must be set to [Off]. If [Beep] is set to [On], the beep sounds even if each sound item in the [] (My Camera)] menu is set to [Off].
For details, see the table below.

		The settings of [Beep] in the [] (Set up)] menu	
		[On]	[Off]
The settings of each sound item in the [] (My Camera)] menu ([Start-up Sound]/[Shutter Sound]/[Operation Sound]/[Selftimer Sound])		● [Beep]	–
		●	●
		●	●
		●	●

- : The sound specified in [] sounds.
- : No sound

Resetting the Settings to Default

You can reset the menu and button operation settings to default except for the [Date/Time], [Language], and [Video System] settings.

1 Turn on the camera.

You can turn on the camera into either Shooting or Replaying mode.

2 Press the **MENU** button for longer than 5 seconds.

The message "Reset settings to default?" appears on the LCD monitor.

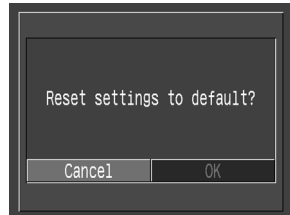

3 Select [OK] using ◀ or ▶ on the multicontroller, then press **SET**.

- The screen on the right appears while resetting. The normal screen resumes when resetting is complete.
- To cancel resetting, select [Cancel] instead of [OK].

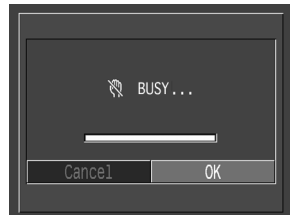

.....



- The custom white balance is not cancelled even if settings are reset to default settings. (p. 81)
- Settings cannot be reset when the camera is connected to a computer, to an optional direct print function compatible printer (CP series) or to a direct print function compatible BJ printer (optional).

.....



When the camera is in Shooting mode, only the **C** mode settings will revert to default when the shooting mode dial is turned to **C**.

List of Messages

The following messages may appear on the LCD monitor.

Reset settings to default?:	Do you wish to reset all the camera and menu settings to default?
Resetting:	Resetting all the camera and menu settings to default
Busy...:	Image is being recorded to, or read from, CF card. Resetting settings to default.
No memory card:	You attempted to shoot or replay images without a CF card installed.
Cannot record!:	You attempted to shoot an image without a CF card installed.
Memory card error:	CF card has experienced an anomaly.
Memory card full:	CF card is too full to save more images or print settings.
Naming error!:	The file could not be created because there is a file with the same name as the directory that the camera is attempting to create, or the highest possible file number has already been reached. In the Rec. menu, please set [File No.] Reset to [On]. After you save all the images you wish to retain onto a computer, format the CF card (p. 121). Please note that formatting will erase all the existing images and other data.
Change the battery pack:	Battery charge is insufficient to operate the camera. Replace it immediately with a charged battery pack or recharge it.
No image:	No images recorded on CF card.
Image too large:	You attempted to replay an image larger than 3200 x 2400 pixels.
Incompatible JPEG format:	You attempted to replay an incompatible JPEG file.
Corrupted data:	You attempted to replay an image with corrupted data.

RAW:	You attempted to replay an image recorded in an incompatible RAW format.
Cannot magnify!:	You attempted to magnify an image that was photographed with another camera, recorded in a different format, or edited on a computer.
Cannot rotate:	You attempted to rotate an image that was photographed with another camera, recorded in a different format, or edited on a computer.
Unidentified Image:	You attempted to replay an image that was recorded in a special format (proprietary format used by the camera of another manufacturer, etc.).
Incompatible Wave format:	Cannot attach sound annotation to the image because the image has some sound file recorded in an inappropriate format.
Protected!:	You attempted to erase a protected image.
Too many marks:	Too many images have been marked for printing or for inclusion in a slide show. Cannot process any more.
Cannot mark image:	You attempted to set the print settings for a non-JPEG file.
Cannot complete!:	Couldn't save the print or slide show settings.
Cannot edit:	Slide show settings file is corrupted
Cannot register this image!:	You attempted to register an image recorded with another camera as a start-up image.
Cannot change!:	You attempted to change to the RAW format an image that was shot with the digital zoom or that was already recorded in the RAW format.

List of Messages (continued)

The following messages may appear on the camera's LCD monitor when a direct print compatible printer (CP series) is printing. Depending on the printer model, some messages may not display.

No Paper:	Paper cassette is incorrectly inserted or out of paper. Or the paper feed isn't operating correctly.
No Ink:	The ink cartridge has not been inserted or has run out of ink.
Incompatible paper size:	Wrong paper size is loaded in the printer.
Incompatible ink size:	Wrong ink cassette size is loaded in the printer.
Ink Cassette Error:	The ink cassette is experiencing a problem.
Paper and ink do not match:	The paper and ink are from different sets.
Paper Jam:	The paper jammed during printing.
Paper has been changed:	Paper was changed after the print menu was displayed.
Recharge the printer battery:	The printer's battery pack is depleted.
Communication Error:	The printer is experiencing a data transmission error.
Could not print xx images:	You attempted to use the DPOF print settings to print xx images that are from another camera, that have been recorded in a different format, or that have been edited on a computer.
Cannot Print!:	You attempted to print an image from another camera, one recorded in a different format, or one that has been edited on a computer.
Readjust trimming:	You attempted to print the image with a different style than the one used when the trimming settings were set.

The following messages may appear when the camera is connected to the Direct Print compatible Bubble Jet Printer.

On Bubble Jet printers with operation panels, check the error number displayed on the panel and refer to the Bubble Jet Printer *Quick Start Guide*.

(The message or error code may not display with some models.)

Printer in use:	The printer is printing the data from the memory card inserted in the computer or printer. The printer automatically starts printing the images from the camera after completing the current printing.
Printer warming up:	Printer is warming up. When it is ready, the printer starts printing automatically.
No print head:	No print head is installed in the printer.
Printer cover open:	Close the printer cover securely.
Media type error:	You selected a paper type incompatible with the printer. Select a compatible paper type in the Print Style menu.
Paper lever error:	Adjust the paper thickness lever to the proper position.
Low ink level:	The ink tank needs to be replaced soon. Prepare a new ink tank. If you select [Continue] in the error screen, you can restart printing. (This message may not display with some models.)
Waste tank full:	You can restart printing by pressing the RESUME/CANCEL button on Bubble Jet Printer. Please request replacement of the waste tank at your nearest Canon customer support center listed in the Contact List provided with the Bubble Jet Printer or in the Bubble Jet Quick Start Guide.
Printer error:	Turn off the printer, then turn it on again. If the error persists, please consult your nearest Canon customer support center listed in the Contact List provided with the Bubble Jet Printer or in the Bubble Jet Quick Start Guide.

Using an AC Adapter Kit (Optional)

You are advised to use AC Adapter Kit ACK700* (optional) for long periods of use and when connecting to a computer or printer.

* Consists of Compact Power Adapter CA-PS700, DC Coupler DR-700 and a power cord.

1

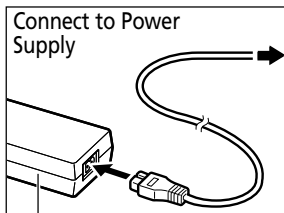

Compact Power Adapter
CA-PS700

Attach the power cord to the compact power adapter and plug it into a power outlet.

2

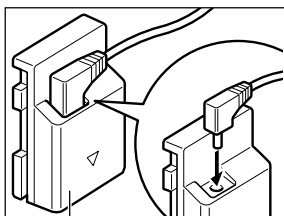

DC Coupler DR-700

Connect the DC plug of the compact power adapter cable to the DC Coupler DR-700 terminal.

3

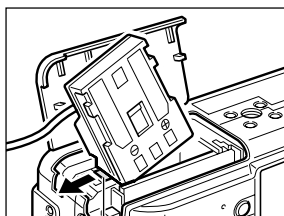

Battery lock

Open the CF card slot/battery cover, then insert the DC Coupler until it is locked.

4

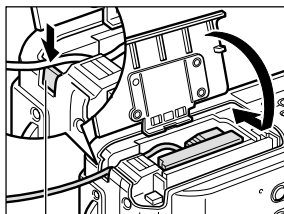

DC Coupler Cable Cover

Press and hold the DC Coupler cable cover using the cable, then close the CF card slot/battery cover.

Always disconnect the power cord from the power supply after use.



- Always turn the camera's power off before connecting or disconnecting the compact power adapter (p. 24).
- Use of any adapter other than AC Adapter Kit ACK700 may cause malfunction of the camera or AC adapter kit.



Using a Car Battery Charger (Optional)

Car Battery Charger CBC-NB2 (sold separately) can be used to charge battery packs from an automobile's cigarette lighter socket.

Always ensure that the automobile's engine is running when you use the car battery charger. Use of it with the engine off may flatten the battery in some automobiles. Always unplug the car battery charger before turning off the engine.

1

To the cigarette lighter socket

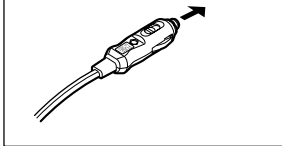

With the engine running, plug the car battery cable into the cigarette lighter socket and the battery charger.

2

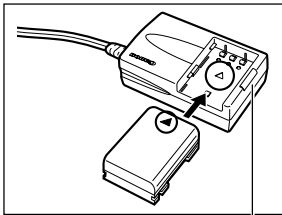

Charge Indicator

Insert the battery pack all the way into the battery charger as shown.



- Align the arrow on the battery pack and the arrow on the battery charger to correctly insert the battery pack in the charger.
- The charge indicator will light red while the battery pack is charging. It will change to green when the charge is complete.
- After charging, unplug the car battery cable from the cigarette lighter socket and remove the battery pack.



- The battery will stop charging whenever you turn the engine off, so be sure to unplug the car battery cable from the cigarette lighter socket.
- Wait until the engine is running again to plug the car battery cable into the cigarette lighter socket.
- The car battery charger can only be used in a negative ground car. It cannot be used in a positive ground car.

Using the Waterproof Case (Optional)

Some of the camera's operations differ slightly when it is used in the waterproof case WP-DC300 (sold separately). Please operate the camera according to the below information.

Camera Operations (without the waterproof case)	Camera Operations with the Waterproof Case	Page Number
Turning off the power	Hold the  / WB / FUNC. button for more than 5 seconds. (Press the shutter button halfway when turning on the camera for the second time)	24
Selecting menus using the MENU button or the  / WB / FUNC. button.	Press ◀ or ▶ on the multicontroller while holding the MF button.	36, 37
Focusing the camera manually (Manual focus)		
Changing the aperture value in M mode	Press ◀ or ▶ on the multicontroller while holding the  (light metering) button.	73





- The display location cannot be moved up and down in magnified replay.
- Please refer to the Waterproof Case user guide for details about specifications and handling precautions.

Troubleshooting

Problem	Cause	Solution
Camera will not operate	Power is not turned on	Turn on the camera. ➔ See <i>Turning the Power On / Off</i> (p. 24).
	CF card slot/battery cover opened	Confirm that the CF card slot/battery cover is securely closed.
	Insufficient battery voltage	Fully charge the battery or use a household power source.
	Poor contact between camera and battery terminals	Wipe the terminals with a clean, dry cloth.
Camera will not record	Camera is in Replay or computer/printer mode	Switch the camera to Shooting mode. ➔ See <i>Switching between Shooting and Replaying</i> (p. 26).
	Flash is charging (blinking orange indicator)	Wait until the orange indicator stops blinking and lights steadily, signaling that the flash is charged, then press the shutter button.
	CF card full	<ul style="list-style-type: none"> • Insert a new CF card. • If required, download the images to a computer and erase them from the CF card to make space.
	CF card not formatted correctly	<ul style="list-style-type: none"> • Format CF card. ➔ See <i>Formatting a CF card</i> (p. 121). • If reformatting doesn't work, the CF card logic circuits may be damaged. Contact the nearest Canon Customer Support Help Desk.
Lens will not retract	CF card slot/battery cover opened with camera on	Close the CF card slot/battery cover, then turn off the camera.
	CF card slot/battery cover opened while camera was recording to CF card (warning signal)	Close the CF card slot/battery cover, then close the lens cover.
	Switched to Replaying mode from Shooting mode	The lens does not retract in this case. To make the lens retract, close the lens cover.

Troubleshooting (continued)

Problem	Cause	Solution
Battery pack consumed quickly	Battery pack capacity reduced because of disuse for one year or more after being fully charged	Replace the battery pack with a new one.
	Battery life exceeded	Replace the battery pack with a new one.
Battery pack will not charge	Battery life exceeded	Replace the battery pack with a new one.
	Poor contact between battery charger and battery	<ul style="list-style-type: none"> • Clean the battery terminals with a clean dry cloth. • Insert the charger plug firmly into the power outlet.
Image is blurred or out of focus	Camera moved	<ul style="list-style-type: none"> • Be careful not to move the camera when pressing the shutter button. • Use a tripod at slow shutter speeds when the camera shake warning  appears.
	Autofocus function hampered by obstruction to AF auxiliary light emitter	Be careful not to block the AF auxiliary light emitter with your finger or other items.
	AF-assist Beam is set to off	Set the AF-assist Beam to [On]. ➔ See <i>Rec. Menu</i> (p. 148)
	Subject out of focal range	<ul style="list-style-type: none"> • Ensure that there is at least 50 cm (1.64 ft.) between the camera lens and subject. • Use the macro mode to shoot close-ups between 10 and 50 cm (3.9 in. and 1.64 ft.) at maximum wide angle and 30 and 50 cm (12 in. and 1.64 ft.) at maximum telephoto.
	Subject is hard to focus on	Use the focus lock or the manual focus to shoot the image. ➔ See <i>Shooting Problem Subjects for the Autofocus</i> (p. 98)
Subject in recorded image is too dark	Insufficient light for shooting	Set the flash to [On].
	Subject dark in comparison to the background	<ul style="list-style-type: none"> • Set the exposure compensation to a positive (+) setting. • Use the AE lock or spot metering function. ➔ See <i>Locking the Exposure Setting (AE Lock)</i> (p. 90) and <i>Switching between Light Metering Modes</i> (p. 77)
	Subject too far for flash to reach	<ul style="list-style-type: none"> • To use the built-in flash, shoot within the following ranges: When sensitivity is set to AUTO: 35 cm - 4.8 m (1.1 ft. - 15.7 ft.) (W) 35 cm - 3.0 m (1.1 ft. - 9.8 ft.) (T) When sensitivity is set to ISO 100 equivalent: 55 cm - 4.0 m (1.8 ft. - 13.1 ft.) (W) 55 cm - 2.5 m (1.8 ft. - 8.2 ft.) (T)

Problem	Cause	Solution
Subject in recorded image is too dark	Subject too far for flash to reach	Raise the ISO sensitivity and then shoot. See <i>Changing the ISO Speed</i> (p. 85)
Subject in recorded image is too bright	Subject too close	Adjust the flash output with the flash exposure compensation function (p. 93).
	Subject bright in comparison to the background	<ul style="list-style-type: none"> Set the exposure compensation to a negative (-) setting. Use the AE lock or spot metering function. <ul style="list-style-type: none"> ➔ See <i>Locking the Exposure Setting (AE Lock)</i> (p. 90) and <i>Switching between Light Metering Modes</i> (p. 77)
	Light shining directly on subject or reflected off subject into camera	Change the shooting angle.
	Flash set to On.	Set the flash to Auto or Off.
A red bar of light appears on the upper part of the LCD monitor	Subject is too bright.	This is a normal occurrence in devices containing CCDs and does not constitute a malfunction. (This red bar of light will not be recorded when shooting still photos, but it will be recorded when shooting movies.)
White dots or white asterisks appear on the image	Light from the flash has reflected off dust particles or insects in the air. This occurs more frequently in the following conditions: <ul style="list-style-type: none"> - When shooting at the wide-angle end. - When shooting with a high aperture value in the aperture-priority AE mode. 	This is a phenomenon that occurs with digital cameras and does not constitute a malfunction.
Flash will not fire	Flash set to Off.	Set the flash to Auto or On.
Image not showing on TV	Incorrect video system setting	Set the video system to the appropriate setting, NTSC or PAL, for your TV (p. 154).
	Shooting mode set to  (Stitch Assist)	The output will not appear on a TV monitor in  (Stitch Assist) mode. Shoot in a different mode.
Zoom does not operate.	Zoom lever was moved while shooting in movie mode.	Operate the zoom before shooting in movie mode.
CF card image reading is slow Recording images on the CF card takes too long	Currently used CF card has been formatted in a different device.	Use a CF card formatted with this camera. <ul style="list-style-type: none"> ➔ See <i>Formatting a CF Card</i> (p. 121)

Specifications

All data is based on Canon's testing standard. Subject to change without notice.

PowerShot S50

Camera effective pixels:	Approx. 5 million
Image sensor:	1/1.8 inch CCD (Total number of pixels: approx. 5.3 million)
Lens:	7.1 (W) - 21.3 (T) mm (35mm film equivalent 35-105 mm) F2.8(W) - 4.9 (T)
Digital tele-converter:	Max. approx. 4.1 × (Maximum 12x digital zoom is available when combined with optical zoom)
Optical viewfinder:	Real-image zoom viewfinder, picture coverage = approx. 82%
LCD monitor:	1.8-inch, low-temperature polycrystalline silicon TFT color LCD, picture coverage = 100%
Autofocus method:	TTL Auto focus 9-point (AiAF)/1-point (AF) 1-point AF: Any position is available Focus lock and Manual focus are available
Shooting distance (from tip of the lens barrel):	Normal AF: 50 cm (1.64 ft.) – ∞ Macro AF: 10 cm (W) / 30 cm (T) – 50 cm (3.9 in. (W) / 11.8 in. (T) – 1.64 ft.) Manual focus: 10 cm (W) / 30 cm (T) – ∞ (3.9 in. (W) / 11.8 in. (T) – ∞)
Shutter:	Mechanical shutter + electronic shutter
Shutter speeds:	15 – 1/1500 sec. 1.3 sec. or more shutter speed is automatically selected in Shutter-Priority mode or Manual mode Slow shutter speeds of 15-1/3 sec. operates with noise reduction
Light metering system:	Evaluative metering, Center-weighted average metering, Spot metering (Center or AF Point)
Exposure control method:	Program AE, Shutter-priority AE, Aperture-priority AE or Manual exposure control AE lock is available
Exposure compensation:	+/- 2 stops in 1/3-stop increments Auto exposure bracketing (AEB) is available
Sensitivity	Auto, ISO 50, ISO 100, ISO 200, ISO 400 equivalent
White balance:	TTL auto white balance, preset white balance (available settings: Daylight, Cloudy, Tungsten, Fluorescent, Fluorescent H or Flash) or Custom white balance (Custom 1 / Custom 2)
Flash:	Auto, On, Off Red-eye reduction On: Red-eye reduction auto / Red-eye reduction On / flash Off Red-eye reduction Off: On / Off

Flash range:	(When sensitivity is set to AUTO) 35 cm - 4.8 m (1.1 ft. - 15.7 ft.) (W), 35 cm - 3 m (1.15 ft. - 9.8 ft.) (T) (When sensitivity is set to ISO 100 equivalent) 55 cm - 4 m (1.8 ft. - 13.1 ft.) (W), 55 cm - 2.5 m (1.8 ft. - 8.2 ft.) (T)
Flash exposure compensation:	+/- 2 stops in 1/3-stop increments, FE lock is available
Shooting modes:	Auto Creative zone: Program, Shutter Speed Priority, Aperture Priority, Manual and Custom Image zone: Portrait, Landscape, Night Scene, Fast Shutter, Slow Shutter, Stitch Assist and Movie
Continuous shooting:	High-Speed continuous shooting: Approx. 2.0 image/sec. Standard continuous shooting: Approx. 1.5 image/sec. (Large/Fine mode with LCD viewfinder off)
Interval shooting:	Shooting interval: approx. 1 - 60 min. (1 min. increments) Number of shots: 2 - 100 shots (Maximum number of shots varies according to CF card capacity)
Self-timer:	Approx. 2 sec./10 sec. shutter release delay
PC-connected shooting:	Available (USB connection only. Use the supplied software RemoteCapture.)
Storage media:	CompactFlash™ (CF) card (Type I or Type II)
File Format:	Design rule for Camera File system, DPOF-compliant
Image recording format	Still images: JPEG (Exif 2.2)* or RAW Movies: AVI (Image data: Motion JPEG, Audio data: WAVE [monaural])
Compression mode:	Super fine, Fine or Normal
Number of recording pixels:	Still images: Large: 2592 x 1944 pixels Medium 1: 1600 x 1200 pixels Medium 2: 1024 x 768 pixels Small: 640 x 480 pixels Movies: 320 x 240 pixels (Approx. 3 min.)** 160 x 120 pixels (Approx. 3 min.)** Approx. 15 frames/sec. ** The data in parentheses refer to the maximum movie length per shooting
Replay modes:	Single (Histogram displayable), Index (9 thumbnail images), Magnified (approx. 10x (max.) in LCD monitor) Slide Show Sound annotations (up to 60 sec.) Image output to Card Photo Printer CP-100 / CP-10 and Bubble Jet Printer with the direct print function
Display languages	English, Deutsch, Français, Nederlands, Dansk, Suomi, Italiano, Norsk, Svenska, Español, Chinese and Japanese
My Camera Settings (customizing):	The Start-up Image, Start-up Sound, Shutter Sound, Operation Sound and Selftimer Sound can be customized using the following methods. 1. Using the images and sounds recorded on the camera. 2. Using downloaded data from your computer using the supplied software.

Specifications (continued)

Interface:	Universal Serial Bus (mini-B, PTP [Picture Transfer Protocol]) Audio/Video Output (NTSC or PAL selectable, monaural audio)
Power source:	1. Rechargeable Lithium-ion battery (type: NB-2L) (supplied) 2. AC Adapter kit ACK 700 (optional) 3. Car Battery Charger Kit CBC-NB2 (Optional)
Operating Temperatures:	0 – 40°C (32 – 104°F)
Operating Humidity:	10 – 90%
Dimensions (W × H × D):	112 × 58 × 42 mm (4.4 × 2.3 × 1.7 in.) (excluding protrusions)
Weight:	Approx. 260g (9.2 oz.) (camera body only)

(W): wide angle (T): telephoto

- * This digital camera supports Exif 2.2 (also called “Exif Print”). Exif Print is a standard for enhancing the communication between digital cameras and printer. By connecting to an Exif Print-compliant printer, the camera’s image data at the time of shooting is used and optimized, yielding extremely high quality prints.

Battery Performance (Battery Pack NB-2L at full charge)

	Number of Images Shot		Replay Time
	LCD Monitor On	LCD Monitor Off	
PowerShot S50	Approx. 210 images	Approx. 460 images	Approx. 180 minutes

* The data above reflects standard Canon testing conditions. The actual figures will vary according to the shooting conditions and settings.

* Movie data is excluded.

* At low temperatures, the battery pack performance may diminish and the low battery icon appear very rapidly. In these circumstances, the performance can be improved by warming the battery pack in a pocket before use.

<Test Conditions>















Shooting: Normal temperature (23° C, 73° F), alternating wide angle end and telephoto end shots at 20-second intervals with flash fired once every four shots and camera power turned off and on every eighth shot. CF card used.







Replaying: Normal temperature (23° C, 73° F), continuous playback at one image per 5 seconds. CF card used.







See *Battery Pack Handling Precautions* (p. 16)

CF Cards and Estimated Capacities (Recordable Images)

		FC-16M	FC-32M	FC-64M	FC-128M	FC-256MH*	
L (Large)	2592 x 1944 pixels		5	11	24	49	99
			10	21	43	88	177
			21	43	88	176	355
M 1 (Medium)	1600 x 1200 pixels		14	30	61	122	246
			26	54	109	219	440
			52	108	217	435	868
M 2 (Medium)	1024 x 768 pixels		25	53	107	215	431
			46	94	189	379	762
			84	174	349	700	1390
S (Small)	640 x 480 pixels		58	120	241	482	962
			94	196	393	788	1563
			165	337	676	1355	2720
RAW	2592 x 1944 pixels		2	5	12	25	51
Movie	320 x 240 pixels		44 sec	91 sec	183 sec	368 sec	735 sec
	160 x 120 pixels		118 sec	242 sec	486 sec	973 sec	1954 sec

- These figures reflect standard shooting conditions established by Canon. Actual totals may vary according to the subject, shooting conditions and Shooting mode.
 - The following are the approximate maximum recording times for movie clips:
 : 3 minutes,  : 3 minutes. The maximums in the chart reflect continuous shooting.
 - **L** (Large), **M1** (Medium 1), **M2** (Medium 2), **S** (Small) and ,  indicate the resolution.
 -  (Superfine),  (Fine) and  (Normal) indicate the relative compression ratio.
- * The Canon FC-256MH CF card is not sold in some regions.

Approximate Image File Sizes (Estimated)

Resolution	Compression		
			
L (2592 x 1944 pixels)	2503 KB	1395 KB	695 KB
M1 (1600 x 1200 pixels)	1002 KB	558 KB	278 KB
M2 (1024 x 768 pixels)	570 KB	320 KB	170 KB
S (640 x 480 pixels)	249 KB	150 KB	84 KB
RAW	4725 KB		
Movies	 (320 x 240 pixels)	330 KB/sec	
	 (160 x 120 pixels)	120 KB/sec	

Battery Pack NB-2L

Type:	Rechargeable lithium ion cell
Nominal voltage:	7.4 V
Nominal amperage:	570 mAh
Charge cycles:	Approx. 300
Operating temperatures:	0 - 40° C (32 - 104° F)
Dimensions:	33.3 × 45.2 × 16.2 mm (1.3 × 1.8 × 0.6 in.)
Weight:	Approx. 40 g (1.4 oz.)

Battery Charger CB-2LT / CB-2LTE

Input voltage:	AC 100 - 240 V (50/60 Hz) 0.17 A (100V) - 0.10 A (240V)
Rated output:	8.4 V DC, 0.5 A
Charging time:	Approx. 80 minutes*
Operating temperatures:	0 - 40° C (32 - 104° F)
Dimensions:	91 × 29.5 × 56 mm (3.6 × 1.2 × 2.2 in.)
Weight:	CB-2LT: Approx. 86 g (3.0 oz.)/CB-2LTE: Approx. 82 g (2.9 oz)

* When charging Battery Pack CB-2LT

Compact Power Adapter CA-PS700

(Included with the optional AC Adapter Kit ACK700)

Input voltage:	AC 100 - 240 V (50/60 Hz) 0.32 A
Rated output:	7.4 V DC / 2.0 A
Operating temperatures:	0 - 40°C (32 - 104°F)
Dimensions:	112 × 29 × 45 mm (4.4 × 1.1 × 1.8 in.)
Weight:	Approx. 186 g (6.6 oz.)

Car Battery Charger CBC-NB2 (Optional)

Rated Input:	DC 12 V / 24 V
Rated Output:	DC 8.4 V / 0.55 A
Operating temperatures:	0 - 40°C (32 - 104°F)
Dimensions:	91 × 56 × 29.5 mm (3.58 × 2.2 × 1.16 in.)
Weight:	Approx. 145 g (5.1 oz.)

CompactFlash™ Card

Card slot type:	Type I
Dimensions:	36.4 x 42.8 x 3.3 mm (1.4 x 1.7 x 0.1 in.)
Weight:	Approx. 10 g (0.4 oz.)

Index

A

- AC Adapter Kit 162
- AEB Mode 86
- AE Lock 90
- AF Frame
 - Auto Selection 74
 - Manual Selection 74
- Aperture-Priority AE (**Av**) 71
- Aperture Value 67, 69, 71, 73
- Auto Mode (**AUTO**) 45
- Auto Exposure Bracketing (AEB Mode) 86
- Auto Replay (Slide Show) 114
- AV Out Terminal 10, 144

B

- Battery Pack
 - Charging 15
 - Handling Precautions 16
 - Installing 17
 - Low Status 18
 - Performance 172
- Battery charger 15
- Beep 151, 152, 153
- Black and White Mode 83
- Brightness
 - LCD Monitor 151

C

- Camera Care and Maintenance 166
- CF Card
 - Formatting 121
 - Handling 20
 - Installing 19
 - Recording Capacity 173
- Cleaning 166
- CompactFlash™ Card 19, 20, 121, 173
- Compact Power Adapter 162
- Components Guide 10
- Compression 49, 173
- Continuous Shooting () 66
- Contrast 83
- Creative Zone 13

D

- Date/Time 21, 151
- DC Coupler 162
- Digital Print Order Format (DPOF) Settings
 - Print Settings 135, 140
 - Transfer Order 142
- Digital Terminal 10, 126, 144
- Digital Zoom 35, 65, 149
- Display Modes 28 - 31
 - Detailed 29, 30
 - Simple 29, 30
- DPOF

- Print Settings 135, 140
- Transfer Order 142

E

- Erasing
 - All Images 120
 - Displayed Images 9
 - Single Images 119
- Exposure
 - AEB 86
 - AE Lock 90
 - Aperture-Priority AE (**Av**) 71
 - Compensation 79
 - Flash Exposure Compensation 93
 - Shutter Speed-Priority AE (**Tv**) 69
 - White Balance 80
- Exposure Compensation 79

F

- Fast Shutter 57
- FE Lock 92
- File Format 47, 52
- File No. Reset 104
- File Numbers 104
- Flash 54
- Flash Exposure Compensation 93
- Focal Length 35
- Focus
 - Lock 98
 - Manual 100
- Format 121

H

- Histogram 31
- Household Power Source 162

I

- Image Characteristics 83
 - Contrast 83
 - Saturation 83
 - Sharpness 83
- Image Zone 13
- Index Replay 107
- Indicators 12
- Information View 29 - 30
- Interface
 - Cables 10, 126, 144
- Intervalometer 96, 149
- ISO Speed 85

J

- Jump 108

L

- Landscape Mode () 56
- Language Settings 23, 154

LCD Monitor 28 - 31
 Brightness 151
 Light Metering
 Center-Weighted Averaging 77
 Evaluative 77
 Spot AE Point (AF Point) 77
 Spot AE Point (Center) 77

M

Macro Mode (M) 63
 Magnifying Images 106
 Manual
 Exposure (M) 73
 Focus (MF) 100
 Setting Image Characteristics 83
 Shooting Mode 73
 Menu
 List of Options 148
 Rec 148
 Replay 150
 Selecting Menus and Settings 36
 Set up 152 - 154
 Messages 158
 Movie (M) (M)
 Shooting 62
 Replaying 109
 Editing 110
 My Camera
 Menu 155
 Settings 40
 Registering 42

N

Night Scene Mode (N) 57

O

Overexposure Warning 31
 Operation Sound 40 - 41, 155

P

PC Connection Mode 147, 154
 Photo Effect 83
 Play 105
 Portrait Mode (P) 56
 Program AE (P) 67
 Protect 118, 150
 Printing 122, 129, 140
 Settings 131
 Selecting Images 135
 Print Style 137
 Resetting 139
 Power/Mode Indicator 24
 Power On/Off 24 - 25
 Power Saving 25, 151

R

RAW File Format 47, 52
 Recording File Format 47, 52
 Red-Eye Reduction Function 54
 Replay
 Index Replay 107
 Jumping 108
 LCD Monitor 28
 Magnifying Images 106
 Movies 109
 Rotating 112
 Single Image Replay 105
 Slide Show 114
 Switching from Shooting Mode 26
 TV 144
 Volume 152
 Resolution 49
 Resetting the settings to default 157
 Rotate 112

S

Saturation 83
 Self-Timer 64
 Sound 40 - 41, 156
 Sharpness 83
 Shooting 24, 26, 33
 Checking Images 47
 Switching from Replaying Mode 26
 TV Set 144
 Shooting Mode 180
 Dial 13
 Functions Available 180
 Shutter
 Sound 40 - 41, 156
 Shutter Speed Priority AE (Tv) 69
 Speed 67, 69, 71, 73
 Volume 152
 Shutter Button 33
 Pressing Halfway 33
 Pressing Fully 33
 Single Image Replay 105
 Slide Show 114, 150
 Play Time 116
 Repeat 116
 Selecting Images 115
 Starting 114
 Slow Shutter 58
 Soft Case 20
 Sound Annotations 113
 Speaker 10
 Specifications 170 - 175
 Spot Light Metering 77
 Start-up
 Image 24, 40 - 41, 155

Sound 24, 40 - 41, 155
Stitch Assist Mode (□) 59
 Framing Subjects 59
 Shooting 60
Strap 11

T

Telephoto 35
Transfer Order
 Reset 142
 Selecting Images 142
Troubleshooting 167 - 169

V

Video System 144, 154
Viewfinder
 LCD Monitor 12, 28
 Optical 11, 32
Volume
 Replay 152
 Shooting 152

W

WAVE Files 30, 44, 113
White Balance 80
Wide Angle 35

Z

Zoom 35, 65, 106

FCC Notice

Digital Camera, Model PC1048

This device complies with Part 15 of the FCC Rules. Operation is subject to the following two conditions;

- (1) this device may not cause harmful interference, and
- (2) this device must accept any interference received, including interference that may cause undesired operation.

Note: This equipment has been tested and found to comply with the limits for Class B digital devices, pursuant to Part 15 of the FCC rules. These limits are designed to provide reasonable protection against harmful interference in a residential installation. This equipment generates, uses and can radiate radio frequency energy and, if not installed and used in accordance with the instructions, may cause harmful interference to radio communications. However, there is no guarantee that interference will not occur in a particular installation. If this equipment does cause harmful interference to radio or television reception, which can be determined by turning the equipment off and on, the user is encouraged to try to correct the interference by one or more of the following measures:

- Reorient or relocate the receiving antenna.
- Increase the separation between the equipment and receiver.
- Connect the equipment into an outlet on a circuit different from that to which the receiver is connected.
- Consult the dealer or an experienced radio/TV technician for help.

The cables with the ferrite core provided with the digital camera must be used with this equipment in order to comply with Class B limits in subpart B of Part 15 on FCC rules.

Do not make any changes or modifications to the equipment unless otherwise specified in the manual. If such changes or modifications should be made, you could be required to stop operation of the equipment.

Canon U.S.A. Inc.

One Canon Plaza, Lake Success, NY 11042, U.S.A.

Tel No. (516) 328-5600

Canadian Radio Interference Regulations

THIS CLASS B DIGITAL APPARATUS MEETS ALL REQUIREMENTS OF THE CANADIAN INTERFERENCE CAUSING EQUIPMENT REGULATIONS.

Réglementation canadienne sur les interférences radio

CET APPAREIL NUMERIQUE DE LA CLASSE B RESPECTE TOUTES LES EXIGENCES DU REGLEMENT SUR LE MATERIEL BROUILLEUR DU CANADA.

Functions Available in Each Shooting Mode

This chart shows the functions available in each shooting mode.
You can shoot with the settings saved in the **C** mode.

		AUTO								P	Tv	Av	M	Reference Page
Resolution	Large L	●*	●*	●*	●*	●*	●*	▲*	–	●*	●*	●*	●*	49
	Medium 1 M1	●	●	●	●	●	●	▲	–	●	●	●	●	
	Medium 2 M2	●	●	●	●	●	●	▲	–	●	●	●	●	
	Small S	●	●	●	●	●	●	▲	–	●	●	●	●	
Resolution	Movie	–	–	–	–	–	–	–	●*	–	–	–	–	49
	Movie	–	–	–	–	–	–	–	●	–	–	–	–	
Compression	Superfine S	●	●	●	●	●	●	▲	–	●	●	●	●	49
	Fine	●*	●*	●*	●*	●*	●*	▲*	–	●*	●*	●*	●*	
	Normal	●	●	●	●	●	●	▲	–	●	●	●	●	
File Format	JPEG	●	●	●	●	●	●	●	–	●*	●*	●*	●*	52
	RAW RAW	–	–	–	–	–	–	–	–	●	●	●	●	
Flash	Auto	●*	●*	●	●*	●*	●	–	–	●	–	–	–	54
	On	–	●	●	●	●	●	▲	–	●	●	●	●	
	Off	●	●	●*	●	●	●*	▲*	–	●*	●*	●*	●*	
Red-eye reduction, Flash On		●	●	●	●	●	●	▲	–	●	●	●	●	54
Slow Synchro	On	–	–	●	●	–	●	▲	–	●	–	●	–	55
	Off	●	●	–	–	●	–	▲*	–	●*	●*	●*	●*	
Flash Adjust	Auto	●	●	●	●	●	●	●	–	●	●*	●*	–	93
	Manual	–	–	–	–	–	–	–	–	–	●	●	●	
Flash Sync	1st-curtain	●	●	●	●	●	–	●	–	●*	●*	●*	●*	95
	2nd-curtain	–	–	–	–	–	●	–	–	●	●	●	●	
AF-assist Beam		●	●	●	●	●	●	▲	●	●	●	●	●	149
Drive Mode	Single Shot	●*	●*	●*	●*	●*	●*	▲*	●*	●*	●*	●*	●*	–
	Normal Continuous Mode	–	●	●	●	●	●	–	–	●	●	●	●	66
	High Speed Continuous Mode	–	●	●	●	●	●	–	–	●	●	●	●	
	Self-Timer (10 sec.)	●	●	●	●	●	●	▲	●	●	●	●	●	64
	Self-Timer (2 sec.)	●	●	●	●	●	●	▲	●	●	●	●	●	
Intervalometer		–	–	–	–	–	–	–	–	●	●	●	●	96