

Panasonic

Compact Plain Paper Fax
with Answering System

Operating Instructions

Model No. **KX-FP155**



FOR FAX ADVANTAGE ASSISTANCE:

- CALL
1-800-HELP-FAX (1-800-435-7329)
- E-MAIL TO
consumerproducts@panasonic.com
for customers in the U.S.A. or Puerto Rico
- REFER TO
www.panasonic.com
for customers in the U.S.A. or Puerto Rico

Please read these Operating Instructions before using the unit and save for future reference.

This model is designed to be used only in the U.S.A.

Thank you for purchasing a Panasonic facsimile.

Things you should keep a record of

Attach your sales receipt here

For your future reference

Date of purchase

Serial number

(found on the rear of the unit)

Dealer's name and address

Dealer's telephone number

Caution:

- The Telephone Protection Act of 1991 requires the following information to be clearly stated either at the top or bottom margin of the first message page when transmitting messages via telephone facsimile:
 - date and time of transmission,
 - identification of the business, entity or person(s) sending the facsimile, and
 - telephone number of the business, entity or person(s).To program this information into your unit, complete all the instructions on pages 15 to 18.
- Note that the images of copied or received documents will remain on the used ink film. Use discretion when disposing of the used ink film.
- Do not rub or use an eraser on the printed side of recording paper, as the print may smear.

Energy Star

As an ENERGY STAR® Partner, Panasonic has determined that this product meets the ENERGY STAR® guidelines for energy efficiency. ENERGY STAR is a U.S. registered mark.



Copyright:

This manual is copyrighted by Kyushu Matsushita Electric Co., Ltd. (KME) and its licensee. Under the copyright laws, this manual may not be reproduced in any form, in whole or part, without the prior written consent of KME and its licensee.

© Kyushu Matsushita Electric Co., Ltd. 2001

Trademarks

Hammermill® is a registered trademark of INTERNATIONAL PAPER in the United States and/or other countries.

All other trademarks identified herein are the property of their respective owners.

Important safety instructions

When using this unit, basic safety precautions should always be followed to reduce the risk of fire, electric shock, or personal injury.

1. Read and understand all instructions.
2. Follow all warnings and instructions marked on this unit.
3. Unplug this unit from power outlets before cleaning. Do not use liquid or aerosol cleaners. Use a damp cloth for cleaning.
4. Do not use this unit near water, for example near a bathtub, wash bowl, kitchen sink, or the like.
5. Place the unit securely on a stable surface. Serious damage and/or injury may result if the unit falls.
6. Do not cover slots and openings on the unit. They are provided for ventilation and protection against overheating. Never place the unit near radiators, or in a place where proper ventilation is not provided.
7. Use only the power source marked on the unit. If you are not sure of the type of power supplied to your home, consult your dealer or local power company.
8. For safety purposes this unit is equipped with a grounded plug. If you do not have this type of outlet, please have one installed. Do not use any type of adaptor plug to defeat this safety feature.
9. Do not place objects on the power cord. Install the unit where no one can step or trip on the cord.
10. Do not overload wall outlets and extension cords. This can result in the risk of fire or electric shock.
11. Never push any objects through slots in this unit. This may result in the risk of fire or electric shock. Never spill any liquid on the unit.
12. To reduce the risk of electric shock, do not disassemble this unit. Take the unit to an authorized service center when service is required. Opening or removing covers may expose you to dangerous voltages or other risks. Incorrect reassembly can cause electric shock when the unit is subsequently used.
13. Unplug this unit from the wall outlet and refer servicing to an authorized service center when the following conditions occur:
 - A. When the power supply cord or plug is damaged or frayed.
 - B. If liquid has been spilled into the unit.
 - C. If the unit has been exposed to rain or water.
 - D. If the unit does not work normally by following the operating instructions. Adjust only controls covered by the operating instructions. Improper adjustment may require extensive work by an authorized service center.
 - E. If the unit has been dropped or physically damaged.
 - F. If the unit exhibits a distinct change in performance.
14. During thunderstorms, avoid using telephones except cordless types. There may be a remote risk of an electric shock from lightning.
15. Do not use this unit to report a gas leak, when in the vicinity of the leak.

SAVE THESE INSTRUCTIONS

INSTALLATION:

- Never install telephone wiring during a lightning storm.
- Never install telephone jacks in wet locations unless the jack is specifically designed for wet locations.
- Never touch uninsulated telephone wires or terminals unless the telephone line has been disconnected at the network interface.
- Use caution when installing or modifying telephone lines.

WARNING:

- To prevent the risk of fire or electrical shock, do not expose this product to rain or any type of moisture.

OTHER INFORMATION:

- Keep the unit away from electrical noise generating devices, such as fluorescent lamps and motors.
- The unit should be kept free from dust, high temperature and vibration.
- The unit should not be exposed to direct sunlight.
- Do not place heavy objects on top of this unit.
- Do not touch the plug with wet hands.

Table of Contents

Initial Preparation

Accessories	Included accessories	6
	Accessory information	6
Help Button	Help function	7
Finding the Controls	Overview	8
	Location	9
Setup	Ink film – installing / replacing	10
	Paper tray	12
	Recording paper	13
	Connections	14
	Date and time, your logo and facsimile telephone number	15
Volumes	Adjusting volumes	19

Telephone

NAVIGATOR Directory	Storing names and telephone numbers in the directory	20
	Editing and erasing a stored station	21
	Making a phone call using the directory	22
Caller ID	Caller ID service from your phone company	23
	Viewing and calling back using caller information	24
	Confirming caller information using the Caller ID list	25
	Storing caller information in the directory	26
Voice Contact	Talking to the other party after fax transmission or reception	27

Fax

Sending Faxes	Sending a fax manually	28
	Sending a fax using the directory	29
	Sending a fax with the voice guide	30
	Documents you can send	30
	Reports for confirmation	31
	One time broadcast transmission	32
	Broadcast transmission to pre-programmed parties	33
Receiving Faxes	Setting the unit to receive faxes	36
	TEL mode (answering all calls manually)	38
	FAX ONLY mode (all calls are received as faxes)	39
	TEL/FAX mode (receiving phone calls with ring signals and faxes without ring signals when you are near the unit)	40
	Using the unit with a computer	42
	Extension telephone	42
	Pager call - when the unit receives a fax or voice message	43

Copy

Copying	Making a copy	44
	Convenient way to make a copy	44

Answering Device

Setup	TAD/FAX mode (using the built-in answering device and receiving phone calls and faxes automatically)	47
Greeting	Recording your own greeting messages	48
	Erasing your own recorded greeting messages	49
Incoming Messages	Listening to recorded messages	50
Recording	Memo message (leaving a message for others or yourself)	51
	Telephone conversation	51
Voice Mailbox	Voice mailbox (how callers can leave you private messages)	52
Remote Operation	Operating from a remote location	55
	Operation from a remote touch tone telephone	56
Option	Transferring recorded messages to another telephone	59

Programmable Features

Features	Programming	61
Summary	Basic features	62
	Advanced features	64

Help





Error Messages	Reports	70
	Display	71
Operations	When a function does not work, check here before requesting help	73
	If a power failure occurs	77
Jams	Recording paper jam	78
	Document jams – sending	79
Cleaning	Document feeder	80
	Thermal head	80

General Information

Printed Reports	Reference lists and reports	81
FCC Information	List of FCC requirements and information	82
Limited Warranty	PANASONIC Facsimile Products Limited Warranty	83
Servicenter Directory	Servicenter directory	84
Specifications	Technical data about this product	85
Index	Index	86

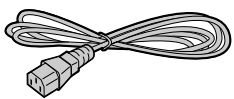
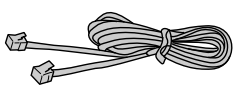
Accessories

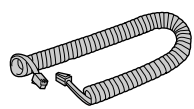
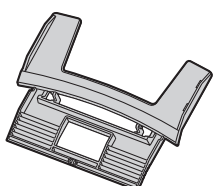
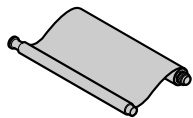
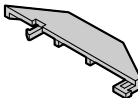
Included accessories

Power cord.....1  Part No. PFJA1030Z	Telephone line cord...1  Part No. PQJA10075Z	Handset.....1  Part No. PFJXE0805Z	Handset cord.....1  Part No. PFJA1029Z
Paper tray1  Part No. PFKS1056Z1	Ink film.....1 (included film roll) 	A4 paper guide1  Part No. PFZMFP155M	Operating instructions1  Part No. PFQX1562X

- If any item is missing or damaged, check with the place of purchase.
- The part numbers listed above are subject to change without notice.
- Save the original carton and packing materials for future shipping and transportation of the unit.

Accessory information

- The included film roll is 10 meters (32½') long. We recommend that you buy full size replacement film – 50 meters (164') for continuous use of your unit. For best results, use genuine Panasonic replacement film Model No. KX-FA53 or KX-FA55.
- To install legal size recording paper, use a legal paper tray Model No. KX-FA50 (p. 12).

Model No.	Item	Specifications / Usage
KX-FA53	Replacement film	1 roll – 216 mm x 50 m (8½" x 164')
KX-FA55	Replacement film	2 rolls – 216 mm x 50 m (8½" x 164')
KX-FA50	Legal paper tray	To install legal size recording paper.

- **The ink film is not reusable. Do not rewind and use the ink film again.**
- To place an order:
 - Telephone:** Call 1-800-332-5368.
 - Fax:** Send a fax to 1-800-237-9080.
 Include: —your name, shipping address and telephone number,
 —credit card type, number, expiration date and your signature,
 —order part number and quantity.
 - Internet:** Visit our web site: <http://www.panasonic.com/store>
 (for customers in the U.S.A. or Puerto Rico ONLY)
- If you have any questions about internet orders, please contact us at:
 - E-mail:** panasonicdirect@panasonic.com
 - Telephone:** 1-201-348-7292

Help function

You can print a quick reference for assistance as follows.

1 Press **HELP**.

Display:

PRESS NAVI. [◀▶] & SET

2 Press **◀** or **▶** until the desired item is displayed.

1. How to send faxes with the voice guide.

SEND GUIDE PRESS SET

2. How to set the date, time, your logo and fax number.

QUICK SET UP PRESS SET

3. How to program the features.

FEATURE LIST PRESS SET

4. How to store names in the directory and how to dial them.

DIRECTORY PRESS SET

5. Help with problems operating the answering device.

TAD OPERATION PRESS SET

6. Help with problems sending/receiving faxes.

FAX SND/RCV PRESS SET

7. How to use the copier function.

COPIER PRESS SET

8. Frequently asked questions and answers.

Q and A PRESS SET

9. Explanation of error messages shown on the display.

ERRORS PRESS SET

10. List of available reports.

REPORTS PRESS SET

11. How to use the Caller ID service.

CALLER ID PRESS SET

3 Press **SET**.

PRINTING

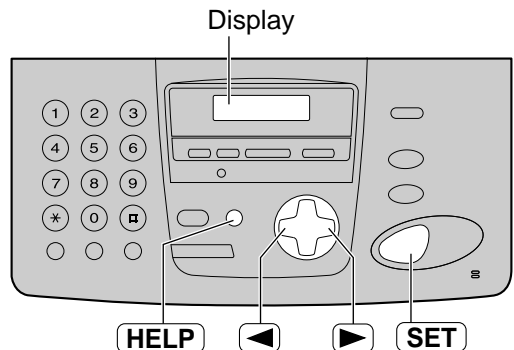

Finding the Controls

Overview

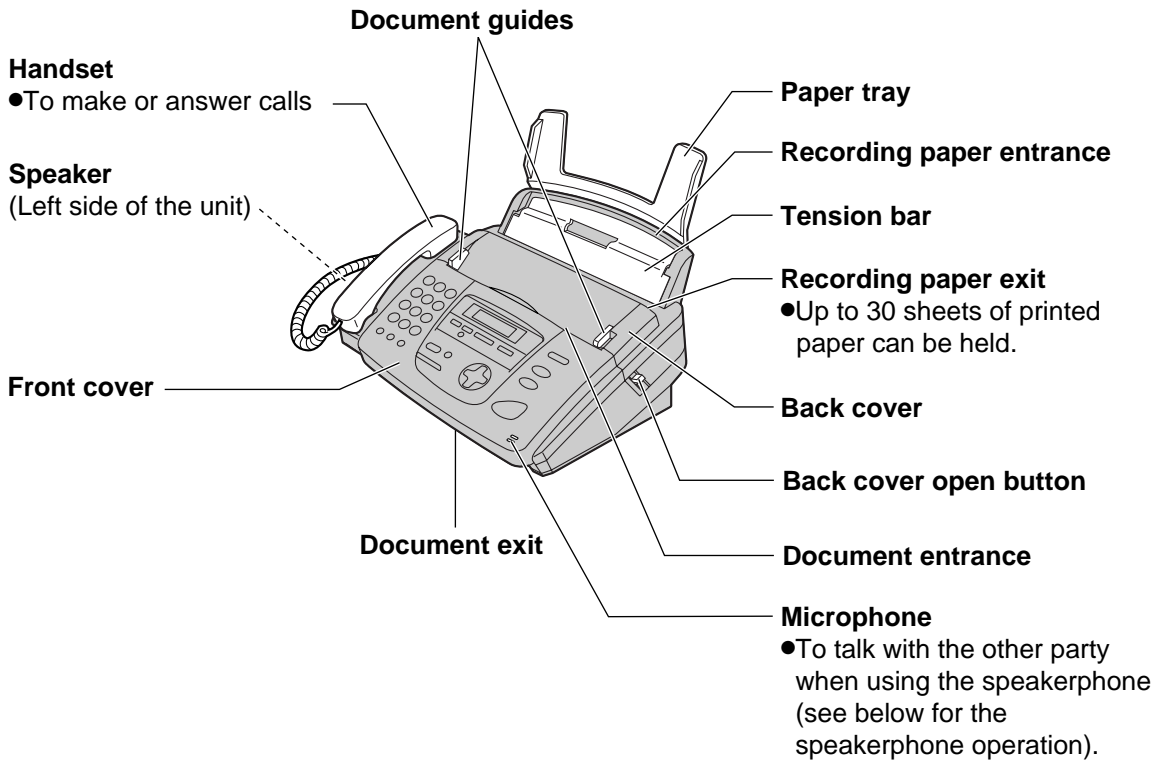

Note:

- The document will be ejected from the front of the unit. Install the unit on a desk or floor with a smooth surface and do not place anything in front of the unit.

Speakerphone operation

- Use the speakerphone in a quiet room.
- Adjust the speakerphone volume using **+** or **-**.
- To switch to the handset, lift the handset. To switch back to the speakerphone, press **DIGITAL SP-PHONE**.

Location

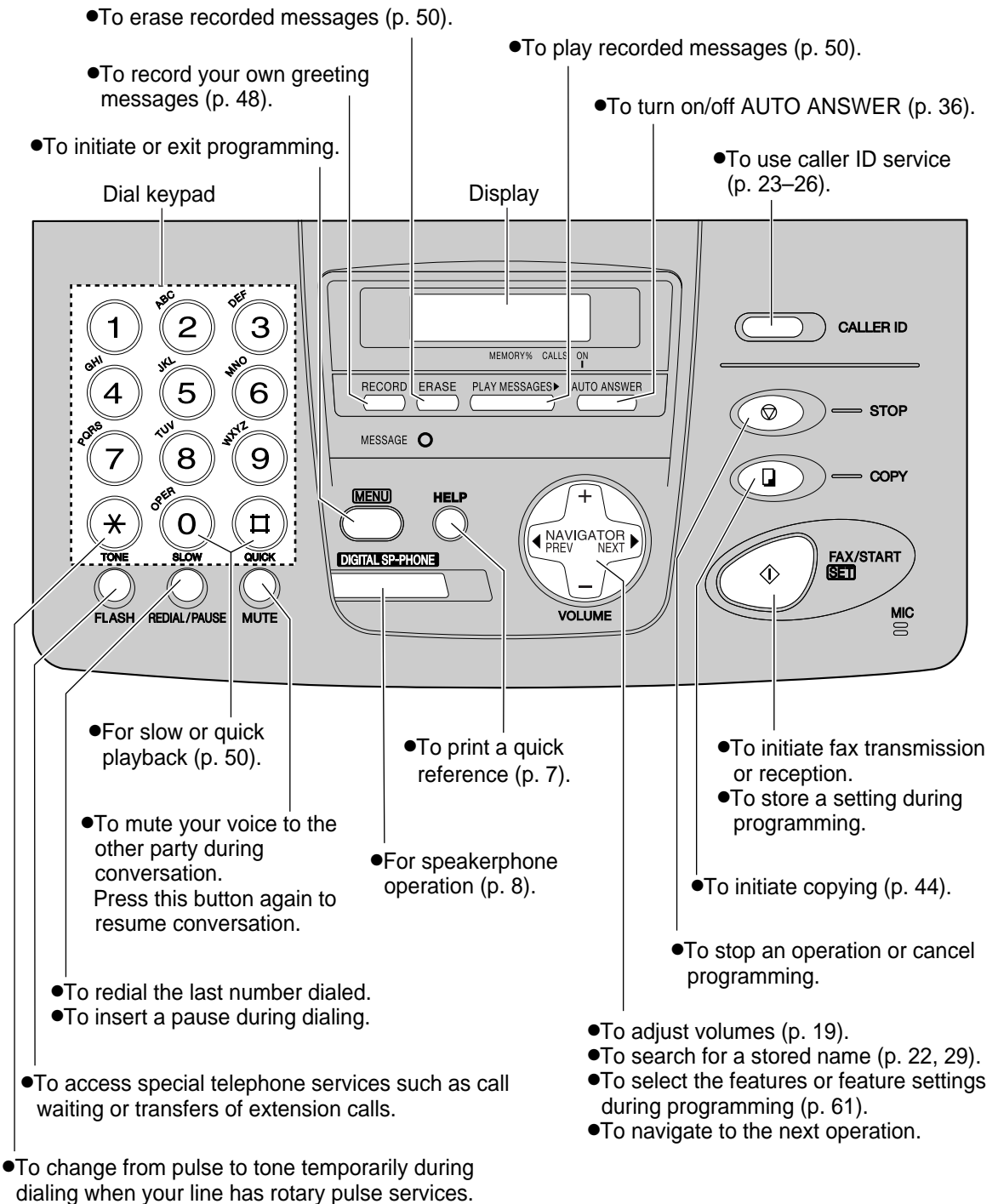

Setup

Ink film – installing / replacing

Install the included ink film or replace the used ink film with new one.

The following ink films are available for replacement. Each roll prints about 150 letter-size pages.

See page 6 for accessory information.

Model No. KX-FA53: Replacement film (1 roll)

Model No. KX-FA55: Replacement film (2 rolls)

- 1** Open the front cover by pulling up the center part.

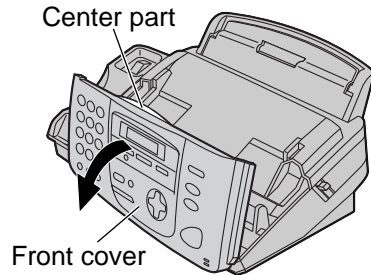

- 2** Push the back cover open button (green) on the right side of the unit.
OR
Push the back cover open lever (green) inside of the unit.

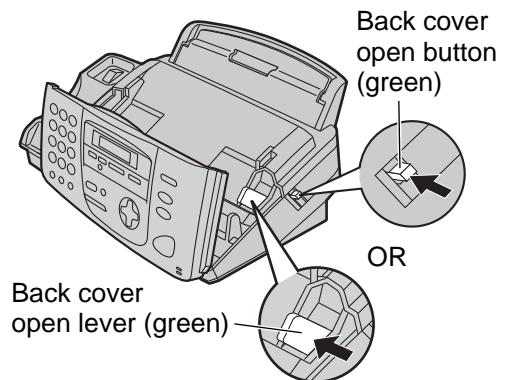

- 3** Open the back cover.
- If you install the included ink film, skip to step 6.

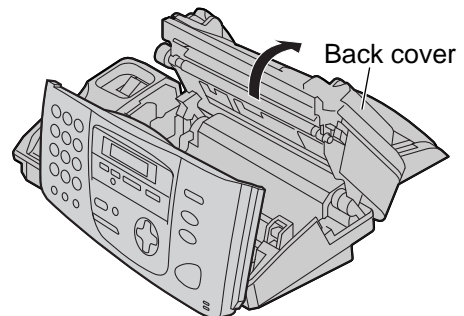

- 4** **For replacement only**
Pull out the blue gear and remove the used ink film. Remove the used core.

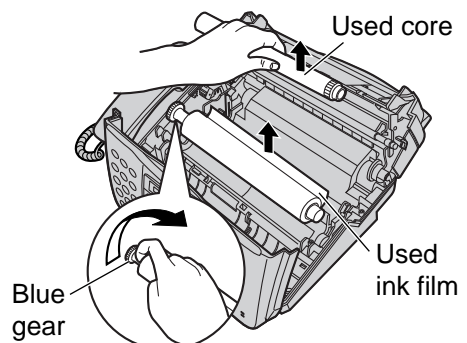

- 5 For replacement only**
Remove the stoppers and tags from the new ink film. Find the "T" shaped gear (blue).

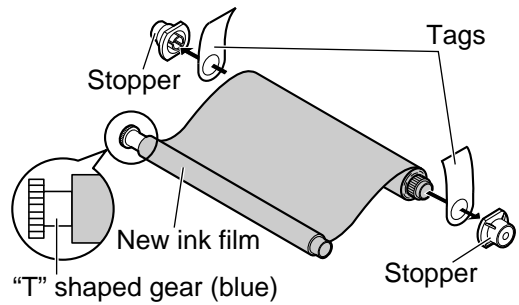

- 6** Insert the blue core of the front ink film roll into the right slot of the unit (①). Insert the "T" shaped gear (blue) into the left slot of the unit (②).
Insert the rear ink film roll (③).

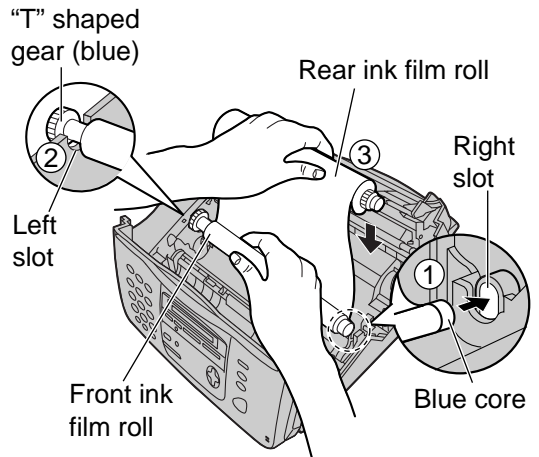

- 7** Turn the "T" shaped gear (blue) in the direction of the arrow.
 - Make sure that the ink film is wrapped around the blue core at least once.

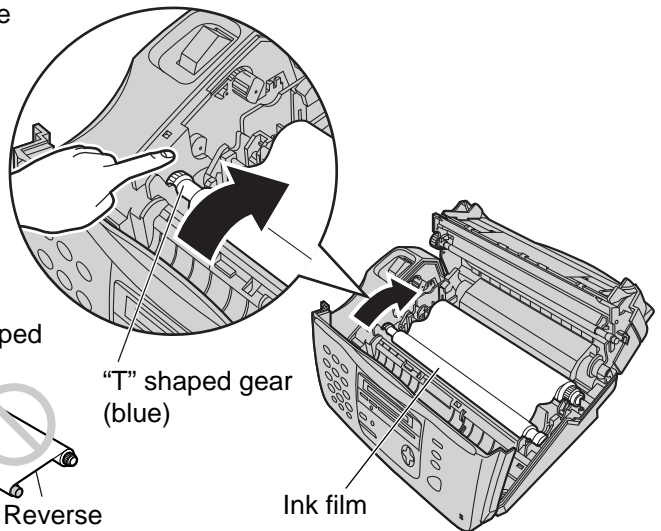
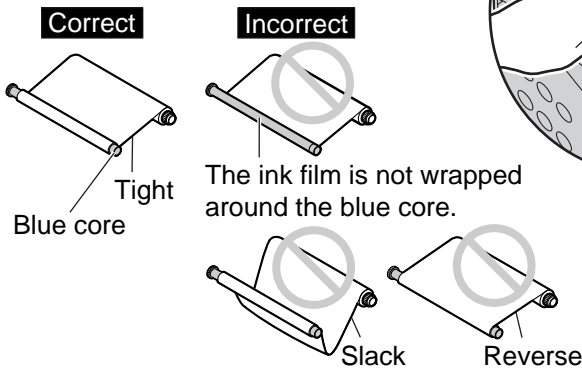

- 8** Close the back cover securely by pushing down on the dotted area at both ends (①). Close the front cover securely (②).
 - The following message will be displayed while the unit is checking that there is no slack in the ink film.

Display: PLEASE WAIT

Note:

- The ink film is completely safe to touch, and will not rub off on your hands like carbon paper.

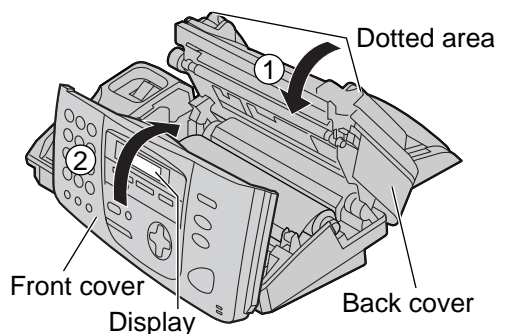

Setup

Paper tray

Insert tabs on the paper tray into slits on the back of the unit.

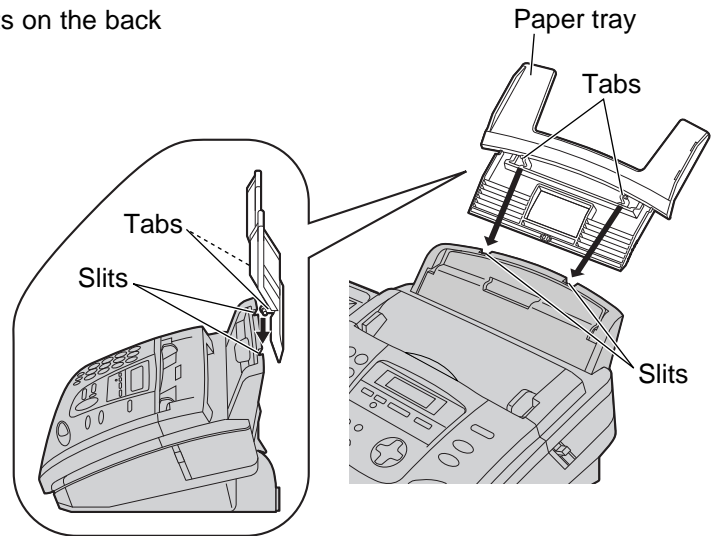

Note:

- Do not place the unit in areas where the paper tray may be obstructed by a wall, etc.

To use legal size paper

- Please purchase a legal paper tray, Model No. KX-FA50 (p. 6) and install as shown above.

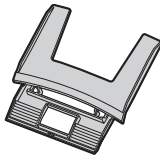

KX-FA50
Legal paper tray

To use A4 size paper

You need to install the A4 paper guide to the right side of the paper tray.

1. Insert the bottom tab on the A4 paper guide into the lower slot.
2. Press the guide into the upper slot.

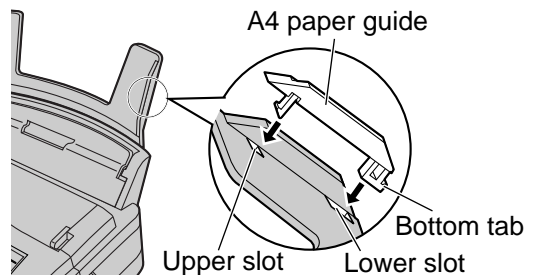

Recording paper

Letter, legal or A4 size recording paper can be loaded. The unit can hold up to 50 sheets of 60 g/m² to 75 g/m² (16 lb. to 20 lb.) paper or 30 sheets of 90 g/m² (24 lb.) paper. Set the recording paper size (feature #16 on page 63) according to the paper size you use, after connecting the unit (p. 14).

–**To use legal size paper**, please install an optional legal paper tray, Model No. KX-FA50 (p. 6, 12).

–**To use A4 size paper**, install the included A4 paper guide to the paper tray (p. 12).

For best results, only use inkjet paper such as Hammermill® Jet Print. If you use other types of paper, the print quality may be affected.

- 1** Fan the stack of paper to prevent a paper jam.
- 2** Pull the tension bar forward and hold open while inserting the paper.
 - The paper should not be over the tab.
 - If the paper is not inserted correctly, readjust the paper, or the paper may jam.

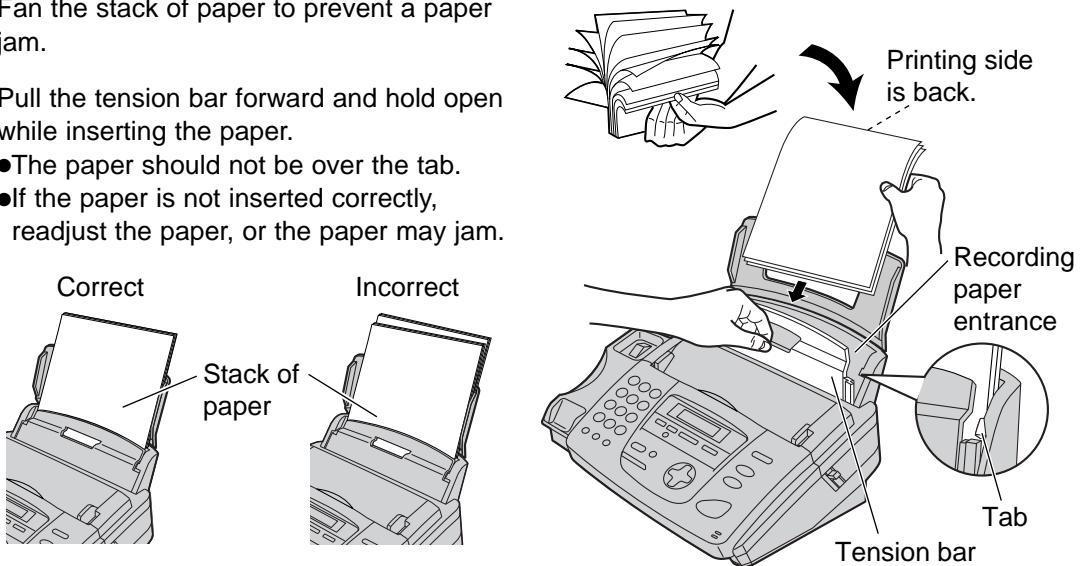

Note for recording paper:

- Avoid using paper with a cotton and/or fiber content that is over 20%, such as letterhead paper or paper used for resumes.
- Do not use different types or thicknesses of paper at the same time. This may cause a paper jam.
- Avoid extremely smooth or shiny paper that is highly textured.
- Avoid paper that is coated, damaged or wrinkled.

Note:

- Avoid double-sided printing.
- Do not use paper printed from this unit for double-sided printing with other copiers or printers, or the paper may jam.
- Some paper only accepts print on one side. Try using the other side of paper if you are not happy with the print quality.

Adding paper

1. Pull the tension bar forward and hold open while removing all of the installed paper.
2. Add paper to the removed paper and straighten.
3. Fan the stack of paper.
4. Pull the tension bar forward and hold open while inserting the paper.

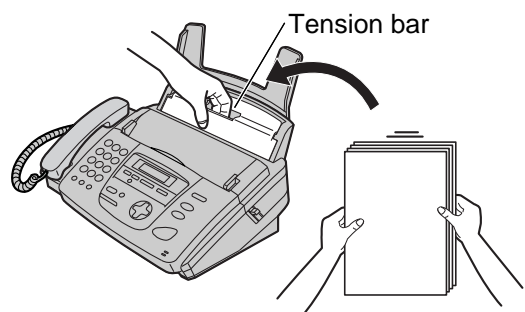

Setup

Connections

- 1 Connect the handset cord.
- 2 Connect the telephone line cord.
- 3 Connect the power cord.

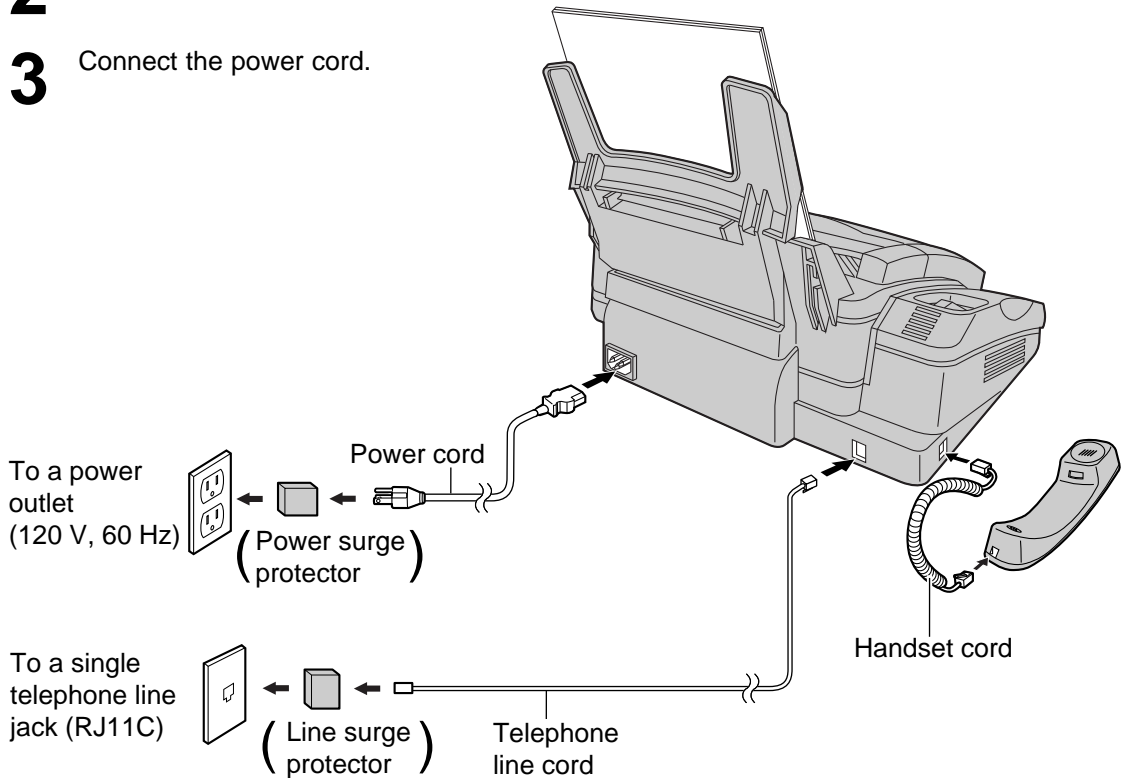

Caution:

- When you operate this product, the power outlet should be near the product and easily accessible.

Note:

- For additional equipment protection, we recommend you use a surge protector. The following types are available: TELESPIKE BLOK MODEL TSB (TRIPPE MFG. CO.), SPIKE BLOK MODEL SK6-0 (TRIPPE MFG. CO.), SUPER MAX (PANAMAX) or MP1 (ITW LINX).
The warranty does not cover damage due to power line surges or lightning.

Date and time, your logo and facsimile telephone number

You should program the date and time, your logo and facsimile telephone number. This information will be printed on each page transmitted from your unit.

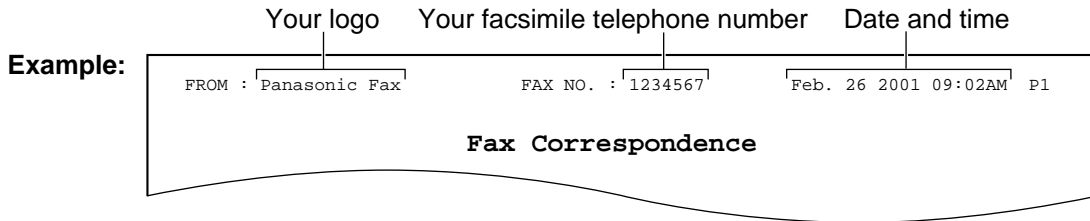

Setting the date and time

1 Press **MENU**.

Display: SYSTEM SET UP
PRESS NAVI. [◀ ▶]

2 Press **◀** or **▶** until the following is displayed.

SET DATE & TIME
PRESS SET

3 Press **SET**.

Cursor
Example: M:01/D:01/Y:01
TIME: 12:00AM

4 Enter the correct month/day/year by selecting 2 digits for each, using the dial keypad.

Example: Aug. 10, 2001

Press **081001**.

M:08/D:10/Y:01
TIME: 12:00AM

5 Enter the correct hour/minute by selecting 2 digits for each, using the dial keypad.

Press ***** to select "AM" or "PM".

Example: 3:15PM

1. Press **0315**.

M:08/D:10/Y:01
TIME: 03:15AM

2. Press ***** until "PM" is displayed.

M:08/D:10/Y:01
TIME: 03:15PM

6 Press **SET**.
•The next feature will be displayed.

YOUR LOGO
PRESS SET

7 Press **MENU**.

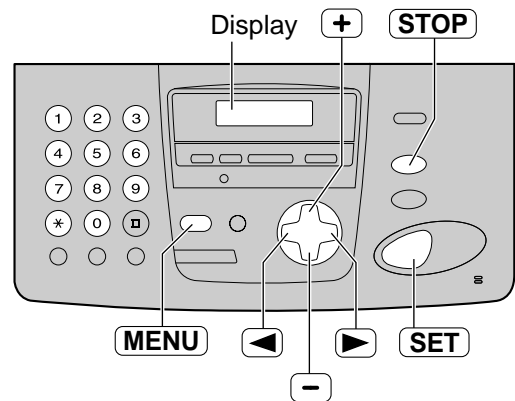

Note:

- You can enter the number by pressing **+** or **-** in steps 4 and 5. In this case, press **▶** to move the cursor.
- The accuracy of the clock is approximately ± 60 seconds a month.

To correct a mistake

- Press **◀** or **▶** to move the cursor to the incorrect number, and make the correction.
- If you press **STOP** while programming, the display will return to the previous one.

Setup

Setting your logo

The logo can be your company, division or name.

1 Press **MENU**.

Display: SYSTEM SET UP
PRESS NAVI. [◀ ▶]

2 Press **◀** or **▶** until the following is displayed.

YOUR LOGO
PRESS SET

3 Press **SET**.

LOGO=

4 Enter your logo, up to 30 characters, using the dial keypad. See the next page for details.

Example: "Bill"

1. Press **2** twice.

Cursor
LOGO=**B**

2. Press **4** six times.

LOGO=Bi

3. Press **5** six times.

LOGO=Bi1

4. Press **▶** to move the cursor to the next space and press **5** six times.

LOGO=Bill

5 Press **SET**.
•The next feature will be displayed.

YOUR FAX NO.
PRESS SET

6 Press **MENU**.

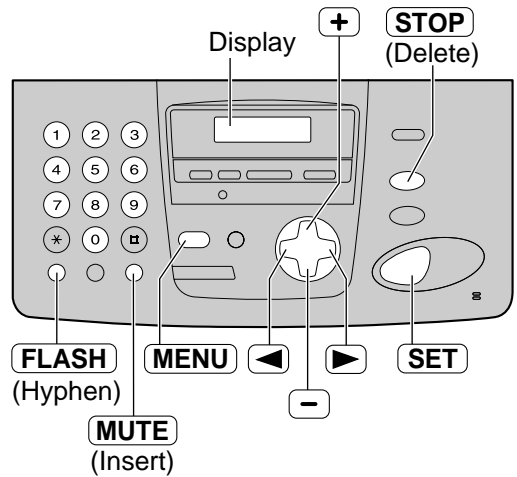

Note:

- You can enter your logo by pressing **+** or **-** (see the next page) in step 4. In this case, press **▶** to move the cursor.

To correct a mistake

- Press **◀** or **▶** to move the cursor to the incorrect character, and make the correction.

To delete a character



- Move the cursor to the character you want to delete and press **STOP**.

To insert a character

1. Press **◀** or **▶** to move the cursor to the position to the right of where you want to insert the character.
2. Press **MUTE** (Insert) to insert a space and enter the character.

To select characters with the dial keypad

Pressing the dial keys will select a character as shown below.

Keys	Characters
①	1 [] { } + - / = , . _ ` : ; ?
②	A B C a b c 2
③	D E F d e f 3
④	G H I g h i 4
⑤	J K L j k l 5
⑥	M N O m n o 6
⑦	P Q R S p q r s 7
⑧	T U V t u v 8
⑨	W X Y Z w x y z 9
⑩	0 () < > ! " # \$ % & ¥ * @ ^ ' →
FLASH	Hyphen button (To insert a hyphen.)
MUTE	Insert button (To insert one character or one space.)
STOP	Delete button (To delete a character.)
	▶ key (To move the cursor to the right.) To enter another character using the same number key, move the cursor to the next space.
	◀ key (To move the cursor to the left.)

To select characters using **+** or **-**

Instead of pressing the dial keys, you can select characters using **+** or **-**.

1. Press **+** or **-** until the desired character is displayed.
2. Press  to move the cursor to the next space.
 - The character displayed in step 1 is inserted.
3. Return to step 1 to enter the next character.

Display order of characters

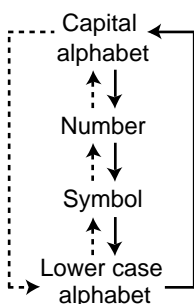

→ : Pressing **+**

---> : Pressing **-**

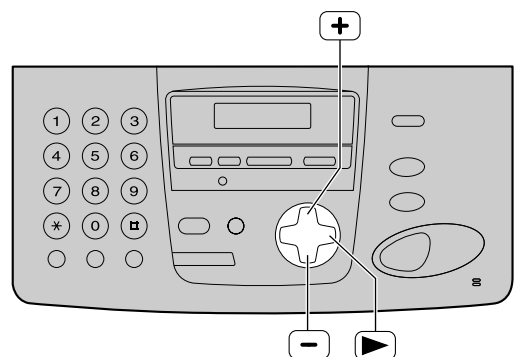

Setup

Setting your facsimile telephone number

1 Press **MENU**.

Display: SYSTEM SET UP
PRESS NAVI. [◀ ▶]

2 Press **◀** or **▶** until the following is displayed.

YOUR FAX NO.
PRESS SET

3 Press **SET**.

NO. =

4 Enter your facsimile telephone number, up to 20 digits, using the dial keypad.

Example: NO. = 1234567

5 Press **SET**.
•The next feature will be displayed.

SENDING REPORT
MODE=ERROR [±]

6 Press **MENU**.

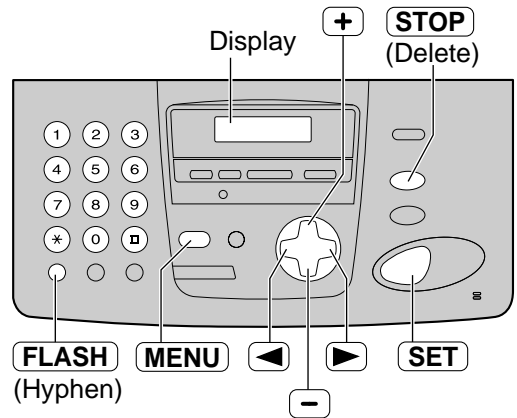

Note:

- You can enter your facsimile telephone number by pressing **+** or **-**. If you use **+** or **-**, press **▶** to move the cursor.
- The ***** button replaces the digit with a "+" and the **▣** button replaces it with a space.

Example (using the dial keypad): +234 5678

Press *******2****3****4****▣****5****6****7****8**.

- To enter a hyphen in a telephone number, press **FLASH** (Hyphen).

To correct a mistake

- Press **◀** or **▶** to move the cursor to the incorrect number, and make the correction.

To delete a number

- Move the cursor to the number you want to delete and press **STOP**.

Adjusting volumes

Ringer volume

4 levels (high/middle/low/off) are available.

While the unit is idle, press **+** or **-**.

● If any documents are in the document entrance, you cannot adjust the ringer volume. Confirm that there are no documents in the entrance.

■ To turn the ringer off:

1. Press **-** repeatedly until the following is displayed.

Display:

RINGER OFF= OK? YES: SET/NO: STOP

2. Press **SET**.

● To turn the ringer back on, press **+**.

■ While the ringer volume is set to off:

The display will show the following message.

RINGER OFF

When a call is received, the unit will not ring and will display the following.

INCOMING CALL

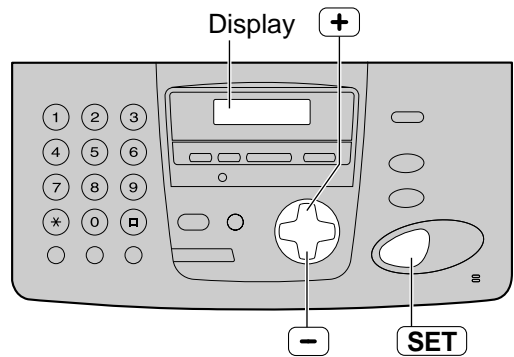

Ringer pattern

● You can select one of the three ringer patterns. Change the setting (feature #17 on page 63). The ringer pattern you selected will sound when the unit receives a call.

Handset receiver volume

5 levels (high to low) are available.

While using the handset, press **+** or **-**.

Speaker volume

8 levels (high to low) are available.

While using the speakerphone, press **+** or **-**.

Fax voice guidance volume

9 levels (high to off) are available.

While listening to the fax voice guidance, press **+** or **-**.

Answering device volume

9 levels (high to off) are available.

While listening to the recorded messages, press **+** or **-**.

Storing names and telephone numbers in the directory

For rapid access to frequently dialed numbers, the unit provides the NAVIGATOR directory (50 stations).

For your convenience, the following station has been pre-programmed.

HELP-FAX (1-800-435-7329): If you cannot correct a problem after trying the help function (p. 7), call using this station (p. 22).

• If you do not need the above station, you can erase it (p. 21).

1 Press **MENU** two times.

Display: `DIRECTORY SET
NAVI.=* BROAD=#`

2 Press ***** to select "NAVI."

`NAME=
STORE:PRESS SET`

3 Enter the name, up to 10 characters (see page 17 for instructions).

Example: `NAME=Alice
STORE:PRESS SET`

4 Press **SET**.

`NO.=`

5 Enter the telephone number, up to 30 digits, using the dial keypad.

Example: `NO.=5552233`

• If you want to enter a hyphen, press **FLASH**.

6 Press **SET**.

`REGISTERED`

↓
`NAME=
STORE:PRESS SET`

• To program other stations, repeat steps 3 to 6.

7 Press **MENU** to exit the program.

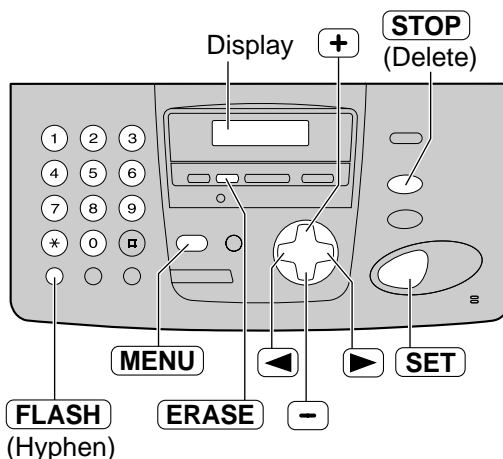

Helpful hint:

• You can confirm the stored stations on the telephone number list (p. 81).

Note:

• When the following message is displayed in step 6, you can store only 5 more stations.

Display: `REGISTERED
SPACE= 5 DIRS.`

• If there is no space to store new stations, the following message is displayed in step 6.

`REGISTERED
DIRECTORY FULL`

Press **STOP** to exit the program.

To store new stations, erase unnecessary stations (p. 21).

• A hyphen or a space entered in a telephone number counts as two digits.

To correct a mistake

• Press **◀** or **▶** to move the cursor to the incorrect character/number, and make the correction.

To delete a character/number

• Move the cursor to the character/number you want to delete, and press **STOP**.

Editing and erasing a stored station

Editing a stored station

1 Press **▶**.

Display: DIRECTORY[+ -]
<MAILBOX>▶

2 Press **+** or **-** until the desired station is displayed.

Example: Mary
0123456



Mary
EDIT:PRESS MENU

3 Press **MENU**.

NAME=Mary
EDIT=* DELETE=#

4 Press ***** to select "EDIT".

NAME=Mary
STORE:PRESS SET

●If you do not need to edit the name, skip to step 6.

5 Edit the name (see page 17 for instructions).

6 Press **SET**.

Example: NO.=0123456

●If you do not need to edit the telephone number, skip to step 8.

7 Edit the telephone number. For further details, see page 20.

8 Press **SET**.

REGISTERED

Erasing a stored station

1 Press **▶**.

Display: DIRECTORY[+ -]
<MAILBOX>▶

2 Press **+** or **-** until the desired station is displayed.

Example: Mary
0123456



Mary
EDIT:PRESS MENU

3 Press **MENU**.

NAME=Mary
EDIT=* DELETE=#

4 Press **#** to select "DELETE".

DELETE OK?
YES:SET/NO:STOP

●To cancel erasing, press **STOP**.

5 Press **SET**.

DELETED

●The stored name and number are deleted.

Note:

●You can use the following method to erase.

1. Press **▶**.

2. Press **+** or **-** until the desired station is displayed.

3. Press **ERASE**.

4. Press **SET**.



Making a phone call using the directory

Before using this feature, program the desired names and telephone numbers into the directory (p. 20).

1 Press .

Display:

DIRECTORY[+ -] <MAILBOX>▶

2 Press  or  until the desired station is displayed.

Example:

Lisa 2233445



Lisa EDIT:PRESS MENU

- If the desired name has not been stored, press **STOP** and dial the number manually.

3 Press **DIGITAL SP-PHONE** or lift the handset.

- The unit will start dialing automatically.

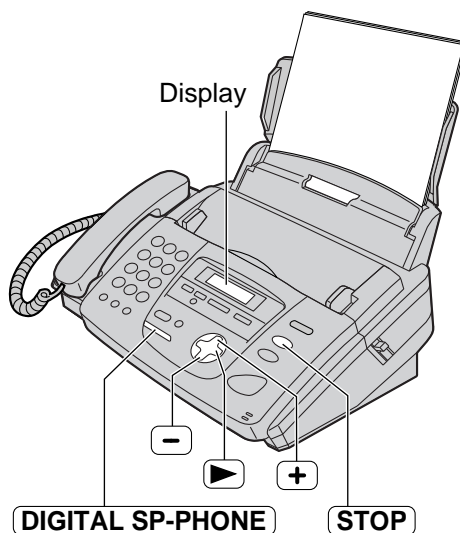



To search for a name by initial

Example: "Lisa"

1. Press .

Display:

DIRECTORY[+ -] <MAILBOX>▶

2. Press  or  until any name is displayed.

Example:

Alan 7891011



Alan EDIT:PRESS MENU

3. Press **5** repeatedly until any name with the initial "L" is displayed (see the character table on page 17).

Larry 12131415

4. Press  until "Lisa" is displayed.

Lisa 2233445

- To stop the search, press **STOP**.
- To make a call, press **DIGITAL SP-PHONE** or lift the handset.

Note:

- When you want to search for symbols (not letters or numbers), press  in step 3.

Caller ID service from your phone company

This unit is compatible with the Caller ID service offered by your local telephone company. To use this feature, you must subscribe to the Caller ID service.

Set the following ring count settings to 2 or more rings beforehand.

- TAD ring count and FAX ring count (feature #06 on page 62)
- TEL/FAX ring count (feature #78 on page 69)

How Caller ID is displayed

The calling party's name or telephone number will be displayed after the first ring.

You then have the option of whether or not to answer the call depending on the caller.

Example:

Chris Horner 1-654-987-3210

The unit will automatically store the caller information (name, telephone number and the time of the call). You can view the caller information (p. 24) and print the caller ID list (p. 81).

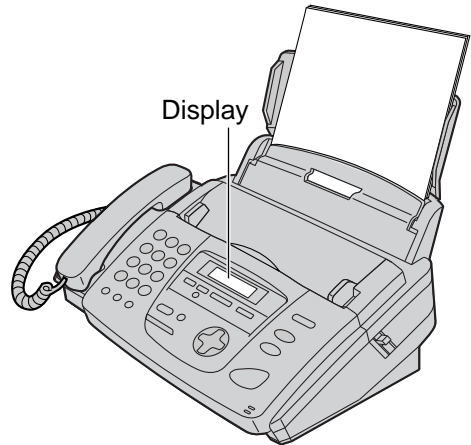

Note:

- If the unit is connected to a PBX (Private Branch Exchange) system, you may not receive the caller information. Consult your PBX supplier.
- If the unit cannot receive caller information, the unit will show the following.

OUT OF AREA

The caller dialed from an area which does not provide Caller ID service.

PRIVATE CALLER

The caller requested not to send caller information.

LONG DISTANCE

The caller made a long distance call.

Viewing and calling back using caller information

You can easily view caller information and call back.

Important:

- Calling back will not be possible in the following cases.
 - The telephone number includes data other than numbers (i.e. * or #).
 - The caller information does not include a telephone number.

1 Press **CALLER ID**.

Example (2 new calls are received):

Example:

2 NEW CALLS PRESS NAVI. [+ -]

2 Press **+** or **-** to view caller information.

- If you press **+**, the display will show the most recent caller's name.
- If you press **-**, the display will show the already viewed calls.

3 Press **DIGITAL SP-PHONE** or lift the handset to make a call.

- The unit will start dialing automatically.
- To send a fax – insert the document FACE DOWN and press **FAX/START**.

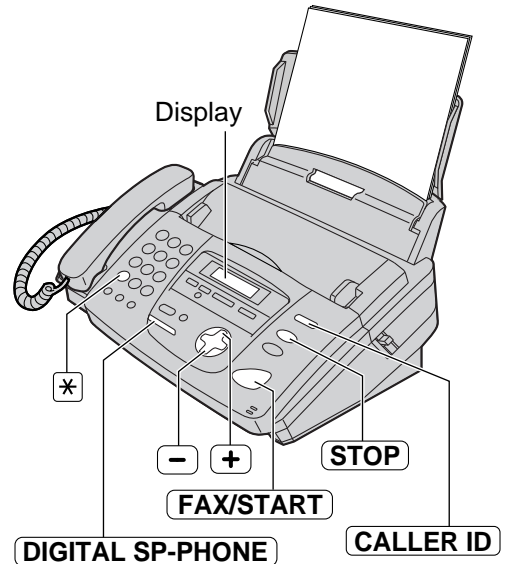

To display the caller's telephone number

Press **CALLER ID** after step 2.

Example:

WENDY ROBERTS 11:20A Jul20	↔	1-345-678-9012 11:20A Jul20 ✓
-------------------------------	---	----------------------------------

This means the caller has already been viewed or answered.

To edit the telephone number for calling back

Press ***** repeatedly after step 2.

Each time you press *****, the telephone number will be changed as follows.

1. **1** – **Area code** – **Local telephone number** ("1" added)
2. **Local telephone number** (area code omitted)
3. **Area code** – **Local telephone number**
4. **1** – **Local telephone number** ("1" added and area code omitted)

Display while viewing

NO NAME RCVD

 When the unit could not receive a name.

NO CALLER DATA

 When no calls have been received.

To stop viewing

Press **STOP** after step 2.

Confirming caller information using the Caller ID list

The unit will store the 30 most recent caller information.

—To print manually, see page 81.

—To print automatically after every 30 new calls, activate feature #26 (p. 64).

Sample of a Caller ID list

CALLER ID LIST				
Mar. 14 2001 11:37AM				
[NEW]				
NO.	NAME	TELEPHONE NUMBER	TIME OF CALL	ANSWER
01	WENDY ROBERTS	345-678-9012	Mar. 14 10:30AM	FAX
02	ALLAN STONE	456-789-0123	Mar. 13 08:35AM	TAD
[OLD]				
NO.	NAME	TELEPHONE NUMBER	TIME OF CALL	ANSWER
01	MIKE TIMAR	987-654-3210	Mar. 11 09:35AM	TEL

NEW: Shows a call you have not yet viewed.
 OLD: Shows a call you have already viewed.

FAX: Facsimile reception
 TAD: Telephone answering device responded.
 TEL: Telephone call received.
 (blank): Not answered.

Erasing the Caller ID list

1 Press **MENU** four times.

Display: CALLER SET UP
PRESS SET

2 Press **SET**.

CALL LIST ERASE
PRESS SET

3 Press **SET**.

ALL ERASE OK?
YES:SET/NO:STOP

•To cancel erasing, press **STOP**, then **MENU**.

4 Press **SET**.

ERASE COMPLETED

5 Press **STOP** to exit the program.

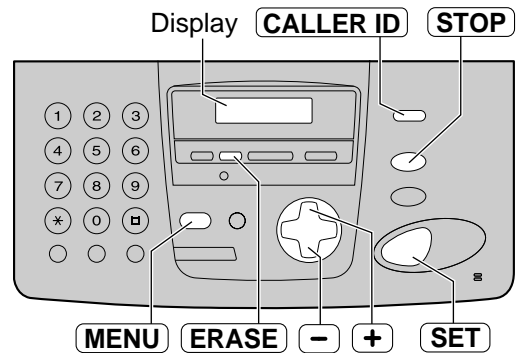

To erase specific caller information

1. Press **CALLER ID**.

Example: 2 NEW CALLS
PRESS NAVI.[+ -]

2. Press **+** or **-** until the desired station is displayed.

Example: WENDY ROBERTS
12:10A Jul20

3. Press **ERASE**.

•The caller information will be erased.

DELETED

Example: ALLAN STONE
12:12A Jul20

•To erase other items, repeat steps 2 and 3.

4. Press **STOP** to exit the program.

Storing caller information in the directory

Important:

- This feature is not available in the following cases.
 - The telephone number includes data other than numbers (i.e. * or #).
 - The caller information does not include a telephone number.

1 Press **CALLER ID** .

Example:

2 NEW CALLS PRESS NAVI. [+ -]

2 Press **+** or **-** until the name you want to store is displayed.

Example:

WENDY 11:50A Apr14

3 Press **MENU** .

NAME=WENDY STORE:PRESS SET

4 Press **SET** .

NO.=13456789012

5 Press **SET** .

REGISTERED

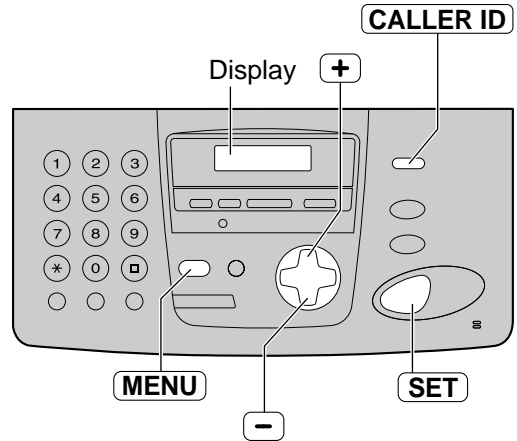

Note:

- You can confirm the stored items on the telephone number list (p. 81).
- You can only store a name of up to 10 characters long.
- To edit a name and number, see page 21.
- If the directory is full, you cannot store caller information.

Talking to the other party after fax transmission or reception

You can talk to the other party after a fax message is completed. This will save the added expense and time of making another call.

This feature only works when the other party's fax machine is equipped with a voice contact feature.

Initiating voice contact

- 1 Press **DIGITAL SP-PHONE** while transmitting or receiving documents.

Example:

SENDING P 1
VOICE STANDBY

- Your unit will call the other party with a distinctive ring.
- When the other party answers, your unit will emit a distinctive ring.

- 2 Press **DIGITAL SP-PHONE** or lift the handset to start talking.

Note:

- If you initiate voice contact during transmission, the unit will call you with a distinctive ring after all of the documents have been transmitted.
- If you initiate voice contact during reception, the unit will call you with a distinctive ring after the current page of the document is received.

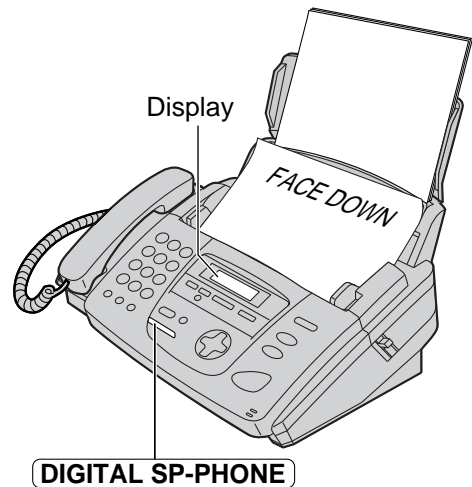

Receiving a request for voice contact

- 1 If the other party initiates voice contact, your unit will sound a distinctive ring and the following will be displayed.

Display:

PLEASE PICK UP

- 2 Press **DIGITAL SP-PHONE** or lift the handset within 10 seconds of the distinctive ring to start talking.

Note:

- If you do not answer within 10 seconds of the distinctive ring;
 - In TAD/FAX mode, your unit will play a greeting message and record an incoming voice message.
 - In FAX ONLY, TEL or TEL/FAX mode, the line will be disconnected.

Sending Faxes

Sending a fax manually

1 Adjust the width of the document guides to the size of the document.

2 Insert the document (up to 10 pages) **FACE DOWN** until a single beep is heard and the unit grabs the document.

Display: STANDARD
PRESS NAVI. [+ -]

3 If necessary, press **+** or **-** repeatedly to select the desired resolution (see below).

4 Press **DIGITAL SP-PHONE** or lift the handset.

TEL=
PRESS NAVI. [▶]

5 Dial the fax number.

Example: TEL=5678901

6 **When a fax tone is heard:**

Press **FAX/START**, and replace the handset if you are using it.
OR

When the other party answers your call:

Ask them to press their start button. When the fax tone is heard, press **FAX/START** and replace the handset if using it.

CONNECTING
STANDARD [±]

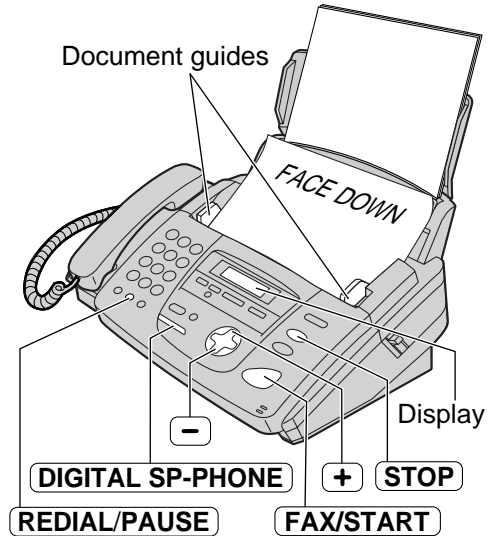

To select the resolution

Select the desired resolution according to the type of document.

- STANDARD**: For printed or typewritten originals with normal-sized characters.
- FINE**: For originals with small printing.
- SUPER FINE**: For originals with very small printing.
- PHOTO**: For originals containing photographs, shaded drawings, etc.
- Using the “FINE”, “SUPER FINE”, or “PHOTO” setting will increase transmission time.
- If the resolution setting is changed during feeding, it will be effective from the next sheet.
- The “SUPER FINE” resolution only works with other compatible fax machines.

Quick scan feature

With this feature, the unit will scan the document into memory before sending. This is helpful when you want to remove the document for other uses. To activate this feature, see feature #34 on page 65. After storing, the unit will transmit the document.

- If the document exceeds the memory capacity (p. 85), sending will be canceled and this feature will be turned OFF automatically. Transmit the entire document manually.

To stop transmission

Press **STOP**.

To redial the last number

Press **REDIAL/PAUSE**.

- If the line is busy, the unit will automatically redial the number up to 2 times.
- During redial, the following will be displayed.

Display: WAITING REDIAL

- To cancel redialing, press **STOP**.

Convenient way to send a fax

You can dial the fax number first before inserting the document. This is convenient if the other party's number is indicated on the document.

1. Enter the fax number.

- The handset must be on the cradle.

2. Insert the document.

3. Press **FAX/START**.

Sending a fax using the directory

Before using this feature, program the desired names and telephone numbers into the directory (p. 20).

- 1 Adjust the width of the document guides to the size of the document.
- 2 Insert the document (up to 10 pages) **FACE DOWN** until a single beep is heard and the unit grabs the document.

Display: STANDARD
PRESS NAVI. [+ -]

- 3 If necessary, press **+** or **-** repeatedly to select the desired resolution (p. 28).

- 4 Press **▶**.

DIRECTORY [+ -]
<MAILBOX> ▶

- 5 Press **+** or **-** to display the desired station.

Example: Sam
1789653

- For further details about using the directory, see page 22.

- 6 Press **FAX/START**.

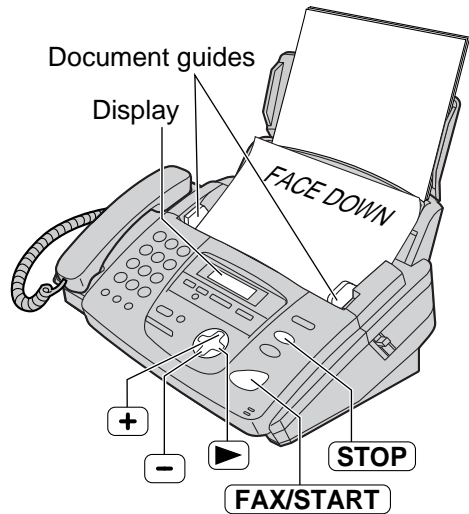

Fax auto redial

If the line is busy or if there is no answer, the unit will automatically redial the number up to 2 times.

- This feature is also available for delayed transmission (feature #25 on page 64).
- During redial, the following will be displayed.

Display: WAITING REDIAL

- To cancel redialing, press **STOP**.

If your unit does not send a fax

- Confirm the stored telephone number on the display and check that the number dialed is answered by the other party's machine (p. 22).
- The connecting tone will be heard during dialing to tell you the status of the other party's machine (feature #76 on page 69).

Sending Faxes

Sending a fax with the voice guide

You can send documents by following the voice guide. After transmission, the voice guide will turn off automatically.

- 1** Press **HELP** twice.

Display: **SEND GUIDE
PRESS SET**

- 2** Press **SET**.

Voice guide:

To transmit, insert the document face down until you hear the beep.

- 3** Insert the document (up to 10 pages) **FACE DOWN** until a single beep is heard and the unit grabs the document.

Press the speaker phone button, then dial the phone number. When the fax tone is heard, press the start button.

- If necessary, press **+** or **-** repeatedly to select the desired resolution (p. 28).

- 4** Press **DIGITAL SP-PHONE** and dial the fax number.

- You can also use the handset.

- 5** When a fax tone is heard, press **FAX/START**.

Start transmission.

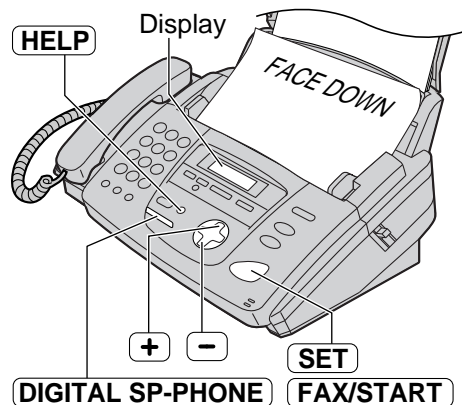

Documents you can send

Minimum size

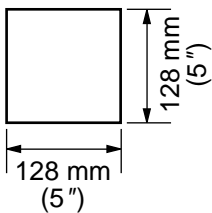

Maximum size

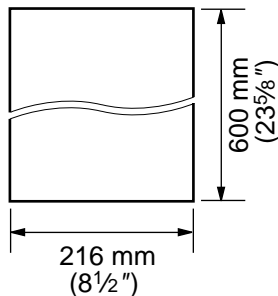

Effective scanning area

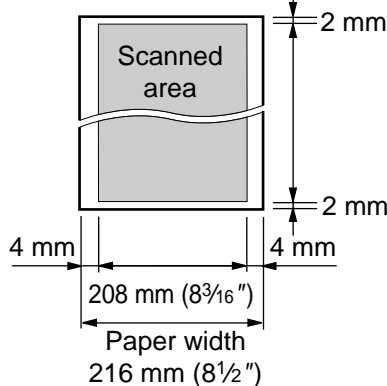

Document weight

Single sheet:

45 g/m² to 90 g/m²
(12 lb. to 24 lb.)

Multiple sheets:

60 g/m² to 75 g/m²
(16 lb. to 20 lb.)

Note:

- Remove clips, staples or other similar fasteners.
- Check that ink, paste or correction fluid has dried.
- Do not send the following types of documents. Use copies for fax transmission.
 - Chemically treated paper such as carbon or carbonless duplicating paper
 - Electrostatically charged paper
 - Paper with printing on the opposite side that can be seen through the front (e.g. newspaper)
 - Badly curled, creased or torn paper
 - Paper with a faint image
 - Paper with a coated surface
- To transmit the document(s) whose width is less than the letter size (216 mm), we recommend using a copier machine. Copy the original document on to a letter size paper, then transmit the copied document.

To transmit more than 10 pages at a time

- Insert the first 10 pages of the document. Add the other pages (10 at a time) before the last page is fed into the unit.

Reports for confirmation

To confirm the communication results, the following reports are available.

Sending report

This report will provide you with a printed record of transmission results. To use this feature, activate feature #04 (p. 62).

Sample of a sending report

SENDING REPORT								Jan. 20 2001 09:19AM
YOUR LOGO :								
YOUR FAX NO. :								
NO.	OTHER FACSIMILE	START TIME	USAGE TIME	MODE	PAGES	RESULT	*CODE	
01	2345678	Jan.20 09:18AM	00'51	SND	00	COMMUNICATION ERROR	43	

Communication message (p. 70) Error code

Journal report

The unit stores the 30 most recent fax communication results. When a new communication occurs, the oldest communication result will be erased.

—To print manually, see page 81.

—To print automatically after every 30 new fax communications, activate feature #22 (p. 64).

Sample of a journal report

JOURNAL								Jan. 25 2001 11:22AM
YOUR LOGO :								
YOUR FAX NO. :								
NO.	OTHER FACSIMILE	START TIME	USAGE TIME	MODE	PAGES	RESULT	*CODE	
01	3332222	Jan.21 07:14AM	00'45	SND	01	OK		
02	9998765	Jan.21 08:17AM	00'58	SND	02	OK		
03	John	Jan.21 09:18AM	00'48	RCV	01	OK		
04	5555666	Jan.21 10:25AM	02'45	SND	03	COMMUNICATION ERROR	43	
				SND	05	OK		
				SND	02	OK		

Communication message (p. 70) Error code

Sending Faxes

One time broadcast transmission

This feature is useful for sending the same document to selected parties only once. Select the parties for each transmission.

- 1 Insert the document **FACE DOWN**.
 - If necessary, press **+** or **-** repeatedly to select the desired resolution (p. 28).

- 2 Press **▶**.

Display:

DIRECTORY[+ -] <MAILBOX>▶

- 3 Press **+** or **-** until the following is displayed.

<ONE TIME BROAD> PRESS SET

- 4 Press **SET** to start programming the stations you want to transmit.

DIR= [00] NAVI.[+ -] & SET

- 5 Press **+** or **-** until the desired station you want to transmit is displayed.

Example:

Bill 6543210

- 6 Press **SET**.

DIR=Bill [01] SEND:PRESS SET

- To program other stations, repeat steps 5 and 6 (up to 20 stations).

- 7 Press **SET** to start transmission to the programmed stations.
 - The document will be fed into the unit and scanned into memory. The unit will then transmit the data to each station, calling each number sequentially.
 - After transmission, the stored document will be erased automatically, and the unit will automatically print a broadcast sending report (p. 35).

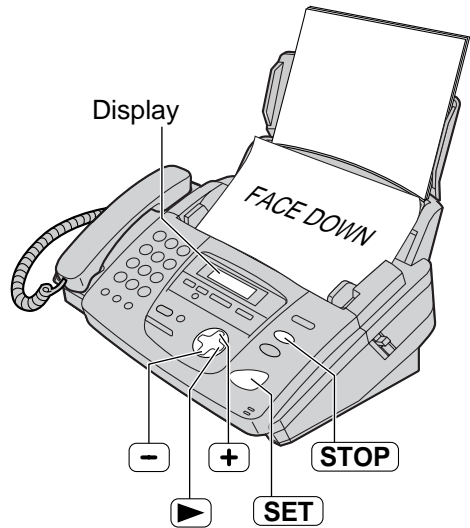

Note:

- If you select the "FINE", "SUPER FINE" or "PHOTO" resolution, the number of pages that the unit can transmit will decrease.
- If the document exceeds the memory capacity (p. 85), sending will be canceled.
- If one of the stations is busy or does not answer, the station will be skipped. All skipped stations will be redialed up to 2 times after all of the other stations have been called.

To cancel the broadcast setting

1. Press **STOP** while the unit displays the following message.

Display:

BROADCASTING

- The display will show the following.

SEND CANCELED? YES:SET/NO:STOP

2. Press **SET**.

Broadcast transmission to pre-programmed parties

This feature is useful for sending the same document often to selected parties (up to 20 stations). First program the stations, then see page 35 for transmission.

Programming the stations in the broadcast memory

1 Press **MENU** two times.

Display: `DIRECTORY SET
NAVI. = * BROAD=#`

2 Press **□** to select "BROAD".

`DIR= [00]
NAVI. [+ -] & SET`

3 Press **+** or **-** until the desired station is displayed.

Example: `MIKE
1-987-654-3210`

4 Press **SET**.

`DIR=MIKE [01]
STORE:PRESS SET`

- To program other stations, repeat steps 3 and 4.

5 Press **SET** to exit the program.

`REGISTERED`

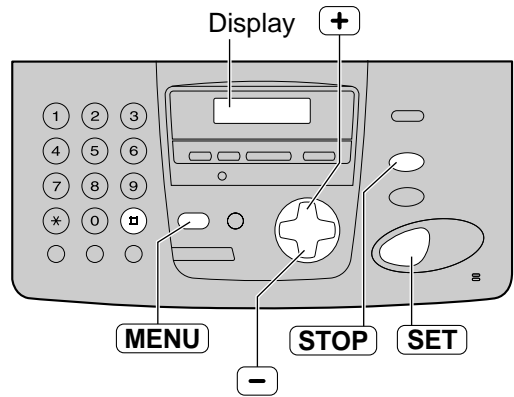

Note:

- If you enter the wrong station, press **STOP** after step 4 to erase the station.
- Confirm the stored items by printing a broadcast programming list (p. 81).

Sending Faxes

Adding a new station

- 1** Press **[▶]**.
●Confirm that there are no documents in the document entrance.

Display:

DIRECTORY[+ -] <MAILBOX>▶

- 2** Press **[+]** or **[-]** until the following is displayed.

<BROADCAST> EDIT:PRESS MENU

- 3** Press **[MENU]**.

BROADCAST ADD=* DELETE=#

- 4** Press **[*]** to select "ADD".

- 5** Press **[+]** or **[-]** until the desired station you want to add is displayed.

Example:

Mary 1-584-372-4123

- 6** Press **[SET]**.

REGISTERED



Example:

Nikki 1-385-217-9365

- To add other stations, repeat steps 5 and 6 (up to 20 stations).

- 7** Press **[STOP]** to exit the program.

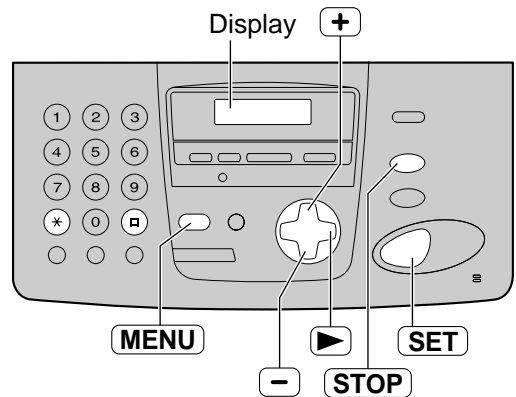

Erasing a stored station

- 1** Press **[▶]**.
●Confirm that there are no documents in the document entrance.

Display:

DIRECTORY[+ -] <MAILBOX>▶

- 2** Press **[+]** or **[-]** until the following is displayed.

<BROADCAST> EDIT:PRESS MENU

- 3** Press **[MENU]**.

BROADCAST ADD=* DELETE=#

- 4** Press **[#]** to select "DELETE".

- 5** Press **[+]** or **[-]** until the desired station you want to erase is displayed.

Example:

Dick 1-328-143-2968

- 6** Press **[SET]**.

DELETE OK? YES:SET/NO:STOP

- 7** Press **[SET]**.

DELETED



Example:

Bob 0123456

- To delete other stations, repeat steps 5 to 7.

- 8** Press **[STOP]** to exit the program.

- To cancel erasing, press **[STOP]**.

Sending the same document to pre-programmed parties

1 Insert the document **FACE DOWN**.
 ● If necessary, press **[+]** or **[-]** repeatedly to select the desired resolution (p. 28).

2 Press **[▶]**.

Display: DIRECTORY[+ -]
<MAILBOX>▶

3 Press **[+]** or **[-]** until the following is displayed.

<BROADCAST>
SEND:PRESS SET

4 Press **[SET]**.

- The document will be fed into the unit and scanned into memory. The unit will then transmit the data to each station, calling each number sequentially.
- After transmission, the stored document will be erased automatically, and the unit will automatically print a broadcast sending report (see below).

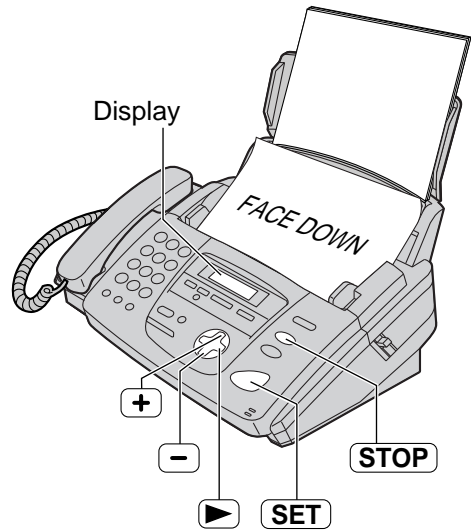

Note:

- If you select the "FINE", "SUPER FINE" or "PHOTO" resolution, the number of pages that the unit can transmit will decrease.
- If the document exceeds the memory capacity (p. 85), sending will be canceled.
- If one of the stations is busy or does not answer, the station will be skipped. All skipped stations will be redialed up to 2 times after all of the other stations have been called.

To cancel the broadcast setting

1. Press **[STOP]** while the unit displays the following message.

Display: BROADCASTING

- The display will show the following.

SEND CANCELED?
YES:SET/NO:STOP

2. Press **[SET]**.

Sample of a broadcast sending report

BROADCAST REPORT						Jan. 10 2001 09:36AM
				YOUR LOGO :		
				YOUR FAX NO. :		
NO.	OTHER FACSIMILE	START TIME	USAGE TIME	PAGES	RESULT	
01	Mike	Jan.10 09:31AM	01'10	02	OK	
02	Peter	Jan.10 09:33AM	01'08	02	OK	
03	Sam	Jan.10 09:34AM	01'09	02	OK	
04	Kim	Jan.10 09:35AM	01'10	02	OK	
TOTAL			004'37	008		

Receiving Faxes

Setting the unit to receive faxes

Use as answering device and/or fax



You want to receive all phone calls and faxes automatically.

TAD/FAX mode (p. 47)

Turn AUTO ANSWER on by pressing **AUTO ANSWER**.

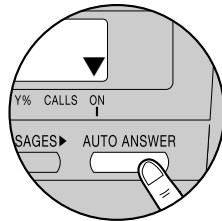

When receiving phone calls:

The unit will activate the answering device and record voice messages.

When receiving faxes:

The unit will activate the fax function to receive documents.

Use only as a fax



You have a separate telephone line just for faxes.

FAX ONLY mode (p. 39)

Turn AUTO ANSWER on by pressing **AUTO ANSWER**.

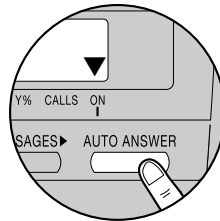

When receiving calls:

All incoming calls will be answered as faxes.

How you want the unit to receive calls

You have to set this.

This is how the unit will operate.

Voice mail service (Distinctive Ring)

2-number example

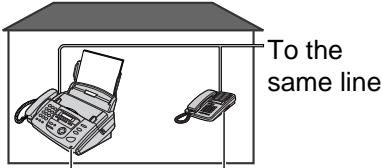

Facsimile No. (555-1333) Telephone No. (555-1111)

You need to subscribe to Distinctive Ring Service.

Mostly phone calls



You plan to answer the calls yourself.

Other options

With a PC

If you have a computer attached to the same telephone line, see page 42.

TEL/FAX mode

If you are near the unit and want to use it to receive phone calls yourself and faxes automatically, see pages 40 and 41.

Setting the Distinctive Ring pattern (feature #31 on page 65)

Select the same ring pattern assigned to the facsimile number. (Default setting is B.)
A: Standard ring (one long ring)
B: Double ring (two short rings)
C: Triple ring (short-long-short rings)
D: Other triple ring (short-short-long rings)

TEL mode (p. 38)

Turn AUTO ANSWER off by pressing **AUTO ANSWER**.

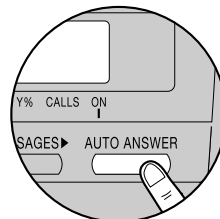

When the fax machine detects a call matching the selected Distinctive Ring pattern: The fax machine will activate the fax function.

When the fax machine detects other ring patterns: The fax machine will operate based on the AUTO ANSWER setting.

When receiving calls:

You have to answer all calls manually.

To receive a fax document, press **FAX/START** for each fax receiving.

Remote fax activation

You can also receive a fax using an extension telephone. While hearing a fax calling tone with an extension telephone, press *** 9** (pre-selected fax activation code) to receive a fax (p. 42).

Receiving Faxes

TEL mode (answering all calls manually)

Activating TEL mode

If the arrow (▼) is shown on the right of the display, turn it off by pressing **AUTO ANSWER**.

Display: TEL MODE
ON

Receiving a fax manually

1 When the unit rings, press **DIGITAL SP-PHONE** or lift the handset to answer the call.

2 When:
—document reception is required,
—a fax calling tone (slow beep) is heard, or
—no sound is heard,
press **FAX/START**.

CONNECTING.....

3 Replace the handset.
●The unit will start fax reception.

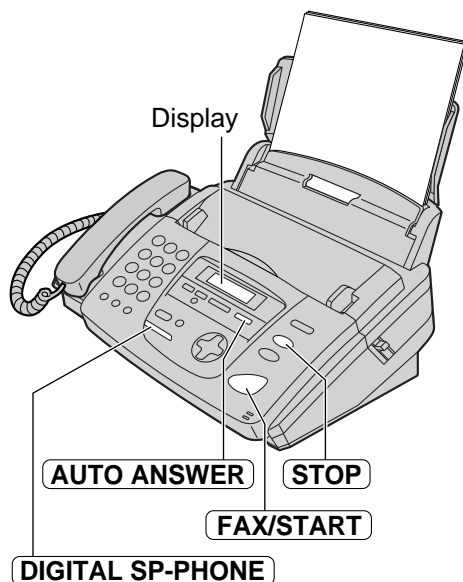

Note:

- If you do not answer the call within 10 rings, the unit will temporarily activate the answering device.
- Up to 30 sheets of printed paper can be held. Remove the printed paper before it exceeds 30 sheets.

To stop receiving

Press **STOP**.

Friendly reception feature

When you answer a call and hear a fax calling tone (slow beep), the unit will automatically start fax reception.

- If this feature is not required, set feature #46 to off (p. 67).

Fax reception in memory

When a printing problem is detected, the unit will temporarily store the received document into memory.

While the document is in memory:

—the display will show an error message and the following message alternately,

Display: FAX IN MEMORY

—slow beeps will sound if feature #44 is set to on (p. 67).

- Follow the instructions on pages 71 and 72 to solve the problem.
- For memory capacity, see page 85.

FAX ONLY mode --- --- (all calls are received as faxes)

Activating FAX ONLY mode

- 1 Set feature #77 to "FAX ONLY" (p. 69).
- 2 If the arrow (▼) is not shown on the right of the display, turn it on by pressing **AUTO ANSWER**.
 - The display will show the number of rings before the unit answers a call in FAX ONLY mode.

Display:

PICKUP & RCV FAX AFTER 3 RINGS[±]

- 3 If you wish to change the ring count setting, press **+** or **-** until the desired number is displayed, and press **SET**.

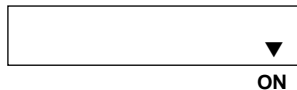

- When receiving calls, the unit will automatically answer all calls and only receive fax documents.

Note:

- If the arrow (▼) is already shown on the right of the display and you wish to change the ring count, turn the arrow off once then on again by pressing **AUTO ANSWER** and follow the instructions in step 3.
- This mode should not be used with a telephone line which is used for both phone calls and faxes. Fax communication will be attempted even if someone is trying to call you.

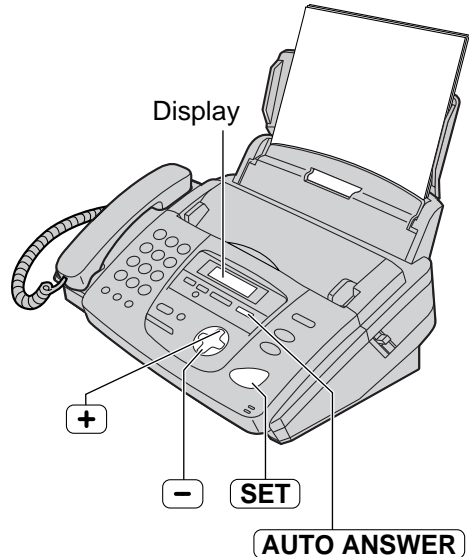

If you have a telephone line just for faxes, we recommend the following setup.

Example: One telephone line is used for phone calls and a separate telephone line for faxes.

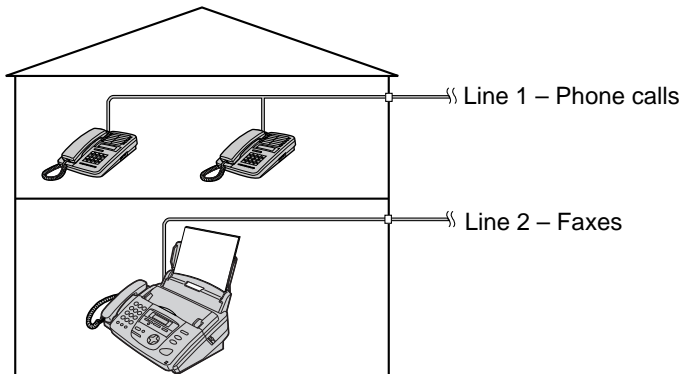

Only a fax machine is connected.

When an extension telephone is connected

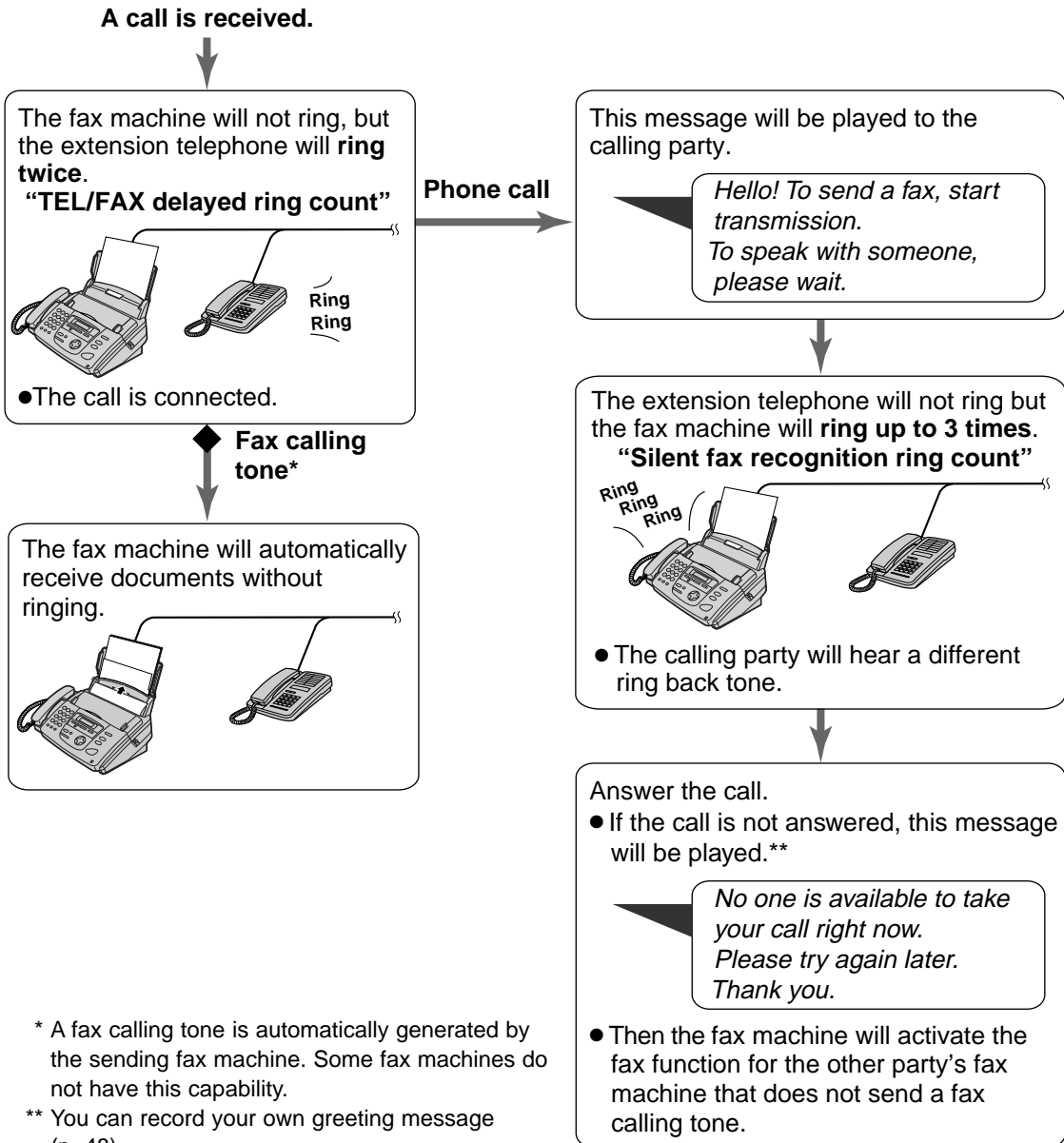

* A fax calling tone is automatically generated by the sending fax machine. Some fax machines do not have this capability.

** You can record your own greeting message (p. 48).

TEL/FAX delayed ring count

The number of rings generated before the fax machine answers depends on the setting of feature #78 on page 69. The fax machine will not generate an audible ring during this time.

Silent fax recognition ring count

The fax machine generates audible rings to indicate that it is receiving a phone call. The number of rings generated depends on the setting of feature #30 on page 65. This signal will not ring at an extension telephone.

Receiving Faxes

Using the unit with a computer

We recommend you use separate wall jacks for the unit and the computer.

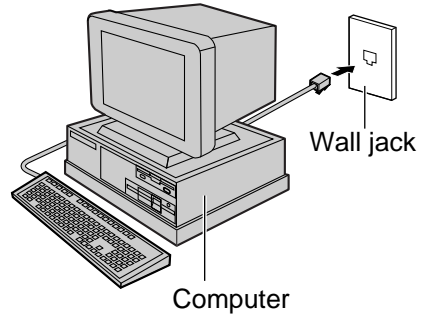
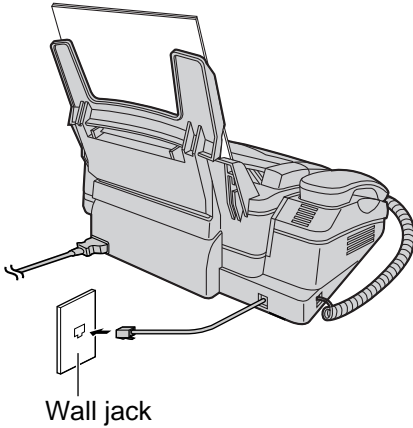

Note:

- Set the fax machine to TEL mode.
- The device which has the shortest ring count will answer a call first.

Extension telephone

If you use the fax machine with an extension telephone, you can receive fax documents using the extension telephone. You do not have to press **FAX/START** on the fax machine.

Important:

- Use a touch tone telephone as the extension telephone and enter the fax activation code **firmly**.

1 When the extension telephone rings, lift the handset of the extension telephone.

2 When:
—document reception is required,
—a fax calling tone (slow beep) is heard, or
—no sound is heard,
press *** 9** (pre-selected fax activation code) **firmly**.

3 Hang up the handset.
•The fax machine will start reception.

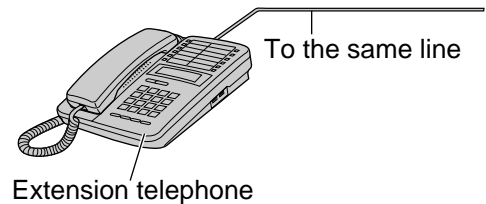

Note:

- You can change the fax activation code in feature #41 (p. 66).

Pager call - when the unit receives a fax or voice message

This feature allows your unit to call your pager when your unit receives a fax document or an incoming voice message.

1 Press **MENU** .
Display: SYSTEM SET UP
PRESS NAVI. [◀ ▶]

2 Press **#** , then **7 0** .
PAGER CALL
MODE=OFF [±]

3 Press **+** or **-** to select "ON".
PAGER CALL
MODE=ON [±]

● If this feature is not required, select "OFF".

4 Press **SET** .
NO. =

5 Enter your pager number up to 30 digits.
Example: NO. =12025551234

6 Press **SET** .
PIN =

7 Enter your pager access code up to 10 digits if required.
Example: PIN=12345678

8 Press **SET** .
MSG. =07734

● The default code 07734 will show "Hello!" on your pager.

● If you want to change this message, enter your message up to 30 digits.

Example: MSG. =5555

9 Press **SET** .
● The unit will dial the stored number.
PAGER TEST

10 Check that your pager received the pager test call.

11 Press **DIGITAL SP-PHONE** .

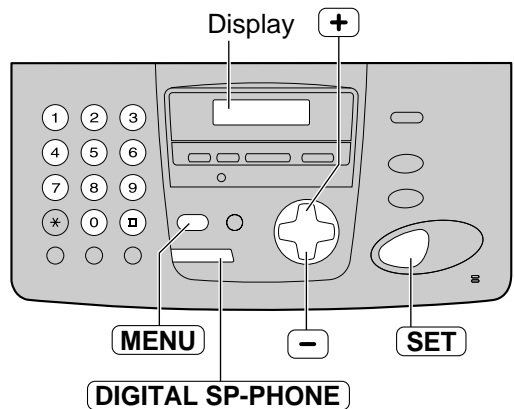

Note:

● If you have subscribed to a Caller ID service, your pager will display the caller's telephone number before the number "11" or "22" (see below) instead of the message.

When your pager receives a pager call

Your pager will beep and display as follows;

— "11" : when your unit receives a voice message.

— "22" : when your unit receives a fax document.

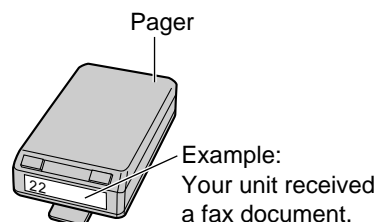

Copying

Making a copy

The unit can make single or multiple copies (up to 50).

- 1 Adjust the width of the document guides to the size of the document.
- 2 Insert the document (up to 10 pages) **FACE DOWN** until a single beep is heard and the unit grabs the document.

Display: `STANDARD
PRESS NAVI. [+ -]`

- If necessary, press **+** or **-** repeatedly to select the desired resolution (see below).
- Make sure the handset is on the cradle.

- 3 Press **COPY**.

`NUMBER=1
COPY:PRESS START`



`NUMBER=1
OR PRESS NAVI. ▶`

- If necessary, enter the number of copies (up to 50).

- 4 Press **START**.
- The unit will start copying.

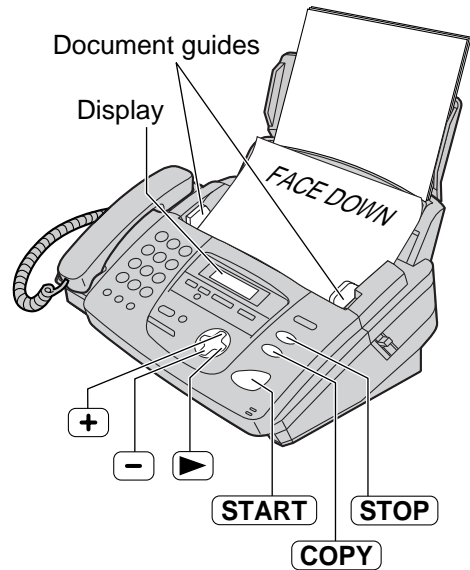

Note:

- Any transmittable document can be copied (p. 30).

To select the resolution

Select the desired resolution according to the type of document.

- **FINE**: For printed or typewritten originals with small printing.
- **SUPER FINE**: For originals with very small printing.
- **PHOTO**: For originals containing photographs.
- If you select "STANDARD", copying will be done using "FINE" mode.

To stop copying

Press **STOP**.

Convenient way to make a copy

The following settings are available before you start copying.

- Enlargement (p. 45)
- Reduction (p. 45)
- Collation (sort) (p. 46)
- Resolution (p. 46)
- Quick scan (p. 46)

To enlarge a document

1. Press in step 3 on page 44.

Display:

ZOOM 100%[+ -] <COLLATE>

2. Press to select "150%" or "200%".

●The unit will only enlarge the center most part of the document, printing it on two pages.

Example of a 150% enlarged copy

Original document

Enlarged copy

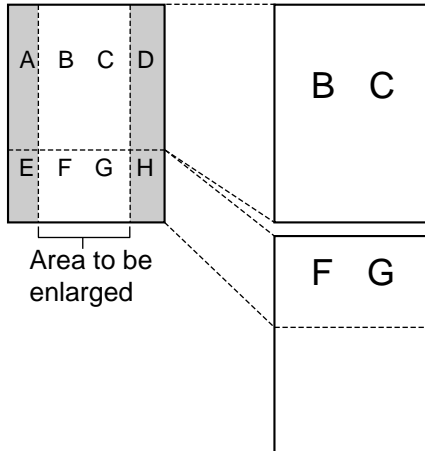

Example of a 200% enlarged copy

Original document

Enlarged copy

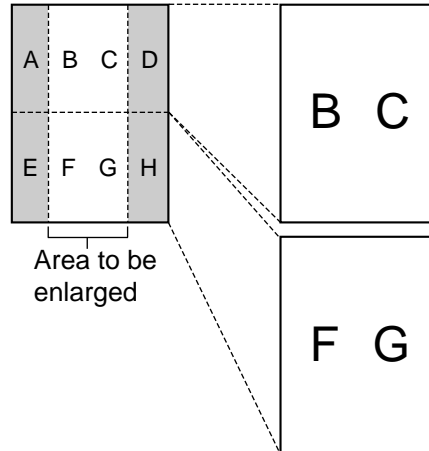

To reduce a document

1. Press in step 3 on page 44.

Display:

ZOOM 100%[+ -] <COLLATE>

2. Press to select "92%", "86%" or "72%".

●See below for the recommended reduction rates.

Setting	Size of recording paper	Size of original document
100% (default)	Letter	Letter
	Legal	Letter, A4, Legal
	A4	A4, Letter
92%	Letter	A4
86%	Letter	A4
72%	Letter	Legal
	A4	Legal

Letter = 216 mm x 279 mm (8 $\frac{1}{2}$ " x 11") / Legal = 216 mm x 356 mm (8 $\frac{1}{2}$ " x 14")

A4 = 210 mm x 297 mm (8 $\frac{1}{4}$ " x 11 $\frac{11}{16}$ ")

Note:

- If the appropriate reduction rate is not programmed, the document may be divided and the top of the second sheet will be deleted.
- If the image at the bottom of the document is not copied when you copy a document as long as the recording paper, try 92% or 86%.

Copying

To collate multiple copies

The unit can collate multiple copies in the same order as the original document pages.

1. Press  two times in step 3 on page 44.

Display:

COLLATE OFF [+ -]
<RESOLUTION>▶

2. Press  or  repeatedly to select "COLLATE ON".

Display:

COLLATE ON [+ -]
<RESOLUTION>▶

Example: Making two copies of a 4-page original document

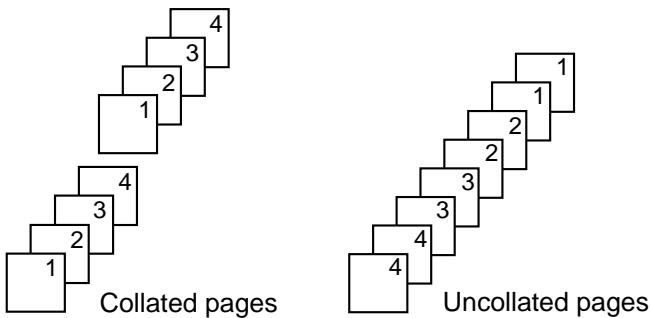

Note:

- The unit will store the documents into memory while collating the copies. If memory becomes full while storing, the unit will only print out the stored pages.
- After copying, the collating feature will turn off automatically.

To select the resolution



You can select the resolution according to the type of document after pressing  in step 3 on page 44.

- For further details about the resolution, see page 44.

1. Press  three times in step 3 on page 44.

Display:

STANDARD [+ -]
<NUMBER>▶

2. Press  or  repeatedly to select the desired resolution.

Quick scan feature

The unit can scan the document into memory before copying. This feature is helpful when you want to remove the document for other uses.

To activate this feature, see feature #34 on page 65. After storing, the unit will copy the document.

Note:

- If the document exceeds the memory capacity (p. 85), copying will be canceled and this feature may be turned OFF automatically.

TAD/FAX mode --- --- (using the built-in answering device and receiving phone calls and faxes automatically)

When TAD/FAX mode is set, the unit will work as a fax machine and/or answering device.

If a fax tone is detected, the unit will automatically receive the fax. If a phone call is detected, the answering device will play a greeting message and the caller can leave a voice message in the common memory. If you share the unit with other people and wish to prevent them from retrieving messages, use the voice mailbox feature (p. 52–54).

- You can use either the pre-recorded greeting message (see below) or your own greeting message (p. 48).

Setting up the voice and fax message reception

1 Set feature #77 to “TAD/FAX” (p. 69).

2 If the arrow (▼) is not shown on the right of the display, turn it on by pressing

AUTO ANSWER.

- The unit will play the greeting message.

*Hello! We are unable to answer right now.
To send a fax, please start transmission.
To leave a voice message, please speak after the beep. Thank you.*

- The display will show the number of rings before the unit answers a call in TAD/FAX mode.

Display: PICKUP &RCV CALL
AFTER 2 RINGS[±]

3 If you wish to change the ring count setting, press **+** or **-** until the desired number (see below) is displayed, and press **SET**. The remaining time for recording incoming messages will be displayed.

Example: TIME = 10m13s

- You can change the speaker volume. After setting the ring count, press **+** or **-** while listening to the greeting message.

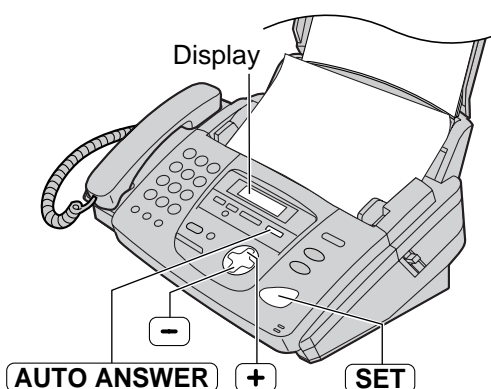

Note:

- If the arrow (▼) is already shown on the right of the display and you wish to change the ring count, turn it off once then on again by pressing **AUTO ANSWER** and follow the instructions in step 3.
- The incoming message recording time can be changed (feature #10 on page 63).
- When the remaining time is low, erase unnecessary messages (p. 50). For voice memory capacity for incoming messages, see page 85.
- While an incoming call is being recorded, you can monitor it through the speaker. If this feature is not required, set feature #67 to off (p. 69).

Ring count in TAD/FAX mode

You can choose from 1, 2, 3, 4, TOLL SAVER and RINGER OFF (feature #06 on page 62).

TOLL SAVER: When you call the unit from a remote location, the number of rings will tell you if there are any new voice messages. If the unit answers on the second ring, there is at least one new recorded message. If the unit answers on the fourth ring, there are no new recorded messages. To save the toll charges for the call, hang up immediately when you hear the third ring. The third ring indicates that there are no new recorded messages.

RINGER OFF: The unit will answer without ringing.

- If you subscribe to a Caller ID service, set to 2 or more rings.

Recording your own greeting messages

You can record your own greeting messages for TAD/FAX and TEL/FAX modes. When receiving a call, your own greeting message will be played instead of the pre-recorded message. The recording time will be limited to 16 seconds. We recommend you record your message within 12 seconds to make it easier to receive faxes.

Suggested messages

TAD/FAX greeting message	<i>"This is (your name, business and/or telephone number). We are unable to answer right now. To send a fax, start transmission. To leave a message, speak after the beep. Thank you."</i>
TEL/FAX greeting message	<i>"This is (your name, business and/or telephone number). We are unable to answer right now. Please try again later. Thank you."</i>

1 Select the desired mode (TAD/FAX or TEL/FAX) where you want to record a greeting message (feature #77 on page 69).

2 Press **RECORD** 2 times.
●The display will show the following according to your selection in step 1.

TAD/FAX mode:

TAD GREETING PRESS SET

TEL/FAX mode:

TEL/FAX GREETING PRESS SET

3 Press **SET**.
●A long beep will sound.

4 Speak clearly about 20 cm (8 inches) away from the microphone.

●The display will show the remaining recording time.

TAD/FAX mode:

TAD REC. 15s

TEL/FAX mode:

T/F REC. 15s

5 When finished recording, press **STOP**.
●The unit will repeat your message. Adjust the volume using **+** or **-**.

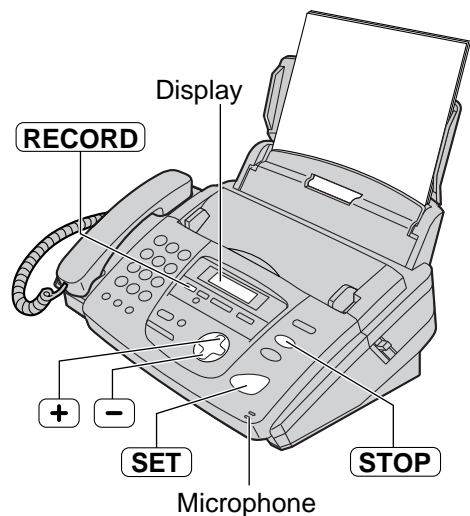

Note:

- If you make a mistake while recording, start again from step 2.
- You can choose 60 seconds for your own TAD/FAX greeting message (feature #54 on page 68).
 - If you change to 60 seconds, we recommend that you tell the caller in your own TAD/FAX greeting message to press *9 before starting fax transmission.
 - If you change to 16 seconds from 60 seconds, your own recorded TAD/FAX greeting message will be deleted and the pre-recorded message will be played.

Checking the greeting messages

- 1 Select the desired mode (TAD/FAX or TEL/FAX) for the greeting message you want to listen to (feature #77 on page 69).
- 2 If the arrow (▼) is not shown on the right of the display, turn it on by pressing **AUTO ANSWER**.
If the arrow (▼) is shown on the right of the display, turn it off once then on again.

TAD/FAX mode:

PICKUP &RCV CALL AFTER 2 RINGS[±]

TEL/FAX mode:

TEL/FAX MODE

- The unit will play the greeting message.

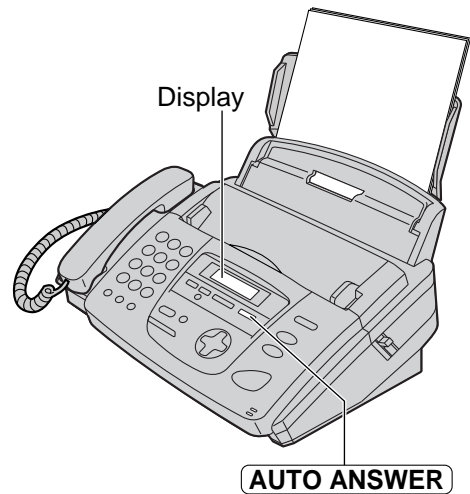

Erasing your own recorded greeting messages

- 1 Select the desired mode (TAD/FAX or TEL/FAX) for the greeting message you want to erase (feature #77 on page 69).
- 2 Press **ERASE** twice.
 - The display will show the following according to your selection in step 1.

TAD/FAX mode:

TAD GREETING PRESS SET

TEL/FAX mode:

TEL/FAX GREETING PRESS SET

- 3 Press **SET**.

ERASE GREETING? YES:SET/NO:STOP

- To cancel erasing, press **STOP**.

- 4 Press **SET**.

GREETING ERASED

- When receiving a call, the pre-recorded greeting message will be played.

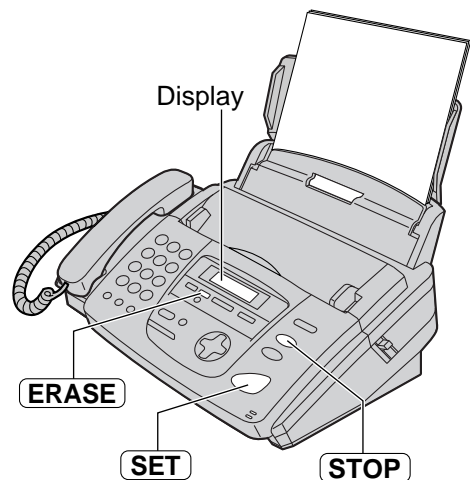

Incoming Messages

Listening to recorded messages

When the unit has recorded new voice messages:

- the MESSAGE light will flash,
- the call counter will show the total number of recorded messages, and
- slow beeps will sound if the message alert feature is activated (feature #42 on page 66).

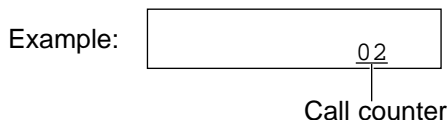

Press **PLAY MESSAGES**.

- Only the new recorded messages will be played.
- Adjust the speaker volume using **+** or **-**.
- After playing back all of the new messages, the MESSAGE light will stop flashing but will remain lit up.

If you press **PLAY MESSAGES** at this time, all the recorded messages will be played.

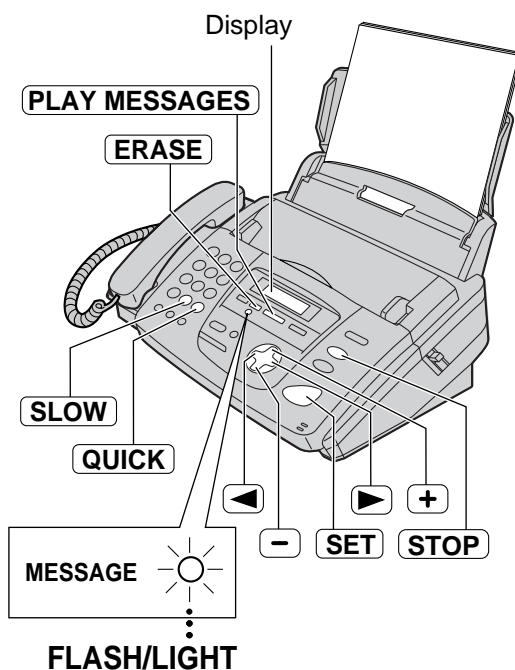

Repeating a message

Press **◀** while listening to the message.

- If you press **◀** within 5 seconds of the beginning of the message, the previous message will be played.
- To play back a specific message, press **◀** or **▶** and search for the message you want to listen to.

Skipping a message

Press **▶** to play the next message.

Stopping playback

Press **STOP**.

- If you press **PLAY MESSAGES** within 1 minute, the unit will resume playing the rest of the messages.

Voice time/day stamp

During playback, a synthesized voice will announce the time and day of the week that each message was recorded.

Changing the playback speed

Press **QUICK** to play messages at one and a half times the original speed.

Press **SLOW** to play messages at half the original speed.

- To return to the original speed, press **QUICK** or **SLOW** again during quick or slow playback.

Erasing all of the recorded messages

Check that you have listened to all of the recorded messages.

1. Press **ERASE**.

Display:

ALL MESSAGES PRESS SET

2. Press **SET**.

ERASE MESSAGES? YES: SET/NO: STOP

3. Press **SET**.

- To erase a specific message, press **ERASE** while listening to the message you want to erase.

Memo message --- --- (leaving a message for others or yourself)

To leave a private message for yourself or someone else, you can record a voice memo. This memo can be played back later, either directly or remotely.

1 Press **RECORD**.

Display:

MEMO MESSAGE PRESS SET

2 Press **SET**.
•A long beep will sound.

MEMO RECORDING

3 Speak clearly about 20 cm (8 inches) away from the microphone.

4 When finished recording, press **STOP**.

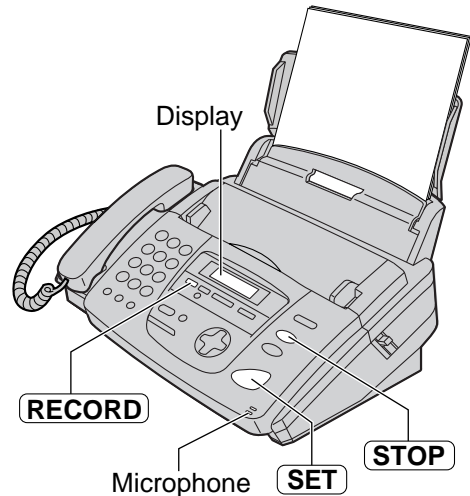

Telephone conversation --- ---

You can record a telephone conversation. This conversation can be played back later, either directly or remotely.

1 During a telephone conversation, press **RECORD**.

Display:

2WAY RECORDING

2 To stop recording, press **STOP** or replace the handset.

Note:

- There may be legal restrictions in your state on recording two-way telephone conversations. Inform the other party that the conversation is being recorded.

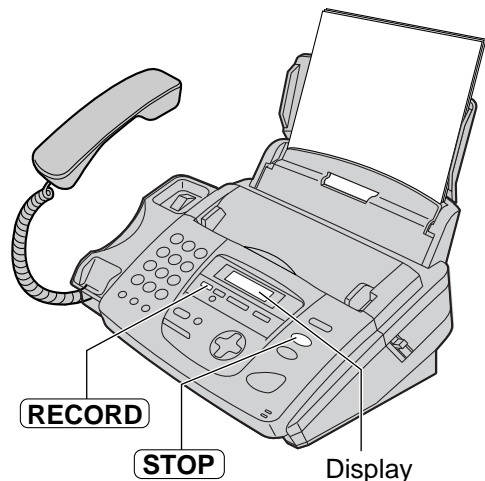

Voice Mailbox

Voice mailbox (how callers can leave you private messages)

This unit has two mailbox memories. Your caller can leave a private message in a specific mailbox. Only the person who knows the password can retrieve a message from a mailbox. This feature is useful when you share this unit with other people and a caller would like to leave a message for a specific person.

To use a mailbox

1. Record your own mailbox greeting message if necessary (see next page).
2. Program the mailbox password if necessary (see feature #51 for mailbox 1 password and feature #52 for mailbox 2 password on page 67).
3. Inform the mailbox number to callers.
 - If the caller does not enter the mailbox password, the message will be recorded in common memory.
4. Set the unit to TAD/FAX mode (p. 47).

How incoming messages are recorded in a mailbox

- 1 Call your unit from a touch tone telephone.
 - The TAD/FAX greeting message will be played.

TAD/FAX greeting message example:

Hello! We are unable to answer right now. To send a fax, please start transmission. To leave a voice message, please speak after the beep. To leave a private message, please press [] and the desired mailbox number 1 or 2. Thank you.*

- 2 Press [*] and the desired mailbox number (1 or 2).
 - A mailbox greeting message will be played.

Mailbox greeting message example:

This is mailbox (1 or 2). Please leave your name and message after the beep.



- 3 After the beep, leave a message.

Recording a memo message

You can record a memo message into a mailbox.

1. Press  two times.

Display:

2. Press  or  until the desired mailbox number is displayed.

Example (Mailbox 1):

3. Press .

● A long beep will sound.

Example:

4. Speak clearly about 20 cm (8 inches) away from the microphone.
5. When finished recording, press .

Recording your own voice mailbox greeting messages

The recording time is limited to 16 seconds.

Suggested message

"This is (personal name). Please leave your name and message after the beep."

1 Press **MENU**.

Display:

SYSTEM SET UP PRESS NAVI. [◀ ▶]

2 For mailbox 1
Press **☎**, then **5 5**.

BOX1 GREETING CHECK [±]

For mailbox 2
Press **☎**, then **5 6**.

BOX2 GREETING CHECK [±]

3 Press **+** or **-** to select "RECORD".

Example (Mailbox 1):

BOX1 GREETING RECORD [±]

4 Press **SET**.

Example:

BOX1 REC. 16s

5 Speak clearly about 20 cm (8 inches) away from the microphone.

- The display will show the remaining recording time.

Example:

BOX1 REC. 15s

6 When finished recording, press **STOP**.
●The unit will repeat your message. Adjust the volume using **+** or **-**.

7 Press **MENU**.

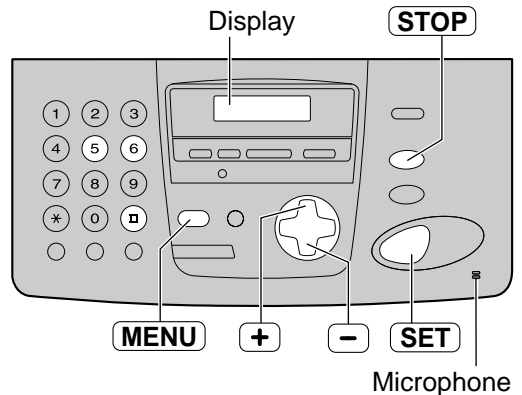

To check your own recorded mailbox greeting message

1. For mailbox 1
Press **MENU**, **☎ 5 5**.

For mailbox 2
Press **MENU**, **☎ 5 6**.

2. Press **+** or **-** to select "CHECK".

3. Press **SET**.
●The unit will play your message.

4. Press **MENU**.

To erase your mailbox greeting message

1. For mailbox 1
Press **MENU**, **☎ 5 5**.

For mailbox 2
Press **MENU**, **☎ 5 6**.

2. Press **+** or **-** to select "ERASE".

3. Press **SET**.
●Your own message will be erased.

4. Press **MENU**.

Voice Mailbox

Listening to messages in a mailbox

1 Press **▶** two times.

Display: MAILBOX[+ -]

2 Press **+** or **-** until the desired mailbox number is displayed.

Example
(Mailbox 2): NEW MESSAGES
MAILBOX2 [±] 02

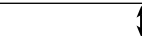

PRESS
REC/ERASE/PLAY

3 If you have **NOT** programmed your own password:

Press **PLAY MESSAGES**.

OR

If you have programmed your own password:

Press **PLAY MESSAGES**, then enter your password.

PASSWORD=

- If there are new messages, the unit will play them back.
- If there are no new messages, the unit will play back the all of recorded messages.

4 To exit the mailbox, press **STOP**.

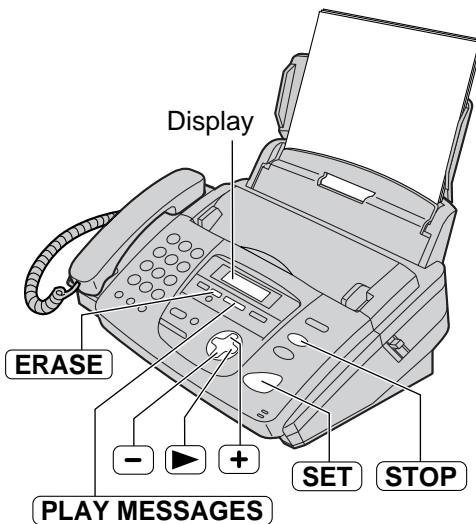

Note:

- The following features are available (p. 50) while listening to messages in a mailbox.
 - Repeating a message
 - Skipping a message
 - Stopping playback
 - Changing the playback speed

Erasing a specific message in a mailbox

Press **ERASE** while listening to the message you want to erase.

Erasing all messages in a mailbox

1. Press **▶** two times.

2. Press **+** or **-** until the desired mailbox number is displayed.

Example
(Mailbox 1): MAILBOX1 [±] 01



PRESS
REC/ERASE/PLAY

3. Press **ERASE**.

BOX1 ERASE OK?
YES:SET/NO:STOP

4. Press **SET**.

ERASE COMPLETED

Operating from a remote location

The following operations can be performed from a remote location using a touch tone telephone. **Program the remote operation ID (feature #11 on page 63) and set the unit to TAD/FAX mode before going out (p. 47).**

Dial key	Remote command	Page	Dial key	Remote command	Page
0	Skips the greeting message	58	*4	Erases a specific message	58
1	Repeats a message	56	*5	Erases all messages	58
2	Skips a message	56	80	Changes to TEL mode	58
4	New message playback	56	81	Turns ON message transfer (not available for mailbox)	58
5	All message playback	56	82	Turns OFF message transfer (not available for mailbox)	58
6	Room monitor	58	83	Turns ON pager call (not available for mailbox)	58
7	Re-records a greeting message	58	84	Turns OFF pager call (not available for mailbox)	58
9	Stops re-recording of a greeting message	58			

Remote operation card

Please cut out and carry this card for assistance when using the remote operation.

Mailbox Remote Operation	Notice of Remote Operation
<p>■ Recording a message in a mailbox:</p> <ol style="list-style-type: none"> 1. Call your unit. 2. Press * and the mailbox no. (1 or 2). 3. Leave a message. <p>■ Retrieving messages from a mailbox:</p> <ol style="list-style-type: none"> 1. Call your unit. 2. Press * and the mailbox no. (1 or 2). 3. Enter the mailbox password □□□. 4. Press the remote command key (see the reverse side). <ul style="list-style-type: none"> ● 81, 82, 83 and 84 cannot be used. 	<ul style="list-style-type: none"> ● The remote operation is available only from a touch tone telephone when the unit is in TAD/FAX mode. ● When the unit is in TEL mode, call your unit and wait for 10 rings. The answering device will temporarily answer the line. Enter the remote operation ID during the greeting message. The unit will switch to TAD/FAX mode. ● When you press a key, press firmly. ● To send a document, press *9. When a fax tone is heard, start transmission.

Remote Operation

Operation from a remote touch tone telephone

Listening to recorded messages in common memory

1 Call your unit.

2 Enter the remote operation ID during TAD/FAX greeting playback.

When there are new recorded messages

The voice guide will tell you the number of new recorded messages and they will be played automatically.

Voice guide example:

3 new messages.

● **To repeat only the new messages:**

Press **4**.

● **To repeat the current message:**

Press **1**.

If you press **1** within 5 seconds of the beginning of a message, the previous message will be played.

● **To listen to all the messages:**

Press **5**.

● **To skip a message:**

Press **2**.

When there are no new recorded messages

No new messages.

Press **5** or wait for 4 seconds to listen to all the messages.

● To listen to messages in another memory after playback, see page 57.

When voice memory is full

*Sorry, no more memory.
Please erase unnecessary messages.*

Erase some or all of the messages (p. 58).

Answering Device Remote Operation

1. Call your unit.
2. Enter the remote operation ID during the greeting message.
 - The new messages will be played automatically.
 - If there are no new messages, wait for 4 seconds. All the messages will be played back.
3. Press the remote command key(s) within 10 seconds.

Key	Remote command
0	Skips the greeting message
1	Repeats a message
2	Skips a message

Key	Remote command
4	New message playback
5	All message playback
6	Room monitor
7	Re-records a greeting message
9	Stops re-recording of a greeting message
*4	Erases a specific message
*5	Erases all messages
80	Changes to TEL mode
81	Turns ON message transfer
82	Turns OFF message transfer
83	Turns ON pager call
84	Turns OFF pager call

Listening to messages in a mailbox

- 1 Call your unit.
- 2 Press ***** and the desired mailbox number (**1** or **2**) during TAD/FAX greeting playback.

Mailbox greeting message example:

*This is mailbox (1 or 2).
Please leave your name and message after the beep.*

- 3 Enter the mailbox password during the mailbox greeting message.
 - If you have not programmed your own mailbox password, enter “555 (default setting)” as the mailbox password (see feature #51 for mailbox 1 password or feature #52 for mailbox 2 password on page 67).

When there are new recorded messages

The voice guide will tell you the number of new recorded messages and they will be played automatically.

Voice guide example:

3 new messages.

●To repeat only the new messages:

Press **4**.

●To repeat the current message:

Press **1**.

If you press **1** within 5 seconds of the beginning of a message, the previous message will be played.

●To listen to all the messages:

Press **5**.

●To skip a message:

Press **2**.

When there are no new recorded messages

No new messages.

Press **5** or wait for 4 seconds to listen to all the messages.

When voice memory is full

*Sorry, no more memory.
Please erase unnecessary messages.*

Erase some or all of the messages (p. 58).

To listen to messages in another memory after playback

1. Press ***** and **0** (for common memory), then enter the remote operation ID.
or
Press ***** and the desired mailbox number (**1** or **2**), then enter the mailbox password during the mailbox greeting message.
 - If you have not programmed your own mailbox password, enter “555 (default setting)” as the mailbox password (see feature #51 for mailbox 1 password or feature #52 for mailbox 2 password on page 67).
2. Press **5** or wait for 4 seconds to play back messages.

Remote Operation

Other remote operations

■ Erasing a specific message

Press **[*] [4]** while listening to the message you want to erase.

Voice guide example:

The message has been erased.

- A long beep will also sound. The unit will then play back the next message.

■ Erasing all the messages

You can erase all of the recorded messages from the common memory and each mailbox memory. To erase all of the messages in a mailbox, you must first select the mailbox.

Press **[*] [5]** to erase all the messages.

All messages have been erased.

- A long beep will also sound.

■ Monitoring the room

Press **[6]** to monitor the sound for about 30 seconds in the room where the unit is installed.

- After 30 seconds, a beep sounds. To continue monitoring, press **[6]** again within 10 seconds.

■ Recording a marker message

You can leave an additional message.

1. Wait for the voice guide.

All messages have been played.

2. Wait about 10 seconds.

Please leave your name and message after the beep.

3. Leave a message after the beep.

■ Re-recording a greeting message

You can change the contents of the greeting messages for TAD/FAX mode and mailbox memories. To re-record a mailbox greeting message, you must first select the mailbox.

1. Press **[7]** to start recording.

- A long beep will sound.

2. Speak clearly up to 16 seconds.

- If you pause for over 2 seconds, 6 beeps will sound and the recording will stop. Repeat from step 1 within 10 seconds.

3. When finished recording, press **[9]**.

- The new greeting message will be played.

■ Skipping the greeting message

Press **[0]** during the greeting message playback.

- The unit will skip the rest of the greeting message.

■ Turning the message transfer on or off

You must pre-program a transfer telephone number beforehand (feature #60 on page 68).

Press **[8] [1]** to turn ON the message transfer.

*Message transfer is set.
Transfer phone number is 123...*

Press **[8] [2]** to turn OFF the message transfer.

Message transfer is off.

- If a transfer telephone number is not programmed, you cannot turn this feature ON.

Transfer phone number is not set.

■ Turning the pager call on or off

You must program a pager number beforehand (feature #70 on page 43).

Press **[8] [3]** to turn ON the pager call.

*Pager call is set.
Pager number is 098765432.*

Press **[8] [4]** to turn OFF the pager call.

Pager call is off.

- If a pager number is not programmed, you cannot turn this feature ON.

Pager number is not set.

■ Changing the receive mode

Press **[8] [0]** to change the receive mode from TAD/FAX to TEL.

- You cannot return to TAD/FAX mode in the same call. To return to TAD/FAX mode, see below.

■ Returning to TAD/FAX mode

1. Call your unit and wait for 10 rings.

- The answering device will temporarily answer the call.

2. Enter the remote operation ID during the greeting message.

- Your unit will switch to TAD/FAX mode.

Transferring recorded messages to another telephone

This feature allows your unit to call a designated telephone number each time an incoming voice message is recorded. You can retrieve the transferred message during the same call using the remote operation.

Program the transfer telephone number first (feature #60 on page 68) and set to TAD/FAX mode.

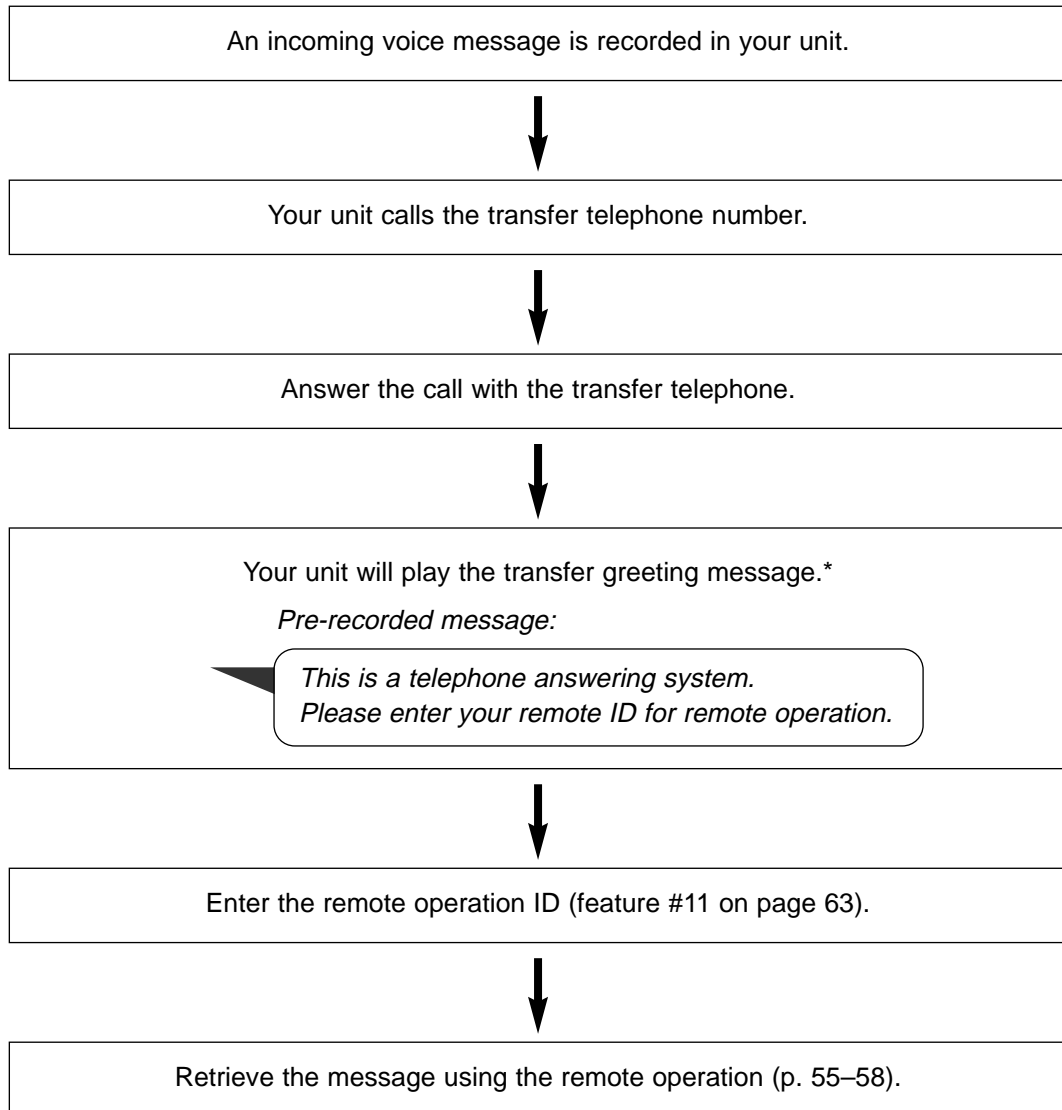

* This message can be changed (p. 60).

Recording your own transfer greeting message

The recording time is limited to 16 seconds.

Suggested message

"This is a transferred message from (your name, business and/or telephone number). Please enter your remote ID for remote operation."

1 Press **MENU**.

Display: SYSTEM SET UP
PRESS NAVI. [◀ ▶]

2 Press **☎**, then **6 1**.

TRNS-GREETING
CHECK [±]

3 Press **+** or **-** to select "RECORD".

TRNS-GREETING
RECORD [±]

4 Press **SET**.

TRNS REC. 16s

5 Speak clearly about 20 cm (8 inches) away from the microphone.

- The display will show the remaining recording time.

Example: TRNS REC. 15s

6 When finished recording, press **STOP**.

- The unit will repeat your message. Adjust the volume using **+** or **-**.

7 Press **MENU**.

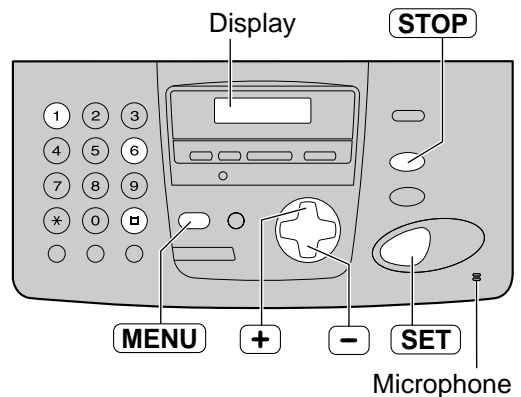

To check your transfer greeting message

1. Press **MENU**, **☎ 6 1**.
2. Press **+** or **-** to select "CHECK".
3. Press **SET**.
 - The unit will play your message.
4. Press **MENU**.

To erase your transfer greeting message

1. Press **MENU**, **☎ 6 1**.
2. Press **+** or **-** to select "ERASE".
3. Press **SET**.
 - Your own message will be erased.
4. Press **MENU**.
 - The pre-recorded greeting message will be played when transferring a call.

Programming

The unit provides various programming features. Program the desired settings by referring to the programming tables (p. 62–69).

General programming method

1 Press **MENU**.

Display:

SYSTEM SET UP PRESS NAVI. [◀ ▶]

2 Select the feature you wish to program.

■For basic features (p. 62, 63):

Press **◀** or **▶** until the desired feature is displayed.

■For advanced features (p. 64–69):

Press **◀** or **▶** until the following is displayed.

ADVANCED MODE PRESS SET

Press **SET** and press **◀** or **▶** until the desired feature is displayed.

●The current setting of the feature will be displayed.

3 Press **+** or **-** until the desired setting is displayed.

●This step may be slightly different depending on the feature.

4 Press **SET**.

●The setting you selected is set, and the next feature will be displayed.

5 To exit programming, press **MENU**.

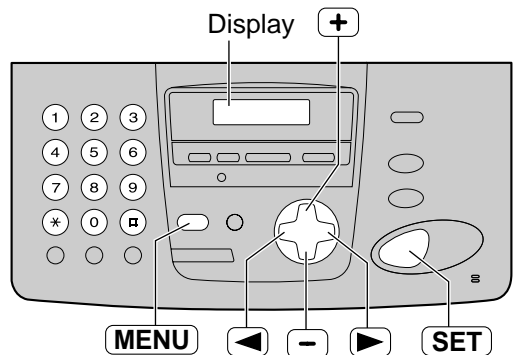

Programming by entering the program code number directly

You can select a feature by directly entering the program code (# and 2-digit number) instead of using **◀** or **▶** in step 2.

1. Press **MENU**.

2. Press **▣** and the 2-digit code number.

3. Follow steps 3 to 5 above.

●See programming tables for code numbers (p. 62–69).

To cancel programming

Press **MENU** to exit the program.

Features Summary

Basic features

The following method of programming is applied except features #01, #02 and #03. For features #01, #02 and #03, refer to the programming table below.

1. Press **MENU**.
2. Press **◀** or **▶** until the desired feature is displayed.
3. Press **+** or **-** until the desired setting is displayed.
4. Press **SET**.
5. Press **MENU**.

Note:

- Step 3 may be slightly different depending on the feature.
- See page 61 for more details.

Programming table

Code	Display & Feature	Settings	How the unit operates
#01	<div style="border: 1px solid black; padding: 2px; width: fit-content;">SET DATE & TIME PRESS SET</div> <p>To set the date and time.</p>	mm/dd/yy hh:mm (2 digits for each entry)	See page 15 for details.
#02	<div style="border: 1px solid black; padding: 2px; width: fit-content;">YOUR LOGO PRESS SET</div> <p>To set your logo.</p>	(Up to 30 characters)	See page 16 for details.
#03	<div style="border: 1px solid black; padding: 2px; width: fit-content;">YOUR FAX NO. PRESS SET</div> <p>To set your facsimile telephone number.</p>	(Up to 20 digits)	See page 18 for details.
#04	<div style="border: 1px solid black; padding: 2px; width: fit-content;">SENDING REPORT MODE=ERROR [±]</div> <p>To print and check the sending report for fax transmission results (p. 31).</p>	ERROR	<p>“ERROR”: The sending report will be printed only when fax transmission fails.</p> <p>“ON”: The sending report will be printed out after every transmission.</p>
		ON	
		OFF	
#06	<div style="border: 1px solid black; padding: 2px; width: fit-content;">TAD RING COUNT RINGS=2 [±]</div> <p>To change the number of rings before the unit answers a call in TAD/FAX mode</p>	1, 2, 3, 4	<p>This setting is also available after activating TAD/FAX mode. See page 47 for details.</p>
		TOLL SAVER	
		RINGER OFF	
#06	<div style="border: 1px solid black; padding: 2px; width: fit-content;">FAX RING COUNT RINGS=3 [±]</div> <p>To change the number of rings before the unit answers a call in FAX ONLY mode</p>	1, 2, 3, 4	<p>This setting is also available after activating FAX ONLY mode (p. 39).</p>

(The default setting is in bold type.)

Features Summary

Code	Display & Feature	Settings	How the unit operates
#10	<div style="border: 1px solid black; padding: 2px; width: fit-content;"> RECORDING TIME MODE=VOX [±] </div> <p>To change the recording time for an incoming message.</p>	VOX	“VOX”: Unlimited “1 MIN”: Up to 1 minute
		1 MIN	
#11	<div style="border: 1px solid black; padding: 2px; width: fit-content;"> REMOTE TAD ID ID=111 </div> <p>To operate the answering device from a remote location.</p>	ID = 111	<ol style="list-style-type: none"> 1. Follow steps 1 and 2 on page 62. 2. Enter any 3-digit number except a number using 0 or 7. 3. Press SET . 4. Press MENU .
#13	<div style="border: 1px solid black; padding: 2px; width: fit-content;"> DIALING MODE MODE=TONE [±] </div> <p>If you cannot dial, change the setting depending on your telephone line service.</p>	TONE	“TONE”: For tone dial service. “PULSE”: For rotary pulse dial service.
		PULSE	
#16	<div style="border: 1px solid black; padding: 2px; width: fit-content;"> PAPER SIZE =LETTER [±] </div> <p>To set the recording paper size.</p>	LETTER	“LETTER”: Letter or legal size paper = Paper width is 216 mm (8½”) “A4”: A4 size paper = Paper width is 210 mm (8¼”)
		A4	
#17	<div style="border: 1px solid black; padding: 2px; width: fit-content;"> RINGER PATTERN MODE=A [±] </div> <p>To set the ringer pattern.</p>	A	You can select the ringer pattern. The selected ringer pattern will sound while setting.
		B	
		C	

(The default setting is in bold type.)

Features Summary

Advanced features

How to set menu options

1. Press **MENU** .
2. Press **◀** or **▶** until the following is displayed.
3. Press **+** or **-** until the desired setting is displayed.
4. Press **SET** .
5. Press **MENU** .

Display:

ADVANCED MODE PRESS SET

Press **SET** and press **◀** or **▶** until the desired feature is displayed.

Note:

- Step 3 may be slightly different depending on the feature.
- See page 61 for more details.

Programming table

Code	Display & Feature	Settings	How the unit operates	
#22	<table border="1" style="display: inline-table; vertical-align: top;"><tr><td style="text-align: center;">AUTO JOURNAL MODE=ON [±]</td></tr></table> To print the journal report automatically for fax communications.	AUTO JOURNAL MODE=ON [±]	ON	"ON": The unit will print the journal report automatically after every 30 new fax communications (p. 31).
		AUTO JOURNAL MODE=ON [±]		
OFF				
#23	<table border="1" style="display: inline-table; vertical-align: top;"><tr><td style="text-align: center;">OVERSEAS MODE MODE=ERROR [±]</td></tr></table> If you have difficulty sending an overseas fax, activate this feature before starting transmission. This feature makes sending documents easier as the transmission speed is slowed down.	OVERSEAS MODE MODE=ERROR [±]	NEXT FAX	"NEXT FAX": This setting is effective only for the next attempted fax transmission. After transmission, the unit will return to the previous setting. "ERROR": When the previous fax transmission fails and you redial the same number. ● This feature is not available for broadcast transmission. ● The calling charge may be higher.
		OVERSEAS MODE MODE=ERROR [±]		
		ERROR		
OFF				
#25	<table border="1" style="display: inline-table; vertical-align: top;"><tr><td style="text-align: center;">DELAYED SEND MODE=OFF [±]</td></tr></table> To send a fax automatically at a specified time. This allows you to take advantage of low-cost calling hours offered by your telephone company. ● The setting can be reserved to take place up to 24 hours in advance.	DELAYED SEND MODE=OFF [±]	ON / fax no. / hh:mm	To send a document: 1. Insert the document. 2. Follow steps 1 and 2 above. 3. Press + or - to select "ON". 4. Press SET . 5. Enter the fax number. 6. Press SET . 7. Enter the transmission start time. Press * to select "AM" or "PM". 8. Press SET . 9. Press MENU . ● To cancel after programming, press STOP then SET .
		DELAYED SEND MODE=OFF [±]		
OFF				
#26	<table border="1" style="display: inline-table; vertical-align: top;"><tr><td style="text-align: center;">AUTO CALL. LIST MODE=ON [±]</td></tr></table> To print the Caller ID list automatically.	AUTO CALL. LIST MODE=ON [±]	ON	"ON": The unit will print the Caller ID list automatically after every 30 new calls (p. 25).
		AUTO CALL. LIST MODE=ON [±]		
OFF				

(The default setting is in bold type.)

Features Summary

Code	Display & Feature	Settings	How the unit operates																								
#30	<div style="border: 1px solid black; padding: 2px; width: fit-content;"> SILENT FAX RING RINGS=3 [±] </div> <p>To change the number of rings when the unit detects a phone call in TEL/FAX mode.</p>	3, 4, 5, 6	See pages 40 and 41 for details.																								
#31	<div style="border: 1px solid black; padding: 2px; width: fit-content;"> RING DETECTION MODE=B [±] </div> <p>If you subscribe to a Distinctive Ring Service (Identa-Ring) from your telephone company, activate this feature. This feature is also required for voice mail service.</p>	A, B, C, D	<p>Select the ring pattern to be assigned to the facsimile number.</p> <p>A: Standard ring (one long ring) B: Double ring (two short rings) C: Triple ring (short-long-short rings) D: Other triple ring (short-short-long rings)</p> <p>●For more information about telephone services, contact your telephone company.</p>																								
		OFF																									
#34	<div style="border: 1px solid black; padding: 2px; width: fit-content;"> QUICK SCAN MODE=OFF </div> <p>To scan the document into memory before sending/copying. This is helpful when you want to remove the document for other uses.</p>	ON	<p>“ON”: The unit will store the documents first and release them.</p> <p>●If the document exceeds the memory capacity (p. 85), sending/copying will be canceled and this feature may be turned OFF automatically.</p>																								
		OFF																									
#36	<div style="border: 1px solid black; padding: 2px; width: fit-content;"> RCV REDUCTION MODE=92% [±] </div> <p>If the size of the document sent by the other party is as large as, or larger than the recording paper, the unit can reduce and print the document. Select the desired reduction rate.</p>	100%	<table border="1"> <thead> <tr> <th>Setting</th> <th>Recording paper</th> <th>Original document</th> </tr> </thead> <tbody> <tr> <td rowspan="2">100%</td> <td>Legal</td> <td>Letter, A4</td> </tr> <tr> <td>A4</td> <td>Letter</td> </tr> <tr> <td rowspan="2">92%</td> <td>Letter</td> <td>Letter</td> </tr> <tr> <td>Legal</td> <td>Legal</td> </tr> <tr> <td>86%</td> <td>A4</td> <td>A4</td> </tr> <tr> <td>86%</td> <td>Letter</td> <td>A4</td> </tr> <tr> <td rowspan="2">72%</td> <td>Letter</td> <td>Legal</td> </tr> <tr> <td>A4</td> <td>Legal</td> </tr> </tbody> </table>	Setting	Recording paper	Original document	100%	Legal	Letter, A4	A4	Letter	92%	Letter	Letter	Legal	Legal	86%	A4	A4	86%	Letter	A4	72%	Letter	Legal	A4	Legal
		Setting		Recording paper	Original document																						
		100%		Legal	Letter, A4																						
				A4	Letter																						
		92%		Letter	Letter																						
				Legal	Legal																						
86%	A4	A4																									
86%	Letter	A4																									
72%	Letter	Legal																									
	A4	Legal																									
92%																											
86%																											
72%																											

(The default setting is in bold type.)

Features Summary

Advanced features (cont.)

How to set menu options

1. Press **MENU**.
2. Press **◀** or **▶** until the following is displayed.
3. Press **+** or **-** until the desired setting is displayed.
4. Press **SET**.
5. Press **MENU**.

Display:

ADVANCED MODE PRESS SET

Press **SET** and press **◀** or **▶** until the desired feature is displayed.

Note:

- Step 3 may be slightly different depending on the feature.
- See page 61 for more details.

Programming table (cont.)

Code	Display & Feature	Settings	How the unit operates	
#39	<table border="1" style="display: inline-table; vertical-align: middle;"><tr><td style="text-align: center;">LCD CONTRAST MODE=NORMAL [±]</td></tr></table> To adjust the display contrast.	LCD CONTRAST MODE=NORMAL [±]	NORMAL	“NORMAL”: For normal contrast “DARKER”: Used when the display contrast is too light.
		LCD CONTRAST MODE=NORMAL [±]		
DARKER				
#41	<table border="1" style="display: inline-table; vertical-align: middle;"><tr><td style="text-align: center;">FAX ACTIVATION MODE=ON [±]</td></tr></table> If you use an extension telephone and wish to use it to receive a fax, activate this feature, and enter the code (p. 42).	FAX ACTIVATION MODE=ON [±]	ON / CODE= * 9	<ol style="list-style-type: none"> 1. Follow steps 1 and 2 above. 2. Press + or - to select “ON”. 3. Press SET. 4. Enter your code from 2 to 4 digits, using 0–9 and *. 5. Press SET. 6. Press MENU. • Do not enter “0000”.
		FAX ACTIVATION MODE=ON [±]		
OFF				
#42	<table border="1" style="display: inline-table; vertical-align: middle;"><tr><td style="text-align: center;">MESSAGE ALERT MODE=OFF [±]</td></tr></table> To alert you with beeps when a new voice message is recorded.	MESSAGE ALERT MODE=OFF [±]	ON	If you hear slow beeps, press PLAY MESSAGES and listen to recorded messages (p. 50). The beeps will stop.
		MESSAGE ALERT MODE=OFF [±]		
OFF				
#43	<table border="1" style="display: inline-table; vertical-align: middle;"><tr><td style="text-align: center;">REC. TIME ALERT MODE=OFF [±]</td></tr></table> To alert you with beeps when there is less than 60 seconds of remaining recording time.	REC. TIME ALERT MODE=OFF [±]	ON	If you hear slow beeps, erase the recorded messages (p. 50, 54). The beeps will stop.
		REC. TIME ALERT MODE=OFF [±]		
OFF				

(The default setting is in bold type.)

Features Summary

Code	Display & Feature	Settings	How the unit operates
#44	<div style="border: 1px solid black; padding: 2px; width: fit-content;">RECEIVE ALERT MODE=ON [±]</div> <p>To alert you with a beeping sound when a document which has been received is stored into memory due to some existing problem.</p>	ON	If you are alerted by a slow beeping sound, clear the printing problem and make sure the unit is supplied with paper to print the stored document. The beeps will stop.
		OFF	
#46	<div style="border: 1px solid black; padding: 2px; width: fit-content;">FRIENDLY RCV MODE=ON [±]</div> <p>To receive a fax automatically when you answer a call and hear a fax calling tone (slow beep).</p>	ON	"ON": You do not have to press FAX/START for fax reception.
		OFF	
#47	<div style="border: 1px solid black; padding: 2px; width: fit-content;">FAX GUIDANCE MODE=ON [±]</div> <p>If you wish to hear the voice guidance (see right) at each fax transmission/reception, set this feature to "ON".</p> <ul style="list-style-type: none"> ●To hear the voice guidance only when fax transmission/reception fails, select "ERROR". 	ON	Voice guidance example: <i>"Start transmission."</i> <i>"Please hang up the handset for transmission."</i> <i>"Transmission is complete."</i> <i>"Transmission has failed."</i> <i>"Transmission has been interrupted."</i> <i>"Start reception."</i> <i>"Please hang up the handset for reception."</i> <i>"Reception is complete."</i> <i>"Reception has failed."</i> <i>"Reception has been interrupted."</i>
		OFF	
		ERROR	
#51	<div style="border: 1px solid black; padding: 2px; width: fit-content;">BOX1 PASSWORD ID=</div> <p>If you wish to prevent other users from retrieving messages, program a password for your mailbox (p. 54).</p>	ID= 555	<ol style="list-style-type: none"> Follow steps 1 and 2 on page 66. Enter a 3-digit number except a number using digits 0 or 7. Press SET . Press MENU .
#52	<div style="border: 1px solid black; padding: 2px; width: fit-content;">BOX2 PASSWORD ID=</div> <p>If you wish to prevent other users from retrieving messages, program a password for your mailbox (p. 54).</p>	ID= 555	<ol style="list-style-type: none"> Follow steps 1 and 2 on page 66. Enter a 3-digit number except a number using digits 0 or 7. Press SET . Press MENU .

(The default setting is in bold type.)

Features Summary

Advanced features (cont.)

How to set menu options

1. Press **MENU**.
2. Press **◀** or **▶** until the following is displayed.
3. Press **+** or **-** until the desired setting is displayed.
4. Press **SET**.
5. Press **MENU**.

Display: ADVANCED MODE
PRESS SET

Press **SET** and press **◀** or **▶** until the desired feature is displayed.

Note:

- Step 3 may be slightly different depending on the feature.
- See page 61 for more details.

Programming table (cont.)

Code	Display & Feature	Settings	How the unit operates
#54	GREETING TIME MODE=16s [±] To change the recording time for your own TAD/FAX greeting message (p. 48).	16s	"16s": Up to 16 seconds "60s": Up to 60 seconds
		60s	
#55	BOX1 GREETING CHECK [±] To check, record or erase the greeting message for mailbox 1.	CHECK	See page 53 for details.
		RECORD	
		ERASE	
#56	BOX2 GREETING CHECK [±] To check, record or erase the greeting message for mailbox 2.	CHECK	See page 53 for details.
		RECORD	
		ERASE	
#60	MESSAGE TRANS. MODE=OFF [±] To transfer a recorded incoming message to another telephone (p. 59).	ON	<ol style="list-style-type: none"> 1. Follow steps 1 and 2 above. 2. Press + or - to select "ON". 3. Press SET. 4. Enter the transfer telephone number. 5. Press SET. 6. Press MENU. ● This feature can be turned on/off from a remote location (p. 58).
		OFF	

(The default setting is in bold type.)

Features Summary

Code	Display & Feature	Settings	How the unit operates
#61	<div style="border: 1px solid black; padding: 2px; width: fit-content;"> TRNS-GREETING CHECK [±] </div> <p>To check, record or erase a transfer greeting message.</p>	CHECK	See page 60 for details.
		RECORD	
		ERASE	
#67	<div style="border: 1px solid black; padding: 2px; width: fit-content;"> ICM MONITOR MODE=ON [±] </div> <p>To hear an incoming message (ICM) from the speaker when the answering device is recording the message.</p>	ON	If you select "OFF", you cannot monitor the incoming message.
		OFF	
#70	<div style="border: 1px solid black; padding: 2px; width: fit-content;"> PAGER CALL MODE=OFF [±] </div> <p>If you have a pager and wish to know when your unit receives a fax or an incoming message, activate this feature.</p>	ON	See page 43 for details.
		OFF	
#76	<div style="border: 1px solid black; padding: 2px; width: fit-content;"> CONNECTING TONE MODE=ON [±] </div> <p>If you often have trouble when sending a fax, this feature allows you to hear connecting tones: fax tone, ring back tone and busy tone.</p>	ON	<p>You can confirm the status of the other party's machine.</p> <ul style="list-style-type: none"> ● If the ring back tone continues, the other party's machine may not be a facsimile or may have run out of paper. Check with the other party. ● The connecting tone volume cannot be adjusted.
		OFF	
#77	<div style="border: 1px solid black; padding: 2px; width: fit-content;"> AUTO ANSWER MODE=TAD/FAX [±] </div> <p>To change the receive mode in the AUTO ANSWER setting.</p>	TAD/FAX	<p>"TAD/FAX": Telephone Answering Device/Facsimile mode (p. 47)</p> <p>"FAX ONLY": Facsimile only mode (p. 39)</p> <p>"TEL/FAX": Telephone/Facsimile mode (p. 40, 41)</p>
		FAX ONLY	
		TEL/FAX	
#78	<div style="border: 1px solid black; padding: 2px; width: fit-content;"> TEL/FAX RING RINGS=2 [±] </div> <p>If you use an extension telephone in TEL/FAX mode, select the desired number of rings of the extension telephone.</p>	1, 2, 3, 4	See pages 40 and 41 for details.
#80	<div style="border: 1px solid black; padding: 2px; width: fit-content;"> SET DEFAULT RESET=NO [±] </div> <p>To reset on advanced features to their default settings.</p>	YES	<ol style="list-style-type: none"> 1. Follow steps 1 and 2 on page 68. 2. Press + or - to select "YES". 3. Press SET . 4. Press SET again. 5. Press MENU .
		NO	

(The default setting is in bold type.)

Error Messages

Reports

If your unit cannot send a fax, check the following:

- the number you dialed is correct,
- the other party's machine is a facsimile.

If the problem remains, correct it by following the communication message printed on the sending and journal reports (p. 31).

Communication message	Error code	Cause & solution
COMMUNICATION ERROR	40–42 46–52 58, 65 68, 72 FF	●A transmission or reception error occurred. Try again or check with the other party.
	43 44	●A line problem occurred. Connect the telephone line cord to a different jack and try again. ●An overseas transmission error occurred. Try using the overseas mode of feature #23 (p. 64).
DOCUMENT JAMMED	—	●The document is jammed. Remove the jammed document (p. 79).
ERROR-NOT YOUR UNIT	54 59 70	●A transmission or reception error occurred because of a problem with the other party's fax machine. Check with the other party.
MEMORY FULL	—	●The document was not received due to memory being full.
NO DOCUMENT	—	●The document was not fed into the unit properly. Reinsert the document and try again.
OTHER FAX NOT RESPOND	—	●The other party's fax machine is busy or has run out of recording paper. Try again. ●The document was not fed properly. Reinsert the document and try again. ●The other party's fax machine rings too many times. Send the fax manually – dial the number, confirm the fax tone, and press FAX/START . ●The other party's machine is not a facsimile. Check with the other party. ●The number you dialed is not in service.
PRESSED THE STOP KEY	—	● STOP was pressed and fax communication was canceled.
OK	—	●Fax communication was successful.

Display

If the unit detects a problem, one or more of the following messages will appear on the display.

Display message	Cause & solution
CALL SERVICE CALL SERVICE2	<ul style="list-style-type: none"> There is something wrong with the unit. Contact our service personnel.
CHECK DOCUMENT	<ul style="list-style-type: none"> The document was not fed into the unit properly. Reinsert the document. If misfeeding occurs frequently, clean the document feeder rollers (p. 80) and try again.
CHECK MEMORY	<ul style="list-style-type: none"> Memory (telephone numbers, parameters, etc.) has been erased. Re-program.
CHECK PAPER	<ul style="list-style-type: none"> The recording paper is not installed or the unit has run out of paper. Install paper and press SET to clear the message. The recording paper is not fed into the unit properly. Reinstall paper (p. 13) and press SET to clear the message. The recording paper has jammed near the recording paper entrance. Clear the jammed paper (p. 78) and press SET to clear the message. Do not install folded or heavily curled paper.
COVER OPEN ↕ CHECK FILM	<ul style="list-style-type: none"> The covers are open. Close them. The ink film is empty. Replace the ink film with a new one (p. 10, 11). The ink film is not installed. Install it (p. 10, 11). The ink film is slack. Tighten it (see step 7 on page 11).
FAX IN MEMORY	<ul style="list-style-type: none"> The unit has a document in memory. See the other displayed message instructions to print out the document.
FAX MEMORY FULL	<ul style="list-style-type: none"> The memory is full of received documents due to a lack of recording paper or a recording paper jam. Install paper or clear the jammed paper. When performing memory transmission, the document being stored exceeds the memory capacity of the unit. Transmit the entire document manually.
DIRECTORY FULL	<ul style="list-style-type: none"> There is no space to store new stations in the directory. Erase unnecessary stations (p. 21).
MEMORY FULL	<ul style="list-style-type: none"> When making a copy, the document being stored exceeds the memory capacity of the unit. Press STOP to clear the message. Divide the document into sections.

(continued)

Error Messages

Display message	Cause & solution
MESSAGE FULL	<ul style="list-style-type: none">● There is no room left in memory to record a voice message. Erase unnecessary messages (p. 50, 54).
MODEM ERROR	<ul style="list-style-type: none">● There is something wrong with the modem circuit. Contact our service personnel.
NO FAX REPLY	<ul style="list-style-type: none">● The other party's fax machine is busy or has run out of recording paper. Try again.
PAPER JAMMED	<ul style="list-style-type: none">● A recording paper jam occurred. Clear the jammed paper (p. 78).
PLEASE WAIT	<ul style="list-style-type: none">● The unit is checking that there is no slack on the ink film. Wait for a while.
REDIAL TIME OUT	<ul style="list-style-type: none">● The other party's fax machine is busy or has run out of recording paper. Try again.
REMOVE DOCUMENT	<ul style="list-style-type: none">● The document is jammed. Remove the jammed document (p. 79).● Attempted to transmit a document longer than 600 mm. Press STOP to remove the document. Divide the document into two or more sheets and try again.
TRANSMIT ERROR	<ul style="list-style-type: none">● A transmission error occurred. Try again.
UNIT OVERHEATED	<ul style="list-style-type: none">● The unit is too hot. Let the unit cool down.

When a function does not work, check here before requesting help

General

Problem	Cause & solution
I cannot make and receive calls.	<ul style="list-style-type: none"> ●The power cord or telephone line cord is not connected. Check the connections (p. 14). ●If you used a splitter to connect the unit, remove the splitter and connect the unit to the wall jack directly. If the unit operates properly, check the splitter.
I cannot make calls.	<ul style="list-style-type: none"> ●The dialing mode setting is wrong. Change the setting of feature #13 (p. 63).
The unit does not work.	<ul style="list-style-type: none"> ●Disconnect the unit from the telephone line and connect the line to a known working telephone. If the working telephone operates properly, contact our service personnel to have the unit repaired. If the working telephone does not operate properly, contact your telephone company.
The unit does not ring.	<ul style="list-style-type: none"> ●The ringer volume is set to off. Adjust it (p. 19). ●The TAD ring count of feature #06 is set to "RINGER OFF". Change to another ring count (p. 62).
The unit displays the following message though the paper is inserted. <div data-bbox="120 996 428 1039" style="border: 1px solid black; padding: 5px; margin: 10px 0;">CHECK PAPER</div>	<ul style="list-style-type: none"> ●The paper is inserted halfway. Insert it correctly (p. 13) and press SET to clear the message.
The other party complains they only hear a fax tone and cannot talk.	<ul style="list-style-type: none"> ●FAX ONLY mode is set. Tell the other party the number is only used for faxes. ●Change to TAD/FAX mode (p. 47), TEL mode (p. 38) or TEL/FAX mode (p. 40).
The REDIAL/PAUSE button does not function properly.	<ul style="list-style-type: none"> ●If this button is pressed during dialing, a pause will be inserted. If pressed immediately after a dial tone is obtained, the last number dialed will be redialed.
The receive mode does not function properly.	<ul style="list-style-type: none"> ●A Distinctive Ring pattern of feature #31 is set (p. 65). ●TEL/FAX mode is set (p. 40, 41).
During programming, I cannot enter the code, mailbox password or ID number.	<ul style="list-style-type: none"> ●All or part of the numbers are the same. Change the code, mailbox password of features #51 and #52 (p. 67) or ID number of features #11 (p. 63) and #41 (p. 66).
The ink film runs out quickly.	<ul style="list-style-type: none"> ●The HELP printing function, copy function, and reports also use ink film.
The unit beeps.	<ul style="list-style-type: none"> ●Recording paper or ink film has run out. Press STOP to stop the beeps and install paper/ink film.
The speakerphone is not working.	<ul style="list-style-type: none"> ●Use the speakerphone in a quiet room. ●If you have difficulty hearing the other party, adjust the volume using + or -. ●If you and the other party speak at the same time, parts of your conversation will be cut off. Speak alternately.

Operations

Fax – sending

Problem	Cause & solution
I cannot send documents.	<ul style="list-style-type: none"> ●The other party's fax machine is busy or has run out of recording paper. Try again. ●The other party's machine is not a facsimile. Check with the other party. ●The other party's fax machine rings too many times. Send the fax manually – dial the number, confirm the fax tone, then press FAX/START .
The other party complains that letters on their received document are distorted or not clear.	<ul style="list-style-type: none"> ●If your line has special telephone services such as call waiting, the service may have been activated during fax transmission. Connect the unit to a line that does not have these services. ●The extension telephone on the same line is off the hook. Hang up the extension telephone and try again. ●Try copying the document. If the copied image is clear, there may be something wrong with the other party's machine.
The other party complains that dirty patterns or black lines appear on their received document.	<ul style="list-style-type: none"> ●The glass or rollers are dirty. Clean them (p. 80).
I cannot send a fax overseas.	<ul style="list-style-type: none"> ●Use the overseas transmission mode of feature #23 (p. 64). ●Add two pauses at the end of the telephone number or dial manually.

Fax – receiving

Problem	Cause & solution
I cannot receive documents automatically.	<ul style="list-style-type: none"> ●The receive mode is set to TEL mode. Set to TAD/FAX mode (p. 47), FAX ONLY mode (p. 39) or TEL/FAX mode (p. 40). ●The time taken to answer the call is too long. Decrease the number of rings of features #06 (p. 62), #30 (p. 65) and #78 (p. 69). ●The greeting message is too long. Shorten the message (p. 48).
The display shows the following message, but faxes are not received. <div style="border: 1px solid black; padding: 2px; width: fit-content; margin-top: 5px;">CONNECTING.....</div>	<ul style="list-style-type: none"> ●The incoming call is not a fax. Change the receive mode to TEL mode (p. 38) or TAD/FAX mode (p. 47).

(continued)

Fax – receiving (cont.)

Problem	Cause & solution
A blank sheet is ejected.	<ul style="list-style-type: none"> ● If a blank sheet is ejected after the received document is printed out, the receiving reduction rate is not programmed correctly. Program the proper rate in feature #36 (p. 65). ● The other party placed the document in their fax machine the wrong way. Check with the other party.
A white line or a dirty pattern appears on your recording paper.	<ul style="list-style-type: none"> ● The glass or rollers are dirty. Clean them (p. 80).
The printing quality is poor.	<ul style="list-style-type: none"> ● The other party sent a faint document. Ask them to send a clearer copy of the document. ● The thermal head is dirty. Clean it (p. 80). ● Some paper has instructions recommending which side to print on. Try turning the paper over. We recommend smooth paper such as Hammermill® Jet Print for clearer printing. ● You may have used paper with a cotton and/or fiber content that is over 20%, such as letterhead or resume paper. We recommend smooth paper such as Hammermill® Jet Print for clearer printing.

Receive mode

Problem	Cause & solution
I cannot select the desired receive mode.	<ul style="list-style-type: none"> ● If you want to set TAD/FAX, FAX ONLY or TEL/FAX mode: <ul style="list-style-type: none"> —select the desired mode using feature #77 (p. 69), and —press AUTO ANSWER to turn ON the arrow (▼) on the right of the display. <p style="text-align: right;">Display: <input data-bbox="967 1139 1259 1197" type="text"/> ▼ ON</p> ● If you want to set TEL mode: <ul style="list-style-type: none"> —press AUTO ANSWER to turn OFF the arrow (▼) on the right of the display. <p style="text-align: right;"><input data-bbox="967 1333 1259 1391" type="text"/> ON</p>
The other party complains that they cannot send a document.	<ul style="list-style-type: none"> ● The unit is not in AUTO ANSWER mode. Press AUTO ANSWER to turn ON the arrow (▼) on the right of the display. <p style="text-align: right;"><input data-bbox="967 1535 1259 1593" type="text"/> ▼ ON</p>

Operations

Copying

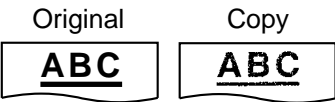
Problem	Cause & solution
The unit does not make a copy.	<ul style="list-style-type: none"> You cannot make a copy during programming. Make the copy after programming or stop programming.
A black line, a white line or a dirty pattern appears on the copied document.	<ul style="list-style-type: none"> The glass or rollers are dirty. Clean them (p. 80).
The copied image is distorted.	<ul style="list-style-type: none"> The thermal head is dirty. Clean it (p. 80).
The printing quality is poor. Original Copy 	<ul style="list-style-type: none"> Some paper has instructions recommending which side to print on. Try turning the paper over. We recommend smooth paper such as Hammermill® Jet Print for clearer printing. You may have used paper with a cotton and/or fiber content that is over 20%, such as letterhead or resume paper. We recommend smooth paper such as Hammermill® Jet Print for clearer printing.

Answering device

Problem	Cause & solution
I cannot retrieve recorded messages from a remote location.	<ul style="list-style-type: none"> Press the remote operation ID correctly and firmly (p. 56).
Messages in the mailbox do not play back.	<ul style="list-style-type: none"> The mailbox password is wrong. Enter the correct password (see feature #51 for mailbox 1 password and feature #52 for mailbox 2 password on page 67).
The other party complains that the following greeting message is played and they cannot leave a voice message. <div style="border: 1px solid black; border-radius: 10px; padding: 10px; margin-top: 10px;"> <p><i>Hello! We are unable to answer right now. To send a fax, please start transmission. To leave a voice message, please try again later. Thank you.</i></p> </div>	<ul style="list-style-type: none"> The memory is full. Erase unnecessary messages (p. 50, 54, 58).
The other party complains that the following greeting message is played and they cannot send a document. <div style="border: 1px solid black; border-radius: 10px; padding: 10px; margin-top: 10px;"> <p><i>Hello! We are unable to answer right now. To send a fax, please try again later. To leave a voice message, please speak after the beep. Thank you.</i></p> </div>	<ul style="list-style-type: none"> The memory is full of received documents due to a lack of recording paper or a recording paper jam. Install paper or clear the jammed paper.

(continued)

Answering device (cont.)

Problem	Cause & solution
<p>The other party complains that the following greeting message is played and they cannot leave a voice message or send a document.</p> <div style="border: 1px solid black; border-radius: 15px; padding: 10px; margin-top: 10px;"> <p><i>Hello! We are unable to answer right now. Please try again later. Thank you.</i></p> </div>	<ul style="list-style-type: none"> ●The memory is full. Erase unnecessary messages (p. 50, 54, 58). ●The memory is full of received documents due to a lack of recording paper or a recording paper jam. Install paper or clear the jammed paper.

If a power failure occurs

- The unit will not function.
- Fax transmission and reception will be interrupted.
- If delayed transmission of feature #25 (p. 64) is programmed and the start time has passed during a power failure, transmission will be attempted soon after power is restored.
- If fax documents are stored in memory, they will be lost. When power is restored, a power down report will be printed out stating which contents in memory have been erased.

Sample of a power down report

POWER DOWN REPORT				
RESTARTED AT:Jan. 05 2001 04:31AM				
YOUR LOGO :				
YOUR FAX NO. :				
<< WARNING >>				
CONTENTS HAVE BEEN CLEARED DUE TO POWER DOWN.				
FOR ADDITIONAL INFORMATION, PLEASE SEE THE JOURNAL REPORT.				
NO.	OTHER FACSIMILE	MODE	PAGES	FUNCTION
01	<FAX # NOT AVAIL.>	RCV	01	MEMORY RECEIVE

Recording paper jam

If the unit does not eject any recording paper during fax reception or copying, the recording paper has jammed and the display will show the following message.

Display: PAPER JAMMED

Remove the jammed paper as follows.

1 Open the front cover by pulling up the center part.

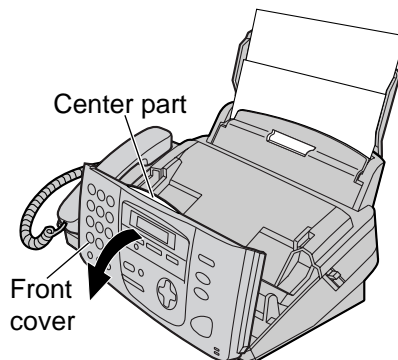

2 Push the back cover open button (green) on the right side of the unit.

OR

Push the back cover open lever (green) inside of the unit.

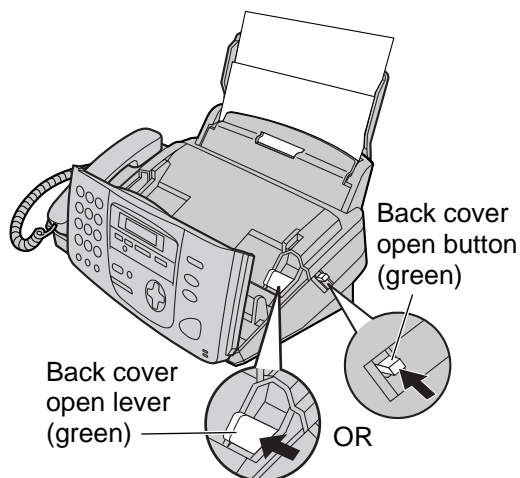

3 Open the back cover.

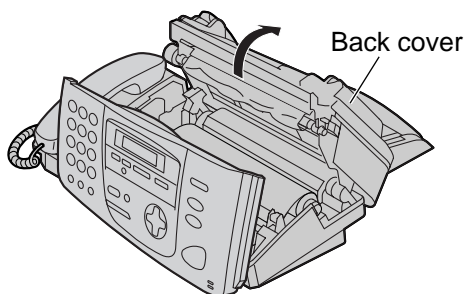

4 Remove the jammed recording paper.

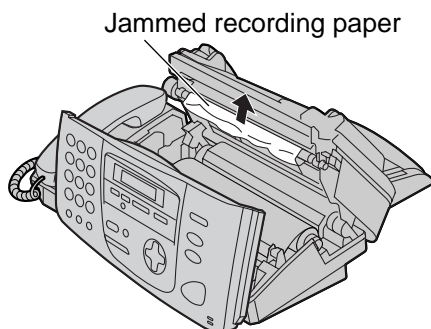

- 5** Turn the “T” shaped gear (blue) in the direction of the arrow.
- Make sure that the ink film is wrapped around the blue core at least once.

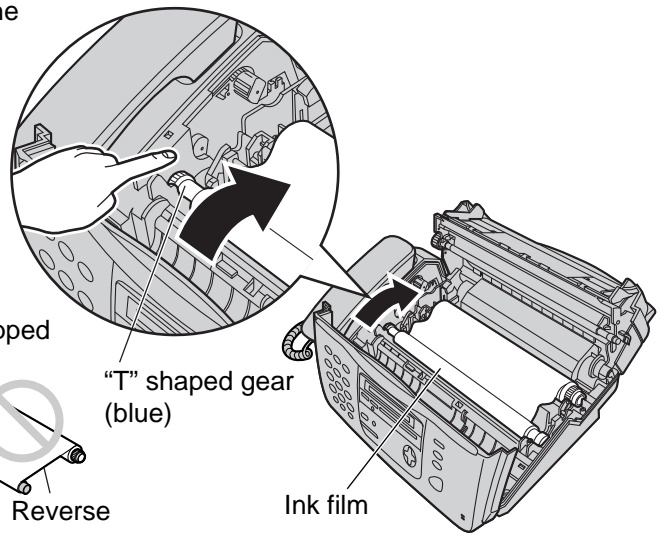
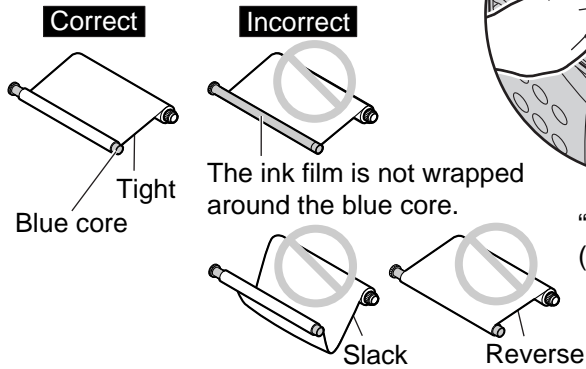

- 6** Close the back cover securely by pushing down on the dotted area at both ends (①). Close the front cover securely (②).

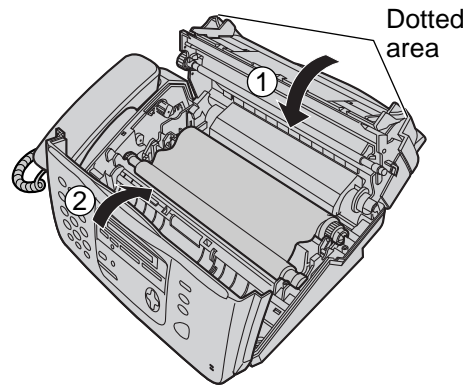

Document jams – sending

If the unit does not release the document during feeding, remove the jammed document as follows.

- 1** Open the front cover by pulling up the center part.
- 2** Remove the jammed document carefully.
- 3** Close the front cover securely.

Note:

- Do not pull out the jammed paper forcibly before opening the front cover.

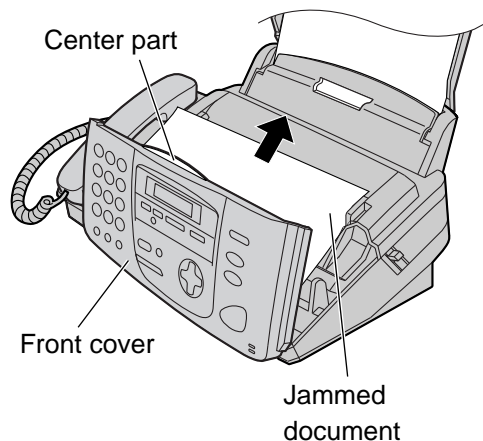

Cleaning

Document feeder

If misfeeding occurs frequently or if dirty patterns or black bands appear on a transmitted document or on the original of a copied document, clean the document feeder.

- 1** Disconnect the power cord and the telephone line cord.
- 2** Open the front cover by pulling up the center part.
- 3** Clean the document feeder rollers and rubber flap with a cloth moistened with isopropyl rubbing alcohol, and let all parts dry thoroughly.
- 4** Clean the glass with a soft dry cloth.
- 5** Close the front cover securely.
- 6** Connect the power cord and the telephone line cord.

Caution:

- Do not use paper products, such as paper towels or tissues, to clean the inside of the unit.

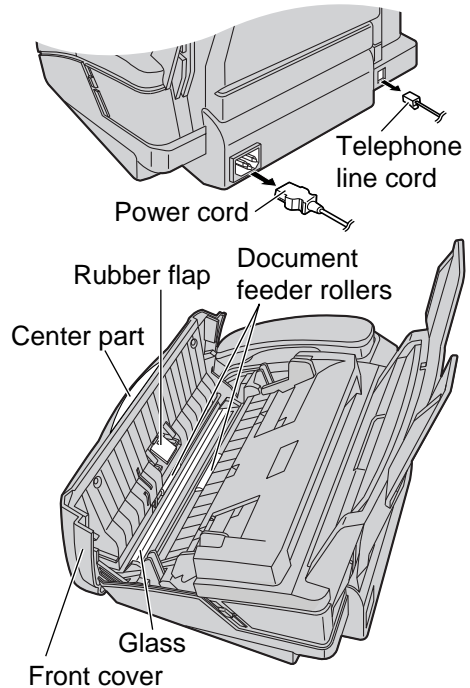

Thermal head

If dirty patterns or black or white bands appear on a copied or received document, check whether there is dust on the thermal head and clean the thermal head to remove the dust.

- 1** Disconnect the power cord and the telephone line cord.
- 2** Open the front cover by pulling up the center part.
- 3** Open the back cover by pushing the back cover open button (green) or pushing the back cover open lever (green).
- 4** Clean the thermal head with a cloth moistened with isopropyl rubbing alcohol, and let it dry thoroughly.
 - Do not touch the black sheets on the thermal head.
- 5** Close the back cover securely by pushing down on the dotted area at both ends. Close the front cover securely.
- 6** Connect the power cord and the telephone line cord.

Caution:

- To prevent malfunction due to static electricity, do not use a dry cloth and do not touch the thermal head directly.

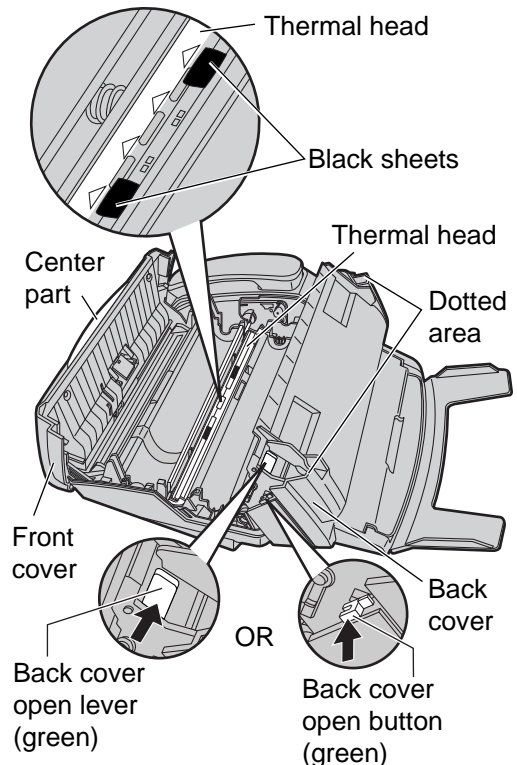

Reference lists and reports

You can print out the following lists and reports for your reference.

Setup list: provides you with the current settings of the basic and advanced programming features (p. 62–69).

Telephone number list: provides you with names and telephone numbers which are stored in the directory.

Journal report: keeps records of fax transmission and reception. This report will be printed automatically after every 30 fax communications (p. 31).

Printer test list: allows you to check the print quality of your unit. If the test print has a dirty pattern, or blurred points or lines, clean the thermal head (p. 80).

Broadcast programming list: provides you with items which are stored in the broadcast feature (p. 33).

Caller ID list: keeps records of the last 30 callers after subscribing to a Caller ID service. This report will be printed automatically after every 30 callers (p. 25).

1 Press **MENU** three times.

Display: PRINT REPORT
PRESS NAVI. [◀ ▶]

2 Press **◀** or **▶** until the desired item is displayed.

SETUP LIST
PRESS SET

TEL NO. LIST
PRESS SET

JOURNAL REPORT
PRESS SET

PRINTER TEST
PRESS SET

BROADCAST LIST
PRESS SET

CALLER ID LIST
PRESS SET

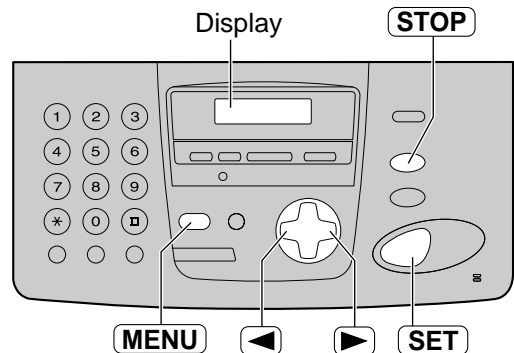

3 Press **SET** to start printing.

PRINTING

- To stop printing, press **STOP**.
- After printing, the printed item will be displayed.

4 Press **MENU**.

List of FCC requirements and information --- ---

If required by the telephone company, inform them of the following.

- FCC Registration No.:
(found on the rear of the unit)
- Ringer Equivalence No.:
(found on the rear of the unit)
- The particular telephone line to which the equipment is connected.

This unit must not be connected to a coin operated line. If you are on a party line, check with your local telephone company.

Ringer Equivalence Number (REN):

This REN is useful in determining the quantity of devices you may connect to your telephone line and still have all of those devices ring when your telephone number is called. In most but not all areas, the sum of the REN's of all devices connected to one line should not exceed five (5.0). To be certain of the number of devices you may connect to your line, as determined by the REN, you should contact your local telephone company to determine the maximum REN for your calling area.

In the event that terminal equipment causes harm to the telephone network, the telephone company should notify the customer, if possible, that service may be stopped. However, where prior notice is impractical, the company may temporarily cease service providing that they:

- a) Promptly notify the customer.
- b) Give the customer an opportunity to correct the problem with their equipment.
- c) Inform the customer of the right to bring a complaint to the Federal Communication Commission pursuant to procedures set out in FCC Rules and Regulations Subpart E of Part 68.

The Telephone Company may make changes in its communications facilities, equipment operations, or procedures where such action is reasonably required in the operation of its business and is not inconsistent with the rules and regulations in FCC Part 68. If such changes can be reasonably expected to render any customer terminal equipment incompatible with telephone company communications facilities, or require modification or

alteration of such terminal equipment, or otherwise materially affect its use or performance, the customer shall be given adequate notice in writing, to allow the customer an opportunity to maintain uninterrupted service.

CAUTION:

Any changes or modifications not expressly approved by the party responsible for compliance could void the user's authority to operate this device.

When programming emergency numbers and/or making test calls to emergency numbers:

1. Remain on the line and briefly explain to the dispatcher the reason for the call before hanging up.
2. Perform such activities in the off-peak hours; such as early morning or late evenings.

This telephone provides magnetic coupling to hearing aids.

NOTE:

This equipment has been tested and found to comply with the limits for a Class B digital device, pursuant to Part 15 of the FCC Rules. These limits are designed to provide reasonable protection against harmful interference in a residential installation. This equipment generates, uses, and can radiate radio frequency energy and, if not installed and used in accordance with the instructions, may cause harmful interference to radio communications. However, there is no guarantee that interference will not occur in a particular installation. If this equipment does cause harmful interference to radio or television reception, which can be determined by turning the equipment off and on, the user is encouraged to try to correct the interference by one or more of the following measures:

- Reorient or relocate the receiving antenna.
- Increase the separation between the equipment and receiver.
- Connect the equipment into an outlet on a circuit different from that to which the receiver is connected.
- Consult the dealer or an experienced radio/TV technician for help.

Limited Warranty

Have any questions? For in warranty support, CALL 1-800-HELP-FAX (1-800-435-7329) on: operating the unit, getting repair service, and/or getting supplies.

**Panasonic Consumer Electronics Company,
Division of Matsushita Electric Corporation
of America**

One Panasonic Way,
Secaucus, New Jersey 07094

**Panasonic Sales Company,
Division of Matsushita Electric of
Puerto Rico, Inc.**

Ave. 65 de Infantería, Km. 9.5, San Gabriel
Industrial Park, Carolina, Puerto Rico 00985

PANASONIC Facsimile Products Limited Warranty

In the event of a defect in materials or workmanship, Panasonic Consumer Electronics Company or Panasonic Sales Company (collectively referred to as "the warrantor"), will repair this product with new or refurbished parts, free of charge, in the USA or Puerto Rico for 6-month limited warranty from the date of original purchase.

This Limited Warranty Excludes both Labor and Parts for: batteries, antennas, ink film, toner cartridge, drum unit, ink cartridge and cosmetic parts (cabinet).

Carry-in or mail-in service in the USA can be obtained during the warranty period by contacting a Panasonic Services Company (PASC) Factory Servicenter listed in the Servicenter Directory. Or call, toll free, 1-800-HELP-FAX (1-800-435-7329) to locate a PASC Factory Servicenter. Carry-in or mail-in service in Puerto Rico can be obtained during the warranty period by calling the Panasonic Sales Company telephone number listed in the Servicenter Directory.

This warranty is extended only to the original purchaser. A purchase receipt or other proof of date of original purchase will be required before warranty service is rendered.

This warranty only covers failures due to defects in material or workmanship which occur during normal use. The inability of this product to interface with any specific computer is not a manufacturing defect and is outside of the scope of this Limited Warranty. In no event shall the warrantor be liable by reason of such incompatibility. The warranty does not cover damages which occur in shipment, or failures which are caused by products not supplied by the warrantor such as non Panasonic ink film, toner cartridge or drum unit, or failures which result from accident, misuse, abuse, neglect, mishandling, faulty installation, misapplication, set-up adjustments, improper operation or maintenance, alteration, modification, power line surge, improper voltage supply, lightning damage, signal reception problems, rental use of the product, or service by anyone other than a PASC Factory Servicenter or a PASC authorized Servicenter, or damage that is attributable to acts of God.

LIMITS AND EXCLUSIONS

There are no express warranties except as listed above.

THE WARRANTOR SHALL NOT BE LIABLE FOR INCIDENTAL OR CONSEQUENTIAL DAMAGES RESULTING FROM THE USE OF THIS PRODUCT, OR ARISING OUT OF ANY BREACH OF THIS WARRANTY. ALL EXPRESS AND IMPLIED WARRANTIES, INCLUDING THE WARRANTIES OF MERCHANTABILITY, ARE LIMITED TO THE APPLICABLE WARRANTY PERIOD SET FORTH ABOVE.

Some states do not allow the exclusion or limitation of incidental or consequential damages, or limitations on how long an implied warranty lasts, so the above exclusions or limitations may not apply to you.

This warranty gives you specific legal rights and you may also have other rights which vary from state to state. If a problem with this product develops during or after the warranty period, you may contact your dealer or Servicenter. If the problem is not handled to your satisfaction, then write to the Customer Satisfaction Center at the company address indicated above.

For product service

- Servicenters are listed on next page.
- Call toll-free 1-800-HELP-FAX (1-800-435-7329) for the location of an authorized servicenter.

For out of warranty technical support

- After the warranty has expired, please contact our Continued Services Technical Support Line at 1-900-555-PANA (1-900-555-7262) for support on a fee basis.

When you ship the product

- Carefully pack your unit, preferably in the original carton.
- Attach a letter, detailing the symptom or problem, to the outside of the carton.
- Send the unit to an authorized servicenter, prepaid and adequately insured.
- Do not send your unit to the Panasonic Consumer Electronics Company or to any executive or regional sales offices. These locations do not repair consumer products.

Servicenter Directory

Servicenter directory

To obtain technical support within the warranty period or product service, please contact: 1-800-HELP-FAX (1-800-435-7329), Monday-Friday 9am-8pm EST.

To obtain continued technical support after the warranty has expired, please contact: 1-900-555-PANA (1-900-555-7262) for support on a fee basis.

Web Site: www.panasonic.com

(for customers in the USA or Puerto Rico ONLY)

You can purchase parts, accessories or locate your nearest servicenter by visiting our Web Site.

Factory Servicenter Locations

<p>CALIFORNIA 6550 Katella Avenue Cypress, CA 90630</p> <p>800 Dubuque Avenue S. San Francisco, CA 94080</p> <p>3878 Ruffin Road Suite A San Diego, CA 92123</p> <p>FLORIDA 3700 North 29th Avenue Suite 102 Hollywood, FL 33020</p>	<p>GEORGIA 8655 Roswell Road Suite 100 Atlanta, GA 30350</p> <p>ILLINOIS 1709 North Randall Road Elgin, IL 60123</p> <p>MASSACHUSETTS 60 Glacier Drive Suite G Westwood, MA 02090</p>	<p>MINNESOTA 7850-12th Avenue South Airport Business Center Bloomington, MN 55425</p> <p>OHIO 2236 Waycross Road Civic Center Plaza Forest Park, OH 45240</p> <p>PENNSYLVANIA 2221 Cabot Blvd. West Suite B Langhorne, PA 19047</p>	<p>TEXAS 13615 Welch Road Suite 101 Farmers Branch, TX 75244</p> <p>WASHINGTON 20425-84th Avenue South Kent, WA 98032</p> <p>HAWAII 99-859 Iwaiwa Street Aiea, Hawaii 96701 Phone (808) 488-1996 Fax (808) 486-4369</p>
---	--	---	---

Service in Puerto Rico

Matsushita Electric of Puerto Rico, Inc. Panasonic Sales Company / Factory Servicenter:
Ave. 65 de Infantería, Km. 9.5, San Gabriel Industrial Park, Carolina, Puerto Rico 00985
Phone (787) 750-4300 Fax (787) 768-2910

Technical data about this product

Applicable Lines:	Public Switched Telephone Network
Document Size:	Max. 216 mm (8½") in width / Max. 600 mm (23⅝") in length
Effective Scanning Width:	208 mm (8¾")
Recording Paper Size:	Letter: 216 mm x 279 mm (8½" x 11") Legal: 216 mm x 356 mm (8½" x 14") A4: 210 mm x 297 mm (8¼" x 11⅛")
Effective Printing Width:	208 mm (8¾")
Transmission Time*:	Approx. 15 s/page (Original mode)**
Scanning Density:	Horizontal: 8 pels/mm (203 pels/inch) Vertical: 3.85 lines/mm (98 lines/inch) –STANDARD 7.7 lines/mm (196 lines/inch) –FINE/PHOTO 15.4 lines/mm (392 lines/inch) –SUPER FINE
Halftone Level:	64-level
Scanner Type:	Contact Image Sensor (CIS)
Printer Type:	Thermal Transfer on plain paper
Data Compression System:	Modified Huffman (MH), Modified READ (MR)
Modem Speed:	9,600 / 7,200 / 4,800 / 2,400 bps; Automatic Fallback
Operating Environment:	5 °C – 35 °C (41 °F – 95 °F), 20 % – 80 % RH (Relative Humidity)
Dimensions (H x W x D):	185 mm x 345 mm x 269 mm (7⅞" x 13⅜" x 10⅞")
Mass (Weight):	Approx. 3.1 kg (6.8 lb.)
Power Consumption:	Standby: Approx. 3.6 W Transmission: Approx. 18 W Reception: Approx. 42 W (When receiving a 20% black document) Copy: Approx. 42 W (When copying a 20% black document) Maximum: Approx. 135 W (When copying a 100 % black document)
Power Supply:	120 V AC, 60 Hz
Memory Capacity:	Voice memory***: Approx. 18 minutes of recording time including greeting messages Fax memory: Approx. 25 pages of memory transmission Approx. 28 pages of memory reception (Based on the ITU-T No. 1 Test Chart in standard resolution.)

* Transmission speed depends upon the contents of the pages, resolution, telephone line conditions and capability of the other party's machine.

** Transmission speed is based upon the ITU-T No. 1 Test Chart and original mode.

If the capability of the other party's machine is inferior to your unit, the transmission time may be longer.

*** Recording time may be reduced by the calling party's background noise.

ITU-T No. 1 Test Chart

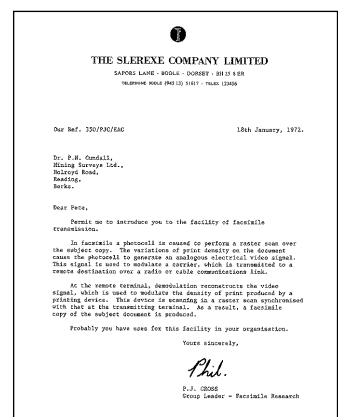

Note:

- Any details given in these instructions are subject to change without notice.
- The pictures and illustrations in these instructions may vary slightly from the actual product.

Index

- A**
 - A4 paper guide12
 - Accessories6
 - Advanced features64–69
 - Alert
 - (Memory reception)(Feature #44) .67
 - (Message)(Feature #42)66
 - (Recording time)(Feature #43) . . .66
 - AUTO ANSWER button . .38, 39, 40, 47
 - Auto Answer setting (Feature #77) . .69
- B**
 - Basic features62, 63
 - Broadcast sending report35
 - Broadcast transmission32
- C**
 - Call counter50
 - Caller ID23
 - (Calling back)24
 - (Storing into directory)26
 - Caller ID list (Feature #26)25, 64
 - CALLER ID button24
 - Caller's recording time (Feature #10) .63
 - Character table17
 - Cleaning80
 - Collation46
 - Communication messages70
 - Connecting tone (Feature #76)69
 - Connections14, 42
 - Copy44
- D**
 - Date and time (Feature #01)15
 - Delayed transmission (Feature #25) . .64
 - Delete button17
 - Dialing mode (Feature #13)63
 - DIGITAL SP-PHONE button28
 - Directory
 - (Making a phone call)22
 - (Selecting characters)17
 - (Sending faxes)29
 - (Storing)20
 - Display
 - (Contrast)(Feature #39)66
 - (Error messages)71, 72
 - Distinctive ring service
 - (Feature #31)65
 - Document jam79
 - Document size30
- E**
 - Enlarge copy45
 - ERASE button49, 50
 - Error messages70–72
 - Extension telephone41, 42
- F**
 - Facsimile telephone number
 - (Feature #03)18
 - Fax activation code
 - (Feature #41)42, 66
 - Fax auto redial29
 - FAX ONLY mode39
 - Fax receiving36, 37
 - Fax ring count (Feature #06)62
 - Fax voice guidance (Feature #47) . . .67
 - Fax voice guide30
 - Friendly reception (Feature #46) .38, 67
- G**
 - Greeting message
 - (Message transfer)(Feature #61) .60, 69
 - (TAD/FAX)47–49
 - (TEL/FAX)40, 41, 48, 49
 - (Voice mailbox)(Feature #55, #56) . 53, 68
- H**
 - Handset receiver volume19
 - HELP button7
 - Hyphen button17
- I**
 - Incoming message monitor
 - (Feature #67)69
 - Ink film10, 11
 - Insert button17
- J**
 - Jams78, 79
 - Journal report (Feature #22)31, 64
- L**
 - List
 - (Broadcast programming)81
 - (Broadcast sending)35
 - (Caller ID)81
 - (Journal)31, 81
 - (Printer test)81
 - (Sending)31
 - (Setup)81
 - (Telephone number)81
 - Logo (Feature #02)16
- M**
 - Memory reception38
 - Message alert (Feature #42)66
 - Message transfer (Feature #60) . .59, 68
- O**
 - Overseas mode (Feature #23)64
- P**
 - Pager call (Feature #70)43, 69
 - Paper jam78
 - Paper size (Feature #16)63
 - Paper tray12
 - Power down report77
 - Power failure77
 - Power supply85

- Q** Quick scan (Feature #34) . . .28, 46, 65
- R** Receiving alert (Feature #44)67
- Receiving reduction (Feature #36) . . .65
- Receiving setting36, 37
- Recording
 - (Greeting message)48, 53, 60
 - (Memo message)51, 52
 - (Telephone conversation)51
- Recording paper13
- Recording paper size85
- Recording time alert (Feature #43) . .66
- Recording time for TAD/FAX greeting message (Feature #54)68
- REDIAL button28
- Reduce copy45
- Remote operation card55, 56
- Remote operation ID (Feature #11) . .63
- Report
 - (Broadcast sending)35
 - (Journal)31, 81
 - (Sending)31
- Reset (Feature #80)69
- Resolution28, 44
- Ring count
 - (FAX ONLY)(Feature #06)62
 - (Silent fax)(Feature #30)65
 - (TAD/FAX)(Feature #06)62
 - (TEL/FAX)(Feature #78)69
- Ring detection (Feature #31)65
- Ringer pattern (Feature #17)19, 63
- Ringer volume19
- S** Sending
 - (Broadcast)35
 - (Directory)29
 - (From memory)28
 - (Manually)28
- Sending report (Feature #04)31, 62
- Set default (Feature #80)69
- Silent fax recognition ring
 - (Feature #30)40, 41, 65
- SLOW button50
- Speaker volume19
- Specifications85
- Storing
 - (Broadcast)33
 - (Directory)20
- T** TAD/FAX mode47
- TAD/FAX ring count (Feature #06)47, 62
- TEL mode38
- TEL/FAX delayed ring count
 - (Feature #78)40, 41, 69
- TEL/FAX mode40
- Toll saver47
- Transmission
 - (Broadcast)35
 - (Directory)29
 - (From memory)28
 - (Manually)28
- V** Voice contact27
- Voice mailbox52
- Voice mailbox password
 - (Feature #51, #52)54, 67
- Voice time/day stamp50
- VOLUME button19

Panasonic FAX ADVANTAGE PROGRAM

*Free peace of mind,
direct from Panasonic*

NO EXTRA COST



- **6-month limited warranty¹: parts, labor, and toll-free help line²**
- **Free replacement³ and repair program**

The Panasonic Fax Advantage Consumer Service Program.

Panasonic knows that if your fax machine is not up and running, neither is your business. That's why we created the Panasonic Fax Advantage Program. Included at no extra cost with the purchase of a new and unused Panasonic Fax Machine, the Fax Advantage Program can provide a free replacement unit³ if your original unit is in need of repair.

Here's how it works:

1. If you have a problem with your fax that you purchased new and unused while it is covered by the period of limited warranty¹, call our toll-free help-line at 1-800-HELP-FAX².
2. Talk to one of our technical experts to diagnose your problem over the phone.
3. If repairs are necessary and you are entitled to service under the terms and conditions of the limited warranty⁴, we will send a refurbished replacement unit to you by UPS Ground service delivery. The shipping method is upgradable for an extra charge.

A second option available under our limited warranty is to mail-in or carry-in your fax to one of our Regional Service centers, where the unit will be repaired and returned to you.

Instructions:

If you choose to receive a replacement unit under the Fax Advantage Program, Panasonic will provide a replacement unit which will be completely refurbished, quality-tested by Panasonic technicians and individually hand-inspected before it is shipped to you. You will keep the replacement unit and send the original unit to us in the replacement unit's box. UPS will pick up the unit at no charge to you, should it be determined that you are entitled to warranty service. A proof-of-purchase must be included with the returned product. Any unit that is replaced by Panasonic and not shipped with proper proof-of-purchase by you will be subject to a minimum \$100.00 charge. The original unit must be properly packaged in the same manner as the replacement unit, utilizing the packing materials provided. Damage due to improper or inadequate packing will be charged to you as an out-of-warranty cost.

If our 1-800-HELP-FAX technicians determine that your unit may be an "out-of-box failure"⁵, we will attempt to provide you with a factory-new replacement unit⁶. You must ship a copy of your receipt with your original unit to verify that you purchased the unit within 10 days prior to your 1-800-HELP-FAX call.

Requirements:

You must give our technicians a valid credit card number (Discover, VISA, Master Card, or American Express/Optima). Product that is not returned to Panasonic by 10 business days after shipment of the replacement product will be charged to your credit card account at Panasonic's Suggested Retail Price (see dealer for details). If your original unit is not eligible for warranty service, your card will be charged for the non-warranty repair of the unit at Panasonic's current rate for parts and labor and for any shipping charges associated with this program. If you do not wish to pay out-of-warranty repair costs, you will be responsible for returning the replacement unit to Panasonic and for paying all shipping charges associated with this program including the UPS delivery of the replacement product to you, shipment of the problem unit to Panasonic, shipment of the replacement unit back to Panasonic and the return of your original unit back to you. Credit status will be verified prior to sending the replacement product.

1. See dealer for limited warranty details.
2. After the fax advantage program, contact our Continued Services Technical Support Line at 1-900-555-PANA (1-900-555-7262), for fee based technical support.
3. Replacement unit is refurbished.
4. Replacement program is only available in the 50 United States and is subject to termination at any time without advance notice.
5. "Out-of-box failure" is an inoperable unit that was purchased no more than 10 days prior to your 1-800-HELP-FAX call, and would otherwise qualify for warranty service under the terms and conditions of the limited warranty.
6. Panasonic reserves the right to send a refurbished unit.

Panasonic Consumer Electronics Company, Division of Matsushita Electric Corporation of America
One Panasonic Way,
Secaucus, New Jersey 07094

Panasonic Sales Company, Division of Matsushita Electric of Puerto Rico, Inc.
Ave. 65 de Infantería, Km. 9.5
San Gabriel Industrial Park, Carolina,
Puerto Rico 00985