



BROWNING®

The Best There Is.

OWNER'S MANUAL

VERY IMPORTANT:

Save This Booklet. Carefully read this entire manual before using your new Browning firearm.

9mm & .40 S&W

**SINGLE ACTION
HI-POWER PISTOL**

NEW GUN OWNERS RECORD

KEEP THIS RECORD FOR FUTURE REFERENCE

Browning Model

Serial Number

Gauge / Caliber

Purchase Price

Purchased From

Date of Purchase

***We are pleased that you have chosen a
Browning Single Action Hi-Power pistol.***

The Browning Hi-Power pistol sets a standard on which other auto-loading pistols are judged, Nearly every semi-auto pistol on the market today incorporates some of the Browning Hi-Power's design features. The Browning Hi-Power is truly a classic design that should give you many years of dependable, enjoyable service. This manual covers many versions of the 9mm Single Action Hi-Power, as well as the .40 S&W Hi-Power. Since the 9mm Hi-Power and the .40 S&W are very similar in appearance, examine every cartridge you load in your Hi-power pistol. The caliber of your Hi-Power is inscribed on the right side of the barrel. Failure to use correct ammunition may result in serious injury. Please feel free to write us immediately if you have any important observations regarding your pistol's performance and operation.

Thank you.



*One Browning Place, Morgan, Utah 84050-9326
Distributed in Canada by Canada Sports Ltd./Lee,
5617 Chemin St-Francois, St-Laurent, Quebec, Canada H4S 1W6*

Printed in Portugal

96.5

9mm & .40 S&W SINGLE ACTION HI-POWER PISTOL

You Are Responsible For Firearms Safety

As a gun owner, you accept a set of demanding responsibilities. How seriously you take these responsibilities can mean the difference between life and death.

THERE IS NO EXCUSE FOR CARELESS OR ABUSIVE HANDLING OF ANY FIREARM. AT ALL TIMES HANDLE YOUR HI-POWER PISTOL AND ANY OTHER FIREARM WITH INTENSE RESPECT FOR ITS POWER AND POTENTIAL DANGER.

READ AND UNDERSTAND THE CAUTIONS AND PROPER HANDLING PROCEDURES OUTLINED IN THIS BOOKLET BEFORE USING YOUR NEW FIREARM.

- 1 **ALWAYS KEEP THE MUZZLE OF YOUR PISTOL POINTED IN A SAFE DIRECTION.**

Never point any firearm at anything you do not intend to shoot. Be extremely alert and aware of all persons and property within the range of your ammunition.

- 2 **NEVER RELY TOTALLY ON YOUR FIREARM'S MECHANICAL "SAFETY" DEVICES. ALWAYS ASSUME THAT YOUR PISTOL CAN BE FIRED AT ANY TIME, EVEN WITH ALL SAFETY MECHANISMS ENGAGED.**

LIKE ANY MECHANICAL DEVICE, A "SAFETY" CAN SOMETIMES FAIL; IT CAN BE JARRED OR INADVERTENTLY MANIPULATED INTO AN UNSAFE CONDITION.

Mechanical "safeties" merely aid safe gun handling and are no excuse for pointing your gun's muzzle in an unsafe direction. While it is a good idea to "test" your gun's mechanical "safeties" periodically for proper function, never test them while your pistol is loaded or pointed in an unsafe direction. Do not carry this pistol with the hammer in the half cock position. The half cock notch is pro-

vided only as a means of catching the hammer if it should accidentally slip from the shooter's thumb during the process of cocking. Carefully follow the procedures for lowering the hammer from the cocked to the dropped position explained later in this manual.

Safe gun handling does not stop with your gun's mechanical "safety" devices—it starts there. Always treat this pistol with the respect due a loaded, ready-to-fire pistol.

- 3 **DO NOT CARRY YOUR HI-POWER WITH A ROUND IN THE CHAMBER.**

For good safety practice, it is recommended that a round not be chambered until immediately before your pistol is to be fired.

- 4 **THE RECOMMENDED CARRYING POSITION OF THE HI-POWER IS WITH THE HAMMER IN THE DROPPED POSITION.**

Carefully follow the procedures for lowering the hammer from the cocked to the decocked position explained later in this booklet.

- 5 **WHENEVER YOU HANDLE YOUR HI-POWER, OR HAND IT TO SOMEONE, MAKE SURE IT IS COMPLETELY UNLOADED.**

To fully unload your Hi-Power, you must first remove the magazine, open and lock the slide rearward, and visually inspect the chamber to be certain it does not contain a cartridge. It is vital that you remove the magazine from your pistol so a cartridge is not automatically chambered when you close the action.

- 6 **DO NOT TRANSPORT YOUR PISTOL LOADED.**

Keep it unloaded, whether stored in a holster, gun case, or other container.

- 7 **BEWARE OF BARREL OBSTRUCTIONS.**

When preparing to shoot your pistol, check for a barrel obstruction as follows: first fully unload the pistol by removing the magazine, locking the action open and inspecting the chamber. **BE CERTAIN NO LIVE ROUND IS IN THE CHAMBER.** Then glance down the barrel to be sure it is clear of any obstruction. It takes only a small obstruction to dangerously increase pressures. Before the first firing, clean the bore with a cleaning rod and patch, and wipe away any

anti-rust compounds in the chamber and around the action.

BE ALERT TO THE SIGNS OF AMMUNITION MALFUNCTION.

If you detect an off sound or light recoil when a cartridge is fired, do not load another cartridge into the chamber. Fully unload by removing the magazine and removing the cartridge from the chamber. With the action open, glance down the barrel to make sure that an obstruction does not remain in the barrel. If there is an obstruction, completely clear the barrel before loading and firing again. Failure to follow these instructions can cause extensive damage to your gun and possible serious injury to yourself and others.

8 BE CERTAIN YOUR PISTOL IS COMPLETELY UNLOADED BEFORE CLEANING.

Because so many gun accidents occur when a firearm is being cleaned, special and extreme care should be taken to be sure your gun is unloaded before disassembly, cleaning and

reassembly. Keep ammunition away from the cleaning location. Never test the mechanical function of any firearm with live ammunition.

9 ALWAYS COMPLETELY UNLOAD YOUR PISTOL WHEN NOT IN USE.

Your responsibilities do not end when your firearm is unattended. Store your pistol and ammunition separately and well beyond the reach of children. Take all safeguards to ensure that your pistol does not become available to untrained, inexperienced or unwelcome hands.

10 USE THE PROPER AMMUNITION.

The barrel and action of this pistol have been made with substantial safety margins over the pressures developed by established American commercial loads.

HOWEVER, BROWNING ASSUMES NO LIABILITY FOR ACCIDENTS WHICH OCCUR THROUGH THE USE OF CARTRIDGES OF NON-STANDARD DIMENSIONS OR THAT DEVELOP PRESSURES IN EXCESS OF COMMERCIALY AVAILABLE AMMUNITION THAT HAS BEEN LOADED IN

ACCORDANCE WITH STANDARDS ESTABLISHED BY THE SPORTING ARMS AND AMMUNITION MANUFACTURERS' INSTITUTE (SAAMI).

EXAMINE EVERY CARTRIDGE YOU PUT IN YOUR HI-POWER PISTOL. THE CALIBER OF YOUR HI-POWER IS INSCRIBED ON THE RIGHT SIDE OF THE BARREL. THE 9MM HI-POWER MUST BE USED ONLY WITH 9MM LUGER (PARABELLUM) CARTRIDGES. THE .40 S&W HI-POWER MUST BE USED ONLY WITH .40 S&W CARTRIDGES. FAILURE TO USE CORRECT AMMUNITION MAY RESULT IN SERIOUS INJURY TO YOURSELF OR OTHERS.

Browning cannot assume any responsibility for the use of unsafe or improper arms and ammunition combinations. It is your responsibility to read and heed all warnings in the instruction manual and on ammunition boxes.

MAKE SURE OF ADEQUATE VENTILATION IN THE AREA THAT YOU DISCHARGE A FIREARM. WASH HANDS THOROUGHLY AFTER EXPOSURE TO AMMUNITION OR CLEANING A FIREARM.

Lead exposure can be obtained from discharging firearms in poorly ventilated areas, cleaning firearms or handling ammunition. Lead is a substance that has been known to cause birth defects, reproductive harm and other serious injury.

11 DO NOT SNAP THE FIRING PIN ON AN EMPTY CHAMBER — THE CHAMBER MAY NOT BE EMPTY!

Treat every gun with the respect due a loaded gun, even though you are certain the gun is unloaded.

12 KEEP YOUR FINGERS AWAY FROM THE TRIGGER WHILE COCKING THE HAMMER, UNLOADING, LOADING AND REMOVING THE MAGAZINE, UNTIL YOU ARE READY TO SHOOT.

13 BE SURE OF YOUR TARGET AND BACKSTOP.

Take additional care during low light periods. Know the range of your ammunition. Never shoot at water or hard objects.

14 DROPPING YOUR HI-POWER PISTOL WHEN LOADED CAN CAUSE AN ACCIDENTAL

DISCHARGE EVEN WITH THE HAMMER IN THE DROPPED POSITION.

Be extremely careful while hunting or during any shooting activity, to avoid dropping any firearm.

- 15 **ALWAYS COMPLETELY UNLOAD YOUR PISTOL'S CHAMBER BEFORE CROSSING A FENCE, CLIMBING A TREE, JUMPING A DITCH OR NEGOTIATING OTHER OBSTACLES.**

Never place your pistol on a car, or on any unstable object.

- 16 **IF YOUR HI-POWER FAILS TO FIRE, KEEP THE MUZZLE POINTED IN A SAFE DIRECTION.**

Hold this position for a minimum of 30 seconds. Remove the magazine. Carefully open the action and remove the cartridge. If the primer is indented, the cartridge should be disposed of in a way that cannot cause harm. If the primer is not indented, completely unload the pistol. Your firearm should be examined by a qualified gunsmith and the cause of the malfunction should be corrected before further use.

- 17 **WEAR EYE AND EAR PROTECTION WHEN SHOOTING.**

Unprotected, repeated exposure to gunfire can cause hearing damage. Wear ear protectors (shooting ear plugs or muffs) to guard against such damage. Wear shooting glasses to protect your eyes from flying particles. Always keep a safe distance between the muzzle of your firearm and any persons nearby, as muzzle blast, debris and ejecting shells could inflict serious injury. Also, wear eye protection when disassembling and cleaning your pistol to prevent the possibility of springs, spring-tensioned parts, solvents or other agents from contacting your eyes.

- 18 **BE DEFENSIVE AND ON GUARD AGAINST UNSAFE GUN HANDLING AROUND YOU AND OTHERS.**

Don't be timid when it comes to gun safety. If you observe other shooters violating any of these safety precautions, politely suggest safer handling practices.

- 19 **SUPERVISE AND TEACH FIREARMS SAFETY TO ALL MEMBERS OF YOUR FAMILY.**

This is especially important when children and nonshooters are involved. Closely supervise newcomers to the shooting sports. Encourage enrollment in hunting/shooting safety courses.

- 20 **NEVER DRINK ALCOHOLIC BEVERAGES OR TAKE ANY TYPE OF DRUGS BEFORE OR DURING SHOOTING.**

Your vision and judgment could be dangerously impaired, making your gun handling unsafe to you or to others.

- 21 **PERIODIC MAINTENANCE — AVOID UNAUTHORIZED SERVICING.**

Your Hi-Power is a mechanical device which will not last forever, and as such, is subject to wear and requires periodic inspection, adjustment, and service. Like all Browning firearms, your pistol should be serviced by a Browning Recommended Service Center or by Browning's service facility in Arnold, Missouri. Browning cannot assume any responsibility for injuries suffered or caused by unauthorized servicing, alterations or modifications of Browning firearms.

- 22 **BROWNING RESERVES THE RIGHT TO REFUSE SERVICE ON FIREARMS THAT HAVE BEEN ALTERED, ADDED TO OR SUBSTANTIALLY CHANGED.**

Removal of metal from the barrel(s), or modifications of the firing mechanism and/or operating parts may lead to Browning's refusal of service on such firearms. Browning will charge the owner for parts and labor to return the firearm to original Browning specifications.

Read and heed all warnings in this instruction book, on ammunition boxes and with all accessories that you install on your firearm. It is your responsibility to secure the most up-to-date information on the safe handling procedures for your Browning gun. Browning assumes no liability for incidents which occur when unsafe or improper guns accessories or ammunition combinations are used.

IT CAN BE VERY DANGEROUS TO ALTER FIRING MECHANISM PARTS OF THIS OR ANY OTHER FIREARM.

BE CAREFUL!

Figure 1



Nomenclature

In conventional gun terminology, the position and movement of pistol parts are described as they occur

with the pistol horizontal and in normal firing position; i.e. the muzzle is forward or front, the pistol grip is rearward or rear, the trigger is downward or underneath, the sights are upward or on top. For general nomenclature refer to figure 1.

Serial Number

The serial number of your Hi-Power pistol can be found stamped on the front of the frame, directly under the trigger guard.

Initial Cleaning

BEFORE THE FIRST FIRING, CLEAN THE ANTI-RUST COMPOUND from the inside of the barrel and frame with a clean rag and light gun oil such as Browning Oil. For general cleaning procedures see "Care and Cleaning" on page 14.

Ammunition

As indicated by the inscription on the exposed portion of the barrel, the 9mm Hi-Power must be used only with 9mm Luger (Parabellum) cartridges. The .40 S&W Hi-Power must be used only with .40 S&W cartridges. The barrel and action of this pistol have been made

with substantial safety margins over the pressures developed by established American loads. Nevertheless, Browning can assume no responsibility for incidents

which occur through the use of cartridges of nonstandard dimensions or those developing pressures in excess of SAAMI (Sporting Arms and Ammunition Manufacturers' Institute) established standards.

EXAMINE EVERY CARTRIDGE YOU PUT IN YOUR HI-POWER PISTOL. THE CALIBER OF YOUR HI-POWER IS INSCRIBED ON THE RIGHT SIDE OF THE BARREL. DO NOT USE AMMUNITION OTHER THAN THAT INSCRIBED ON THE BARREL OF YOUR HI-POWER PISTOL. FAILURE TO USE CORRECT AMMUNITION MAY RESULT IN SERIOUS INJURY TO YOURSELF OR OTHERS.

Ammunition

	Ammo	Mag. ** Capacity
9mm Single Action Hi-Power	9mm Luger (Parabellum)	13*
.40 S&W Single Action Hi-Power	.40 S&W	10

* With certain brands of ammunition, it may be possible to load 14 rounds into the magazine.

** The 9mm is also supplied with 10 round capacity magazine where required by law.

Figure 2



Figure 3



Figure 4

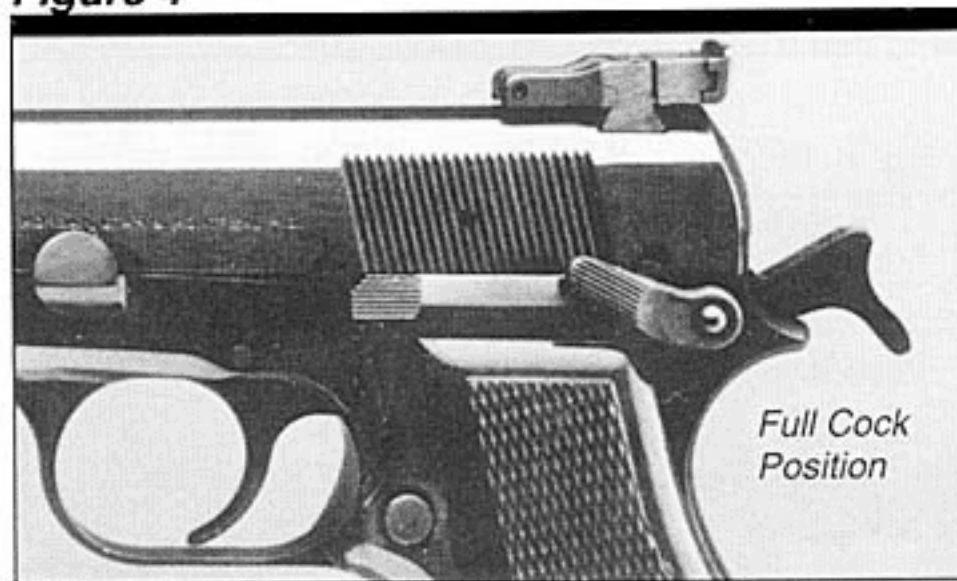

In the dropped position, the hammer is fully fallen and resting against the inertia firing pin. The firing pin is not in contact with the cartridge primer. (This is the design nature of the inertia firing pin; the firing pin must be struck forcefully by the hammer in order to achieve enough momentum to contact and indent the primer, causing cartridge ignition.)

HALF COCK POSITION —

The half cock hammer position is between the dropped and full cock position (see figure 3).

General Operation

Your Browning Hi-Power is a recoil-operated, semi-automatic pistol. With the chamber and magazine loaded, the "safety" in the "off safe" or fire position, and the hammer cocked, the pistol will fire a single round with each successive pull of the trigger until the magazine and chamber are empty. The slide of this pistol is designed to stay open after the last cartridge has been fired.

Operation of the Hammer

The Browning Single Action pistol has an exposed hammer with dropped, half cock, and full cock positions. The hammer spur is serrated to help insure positive control while manually cocking and lowering the hammer.

DROPPED POSITION —

This is the recommended carrying position of the pistol whether there is a round in the chamber or not (see figure 2).

DO NOT CARRY A ROUND IN THE CHAMBER.

DO NOT CARRY OR STORE THE PISTOL IN THE HALF COCK POSITION.

It is provided only as a means of catching the hammer, if the hammer should slip from the shooter's thumb while lowering the hammer from the full cock to dropped position or when cocking the pistol.

CAUTION: IF THE HAMMER SHOULD SLIP WHILE THE TRIGGER IS DEPRESSED, THE HALF COCK NOTCH WILL NOT PREVENT THE HAMMER FROM STRIKING THE FIRING PIN. THEREFORE, KEEP YOUR FINGER OFF THE TRIGGER WHEN YOU ARE COCKING THE HAMMER, AND WHEN YOU ARE LOWERING THE HAMMER.

FULL COCK POSITION —

The hammer is all the way to the rear (see figure 4). In the full cock position, with the thumb "safety" in the "off safe" position, and with a cartridge in the chamber, the pistol is ready to fire by pulling the trigger.

Browning Hi-Power Semi-Automatic Pistol

When ordering parts please indicate the model name, serial number, stock style, and exterior finish. **Do not order parts using key numbers.**

Key No.	Parts No.	Description	Key No.	Parts No.	Description
01	PO55520	Barrel 9mm	24	PO55538	Recoil Spring Guide Assy. w/ Slide Stop, Retain. Balls, Spring
01	PO55906	Barrel 40 S&W	25	* PO55380	Safety Lever Assembly Left, Ambidextrous, Blue
02	PO55598	Ejector	25	* PO55472	Safety Lever Left (90), Practical
02	PO55913	Ejector .40 S&W	26	* PO55381	Safety Lever Right, Ambidextrous, Blue
03	PO55615	Extractor	26	* PO55473	Safety Lever Right (90), Practical
03	PO55909	Extractor .40 S&W	27	PO55383	Safety Lever Retaining Pin, Ambidextrous, Blue
04	PO55617	Extractor Pin		PO55474	Safety Lever Pin (90), Practical
05	PO55618	Extractor Spring	28	* PO55588	Sear
06	PO55545	Firing Pin	29	PO55626	Sear Lever Pin
07	PO55555	Firing Pin Spring	30	PO55629	Sear Lever Spring
08	PO55558	Firing Pin Retaining Plate	31	PO55623	Sear Lever, Type II
09	PO55636	Fixed Sight, Mark III ('90), Dovetail Front	32	PO55590	Sear Pin
09	PO55637	Front Sight (90), Practical	33	PO55591	Sear Spring with Button
09	PO55912	Front Sight, .40 S&W	34	PO55632	Slide, Mark III ('90) Matte Finish
09	PO55559	Front Sight, Capitan	34	PO55907	Slide, .40 S&W Matte Finish
09	PO55552	Front Sight Adjustable, Dovetail Blue	34	PO55900	Slide, Capitan Blue Finish
10	PO55350	Grip Left, Matte Blue			
10	PO55650	Grip Left, Walnut, Polished Blue	34	PO55484	Slide, Practical Adjustable
10	PO55658	Grip , Silver Chrome, Practical	34	PO55479	Slide, Practical (90) Fixed
11	PO55360	Grip Right, Matte Blue	34	PO55490	Slide, Blue (90) Dovetail Fixed
11	PO55660	Grip Right, Walnut, Polished Blue	34	PO55494	Slide, Blue (90) Dovetail Adjustable Rear
12	PO55670	Grip Screw	35	PO55634	Rear Sight Fixed, Mark III ('90)
13	* PO55593	Hammer	36	PO55901	Rear Sight, Capitan
13	* PO55469	Hammer, Capitan	37	PO55902	Rear Sight Cursor, Capitan
13	* PO55471	Hammer, Practical	38	PO55903	Rear Sight Cursor Lock, Capitan
14	PO55597	Hammer Strut Assy. with Mainspring, Mainspring Support Pin & Nut	39	PO55904	Rear Sight Cursor Spring, Capitan
15	PO55596	Hammer Strut Pin	40	PO55905	Rear Sight Elevation Spring, Capitan
16	PO55600	Magazine Latch	41	PO55652	Slide Stop
16	PO55477	Magazine Latch, Practical	41	PO55910	Slide Stop, .40 S&W
17	PO55608	Magazine Latch Spring	41	PO55470	Slide Stop (90), Practical
18	PO55610	Magazine Latch Spring Guide	42	* PO55570	Trigger
18	PO55478	Magazine Latch Spring Guide, Practical	42	* PO55475	Trigger (90), Practical
	PO55641	Magazine Pad, Practical & Silver Chrome	43	* PO55561	Trigger Lever
19	* PO55695	Magazine Safety	44	PO55562	Trigger Pin
20	* PO55699	Magazine Safety Spring	44	PO55476	Trigger Pin (90), Practical
21	PO55567	Magazine Safety Pin & Trigger Spring Pin	45	PO55875	Trigger Spring
22	PO55547	Rear Sight Adjustable (Millet)			
	PO55634	Rear Sight Blue (90) Fixed			
23	PO55540	Recoil Spring			
23	PO55908	Recoil Spring, .40 S&W			

* Indicates part must be fitted by Browning Service Department or by a Browning Recommended Service Center.

Browning Hi-Power Schematic

Schematic is provided for parts identification only and should not be used as a guide to assemble guns.

IMPORTANT: When ordering parts, please list the part number, the part name, the caliber, the model and the serial number, located on your pistol.

(Do not order parts using key numbers.)

CAUTION: These Browning parts are made exclusively for the Browning Hi-Power pistol and should not be used in other guns even though models may be similar. Inadequately fitted parts may be dangerous.

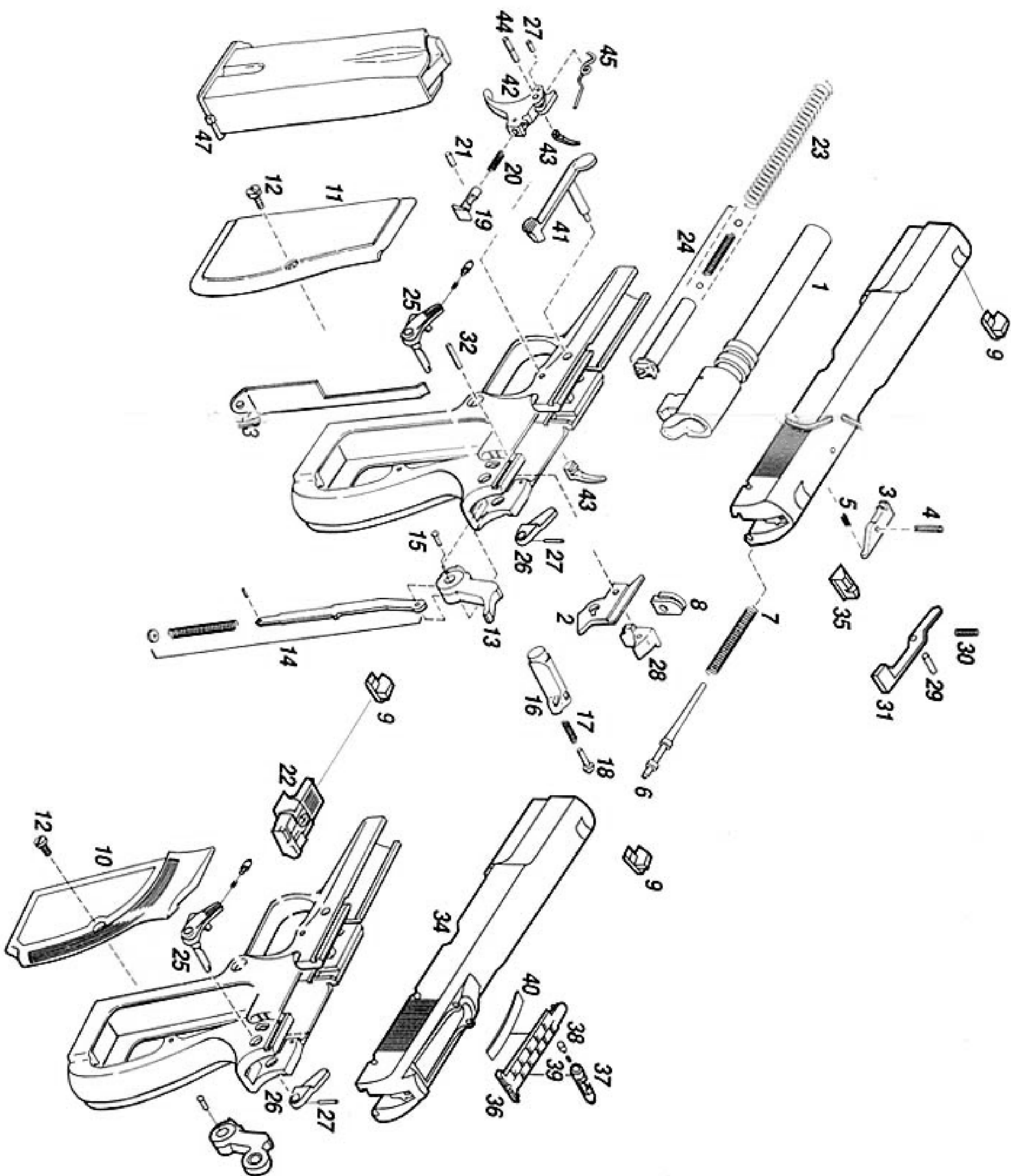
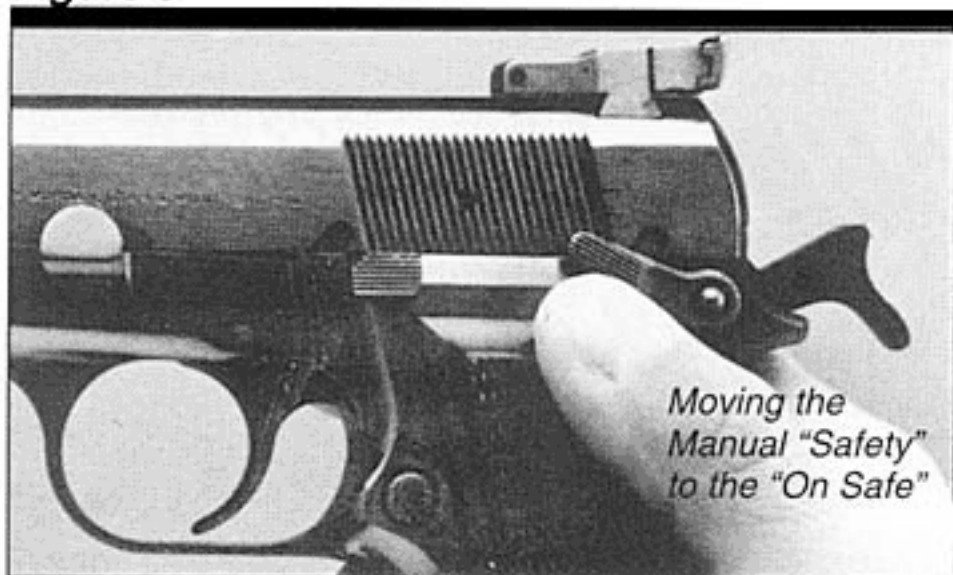

Figure 5**LOWERING THE HAMMER —**

To lower the hammer from full cock to the dropped position the following procedure is recommended.

- 1 To lower the hammer from full cock to the dropped position, the magazine must be inserted in the pistol.

BE SURE THE MUZZLE IS POINTED IN A SAFE DIRECTION.

- 2 Firmly place your thumb over the hammer with the point of your thumb in the "V" between the

hammer and the firing pin (the point of your thumb will act as a cushion should the hammer accidentally fall). Apply slight rearward pressure on the hammer.

- 3 Depress the trigger and allow the hammer to travel forward very slowly.
- 4 As soon as the hammer has passed the full cock position **REMOVE YOUR FINGER FROM THE TRIGGER.**
- 5 Let the hammer slowly travel forward until it is stopped in the half cock position.
- 6 Again draw the hammer slightly rearward and depress the trigger until the hammer moves forward, clearing the half cock position.
- 7 Ease the hammer against the inertia firing pin. The hammer is now in the dropped position — the recommended carrying position.

Manual Thumb "Safety"

The thumb "safety" serves two functions on all models of this pistol — as a manual safety and a slide lock. All current models of the Single Action Hi-

Power Pistol have an ambidextrous "safety." A "safety" lever is on both the right and left side of the frame for the convenience of left-handed shooters. On older models, the safety is on the left side. The instructions below apply to ambidextrous "safety" models.

Manual "Safety"**"ON SAFE" POSITION—**

To place the "safety" in the "on safe" position, cock the pistol and push the "safety" lever upward into the recess located in the rearward portion of the slide (see figure 5).

"OFF SAFE" POSITION —

To place the safety in the "off safe" or ready-to-fire position, depress the thumb "safety" downward from the recess in the slide. With the hammer fully cocked and with a round in the chamber and the magazine inserted,

THE PISTOL IS READY FOR FIRING WITH A PULL ON THE TRIGGER.

SLIDE LOCK —

The manual "safety" may be used as a slide lock for disassembly. When disassembling the Hi-Power, the "safety" lever is used to lock the slide back by engaging it into the disassembly recess. See page 12 and 13 for disassembly instructions.

Loading

SINCE THE 9MM HI-POWER AND THE .40 S&W ARE VERY SIMILAR IN APPEARANCE, PLEASE CAREFULLY EXAMINE EVERY CARTRIDGE YOU LOAD IN YOUR HI-POWER PISTOL. THE CALIBER OF YOUR HI-POWER IS INSCRIBED ON THE RIGHT SIDE OF THE BARREL. FAILURE TO USE CORRECT AMMUNITION MAY RESULT IN SERIOUS INJURY TO YOURSELF OR OTHERS.

- 1 With the slide closed and the muzzle pointing in a safe direction, press the magazine latch on the left side of the frame at the rear of the trigger guard and remove the magazine. As a safety precaution, operate the slide manually and visually inspect the chamber to eliminate any possibility of a cartridge being in the chamber.

Figure 6

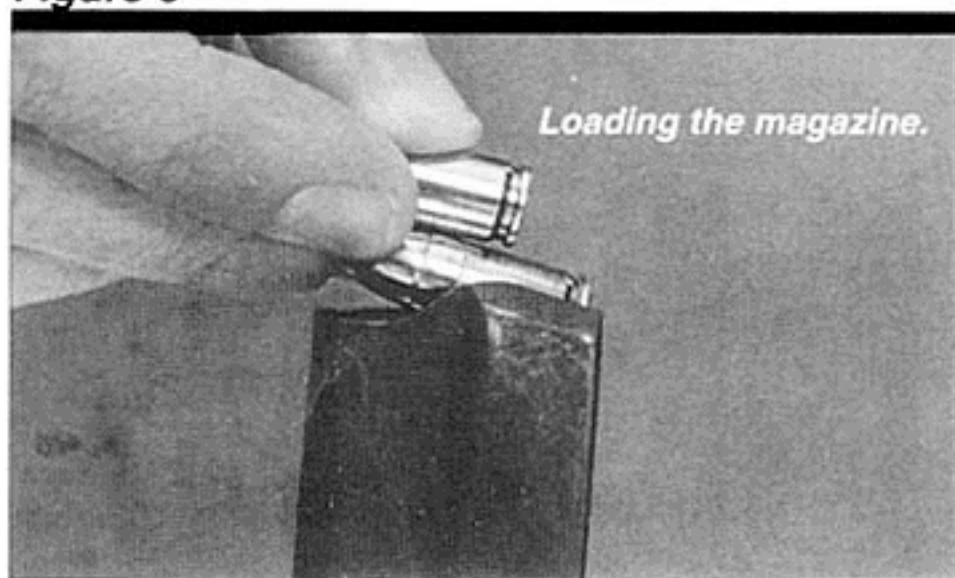

- 2 Allow the slide to close. It is possible to lock the slide open before inserting a loaded magazine. However, . . .

... BROWNING RECOMMENDS THAT THE SLIDE BE CLOSED BEFORE INSERTING A LOADED MAGAZINE .

If the slide is locked open when a magazine is inserted, and the slide is then closed using the slide lock, a cartridge will be fed into the chamber as the slide closes.

THE PISTOL COULD THEN BE FIRED WITH THE PULL OF THE TRIGGER.

- 3 Insert the cartridges into the magazine by pushing them down and sliding them rearward with your thumb (see figure 6) as the slide closes.

The recommended magazine capacity of the 9mm Single Action (Hi-Power) pistol is 13 rounds of 9mm Luger cartridges (unless a 10 capacity magazine is required by law). However, with certain brands of ammunition, it may be possible to load 14 rounds into the magazine. The recommended magazine capacity of the .40 S&W Single Action (Hi-Power) pistol is 10 rounds of .40 S&W cartridges.

- 4 Browning recommends that you close the slide before inserting a loaded magazine. Insert the loaded magazine into the base of the frame, being certain that the magazine is pressed completely in until retained by the magazine latch.
- 5 To load the chamber, point the muzzle in a safe direction and pull the action slide completely

Figure 7

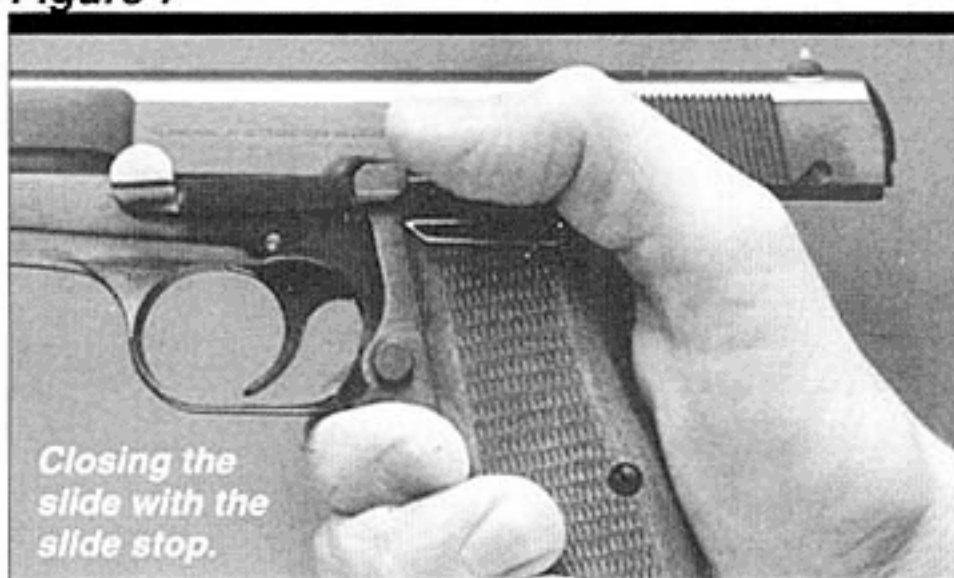

back. This is done by firmly gripping the slide and pulling back. Then, with your thumb, depress the Slide Stop and let the slide spring forward, feeding the first cartridge from the magazine into the chamber. This is the maximum ready position. **Do not ease the slide forward; it could cause a cartridge misfeed.**

CAUTION: THE PISTOL IS NOW COCKED AND CAN BE FIRED BY SIMPLY SQUEEZING THE TRIGGER.

Unless shooting is imminent, immediately place the pistol in a safer status by lowering the hammer to the dropped position.

CAUTION: YOU WILL HAVE OBSERVED, BY PULLING THE SLIDE BACK TO COCK THE PISTOL, THAT THE SLIDE MOVES REARWARD ABOUT 3/4" PAST THE REAR OF THE FRAME. IN SHOOTING, NEITHER HAND SHOULD BE IN A POSITION WHERE IT COULD BE HIT BY THE SLIDE IN ITS REARWARD MOVEMENT NOR SHOULD UNORTHODOX SIGHTING METHODS BE USED WHERE THE PISTOL IS HELD CLOSE TO THE EYE.

Firing

The pistol may be fired from the full cock, maximum ready position as mentioned previously.

After pulling the trigger and firing a cartridge, the pistol automatically ejects the fired cartridge and feeds a fresh cartridge from the magazine into the

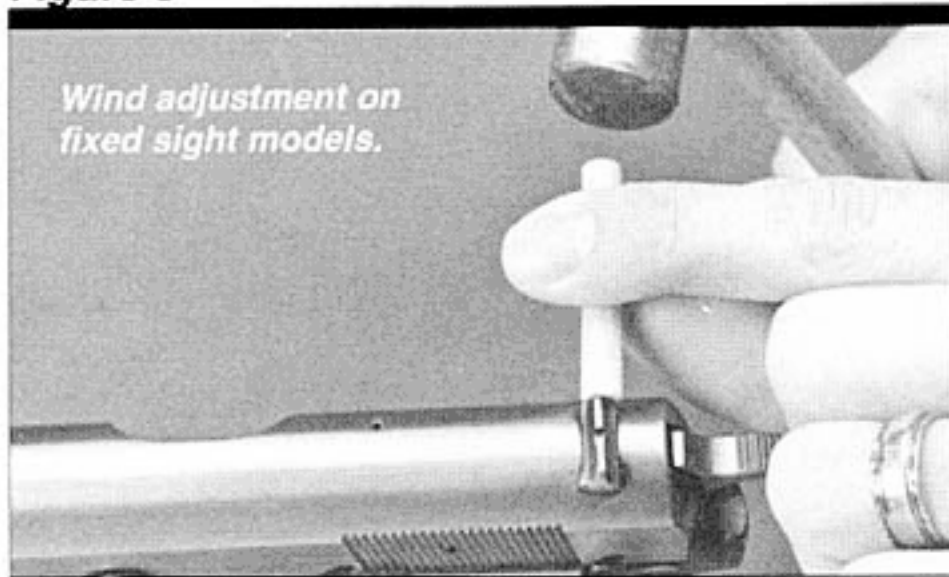
Figure 8

chamber ready for a second shot. Thus the shooter may fire the pistol until the magazine is empty simply by pulling the trigger for each shot.

After the last shot is fired, the slide stop on the left side causes the slide to remain back. At this point, Browning recommends that the slide be closed (by releasing the slide stop) before a loaded magazine is inserted in the pistol (see figure 7).

To load a round in the chamber with the slide closed, follow the procedure outlined in step 5 of

the "Loading" section. With a round in the chamber and the hammer at full cock, . . .

. . . THE PISTOL IS READY FOR FIRING WITH A PULL ON THE TRIGGER.

Unloading the Pistol

With the muzzle pointed in a safe direction, first depress the magazine release on the left side of the frame and remove the magazine. Then, pull back the slide to make sure that the chamber is empty.

CAUTION: KEEP YOUR FINGER OFF THE TRIGGER WHILE REMOVING THE MAGAZINE.

Grip the slide. Draw it sharply rearward and lock the slide to the rear by raising the Slide Stop. This will clear any round that may be in the chamber

and eject that round. Visually inspect both the chamber and magazine channel to be sure your pistol is clear. When you store your pistol, leave the slide back and the magazine out. Remove any cartridges remaining in the magazine by individually stripping them from the magazine thumb. The magazine and cartridges should be stored separately from the pistol.

Sight Adjustment

The Hi-Power pistol is offered with three sighting systems: fixed sights, adjustable sights and tangent sights. Before adjusting the sights, **BE CERTAIN YOUR PISTOL IS COMPLETELY UNLOADED.**

FIXED SIGHTS—

The pistol is equipped with a windage adjustable rear and front sight.

Windage — The windage adjustment (horizontal correction) is pre-set at the factory. However, should it ever be required, the rear sight or front sight may be moved in its dovetail slot in the slide.

This is accomplished by lightly tapping the base of the rear sight in the same direction you want the bullet to move or the front sight in the opposite direction you want the bullet to move. For example, if you want the point of impact to move to the left, tap the rear sight to the left; if you want to move the point of impact to the right, tap the rear sight to the right.

A small wooden dowel or comparable nonmetallic object should be used to bear against the sight base during tapping to avoid marring the finish (see figure 8). Correct adjustment is a process of trial and error using the method described above.

ADJUSTABLE SIGHTS —

Hi-Power pistols equipped with adjustable sights are screw adjustable for both horizontal (windage) and

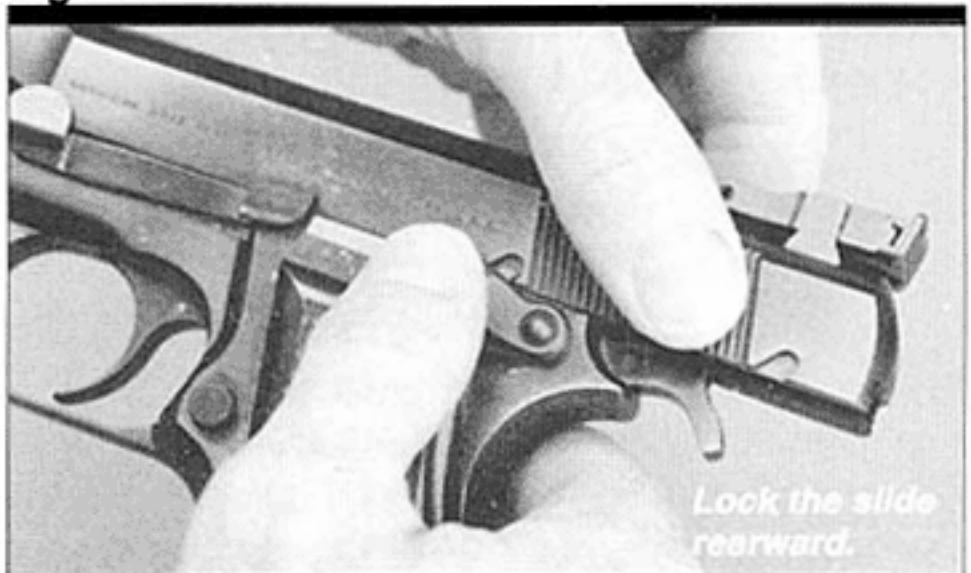
Figure 9**Figure 11****Figure 10****Figure 12**

vertical correction. The front sight is a serrated ramp-type design.

Windage — To move the point of impact to the **right**, simply turn the screw located on the right side of the sight in a clockwise direction (see figure 9). To move the point of impact to the **left**, simply turn the screw located on the right side of the sight in a counterclockwise direction (see figure 10).

Elevation — To raise the point of impact, turn the elevation screw, located just in front of the rear sight, counterclockwise. To lower the point of impact, turn the elevation screw clockwise (see figure 10).

TANGENT SIGHTS —

The tangent sight is a military styled sight that is adjustable from 50 to 500 meters.

Windage — The windage adjustment (horizontal correction) is pre-set at the factory.

Elevation — To adjust the point of impact, squeeze the pins on the sides of the sight and slide the top bar so it is lined up with the desired yardage marked on top of the sight (see figure 11).

Disassembly

FIRST, BE CERTAIN YOUR PISTOL IS COMPLETELY UNLOADED.

- 1 Remove the magazine — Press the magazine catch button on the left side and remove the magazine.
- 2 Lock the slide in its rearward position — Push the thumb safety up into the disassembly recess on the slide (see figure 12).

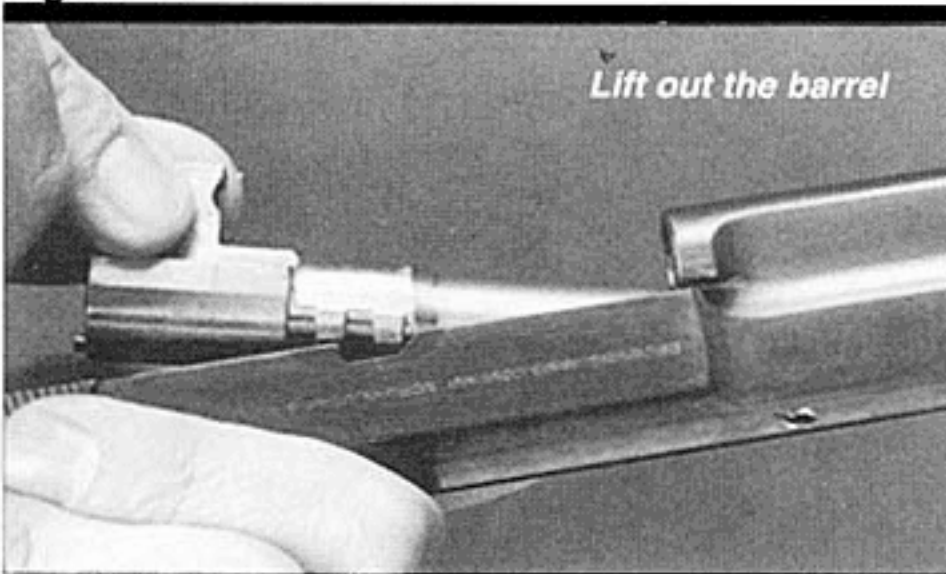
Figure 13**Figure 14**

- 3 Remove the slide stop — Press against the end of the slide stop pin that extends out of the right side of the frame (see figure 13). At the same time, slightly elevate the slide stop on the left side of the frame. After the slide stop pin is pushed flush with the right side of the frame, the slide stop can be removed from the left side of the frame.
- 4 Remove the slide — Lower the thumb safety, taking care to hold back on the slide, preventing it from springing forward. Remove the slide forward from the receiver.
- 5 Remove the coil spring and guide — While holding the slide, press the head of the recoil spring guide forward to release the head of the recoil spring guide from the barrel. Remove the recoil spring and its guide.
- 6 Remove the barrel — Lift up on the barrel lug and slide the barrel out rearward (see figure 14). Disassembly to this point is sufficient for normal maintenance of the Hi-Power (see figure 15).

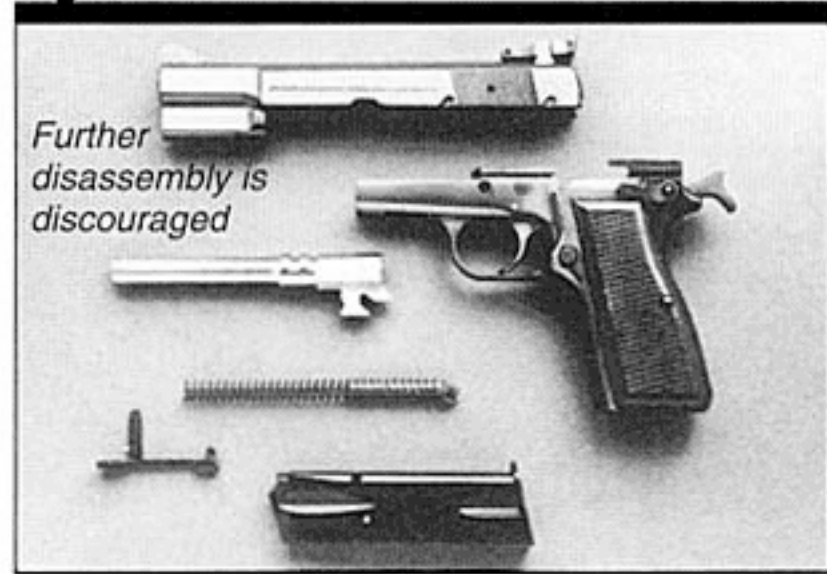
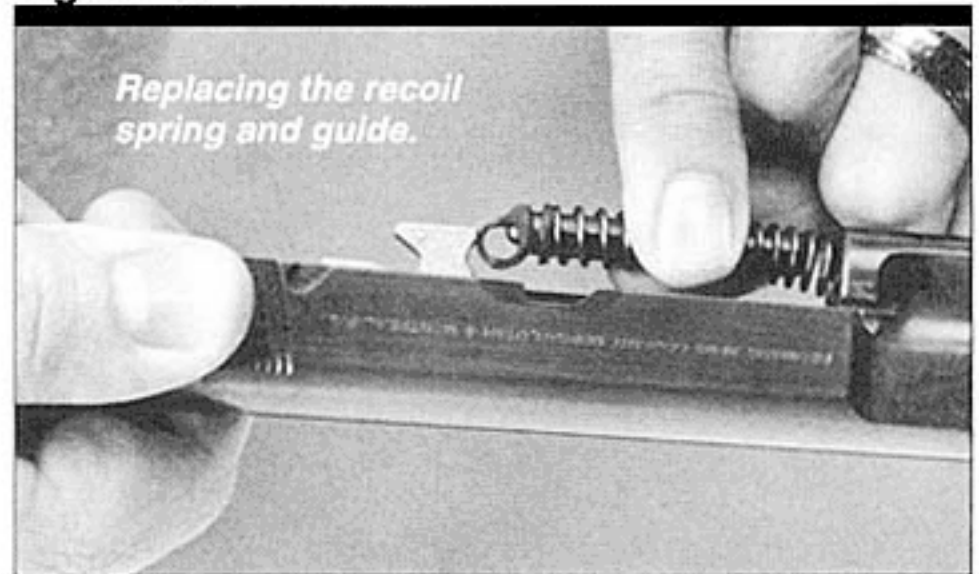
Figure 15**Figure 16**

Further disassembly is not recommended. If necessary, it should be done by a qualified gunsmith.

Reassembly

- 1 Replace the barrel in the slide.
- 2 Replace the recoil spring on the receiver — Press the spring forward to release the tension and position the head of the recoil guide into its recess in the forward surface of the barrel lug (see figure 16 for precise position of guide).
- 3 Replace the slide on the receiver — Draw the slide rearward as far as possible. Lock it in this position by moving the thumb "safety" lever into the disassembly recess on the slide.
- 4 Replace the slide stop in the receiver.
- 5 Release the slide — Grasp the slide and push rearward slightly. Lower the thumb "safety" and allow the slide to move forward under spring tension.
- 6 Replace the magazine.

Care and Cleaning

FIRST, BE CERTAIN YOUR PISTOL IS COMPLETELY UNLOADED.

- 1 Disassemble the pistol as previously described in the section titled "Disassembly." Be sure to use eye protection whenever cleaning your pistol. Clean the bore using a pistol cleaning rod with a tip and patch specifically designed for use with a 9mm pistol, or for a .40 S&W pistol. Work the patch back and forth until a patch comes through clean.
- 2 Depending on the amount of use, the barrel may need to be cleaned with a good quality nitro solvent. Ordinarily, a light lubricating oil like Browning Oil will suffice for this purpose.
- 3 The slide assembly may be cleaned with solvent or oil and then wiped dry with a clean cloth.
- 4 Use a small brush to remove dirt or other foreign matter from the other parts of the action. Lightly lubricate all moving parts, sparingly, with oil. A light film is sufficient.
- 5 Periodically wash the magazine in a good gun cleaning solvent to keep the magazine spring and follower functioning well. Bullet lubricants, oil and dirt can make these magazine components sluggish. Do not heavily oil the internal parts of the magazine, as the oil can serve to collect grit and foreign matter.
- 6 It is appropriate to wipe the external parts of the pistol with a slightly oiled cloth after handling and to put a drop of oil on the friction points from time to time. Frequently inspect your pistol and magazine to determine the need for cleaning.

DO NOT TAKE YOUR GUN'S ACTION APART BEYOND THE EXTENT EXPLAINED IN THIS MANUAL.

This is a specialized, finely fitted mechanism, and you may mar it for life by an attempt to disassemble the inner mechanism assemblies. Do not disassemble the breechlock, gas system or trigger group more than described. If further disassembly is required, take your gun to a Browning Recommended Service Center or a competent gunsmith.

SPECIFICATIONS

Caliber (Parabellum)	9mm Luger (Parabellum)	.40 S&W
Capacity of Magazine	13 Cartridges*	10 Cartridges
Overall Length	7 3/4"	7 3/4"
Length of Barrel	4 21/32"	4 3/4"
Height of Pistol	5"	5"
No. of Rifling Grooves	6	6
Twist of Rifling	Right hand, 1 in 10"	Left hand, 1 in 16"
Weight (unloaded)	32 oz.	35 oz.
Sights	<ul style="list-style-type: none"> • Drift Adjustable Front • Adjustable Rear, Drift Adjustable for windage and elevation. • Tangent Style Rear, Adjustable to 500 meters. 	<ul style="list-style-type: none"> • Drift Adj. Front • Drift Adj. Rear

* The recommended magazine capacity of the 9mm Single Action (Hi-Power) pistol is 13 rounds of 9mm Luger cartridges. However with certain brands of ammunition, it may be possible to load 14 rounds into the magazine. 10 round capacity magazines are available where required by law. Hi-Power pistols are available in a variety of metal finishes and grip options.

Service or Repair

If your firearm should require service or repairs, we suggest you first contact a local recommended Browning Firearms Service Center. Contact your Browning sporting goods dealer or call our Service Department for the address of the Service Center nearest you. Otherwise, you may send your firearm directly to our own Service Department. For technical questions about your firearm or service call our Service Department.

***Browning Service Department
3005 Arnold Tenbrook Road
Arnold, Missouri 63010-9406
Phone: 1-800-322-4626***

Canadian Customers call or write:

***Browning Canada Sports Ltd./Ltee,
5617 Chemin St-Francois
St-Laurent, Quebec H4S 1W6
Phone: (514) 333-7261***

When returning your firearm for servicing, you *must* do the following:

- a. Be sure it is completely unloaded.
- b. Package it securely in a cardboard container.
- c. Enclose a letter with your firearm that clearly describes the trouble experienced and the repairs or alterations desired.
- d. If convenient, send a copy of the letter to us separately.
- e. Never return ammunition with your firearm. It is against postal and most commerce regulations.

If you have any questions about this manual or about any other Browning products, call or write our Consumer Information Department:

***Browning Consumer Information
Morgan, Utah 84050
Phone: (801) 876-2711***