

IthacaGun

**FIELD MAINTENANCE INSTRUCTIONS
MODEL 37 and MODEL 87
PUMP ACTION SHOTGUN**



LEO SMITH
1974-1987

FIELD MAINTENANCE INSTRUCTIONS

Model 37 and Model 87

Pump Action Shotgun

This manual has been prepared for the reader to facilitate repair and servicing of the Ithaca Model 37 and Model 87 Pump Action Shotguns.

The illustrations used represent a typical firearm and are not meant to apply to this firearm alone. The illustrations represent an older firearm to allow gunsmiths and armorers to repair older units as well as those of current manufacture and design.

The reader is cautioned to be aware of whether the firearm to be serviced is a 2 $\frac{3}{4}$ " or 3" action. Each of these take several components that are different and could cause malfunctions if improperly mixed.

The illustration shows a firearm with a sling. Ithaca firearms are not provided with slings or swivels. These are dealer or consumer added options. They are illustrated here simply for reference.

Ithaca Deerslayer II's are free floating barrel shotguns. They are not provided with a drilled and tapped barrel lug. As of the 1993 productions, a special sling stud mounting lug was provided to allow for the mounting of a sling. Deerslayer II barrels are permanently mounted to the receiver. As a result, the barrel may not be removed for cleaning. Gunsmiths and armorers will need to adjust for this feature when disassembling and cleaning Deerslayer II's. All other disassembly instructions remain the same.

Figures 7.7 and 19.8 show the disassembly of the Spring Shell Stop with a screwdriver. All current production, and some past production firearms, use a locating pin configuration.

Figure 4.3 and 4.4 show the use of a screwdriver to remove the stock from the gun. All current manufacture, and some past manufacture, require a $\frac{1}{8}$ inch socket set. Some older production also may have required a $\frac{3}{8}$ inch standard socket set. Unless your customer requires that you maintain the original condition of the firearm, we recommend that you standardize to the current $\frac{1}{8}$ inch socket.

Finally, figures 21, 22, 23 and 24 have been eliminated as they serve no current purpose. References to those figures should be ignored.

Should you have any further questions, please do not hesitate to contact us at:

Ithaca Gun

Ithaca Gun Company, LLC

891 Rte 34 B

King Ferry, NY 13081

Telephone: (315) 364-7182

FAX: (315) 364-5134

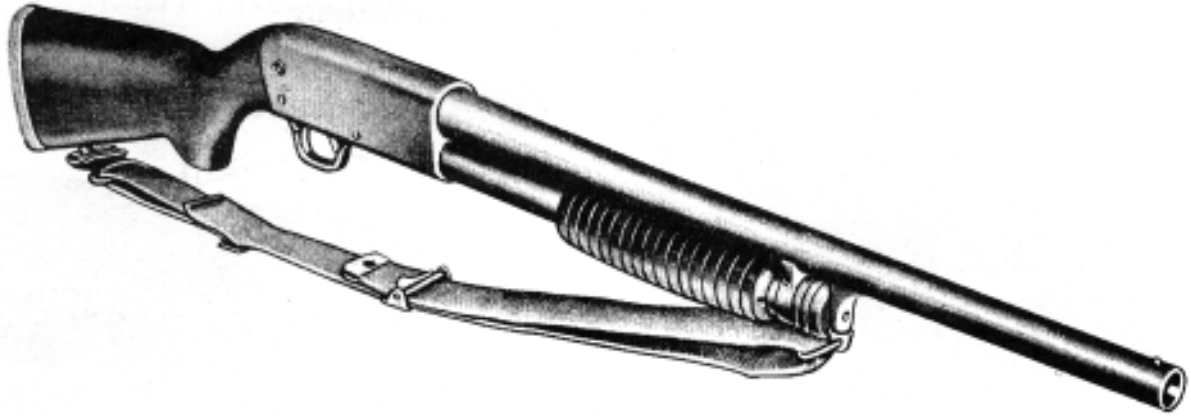

Figure 1. 12-gauge Ithaca shotgun Model 37 - right front view.



Figure 2. 12-gauge Ithaca shotgun Model 37 - left rear view.

Section III. REMOVAL AND DISASSEMBLY

3. Removal of sling and front swivel (See figure 3.)

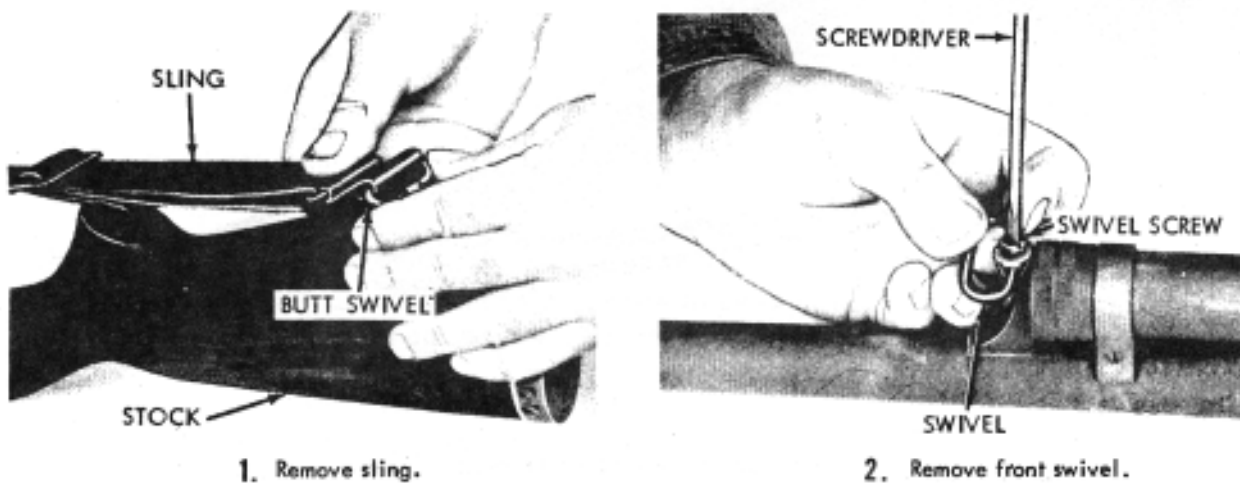

Figure 3. Removal of sling and front swivel.

4. Removal of the Stock Assembly (See figure 5.)

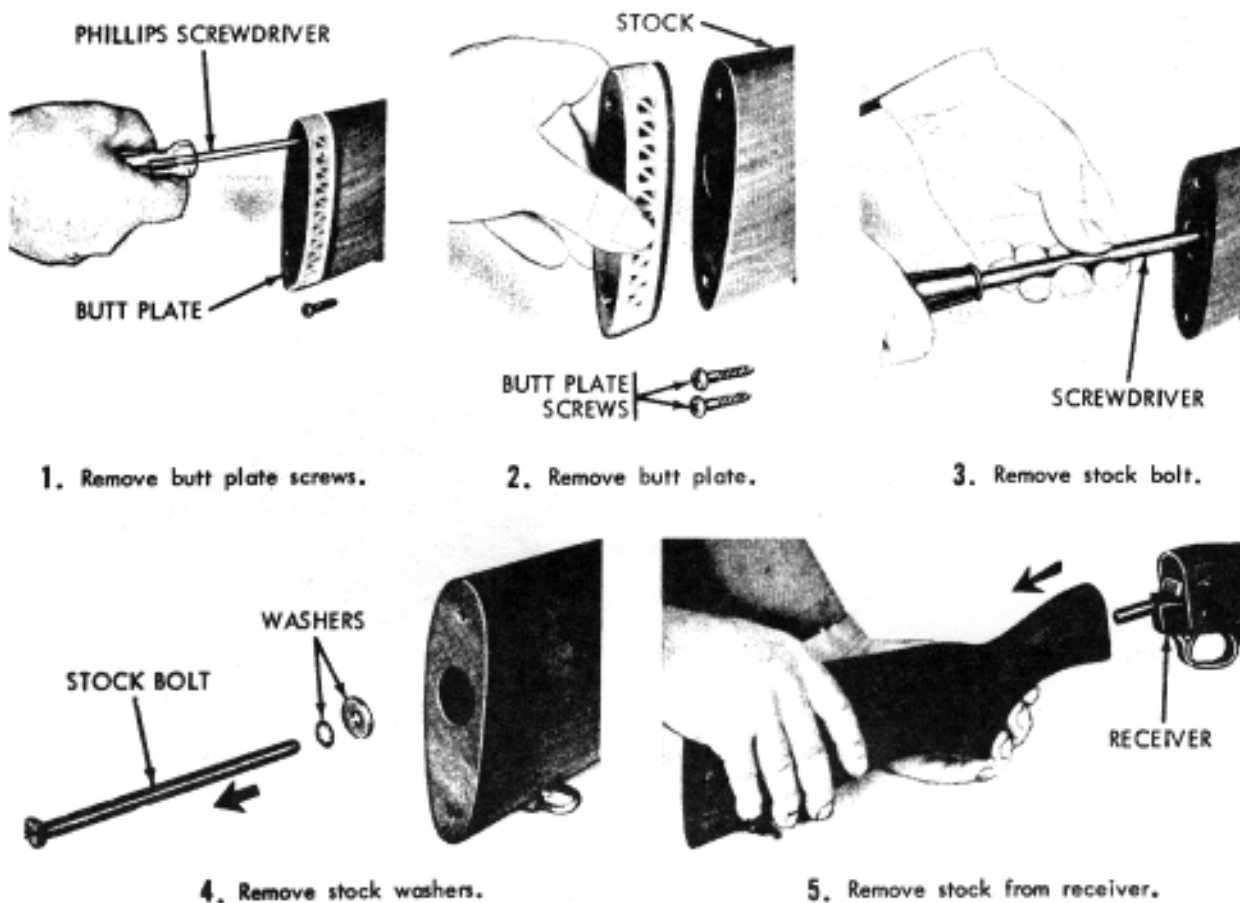
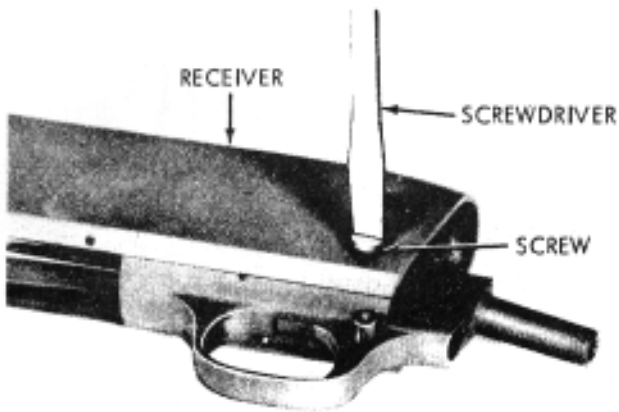

Figure 4. Removal of stock assembly.

5. Removal of Trigger Plate Group (See figure 5.)



1. Remove trigger plate screw.



2. Pull trigger plate group to rear of receiver.

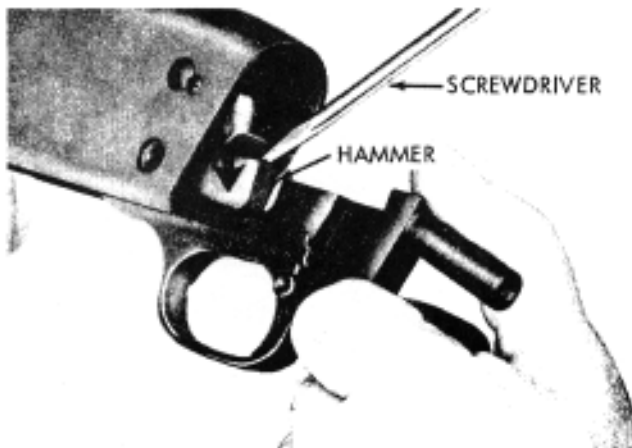

3. Compress hammer.

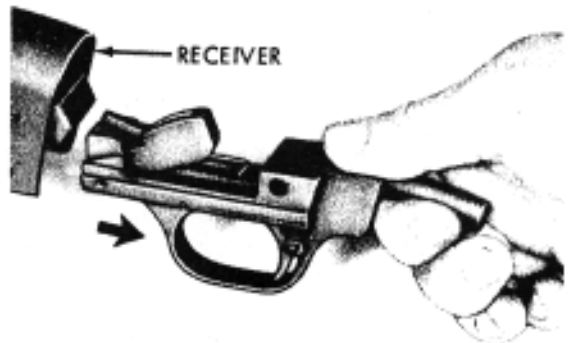

4. Remove trigger plate group.

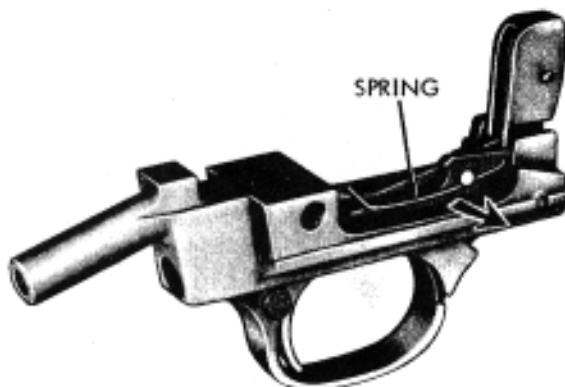

5. Remove slide stop release spring (top).

NOTE: SPRING TO BE REMOVED FOR REPLACEMENT ONLY

Figure 5. Removal of trigger plate group.

6. Removal of Slide, Breechblock and Carrier Group (See figures 6 and 7.)

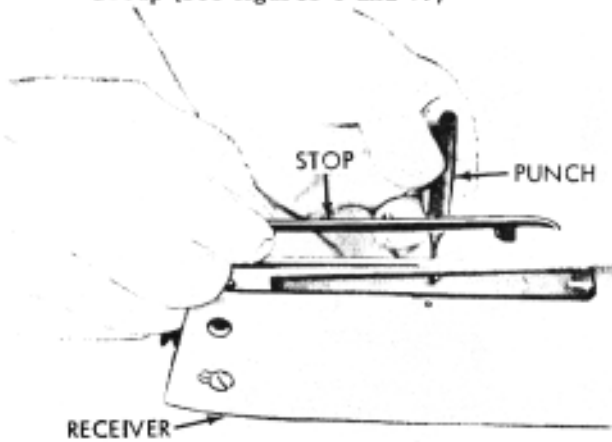

1. Remove positive shell assembly stop (right).

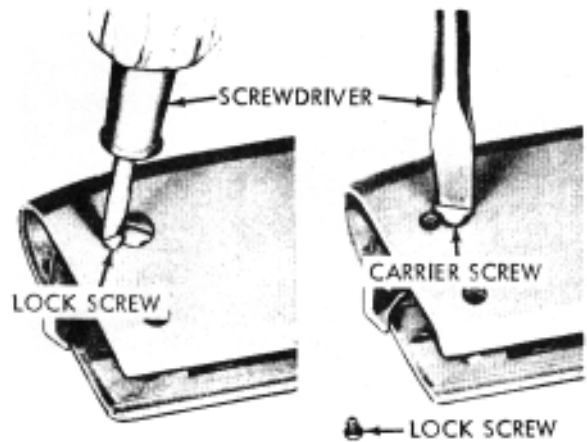

2. Remove right hand carrier screw lock screw and carrier screw.

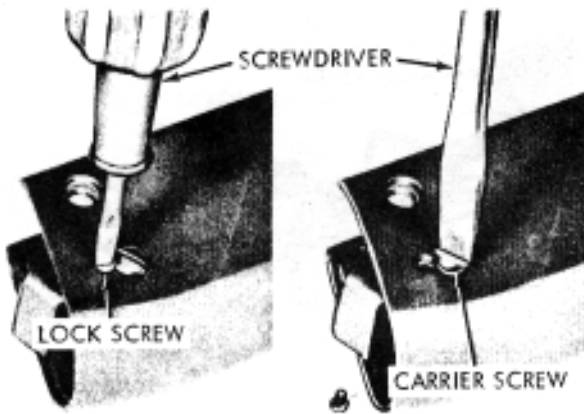

3. Remove left hand carrier screw lock screw and carrier screw.

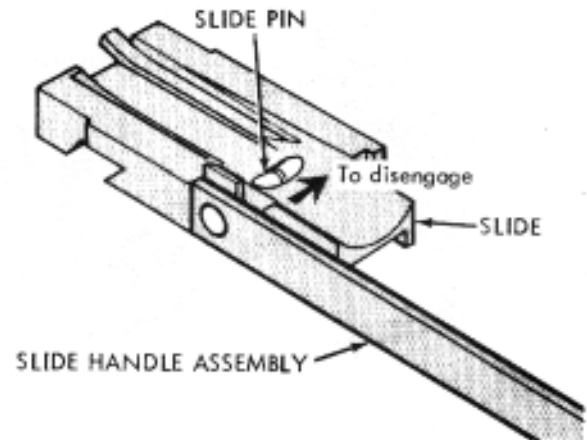

Slide plunger engaged with slide handle assembly. (See Step 4.)

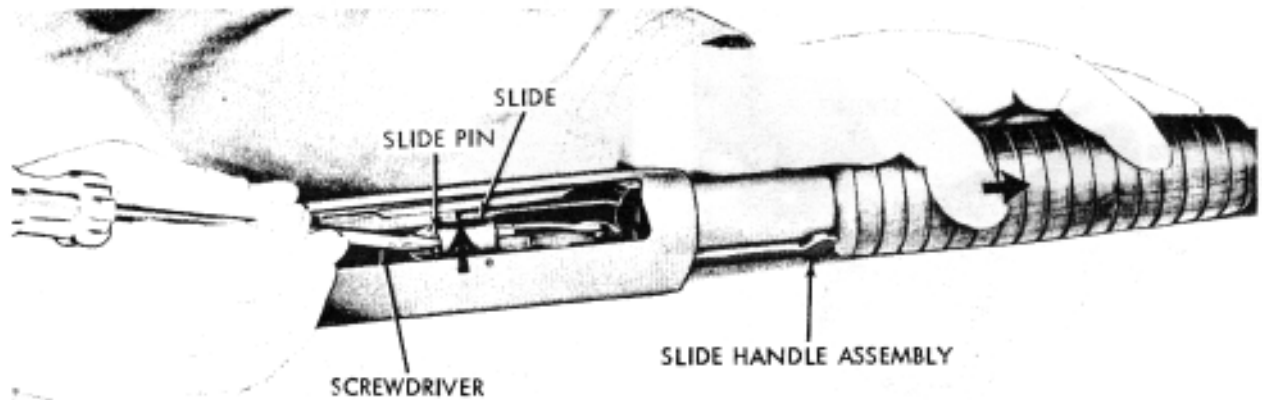

4. Compress slide pin releasing slide handle assembly.

Figure 6. Removal of slide, breechblock and carrier group.

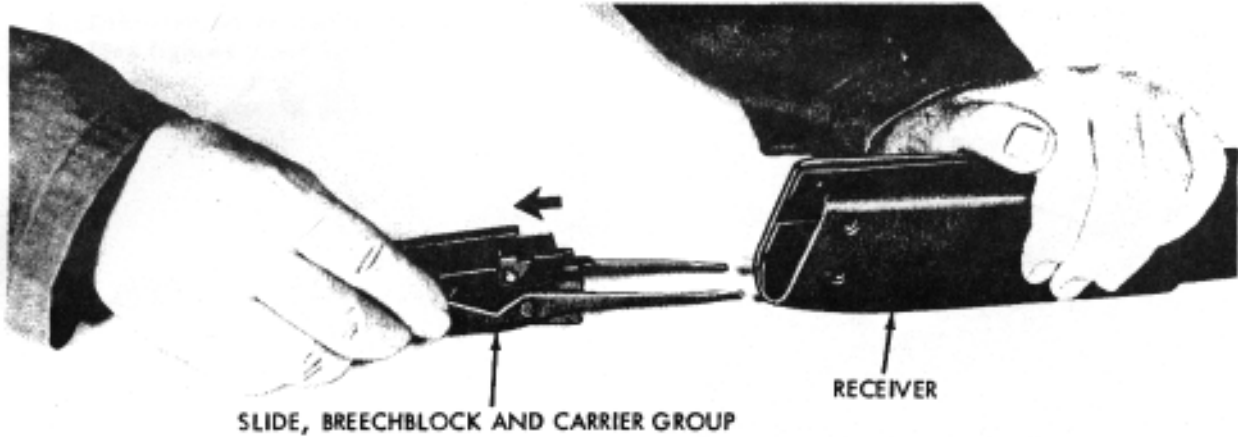

SLIDE, BREECHBLOCK AND CARRIER GROUP

RECEIVER

5. Remove slide, breechblock and carrier group.

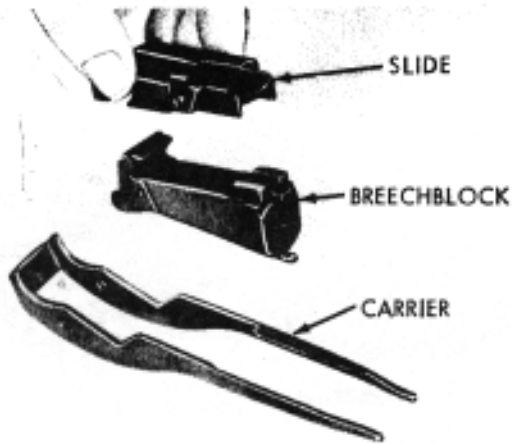

6. Separate slide, breechblock and carrier group.

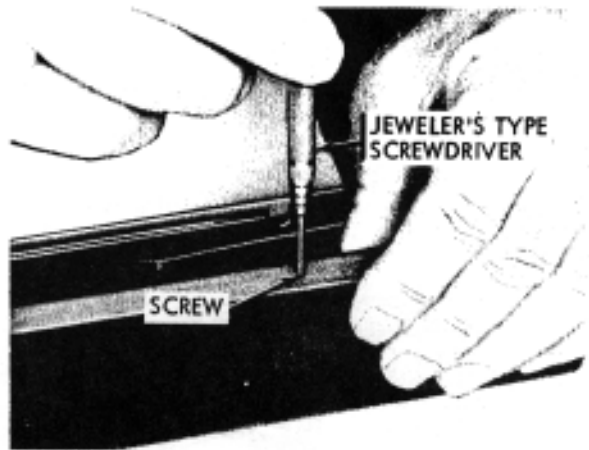

7. Remove spring shell stop screw.



8. Remove spring shell stop (left).

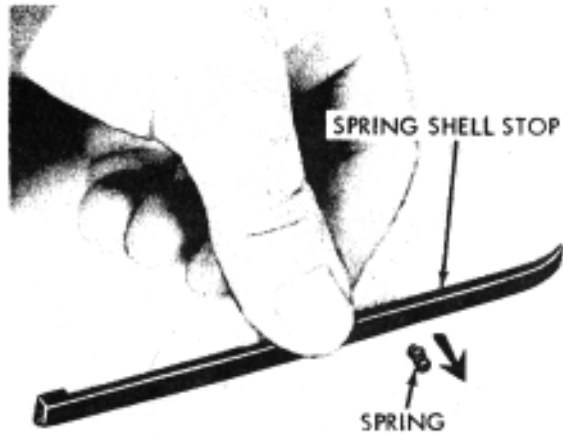

9. Remove spring shell stop spring.

Figure 7. Removal of slide, breechblock and carrier group (Continued).

7. Disassembly of Breechblock (See figure 8.)

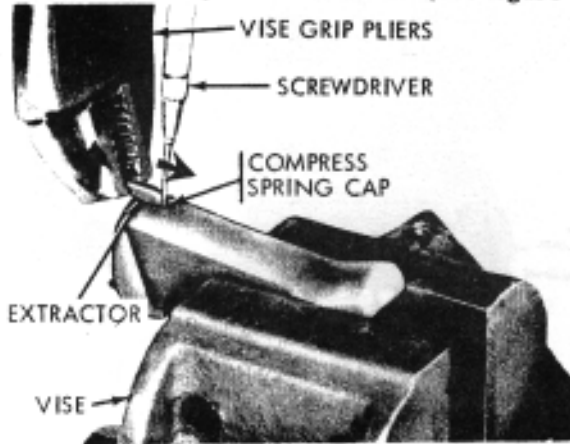

1. Remove positive extractor (top).

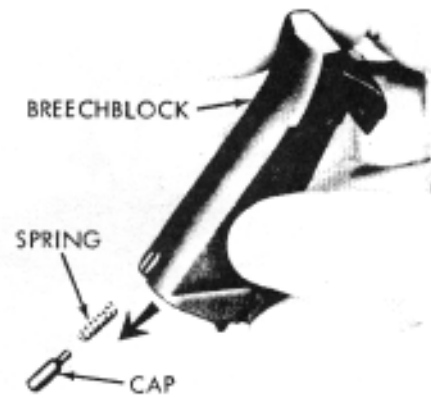

2. Remove positive extractor spring cap and positive extractor spring.

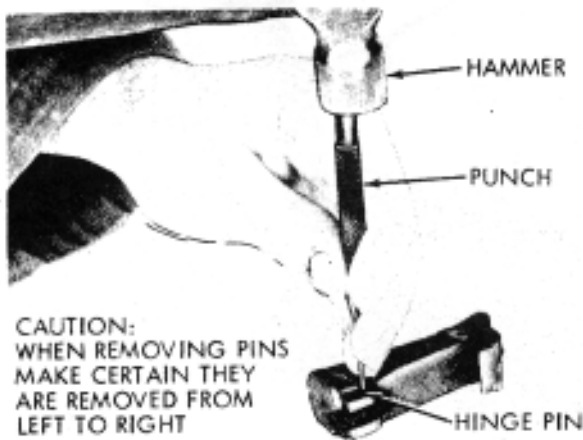

3. Remove extractor hinge pin (bottom).

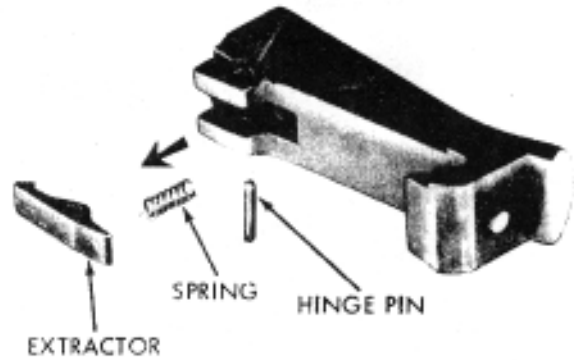

4. Remove bottom assembly extractor and extractor spring.

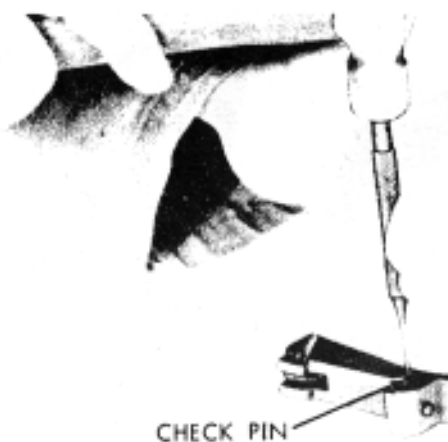

5. Remove firing pin check pin.

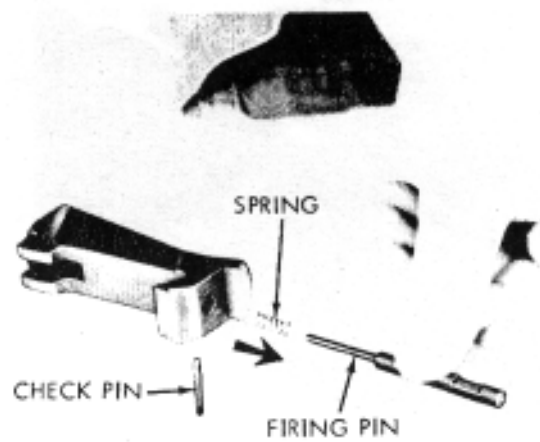

6. Remove firing pin and firing pin spring.

Figure 8. Disassembly of breechblock.

8. Disassembly of Barrel and Receiver Group
(See figures 9 and 10.)

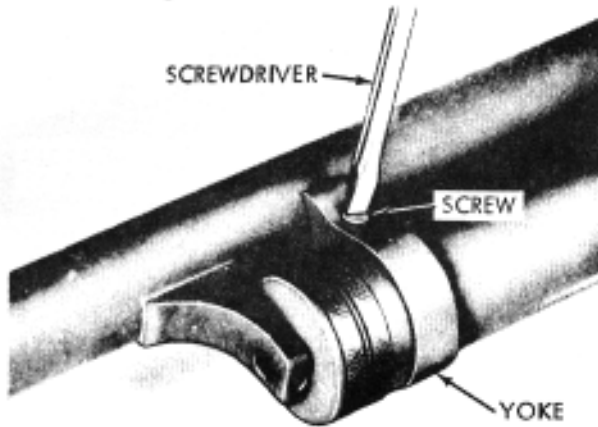

1. Remove yoke screw.

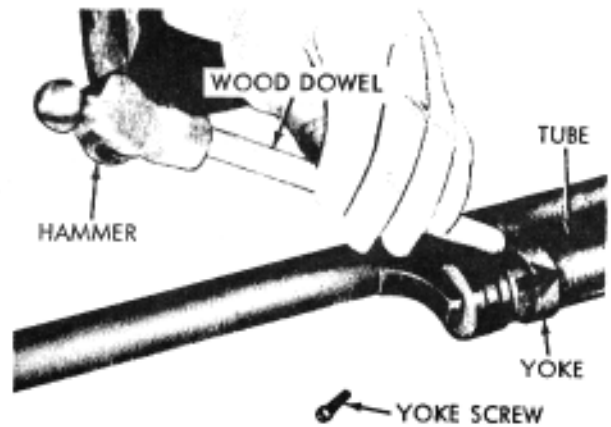

2. Drive yoke to rear over magazine tube.



3. Turn magazine nut clockwise as far as possible.

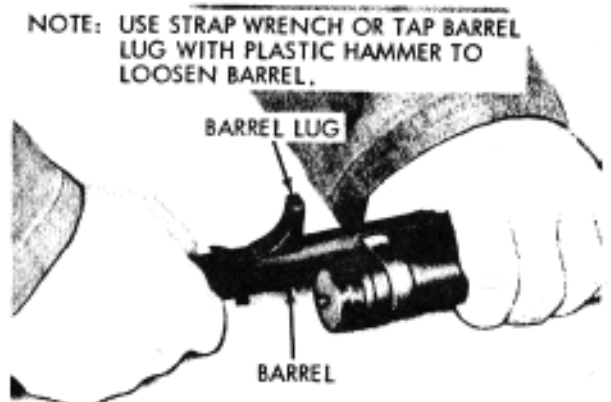

4. Rotate barrel counterclockwise 90-degrees.

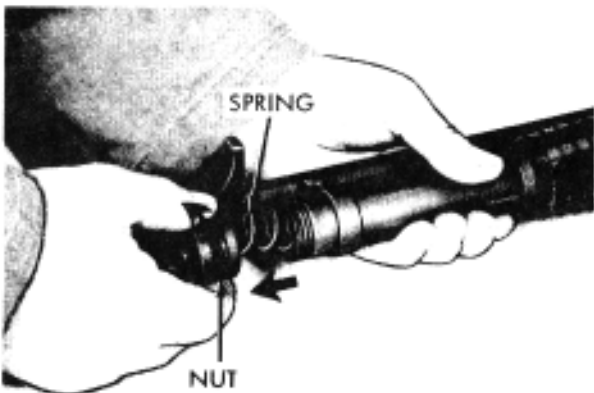

5. Remove magazine nut and magazine spring.

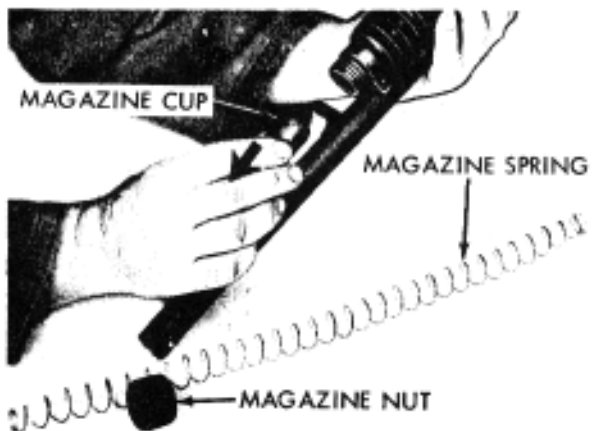

6. Tilt muzzle end of barrel down and slide magazine spring cup from magazine tube.

Figure 9. Disassembly of barrel and receiver group.

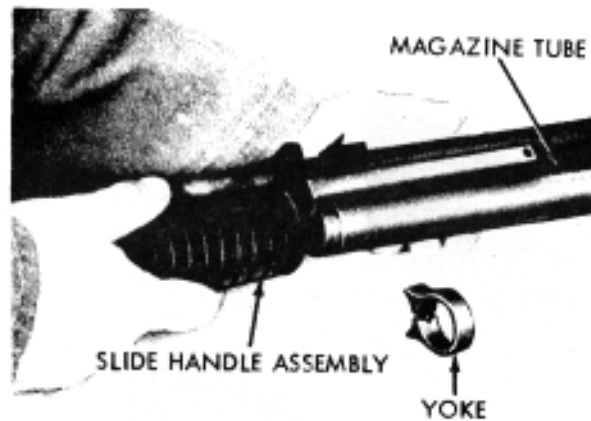

7. Remove slide handle assembly.

Figure 10. Disassembly of barrel and receiver group (Continued).

NOTE: REMOVAL OF YOKE AND SLIDE HANDLE ASSEMBLY IS REQUIRED FOR CLEANING PURPOSES ONLY.

NOTE: NO FURTHER DISASSEMBLY IS REQUIRED.

Section IV. CLEANING, INSPECTION, AND REPAIR.

9. Cleaning

a. The barrel should be thoroughly cleaned with CR, rifle bore cleaner applied to a cloth patch (fig. 11) assembled to a cleaning rod. Clean slide and magazine tube. Thoroughly dry and lightly oil with PL special, lubricating oil.

b. Clean all metal parts by wiping with a clean rag slightly moistened with CR, rifle bore

cleaner to loosen burnt powder and foreign matter. Wipe parts clean and dry. Oil lightly using a rag or brush moistened with PL special, lubricating oil. Special attention should be given to the items in figure 12.

Caution: In very cold climates, oiling should be reduced to a minimum. Only surfaces showing signs of wear should be lightly oiled, using LAW, lubricating oil.

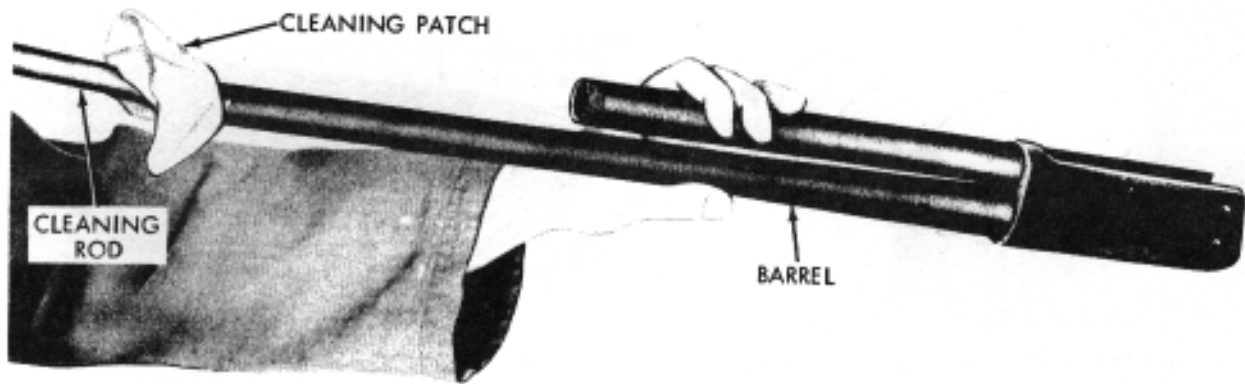

1. Cleaning barrel bore

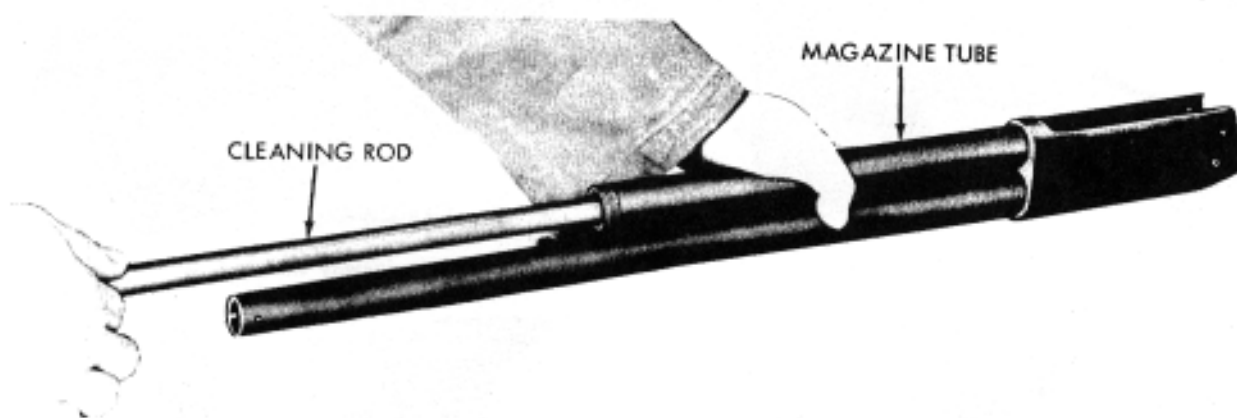

2. Cleaning magazine tube

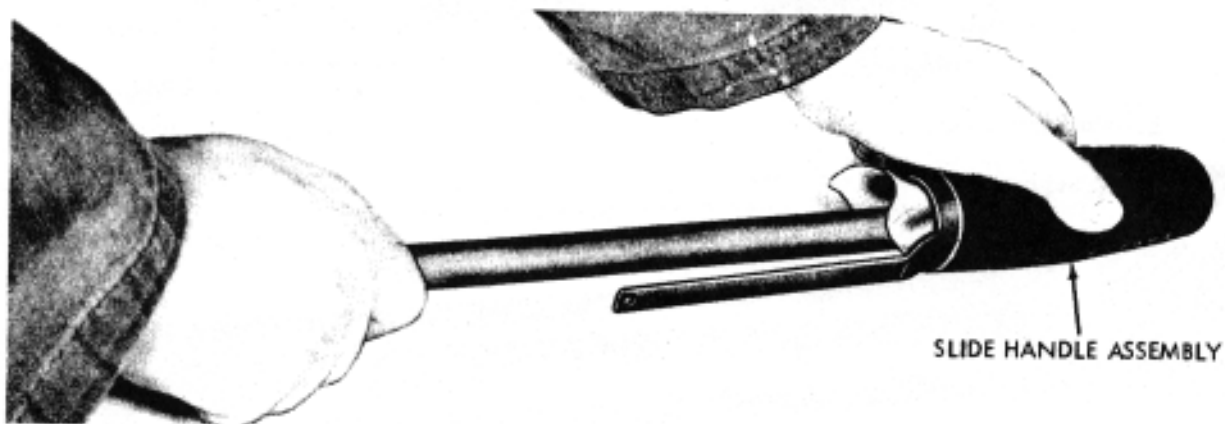

3. Cleaning slide

Figure 11. Cleaning barrel bore, magazine tube and slide assembly.

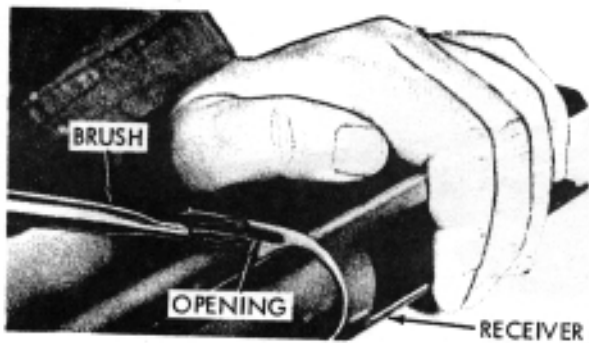

1. Slide bar opening in forward end of receiver.

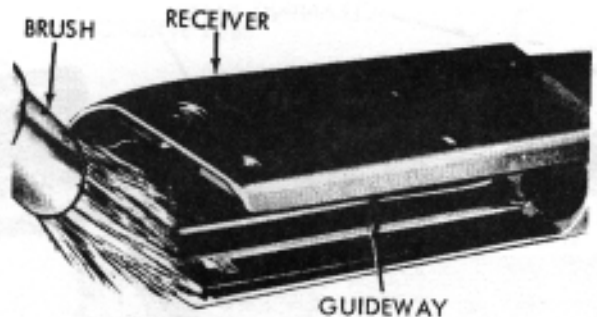

2. Slide bar guideway in receiver.

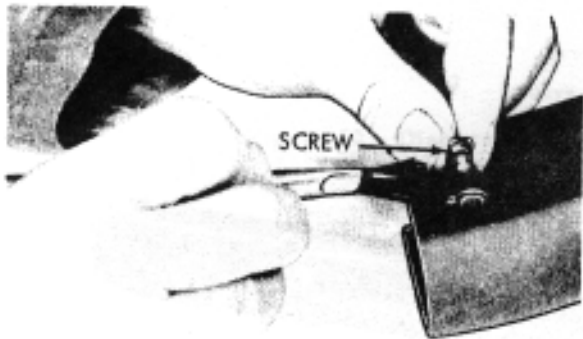

3. Carrier screws.

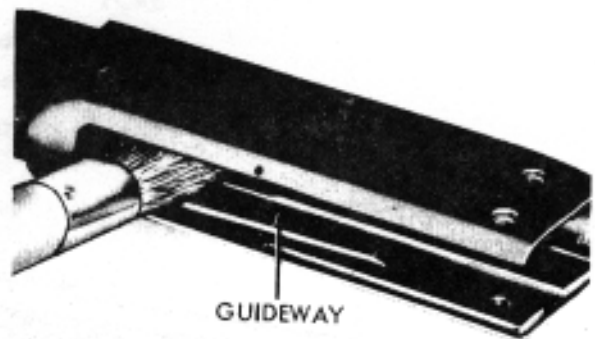

4. Slide guideway in receiver.

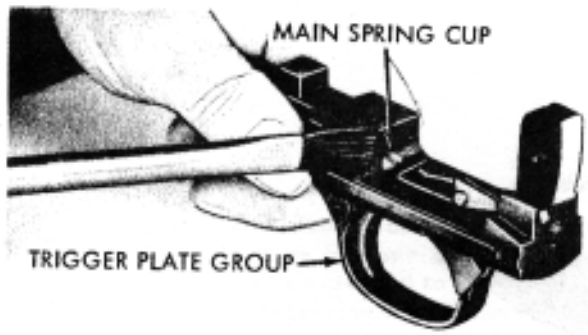

5. Main spring cup.

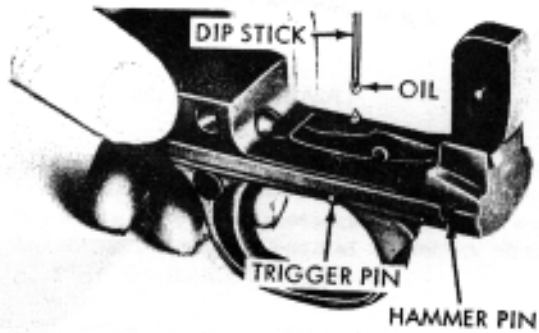

6. Trigger and hammer pins.

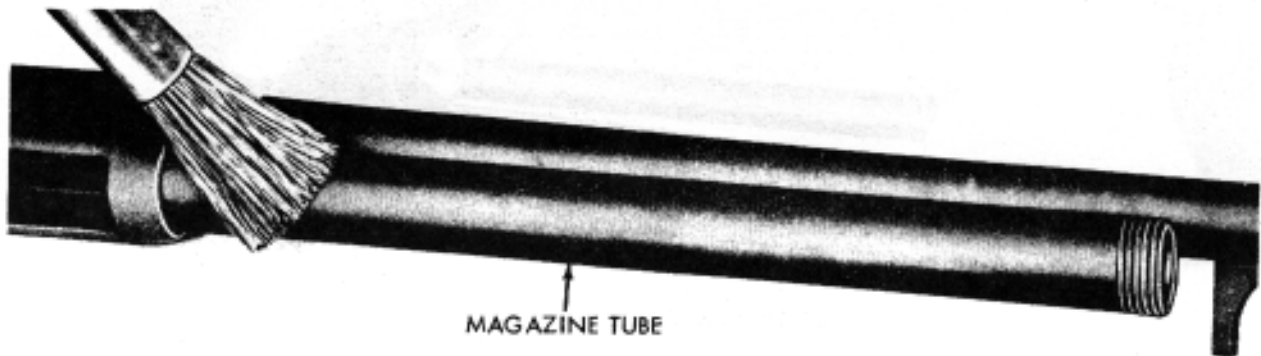

7. Outer surface of magazine tube, bearing surface of slide handle.

Figure 12. Cleaning and lubrication points.

c. Wooden components, which includes the stock and slide handle, shall be cleaned by wiping with a slightly oiled rag, then polished with a clean dry cloth. Apply a light coat of linseed oil and rub into wood with heel of hand (fig. 13). This will help preserve the wood.



Figure 13. Cleaning and treating stock and handle.

10. Inspection

a. Inspect stock bolt (2, fig. 21) for damaged threads.

b. Inspect positive extractor (1, fig. 22) and bottom assembly extractor (5, fig. 22) for wear and damage.

c. Inspect firing pin (8, fig. 22) for broken or bent point.

d. Inspect carrier screw (7, fig. 21), carrier locking screw (6, fig. 21) and spring shell stop screw (2, fig. 23) for damaged threads or wear.

e. Examine for broken or weak firing pin spring (9, fig. 22), spring shell stop spring (4, fig. 23), and slide stop release spring (5A, fig. 21).

f. Inspect for broken or cracked stock assembly (1, fig. 21).

g. Inspect positive shell assembly stop (1, fig. 23) and spring shell stop (3, fig. 23) for wear or damage.

h. Inspect for worn or damaged front swivel assembly (5, fig. 23).

i. Inspect camming surfaces for burrs.

j. Inspect barrel bore for rust or corrosion.

11. Repair

a. Remove rust from barrel bore, using a rag moistened with CR, rifle bore cleaner (fig. 11). Use steel wool, if necessary.

b. Remove burrs on camming surfaces, using a fine grained stone (fig. 14).

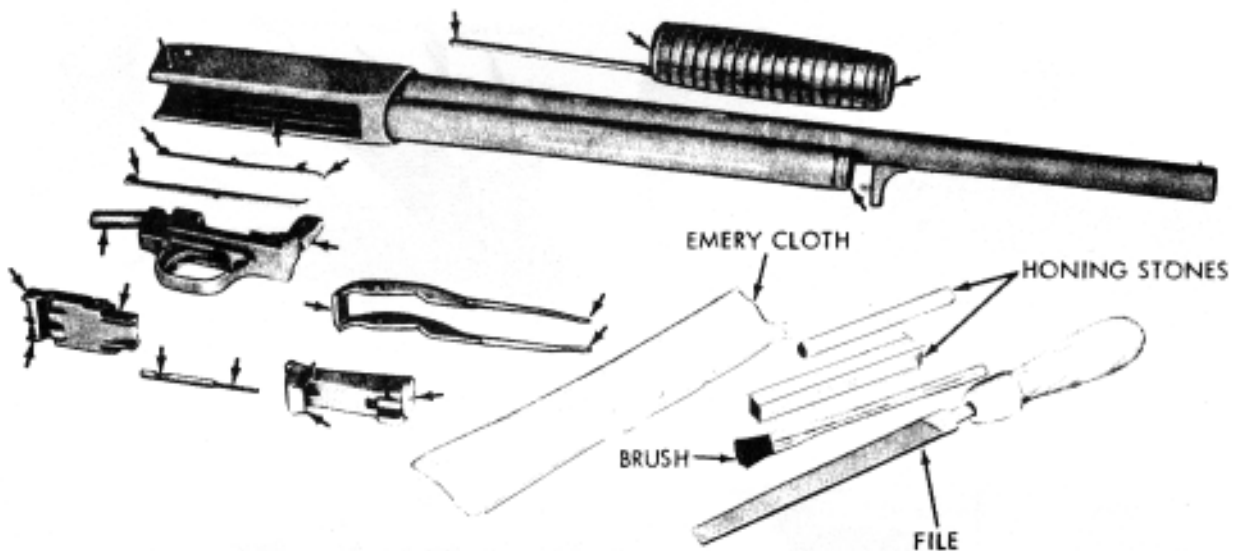

NOTE: ARROWS SHOWN ABOVE INDICATE BURRED AREAS. USE NAMED ITEMS TO REMOVE BURRS.

Figure 14. Removal of burrs from camming surfaces.

c. Replace worn or damaged front swivel assembly (5, fig. 23), positive shell assembly stop (1, fig. 23), and spring shell stop (3, fig. 23).

d. Replace broken or cracked stock assembly (1, fig. 21).

e. Replace broken or weak firing pin spring (9, fig. 22), shell stop spring (4, fig. 23), and slide stop release spring (5A, fig. 21).

f. Replace spring shell stop screw (2, fig. 23), carrier locking screw (6, fig. 21) and carrier screw (7, fig. 21), if worn or threads are damaged.

g. Replace firing pin (8, fig. 22), if broken or damaged.

h. Replace bottom assembly extractor (5, fig. 22) and positive extractor (1, fig. 22), if worn or damaged.

i. Replace stock bolt (2, fig. 21), if threads are damaged.

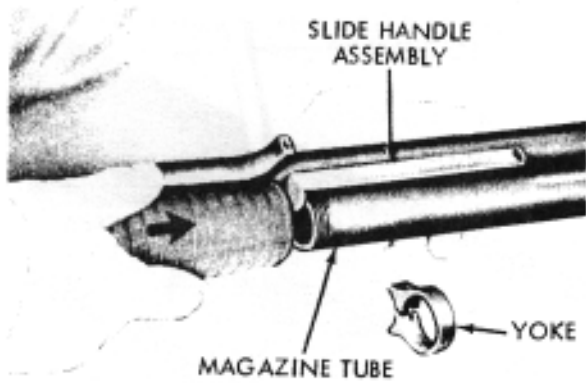

1. Install slide handle assembly.

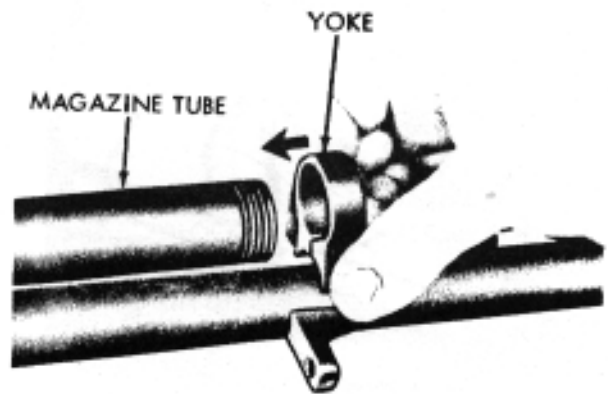

2. Install yoke.

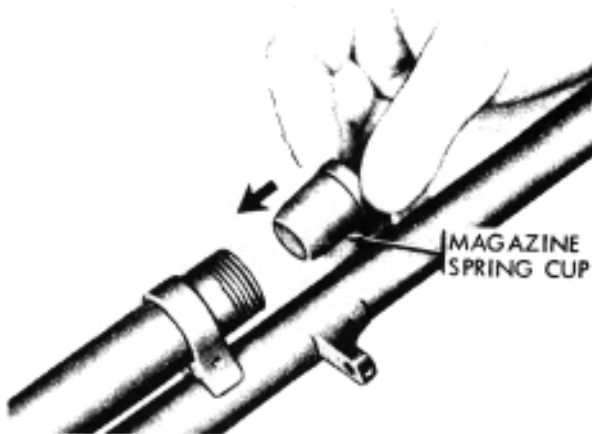

3. Install magazine spring cup.



NOTE: WHEN INSTALLING MAGAZINE NUT MAKE CERTAIN NUT IS TURNED CLOCKWISE AS FAR AS POSSIBLE

4. Install magazine spring and magazine nut.

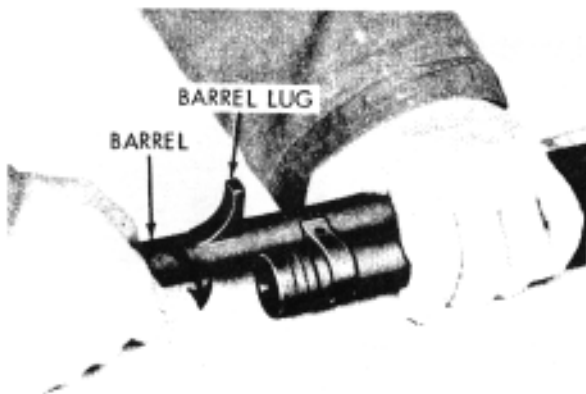

5. Rotate barrel 90-degrees.

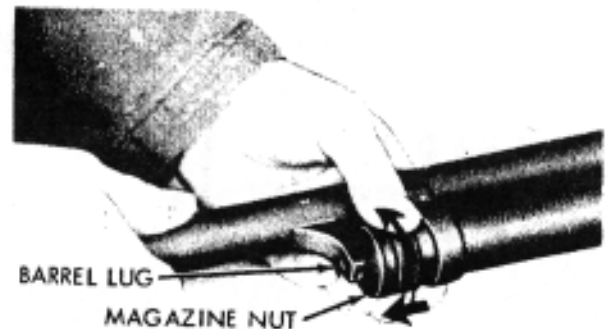

NOTE: TURN MAGAZINE NUT COUNTER-CLOCKWISE TO LOCK BARREL LUG TO MAGAZINE NUT

6. Position magazine nut.

Figure 15. Assembly of barrel and receiver.
#7. Replace and tighten yoke screw.

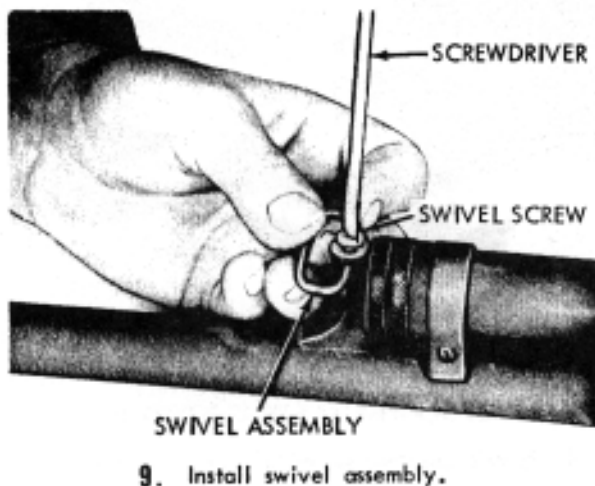
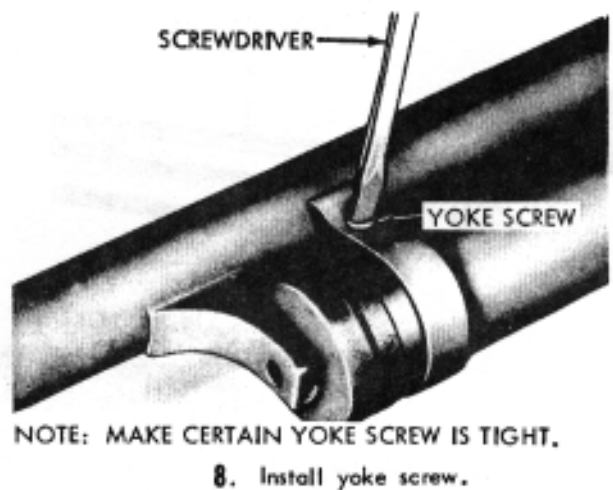
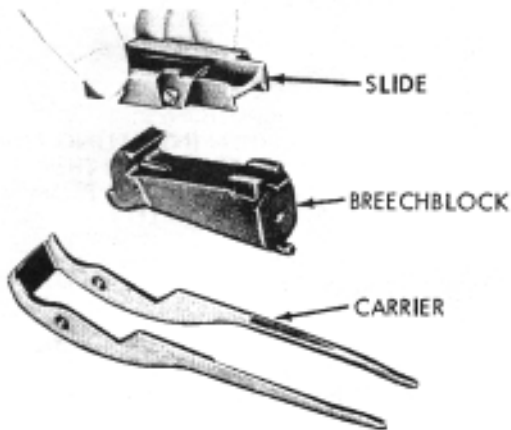
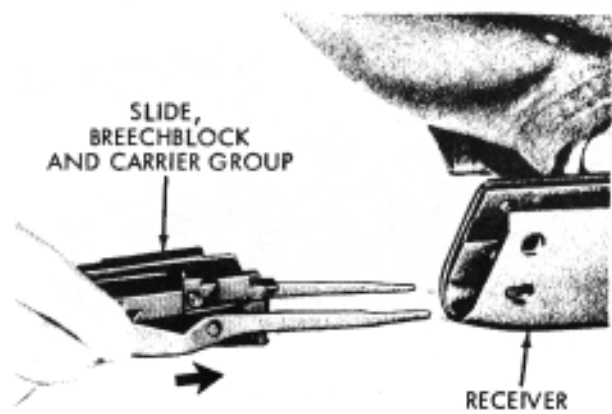

Figure 16. Assembly of barrel and receiver (Continued).

14. Installation of slide, breechblock, carrier and trigger plate group (See figures 18 and 19.)



1. Assemble slide, breechblock and carrier.



2. Install slide, breechblock and carrier into receiver.

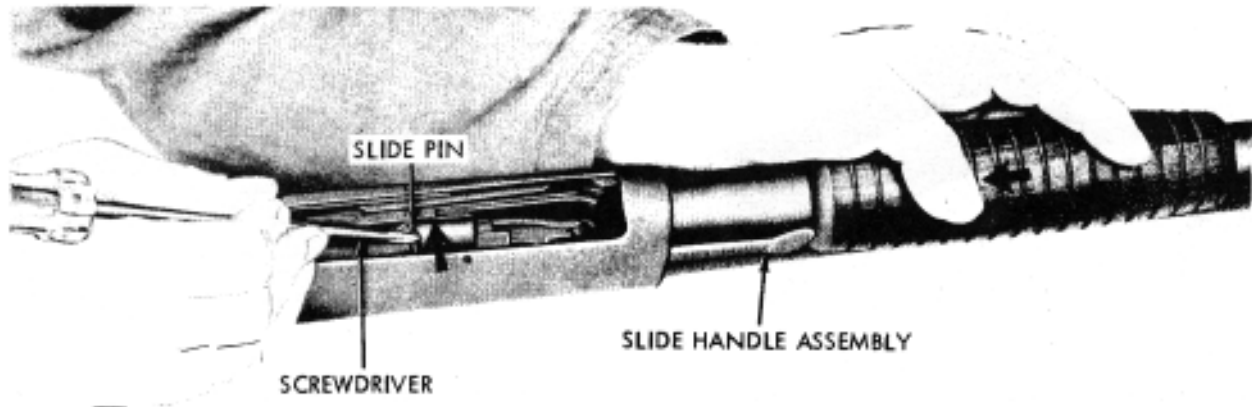

3. Connect slide handle assembly.

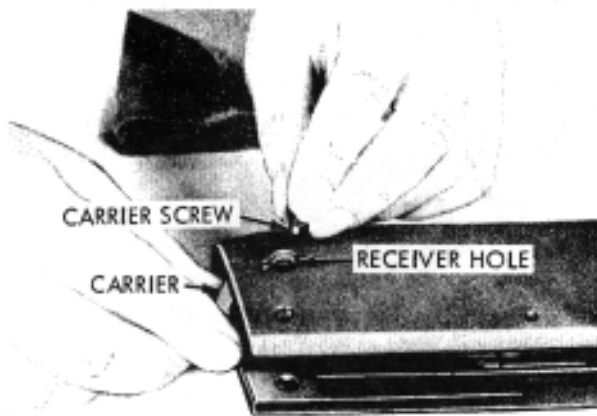

4. Aline carrier screw holes with holes in receiver.

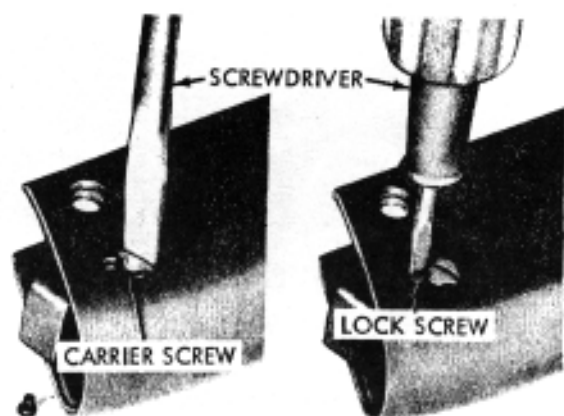

5. Install left hand carrier screw and lock screw.

Figure 18. Installation of slide, breechblock, carrier and trigger plate group.

13. Assembly of breechblock (See figure 17.)

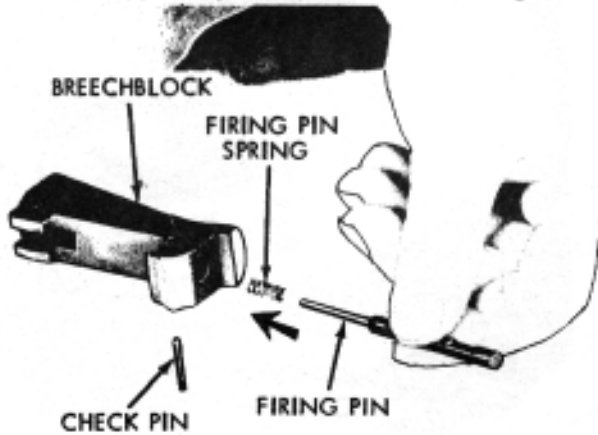

1. Install firing pin spring and firing pin.

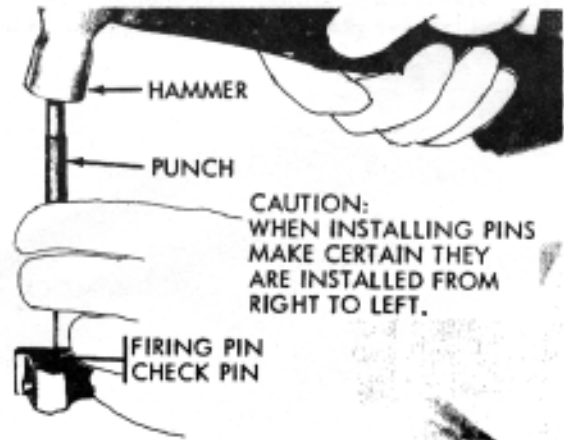

2. Install firing pin check pin.

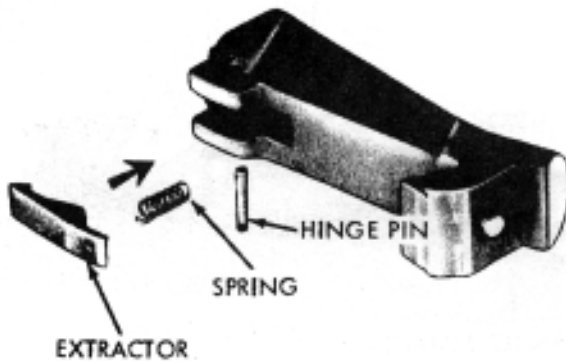

3. Install bottom assembly extractor spring and bottom assembly extractor.

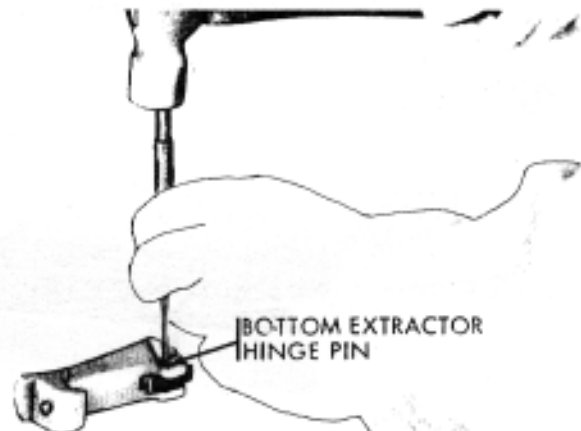

4. Install bottom assembly extractor hinge pin.



5. Install positive extractor spring and positive extractor spring cap.

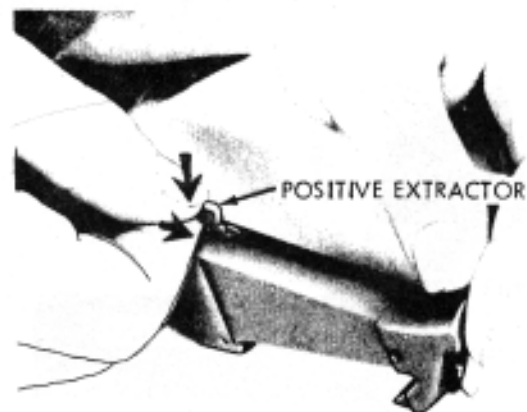

6. Install positive extractor (top).

Figure 17. Assembly of breechblock.

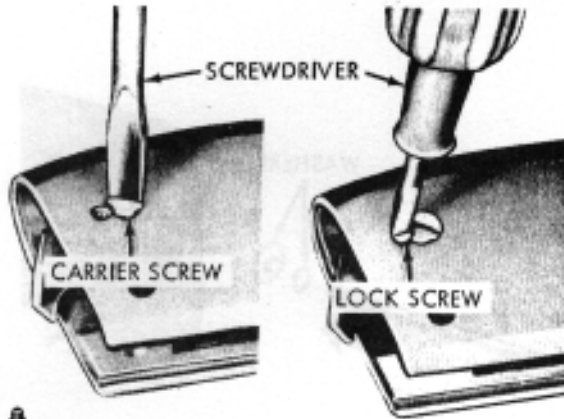

6. Install right hand carrier screw and lock screw.

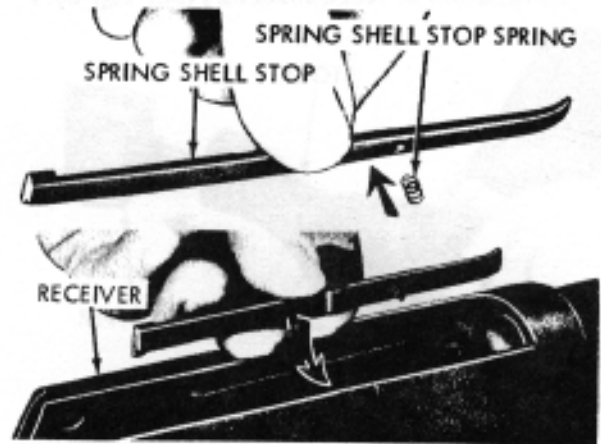

7. Install spring shell stop (left) and spring.

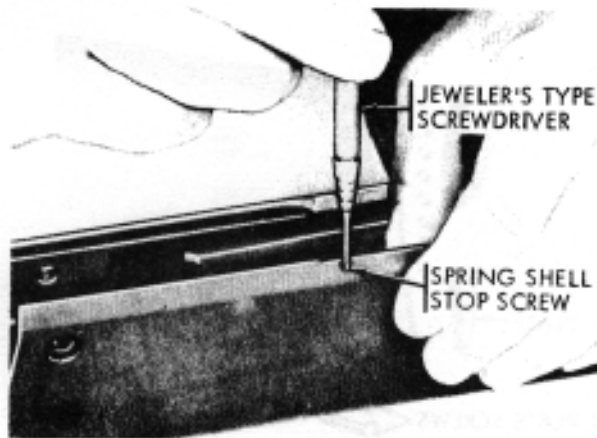

8. Install spring shell stop screw.

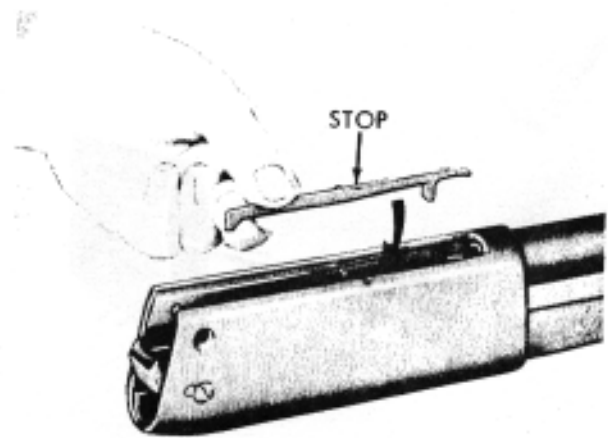

9. Install positive shell assembly stop (right).

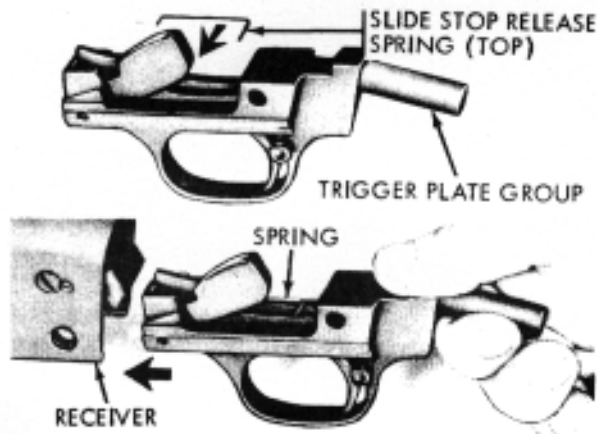

10. Install trigger plate group.

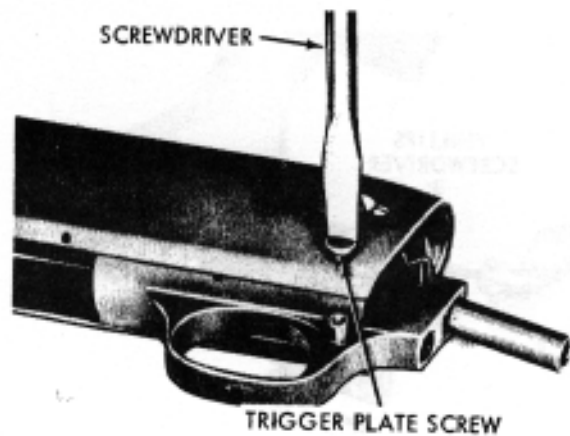

11. Install trigger plate screw.

Figure 19. Installation of slide, breechblock, carrier and trigger plate group (Continued).

15. Installation of stock assembly (See fig. 20.)

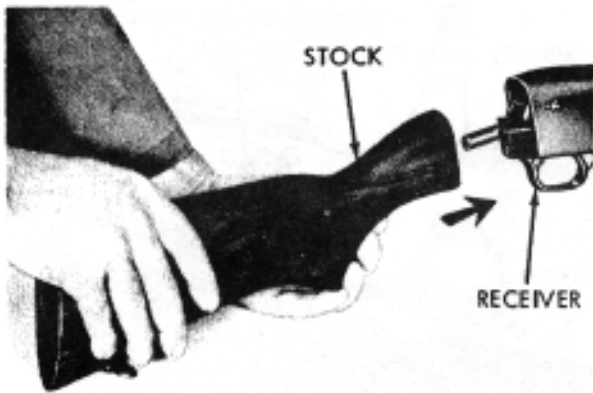

1. Install stock to receiver.

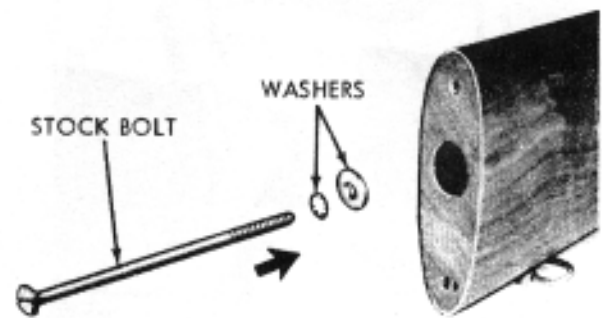

2. Install washers on stock bolt.

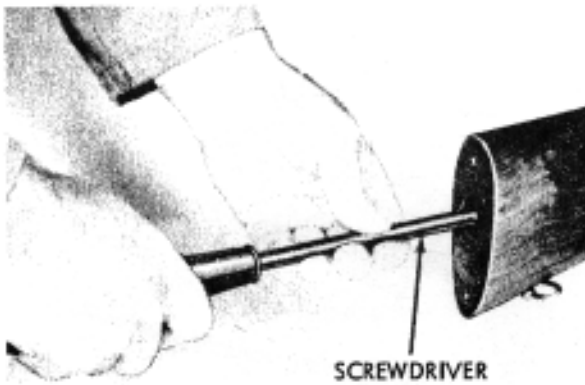

3. Install stock bolt.

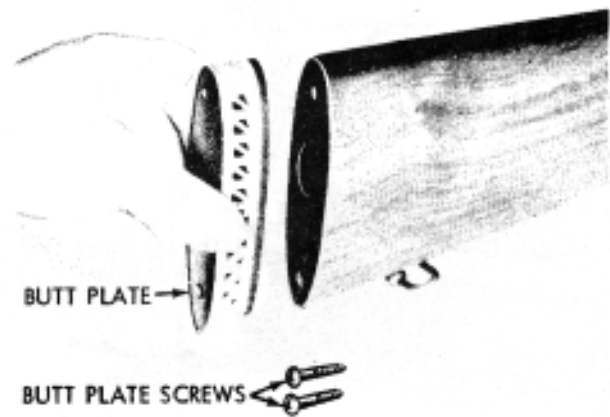

4. Install butt plate.

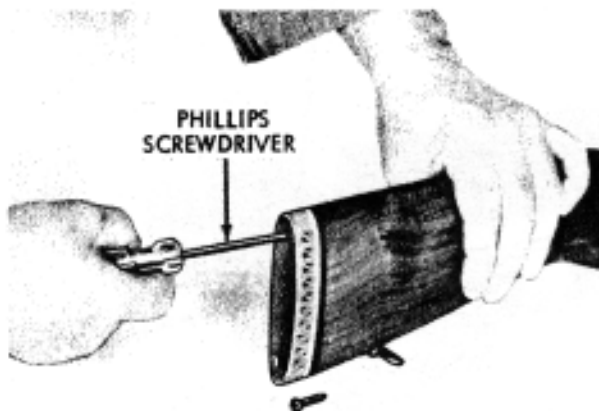

5. Install butt plate screws.

Figure 20. Installation of stock assembly.