

**NEC**

ND-70428 (E)  
ISSUE 1  
STOCK # 200892

**NEAX<sup>®</sup> 2400 IMX**  
**Message Center Interface (MCI)**  
**Specifications**

JANUARY, 1999

NEC America, Inc.

## **LIABILITY DISCLAIMER**

NEC America, Inc. reserves the right to change the specifications, functions, or features, at any time, without notice.

NEC America, Inc. has prepared this document for use by its employees and customers. The information contained herein is the property of NEC America, Inc. and shall not be reproduced without prior written approval from NEC America, Inc.

NEAX and D<sup>term</sup> are registered trademarks of NEC Corporation.

Copyright 1999

**NEC America, Inc.**

Printed in USA

# NEAX2400 IMX Message Center Interface (MCI) Specifications

## TABLE OF CONTENTS

	Page
LIST OF FIGURES .....	ii
LIST OF TABLES .....	iii
CHAPTER 1 INTRODUCTION .....	1
CHAPTER 2 MCI FOR IOC .....	3
1. SPECIFICATIONS .....	3
1.1 Interface .....	3
1.2 Text Format .....	3
2. PROTOCOL AND MESSAGE RESPONSES .....	4
2.1 PBX → MC .....	4
2.2 MC → PBX .....	4
CHAPTER 3 MCI FOR LAN .....	5
1. SPECIFICATIONS .....	5
1.1 Timing .....	5
1.2 Interface .....	5
1.3 Basic Configuration of Text .....	6
1.4 Text Format .....	9
2. PROTOCOL AND MESSAGE RESPONSES .....	13
2.1 Link Establishment Sequence .....	13
2.2 Transmission and Reception of Call Information .....	14
2.3 MWL Control .....	19
2.4 Monitoring Status Between Client and Server .....	23
2.5 Link Release Sequence .....	24
2.6 Connection Sequence for System Changeover .....	25
CHAPTER 4 MESSAGE FORMAT .....	27
1. ICS FORMAT .....	27
2. IMX FORMAT .....	31
CHAPTER 5 SERVICE CONDITIONS .....	39
CHAPTER 6 DATA ASSIGNMENT .....	41

## LIST OF FIGURES

Figure	Title	Page
Figure 1-1	MCI for UCD Incoming Call	1
Figure 1-2	MCI for Attendant Incoming Call	1
Figure 2-1	Word Framing Example	3
Figure 2-2	Typical Text Format	3
Figure 3-1	PBX and MCI for LAN Interface	6
Figure 3-2	Text Basic Configuration	6
Figure 3-3	Lamp Control Text Configuration	9
Figure 3-4	Call Information Text Configuration	9
Figure 3-5	Server Response Text Configuration	10
Figure 3-6	Client Response Text Configuration	11
Figure 3-7	Status Monitoring Text Configuration	11
Figure 3-8	Link Release Text Configuration	12
Figure 3-9	Link Establishment Sequence	13
Figure 3-10	Transmission and Reception of Call Information Sequence	14
Figure 3-11	Transmission and Reception of Call Information Error Processing Sequence (1)	15
Figure 3-12	Transmission and Reception of Call Information Error Processing Sequence (2)	16
Figure 3-13	Transmission and Reception of Call Information Error Processing Sequence (3)	17
Figure 3-14	Transmission and Reception of Call Information Error Processing Sequence (4)	18
Figure 3-15	MWL Control Processing Sequence	19
Figure 3-16	MWL Control Error Processing Sequence (1)	20
Figure 3-17	MWL Control Error Processing Sequence (2)	21
Figure 3-18	MWL Control Error Processing Sequence (3)	22
Figure 3-19	Monitoring Status Between Client and Server Processing Sequence	23
Figure 3-20	Link Release Sequence	24
Figure 3-21	System Changeover Connection Sequence	25

## LIST OF TABLES

<b>Table</b>	<b>Title</b>	<b>Page</b>
Table 4-1	Call Type Codes for Attendant Incoming Calls .....	29
Table 4-2	Call Type Codes for UCD Incoming Calls .....	29
Table 4-3	Message Text Station Number Explanation .....	30
Table 4-4	PBX → MC Data Type Explanation .....	31
Table 4-5	Call Type Codes for Attendant Incoming Calls .....	34
Table 4-6	Call Type Codes for UCD Incoming Calls .....	34
Table 4-7	MC → PBX Data Type Explanation .....	35
Table 4-8	MC → PBX Data Type Explanation .....	37

This page is for your notes.

# CHAPTER 1 INTRODUCTION

This manual provides the Message Center Interface (MCI) specifications for the NEAX2400 IMX system. When a call terminates to the attendant or a Uniform Call Distribution (UCD) station, the call information is sent via the MCI to the Message Center (MC). Based on the call information from the Private Branch Exchange (PBX), the MC achieves ON/OFF control of the Message Waiting Lamp (MWL) and Message Waiting (MW) indication of the station. [Figure 1-1](#) and [Figure 1-2](#) show the MCI for a UCD incoming call and an attendant incoming call.

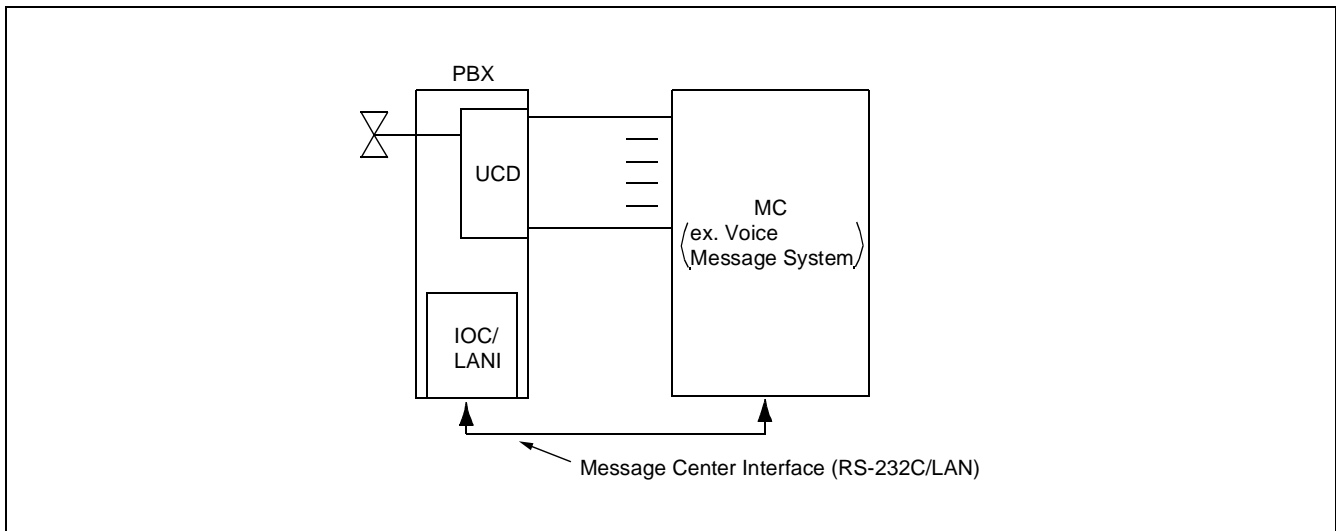

**Figure 1-1 MCI for UCD Incoming Call**

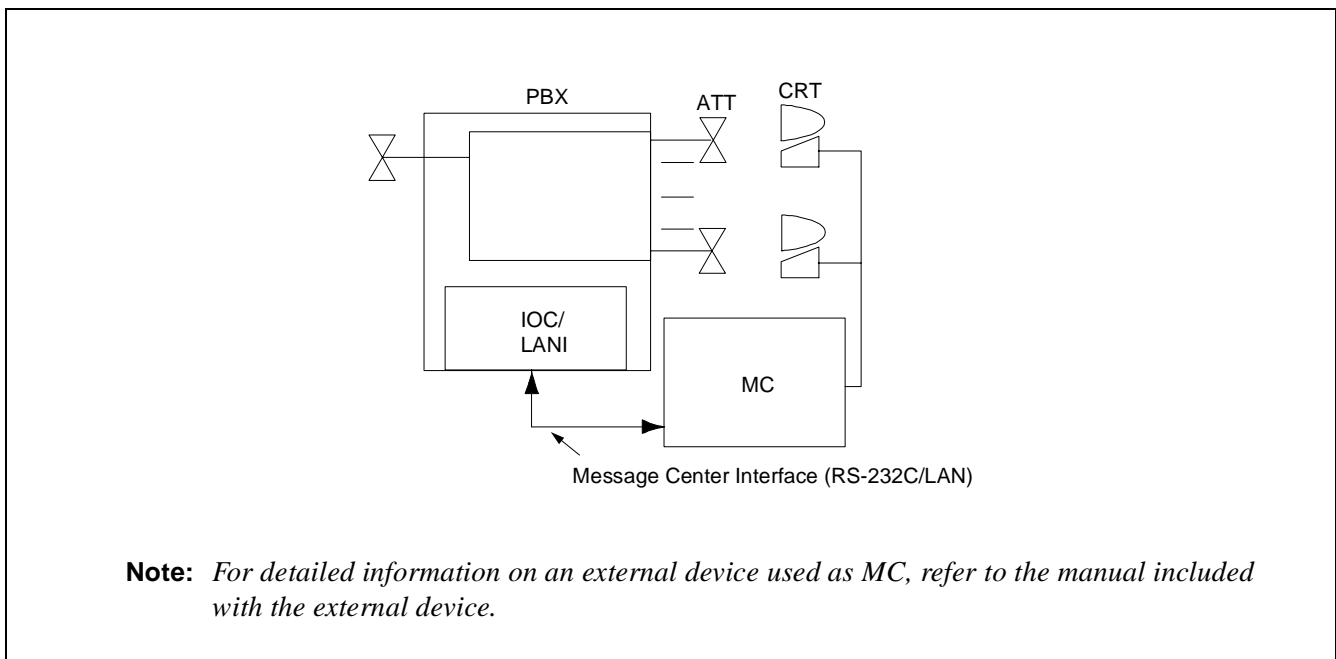

**Note:** For detailed information on an external device used as MC, refer to the manual included with the external device.

**Figure 1-2 MCI for Attendant Incoming Call**

This page is for your notes.



# CHAPTER 2 MCI FOR IOC

## 1. SPECIFICATIONS

### 1.1 Interface

This section has information on the signal interface requirements for the MCI for Input/Output Controller (IOC).

- Operating mode : Full duplex
- Electrical interface characteristic : RS-232C electrical interface standard
- Frame code : US ASCII
- Parity : Non/Odd/Even
- Word framing example : See [Figure 2-1](#).
- Data rate : Up to 9600 bps
- Priority sequence
  - Primary station : PBX
  - Secondary station : MC

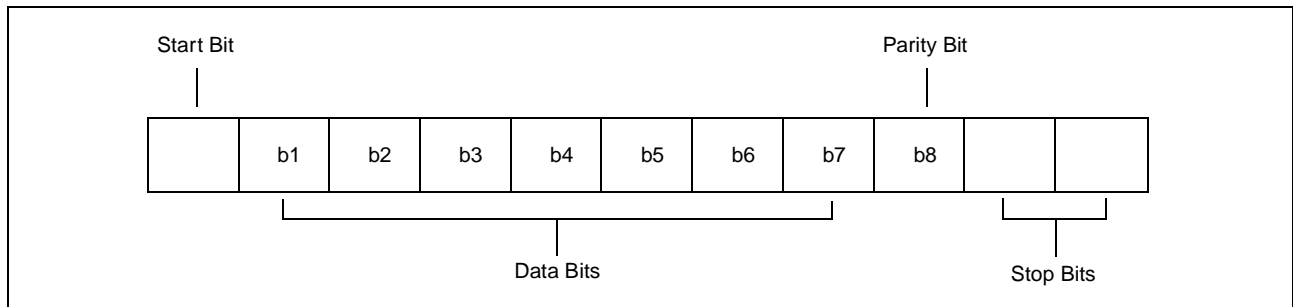
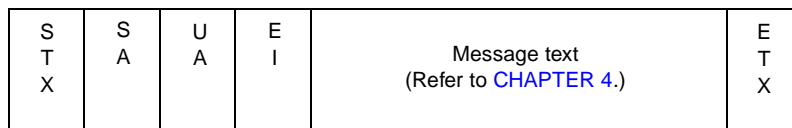

Figure 2-1 Word Framing Example

### 1.2 Text Format

MCI for IOC uses the following text format.



- STX : Start of Text
- SA : System Address
- UA : Unit Address
- EI : Entry Index
- ETX : End of Text

Figure 2-2 Typical Text Format

2. PROTOCOL AND MESSAGE RESPONSES

This section has information on protocol and message responses of MCI for IOC. For detailed information on each message, refer to [CHAPTER 4](#).

2.1 PBX → MC

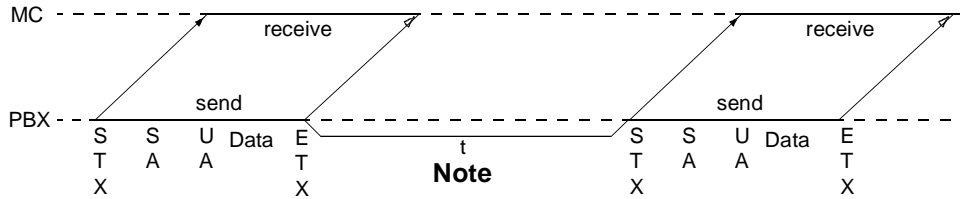

**Note:** The interval between communications is the Guard Timing (GT) value programmed in ASYD (SYS1, Index 28, Bits 0-4).

2.2 MC → PBX

(1) When receiving messages controlling one station, the following text format applies.

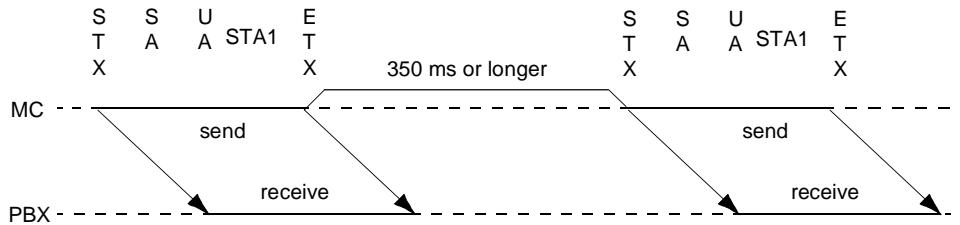

(2) When receiving queue is full, the PBX sends Call Type 39. This requests MC to stop transmission. When the PBX has processed all MWL requests in full queue, the PBX sends Call Type 66. This requests MC to start sending MWL data.

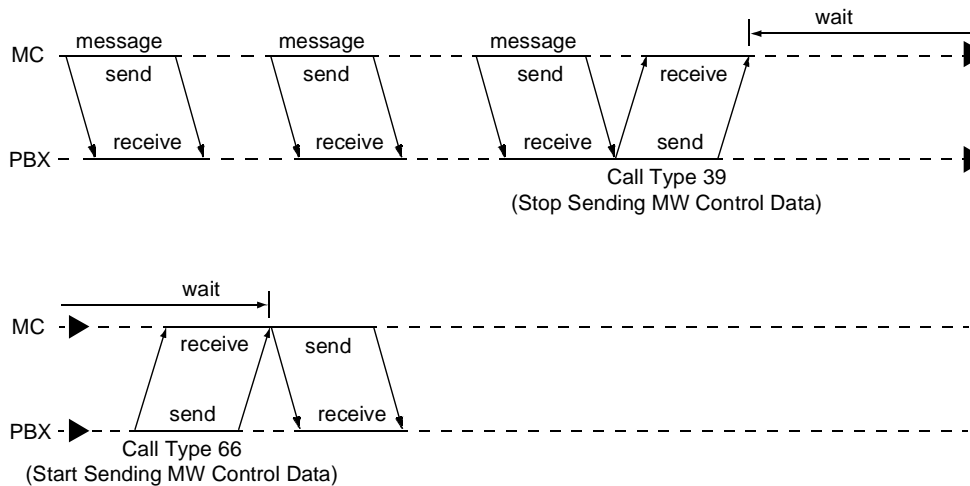

## CHAPTER 3 MCI FOR LAN

### 1. SPECIFICATIONS

#### 1.1 Timing

- Timing to Establish a Link : A link is connected when an MC connect request is received.
- Timing to Output Call Information : When a call terminates to the attendant or a UCD group station, the call information is sent via the MCI to the MC.
- Timing to Receive MWL Information : When Message Waiting Lamp (MWL) information is received, the MWL of the station served by the PBX is caused to be ON/OFF.
- Timing to Release the Link : The MC for Local Area Network (LAN), which is a client of the PBX, discards the socket and performs processing to release the link when it does not receive a “Call Information Text” or “Server Response Text” in a given time interval from the server. When the PBX or the server does not receive a “Lamp Control Text”, “Client Response Text”, or “Status Monitoring Text” in a given time interval from the client, it performs NG processing + sends a “Connection Disconnect Text” and then discards the socket and performs processing to release the link.

#### 1.2 Interface

This section has information on the interface requirements for the PBX and the external device (MC for LAN). [Figure 3-1](#) shows the PBX and the MCI for LAN interface.

- Protocol : Stream type socket (TCP) protocol
- Physical condition : Ethernet
- Software conditions
- PBX : Socket interface (capability provided to deal with WinSock)
  - External device : Shall use the WinSock, UNIX socket and other libraries.
- Port No. : 60020 (defined at PBX side)
- Codes to be used
- Transmission code : ASCII 8 bits without parity
  - Control codes
    - SYN : 16H indicates the beginning of a text.
    - STX : 02H indicates the beginning of an MCI record.
    - ETX : 03H indicates the end of an MCI record.



## (2) Text Identifier

The text identifier identifies the data to be sent or received.

Data type : Decimal (ASCII code)

Data size : 1 digit

Data range: 0 to 9

0 : Not used

1 : Lamp Control Text (MC for LAN → PBX)

The PBX that received the data sends the result of the received data check as a “Server Response Text (text identifier (3))” to the MC for LAN in a predetermined time interval.

2 : Call Information Text (PBX → MC for LAN)

The MC for LAN that received the data sends the result of the received data check as a “Client Response Text (text identifier (4))” to the PBX in a predetermined time interval.

3 : Server Response Text (PBX → MC for LAN)

When the PBX receives identifiers (1) or (5), it sends the result of the received data check to the MC for LAN.

4 : Client Response Text (MC for LAN → PBX)

When the MC for LAN receives identifier (2), it sends the result of the received data check to the PBX.

5 : Status Monitoring Text (MC for LAN → PBX)

When both the MC for LAN and PBX do not send any of the various types of processing requests, a status monitoring text is sent by the MC for LANs in a predetermined time interval.

When the PBX receives the text, it monitors the status of the client.

6 : Link Release Text (MC for LAN ← → PBX)

A link release request text sent from the client to the server and from the server to the client.

## (3) Data Length

The data length indicates the length of data to be sent and received between the server and client.

The number of bytes ranging from the character following the data length to the character preceding to the parity is set in terms of 3 digits.

Data type : Decimal (ASCII code)

Data size : 3 digits

Data range: 0 to 999

## MCI FOR LAN

### (4) Device No.

The device No. indicates the device No. for the MC for LAN connected to the server.

The MC for LAN sends its own device No. to the server, and the PBX sends the device No. for the MC for LAN, which is the destination of the text.

The device No. to be used is defined at the PBX side.

Data type : Decimal (ASCII code)

Data size : 2 digits

Data range: 0 to 99

### (5) Sequence No.

The sequence No. is a serial number for the data to be sent.

It is a number assigned to assure that the transferred data is cleared.

The PBX and server manage independent numbers respectively.

Data type : Decimal (ASCII code)

Data size : 2 digits

Data range: 0 to 99

### (6) Parity

The horizontal parity check method is adopted. The calculation range is from the text identifier to the character preceding to the parity. By default, odd parity is used.

The parity check method can be changed in system data.

Data type : Hexadecimal

Data size : 1 byte

Data range: 00H to FFH

1.4 Text Format

(1) Lamp Control Text (MC for LAN → PBX)

Figure 3-3 shows text to be sent when a request for control from the MC for LAN is presented. The format in a record is the IMX format of MCI message. It complies with the format of MC → PBX message in CHAPTER 4, Section 2, IMX FORMAT.

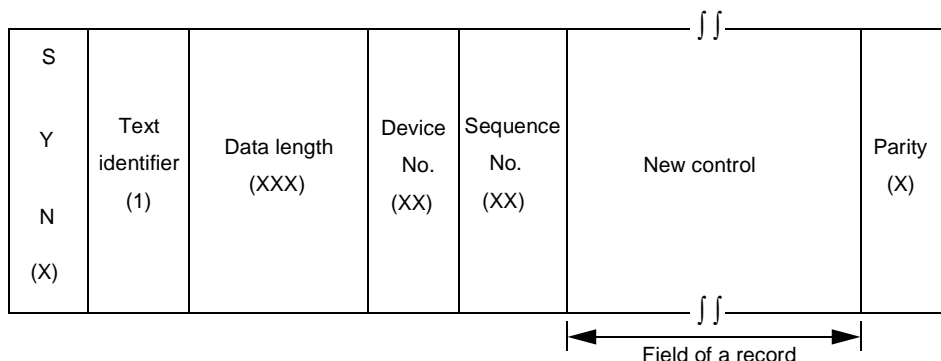

Figure 3-3 Lamp Control Text Configuration

(2) Call Information Text (MC for LAN ← PBX)

Figure 3-4 shows the call information text to be sent from the PBX to the MC for LAN. The format in a record is the IMX format of MCI message. It complies with the format of PBX → MC message in CHAPTER 4, Section 2, IMX FORMAT.

As for text identifier (2), a piece of call information is created when a call terminates to the attendant or a UCD station and when text is sent to the MC for LAN. Therefore, each text contains one record.

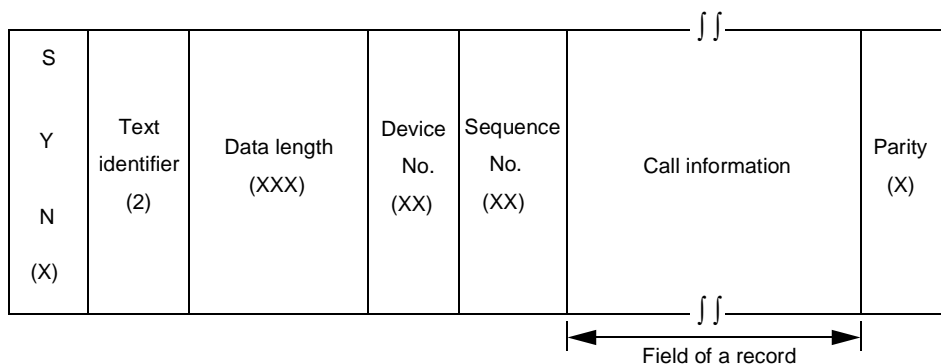

Figure 3-4 Call Information Text Configuration

## MCI FOR LAN

### (3) Server Response Text (MC for LAN ←PBX)

Figure 3-5 shows the server response text to be sent by the PBX that received text identifiers (1) and (5) to notify the MC whether or not the received text is correct.

Response No. (server information)

Data type : Decimal (ASCII code)

Data size : 1 digit

Data range: 0 to 9

0 : Normal

1 : Received text parity error

2 : Device No. not defined

3 : Received text error (incorrect text received)

4 to 9 : Not used

S						
Y	Text identifier	Data length	Device No.	Sequence No.	Response No.	Parity
N	(3)	(005)	(XX)	(XX)	(X)	(X)
(X)						

**Figure 3-5 Server Response Text Configuration**

### (4) Client Response Text (MC for LAN →PBX)

Figure 3-6 shows the client response text to be sent by the MC for LAN that received text identifier (2) to notify the PBX whether or not the received text is correct.

Response No. (client side information)

Data type : Decimal (ASCII code)

Data size : 1 digit

Data range: 0 to 9

0 : Normal

1 : Received text parity error

2 : Not used

3 : Received text error (incorrect text received)

4 to 9 : Not used



S						
Y	Text identifier	Data length	Device	Sequence	Response	Parity
N	(4)	(005)	No. (XX)	No. (XX)	No. (X)	(X)
(X)						

**Figure 3-6 Client Response Text Configuration**

(5) Status Monitoring Text (MC for LAN → PBX)

The text shown in [Figure 3-7](#) is defined for use in monitoring the server status from the client and the client status from the server. In response to the text, the server sends a “Server Response Text (3)” to the client.

Client device information

Data type : Decimal (ASCII code)

Data size : 2 digits

Data range: 0 to 99

Data type

00 : Normal

01 to 99 : To be defined at MC side

S						
Y	Text identifier	Data length	Device	Sequence	Client device infor- mation	Parity
N	(5)	(006)	No. (XX)	No. (XX)	(XX)	(X)
(X)						

**Figure 3-7 Status Monitoring Text Configuration**

## MCI FOR LAN

(6) Link Release Text (MC for LAN ← → PBX)

Figure 3-8 shows a link release request to be sent from the client to the server and from the server to the client. Processing is performed to release the link immediately after the text is received.

S					
Y	Text identifier	Data length (004)	Device No. (XX)	Sequence No. (XX)	Parity (X)
N	(6)				
(X)					

**Figure 3-8 Link Release Text Configuration**



## 2.2 Transmission and Reception of Call Information

(1) Normal Processing Sequence for Transmission and Reception of Call Information

Figure 3-10 shows the normal sequence used when the server sends call information to the client.

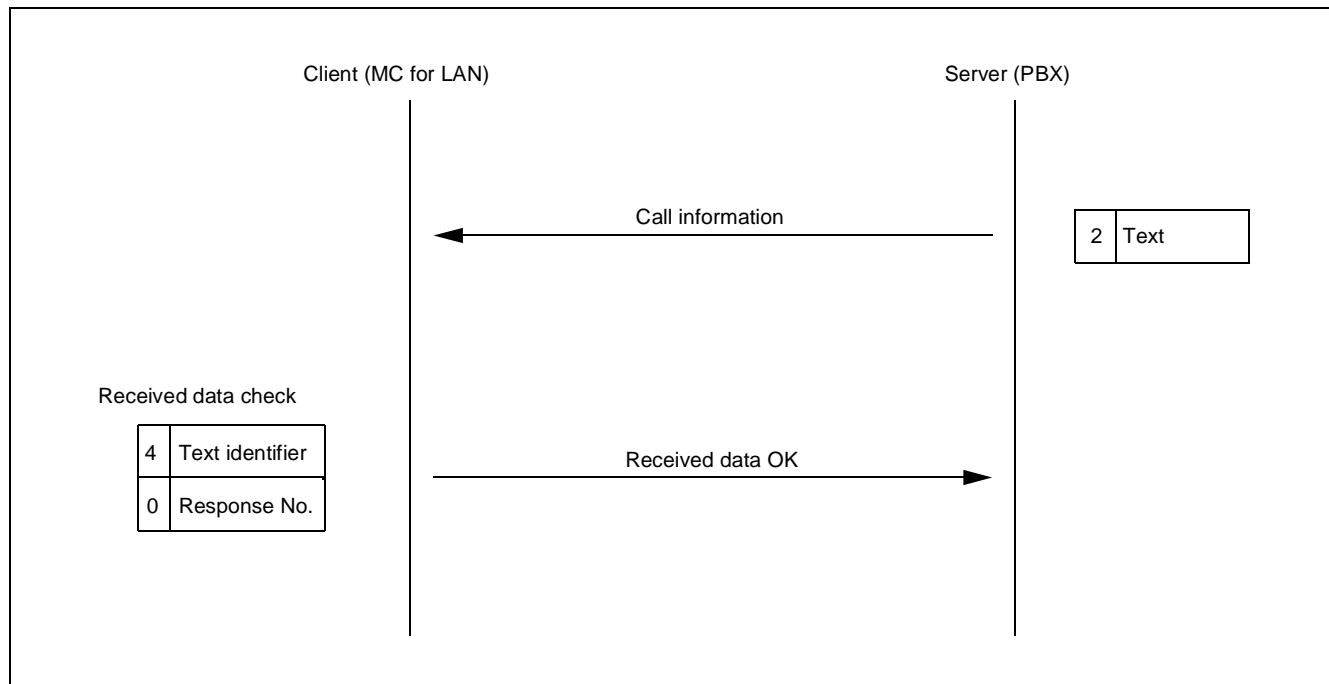

Figure 3-10 Transmission and Reception of Call Information Sequence

(2) Error Processing Sequence (1) for Transmission and Reception of Call Information

Figure 3-11 shows the error processing sequence used when the server sends call information to the client.

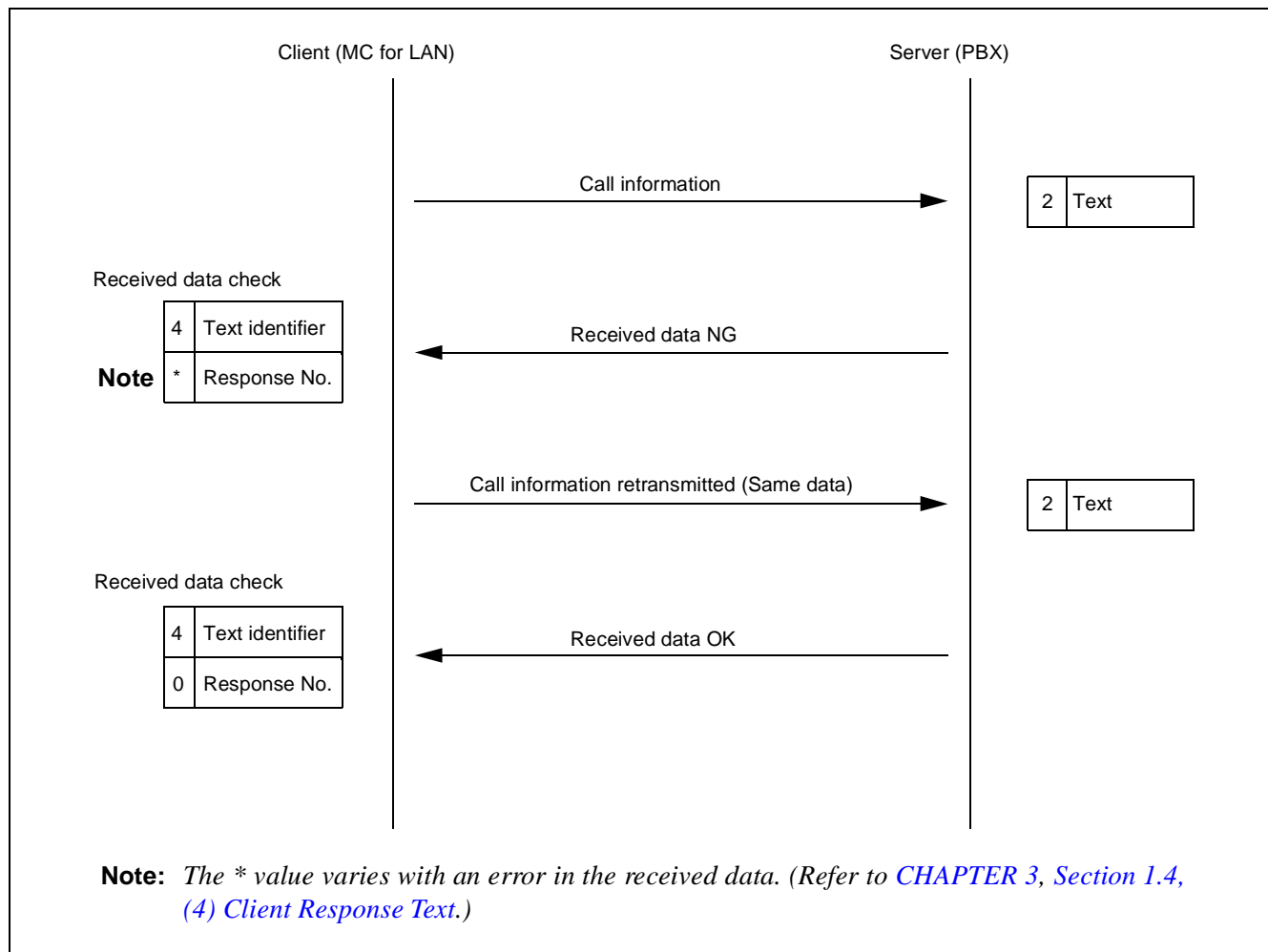
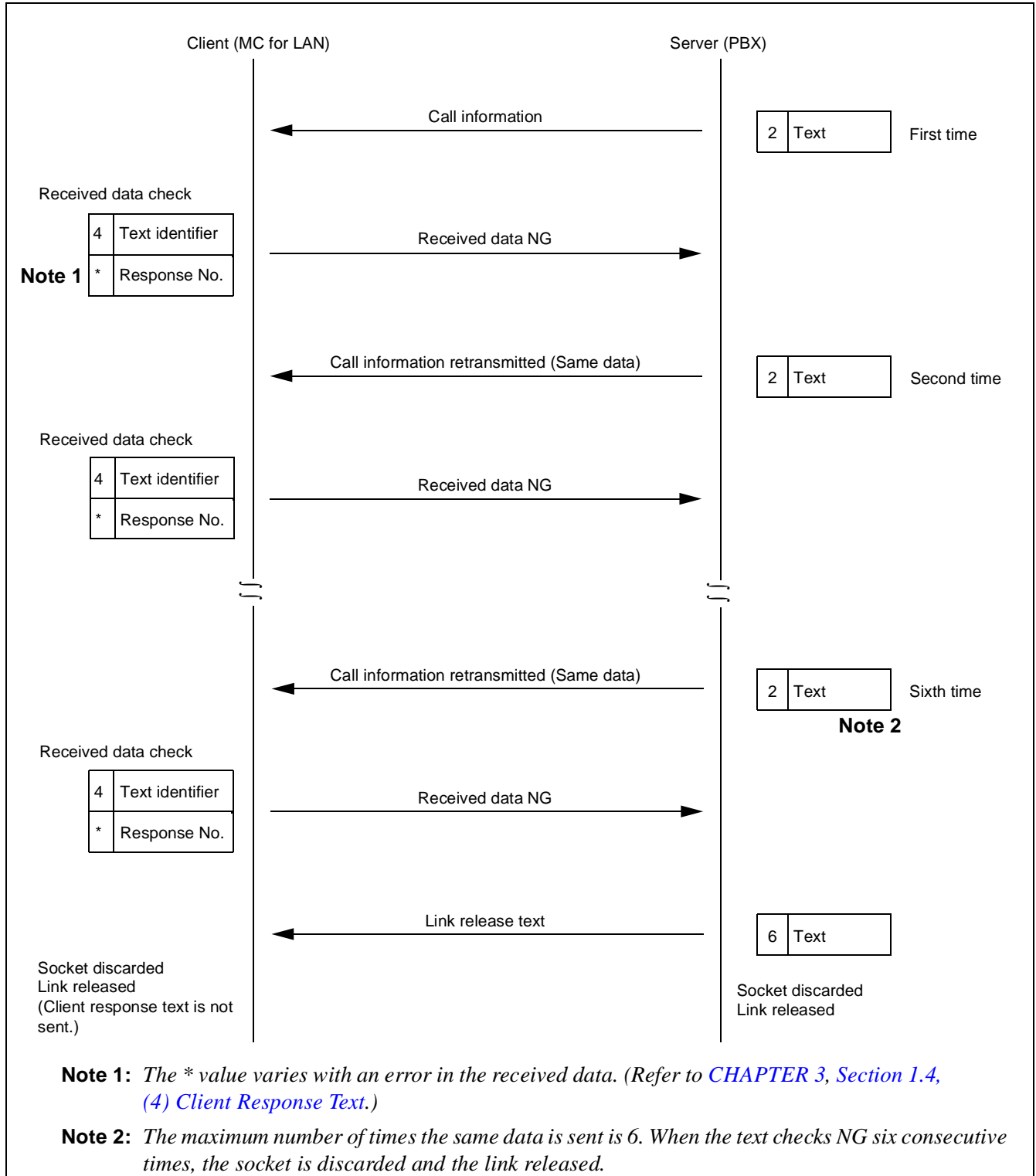

Figure 3-11 Transmission and Reception of Call Information Error Processing Sequence (1)

**MCI FOR LAN**

(3) Error Processing Sequence (2) for Transmission and Reception of Call Information

Figure 3-12 shows the error processing sequence used when the server sends call information to the client.



**Figure 3-12 Transmission and Reception of Call Information Error Processing Sequence (2)**



## MCI FOR LAN

### (5) Error Processing Sequence (4) for Transmission and Reception of Call Information

Figure 3-14 shows the sequence used when the server sends call information to the client and does not receive any client response text or detects an error in the data received by the client; the server then releases the link connected to the smaller numbered MC for LAN and sends call information to the other MC for LAN.

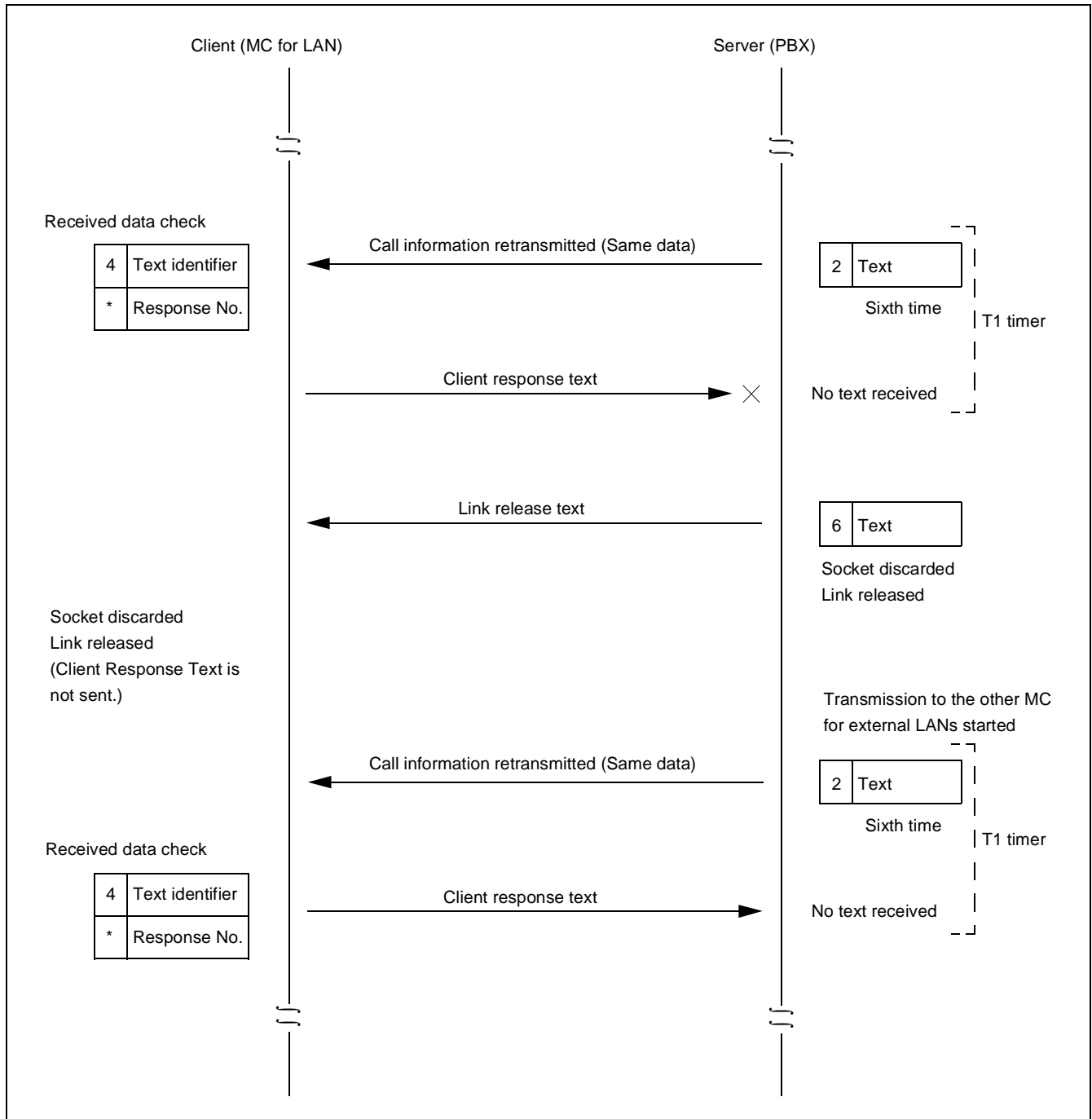

Figure 3-14 Transmission and Reception of Call Information Error Processing Sequence (4)



## 2.3 MWL Control

### (1) Normal Processing Sequence for Control of MWL

Figure 3-15 shows the normal processing sequence used when the client requests the server to control MWL.

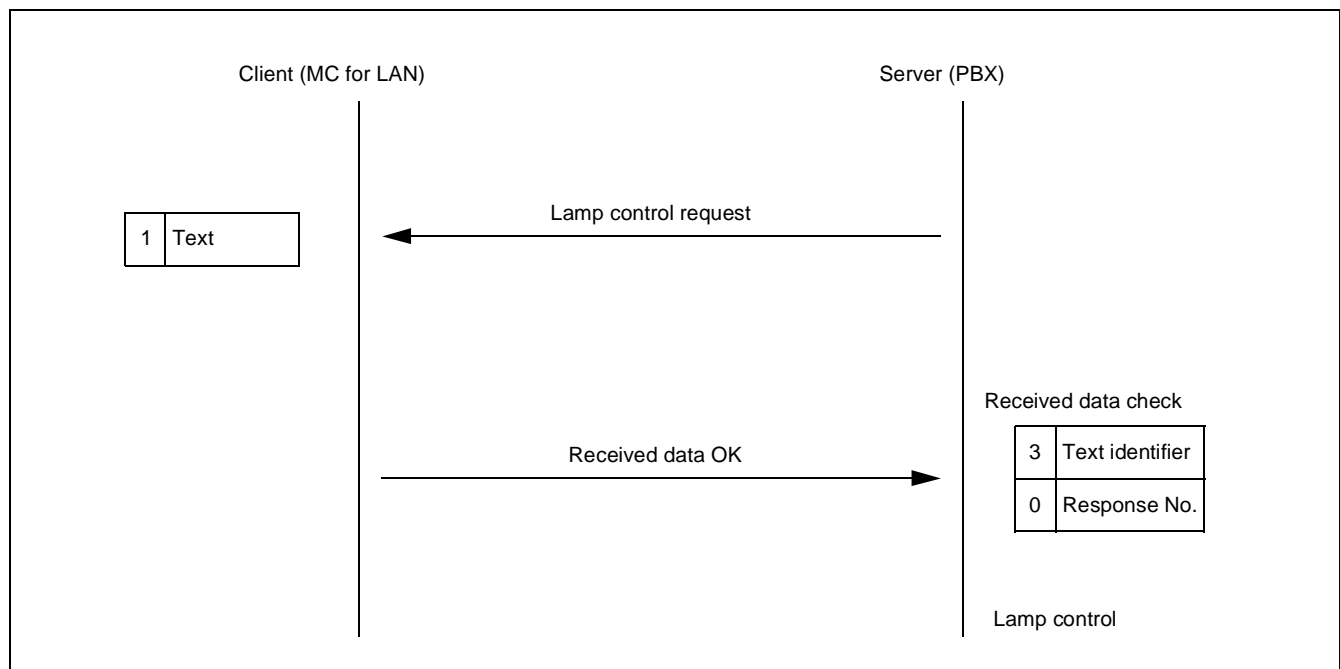

Figure 3-15 MWL Control Processing Sequence

## MCI FOR LAN

### (2) Error Processing Sequence (1) for Control of MWL

Figure 3-16 shows the processing sequence used when the client requests the server to control MWL and detects an error in the received data.

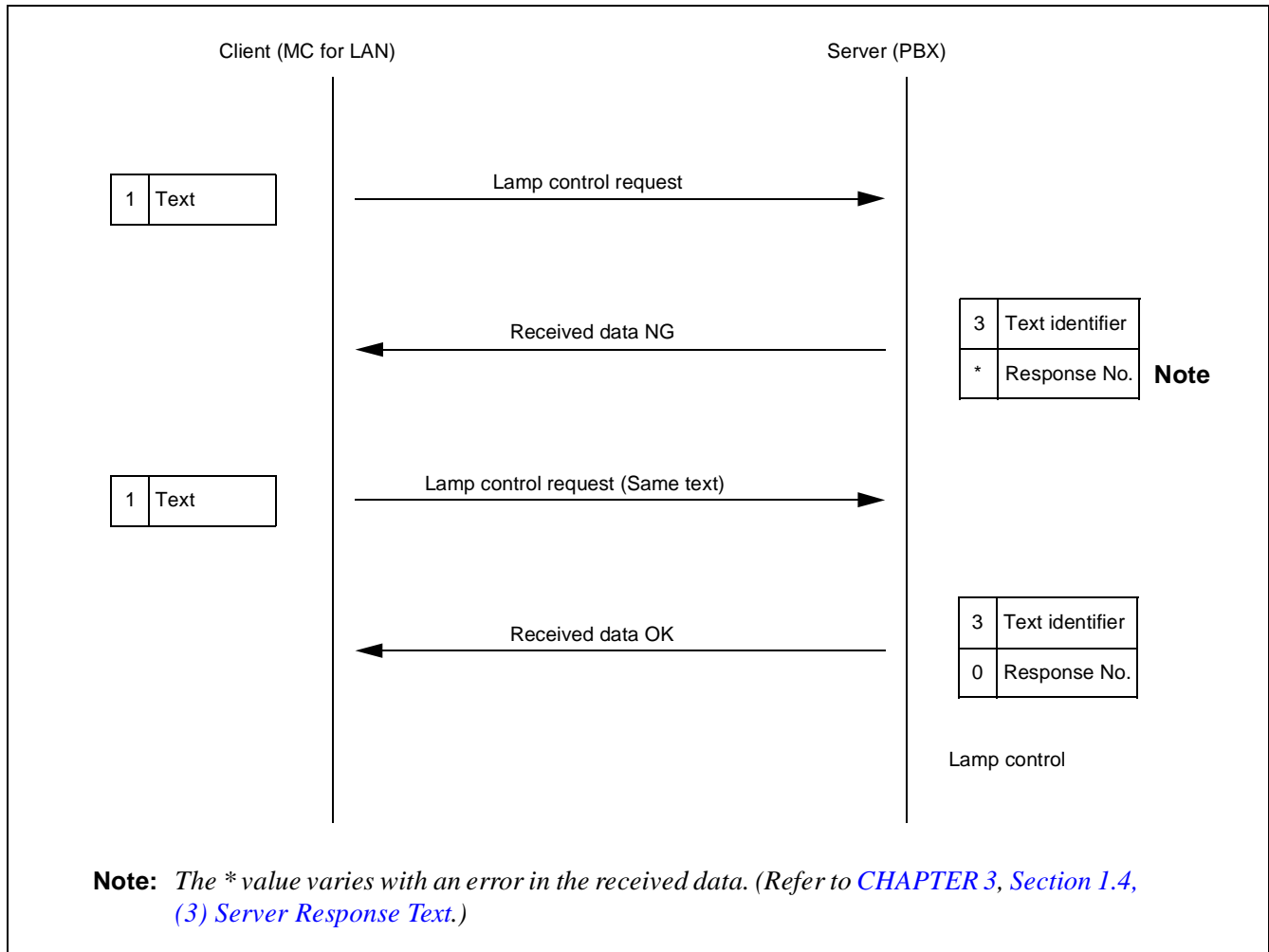

Figure 3-16 MWL Control Error Processing Sequence (1)

(3) Error Processing Sequence (2) for Control of MWL

Figure 3-17 shows the processing sequence used when the client requests the server to control MWL and detects an error in the received data.

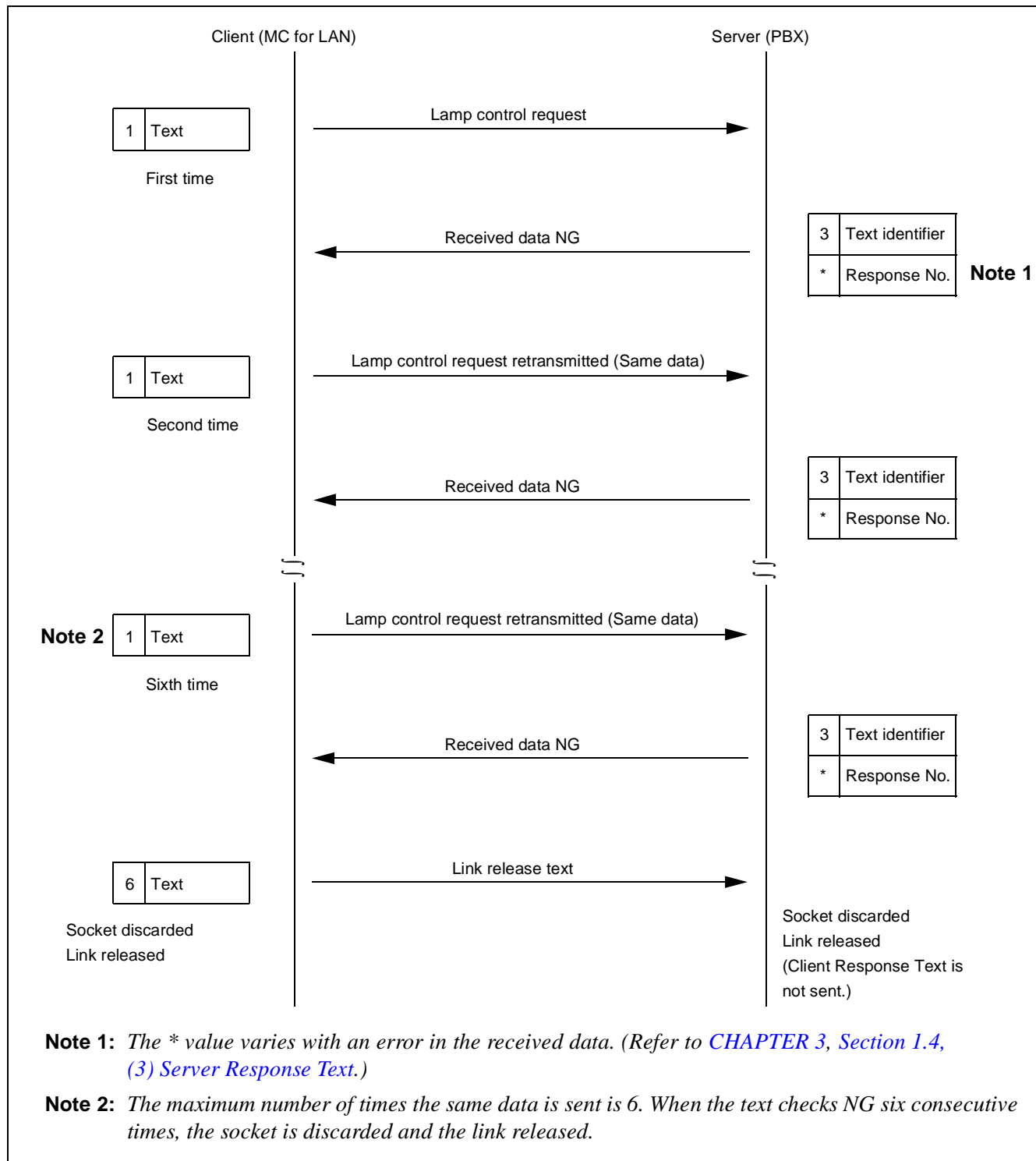
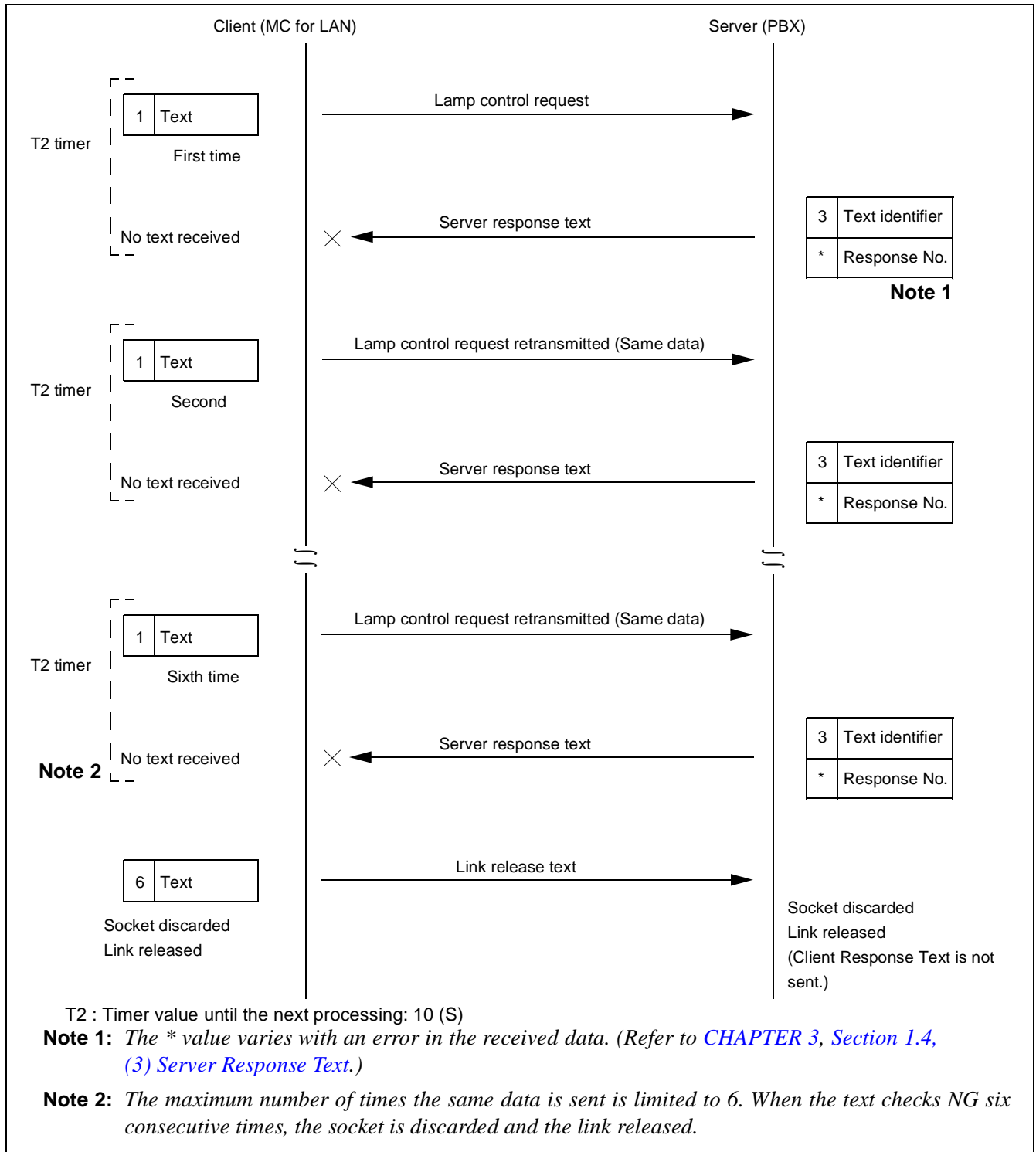

Figure 3-17 MWL Control Error Processing Sequence (2)

**MCI FOR LAN**

(4) Error Processing Sequence (3) for Control of MWL

Error processing sequence to be followed when the client requests the server to control MWL and does not receive any server response text.



**Figure 3-18 MWL Control Error Processing Sequence (3)**

## 2.4 Monitoring Status Between Client and Server

Figure 3-19 shows the processing sequence for monitoring status between client and server.

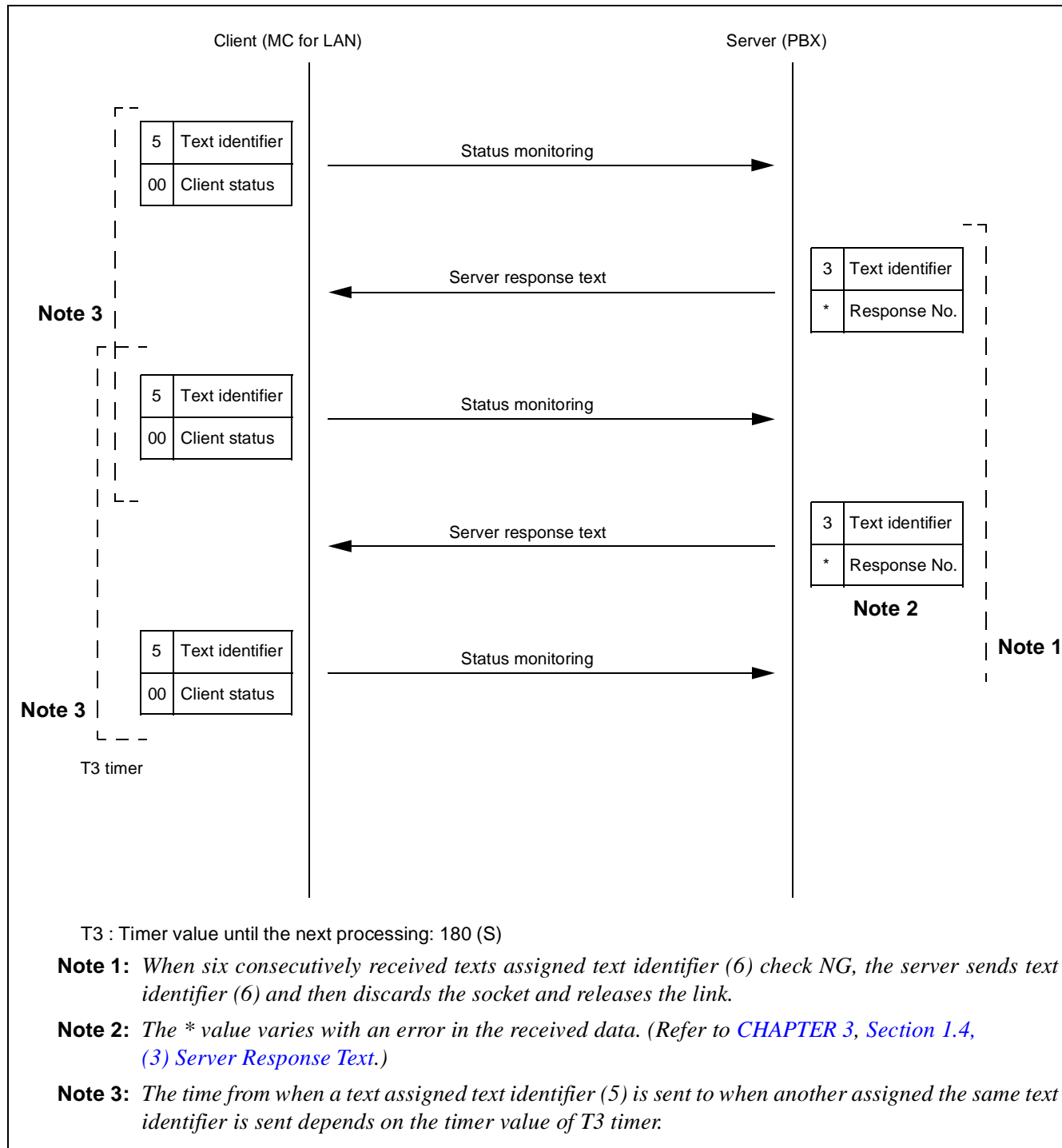

Figure 3-19 Monitoring Status Between Client and Server Processing Sequence

### 2.5 Link Release Sequence

Figure 3-20 shows the link release sequence used in response to a request from the client.

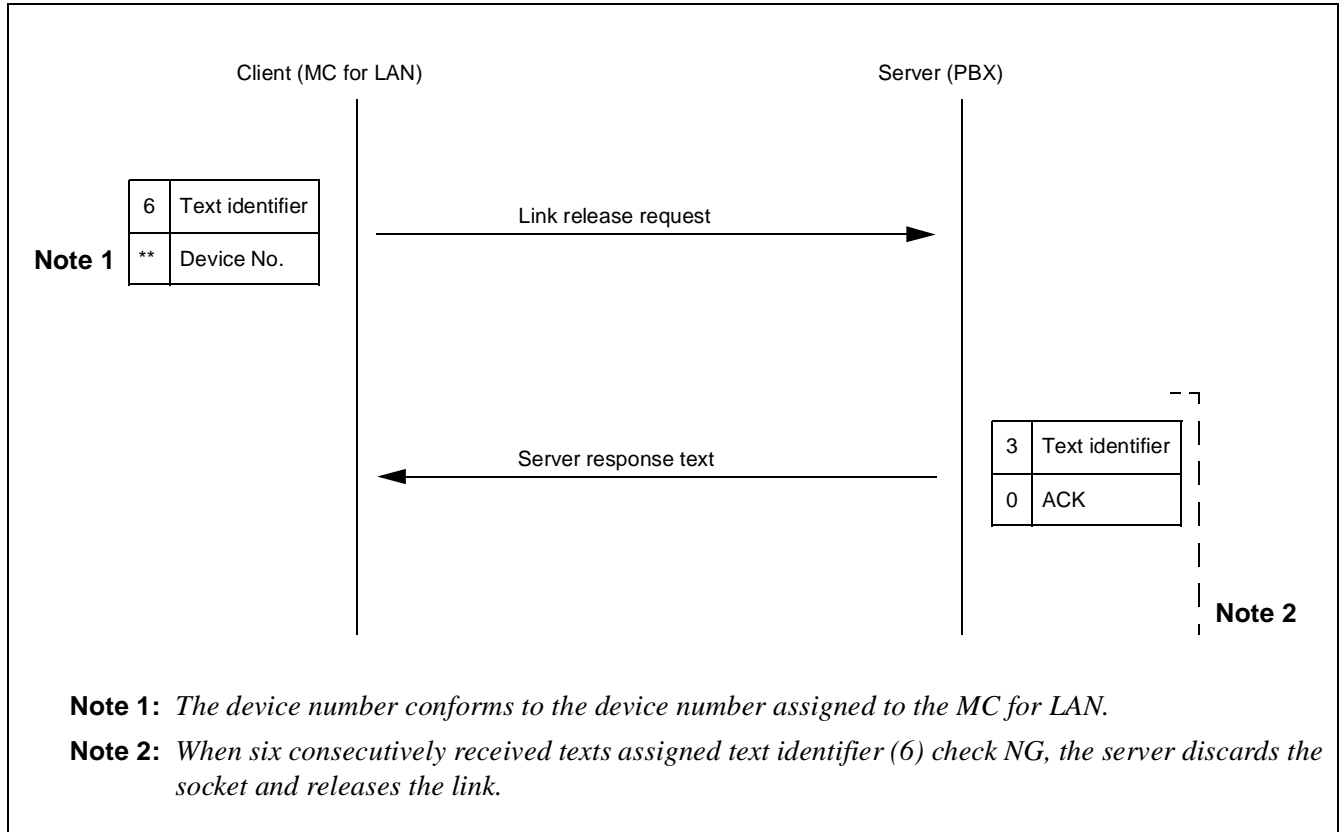

Figure 3-20 Link Release Sequence

## 2.6 Connection Sequence for System Changeover

Figure 3-21 shows the link release sequence used in response to a request from the client.

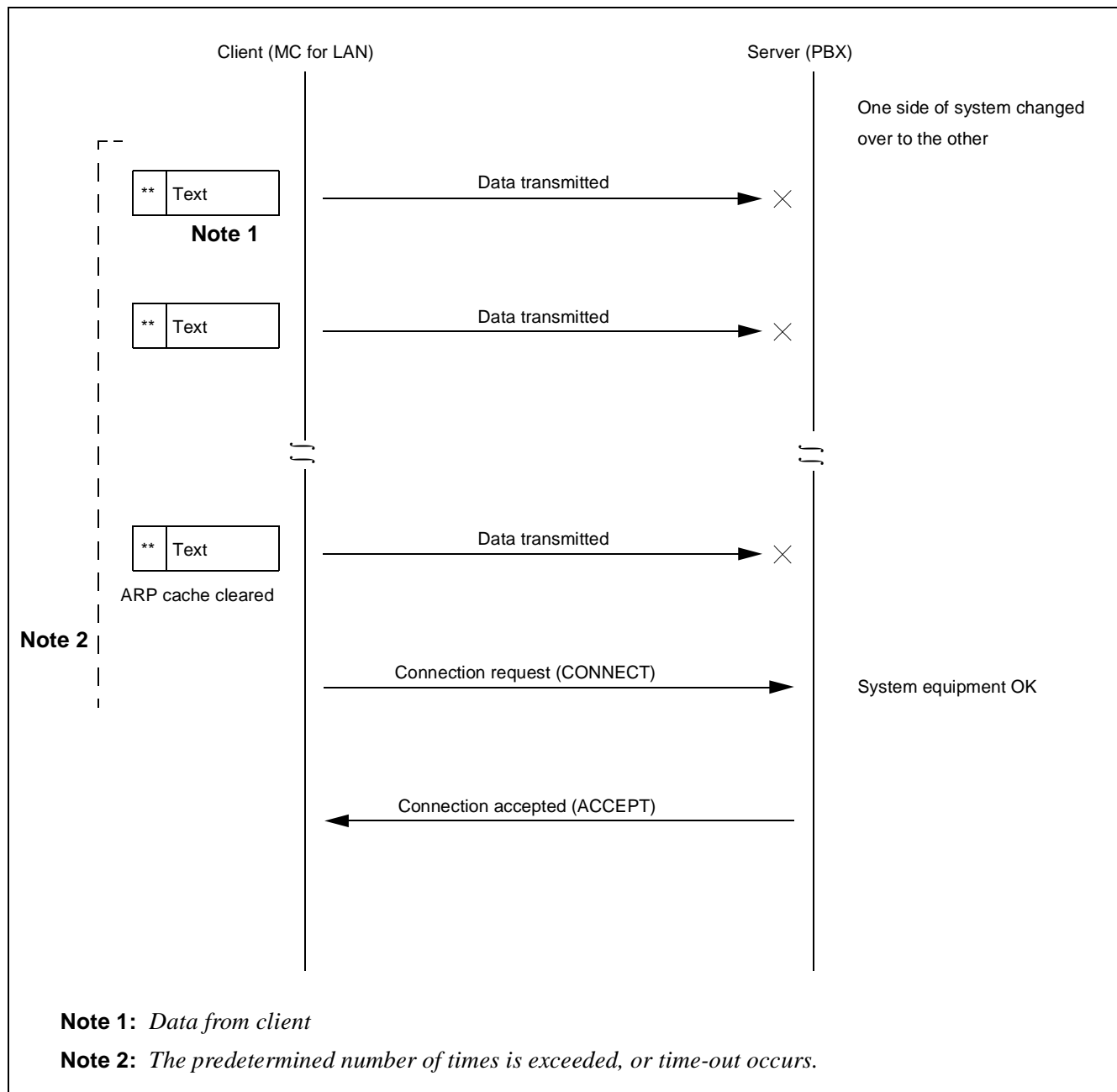

Figure 3-21 System Changeover Connection Sequence

This page is for your notes.





# MESSAGE FORMAT

## Note 1:

- *When the destination is a station*

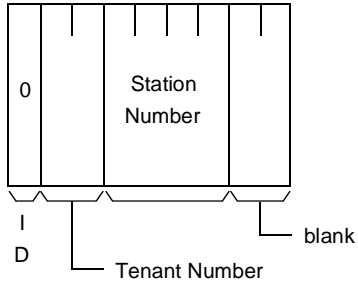

- *When the destination is the attendant*

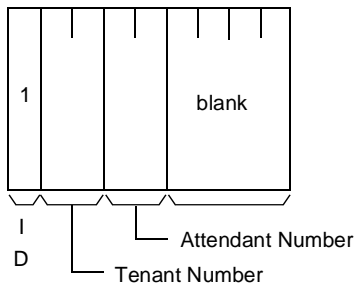

- *When the destination is a trunk*

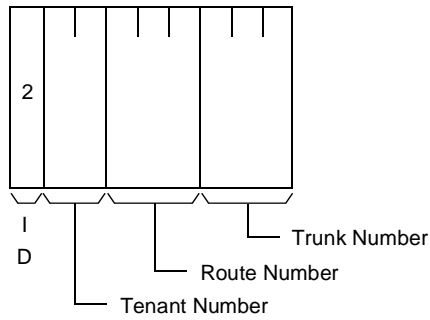

- *When the destination is a trunk (a calling number provided)*

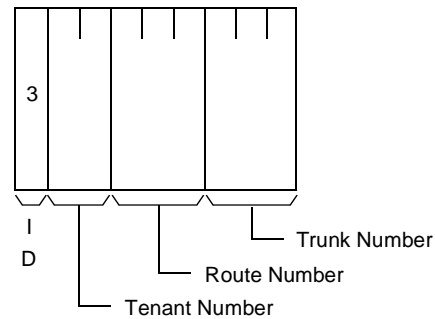

**Note 2:** This information is valid when Source of Information is the attendant.

**Note 3:** Table 4-1 and Table 4-2 identify the call types.

**Table 4-1 Call Type Codes for Attendant Incoming Calls**

CALL TYPE CODE	CALL TYPE	SOURCE	CALLING PARTY	CALLED PARTY
10	Automatic Recall	ATT	STA/TRK	STA
11	Attendant Camp-On	ATT	TRK	STA
12	Call Forwarding-Don't Answer	ATT	STA/TRK	STA
13	Call Forwarding-Busy Line	ATT	STA/TRK	STA
14	Call Forwarding-All Calls	ATT	STA/TRK	STA
15	Operator Call	ATT	STA	--
16	House Phone	ATT	STA	--
17	Off-Hook Alarm	ATT	STA	--
20	Intercept Call to the Attendant	ATT	STA/TRK	--
21	Call Transfer-Attendant	ATT	STA/TRK	STA/TRK
22	Recall from a Series Call	ATT	TRK	STA
23	Series Call Re-entry	ATT	TRK	STA
24	Tandem Transferring/Hold Entry	ATT	TRK	TRK
26	Inter-Position Transfer	ATT	STA/TRK	ATT
27	CAS Incoming Call	ATT	TRK	--
30	LDN Call	ATT	TRK	--
36	Call Returned from Hold	ATT	STA/TRK	--
39	Stop Sending MW Control Data	--	--	--
66	Start Sending MW Control Data	--	--	--

**Table 4-2 Call Type Codes for UCD Incoming Calls**

CALL TYPE CODE	CALL TYPE	SOURCE	CALLING PARTY	CALLED PARTY
40	Call Forwarding-Don't Answer	STA	STA/TRK	STA
41	Call Forwarding-Busy Line	STA	STA/TRK	STA
42	Call Forwarding-All Calls	STA	STA/TRK	STA
43	STA/TRK	STA	STA/TRK	UCD-Pilot
44	STA/TRK via ATT	STA	STA/TRK	ATT
45	STA/TRK Transferred to UCD Pilot Station	STA	STA/TRK	STA

**MESSAGE FORMAT**

(2) MC → PBX Message

- When Entry Index is A

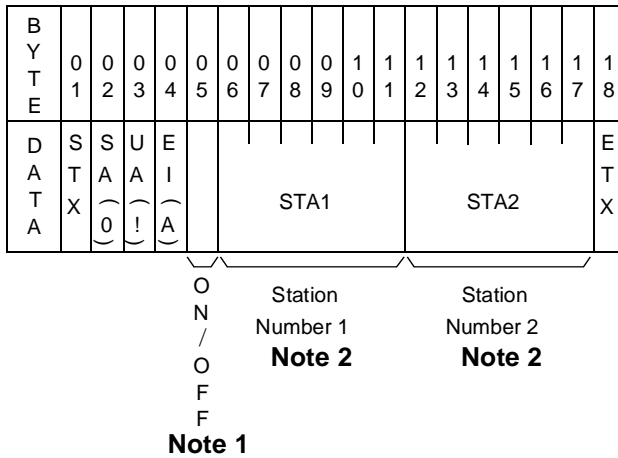

- When Entry Index is B

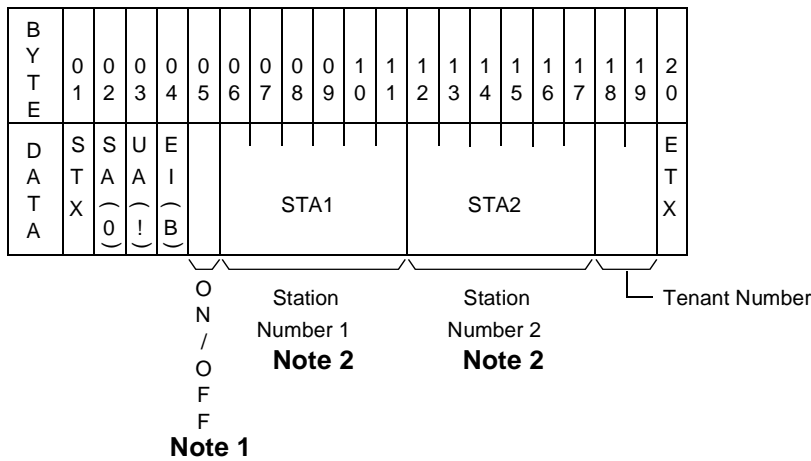

**Note 1:** This information has the following meanings:

- 0: All MWL Off
- 1: MWL On for MC
- 2: MWL On for VMS
- 5: MWL Off for MC
- 6: MWL Off for VMS

**Note 2:** Table 4-3 explains the meaning of STA1 and STA2. The number of digits in the station number and the tenant number of these stations must be the same.

**Table 4-3 Message Text Station Number Explanation**

STA1	STA2	MEANING
Station data	blank	Station 1 MWL On/Off
Station data	Station data	MWL is set/cancelled for all stations between Station 1 and Station 2.
blank	blank	MWL is set/cancelled for all stations in system.

**Note 3:** If the tenant number in the MWL control data is not used, default value of tenant number is one.

2. IMX FORMAT

(1) PBX → MC Message

(a) Summary of format

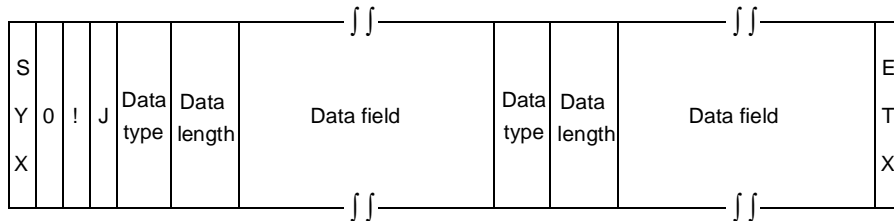

(b) Data type list (see [Table 4-4](#))

**Table 4-4 PBX → MC Data Type Explanation**

Data Type	Description	Data Length
00	Not used	—
01	Destination information (Source of information)	16 to 34
02	Loop number/Call type	04
03	Calling party information	16 to 34
04	Called party information	16 to 34
05	Extended calling party information	16 to 34
06	Calling number information	01 to 33
07 to 99	Not used	—

# MESSAGE FORMAT

## (c) Details of format

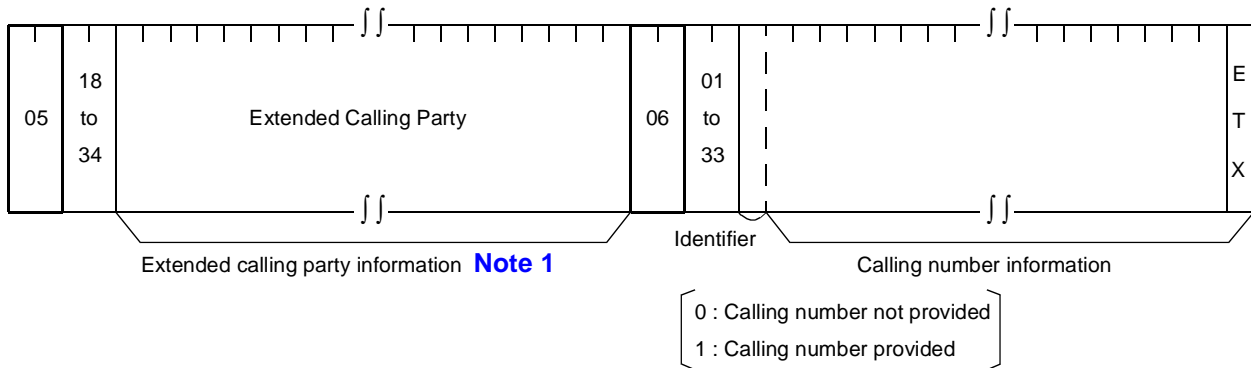
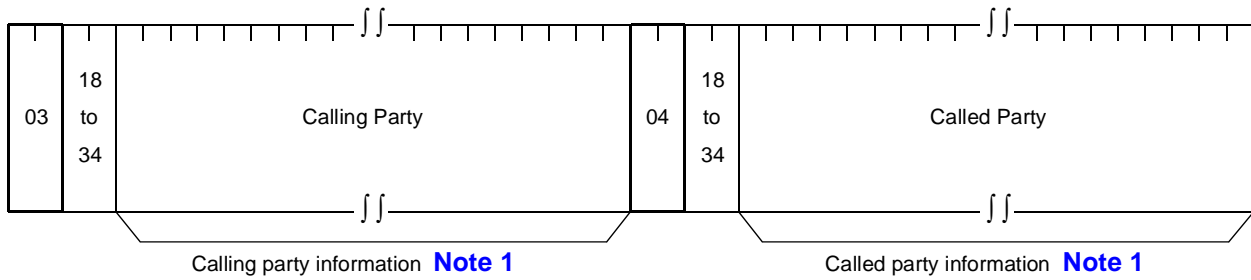
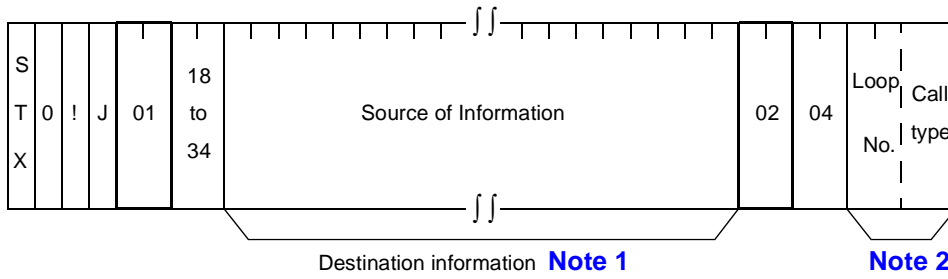

**Note 1:**

- *When the destination is a station*

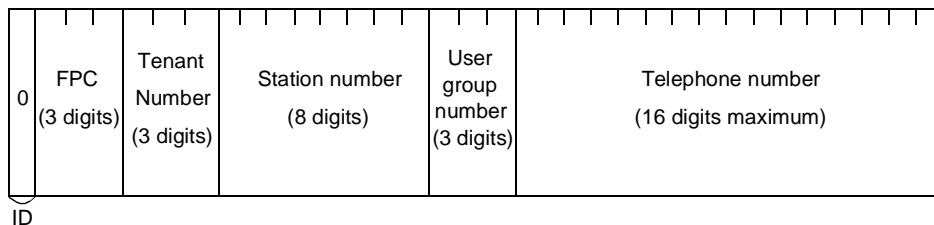

- *When the destination is the attendant*

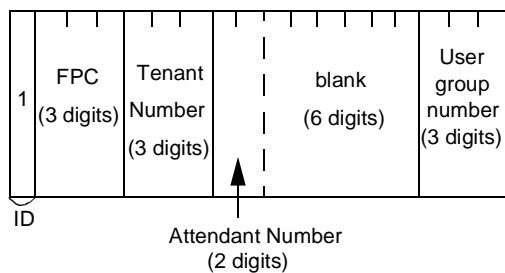

- *When the destination is a trunk*

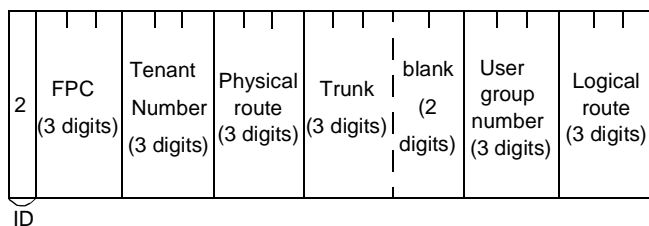

- *When the destination is a trunk (a calling number provided)*

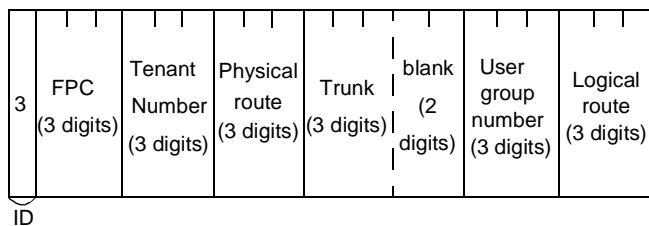

**Note 2:** *When the call type is 39 (wait request) or 66 (wait cancel), the information of data type (02) only is transmitted. [Table 4-5](#) and [Table 4-6](#) show the call types.*

**MESSAGE FORMAT**

**Table 4-5 Call Type Codes for Attendant Incoming Calls**

<b>CALL TYPE CODE</b>	<b>CALL TYPE</b>	<b>SOURCE</b>	<b>CALLING PARTY</b>	<b>CALLED PARTY</b>
10	Automatic Recall	ATT	STA/TRK	STA
11	Attendant Camp-On	ATT	TRK	STA
12	Call Forwarding-Don't Answer	ATT	STA/TRK	STA
13	Call Forwarding-Busy Line	ATT	STA/TRK	STA
14	Call Forwarding-All Calls	ATT	STA/TRK	STA
15	Operator Call	ATT	STA	--
16	House Phone	ATT	STA	--
17	Off-Hook Alarm	ATT	STA	--
20	Intercept Call to the Attendant	ATT	STA/TRK	--
21	Call Transfer-Attendant	ATT	STA/TRK	STA/TRK
22	Recall from a Series Call	ATT	TRK	STA
23	Series Call Re-entry	ATT	TRK	STA
24	Tandem Transferring/Hold Entry	ATT	TRK	TRK
26	Inter-Position Transfer	ATT	STA/TRK	ATT
27	CAS Incoming Call	ATT	TRK	--
30	LDN Call	ATT	TRK	--
36	Call Returned from Hold	ATT	STA/TRK	--
39	Stop Sending MW Control Data	--	--	--
66	Start Sending MW Control Data	--	--	--

**Table 4-6 Call Type Codes for UCD Incoming Calls**

<b>CALL TYPE CODE</b>	<b>CALL TYPE</b>	<b>SOURCE OF INFORMATION</b>	<b>CALLING PARTY</b>	<b>CALLED PARTY</b>
40	Call Forwarding-Don't Answer	STA	STA/TRK	STA
41	Call Forwarding-Busy Line	STA	STA/TRK	STA
42	Call Forwarding-All Calls	STA	STA/TRK	STA
43	STA/TRK	STA	STA/TRK	UCD-Pilot
44	STA/TRK via ATT	STA	STA/TRK	ATT
45	STA/TRK Transferred to UCD Pilot Station	STA	STA/TRK	STA



(2) MC → PBX Message

(a) Summary of format

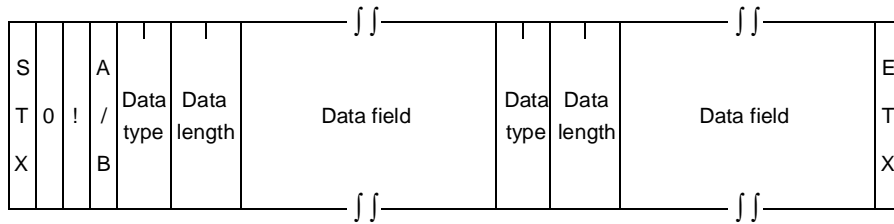

(b) Data type list (see [Table 4-7](#))

**Table 4-7 MC → PBX Data Type Explanation**

Data Type	Description	Data Length
00	Not used	—
01	ON/OFF	01
02	Station No. (STA1)	01 to 16
03	Station No. (STA2)	01 to 16
04	Tenant number/user group number	06
05 to 99	Not used	—

# MESSAGE FORMAT

(c) Details of format

- When Entry Index is A

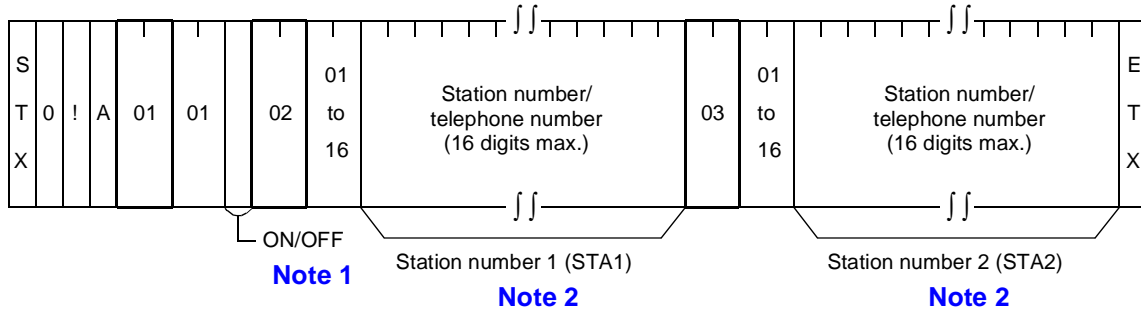

- When Entry Index is B

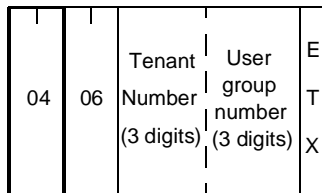
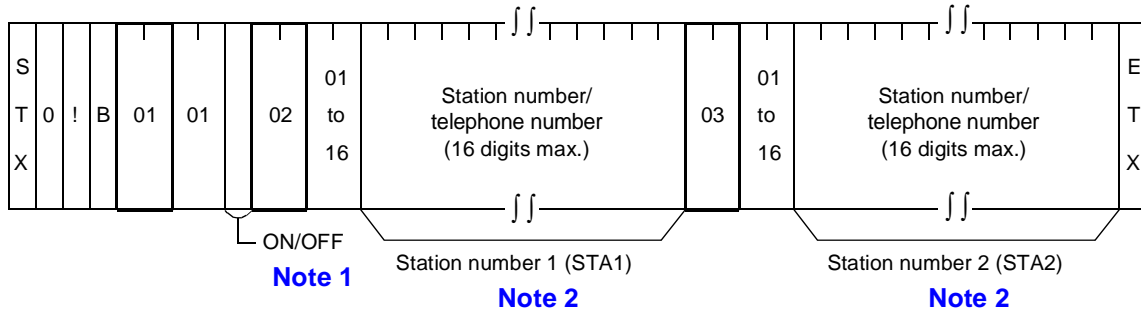

**Note 1:** *This information has the following meanings:*

- 0: All MWL Off
- 1: MWL On for MC
- 2: MWL On for VMS
- 5: MWL Off for MC
- 6: MWL Off for VMS

**Note 2:** *Table 4-8 explains the meaning of STA1 and STA2. The number of digits in the station number and the tenant number of these stations must be the same.*

**Table 4-8 MC → PBX Data Type Explanation**

STA1	STA2	MEANING
Station data	blank	Station 1 MWL On/Off
Station data	Station data	MWL is set/cancelled for all stations between Station 1 and Station 2.
blank	blank	MWL is set/cancelled for all stations in system.

**Note 3:** *If the tenant number in the MWL control data is not used, default value of tenant number is one.*

This page is for your notes.

## CHAPTER 5 SERVICE CONDITIONS

- (1) A maximum of 2 ports can be used for MCI. When 2 ports are used for MCI, note the following conditions.
  - When both ports are operating normally
    - Transmission: Messages are transmitted from the smaller-numbered port.
    - Reception: Messages are received from both ports.
  - When one of the ports is faulty
    - Transmission: Messages are transmitted from the port operating normally.
    - Reception: Messages are received from the port operating normally.
- (2) When the communication line between the MCI and the MC is closed, no display appears on the attendant's CRT.
- (3) If the data received from the MC contains text errors or parity errors, the PBX disregards all proceeding data until an STX message is transmitted to indicate another MWL request.
- (4) The following list provides service conditions for MCI used in a CCIS network. In the explanation, the following words are used:
  - MC node: The node to which the MC is connected.
  - Remote node: Nodes in a CCIS network except MC node.
  - (a) Only one MC can be connected in a CCIS network.
  - (b) When a call terminates from a remote node to the attendant or a UCD station in the MC node, the route number and trunk number used in the MC node displays as the Calling Party information.
  - (c) The MC node can control MWLs of all the stations in a maximum of 32 nodes.
- (5) The formats of messages to be transferred to and from the IOC can be changed by system data.
- (6) LAN interface and IOC interface cannot be concurrently used for MCI.
- (7) The following list provides service conditions for MCI for LAN:
  - (a) The socket interface shall be used for transfer of data to and from the MC connected to LAN.
  - (b) After the link is released, it shall always be the client that presents a link establishment request.
  - (c) The MCI messages transferred through the LAN interface is IMX format messages only.

This page is for your notes.

## CHAPTER 6 DATA ASSIGNMENT

STEP 1: ASYD - System Data 1, Index 28, Bits 0-4 Assign a Miscellaneous Timer Counter (MTC) used to calculate the message-sending Guard Timer for Message Center. If not required, assign data "0" to these bits.

System Data 1, Index 28, Bit 5	Is Message Waiting Lamp setting from the Message Center to be used? 0/1: No/Yes.
System Data 1, Index 29, Bits 1-7	Assign which I/O port will act as the Message Center Interface (a maximum of 2 ports).
System Data 1, Index 60, Bit 3	UCD Queuing. 0/1: Required/Not Required. Assign this data as "0" (Required).
System Data 1, Index 70, Bit 0	Called Number Display on the console for DID and TIE Line calls must be enabled. Assign Bit 0 as data "1" when System Data 2, Index 6, Bit 7 is also enabled.
System Data 1, Index 78, Bit 0	CALLING NUMBER DISPLAY - D <sup>term</sup> [C-24D] must be enabled. Assign Bit 0 as data "1".
System Data 1, Index 78, Bit 1	CALLING STATION STATUS DISPLAY - D <sup>term</sup> [C-22D] must be enabled. Assign Bit 1 as data "1".
System Data 1, Index 400, Bit 2	0/1: Calling number information is Not sent/sent to MCI.
System Data 2, Index 6, Bit 0	Is MCI service with UCD groups to be enabled? 0/1:No/Yes.
System Data 2, Index 7, Bit 1	Is MCI service for calls via the Attendant Console to be enabled? 0/1: No/Yes.

STEP 2: AIOC - Assign the function and attribute data of the IOC ports. Note that this data assignment is required for the MCI for IOC. Skip this step when using MCI for LAN.

STEP 3: ASYDL - System Data 1, Index 529, Bits 0 and 1 Parity check method for SMDR/MCI with LAN interface.

b1-b0 00 = No parity  
 01 = Odd parity  
 10 = Even parity

System Data 1, Index 641, Bit 1	Designate output numbers for MCI IMX format. 0/1: Station Number/Telephone Number. Assign this data to the node connected to MC.
System Data 1, Index 832	Assign the Fusion Point Code (FPC) of the node connected to MC. Assign this data to all nodes.
System Data 1, Index 833, Bit 0	Interface type for MCI. 0/1: IOC/LAN interface.
System Data 1, Index 833, Bit 1	Text format for MCI. 0/1: ICS/IMX format
System Data 1, Index 834, Bit 0	0/1: MC0 for LAN is Not mounted/Mounted.
System Data 1, Index 834, Bit 1	0/1: MC1 for LAN is Not mounted/Mounted.

## **DATA ASSIGNMENT**

STEP 4: AUCD - Whether UCD incoming call information is to be sent to a Message Center Interface or not can be specified on a UCD group basis using the following parameter:  
MCI: 0/1 (Not to be sent/To be sent to MCI)

STEP 5: ARPC - In the case of CCIS network, assign Remote Point Code (RPC) of each remote node.  
CSN (Centralized Service Number): 1 (Message Center)  
CNT (Remote Point Code Counter): (1-32)  
RPC (Remote Point Code): (1-16383)