

**Compact ICS 6.0  
System  
Coordinator  
Guide**

Norstar and Meridian are trademarks of Nortel Networks  
© Copyright Nortel Networks 2002



# Table of Contents

---

## Getting started with Norstar 13

- Using this guide 13
- Understanding programming 13
- Before you start 14
- What you'll need to do programming 15
- Using Buttons 15
- Using the buttons under the display 18
- The programming overlay 18**
- A map for working in programming 20
- Starting and ending a session 24
- Ending a session 25

---

## Frequently used programming operations 27

- Changing the time and date on the display 27
- Adding or changing a system speed dial 29
- Changing the name of a telephone 32
- Changing the name of a line 34
- Making changes to Call Forward No Answer 35
- Making changes to Call Forward on Busy 37
- Making Changes to Do Not Disturb on Busy 38
- What would you like to do next? 40

---

## Answering calls 41

- Answering incoming calls with Hunt Groups 41
- Answering an incoming call 41
  - Line buttons 42
  - What line indicators mean 42
  - Rings you may hear 42
- Sorting calls by distinctive ring patterns 43
- Answering calls at a prime telephone 43
- Using a central answering position (CAP) module 44
  - Customizing your CAP module 45
  - Monitoring telephones with the CAP module 45

- Release button 45
- Hearing aid compatibility 46
- Viewing information about a call on the display 46
  - Using Call Information for a particular call 46
  - Displaying Call Information before or after answering 47
  - Displaying Call Information for a call on hold 47
  - Making Call Display information appear automatically at a telephone 48
  - Changing what information is shown first about a call 48
- Picking up a call ringing at another telephone 49
  - Answering any ringing telephone using Directed Pickup 49
  - Answering any ringing telephone using Group Pickup 49
  - Changing a pickup group for a set 50
  - Trunk Answer 51
  - Answer buttons 52
- Creating a Conference Call 53
  - Disconnecting one party 53
  - Independently holding two calls 54
  - Putting a conference on hold 54
  - Splitting a conference 54
  - Removing yourself from a conference 55
- Listening to a call as a group 56
  - Canceling Group Listening 56
- Using Handsfree/Mute 56
  - Answering calls without lifting the handset 56
  - Making calls without lifting the handset 57
  - Muting Handsfree 57
  - Changing a regular call to handsfree 57
  - Changing a handsfree to a regular call 57
  - Using Handsfree 58
  - Changing Handsfree for a telephone 59
  - Changing Handsfree Answerback for a telephone 60
- Turning Privacy on or off for a call 60
  - Creating a conference by releasing privacy 61
  - Making a call private 61
- Checking call length using Call Duration Timer 61
- Disconnecting by accident 62

---

## **Making calls 63**

- Choosing a line using a line button 65

- 
- Line pools 65
    - Using a line pool to make a call 66
    - Programming a memory button with a line pool feature code 66
    - Making calls from an ISDN terminal 66
  - Changing how you dial your calls 67
    - Using Standard Dial 67
    - Using Automatic Dial 67
    - Using Pre-dial 67
  - When the internal number you have called is busy 68
    - Priority Call 68
    - Making a priority call 68
    - Giving a telephone the ability to make priority calls 69
    - Using Ring Again 70
    - Turning on Ring Again 70
    - Canceling Ring Again 70
- 

## **Auto Attendant 71**

- System Answer 71
- Custom Call Routing (CCR) 72
  - CCR groups 72
  - Direct extension dialing 73
  - Customizing System Answer and CCR 73
  - Turning System Answer on or off 74
  - Turning CCR on or off 75
  - Choosing the attendant telephone 75
  - Changing the language for System Answer and CCR 76
  - Setting ring delay before System Answer takes a call 76
  - Setting the ring delay before CCR greeting answers 77
  - Adding/removing telephones from CCR groups 77
  - Using the pre-recorded greetings 78
  - Using customized greetings for System Answer and CCR 79
  - Time available for customized greetings 80
  - Recording customized greetings for System Answer and CCR greetings 81
  - Programming or changing CCR destinations 83
  - Testing your custom System Answer and CCR 84
- Storing a number on a memory button for Autodial 84
  - Adding an autodial button 84
  - Choosing a line for Autodial 85

- Using intercom as the line for Autodial 85
  - Using Last Number Redial 86
  - Preventing a telephone from using Last Number Redial 87
  - Using Speed Dial 88
    - Changing and adding System Speed Dials 88
    - Adding or changing User Speed Dial 88
  - Making a speed dial call 90
  - Using Saved Number Redial 90
    - Saving a number 90
    - Dialing a saved number 90
  - Preventing a telephone from using Saved Number Redial 91
- 

## **Handling many calls at once 93**

- Using Hold 93
    - Retrieving a held call 93
    - Holding automatically 93
    - Listening on hold 94
    - Holding a call exclusively 94
  - Using Call Queuing 95
  - Using system-wide call appearance (SWCA) 95
    - Incoming calls 96
    - Outgoing calls 97
    - No free call keys 98
- 

## **Transferring calls 99**

- Using the transfer feature 99
    - Transferring a call 99
    - Transferring external calls 100
    - Canceling a transfer 100
  - Using Camp-on 102
  - Parking a call 103
    - Retrieving a parked call 103
    - Using Call Park 103
  - Using Callback 105
- 

## **Forwarding your calls 107**

- Forwarding your calls to another Norstar telephone 107
  - Canceling Call Forward 107
  - Using Call Forward at your telephone 107

---

- Overriding Call Forward 108
- Changing the automatic Call Forward settings for a telephone 108
- Changing Forward no answer 108
- Changing the delay before a call is forwarded 109
- Forward on busy 109
- DND on Busy 110
- Call Forward and Voice Mail 111
- Line Redirection 111
  - Turning on Line Redirection 112
  - Canceling Line Redirection 112
  - Allowing a telephone to redirect calls 113
  - Turning the redirect ring for a telephone on or off 113
  - How Line Redirection is different from Call Forward 115
  - Using Line Redirection 115

---

## **Communicating in the office 117**

- Paging 117
  - Making a page announcement 117
  - Activating and deactivating the ability to page 118
  - Creating page zones 118
  - Using Page with external paging equipment 120
- Sending messages using the display 120
  - Sending a message 120
  - Canceling a message you have sent 121
  - Viewing your messages 121
  - Replying to a message 121
  - Removing items from your message list 122
  - Viewing messages you have sent 122
- Using Voice Call 124
  - Making a Voice Call 124
  - Answering a Voice Call without touching your telephone 124
  - Preventing Voice Calls to your telephone using Voice Call Deny 125

---

## **Tracking your incoming calls 127**

- Using Call Log 127
- Call Log options 128
- Logging a call manually 128
- Deleting old log items 129
- Viewing your Call Log 129

- Viewing a Call Log item 129
  - Erasing log items 129
  - Making a call using Call Log 130
  - Creating a password to your Call Log 130
  - Changing your Call Log password 131
  - Deleting an assigned password 131
  - Programming a telephone to log calls automatically 131
  - Using Voice mail 133
- 

## **Customizing your telephone 135**

- Finding out what a button does using Button Inquiry 135
  - Making the display darker or lighter using Contrast adjustment 136
  - Changing the language on the display 136
    - English 136
    - French 136
    - Spanish 136
  - Programming a feature code onto a memory button 137
    - Programming feature buttons 137
    - Erasing a feature button 137
  - Labeling your set 139
    - Applying button labelling 139
    - Business Series Terminals 139
    - Identifying the telephones 140
    - T7316 Business Series Terminal button defaults 141
    - M7310 telephone button defaults 143
    - Default button assignments 144
  - Moving line buttons 147
  - Changing the type of ring 148
  - Adjusting the Ring volume 148
  - Hiding the message or calls indication 148
    - Restoring the messages and calls indication 148
- 

## **User Preferences 149**

- Using User Preferences 149
- Changing button programming 150
- Changing a User Speed Dial 151
- Changing Call Log options 152
- Changing how calls are dialed 152
- Changing the language used on the display 152



- 
- Making the display lighter or darker 152
  - Changing the ring on the telephone 152
  - Changing the voice path on the telephone 152
- 

## **Programming Hunt Groups 155**

- Adding or removing members from a group 156
    - Moving members of a group 157
  - Assigning or unassigning lines to a group 158
  - Assigning a distinctive ring pattern to a Hunt Group 159
  - Setting the distribution mode 159
  - Setting the hunt delay 161
  - Programming busy line setting 161
  - Programming the queue time-out 162
  - Programming the overflow set 163
  - Setting the name 164
- 

## **Using the Hospitality features 165**

- Hospitality passwords 165
    - Desk pswd 165
    - Cond pswd 166
  - Room/desk information 166
    - Programming room information 167
    - Using the room/set programming 169
  - Programming the alarm feature 170
    - Using the Administration set to control alarms 171
    - Using the alarm 172
    - Canceling an alarm 173
    - Turning off an alarm 173
- 

## **Telephone features 175**

- Installing Business Series Terminals 175
    - Mounting a Business Series Terminal on the wall 176
  - Installing Norstar telephones 178
  - Naming a telephone or a line 180
  - Moving telephones 180
  - Stopping calls from ringing at your telephone:
    - Do Not Disturb (DND) 180
      - Stopping calls 180
      - Refusing to answer a call 181
-

- Canceling Do Not Disturb 181
- Using Do Not Disturb 181
- Using Background Music 182
  - Turning Background Music off 182
- Using the device attached to the internal analog terminal adapter 182
- Using a data communication device with the I-ATA 188
  - Turning off tones that can interfere with data transmissions 188
  - Programming answering machines or modems to answer calls automatically 188
  - Using the I-ATA with modems and fax machines 188
  - Troubleshooting for the device attached to the I-ATA 189

---

## **ISDN 191**

- ISDN BRI 191
  - Line access from an ISDN terminal 192
- ISDN BRI features 192
  - Network Name Display for BRI 192
  - Name and number blocking for BRI 193
- Service provider features 193
  - Call Forward 193
  - Canceling Call Forward 193
  - Calling the number your calls are forwarded to 194
  - Automatic Call Back 194
  - Automatic Recall 194
  - MCID 194
  - Network Call Diversion 194
- ISDN BRI terminals 195
- ISDN applications 195
  - Videoconferencing and video telephony 195
  - Desktop conferencing 195
  - File transfer 195
  - Telecommuting 196
  - Group 4 fax 196
  - Remote LAN access 196
  - Leased line backup 196
  - LAN to LAN bridging 196
  - Internet and database access 196

---

## Using System features 197

- Using alternate or scheduled services 197
  - Preventing certain calls from being made 197
  - Making additional telephones ring 197
  - Changing the lines used by outgoing calls 197
  - Turning Services on and off 198
  - An example of how to turn on a Service manually 199
  - Turning Services on and off using feature codes 199
  - Viewing the active Services from a two-line display telephone 200
  - Viewing the active Services from a one-line display telephone 201
- Using passwords 202
  - Using a Basic password 203
  - Changing passwords 203
  - Clearing a Call Log password 204
  - Hospitality password 204
- Using special telephones 205
  - Direct-dial 205
  - Changing the direct-dial telephone assignments 206
  - Hotline 207
  - Bypassing a Hotline 207
  - Making a telephone a hotline telephone 207
  - Control telephone 208
- Using Set lock 208
  - Changing Set Lock programming for a telephone 209
- Using an auxiliary ringer 209
  - Turning the auxiliary ringer for a telephone on or off 209
  - Using Host System dialing signals 210
  - Link 210
    - Preventing a telephone from using Link 210
  - Pause 211
  - Long Tones 211
  - Programmed Release 212
  - Run/Stop 212
  - Wait for Dial Tone 213
  - Using pulse dialing for a call 213
  - Using your Norstar system from an external location 213
  - Controlling access to your Norstar system 214
  - Direct inward system access (DISA) 214

- Class of Service (COS) 214
  - Maintaining security 215
  - Accessing Norstar remotely over the public network 215
  - Tones 216
  - Using Class of Service (COS) passwords 216
- 

## **General System features 219**

- Disconnect supervision 219
  - Hunt Groups 219
  - Internal numbers 219
  - Line assignment 220
  - Target line 220
  - Line pools 221
  - Overflow call routing 221
    - M7100 and T7100 telephones 221
    - Memory buttons 222
    - One-line display 222
    - Prime line 223
    - Private lines 223
    - Volume bar 223
- 

## **Troubleshooting 225**

- Using the alarm telephone 225
  - Reporting and recording alarm codes 225
  - Testing the telephone 225
    - Testing the telephone display 226
    - Testing the telephone buttons 226
    - Testing the speaker in the telephone handset 226
    - Testing the telephone headset 227
    - Testing the telephone speaker 227
    - Testing the power supply to a telephone 227
- 

## **Common feature displays 229**

---

## **Index 233**

- Backup programming overlays 251

---

# Getting started with Norstar

Your Norstar digital key system has many powerful features that can be customized to keep up with changes in your workplace.

---

## Using this guide

The person who is responsible for adding or moving telephones or making changes to the system is called the system coordinator. This guide is designed to give the system coordinator all the information he or she needs to carry out these kinds of jobs.

The first section contains step-by-step instructions on changing the time and date, deciding how many rings it takes before a call is forwarded and other day-to-day programming. Once you understand these basic steps, you can move on to the many other features described in the second section of the guide, and refer to the first section only from time to time.

You can look at the contents page for an overview of the features that are available, or check the index for specific features or messages displayed on your telephone.

---

## Understanding programming

When your system is installed, your installer or customer service representative programs it to work with your telephone lines, with your private network, if you have one, and with optional equipment. They customize the system for your office. All programming is recorded in the *Norstar Programming Record*.

You may want to further customize your system. For example, you can change how some features work, or adapt the system to changes in your office. Programming allows you to change settings that probably need to be updated regularly because of staff turnover or new business contacts. You can also assign features and program buttons on individual telephones.

There are four ways to customize and maintain your Norstar system:

- Initial programming is done for you by your installer or customer service representative. It deals mostly with how the system interacts with lines, telephones, and other equipment.
- Your programming as a system coordinator changes how features work for the system, as needed. It requires a system coordinator password.
- A basic programming password is available to allow individuals other than the system coordinator to make changes without giving access to sensitive programming capabilities.
- Personal programming is available to anyone through the Feature button on their Norstar telephone. It allows individuals to change how their telephone works to suit themselves.



## Before you start

Before you begin programming, plan what changes you want to make. Record the changes in the *Norstar Programming Record* so that you have the information at hand. For example, if you are going to program system speed dial numbers, fill out the page in the *Norstar Programming Record* so that you have all the numbers and codes handy once you start programming.

---

## What you'll need to do programming

Programming is done using a telephone that can show two lines of information on its display. Examples of telephones with two-line displays are shown on page 15.

You need a programming overlay to show which buttons to press when you are doing programming. See “The programming overlay” on page 18.

When you use a telephone for programming, it is taken out of service. This means it is unable to receive or make calls, and the call forward features do not work. Do not use the main reception telephone for programming because you may lose incoming calls.

---

## Using Buttons

The two-line telephone you use for everyday calling is used for changes and maintenance. Examples of telephones with two-line displays are shown in the illustration below.

### **Business Series Terminal used for programming and maintenance**

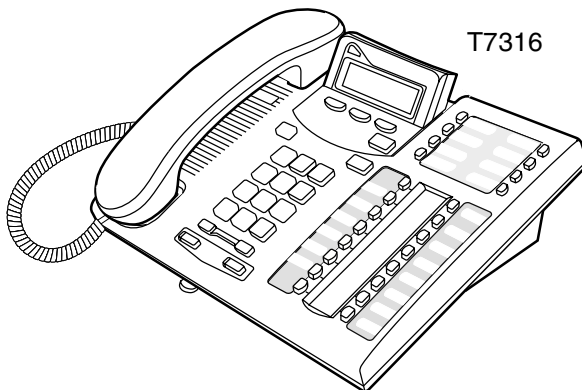

## Norstar two-line display telephones

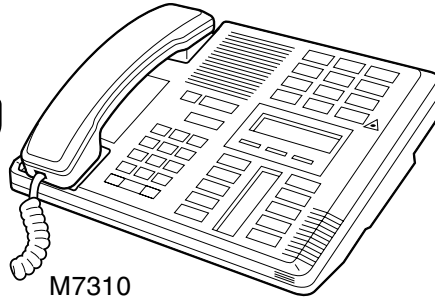
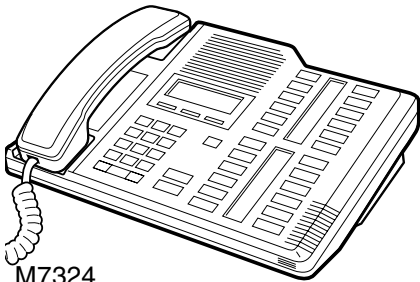

The next illustration numbers the buttons that are used for both day-to-day communication and programming on the T7316 telephone.

### Business Series Terminal buttons.

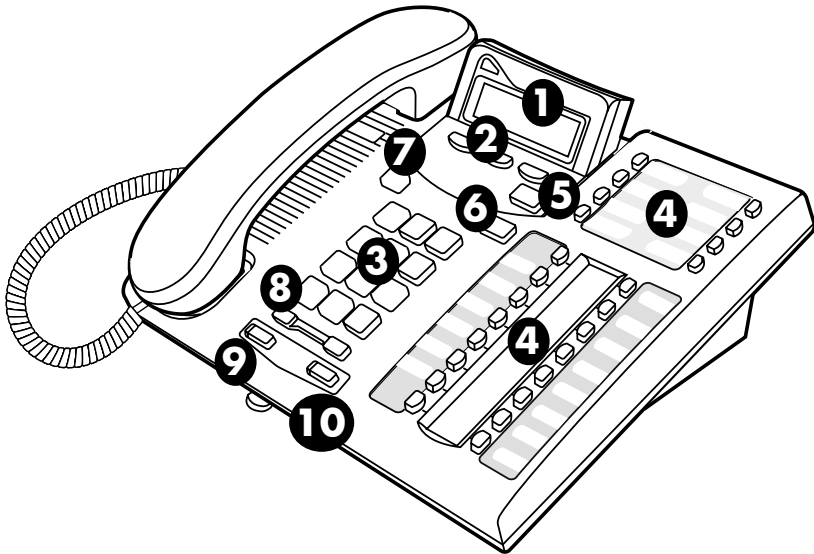







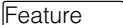

❶ Display	Shows instructions for everyday calling as well as for programming.
❷ Display buttons	Have a variety of uses. The current use is shown on the display above each button.
❸ Dialpad	Used for dialing numbers when you are making calls. For programming, the dialpad is also used for entering numbers and letters
❹ Memory buttons	Dial a number or feature code stored on the button.
❺ Feature button	Allows you to enter a feature code while using or programming the telephone.
❻ Hold button	Puts an active call on hold.
❼ Release button	Hangs up an active call or ends programming.
❽ Volume rocker switch	Turns the volume you hear through the handset up or down. During programming this switch is used to adjust settings, such as for the display contrast.
❾ Mute	Mutes the transmitter in the handset.
❿ Handsfree	Allows you to speak to and hear a call without using the handset or headphones.

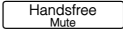
This guide shows the icons for Business Series Terminal buttons. Your set may have different labels, or the buttons in slightly different locations.

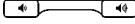
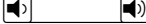
Refer to the table below for comparable Norstar icons,

Business Series Terminals T7100, T7208, T7316, T7406	Button description	Norstar sets M7100, M7208, M7310, M7324
	<b>Feature</b>	
T7208 and T7316: Handsfree:  Mute: 	<b>Handsfree/Mute</b>	
	<b>Hold</b>	
	<b>Volume Control</b>	
	<b>Release</b>	

## Using the buttons under the display

The three display buttons are used both for telephone features and programming, but what each button does depends on what the display shows. Some display instructions that you may see when making changes on the system are OK, CHANGE or COPY. In this guide, display button instructions are underlined.

### Display buttons

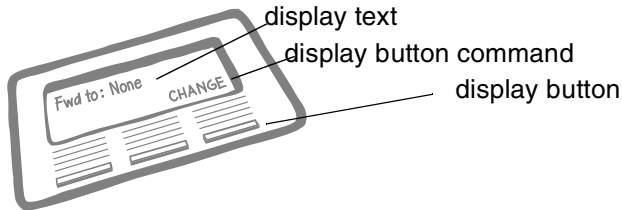

## The programming overlay

When you begin programming, a group of buttons on the telephone become the buttons for moving through programming headings and settings. The programming overlay is a paper cutout (found at the front of this guide) that shows the directions the four buttons take you when programming.

### Placing the programming overlay on a Business Series Terminal

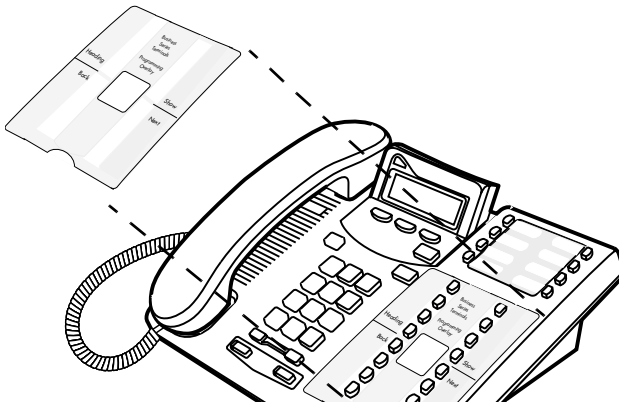

**T7316 overlay (smaller than actual size)**

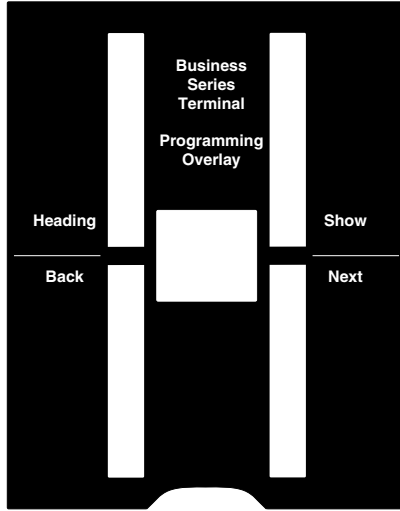

**M-series terminals overlay**

Displays the heading for the current level

Displays the first setting within a menu level



Moves back one item on the current level

Moves display one item forward on the current menu level

## Placing the programming overlay on M-series terminals

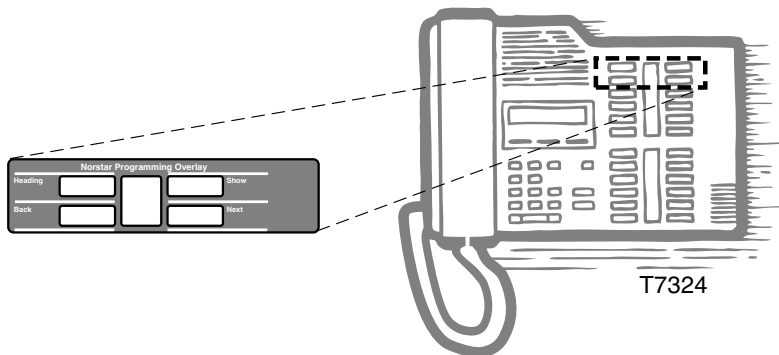
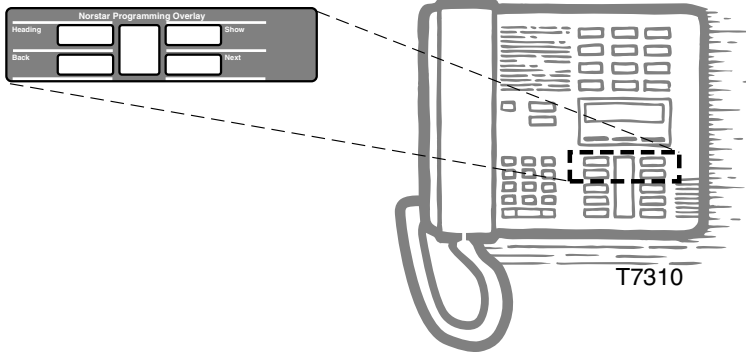

Programming buttons are active or inactive at different stages of programming. A button is active (meaning you can use that option), when the indicator next to it is lit (◀ or ▶).

## A map for working in programming

The programming maps on page 22, page 23, and page 24 show the headings you see when you move through the display menu after pressing  \* \* C O N F I G and entering the password (the default password is A D M I N or 2 3 6 4 6 ). The maps show you the menu choices.

A Basic password can be used with a limited number of feature codes, including \* \* T I M E and the codes for turning call

services on and off. For more information, see “Using passwords” on page 202.

**Terminals&Sets**

Customize the many features used by telephones. You can change where a call is forwarded, give a telephone a name, or allow certain features to be used at a telephone.

**Lines**

Program names for each line.

**Services**

Turn services on or off. These are Ringing service, (often called night service) that allows additional telephones to ring, Restriction service that blocks certain kinds of calls and Routing Service that decides what lines a call uses.

**Sys speed dial**

Program up to 255 different telephone numbers so that people in your office can dial them with a three-digit code.

**Passwords**

Change the password you use for programming, or erase a Call log password.

**Time&Date**

Change the time, date, or both.

**System prgrming**

Change the settings for the System Answer that handles the overflow when the attendant set is busy, and Custom Call Routing (CCR) that gives a caller a choice of where to direct their call.

Programming map (page 1)

Terminals & Sets	Show set Enter digits or press LIST.	Capabilities	Fwd no answer	Fwd to Fwd delay
			Fwd on busy	Fwd to Fwd delay
			DND on busy	Fwd to
			Handsfree	
			HF answer back	
			Pickup grp	
			Page zone	
			Paging	
			D-Dial	
			Priority call	
			Hotline	Intrn # Extrnl# .... Use prime line
			Aux. ringer	
			Allow redirect	
			Redirect ring	
			SM Supervisor	
		Name	Model	# of buttons B01 ... BXX CLRTEL#FEATR
		User preferences	Button progrming	# of speed dialers Spd # XX
			User speed dial	No one answered Unanswered by me Log all calls No autologging
			Call log opt'ns	Standard dial Pre-dial Automatic dial
			Dialing opt'ns	
			Language	
			Display cntrst	
			Ring type	
			Voice path	Dfft: Handsfree Headset
		Restrictions	Set restrictions	Set lock (Partial, Full, None)
				Allow last no
				Allow saved no
				Allow link
		Telco features	1st Display	
			Called ID	

## Programming map (page 2)

Lines	Show lines ___ Enter digits or press LIST	Name	
Services	Ringng service	Sched: Night Evening Lunch Sched 4 Sched 5 Sched 6	Off, Manual, Auto
	Restrn services	Sched: Night Evening Lunch Sched 4 Sched 5 Sched 6	Off, Manual, Auto
	Routing service	Sched: Night Evening Lunch Sched 4 Sched 5 Sched 6	Off, Manual, Auto
Sys speed dial	Speed dial # Enter digits or press LIST	add/change tel # Use prime line Display digits Name	
Passwords	Call Log pswds	Show set	Log pswd
	Progrming pswds	Sys admin: 23646 Basic: 22742	
	Hospitality	Desk pswd: 4677 Cond pswd:None	
Time&Date	Hour		
	Minutes		
	Year		
	Month		
	Day		
System Prgming	Hunt Group	Show Group	Member DNs
			Line assignment
			Mode
			Hunt Delay
			If Busy
			Q Timeout
			Overflow
			Name
		Show line ___ Unassigned/ Assigned	
		Broadcast Sequential Rotary	
		BusyTone/Queue	

**Programming map (page 3)**

System Prgmng (continued)	Auto Attendant	Attd set	
		Language	First/Second
		System Answer	After__rings
		CCR	After__rings CCR groups
			Show group: Enter digits or press List
	BusName		
	Hospitality	Room/desk info	Show set
			Room #
		Service time	Adm pwd req'd
		Alarm	Hour
			Minutes
			Attn attempts
			Retry intrvl
			Attn duration
			Time format
			12 hr/24 hr
			Expired alarms
			Notify set
			Use tone

## Starting and ending a session

As system coordinator, the first steps in making any change to the Norstar system are always the same.

Jan 1 12:00PM

Press .

Feature:

Press        . It's the same as pressing        .

Password:

RETRY

Press          ). Press **RETRY** to re-enter the password if it is entered wrong.

Terminals&Sets

The display shows the first of the seven headings available for administration programming.

is the password, unless the password has been changed. Check the Norstar Programming Record for the most recent password.



## Ending a session

Display digits:Y  
CHANGE

Press  to end the session.

End of session

After a few seconds, the time and date reappears on the display.

The system goes ahead with any changes you make to programming as soon as you move away from a setting, either by using the navigation buttons or .

You can see if the changes you have made to telephone programming have taken effect by pressing the **UPDATE** display key. The display shows you how many telephones have not been updated.

Press **DNE** to see the specific extensions where programming changes have not taken effect yet. Items disappear from the list as they are updated.

Record any changes you make in the *Norstar Programming Record*. If there is a problem with the system, the installer needs to see a history of the changes you have made. Remember to inform people in your office of any changes you have made that affect them. For example, you may change system speed dial codes or change the number of rings before an unanswered telephone is forwarded.



# Frequently used programming operations

The following sections highlight the most frequently used programming operations. To consult these or other programming operations, see either the Table of Contents or the Index.

## Changing the time and date on the display

Jan 1 12:00pm

Press .

Feature:

Press \* \* 8 4 6 3 (which is the same as \* \* T I M E).

Password:

RETRY

Press 2 2 7 4 2 (B A S I C) or 2 3 6 4 6 (A D M I N)

The passwords can be changed. See “Using passwords” on page 202 for more information.

## Entering letters and numbers using the dialpad

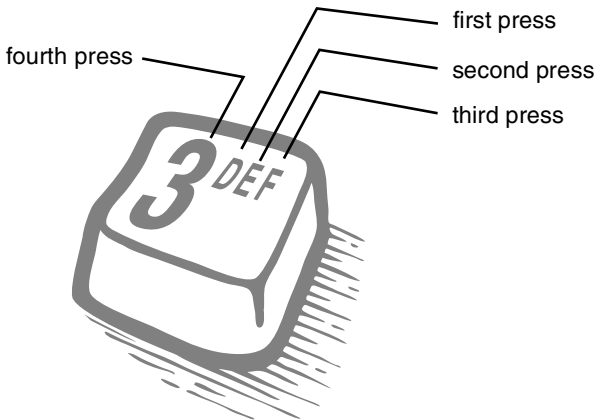

In this example, you are changing the time to 1:30 p.m.

Hour:01  
NEXT CHANGE

Press CHANGE.

Hour:\_\_\_  
CANCL

Press the dialpad buttons to enter the hour. Use two digits for all hours. The clock on the display shows either one or two digits.

AM  
OK CHANGE

The display prompts you to choose a.m. or p.m. Press CHANGE and OK to select p.m.

Hour:01  
NEXT CHANGE

Press NEXT.

Minutes:00  
NEXT CHANGE

Press CHANGE.

Minutes:\_\_\_  
CANCL

Press the dialpad buttons to enter the minutes.

If you are only changing the time and not the date, press  to end your session.

In this example, you are changing the date to July 15, 2002.

Minutes:30  
NEXT CHANGE

Press NEXT.

Year:00  
NEXT CHANGE

Press CHANGE.

Year:\_\_\_  
CANCL

Press the dialpad buttons to enter the year.

Year:02  
NEXT CHANGE

Press NEXT.

Month:01  
NEXT CHANGE

Press CHANGE.

Month:\_\_\_  
CANCL

Press the dialpad buttons to enter the month.

Use numbers for the months: 01 is January; 12 is December.

Month:07  
 NEXT CHANGE

Press NEXT.

Day:01  
 NEXT CHANGE

Press CHANGE.

Day:\_\_\_\_  
 CANCL

Press the dialpad buttons to enter the day.

Day:15  
 CANCL

Press  to end your session.

End of session

The clock controls the schedules used for services such as ringing and routing services.

After a power failure, the clock is behind by the length of time power was lost. For example, if the power is out for two minutes, the clock is two minutes behind.

## Adding or changing a system speed dial

You program a speed dial on your Norstar so that anyone in your office can dial a frequently used number using a three-digit code (001-255).









To change a speed dial that already exists, follow the same steps. The new programming overwrites the previous number and settings.

### Begin the programming session

Jan 1 12:00PM

Press .

Feature:

Press        .

Password:   
 RETRY

Press     .

### Choose a speed dial code

Terminals&Sets▶

Press  three times.

Sys Speed Dial▶

Press .

Speed dial #:\_  
  
 LIST

Press   .

You can pick any system speed dial code between 001 and 255.

Speed dial #:001▶  
  
 FIND

Press .

### Add or change the telephone number

001:No number  
  
 CHANGE

Press CHANGE.

001:\_  
  
 CANCEL OK

Use the dialpad to program the telephone number that you want to add. The telephone number can be up to 24 digits long.

001:nnnnnnnn\_  
  
 CANCEL BKSP OK

Your display shows the telephone number, and not n's as shown here. Press OK.

### Select a line for the speed dial code

001:nnnnnnnn  
  
 CLR CHANGE

Press .

Use prime line  
  
 CHANGE

Press CHANGE to see your options: Use prime line, a specific line (for example Use line:01), a line pool (for example Pool code:71), or Use routing tbl.

Stop pressing CHANGE when the display shows the prime line again.

Use prime line  
  
 CHANGE

In this example, the system selects the prime line automatically (the most common choice), to dial speed dial code 001.

If you assign a specific line to a system speed dial number, only telephones with an appearance of that line can use the speed dial number.

### Choose what shows up on the display

Use Prime line  
CHANGE

Press .

Display digits:Y  
CHANGE

Your choices are Yes and No. Yes means the display shows the telephone number. Press CHANGE.

Display digits:N  
CHANGE

No means the display shows a name for the code.

### Program a name for a speed dial

The system has a standard name to display, so it is not necessary for you to program one. However, if you have chosen not to display the telephone number, you may want a specific name.

**Alpha tagging feature:** This feature offers name display for calls coming in over lines that offer number-only display services.

If you specify a name for a speed dial, and that person calls in on an external line, the speed dial name you specify acts as the name display for the call if the call number matches the number in the speed dial list (CLID Match). If the telephone has also been configured to display Caller ID (Caller ID set) and the name of a caller first (1st display), then the name you program for the speed dial code is the name that will display.

For example: If you create a speed dial for the courier company you use, and assign the name Courier with the following process, when that company calls you, Courier would appear on the display for the call.

Note: The Alpha tagging feature is only active when the system CLID service provides number-only display services.

Display digits:N  
CHANGE

Press .

Name:Sys Spd Di...  
CHANGE

Press .

...al 001 ...  
CHANGE

This is the name the display shows if you do not change it. Press CHANGE.

Name: \_ \_ \_ \_ \_  
 -->

Decide the name you want to give to the speed dial code.

Press the numeric dialpad button that has the first letter of the name until the display shows the letter you want.

Name: S \_ \_ \_ \_  
 BKSP -->

Press -->.

Name: S \_  
 <-- BKSP -->

Use the dialpad and --> until you have the entire name.

The name can be up to 16 characters long, including spaces.  
 Press # on the numeric dialpad to add spaces.

Name: SAVINGS BANK  
 <-- BKSP -->

Press .

Name: SAVINGS BA...  
 CLR CHANGE

Press  to end your session.

Or you can press , then  to program another speed dial number.

End of session

## Changing the name of a telephone

### Begin the programming session

Jan 1 12:00pm

Press .

Feature:

Press \* \* 2 6 6 3 4 4 .

Password:  
 RETRY

Press 2 3 6 4 6 .



## Change the name of a telephone

Terminals&Sets▶ Press .

Show set:\_\_\_\_ Enter the internal number (DN) of the telephone or  
LIST voice mail extension. In this example, the DN is 21.

If the set has already been given a name, it appears after DN: on the display.

21:21▶ Press  then .

FIND

Name:21 This is the name the display shows if you do not  
CHANGE change it. Press CHANGE.

Decide what name you want to give to the telephone number.

Name:\_\_\_\_ Press the telephone numeric dialpad button that  
--> has the first letter of the name until the display shows the letter you want.

Name:P Press -->.

BKSP -->

Name:P\_ Use the dialpad and --> until you have the entire  
<-- BKSP --> name.

Name:Pat P Press  to use the name you have  
<-- BKSP --> entered.

The name can be up to seven characters long, including spaces.

Name:Pat P Press  to end your session.

CLR CHANGE

You can press  once to continue programming this telephone, or press  twice to return to the Terminals and Sets heading.

End of session

## Changing the name of a line

### Begin the programming session

Jan 1 12:00pm

Press .

Feature:

Press        .

Password:

Press     .

RETRY

### Change the name of a line

Terminals&Sets▶

Press .

Lines▶

Press .

Show line:\_\_\_

Enter the three-digit number of the line you want to name. In this example, the line is 002.

LIST

This is the name the display shows if you do not change it.

Line002:Line002▶

Press .

FIND

Name:Line002

Press CHANGE.

CHANGE

Decide what name you want to give to the line.

Name:\_\_\_

Press the telephone numeric dialpad button that has the first letter of the name, until the display shows the letter you want.

-->

Name:L

Press -->.

BKSP

-->

Name:L\_\_

Use the dialpad and --> until you have the entire name.

<--

BKSP

-->

The name can be up to seven characters long, including spaces.

```
Name:LOCAL
<-- BKSP -->
```

Press  to use the name you have entered.

```
Name:LOCAL
CLR CHANGE
```

Press  to end your session.

You can press  once to continue programming this line, or press  twice to return to the Lines heading.

```
End of session
```

## Making changes to Call Forward No Answer

### Begin the programming session

```
Jan 1 12:00PM
```

Press .

```
Feature:
```

Press .

```
Password:
```

Press .

```
RETRY
```

### Change where a call goes when there is no answer

```
Terminals&Sets▶
```

Press .

```
Show set: _
```

```
LIST
```

Enter the internal number (DN) of the telephone or voice mail extension. In this example, the DN is 25.

If the set has been given a name, it appears on the display.

```
25:25
```

```
FIND
```

Press .

```
Capabilities▶
```

Press .

```
Fwd no answer▶
```

Press .

```
Fwd to:None
CHANGE
```

Press **CHANGE** and enter the internal number where you want the calls to be sent. In this example, the DN is 21.

```
Fwd to:21
CLR CHANGE
```

You can press **CLR** to change the destination back to **None**.

## Change the number of times the telephone rings before it is forwarded

```
Fwd to:21
CLR CHANGE
```

Press .

```
Forward delay:4
CHANGE
```

Use the **CHANGE** button to choose the number of times the telephone rings before it is forwarded.

Your choices are 2, 3, 4, 6 and 10 rings.

```
Forward delay:3
CHANGE
```

Press  to end your session.

You can press  to continue programming capabilities for this telephone, or press  four times to return to the Terminals and Sets heading.

```
End of session
```



**Tip** - If the Norstar set is a member of a Hunt Group, the Call Forward no answer feature is overridden and the Hunt Group call continues to ring until the hunt time has expired. For more information about Hunt Groups see “Programming Hunt Groups” on page 155.

## Making changes to Call Forward on Busy

### Begin the programming session

Jan 1 12:00PM

Press .

Feature:

Press        .

Password:

Press     .

RETRY

### Change where a call goes when a telephone is busy

Terminals&Sets▶

Press .

Show set:\_\_\_

LIST

Enter the internal number (intercom number) of the telephone extension. In this example, the DN is 25.

If the set has been given a name, it appears on the display.

25:25

FIND

Press .

Capabilities▶

Press .

Fwd no answer▶

Press .

Fwd on busy...

Press .

Fwd to:None

CHANGE

Press CHANGE and enter the internal number where you want the calls to be sent. In this example, the DN is 21.

You can press CLR to change the destination back to None.

Fwd to:21

CLR

CHANGE

Press  to end your session.

You can press  to continue programming capabilities for this telephone, or press  three times to return to the Terminals and Sets heading.

End of session



**Tip** - *If the Norstar set is a member of a Hunt Group, the Call Forward on busy feature is overridden and the Hunt Group call continues to ring until the hunt time has expired. For more information about Hunt Groups see "Programming Hunt Groups" on page 155.*

## Making Changes to Do Not Disturb on Busy

When you are on a call and a second call comes in, your telephone rings softly to alert you to the second call. You can turn this feature on or off for each telephone.

### Begin the programming session

Jan 1 12:00PM

Press .

Feature:

Press        .

Password:

Press     .

RETRY

### Change Do Not Disturb on Busy

Terminals&Sets▶

Press .

Show set: \_

LIST

Enter the internal number (intercom number) of the telephone extension. In this example, the DN is 25.

If the set has been given a name, it appears on the display.

25:25 Press  .  
 FIND

Capabilities▶ Press  .

Fwd no answer▶ Press  twice.

DND on Busy:IN Press CHANGE to turn the feature on.  
 CHANGE

DND on Busy:Y A second press turns it off again. Press  to end  
 CHANGE your session.

You can press  to continue programming capabilities for this telephone, or press  three times to return to the Terminals and Sets heading.

End of session



**Tip** - *If the Norstar set is a member of a Hunt Group and the set activates this feature, the set does not receive notification of incoming Hunt Group calls while on a call. The DND on busy feature overrides the Hunt Group. For more information about Hunt Groups see “Programming Hunt Groups” on page 155.*

For more information on Call Forward and similar settings, see “Forwarding your calls to another Norstar telephone” on page 107.



## What would you like to do next?

Some of the most common programming tasks are listed below. For a comprehensive list of settings and instructions, see either the Table of Contents or the Index.

Redirect calls coming in on a line.

See “Turning on Line Redirection” on page 112.

Allow individuals to answer calls that are ringing at another telephone.

See “Picking up a call ringing at another telephone” on page 49.

Assign telephones to different zones for paging.

See “Paging” on page 117.

Turn the night service on and off.

See “Making additional telephones ring” on page 197.

Use a basic password so others can take care of programming such as changing user speed dials, changing names, changing the time and date, and activating Auto Attendant features.

See “Using passwords” on page 202.



# Answering calls

## Answering incoming calls with Hunt Groups

Your Norstar system now allows you to establish Hunt Groups in your system. Hunt Groups are a group of Norstar set DN's that can be called by a single directory number. The Hunt Groups feature ensures calls are easily routed to the appropriate people. You can program

- the members for a Hunt Group
- member position within a Hunt Group
- how calls are distributed
- how long a call spends looking for available members
- what happens if all members are busy

For more information on Hunt Groups see “Programming Hunt Groups” on page 155.

## Answering an incoming call

There are three indications of an incoming call: ringing, a line button flashing, and a message on the display. You may not necessarily receive all three indications for any particular call. For example, you may have a line that has been set up not to ring at your telephone. If so, you see only a flashing line button. There are many possible combinations, depending on how your system is set up. See “Choosing a line using a line button” on page 65 for more information on the use of lines.

If you receive a priority call and your telephone has no free internal line buttons, you cannot transfer the priority call, you must accept or release it.

## Line buttons

One line button for each line is assigned to your telephone. Press the line button to select the line you want to answer or use to make a call. Having several line buttons allows you immediate access to more than one line.

The M7100 and T7100 telephones have two intercom paths which are used instead of line buttons to answer and make calls. Each M7100 can be assigned two lines. You can press  to switch between two calls, one active and one on hold.

## What line indicators mean

- ▶ Flashing on and off for equal lengths of time      There is an incoming call on the line.
- ▶ Flashing on and off more quickly      You have placed a call on hold.
- ▶ Flashing on for longer than off      Someone else has put a call on hold on that line.
- ▶ On, not flashing      You are connected to the call on that line or the line is in use elsewhere.
- Off      The line is free.

## Rings you may hear

- A double beep every ten seconds      A call has been camped to your telephone.
- A long single ring      There is an external call on the line for you.
- A shorter double ring      There is an internal call on the line for you or a call is being transferred to you.
- A brief single ring      A call is being redirected on one of your redirected lines. You cannot answer this call.
- Three beeps descending in tone      You are receiving a priority call.

## Sorting calls by distinctive ring patterns

When lines are configured on your system, they can be assigned one of four distinctive ring patterns (DRP). The default for all telephones and lines is None, which is the lowest priority.

**Call ringing:** When multiple calls are presented to the telephone, the call with the highest priority DRP setting will be the call that rings at the telephone.

**Call answering:** When multiple calls are presented to a telephone, and the user picks up the handset, the call with the highest priority DRP setting is the call that is presented.

**Note:** External calls always have a higher priority than internal calls.

**Note:** If the ring type is changed on a telephone after the DRPs are set on the line, the line DRPs are overwritten by the telephone settings. If the DRPs are set for a line after telephone programming, then the telephone ring programming is overridden by the line DRP program. If the call is to a Hunt group, and the Hunt group DRP is higher than the line DRP, the Hunt group DRP will take precedence within the Hunt group.

## Answering calls at a prime telephone

Each line in a Norstar system can be assigned a prime telephone. Calls not answered at their normal destinations are transferred to the prime telephone. The prime telephone is usually the telephone assigned to the attendant. The installer or customer service representative programs a prime telephone for a line.

### Displays

DND from 21

The person at telephone 21 has forwarded a call to you using Do Not Disturb.

DND transfer

The system has transferred a call to you from a telephone with Do Not Disturb turned on.

DRT Line001

Nobody answered this call so the system transferred it to you.

Line001 callback  
CALLBACK

Someone has camped, parked or transferred a call on line 001, but no one has answered it. Press CALLBACK or the line button to connect to the call.

Line001 to prime

There is no telephone that can receive a call on line 001 so the system has transferred it to you.

Line002>Line052

The call coming in on line 002 was intended for target line 052. Line 052 is busy so the call has come to you.

For other displays, see “Common feature displays” on page 229.

## Using a central answering position (CAP) module

A central answering position (CAP) is a Norstar M7324 telephone and a CAP module that your installer or customer service representative programmed as a CAP. It is best if the CAP is the prime telephone and direct-dial telephone for the lines and telephones it serves.



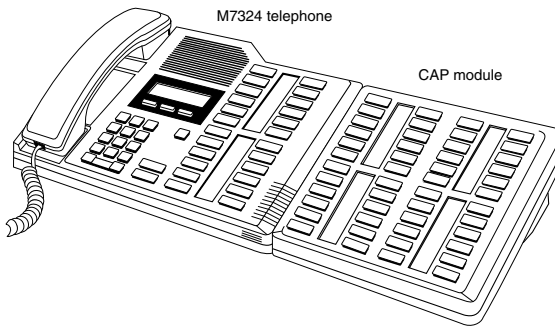

### M7324 set with one CAP module



A CAP module is an add-on device that provides 48 extra memory or line buttons. You can connect one Norstar CAP module to the telephone to increase the number of lines it can handle.

When a CAP module is first plugged into your telephone, some of the module buttons are already programmed to dial an internal number.

## Customizing your CAP module

If your installer has programmed the CAP module to be the central answering position for your system, you can move external lines onto the CAP module by using    . See “Moving line buttons” on page 147.

Any of the buttons on your CAP module that do not select lines can be programmed to dial internal or external numbers automatically. You can program features onto CAP module buttons. See “Storing a number on a memory button for Autodial” on page 84 and “Customizing your telephone” on page 135 for information on programming memory buttons.

## Monitoring telephones with the CAP module

The indicators  beside internal autodial buttons on your CAP module show the status of Norstar telephones.

### The indicator is on when the telephone has:

- an active call
- Do Not Disturb turned on



### The indicator is off when a telephone has:



- no active call
- a call on hold and no other active call



**Tip** - You can send up to 30 messages from a CAP.

## Release button

Pressing  ends a call. You do not have to put the handset down.  also ends feature programming.

While you are on a call, do not press  to end a feature you are using. If you do, you disconnect the call. Use  instead.





## Hearing aid compatibility

The handsets on all Norstar telephones are compatible with hearing aids as defined in the FCC rules, Part 68, section 68.316. Not all hearing aids are optimized for use with a telephone.

## Viewing information about a call on the display

If you subscribe to Call Display services from your local telephone company, one line of information about an external caller is displayed after you answer. Depending on the setting and the external information available, either the caller's name or telephone number is displayed.

When you transfer an external call to another Norstar user, this information is displayed on the recipient's telephone.

Call Display information becomes available between the first and second ring of an incoming call. If you answer before the Call Display information is available on your display, and you press    , you see only the line number or line name.

To use logging features with Call Display, see “Using Call Log” on page 127.

## Using Call Information for a particular call

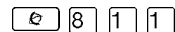

Call Information allows you to see information about incoming calls. This information is more detailed than the Call Display information you can receive automatically. For external calls, you can display the caller name, telephone number, and the line name. For an internal call, you can display the caller name and the internal number of their set. You can see information for ringing, answered, or held calls.

Call Information is available for calls even if they have been transferred, forwarded or rerouted in some way.





Names and numbers for external calls are displayed only if you have subscribed to Call Display services from your telephone company.







**Tip** - *Call Log displays the same information as Call Information, along with the date and time of the call, and the number of times the caller called.*





## Displaying Call Information before or after answering

To find out who is calling or to display information about your current call:





1. Press    .
2. Press  or VIEW to display more information about an external call.

Call Display information becomes available between the first and second ring of an incoming call. If you answer before the Call Display information is available on your display, and you press    , you see only the line number or line name.

## Displaying Call Information for a call on hold

1. Press    . The display shows **Select a call**.
2. Select the line on hold. Information about the call is displayed.
3. Press  or VIEW to display more information about an external call.



**Tip** - *If your telephone automatically displays Call Display information for a call, you need to press     before you can press  or VIEW to display more information about the call.*

## Making Call Display information appear automatically at a telephone

Each telephone that rings for an external line can display Call Display information for that line. After the call is answered, Call Display information is always shown at the telephone that answered the call. Your installer or customer service representative can program telephones to have automatic Call Display.

This feature is not available to ISDN terminals.

## Changing what information is shown first about a call

Depending on the services you subscribe to, Call Display information may contain up to three parts: the name of the caller, the number of the caller, or the name of the line in your Norstar system that the call is on. For each telephone, you can determine which information is displayed first.

You need the programming template found at the front of this guide. See “Getting started with Norstar” on page 13 for more information.

1. Press  \* \* 2 6 6 3 4 4 .
2. Press      (the default System Coordinator password).
3. Press  and enter the internal number of the telephone you want to program.
4. Press .
5. Press  four times.
6. Press .
7. Choose a setting at **1stDisplay:** using the **CHANGE** button. The choices are **Name**, **Numbr** or **Line**.

You may see **Unknown name** or **Unknown number** on the display if the information is not available from your telephone company. You may see **Private name** or **Private number** on the display if the caller blocks that information.





## Picking up a call ringing at another telephone

You can pick up a call ringing at another telephone using Directed Pickup or Group Pickup.

### Answering any ringing telephone using Directed Pickup

You can answer any telephone that is ringing in your Norstar system.

1. Press   .
2. Enter the internal number of the ringing telephone.

Call Pickup cannot be used to answer analog lines that are set to private.

To use Call Pickup (Directed Pickup), the telephone must be ringing. If, for example, the auxiliary ringer is ringing, but the call is not ringing at a telephone, the call cannot be answered using Directed Pickup. It must be answered normally at a telephone that has a flashing indicator for the call, or by using Trunk Answer. You can answer a call that is ringing because someone has transferred the call to a telephone and the call is ringing on an intercom button.



**Tip** - Directed pickup can retrieve calls that are ringing on an Answer DN. While you may enter the internal number of the telephone you hear ringing, it may be calls from another telephone you are answering.

### Answering any ringing telephone using Group Pickup

Your Norstar system can be divided into four pickup groups. If you are a member of a pickup group, you can pick up a call that is ringing at any telephone in your pickup group.

Press   .

Group Pickup cannot be used to retrieve a camped call.

If there is more than one incoming call at a telephone in a pickup group, a call ringing on an external line is answered first followed by calls on the prime line and, finally, calls on internal lines.



**Tip** - A Hunt Group call ringing at a Norstar set DN that is also a member of a call pickup group can be picked up by any Norstar set in that call pickup group. For more information on Hunt Groups see “Programming Hunt Groups” on page 155.

## Changing a pickup group for a set

Telephones can be put into and taken out of pickup groups.

You need the programming template found at the front of this guide. See “Getting started with Norstar” on page 13 for more information.

1. Press  \* \* 2 6 6 3 4 4 .
2. Press      (the default System Coordinator password).
3. Press  and enter the internal number of the telephone you want to program.
4. Press  twice.
5. Press  five times.
6. Press **CHANGE** at **PICKUP GRP:** to assign the telephone to pickup group 1, 2, 3, or 4, or to **None**.

### Displays

Already joined

You are already connected to the telephone that made the call you are trying to pick up. This can happen if you are on a call to a co-worker, your co-worker dials the number of a telephone in your pickup group, and you attempt to pick up that call.

Pickup denied

There is no call that you can pick up or the call that was ringing has already been answered.

You have tried to pick up a call on someone else's private line.

**Pickup:**

Enter the internal number of the telephone that is ringing. (You may use an internal autodial button to do this.)

If you decide not to answer a ringing call after you have activated Directed Pickup, press .





## Trunk Answer

The Trunk Answer feature allows you to answer a ringing call anywhere in the system from any telephone in the system. The line you are answering does not have to appear or ring at the telephone you are using.

Trunk Answer works only with calls that are ringing on lines for which a Ringing Service schedule is active and if Trunk Answer is enabled by your installer or customer service representative.

### Answering a call using Trunk Answer

Press    .



**Tip** - *If there is more than one incoming call on lines in a Ringing Service, the Trunk Answer feature picks up the external call that has been ringing the longest.*

### Displays

Line denied

You have tried to pick up a call on someone else's private line.

Pickup denied

The call that is ringing is on a line that is not in a Ringing Service.

## Answer buttons

You can use an Answer button to monitor calls to another telephone. All calls to the monitored Norstar telephone appear on the Answer button.

Answer buttons are useful for attendants who monitor incoming calls for one or several other people. For example, a secretary may have appearances for three different bosses on her answer buttons. Once a call for boss A is answered by the secretary, the appearance stops at that telephone. This allows for another, simultaneous call to come in on the same line. The same is true for boss B and boss C. When incoming call traffic becomes high, the calls can then be routed to a Hunt Group to optimize call handling. For more information on Hunt Groups see “Programming Hunt Groups” on page 155.

The Answer button setting in Featr settings programming allows you to determine what types of calls alert at the telephone. Your choices are: Basic, Enhanced and Extended.

See the *Modular ICS 6.0 Installer Guide* for more information.

- ISDN terminals cannot be assigned Answer buttons to monitor other sets, but they can be monitored.
- You cannot make calls using Answer buttons.
- If more than one call is ringing at a telephone, the first call appears on the Answer button of the attendant. Any subsequent calls appear on intercom buttons, if they are available.





**Tip** - *More than one attendant may have an Answer button for a single telephone. This allows two or more attendants to handle calls for a busy person.*



*Each telephone can handle calls for up to eight other people using a separate Answer button for each person.*

## Creating a Conference Call

You can talk to two people at once.

1. Make sure you have two calls, one active and one on hold.
2. Press  .
3. Press the appropriate button to retrieve the held call (this is automatic on the M7100 and T7100 telephones).

You can create a conference when you are on a call.

1. Make a second call.
2. Press  .
3. Press the button where the first call is on hold to create a conference.

Only the person who established the conference can process the conference by using the procedures described in this section.



**Tip** - You can create a conference by releasing privacy on a call. See “Turning Privacy on or off for a call” on page 60.





## Disconnecting one party



You can disconnect one party from a conference and continue talking to the other.

On the telephone you are using for system programming:

1. Press the line button of the call that you want to disconnect. The call that you want to keep is automatically put on hold.
2. Press . The call is disconnected.
3. Press the line button of the held call to speak to the remaining person.

On an M7100 or T7100 telephone:

1. Press   , to place one caller on hold. Press  again, to put the caller you want to keep on hold.



2. Press . The call is disconnected.
3. Press  to speak to the remaining party.

## Independently holding two calls

For all Norstar telephones except the M7100 and T7100 telephones, you can put the two people in a conference call on hold independently so that they cannot talk to each other.

1. Press the line button of one person. The other person is automatically put on hold.
2. Press . The second person is put on hold.

You can re-establish the conference.

1. Take one call off hold.
2. Press  .
3. Take the other call off hold.

## Putting a conference on hold

You can put a conference on hold, allowing the other two people to continue speaking to each other by pressing .

You can reconnect to the conference by pressing either of the held line buttons. For M7100/T7100 telephones, press .





## Splitting a conference

You can talk with one person while the other person is on hold.

On a T7316, M7208, M7310 or M7324 telephone:

1. Press the line button of the person you want to speak to. The other person is automatically put on hold.

On an M7100 or T7100 telephone:

1. Press   . The first party is on hold.
2. Press , if necessary, to switch parties.

You can re-establish the conference.

1. Press **[\*] 3**.
2. Take the held call off hold. This is not necessary for the M7100 or T7100 telephone.

## Removing yourself from a conference

You can remove yourself from a conference, and connect the other two callers through your Norstar system.

Enter the Transfer feature code **[\*] 7 0**.

When you remove yourself from a conference using the Transfer feature, and both callers are from outside your system, one of the callers must have called you on a disconnect supervised line, or the call is disconnected.

### Displays

**3 Parties only**

You are trying to add a fourth party to your conference call, or to join two conferences together. Release one call from the conference before adding another, or keep the two conferences separate.

**Conf. on hold**

You have put a conference call on hold.

**Conference busy**

You have tried to make a conference call, but your system is already handling its maximum of four conference calls.

**Line001 21**  
**TRANSFER**





You are on a conference with the two lines or telephones shown. You can drop out of the conference and leave the other two parties connected (Unsupervised Conference) by pressing **TRANSFER** or entering the Transfer feature code.

**Press held line**

You have activated the Conference feature with one call active and another on hold. Press the line of the call on hold to bring that person into the conference.





For other displays, see “Common feature displays” on page 229.

## Listening to a call as a group

To allow people in your office to listen in on a call using Group Listening, press    .

Continue to speak to the caller through the telephone handset. The voice of the caller broadcasts through the speaker on your telephone. The microphone on your telephone is off, so the caller does not hear people in your office.

## Canceling Group Listening

Group Listening is canceled automatically when you hang up or when you press     .



**Tip** - *Keep the handset away from the speaker, or you may hear feedback. The higher the volume, the more the feedback. Press  to prevent feedback when hanging up.*

## Using Handsfree/Mute

The ability to use Handsfree has to be turned on or off for each telephone. The type of Handsfree can be changed. See “Changing Handsfree for a telephone” on page 59.

You must turn on Handsfree for a telephone to be able to use a headset.

## Answering calls without lifting the handset

1. Press the line button for the ringing call.  
This step is not necessary if you have a prime line assigned to your telephone.
2. Press the button labeled Handsfree/Mute. The internal microphone and speaker are automatically turned on.



---

Handsfree is not available for an M7100 or a T7100 telephone.



**Tip** - *Direct your voice toward the telephone. The closer you are to the telephone, the easier it is for the microphone to transmit your voice clearly to your listener.*

## Making calls without lifting the handset

1. Press the button labeled Handsfree/Mute.  
If you do not have a prime line assigned to your telephone, press a line button. The internal microphone and speaker are automatically turned on.
2. Dial your call.
3. Speak normally.

## Muting Handsfree

1. Press the button labeled Handsfree/Mute to switch off the telephone microphone so that you can speak privately to someone in your office while you are on a handsfree call.
2. Press the button labeled Handsfree/Mute to turn the microphone back on again and continue your handsfree call.

## Changing a regular call to handsfree

1. Press the button labeled Handsfree/Mute.
2. Hang up the handset.

## Changing a handsfree to a regular call

Lift the handset.

## Using Handsfree

The indicator next to the button labeled Handsfree/Mute is solid when you have Handsfree turned on.

The indicator next to the button labeled Handsfree/Mute is solid when you mute the microphone.

Note: Other models of telephone may have one button for both functions. In this case, when the set is on handsfree and the microphone is on, the light is solid. If the set is on handsfree and the microphone is off, the light flashes.

Wait for your caller to finish speaking before you speak. The microphone and speaker cannot both be on at once. Your caller's voice may be cut off if you both speak at the same time. Noises such as a tapping pencil could be loud enough to turn on your microphone and cut off your caller's speech.

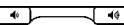
To prevent a possible echo, keep the area around your telephone free of paper and other objects that might screen your microphone. Turning down the microphone's volume (press the left end of ) while speaking) prevents echoes. When you change the volume level, both the microphone and speaker volume are adjusted to prevent feedback problems.

Place the telephone so that any unavoidable local noise (such as an air conditioner) is behind it. This limits the amount of disruptive background noise.



**Tip** - *In open-concept environments, use the handset when handsfree communication is not necessary or when you need privacy during a call. Another option is to use a headset.*

## Changing Handsfree for a telephone

You can program the type of Handsfree used with each telephone.

You need the programming template found at the front of this guide. See “Getting started with Norstar” on page 13 for more information.

1. Press         .
2. Press      (the default System Coordinator password).
3. Press  and enter the internal number of the telephone you want to program.
4. Press  twice.
5. Press  three times.
6. Choose a setting at **Handsfree:** using the **CHANGE** button.

There are three ways to set Handsfree for an individual telephone:

**Handsfree:None**  
**CHANGE**

Handsfree is not available to the telephone.

**Handsfree:Auto**  
**CHANGE**

You can make or answer a call without having to pick up the handset or press the button labeled Handsfree/Mute. The internal microphone and speaker of the telephone turn on automatically when you press a line or intercom button to make or answer a call.

**Handsfree:Std**  
**CHANGE**

A standard version of Handsfree described “Using Handsfree/Mute” on page 56.

For other displays, see “Common feature displays” on page 229.

Both Auto and standard Handsfree allow you to use a headset with a Norstar telephone.

A Handsfree/Mute button is automatically assigned to a telephone that is programmed with Handsfree and is always located in the lower right-hand corner of the telephone.

## Changing Handsfree Answerback for a telephone

Handsfree Answerback allows you to answer a voice call without lifting the handset. It is always turned off for an M7100 or T7100 telephone.

You can turn Handsfree Answerback on or off for a telephone that is programmed to use Handsfree.

You need the programming template found at the front of this guide. See “Getting started with Norstar” on page 13 for more information.

1. Press         .
2. Press      (the default System Coordinator password).
3. Press  and enter the internal number of the telephone you want to program.
4. Press  twice.
5. Press  four times.
6. Choose a setting (Yes or No) at **HF answerback:** using the CHANGE button.

## Turning Privacy on or off for a call

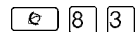

Lines in your system can be configured to have automatic privacy. If a line is not programmed with privacy, anyone with the line assigned to their telephone can join your call by pressing the line button. If a line is programmed with privacy, only one person at a time can use the line.

Privacy control cannot be used on internal or conference calls.

When another telephone joins a call, the participants on the call hear a tone, and a message appears on the Norstar display. You cannot join a call without this tone being heard.

## Creating a conference by releasing privacy

If a line is programmed with privacy, you can turn privacy off to allow another person with the same line to join in your conversation and form a conference. All the rules applicable to a conference apply except there is only one line in use, instead of the normal two. This means that you cannot split a conference set up using Privacy.

1. Press   .
2. Tell the other person to press the line button and join your conversation.

Only two Norstar telephones in addition to the external caller can take part in this kind of conference.

## Making a call private

If a line is programmed to not have privacy, you can turn privacy on for a call, preventing other people with the same line from joining your conversation.

Press   .

## Checking call length using Call Duration Timer

By pressing   , you can see how long you spent on your last call, or how long you have been on your present call.

### Displays

21 02:47

The display shows the last call you made, or the current call, and the total elapsed time in minutes and seconds.

Line001 01:45

You parked your last call. The display shows the length of time the call was parked. You cannot see the length of time a call was parked unless the call is active at your telephone or has just been released by your telephone.

## Disconnecting by accident

If you accidentally drop the handset back into the telephone cradle while answering a call, you can quickly retrieve the call.

Pick up the handset again or press the button labeled Handsfree/Mute within one second to be reconnected to your call.

# Making calls

There are many ways to make a call, depending on the programming and the type of call, as follows:

- Pick up the handset and dial. The Norstar system supports three methods of dialing. See “Changing how you dial your calls” on page 67.
- Pick up the handset, press a line button, and dial, if the call is not on your prime line.
- Press the button labeled Handsfree/Mute and dial to talk without using the handset. See “Using Handsfree/Mute” on page 56.
- Press the button labeled Handsfree/Mute, press a line button, and dial to talk without the handset and if the call is not on your prime line.
- Press a line button and dial to talk without the handset and if Automatic Handsfree is assigned to your telephone.
- Use one of the features that make dialing easier. See “Storing a number on a memory button for Autodial” on page 84.

## Displays

21 busy  
PRIORITY            LATER

The telephone you have called has no internal lines available. Press LATER to use the Ring Again or Message features or press PRIORITY to make a priority call.

9\_  
QUIT            BKSP

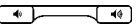
You are dialing using Pre-Dial. To erase an incorrect digit, press the left end of  or BKSP. When the number is complete, select a line or lift the handset.

95551234  
   TRANSFER

This prompt remains on your display as long as you are on a call you have dialed. To transfer the call, press TRANSFER.

Already joined

Your telephone is already connected to the telephone you are trying to call. Check your active line buttons, and return to that call.

Calling 21  
PRIORITY      LATER

Wait for the telephone to be answered. If no one answers, press LATER to use the Ring Again (page 70) or Message (page 120) feature, or press PRIORITY to make a priority call.

Can't ring again

You cannot use Ring Again on your current call. You can only use Ring Again while you have a busy signal on an internal call or line pool request or while an internal call is ringing.

Do not disturb  
PRIORITY      LATER

The telephone you are calling has Do Not Disturb turned on. Press LATER to use the Ring Again or Messages features, or press PRIORITY to make a priority call.

Expensive route

You have dialed a number, but the least expensive route that the system is programmed to use is busy. Unless you release the call, it goes through on a more expensive route.

Hidden number

The last number you dialed or the number you saved for Saved Number Redial was a speed dial number that displayed a name rather than the number. The number is dialed correctly, but you cannot see it.

Line denied

You have attempted to use someone else's private line.

Line001  
TRANSFER

Enter the digits of the number you want to dial.

No last number

You have not dialed an external telephone number since the last power interruption or system reset.

No line selected

Either you have no prime line or your prime line is busy. Select a line manually before dialing.

Not in service

You have entered the number of a telephone that is not in service.

On another call  
LATER

The telephone you have called is on another call. Press LATER to use the Ring Again or Message features.

Restricted call

The call you are trying to make has been restricted in programming. A possible reason is time-of-day restrictions on certain calls.



Ring Again?  
 YES    NO    EXIT

Press YES to use Ring Again. Press NO to send a message. See “Sending a message” on page 120 and “Turning on Ring Again” on page 70.

Select a line

Either you have no prime line, or the prime line is in use, or the line programmed for an autodial number, speed dial number, or Hotline is in use. Select a line and dial again.

Send message?  
 YES    NO

Press YES to send a message. See Messages.

For other displays, see “Common feature displays” on page 229.

## Choosing a line using a line button

You have one line button for each line assigned to your telephone. Press the line button to select the line you want to answer or use to make a call. Having several line buttons allows you immediate access to more than one line.

The M7100 and T7100 telephones have two intercom paths which are used instead of line buttons to answer and make calls. Each M7100 or T7100 telephone can be assigned two lines. You can press  to switch between two calls, one active and one on hold.

## Line pools

A line pool is a group of external lines that can be shared by many telephones. You can use a line in a line pool to make an external call.

The Norstar Compact ICS can have three line pools, and a telephone can be programmed to access any number of them.



A line pool access code is a number you dial to get a line pool. The access code can be up to four digits long. You can have several different line pools for your system, each one giving you access to a different set of external lines. It is one way of sharing lines across telephones in a system.

Your installer or customer service representative programs the line pool access codes and gives each telephone access to a line pool.

Everyone in the office should have a list of the line pool access codes for the line pools their telephones can use.

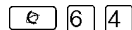
## Using a line pool to make a call



1. Press   .
2. Enter a line pool access code.

If you have a free internal line, you can make a call using a line pool without entering the feature code first.

1. Select an internal line (intercom).
2. Dial the line pool access code.



**Tip** - *If no lines are available in the line pool, you can use Ring Again at the busy tone. You are notified when a line in the line pool becomes available. See “Using Ring Again” on page 70.*

## Programming a memory button with a line pool feature code







When you program a button with the line pool feature code, you must enter a line pool access code after the feature code. The programmed line pool button accesses a specific line pool, not the line pool feature. See “Programming feature buttons” on page 137 for more information.

If you program a button with an indicator to access a line pool, when all the lines in a line pool are busy, the indicator for the line pool button turns on. The indicator turns off when a line becomes available.

## Making calls from an ISDN terminal

ISDN terminals do not have line keys or intercom keys as do Norstar telephones. To make an outgoing call from an ISDN terminal, access an external line by entering a line pool code or by using the ARS feature.

## Changing how you dial your calls

1. Press    .
2. Press  or **NEXT** until the dialing mode you want appears.
3. Press  or **OK** to select the displayed dialing mode.

The dialing modes feature code cannot be programmed onto a memory button.

## Using Standard Dial

Standard Dial allows you to make a call by selecting a line and dialing the number. If you have a prime line, it is selected automatically when you lift the handset or press the button labeled Handsfree/Mute.

You cannot use Standard Dial on an M7100 or T7100 telephone unless you pick up the handset first. If you are using either of these sets, use the Automatic Dial or Pre-dial feature for on-hook dialing.

## Using Automatic Dial

Automatic Dial allows you to dial a number without selecting a line. Your prime line is selected as soon as you start dialing a number.



Automatic Dial does not work if your telephone has no prime line or if your prime line is in use.

Telephones connected to an analog terminal adapter (ATA) cannot use Automatic Dial.

## Using Pre-dial

Pre-dial allows you to enter a telephone number, check it, then change it before actually making the call. The call is not dialed until you select a line or line pool, or pick up the handset. You can pre-dial both external and internal numbers. You must, however, select the correct type of line (external or internal) for the type of number you have entered.



**Tip** - *If your telephone starts ringing while you are pre-dialing a number, you can stop the ringing by turning on Do Not Disturb (  ).* This does not affect numbers you are entering.

*You cannot pre-dial a telephone number if all the lines on your telephone are busy.*

## When the internal number you have called is busy

### Priority Call

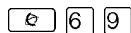



If you get a busy signal or a Do Not Disturb message when you call someone in your office, you can interrupt them. Use this feature for urgent calls only.



**Tip** - *Priority calls cannot be made to Hunt Group DN's. For more information about Hunt Groups see "Programming Hunt Groups" on page 155.*

### Making a priority call

1. Press   .
2. Wait for a connection, then speak.

A person who receives a priority call while on another call has eight seconds to accept or block the call. For information on blocking calls see "Using Do Not Disturb" on page 181. If the person does nothing, the priority call feature puts their active call, including conference parties, on Exclusive Hold and connects your call.

## Giving a telephone the ability to make priority calls

You need the programming template. See “Getting started with Norstar” on page 13 for more information.

1. Press          .
2. Press      (the default System Coordinator password).
3. Press  and enter the internal number of the telephone you want to program.
4. Press  twice.
5. Press  nine times. The display shows **Priority call:**.
6. Press **CHANGE** to choose **Y** (Yes) or **N** (No).

### Displays

Call blocked

You tried to place a priority call to another Norstar telephone. The person you called has blocked your call. Try to call later.

Please wait

The party you are calling has eight seconds to decide whether to accept or reject your priority call.

Priority denied

The telephone you are calling has already received a priority call or is unable to receive priority calls.

You can make a priority call only while your telephone displays:

21 busy

PRIORITY LATER

Calling 21

PRIORITY LATER

Do not disturb

PRIORITY LATER

On another call

PRIORITY LATER

## Using Ring Again

Use Ring Again when you call someone on your Norstar system and their telephone is busy or there is no answer. Ring Again can tell you when they hang up or next use their telephone. You can use Ring Again to tell you when a busy line pool becomes available.



**Tip** - *The Ring Again feature cannot be used when calling a Hunt Group DN. For more information on Hunt Groups see “Programming Hunt Groups” on page 155*

## Turning on Ring Again

Press   before you hang up.

Using Ring Again cancels any previous Ring Again requests at your telephone.

## Canceling Ring Again

Press    to cancel a Ring Again request.

### Displays

```
Can't ring again
```

You cannot use Ring Again on your current call. You can only use Ring Again while you have a busy signal on an internal call or line pool request, or while an internal call is ringing.

```
Ring Again?
```

```
YES      NO      EXIT
```

Press YES to use Ring Again. Press NO if you prefer to send a message.

# Auto Attendant

The built-in Auto Attendant automatically answers and directs incoming calls, which can reduce or eliminate the workload for the person who answers incoming calls for an office. The Auto Attendant carries out three tasks: System Answer, Custom Call Routing (CCR) and direct extension dialing.



**Tip** - *The Auto Attendant can transfer calls to a Hunt Group. For more information on Hunt Groups see “Programming Hunt Groups” on page 155.*

Your installer or customer service representative enables the Auto Attendant for your Compact ICS, and programs which lines are to be answered by CCR.

You may have the option of choosing to record your own greetings instead of using the pre-recorded greetings for System Answer and CCR. Consult your Customer Service Representative to determine whether or not your system has the capability to record customer greetings.

## System Answer

The System Answer feature simplifies the job of answering calls by making sure all calls are answered within a set number of rings. When calls go unanswered at the telephone monitored by System Answer (called the attendant set), Norstar answers the call and plays a greeting. It then puts the call on hold until someone can retrieve it.

If the caller knows the internal number they want to reach, or is using the Norstar remote features, they can dial while the System Answer greeting is playing.

System Answer monitors all external calls that appear as a flashing line button on the attendant telephone including Answer buttons and external calls that have been transferred. After System Answer has played the

greeting, the call is put on hold at the same line indicator where it first appeared. The feature does not answer calls from internal extensions.

## Custom Call Routing (CCR)

The job of answering and transferring calls can be taken over by CCR. When someone calls on lines monitored by CCR, the system answers the call and plays a greeting you have recorded. Callers using a tone dial set can then:

- direct their call by pressing a digit as instructed by your greeting (for example, “to reach our salespeople, press 4”)
- enter an internal telephone number (a fast way for regular callers to reach someone directly)
- access remote features
- reach an attendant by pressing a single digit (a way to transfer out of CCR and talk to someone)

You can use two greetings with CCR: one for when your office is open and one for when it is closed. The business closed greeting may announce your office hours and give a digit to press to leave a message (if you have a voice mail system or answering machine), and callers can dial an internal number to reach someone who is working after hours.

If CCR forwards a call and it goes unanswered (either because the caller enters an invalid extension number or no one is there to answer the call) the call is redirected to ring at the prime telephone after the usual Callback delay. Once a caller has dialed out of the CCR greeting, he or she is not able to return and make another selection.

## CCR groups

CCR allows callers to reach groups of telephones by dialing a single digit they select from the audio menu. You create the CCR groups in programming.

When a call is sent to a CCR group in which all the telephones have the same programming, the call goes to the telephone with the lowest internal number.



If the telephones in a CCR group have different programming, the call is handled by the telephone programming that takes effect first. For example, if a telephone in a group forwards after two rings, it forwards the call from CCR before the telephones in the group that are programmed to forward after three rings.

A CCR call is forwarded by Forward on Busy, the Call Forward feature code, and Callback programming. Be sure to keep this in mind when programming the telephones in your CCR groups.

When a call that was handled by CCR rings at your telephone, call information appears automatically on the display. You must subscribe to a call display service and have the proper equipment installed in your system for this feature to work. If CCR is programmed to answer the call in less than two rings, the call information may not be captured and forwarded to the telephones in the CCR group.

## Direct extension dialing

Both System Answer and CCR give the caller the opportunity to dial an internal telephone number or use remote feature access such as direct inward system access (DISA). This means callers do not have to wait to reach the person they are calling and only the person they are calling has to handle the call.

## Customizing System Answer and CCR

Your installer or customer service representative turns on System Answer and CCR for your system. They assign which lines can be answered with CCR. Until this master control is turned on, the Auto Attendant features are not available.

It is recommended that the CCR not be programmed to answer lines that are answered by System Answer at the attendant telephone (usually the reception telephone).

Plan how you are going to customize System Answer and CCR before you start programming.

- Decide which telephone is to be the attendant telephone. This telephone is one where calls can be answered automatically and put on hold.

- For pre-recorded greetings, decide which language is to be used to greet callers. If you want two languages, decide which is heard first.
- Write down the greetings or scripts that you want to record as the company greeting and business closed greeting. Refer to examples in “Recording customized greetings for System Answer and CCR greetings” on page 81.
- Organize your telephones into groups and decide what number a caller is to use to reach each group. Using the groups and numbers you have created, write down the greeting or “script” to be heard as the CCR.
- Decide how many times a call rings before System Answer and CCR answer. Be sure it does not conflict with voice mail or other auto attendant applications you may be using. If CCR lines ring at the attendant set, CCR and System Answer can conflict.
- Use a programming session and feature codes to create your custom System Answer and CCR.
- Test both System Answer and CCR to make sure they are working properly.
- Make sure your installer or customer service advisor has programmed your system to use the held line reminder tone. This provides another indication that System Answer has placed a call on hold.

## Turning System Answer on or off

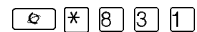

System Answer can be turned on and off at any telephone in the system. System Answer handles only the calls that ring at the attendant telephone (attendant set).

1. Press . The display shows the current status of System Answer.
2. Press **CHANGE** or and enter the System Coordinator password or Basic password (the default passwords are and ) to turn the feature on or off.
3. Press **OK** or to confirm the change.

Because System Answer answers calls and then puts them on hold, the feature should be turned off when no one is at the telephone to retrieve the calls.



**Tip** - You can program the feature code for turning System Answer and CCR on or off on a memory button with an indicator at the attendant telephone. You know that the feature is turned on when the indicator is lit at the attendant set.

## Turning CCR on or off

\* 8 3 2

1. Press  \* 8 3 2 . The display shows the current status of CCR.
2. Press **CHANGE** or  and enter the System Coordinator password or Basic password (the default passwords are  and  ) to select a setting: **OFF**, **Bus. Open**, or **Bus. Closed**.
3. Press **OK** or  to confirm the change.

See the section on recording greetings for a description of the Business Open and Business Closed greetings used with CCR.

## Choosing the attendant telephone

Programming allows you to choose a telephone to be the attendant telephone (attendant set). External calls that go unanswered at this telephone are handled by System Answer.

You need the programming template found at the front of this guide. See “Getting started with Norstar” on page 13 for more information.

1. Press  \* \* 2 6 6 3 4 4 .
2. Press  (the default System Coordinator password). The display shows **Terminals&Sets**.
3. Press  twice. The display shows **System Programming**.
4. Press , , and  . The display shows the internal number of the current attendant telephone.

5. Press **CHANGE** and enter the internal number of the telephone you want to assign as the attendant telephone.

## Changing the language for System Answer and CCR

The programmed greetings used with the auto attendant features are available in three languages. You can change which language that callers hear, or program the system to play greetings in a second language.

If you record your own greeting, that custom greeting is the one that is played regardless of the language choice.

You need the programming template found at the front of this guide. See “Getting started with Norstar” on page 13 for more information.

1. Press         .
2. Press      (the default System Coordinator password). The display shows **Terminals&Sets▶**.
3. Press  twice. The display shows **System Programming▶**.
4. Press  ,  , and  . The display shows the setting for the attendant telephone.
5. Press  . The display shows **Language▶**.
6. Press  . The display shows the first language used in greetings.
7. Press **CHANGE** to select a language: **English**, **French** or **Spanish**.
8. Press  . The display shows the second language that callers hear. Press **CHANGE** to select a different language or **NONE**.

## Setting ring delay before System Answer takes a call

You need the programming template found at the front of this guide. See “Getting started with Norstar” on page 13 for more information.

1. Press         .
2. Press      (the default System Coordinator password).
3. Press  twice.
4. Press  ,  , and  .

5. Press  twice. The display shows **System Answer...**
6. Press .
7. Press **CHANGE** until you see the appropriate number of rings (between 1 and 12).

If the system is busy answering calls, the line rings until System Answer can retrieve the call.

## Setting the ring delay before CCR greeting answers

You need the programming template found at the front of this guide. See “Getting started with Norstar” on page 13 for more information.

1. Press         .
2. Press      (the default System Coordinator password).
3. Press  twice.
4. Press , , and .
5. Press  three times. The display shows **CCR▶**.
6. Press .
7. Press **CHANGE** until you see the appropriate number of rings (between 1 and 12).

If the system is busy answering calls, the line rings until CCR can retrieve the call.

If CCR is programmed to answer the call in less than two rings, the call information may not be captured and forwarded to telephones in the CCR group.

## Adding/removing telephones from CCR groups

The greeting you create for CCR tells a caller to press a number to reach a group of telephones. You add or remove telephones from these groups (CCR groups) in programming.

You need the programming template found at the front of this guide. See “Getting started with Norstar” on page 13 for more information.

1. Press         .
2. Press      (the default System Coordinator password).
3. Press  twice.
4. Press , , and .
5. Press  three times. The display shows **CCR**.
6. Press .
7. Press . The display shows **CCR groups**.
8. Press  and enter the number of the group to which you want to make changes.
9. Press  and enter the internal number of the telephone you want to add or remove from the group.
10. Press **CHANGE** to select the status of the telephone in the group:  
**Assigned, Unassigned.**

You can have a total of nine CCR groups. Each group can include up to 20 telephones.

## Using the pre-recorded greetings

Pre-recorded greetings are always used when the System Answer or CCR are turned on, even if you do not create personalized recordings. The pre-recorded greetings can be turned off (not erased) and/or replaced with user-recorded substitutes. If a pre-recorded greeting is turned off, all System Answer and CCR features that use that greeting are affected.

Incoming calls at the attendant telephone hear the System Answer greetings. Lines that are set up to be answered by CCR hear a different set of greetings. They are:

- All of our operators are busy.
- If you know the extension that you want, and are using a touch-tone phone, please dial it now.
- *Or*, hold the line and your call will be answered as soon as possible.
- Thank you for calling.

In the next section, these recordings appear (in italics) as part of examples of complete greetings that callers might hear. “Thank you for calling” is heard when the caller does not respond to the Business closed greeting after it has been repeated, before the system disconnects the caller.

## Using customized greetings for System Answer and CCR

Norstar uses both greetings you record and pre-recorded greetings to tell callers how their call is being handled. You can make your own voice recordings for all of the greetings used in System Answer and CCR.

For customer greetings, you can create your own version or turn the greeting off completely. With system greetings, you can select the system version, create your own version, or turn the greeting off.

The following examples use greetings recorded for use at a company called Bluebird Consulting. You can use them as models for when you make your own recordings.

The pre-programmed parts of the greetings are shown in italics.

System Answer on:

You have reached Bluebird Consulting. *All of our operators are busy. If you know the extension that you want, and are using a touch tone phone, please dial it now. Or, hold the line and your call will be answered as soon as possible.*

You may choose to create your own message (shown in italics following) instead of using the pre-recorded greetings:

You have reached Bluebird Consulting. *We can't come to the phone right now. If you know the number of the person you are trying to reach, enter the number now. Or stay on the line and someone will assist you momentarily.*

CCR, Bus. open:

You have reached Bluebird Consulting. To reach one of our sales agents, press 1. To contact our accounting office, press 2.

To reach Joan Smithers, press 3. To talk to an attendant, press 0. To repeat this menu, press star. *If you know the extension that you want, and are using a touch tone phone, please dial it now. Or, hold the line and your call will be answered as soon as possible.*

CCR, Bus. closed:

You have reached Bluebird Consulting. Our offices are closed. Our business hours are 8 a.m. to 5 p.m., Monday through Friday, Pacific Standard Time. *If you know the extension that you want, and are using a touch tone phone, please dial it now.*



**Tip** - *For better sound quality in your greetings, use the handset for recording greetings (not the handsfree microphone).*

## Time available for customized greetings

You have a total of 96 seconds of recording time to allocate to all greetings. If you begin by recording a 15-second company greeting, there are 81 seconds available for the remaining greetings ( $96-15=81$ ). The maximum length of a single recording is 32 seconds. If you exceed the maximum time for a single recording, an error message accompanied by a tone is given.

A greeting that is turned off is not erased. The time used by the greeting does not return to the 96-second time pool.

User-recorded greetings are stored on the feature card. The recordings are erased when the card is replaced. If the same card is removed then reinserted, the recordings are preserved. You must re-record all user-recorded greetings when upgrading to a new feature card.

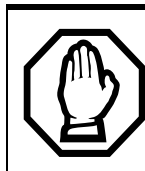

System greetings are permanent and can never be erased.





FLASH memory degrades slightly each time a message is recorded. Typically, messages can be erased and written thousands of times. However, care must be taken to plan out what messages are to be recorded and how often they are to be changed in order to reduce the number of re-recordings made over a long period of time. A warning is given when the card has degraded significantly. Contact your Customer Service Representative when this warning occurs.

The pre-recorded system messages do not use any portion of the 96 seconds of total recording time. They cannot be erased, but they can be turned off or replaced with a user-recorded substitute.

## Recording customized greetings for System Answer and CCR greetings

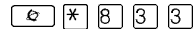

Both System Answer and CCR must be turned off to use this feature.

The customized greetings are not available to System Answer and CCR while you are recording. Callers hear only the pre-recorded greetings.

There are seven greetings to choose from, three user greetings and four pre-recorded system greetings.

You can record your own user greetings with the first three greetings choices (A, B, and C). You can also turn these greetings off.

If your system does not have the capability to allow you to record your own version of the system greetings (D, E, F, and G) you can turn on the pre-recorded system greetings or turn them off.

If your system has the capability to allow you to record your own version of the system greetings (D, E, F, and G) you can record your own system greetings, turn on the pre-recorded system greetings or turn them off.

1. Press **[☎] [\*] [8] [3] [3]** and enter the System Coordinator password (the default password is **[2] [3] [6] [4] [6]**).
2. If you have the capability to record your own system greetings, the display shows **Auto att grtns**.

If you do not have the capability to record your own system greetings, the display shows **Change rec time?**. Select **yes** to change the recording time or **no** to keep the recording time as is.

The display then shows **Auto att grtns**. Your choices are: **SHOW**, **EXIT**, and **NEXT**. (**NEXT** takes you to the menu for programming destinations for CCR.)

3. Press **[Show]**. The display shows **Grt9 A mode: User**. Your choices are: **CHG**, **SHOW**, and **NEXT**. **NEXT** takes you to **Grt9 B mode: User**.
4. Press **CHG** if you want to turn greeting A, B, or C off (**Off**) or if you want to record your own greeting (**User**). For system greetings D, E, F, and G, you may select **Sys** to turn on the pre-recorded greetings, **User** to record your own version of the greeting, or **Off** to turn them off. If your system does not have the capability to allow you to record your own version of the system greeting (D, E, F, and G), you may select **Sys** to turn on the pre-recorded greetings, or **Off** to turn them off. A greeting that is turned off is not erased. The time used by the greeting is not returned to the 96-second time pool.
5. Press **[Show]**. The display shows **Greeting A: User**. Your choices are **PLAY**, **REC**, and **OK**. Press **PLAY** to play the greeting.
6. Press **REC** to record a greeting. As soon as you press **REC** the previous recording is erased. Making a recording of less than two seconds duration also erases the previous greeting.
7. Press **OK** when you have completed your recording.
8. To continue recording greetings, press **NEXT**, then **REC** to record the next greeting.
9. Press **OK** when you have completed your recording.

Example: "Our business hours are 8 a.m. to 5 p.m., Monday through Friday".

- To continue recording greetings, press **NEXT**, then **REC** to record the next greeting, for example the caller menu.

The greeting used with the caller menu indicates the destinations you have chosen for each digit.

Example: “To reach one of our sales agents, press 1. To contact our accounting office, press 2. To reach Joan Smithers, press 3. To talk to an attendant, press 0. To repeat this menu, press star.”

- Continue recording any remaining greetings. Remember that some greetings are shared by both System Answer and CCR. Ensure that the recording is appropriate for both features.



**Tip** - *If you have recorded your greetings, you can press **NEXT** from the display showing Auto att. greetings and go right into the menu for programming destinations for CCR.*

## Programming or changing CCR destinations

- Press **[\*] [8] [3] [3]** and enter the System Coordinator password (the default password is **[2] [3] [6] [4] [6]**).
- Press **NEXT** until the display shows **CCR tree**. The choices are **SHOW**, **EXIT**, and **PREV**.
- Press **[Show]**. The display shows **Dial 0:** and the current destination when the caller presses zero. Your choices are **CHNGE** and **NEXT**.
- Press **CHNGE** to select the appropriate destination.

Each number from zero to nine and **[\*]** can direct a call to the attendant telephone or one of the nine CCR groups. The **[\*]** can be set up to make the system play the CCR greeting again (**Repeat**). If a digit is set to **None**, it has no destination.

Using **NEXT** and **CHNGE**, select the destinations for the remaining digits.

## Testing your custom System Answer and CCR

If you have more than one external line, you can call in to hear your greetings by dialing the number used by external callers to call the attendant set or a line that is answered using CCR.

To call systems with only one external line, you must go to a telephone that is not connected to your system. ime savers for making calls



## Storing a number on a memory button for Autodial



You can program memory buttons for one-touch dialing of internal or external telephone numbers.

Buttons used for lines, answer or Handsfree/Mute cannot be used as autodial buttons.

If the power to your Norstar system is off for more than three days, autodial numbers (as well as some other system programming) may be lost from the memory.

## Adding an autodial button

 \* 1 or  \* 2

1. Press  \* 1 to program an external number or  \* 2 for an internal number.
2. Choose a button and then enter the number as if you were dialing it.

When programming Autodial you can use:

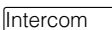
- Last Number Redial
- Saved Number Redial
- destination codes (choose the button with the  label as the line)
- host system signalling

## Choosing a line for Autodial

To include a line selection for an external number, press the line or intercom button before you enter the number. To select a line pool, press a programmed line pool button, or press the button with the  label and enter a line pool access code.

If you select a line before pressing the autodial button, the call goes out on the line you have selected instead of the line that is part of the autodialer programming.

For the M7100 or T7100 telephone, an external autodialer can be programmed only by using a line and not a line pool.



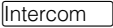

**Tip** - *If you do not include a line selection in an autodial number, the call uses your prime line (if you have one).*

## Using intercom as the line for Autodial

If you press the button with the  label as the line for an external autodial number, you must include a valid line pool access code or a destination code. If line pool access codes or destination codes are changed, remember to reprogram autodial numbers.

### Displays

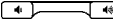
```
987_
QUIT  BKSP  OK
```

Continue to enter digits until the number is complete. Press  or **BKSP** to erase an incorrect digit. Press  or **OK** when you are finished.

```
Autodial full
```

The memory allotted to autodial numbers in your Norstar system is full.

```
Button erased
```

While programming external Autodial, you erased the button by pressing  or **OK** before entering any digits.

Enter digits  
QUIT OK

Enter the number you want to program (choosing the line first if necessary) exactly as you would if you were making a call.

Intercom #: \_  
QUIT

Enter the internal telephone number you want to program.

Invalid number

You are programming an internal autodial button and have entered a number that is not an internal number on your system. Enter a valid internal number. If the number you are entering is a destination code, use external autodial.

Press a button  
QUIT

Press the memory button you want to program.

Program and HOLD

Enter the number you want to program onto the button, then press .

Program and OK  
QUIT OK

Enter the number you want to program onto the button, then press  or **OK**. You may include a line or line pool selection in an autodial sequence by selecting the line before entering any digits.

Programmed

The number is stored on the button.

For other displays, see “Common feature displays” on page 229.



## Using Last Number Redial

 5

Press  5 to redial the last external number you dialed.

Last Number Redial records a maximum of 24 digits.



**Tip** - *If you have a programmed Last Number Redial button, you can use Button Inquiry ( \* 0 ), then press the Last Number Redial button followed by  to check the last number before you dial it.*

# Preventing a telephone from using Last Number Redial

Last Number Redial can be restricted at individual telephones.

You need the programming template found at the front of this guide. See “Getting started with Norstar” on page 13 for more information.

1. Press  \* \* 2 6 6 3 4 4 .
2. Press      (the default System Coordinator password).
3. Press  and enter the internal number of the telephone you want to program.
4. Press .
5. Press  three times. The display shows **Restrictions**.
6. Press  twice.
7. Press . The display shows **Allow last no:**
8. Press **CHANGE** to choose **Y** (Yes) or **N** (No).

## Displays

Hidden number

The last number you dialed was a speed dial number that displayed a name rather than the number. The number is dialed correctly, but you cannot see it.

No last number

You have not dialed an external telephone number since the last power interruption or system reset.



**Tip** - You can copy a number onto an autodial button using Last Number Redial.

## Using Speed Dial

Norstar provides two types of speed dialing: system and user.

- System Speed Dial programming allows you to assign three-digit speed dial codes to the external numbers your co-workers call most frequently.
- User Speed Dial programming allows individuals to program their own speed dial numbers.

Speed dial numbers are subject to the same restriction filters as regularly dialed numbers. Your installer or customer service representative can program system speed dial numbers to bypass dialing restrictions.

Speed dial numbers may include host system signaling codes.

## Changing and adding System Speed Dials

System Speed Dial codes are numbered from 001 to 255. The system coordinator assigns numbers to System Speed Dial codes for the entire system. See “Adding or changing a system speed dial” on page 29.



**Tip** - *There is no difference between using User Speed Dial and using System Speed Dial. They differ only in how you program them.*

## Adding or changing User Speed Dial

To add or change a User Speed Dial number on your telephone:



1. Press   .
2. Enter a three-digit code from 256 to 279 that you want to associate with a telephone number.
3. To include a line selection for this number, press the line or intercom button. To select a line pool, press a programmed line pool button, or press the button with the  label, and enter a line pool access code. For M7100/T7100 telephones, you can only select a line pool.



4. Enter the number you want to program.
5. Press  or OK.

## Displays

```
001:9_
CANCL  BKSP  OK
```

Continue entering the number you want to program. You can change the number by pressing BKSP or . When you are finished, press  or OK.

```
Enter digits
QUIT      OK
```

Enter the telephone number you want to program exactly as you would if you were dialing it normally. When you are finished, press  or OK.

```
Invalid code
```

You have entered a code outside the code range (001-255 for system, 256-279 for user).

```
No number stored
```

There is no number stored on the speed dial code you have dialed.

```
Program and HOLD
```

If you want to program a line or line pool selection for this speed dial number, select the line or line pool. Otherwise, enter the telephone number exactly as if you were dialing it normally. When you are finished, press .

```
Program and OK
QUIT      OK
```

If you want to program a line or line pool selection for this speed dial number, select the line or line pool. Otherwise, enter the telephone number you want to program exactly as if you were dialing it normally. When you are finished, press OK.

```
Select a line
```

There is no line associated with the speed dial number you are trying to use. Select a free external line or line pool and enter the speed dial feature code again.



```
Unknown number
```

The system cannot dial the number stored. Reprogram the number.



For other displays, see “Common feature displays” on page 229.

## Making a speed dial call

You can quickly dial external telephone numbers that have been programmed onto speed dial codes.

1. Press  .
2. Enter the appropriate three-digit speed dial code.

## Using Saved Number Redial

  

You can save the number of the external call you are on (provided you dialed the call) so that you can call it again later. Each telephone can save one number at a time with Saved Number Redial, not one number for each line.





**Tip** - You can copy a number onto an autodial button using Saved Number Redial.



## Saving a number

Press    while you are on the call.

Saved Number Redial records a maximum of 24 digits.

## Dialing a saved number

Press    when you are not on a call.

If you have a programmed Saved Number Redial button, you can use Button Inquiry (  ) to check the last number before you dial it.

# Preventing a telephone from using Saved Number Redial

Saved Number Redial can be restricted at individual telephones.

You need the programming template found at the front of this guide. See “Getting started with Norstar” on page 13 for more information.

1. Press         .
2. Press      (the default System Coordinator password).
3. Press  and enter the internal number of the telephone you want to program.
4. Press .
5. Press  three times. The display shows **Restrictions**.
6. Press  twice.
7. Press  twice. The display shows **Allow saved no:**.
8. Press **CHANGE** to choose **Y** (Yes) or **N** (No).

## Displays

Hidden number

You have saved a speed dial number that displays a name rather than the number. The number is dialed correctly, but you cannot see it.

No number saved

You have tried to save the number of an incoming call. You can only save numbers that you have dialed yourself.



# Handling many calls at once

## Using Hold

You can temporarily suspend a call by pressing .

When a call is on hold, its indicator flashes on all telephones that have access to the line. The call can be retrieved from any of these telephones.

On the M7100 or T7100 telephone,  alternates between two lines; one active, one on hold. These telephones cannot retrieve a call placed on hold by another telephone.



**Tip** - Answered Hunt Group calls can be placed on hold at the answering Norstar set. For more information on Hunt Groups see “Programming Hunt Groups” on page 155.

## Retrieving a held call

You can connect to a call on hold by pressing the flashing line button of the held call.

## Holding automatically

If your line has been programmed with full autohold, you can switch from one call to another and have your calls put on hold automatically.

Press the line button of the caller you want to speak to. Your current caller is put on hold automatically.

## Listening on hold

If you have been put on hold, you can hang up the handset while you wait for the other person to return.

1. Press .
2. Hang up the handset.
3. Press the line button of the call. You may hear indications from the far end that you are on hold (for example, tones or music).
4. When the person you were talking to returns you hear them through your telephone speaker. Lift the handset and talk.





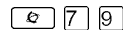

**Tip** - *If Automatic Handsfree has been assigned to your telephone, you can use the Handsfree/Mute feature instead of Listen on Hold.*

## Holding a call exclusively



You can put a call on Exclusive Hold so that it can be retrieved only at your telephone.

Press    or  . The line appears busy on all other telephones, and the call cannot be picked up by anyone else in the office.

### Displays

On hold: LINENAM

You have placed one or more calls on hold. The name of the line that has been held the longest is displayed.

## Using Call Queuing

☎ 8 0 1

If you have more than one call ringing at your telephone, you can choose the call that has the highest priority by pressing ☎ 8 0 1 .

Call Queuing answers incoming external calls before callback, camped, and transferred calls.

## Using system-wide call appearance (SWCA)

This feature allows a call to maintain an appearance on the System Wide Call Appearance (SWCA) buttons to a group of users for the life of the call. SWCA codes can be assigned to up to 16 program buttons with indicators on each telephone in a group.

See “Programming a feature code onto a memory button” on page 137 for general information about setting or changing key programming for a telephone. SWCA keys can be assigned to memory keys using ☎ \* 3 to assign the SWCA feature codes: ☎ \* 5 2 0 to ☎ \* 5 3 5 .

Refer to the *Compact ICS 6.0 Installer Guide* for information about determining how the system will assign calls to SWCA keys, and how the Hold feature will perform.

**Note:** Telephones without assigned SWCA keys can still retrieve a SWCA call by entering the feature code that was used to park the call, providing that they have a free intercom key with which to accept the call. However, there is no indication on these telephones to show which codes were used to park which call. This information can be communicated by the person who parked the call by using a voice call or by using the Page feature to provide a verbal alert.

A call can also be parked on the system by entering a SWCA code, if there are no assigned SWCA user keys on the telephone.

Each group telephone must either have a line appearance of the call coming in, or a free intercom button to be able to retrieve a SWCA call. The number of SWCA keys that can be assigned will depend on available buttons on the

telephone. T7316 and T7324N telephones provide the broadest use of this feature. Companion, M7000/T7000 and M7100N/T7100 telephones do not have line or intercom buttons, therefore, they cannot be assigned SWCA lines.

Your system administrator can configure the SWCA line buttons during the initial configuration of your telephone, in which case, you should have a list of which codes were used. Otherwise, you can use the Supervisor password to assign codes to memory keys with indicators.



**Tips** - *Since SWCA keys use the park feature, check with your system administrator to ensure that park is turned on for your system.*

*A SWCA call on park that exceeds the park timeout timer is released from the SWCA button and rings again at the original telephone.*

## Incoming calls

When you answer an external call, the system can react in one of two ways, depending on what settings were specified in system programming:

- the call may be transferred automatically to a free SWCA key when you answer the call. In this case, you need to put the call on Hold to free the line the call came in on.

OR

- you may need to press the a free SWCA button to transfer the call manually to a free SWCA key. In this case, when you transfer the call, the line the call came in on is released.

When you put a call on hold, the system can react in one of two ways if you have SWCA keys defined:

- when you put the call on Hold, the call transfers to a SWCA key and all the other extensions with corresponding SWCA keys display a flashing indicator beside the button. The call can be picked up at any other extension. If the call automatically transferred to a SWCA key when it was answered, then this option puts the call on hold at the same key.



OR

- when you put the call on Hold, it stays on hold on the line that it came in on. To make the call available to other extensions, press a free SWCA key.

Calls with appearances on SWCA keys show a solid indicator when the call is active. On the extension where the call is active, an Intercom or Line button also becomes active.

### SWCA indicators, call status states (auto assign)

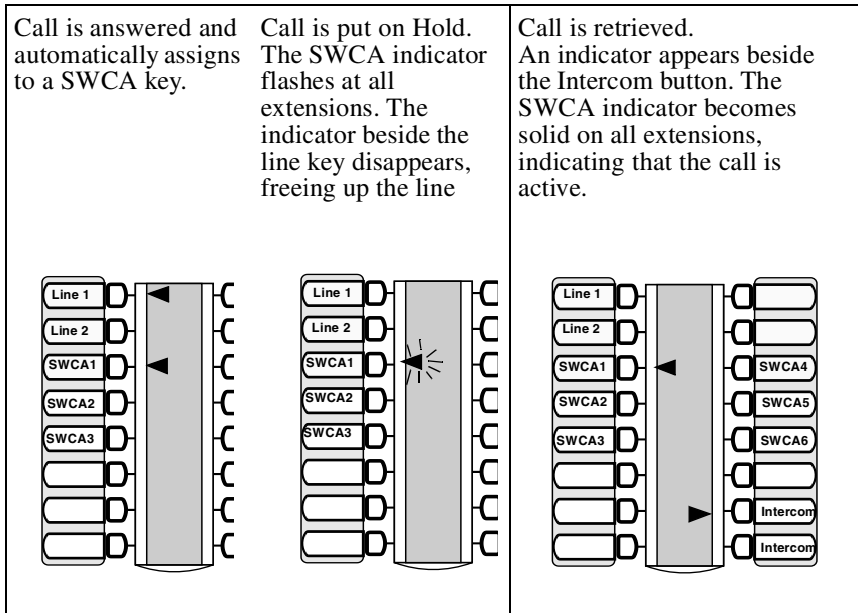

### Outgoing calls

When you make an outgoing call using the intercom key on your telephone, the call is automatically transferred to the first available SWCA key. Solid indicators appear beside the intercom button and the SWCA key on your telephone. All other telephones in the group also see a solid indicator beside the SWCA key, indicating that the line for that key is in use. If you put the call on hold, the SWCA key indicator fast-flashes on your telephone, and slow-flashes on the other telephones in the group. The call can then be picked up by any other telephone in the group.

## No free call keys

If all the SWCA keys are currently occupied when a new call comes in, you can still put the call on Hold.

- If a SWCA key has been freed up between the time you answered the call, and when you want to put the call on Hold, the call will transfer to the free SWCA key and act as described in “Incoming calls” on page 96.
- If all SWCA keys are still occupied when you put the new call on Hold, the call will be held at your telephone on the line it came in on. When a SWCA key becomes free, you can take the call off hold and press the free SWCA key so the call has a group-wide appearance.

These principles also apply to outgoing calls.



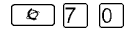

# Transferring calls

## Using the transfer feature



Transfer allows you to direct a call to a telephone in your Norstar system, within the Norstar network, or external to Norstar.

### Transferring a call

1. Press   .
2. Call the person to whom you want to transfer the call.
3. If you want to talk to the person to whom you are transferring the call, wait for them to answer, and speak to them before proceeding.
4. When you are ready to complete the transfer, press  or **JOIN**.

You cannot use Last Number Redial, Saved Number Redial, a speed dial code, Priority Call or Ring Again to dial the number for a transfer.

Depending on how a private network call is routed, it may not always be possible for the system to return a transferred call to you if the transferred call is not answered. When transferring a call to a private network destination, stay on the line until the person to whom you are transferring the call answers.

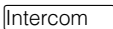
You cannot use the Line Pool feature code to access a line pool for a transfer. To use a line pool, use a programmed line pool button, or press the button with the  label and enter a line pool access code.

If you have an auxiliary ringer programmed to ring for calls on an external line, and you transfer a call on that line without announcing the transfer, the auxiliary ringer rings for the transferred call.

## Transferring external calls

If an external call is transferred to a busy telephone, or not answered after a few rings, the call automatically rings again at the telephone from which it was transferred, and the display indicates that the telephone was busy or that no one answered.

When transferring an external call to an external number, the external call you are trying to transfer must be an incoming call on a disconnect supervised line.





While on a conference call, you can remove yourself from the conference and connect the other two callers using the Transfer feature. However, if both of the other people are from outside the system, at least one of the outside callers must have called you and both of the outside calls must be on disconnect supervision lines.

**Note:** Transfer via Hold on DID lines is not supported. Once a call is answered, the line appearances on all other sets are free immediately to take other calls. This allows a greater number of calls to be received. Use the Call Park feature to transfer a call.

In certain situations, you may experience lower volume levels when transferring an external call to an external person, or when transferring two external callers from a conference call.

## Canceling a transfer

You can reconnect to the person you are trying to transfer at any time before the transfer is complete.

1. Press     or **CANCL**.
2. If you are not reconnected to your original call, press  and then press the line key of the original call, which is now on hold.

### Displays

```
21>22
CANCL  RETRY  JOIN
```

You are talking to the person you want to transfer the call to. Press **RETRY** if you decide to transfer the call to someone else. Press  or **JOIN** to transfer the call.

21 no reply  
CALLBACK

The person to whom you tried to transfer a call did not answer. Press **CALLBACK** or the flashing line button to reconnect to the call. On the M7100 or T7100 telephone, lift the handset.

Do not disturb  
CANCL RETRY JOIN

The person to whom you tried to transfer a call has Do Not Disturb active on their telephone. Press **JOIN** to transfer the call anyway. Press **RETRY** to transfer the call to someone else. Press **CANCL** or the flashing line button to reconnect to the call (on the M7100 or T7100 telephone, press **[ ] # [7] [0]**).

Invalid number  
CANCL RETRY

You entered an invalid internal number. Press **RETRY** and enter the number again.

Line001 hung up

The external caller you were transferring hung up before the transfer was complete.

Line001>21  
CANCL RETRY JOIN

Press **JOIN** to transfer the call on line 001 to telephone 21. Press **RETRY** if, after talking to the person at extension 21, you decide to transfer the call to someone else.

Not in service  
CANCL RETRY

The telephone to which you are trying to transfer a call is out of service.

Restricted call  
CANCL RETRY

You cannot transfer the call because of telephone or line restrictions.

Still in transfer  
CANCL RETRY

Complete the transfer in progress before you access a new feature, answer another alerting call or select an outgoing line.

Transfer denied  
CANCL RETRY

Your transfer cannot be completed for one of these reasons:

- All the resources needed to perform a transfer are in use. Try again later.
- You have tried to transfer an external call to another external party. Some restrictions apply.
- You cannot transfer your conference call.

Transfer to:2\_  
CANCL RETRY

Press **RETRY** if you entered the wrong internal number or if the person to whom you are transferring the call is unavailable.

For other displays, see “Common feature displays” on page 229.

# Using Camp-on

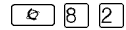

You can transfer an external call to another telephone, even if all its lines are busy.

1. Press .
2. Dial the number of the telephone you want to camp the call to.

Camped calls appear on a line button on the receiving telephone, if one is available. If there is no line button available, you receive a message on the display and hear Camp tones.

Each Norstar telephone can handle only one camped call at a time.

## Displays

21 Camp max  
CALLBACK

You tried to camp a call to a telephone that already has a camped call. The call has come back to you. Press the CALLBACK button or the line button to reconnect to the call. On M7100/T7100 telephones, just pick up the handset.

21 DND  
CALLBACK

The person to whom you redirected a call has Do Not Disturb active on the telephone. The call has come back to you. Press the CALLBACK button or the line button to reconnect to the call. On M7100/T7100 telephones, just pick up the handset.

Camp denied

You have tried to camp an internal call. You can only camp external calls.

Camp to:  
CANCL

Dial the number of the internal telephone to which the call is sent.

Camped: 21  
CALLBACK

The telephone to which you camped a call did not answer the call. The call has come back to you. Press CALLBACK or the line button to reconnect to the call. On M7100/T7100 telephones, just pick up the handset.

Line001 hung up

A call you camped has come back to you, but the caller hung up before you could reconnect.

Not in service  
CALLBACK

The telephone to which you have camped a call is out of service or is being used for programming. The call has come back to you. Press **CALLBACK** or the line button to reconnect to the call. On M7100/T7100 telephones, just pick up the handset.

Release a call

The line that the camped call is on is in use or that line does not appear at your telephone. Release the line or release an internal line.

For other displays, see “Common feature displays” on page 229.

## Parking a call

☎ 7 4

You can suspend a call so that it can be retrieved from any telephone in your system.

1. Press ☎ 7 4 .
2. Use the Page feature (☎ 6 0 ) or press **PAGE** to announce the retrieval code displayed by your telephone.

## Retrieving a parked call

1. Select an internal line. (On M7100/T7100 telephones, pick up the handset.)
2. Dial the Call Park retrieval code.

## Using Call Park

When you park a call, the system assigns one of nine codes for the retrieval of the call. These codes consist of the Call Park prefix, which may be any digit from 0 to 9, plus a two-digit call number between 01 and 09. For example, if the Call Park prefix is 4, the first parked call is assigned Call Park retrieval code 401.

The Norstar system assigns Call Park codes in sequence, from the lowest to the highest, until all the codes are used. This round-robin approach means that a greater variety of codes are used, which makes it easier for a call to reach the right person when more than one incoming call is parked.

The highest call number, which is the Call Park prefix followed by 09, is used only by telephones or devices connected to the system using an analog terminal adapter (ATA).

Your installer or customer service representative programs both the Call Park prefix and the delay before parked calls are returned to the originating telephone. External calls parked for longer than the programmed delay are returned to your telephone.



**Tip** - Answered Hunt Group calls are parked in the same manner as other calls. For more information about Hunt Groups see “Programming Hunt Groups” on page 155.

Call Park can be disabled by your installer or customer service representative.

## Displays

Already Parked

The person you were talking to has already parked your call. You cannot park the same call.

Get call first

You have attempted to use Call Park with no active call on your telephone. If the call you want to park is on hold, reconnect to it before you park it.

Invalid number

You have entered an invalid retrieval code.

No call on: 101

There was no call on the retrieval code you entered.

Park denied

You have tried to park a conference call. Split the conference and park the calls separately. The person who retrieves the calls can reconnect the conference.

Parked on: 402

PAGE EXIT

Record the code shown. Use Page (  ) or press **PAGE** to announce the call and its retrieval code.

Parking full

All available retrieval codes are in use. Transfer the call or take a message instead.

For other displays, see “Common feature displays” on page 229.



## Using Callback

When you direct a call you have answered to another telephone, the system monitors the call to make sure it is answered. If no one answers the call within a set length of time, the system directs it back to you.

Callback generates a variety of displays. Most occur after a set delay and are listed in the index. Some occur immediately if the telephone to which you are directing a call is out of service or otherwise unavailable. These are listed with the descriptions of the specific features like Transfer or Camp-on.



# Forwarding your calls

## Forwarding your calls to another Norstar telephone

Press **[Fwd] 4** and enter the number of the internal telephone to which you want your calls forwarded.

Use Line Redirection to forward calls outside the system. Line redirection takes precedence over Call Forward.

## Canceling Call Forward

Press **[Fwd] # 4**.

## Using Call Forward at your telephone

When you use **[Fwd] 4**, all calls go to the destination you select, regardless of how Forward on busy and Forward no answer are programmed.



**Tip** - *If your Norstar set is a member of a Hunt Group, the Call Forward all calls setting is overridden by the Hunt Group routing for Hunt Group calls. For more information about Hunt Groups see “Programming Hunt Groups” on page 155.*

If the telephone to which you forwarded your calls does not have the same external lines as your telephone, the forwarded calls appear on intercom buttons.

If a call is forwarded, it does not ring. However, the line indicator flashes on the telephone. You can answer the call by pressing the button next to the flashing indicator.



**Tip** - *If you are one of a group of people who regularly forward their calls to one another, be aware that it is possible to set up forward loops where a call is forwarded from one telephone to another in a circle, and is never answered anywhere.*

## Overriding Call Forward

If you call someone who has their calls forwarded to you, your call rings at that receiving telephone even though that telephone has been set to forward calls to you.

## Changing the automatic Call Forward settings for a telephone

Call forwarding occurs automatically when a call is not answered or the line is busy. These automatic options are changed in programming.

For step-by-step instructions, see “Change where a call goes when there is no answer” on page 35.

## Changing Forward no answer

Forward no answer redirects unanswered calls to another telephone on your Norstar system.



**Tip** - *If the Norstar set is a member of a Hunt Group, the Call Forward no answer feature is overridden and the Hunt Group call continues to ring until the hunt time has expired. For more information on Hunt Groups see “Programming Hunt Groups” on page 155.*

For step-by-step instructions for changing Forward no answer see “Change where a call goes when there is no answer” on page 35. Line Redirection takes precedence over Forward no answer.

## Changing the delay before a call is forwarded

You can assign the number of times that the incoming call rings at your telephone before the call is forwarded. To estimate the delay time in seconds, multiply the number of rings by six.

For step-by-step instructions, see “Change the number of times the telephone rings before it is forwarded” on page 36.

## Forward on busy

Forward on busy redirects your calls to another telephone on your Norstar system when you are busy on a call, or when you have Do Not Disturb activated at your telephone.

For step-by-step instructions, see “Making changes to Call Forward on Busy” on page 37.

Line Redirection takes precedence over Forward on busy. Calls that are redirected by Line Redirection are not affected by any Call Forward features or Call Forward programming.

Telephones that have Forward on busy active can receive priority calls. If you are busy on a target line call, another call to that target line is redirected to the prime telephone for that target line.



**Tip** - *If the Norstar set is a member of a Hunt Group, the Call Forward on busy feature is overridden and the Hunt Group call continues to ring until the hunt time has expired. For more information on Hunt Groups see “Programming Hunt Groups” on page 155.*

## DND on Busy

When you are busy on a call and a second call comes in, your telephone rings softly to alert you to the second call. If you find this second ring distracting, you can have the system prevent a second call from disturbing you by assigning Do Not Disturb (DND) on Busy to your extension.

When DND on Busy is turned on for the set, internal and private network callers hear a busy tone instead of ringing when you are on the telephone. External callers are transferred to the prime set used in your system.

For step-by-step instructions, see “Making Changes to Do Not Disturb on Busy” on page 38.

If you use DND on Busy, the line indicator for an external incoming call flashes, but your telephone does not ring.

Forward on busy takes priority over DND on Busy.

If an external call uses a target line, the call is processed according to the programming of the target line. If the target line is busy, the caller may hear a busy tone or be routed to the prime set for the target line regardless of the DND on Busy programming for the telephone.



**Tip** - *If a Norstar set is a member of a Hunt Group and the set activates this feature, the set does not receive notification of incoming Hunt Group calls while on a call. The DND on busy feature overrides the Hunt Group. For more information on Hunt Groups see “Programming Hunt Groups” on page 155.*

## Call Forward and Voice Mail

If you have a voice mail system and want it to pick up unanswered calls automatically

- use the internal number of your voice mail as the destination when you program Forward no Answer and Forward on busy,
- or
- make the ring delay greater than the delay used by your voice mail system, if your voice messaging system or service automatically retrieves calls.

### Displays

Forward denied

There are several reasons why you may get this message. For instance, you cannot forward your calls to a telephone that has been forwarded to your telephone.

Forward>21

CANCL

Your calls are being forwarded to telephone 21.

Not in service

Two or more telephones are linked in a forwarding chain, and one of them is out of service or is being used for programming.

For other displays, see “Common feature displays” on page 229.



## Line Redirection

Line Redirection allows you to send your external calls to a telephone outside the office. You may choose to redirect all your external lines or only some of them.



Line Redirection takes precedence over the Call Forward feature. If both features are active on a set, incoming external calls on redirected lines are routed to the specified Selective Line Redirection (SLR) external destination. Incoming internal calls are forwarded to the specified Call Forward destination.



You cannot use the Line Redirection feature at either M7100 or T7100 telephones, or a telephone connected to an ATA.

## Turning on Line Redirection

1. Press   .
2. Select the outgoing line to be used for redirected calls.
3. Enter the number to which calls are to be redirected (the ways you can do this are listed below).
4. Select the lines to be redirected.

Enter the telephone number to which you want to redirect calls by using one of the following methods.

- Press an external autodial button.
- Enter an external telephone number (using no more than 24 digits) then press  or **OK**.
- Press  or **OK** if the line you have chosen as the outgoing line is a private network line that does not require you to dial digits.





If you use **ALL** to redirect all your lines, it is important that you wait until all the lines on your telephone light up before pressing  or **OK**. If you press  or **OK** before all the lines light up, those lines not lit are not redirected.



**Tip** - *The line chosen for redirecting calls on other lines can be used normally when it is not busy on a redirected call. To avoid redirection failing because the chosen line is in use, choose a line pool with several lines in it.*

*The system does not check that the number you give for line redirection is a valid one. If you redirect to an invalid number, redirection fails. Using an autodial button to enter the redirection number helps avoid this possibility. An autodial button used for line redirection must be programmed to use a specific line.*

## Canceling Line Redirection

1. Press    .
2. Select the lines you no longer want to be redirected.



## Allowing a telephone to redirect calls

You can turn the redirect calls feature on and off.

You need the programming template found at the front of this guide. See “Getting started with Norstar” on page 13 for more information.

1. Press  \* \* 2 6 6 3 4 4 .
2. Press      (the default System Coordinator password).
3. Press  and enter the internal number of the telephone you want to program.
4. Press  twice.
5. Press  three times. The display shows **Allow redirect:**.
6. Press **CHANGE** to select **Y** (Yes) or **N** (No).

## Turning the redirect ring for a telephone on or off

You can program a telephone to ring briefly (200 milliseconds) when a call is redirected on one of its lines.

You need the programming template found at the front of this guide. See “Getting started with Norstar” on page 13 for more information.

1. Press  \* \* 2 6 6 3 4 4 .
2. Press      (the default System Coordinator password).
3. Press  and enter the internal number of the telephone you want to program.
4. Press  twice.
5. Press  twice. The display shows **Redirect ring:**.
6. Press **CHANGE** to select **Y** (Yes) or **N** (No).



**Tip** - If a telephone has redirect ring enabled, it rings briefly for redirected calls on one of its lines even if another telephone set up the line redirection.

## Displays while redirecting lines

Intercom

You selected the intercom button as the facility to place the call on. Enter a line pool code or a destination code.

Line Redirection

QUIT ADD REMOVE

Press **\*** or **ADD** to begin redirection. Press **#** or **REMOVE** to cancel a previous redirection.

No line to use

You have one external line on your telephone, but you need a second line to perform line redirection. Redirect your external line using a line pool as the outgoing line.

Outgoing line

You are attempting to redirect a line and the line you have chosen is the outgoing line you have selected as a destination. You cannot redirect a line to itself. Select another line.

Pool code: \_

QUIT

Enter a valid line pool access code.

Redir by 21

OVERRIDE

You have attempted to redirect a line, but someone else has already redirected that line. Press **\*** or **OVERRIDE** to override the previous redirection and redirect the line as you want.

Redirect denied

You can redirect calls only on individual lines.

Select line out

QUIT

Select the line to be used to redirect calls out of the system.

Select line(s)

QUIT ALL

Press the lines to be redirected. To undo a line selection, press it again. Press **ALL** to redirect all your lines.

Select line(s)

ALL OK

Continue to press the lines to be redirected. Press **OK** or **OK** when you are finished.

Unequipped line

The line you are attempting to redirect cannot be redirected because the hardware does not support redirection.

## Displays while canceling redirection

```
Select line(s)
QUIT      ALL
```

Press the lines that are no longer to be redirected. The lines light up as you press them. Once you cancel redirection for a line you cannot restore it by pressing the line again. Press ALL to cancel redirection for all your lines. When you are finished, press  or OK.

```
Select line(s)
                ALL      OK
```

Continue to press the lines that are no longer to be redirected. Press  or OK when you are finished.

For other displays, see “Common feature displays” on page 229.

## How Line Redirection is different from Call Forward



Call Forward forwards all calls that arrive at a particular telephone to another telephone within the Norstar system or over external ISDN lines.

Line Redirection redirects only the lines you specify, no matter which telephones they appear on, to a telephone outside the Norstar system. Line Redirection takes precedence over Call Forward.

## Using Line Redirection

You redirect lines at a telephone, but once redirected, the lines are redirected for the entire system.

You can only redirect lines that appear at line buttons on your telephone.

You can answer the telephone if it rings while you are in the middle of programming Line Redirection, but none of the Norstar call handling features are available until the feature times out. If you need to use a Norstar feature to process the call, quit Line Redirection programming by pressing . Do not press  or you disconnect the call you are trying to process.

While you are programming Line Redirection you do not receive any indication of calls that do not actually ring at your telephone.

Be careful to avoid redirection loops. If for example, you redirect your lines to your branch office and your branch office redirects its lines to you, you

can create a redirection loop. If these calls are long distance, you end up paying charges.

In certain situations, callers may experience lower volume levels when you redirect calls to an external location.

# Communicating in the office

## Paging

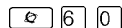

Paging allows you to make announcements over the Norstar system using the telephone speakers, or your loudspeaker system, if one is available.

### Making a page announcement

1. Press .
2. Choose a page type. Page types are:
  - 1 through the telephone speakers (internal page)
  - 2 through an external speaker (external page)
  - 3 both internal and external (combined page)
3. If necessary, choose a zone.
4. Make your announcement.
5. Press .



**Tip** - *Instead of entering the Page feature code followed by the page type, you can enter the following shortcut codes.*

- |          |                       |
|----------|-----------------------|
| Internal | and zone (1 to 3)     |
| External | (code 2 has no zones) |
| Combined | and zone (1 to 3)     |

## Activating and deactivating the ability to page

You need the programming template found at the front of this guide. See “Getting started with Norstar” on page 13 for more information.

1. Press  \* \* 2 6 6 3 4 4 .
2. Press      (the default System Coordinator password).
3. Press  and enter the internal number of the telephone you want to program.
4. Press  twice.
5. Press  seven times. The display shows **Paging**.
6. Press **CHANGE** to select the setting: **Y** (Yes) or **N** (No).

## Creating page zones

Each telephone can be assigned to one of three zones for receiving pages.



**Tip** - Hunt Group DNs cannot be included in a page zone. For more information on Hunt Groups see “Programming Hunt Groups” on page 155.

You need the programming template found at the front of this guide. See “Getting started with Norstar” on page 13 for more information.

1. Press  \* \* 2 6 6 3 4 4 .
2. Press      (the default System Coordinator password).
3. Press  and enter the internal number of the telephone you want to program.
4. Press  twice.
5. Press  six times. The display shows **Page Zone**.
6. Press **CHANGE** to select the setting: **1**, **2**, **3**, or **None**.

You can make a telephone part of a page zone only if the telephone has paging set to **Y** (Yes).

A zone is any set of Norstar telephones that you want to group together for paging, regardless of their location.

Your installer programs whether a tone sounds before a page begins, and the maximum number of seconds a page can last before it is automatically turned off.



**Tip** - *Make sure that everyone who needs to make page announcements has a list showing which telephones are in which page zones.*

## Displays

Enter zone:\_  
ALL

Enter the desired page zone number (1- 3) or press ALL.

Invalid zone

You have entered a page zone code that is not between 1 and 3.



Page choice:  
SETS SPKR BOTH

Select the type of page you want. See the list in "Making a page announcement".

Page timeout

The time allotted for paging has expired.

Paging ALL

You are making a page. The display shows the page zone you have chosen. Press  or  when you are finished.

Paging busy

A page is already being made in the page zone you have requested.

For other displays, see "Common feature displays" on page 229.



**Tip** - *You can make an announcement to one person by placing a voice call to their telephone.*

## Using Page with external paging equipment

When you make a page that uses external paging equipment (external page or combined page), the Long Tones feature is automatically activated for the external paging system only. This allows you to control optional equipment with the Long Tones feature.

## Sending messages using the display

The Messages feature allows you to leave a message on the display of another Norstar telephone, and indicates if you have any messages waiting. The Messages feature uses a message waiting list to keep a record of your internal messages and your (external) voice mail messages (if you subscribe to a voice message service with visual message waiting indication).



### Sending a message



You can leave a message on the display of another telephone in your Norstar system. You can send up to four messages to different telephones, including your voice message center.

If your telephone is a direct-dial telephone or a central answering position (CAP), you can send up to 30 messages.

If your reply to a message is forwarded or is answered at another telephone using the Call Pickup feature, the message remains on your telephone until you cancel it or successfully contact the telephone that sent the message.

1. Press  .
2. On a telephone with a two-line display, press **ADD**. (This step is not necessary on a telephone with a one-line display.)
3. Enter the internal number of the person you want to send the message to. The display shows **Message for you**.



## Canceling a message you have sent

1. Press **[⏪] [#] [1]**. The display shows **Cancel for:**.
2. Enter the internal number of the person to whom you sent the message.

## Viewing your messages

**[⏪] [6] [5]**

You can receive up to four messages from different telephones, including your voice message center. A single message from your voice message center may pertain to several voice messages.

On a telephone with a one-line display

1. Press **[⏪] [6] [5]**. The display shows the first message.
2. Press **[\*]** or **[#]** to move through your messages.

On a telephone with a two-line display

1. Press **MSG**. The display shows the first message you received.
2. Press **NEXT** to move through your messages.

## Replying to a message

You can call the person (or your voice message center) who sent a message while you are viewing the message.

On a telephone with a one-line display

Press **[0]**.

On a telephone with a two-line display

Press **CALL**.

If you want to call your voice message center using a line other than the programmed line, exit your message list and dial the voice message center telephone number.

## Removing items from your message list

You can erase a message while you are viewing it in your message list. If the message is from your voice message center, this only erases the message notification at your telephone. You need to erase the voice message at your voice message center. Refer to your voice message center documentation.

On a telephone with a one-line display

Press .



On a telephone with a two-line display

Press ERASE.

## Viewing messages you have sent



On a telephone with a two-line display, you can view the messages you have sent.

1. Press  .
2. Press SHOW to display your first sent message.
3. Press NEXT to move through your sent messages.

### Displays

Cancel denied

You have entered an invalid number when attempting to cancel a message.

Cleared>LINENAM  
NEXT

You have cleared an external message from your message waiting list. The message itself exists in your voice message center until you erase it there.

In use: 21

You are trying to call from your message waiting list. The line that you are trying to use is being used by the identified Norstar user.

L001:LINENAMUM=9  
NEXT CALL CLEAR

You are viewing your message list. The display shows the number and name of the line that was used for your voice mail message.

Message denied

You have tried to send a message to an invalid internal number or to a telephone that is out of service.

Message list

SHOW      ADD      EXIT

SHOW appears only if you have outstanding messages. Press SHOW to review messages you have sent. Press ADD to send a new message.

Message to:

Enter the internal number of the telephone to which you want to send a message.

Messages & Calls

MSG      CALLS

You have one or more messages and one or more new Call Logs. Press ☐ 8 0 6 to change the first line of the display to the current time and date.

No button free

You have no line button free with which to reply to a message.

No number stored

There has been no number programmed for the voice message center. Contact your voice messaging service provider.

Start of list

NEXT

You are at the beginning of your list of messages. Press NEXT to move through your messages.

Their list full

You are trying to send a message to a user whose message waiting list is full.

Your list full

You have tried to send a message but your telephone list of sent messages is full. Cancel one of the messages you have sent, if possible, or wait until you have received a reply to one of those messages.

For other displays, see “Common feature displays” on page 229.

## Using Voice Call

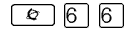



You can make an announcement or begin a conversation through the speaker of another telephone in the system.



**Tip** - *Hunt Groups cannot accept voice calls. Answer buttons have no appearances for voice calls, and the set does not ring for voice calls. For more information on Hunt Groups see “Programming Hunt Groups” on page 155. For more information about Answer buttons see “Answer buttons” on page 52.*

## Making a Voice Call

Press   .

### Muting Voice Call tones

When a voice call begins at your telephone, you hear a beep every 15 seconds as a reminder that the microphone is on.

To stop it from beeping, pick up the handset or press the button labeled Handsfree/Mute.

## Answering a Voice Call without touching your telephone

If Handsfree Answerback is assigned to your telephone, you can respond to a voice call without touching the telephone. This feature is not available to the M7100 or T7100 telephone.

When someone makes a voice call to you, simply start talking. The set microphone picks up your voice.



**Tip** - *Once you have answered a voice call, you can put it on hold, transfer it, or otherwise treat it as a normal call.*

# Preventing Voice Calls to your telephone using Voice Call Deny

Press **[☎] [8] [8]**. Voice calls ring like regular internal calls. Your other calls proceed normally.

## Canceling Voice Call Deny

Press **[☎] [#] [8] [8]**.

### Displays

Dial voice call

Dial the internal number or press the internal autodial button of the person to whom you want to speak.

Microphone muted

Your handsfree microphone is muted. Press the button labeled Handsfree/Mute or pickup your handset to respond to the voice call.

No voice call

The telephone receiving the call cannot accept voice calls for one of the following reasons: it is active or ringing with another call; Call Forward is turned on; Do Not Disturb is turned on; Voice Call Deny is turned on; it is not a Norstar telephone. Your call proceeds automatically as a regular ringing call.

Voice call

The line is open for you to speak.



# Tracking your incoming calls

## Using Call Log

Telephones can automatically log Call Display information for calls on an external line. The line must appear on that telephone but it does not have to be a ringing line.

If your system is equipped with the appropriate equipment and you have subscribed to the call information feature supplied by your service provider, you are able to capture information about incoming callers in your call log. The same feature is supplied by an ISDN service package that comes with calling line identification (CLID).

Call Log creates a record of incoming external calls. For each call the log could contain:

- sequence number in the Call Log
- name and number of the caller
- indication if the call was long distance
- indication if the call was answered (and identity of who answered it)
- time and date of the call
- number of repeated calls from the same source
- name of the line that the call came in on

Call Log can help you to

- keep track of abandoned or unanswered calls
- track patterns for your callers (for example volume of calls and geographical location of calls)
- record caller information quickly and accurately
- build a personal telephone directory from log items

The long distance indicator and the caller name and number, may not be shown in the log, depending on the Call Display services provided by your local telephone company and the local telephone company of the caller.

To use the features on the following pages, your telephone must have spaces available in its Call log. Your installer or customer service representative programs each telephone with an appropriate number of spaces.

## Call Log options

\* 8 4

You can select the type of calls to be stored in your Call Log. Choose from four Autolog options: **No one answered**, **Unanswered by me**, **Log all calls**, **No autologging**.

1. Press  \* 8 4 . The current option displays.
2. Press  # or **NEXT** to change the option.
3. Press  or **OK** to select the display option.

## Logging a call manually

8 1 3

If your calls are not automatically logged, you can manually log call information when you are connected to an external call. Storing information for your current call can be helpful in many situations. For example, you may want to:

- record a caller information without using paper and pencil
- record only selected calls that you choose, as opposed to using Call Log automatically
- quickly record caller information before a caller hangs up

Press  8 1 3 to log an external call manually.



## Deleting old log items

8 1 5

Your log has a set number of items that it can hold. When it becomes full, new calls cannot be logged. When your log is full, Autobumping automatically deletes the oldest Call Log item when a new call is logged.

Press 8 1 5 to enable autobumping.

Press # 8 1 5 to disable autobumping.

## Viewing your Call Log

8 1 2

To view your log

1. Press 8 1 2. The display shows the number of previously read items (old) and the number of new, unread items (new) in the log.
2. Press or **OLD** to view old items; press or **NEW** to view new items.
3. Press or **RESUME** to display the last item you viewed, the last time you viewed your Call Log.

Names and numbers for external callers are displayed only if you have subscribed to Call Display services from your local telephone company.

## Viewing a Call Log item



Press or **MORE** to view the information for a call log item.

## Erasing log items

You should routinely erase log items that you have read, to make space for new items in your log.

1. Display the item you want to erase.
2. Press or **ERASE**.
3. Press to exit.

If you accidentally erase an item, you can retrieve it.

1. Press  or **UNDO** immediately after accidentally erasing an item.
2. Press  to exit.



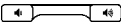

## Making a call using Call Log

You may find it helpful to place calls from within your Call Log. The number stored for each call may vary depending on the type of call. For example, if the call was placed from a Centrex or PBX system, the first few numbers may need to be trimmed before you can make the call. If the number you want to call is long distance, or if you want to use a line pool, you may need to add numbers.





To place a call

1. Display the log item for the call you want to place.
2. Display the associated telephone number.
3. Press  or **TRIM**, once for every digit that you want to remove.
4. Dial any extra digits required.
5. Press an external line or line pool button.
6. Lift the handset. (This is not necessary if Handsfree is programmed at your telephone.) The displayed number is dialed.

## Creating a password to your Call Log

You have the option of accessing your Call Log through a password.

1. Press    . The display shows **New Password:**.
2. Enter your four-digit password. The display shows **Repeat New:**.
3. Re-enter your four-digit password. The display shows **Password changed**, which confirms that your password has been assigned.

To enter Call Log using your password

1. Press **[\*] [8] [1] [2]** to enter Call Log. If you have programmed a password, the display shows **Password:**.
2. Enter your four-digit password.

If you forget your Call Log password, it can be deleted in programming. See “Using passwords” on page 202.

## Changing your Call Log password

**[\*] [8] [5]**

1. Press **[\*] [8] [5]**. The display shows **Old Password:**.
2. Enter your old password. The display shows **New Password:**.
3. Enter your new four-digit password. The display shows **Repeat New:**.
4. Re-enter your password. The display shows **Password changed**, which confirms that your password has been changed.

## Deleting an assigned password

**[\*] [8] [5]**

1. Press **[\*] [8] [5]**. The display shows **Old Password:**.
2. Enter your old password. The display shows **New Password:**.
3. Press **[OK]** or **OK**. The display shows **No Pswd assigned**, which confirms that your password has been deleted.

## Programming a telephone to log calls automatically

Your installer or customer service representative can program each telephone to log calls coming in on a line automatically.

### Displays

1:Unknown name

The caller's name is unavailable.

1:Unknown number

The caller's number is unavailable.

12:KATE SMITH  
NEXT ERASE MORE

\_ indicates a new item.

12KATE SMITH  
NEXT ERASE MORE

] indicates that the call was answered.

12SKATE SMITH  
NEXT ERASE MORE

§ indicates a long distance call.

49/1234567890123  
NEXT ERASE MORE

✓ indicates that the stored number has been shortened to its final 11 digits. Press  or MORE to display additional information about the call.

Call(s) bumped

One or more log entries have been deleted by the Autobumping feature while you are looking at the Call Log.

Hold or release

Hold or release your active call before entering Call Log.

In use: SETNAME

The external line is in use.

Jan 4 9:00a 3X  
NEXT ERASE MORE

The repeat call counter, shown along with time and date, indicates the number of calls you have received from the same caller.

Line001 ]27  
NEXT ERASE MORE

This call was answered at another telephone (27).



Line001 ]Logit  
NEXT ERASE MORE

This call was logged manually.

Line001  
NEXT ERASE MORE

This call was not answered.

Messages & Calls  
MSG CALLS

There are one or more items in your message waiting list, and there are one or more new items in your Call Log. Press    to change the first line of the display to the current time and date.

New calls begin

You have viewed your last old log item and are now viewing your new log items.

No info to log

No information is available for the call.

No log assigned

No log space has been assigned to the telephone.

No resume item

The resume item has been removed because of Autobumping, repeat call update, or log reallocation while you are looking at the Call Log.

For other displays, see “Common feature displays” on page 229.

## Using Voice mail

If you subscribe to a voice message service outside your office, you can access that service through your Norstar system. Your installer or customer service representative programs your Norstar telephone to indicate when you have a voice message waiting on a particular line.

To find out if your external voice message service works with Norstar, or if you have any problems with your service, contact your voice message service provider.



# Customizing your telephone

## Finding out what a button does using Button Inquiry

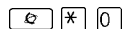

You can check the function of any line, intercom, or programmed button on your Norstar telephone by pressing . On the M7100 or T7100 telephone, Button Inquiry shows your internal number followed by the function assigned to your single memory button.

### Displays

```
001 <LINENAME>
      SHOW      OK
```

The display shows the number and name of the line. Press SHOW to view the redirection status of the line.

```
123456789012345...
      VIEW→     OK
```

Press or press VIEW→ or ←VIEW to view a number that is too long to fit on the display. Press or OK when you are done.

```
21 <SETNAME>
NEXT  VIEW→
```

The display shows the directory number of the telephone, and the assigned name. Press NEXT to see the first line assigned to ring at the intercom button.

```
<Feature name>
      SHOW      OK
```

The name of the feature assigned to a button is displayed when you press the button. Press or SHOW for additional information.

```
Press a button
EXIT
```

Press the button you want to check. Press or EXIT when you are finished.

For other displays, see “Common feature displays” on page 229.

# Making the display darker or lighter using Contrast adjustment

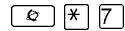

1. Press .
2. Press a number on the dialpad to choose the contrast level you like best.

On a two-line telephone, you can use the UP and DOWN display buttons to adjust the contrast.

The number of contrast levels available varies from one telephone model to another.

## Changing the language on the display

You can select the language used on the display of each Norstar telephone. Which languages are supported depends on the profile for your system. Profile 1, the default profile, supports three languages: English, French and Spanish. Button caps are available for each language. When your system is first installed, all telephones use English.

If you program on to a memory button, you can then simply press the button until the language you want appears on the display. You cannot program or onto a memory button.

### English

Press .

### French

Press .

### Spanish

Press .





# Programming a feature code onto a memory button









You can program a feature code onto a memory button. In some cases, pressing the button a second time cancels the feature.

## Programming feature buttons



Any memory button not programmed as an external or internal line, target line, Answer button, or Handsfree/Mute button, is available for features.





1. Press   .
2. Press the memory button you want to program with a feature.
3. Enter the appropriate feature code you want to assign onto the button.

The following feature codes cannot be programmed onto a memory button: Long Tones and any code beginning with  except      (Language Choice) and    (Contrast Adjustment).



**Tip** - When you program a button with the line pool feature code, you must enter a line pool access code after the feature code. The programmed line pool button accesses a specific line pool, not the line pool feature.

## Erasing a feature button

1. Press   .
2. Press the feature button.
3. Press  or OK to erase the button.

## Displays

```
<Feature name>
      SHOW      OK
```

The name of the feature assigned to a button is displayed when you press the button. **SHOW** appears when there is more information available. Press **#** or **SHOW** for additional information.

```
Enter code:
```

If you are checking a speed dial button, enter the two-digit speed dial code that you want to check.

```
F_
QUIT    CLEAR
```

Enter the feature code, or press **☎** or **QUIT** to quit programming or **CLEAR** to clear the numbers you have entered. The system accepts the entry as soon as you enter a valid feature code.

```
Feature code:
QUIT
```

Press **☎** and enter the feature code you want to assign to the button. You cannot enter invalid codes.

```
Feature moved
```

You have programmed a button with a feature that was already programmed onto another button. The feature has moved to the button you just programmed. Its original button is now blank.

```
Press a button
EXIT
```

Press the button you want to check. Press **☎** or **EXIT** when you are finished.

```
Program and HOLD
```

Enter the number you want to program and press **☎**. To erase the button, just press **☎**.

```
Program and OK
QUIT      OK
```



Enter the number you want to program and press **OK**. To erase the button, just press **☎** or **OK**.

For other displays, see “Common feature displays” on page 229.

## Labeling your set

The Business Series Terminals have label strips that come with each set. The Norstar M-series sets have individual keycap labels. This section suggests the process for setting up the labelling for your set.

### Applying button labelling

Before you apply button labels, use the Button Inquiry feature (    ) to verify the button functions, and to avoid activating features as you put the labels onto the buttons. For more information refer to “Finding out what a button does using Button Inquiry” on page 135.

### Business Series Terminals

The T7100 has only one feature button. The picture below shows the location of the labels for the T7208 and T7316 sets.

#### Business Series Terminal button label locations

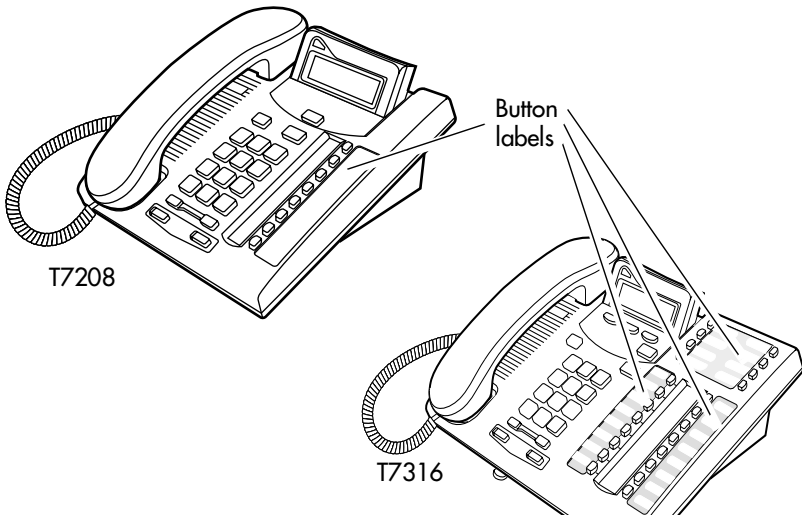

You can use the Desktop Assistant utility to make changes and print a new label card for your T-series telephones. Your system administrator can access this application from the system CD or download it from <http://www.nortelnetworks.com> (Customer Support/Software Distribution, under Product Selection choose Desktop Assistant).

## Norstar button caps

- **Unlabeled, clear button caps**  
with appropriate green or gray paper for typing in line numbers, telephone numbers, and features
- **Pre-printed, colored button caps**  
in green or gray

### Some examples of pre-printed button caps

Green caps	Grey caps
Line 1	Last No.
Handsfree Mute	Speed Dial

For more information about buttons on the Business Series Terminals T7316, refer to “Using Buttons” on page 15.



**Tip** - *To make identification of line types easier, use preprinted green button caps for lines that support incoming and outgoing calls. Use clear button caps for target lines that are incoming only.*

## Identifying the telephones

1. Write the individual telephone numbers on the labels and attach them to the appropriate Norstar telephones.
2. Write the telephone number and the internal number on the appropriate handset card for each type and color of telephone that is to be installed.
3. Cover the handset card underneath the handset of each telephone with the plastic lens.

## T7316 Business Series Terminal button defaults

The default button assignments for the T7316 Business Series Terminal depend on the template applied during startup. Refer to the Programming Record to identify the current button programming for each set or group of sets.

### Upper level buttons

Note the button numbering for the upper buttons of this set. They are mapped to the equivalent from the M7310 Norstar set. However, since there is no second level on this set, the button numbers are not consecutive.

Note: These examples show defaults for a system with three-digit internal numbers. The defaults do not actually exist on any telephone, as no telephone has an autodial button for itself. The position that would be taken by the autodial button for itself, is blank.

### Lower button assignments

The lower set of buttons on the T7316 are mapped in the following way:

#### T7316 BST lower buttons

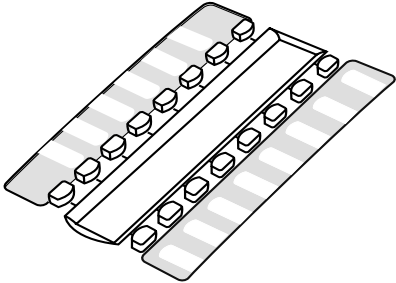
Button #/ Function	Square template	Button #/ Function
11 <input type="text" value="Set 221"/>		17 <input type="text" value="Set 224"/>
13 <input type="text" value="Set 222"/>		19 <input type="text" value="Set 225"/>
15 <input type="text" value="Set 223"/>		21 <input type="text" value="Set 226"/>
01 <input type="text" value="Line 1"/>		06 <input type="text" value="Conf/Trans"/>
02 <input type="text" value="Line 2"/>		07 <input type="text" value="Last No."/>
03 <input type="text" value="Call Fwd"/>		08 <input type="text" value="Voice Call"/>
04 <input type="text" value="Pick-Up"/>		09 <input type="text" value="Intercom"/>
05 <input type="text" value="Page"/>		10 <input type="text" value="Intercom"/>

**PBX template**

**Hybrid template**

11 <input type="text" value="Set 221"/>	17 <input type="text" value="Set 224"/>	11 <input type="text" value="Set 221"/>	17 <input type="text" value="Set 224"/>
13 <input type="text" value="Set 222"/>	19 <input type="text" value="Set 225"/>	13 <input type="text" value="Set 222"/>	19 <input type="text" value="Set 225"/>
15 <input type="text" value="Set 223"/>	21 <input type="text" value="Set 226"/>	15 <input type="text" value="Set 223"/>	21 <input type="text" value="Set 226"/>
01 <input type="text" value="DND"/>	06 <input type="text" value="Conf/Trans"/>	01 <input type="text" value="Line 1"/>	06 <input type="text" value="Conf/Trans"/>
02 <input type="text" value="Transfer"/>	07 <input type="text" value="Last No."/>	02 <input type="text" value="Line pool"/>	07 <input type="text" value="Last No."/>
03 <input type="text" value="Call Fwd"/>	08 <input type="text" value="Voice Call"/>	03 <input type="text" value="Call Fwd"/>	08 <input type="text" value="Voice Call"/>
04 <input type="text" value="Pick-Up"/>	09 <input type="text" value="Intercom"/>	04 <input type="text" value="Pick-Up"/>	09 <input type="text" value="Intercom"/>
05 <input type="text" value="Page"/>	10 <input type="text" value="Intercom"/>	05 <input type="text" value="Page"/>	10 <input type="text" value="Intercom"/>

**T7316 BST upper buttons**

Button 23

Button 25

Button 27

Button 29

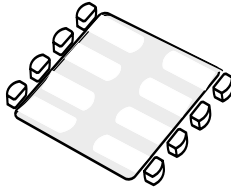

Button 31

Button 33

Button 24

Button 26

## M7310 telephone button defaults

The default button assignments for the M7310 telephone depend on the template applied. The exception is the default numbering for the dual memory buttons. Refer to “Using Buttons” on page 15.

### M7310 lower button assignments

The following tables map the positions for the lower set of buttons for the Norstar M7310 set.

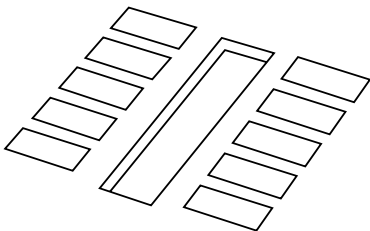
Button #/ Function	Square template	Button #/ Function		
01 <input type="text" value="Line 1"/>		06 <input type="text" value="Conf/Trans"/>		
02 <input type="text" value="Line 2"/>		07 <input type="text" value="Last No."/>		
03 <input type="text" value="Call Fwd"/>		08 <input type="text" value="Voice Call"/>		
04 <input type="text" value="Pick-Up"/>		09 <input type="text" value="Intercom"/>		
05 <input type="text" value="Page"/>		10 <input type="text" value="Intercom"/>		
PBX template		Hybrid template		
01 <input type="text" value="DND"/>		06 <input type="text" value="Conf/Trans"/>	01 <input type="text" value="Line 1"/>	06 <input type="text" value="Conf/Trans"/>
02 <input type="text" value="Transfer"/>		07 <input type="text" value="Last No."/>	02 <input type="text" value="Line pool"/>	07 <input type="text" value="Last No."/>
03 <input type="text" value="Call Fwd"/>		08 <input type="text" value="Voice Call"/>	03 <input type="text" value="Call Fwd"/>	08 <input type="text" value="Voice Call"/>
04 <input type="text" value="Pick-Up"/>		09 <input type="text" value="Intercom"/>	04 <input type="text" value="Pick-Up"/>	09 <input type="text" value="Intercom"/>
05 <input type="text" value="Page"/>	10 <input type="text" value="Intercom"/>	05 <input type="text" value="Page"/>	10 <input type="text" value="Intercom"/>	

## M7310 dual memory buttons

*12	<input type="text" value="Set 233"/>	*20	<input type="text" value="Set 237"/>	*28	<input type="text" value="Set 241"/>
13	<input type="text" value="Set 221"/>	21	<input type="text" value="Set 225"/>	29	<input type="text" value="Set 229"/>
*14	<input type="text" value="Set 234"/>	*22	<input type="text" value="Set 238"/>	*30	<input type="text" value="Set 242"/>
15	<input type="text" value="Set 222"/>	23	<input type="text" value="Set 226"/>	31	<input type="text" value="Set 230"/>
*16	<input type="text" value="Set 235"/>	*24	<input type="text" value="Set 239"/>	*32	<input type="text" value="Set 243"/>
17	<input type="text" value="Set 223"/>	25	<input type="text" value="Set 227"/>	33	<input type="text" value="Set 231"/>
*18	<input type="text" value="Set 236"/>	*26	<input type="text" value="Set 240"/>	*34	<input type="text" value="Set 244"/>
19	<input type="text" value="Set 224"/>	27	<input type="text" value="Set 228"/>	35	<input type="text" value="Set 232"/>

Note: This example shows defaults for a system with three-digit internal numbers. The defaults do not actually exist on any telephone, as no telephone has an autodial button for itself. The position that would be taken by the autodial button for itself, is blank.

\* These settings are produced using the shift key, located beside the upper set of buttons.

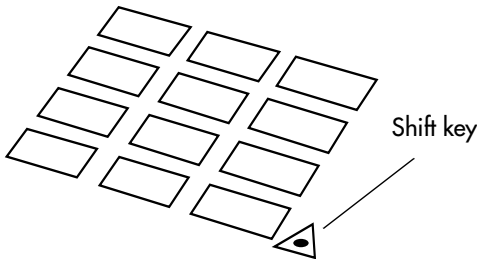

## Default button assignments

Default features are assigned automatically to the programmable buttons on Norstar telephones and vary depending on the telephone. The default features are listed in the tables in this chapter.

### Rules of default button assignment

Line and intercom buttons are assigned by default templates and can be changed in programming. Handsfree/Mute and Answer buttons are not assigned by default. If these features are defined, however, they are automatically assigned to specific buttons, as described on this and the following page. None of these buttons can be assigned to M7100 or T7100 telephones.

The Handsfree/Mute feature appears on the bottom right-hand button. It appears on the bottom button on the M7208 and T7208 telephones. This feature moves the Intercom button(s) up one position.

Each telephone can have up to eight Intercom buttons. They appear above the Handsfree/Mute button at the bottom right-hand position on your



telephone. Note: It appears as the bottom button on M7208 and T7208 telephones).

Each telephone can have up to four Answer buttons. They appear above Intercom buttons in the right column and continue up from the bottom in the left column, replacing the features on those buttons. On the M7208 and T7208 telephones, Answer buttons appear above Intercom buttons and below external line buttons in a single column.)

External line buttons appear in ascending line order, starting at the top button in the left column. This is the top button on the M7208 and T7208 telephones). If more than five external lines are assigned to an M7310 or T7316, telephone assignment continues down the buttons on the right column, erasing the features on those buttons. Line buttons have priority over feature access buttons but not Handsfree/Mute, Intercom, or Answer buttons.

## M7100 and T7100 telephone button defaults

For for the default template, the one programmable button on the M7100 and T7100 telephone is .

## M7208 telephone button defaults



**Tip** - The default Page button activates the General Page option (  ).

## M7324 telephone button defaults

Buttons without a label are blank by default and can be programmed as autodial or feature buttons. The M7324N telephone has a two-line display, three display keys, 24 memory keys with indicators, and Handsfree capability.



### M7324N memory key assignments

Square		
Line 1	Call Fwd	Conf
Line 2	Spd Dial	Transfer
Line 3	Last No.	DND
Line 4	Save No.	Pick-Up
Blank	Blank	Vce Call
Blank	Blank	Page
Blank	Blank	Intercom
Blank	Blank	Intercom

Hybrid			PBX		
Line 1	Call Fwd	Conf	Blank	Call Fwd	Conf
Line Pool	Spd Dial	Transfer	Blank	Spd Dial	Transfer
Blank	Last No.	DND	Blank	Last No.	DND
Blank	Save No.	Pick-Up	Blank	Save No.	Pick-Up
Blank	Blank	Vce Call	Blank	Blank	Vce Call
Blank	Blank	Page	Blank	Blank	Page
Blank	Blank	Intercom	Blank	Blank	Intercom
Blank	Blank	Intercom	Blank	Blank	Intercom



**Tip** - The default Page button activates the External Page option (☎ 6 2).

## Moving line buttons

☎ \* 8 1

You can move external lines to different buttons on your telephone to arrange your lines in the way that makes the most sense to you.

You cannot move intercom, answer or Handsfree/Mute buttons onto a CAP module.

1. Press ☎ \* 8 1.
2. Press the button you want to move the line from.
3. Press the button you want to move the line to.

### Displays

Exchanged

The two buttons you selected have exchanged position.

Invalid location

You have tried to move a line to a button that cannot be used as a line button, such as an intercom button, Handsfree/Mute button, or an answer button.

Move line from:

QUIT

Press the button of the line you want to move. Press ☎ or QUIT when you have finished moving lines.

Move line to:

QUIT

Press the button you want to move the line to. Neither of the buttons is erased. The lines, or the line and feature, simply switch places.

Press a line

The button you are trying to move is not a line button. If you are trying to switch a line and a feature, move the line to the feature button and not the feature button to the line.

## Changing the type of ring

☎ \* 6

You can choose one of four distinctive rings for your telephone. This makes it easier to identify your telephone in an open office.

1. Press ☎ \* 6 .
2. Press 1 , 2 , 3 , 4 , or **NEXT**. You hear the selected ring for two seconds.
3. Repeat until you hear the ring you prefer, then press ☎ or **OK**.

## Adjusting the Ring volume

☎ \* 8 0

1. Press ☎ \* 8 0 . The telephone rings.
2. Press \* ——— \* to adjust the volume; left end for lower and right end for higher.

## Hiding the message or calls indication

☎ 8 0 6

The display that shows you have messages or calls can be replaced with the current time and date. You can retrieve your message and call information by using the display buttons that appear on the second line of the display.

If you are using a telephone with a single-line display, the message or call indication is hidden.

1. Press ☎ 8 0 6 . The current time and date appears on the top line of the display.
2. Press **MSG** or ☎ 6 5 to see your messages, or press **CALLS** or ☎ 8 1 2 to see your calls.

## Restoring the messages and calls indication

Press ☎ # 8 0 6

# User Preferences

The User Preferences section of programming allows you to program memory buttons, speed dial codes and other settings for any Norstar telephone on the system.

For example, an employee may want to have the Do Not Disturb feature programmed onto a memory button or create a speed dial code. Instead of programming from the employee's telephone, you can go into programming on the telephone nearest you to make the change.

## Using User Preferences

1. Press  \* \* U S E R (  \* \* 8 7 3 7 ).
2. Enter your System Coordinator or Basic password (the default passwords are  and ).

By using a Basic password, it is possible to have someone else do day-to-day upkeep of people's telephones without giving out access to sensitive programming. See "Using passwords" on page 202.

After you enter the proper password, the display shows you the telephone with the lowest internal number followed by its name (For example, **21:RECEPTN**).

1. Press  to move through all the telephones on the system.
2. Press  when you see the telephone you want to change. The display shows the model number of the telephone at the extension. The display shows **Connect set** if no telephone is connected at that internal number. You cannot make changes if the model is **Other**.
3. Press  to move through all the subheadings in User Preferences.

User Preferences programming is available under the heading **User Preferences** in **Terminals&Sets** in the main body of programming.

## Sub-headings in User Preferences

User preferences
Model
Button prgrming
User speed dial
Call log opt'ns
Dialing opt'ns
Language
Display cntrst
Ring type

## Changing button programming

Press  at **Button Prgrming**. The display shows the number of buttons on the telephone (an example is shown in Displays at the end of this section).

If the telephone has a CAP module, you can press **CAP1** to see the buttons on the module.

Press  to move through all the buttons on the telephone. Refer to “Default button assignments” on page 144 for button number mapping for each type of Business Series Terminal and Norstar M-series telephones.

Use the display buttons to change the programming for a button. User Preferences programming cannot change the buttons that are used by lines, intercom, and the handsfree feature.

### The display buttons used in button programming

- CANCL** Moves you out of a setting without making any changes to it.
- CLR** Erases the button.
- TEL#** Programs the key as an autodial number for an internal or an external number. If it is an external autodial number, you have to choose a line, line pool, or the routing table for the call to use.
- CHANGE** Used when you are setting up an external autodial number. Press **CHANGE** until you see the type of line or pool you want the number to use.

- FEATR** Press to store a feature code on the button.
- FIND** Locates a specific button on a telephone by entering its number. Button numbers are shown in the illustrations.
- LIST** Takes you to a list of feature codes. Press  to move through the list and press **OK** when you see the feature you want to program on the button.

Information about individual displays you may see is described at the end of this section.

## Changing a User Speed Dial

1. Press  at **User Speed Dial**. The display shows the number of speed dial codes that are available.
2. Press  to see the first speed dial code (256).
3. Press  to move through all the speed dial codes.
4. Press  at the code you want to change.
5. Press **CHANGE** and enter the telephone number the same way you would dial it on the telephone.
6. Press **OK**.
7. Press  and choose the line (or enter a code for a line pool) the speed dial code should use.

Use the line pool code to select a particular line pool for use with Speed Dial. If you select **Use routing tbl**, a line or pool is chosen by the routing programming according to the initial digits in the number.

The route you choose for a User Speed Dial code must be one that the telephone can use. For example, if the telephone does not have access to Line Pool B and you use that pool code with the speed dial code, the code does not work.

To change a system speed dial code, see “Adding or changing a system speed dial” on page 29.

## Changing Call Log options

1. Press  at **Call log opt'ns...**
2. Press **CHANGE** until you see the option you want to use. See “Call Log options” on page 128

## Changing how calls are dialed

1. Press  at **Dialing opt'ns...**
2. Press **CHANGE** until you see the option you want to use.

Descriptions for dialing options are found on the *Telephone Feature Card*, or see “Changing how you dial your calls” on page 67.

## Changing the language used on the display

Press **CHANGE** at **Language:** until you see the language you want to use.

For language choices see “Changing the language on the display” on page 136

## Making the display lighter or darker

Press **CHANGE** at **Display contrast** until you see the value you want to use.

The display contrast on the telephone you are using for the programming session does not change when you are programming another telephone.

## Changing the ring on the telephone

At **Ring type:**, press **CHANGE** until you see the option you want to use.

Descriptions for ringing options are found on the *Telephone Feature Card* or in “Changing the type of ring” on page 148.

## Changing the voice path on the telephone

At **Voice path:**, press **CHANGE** for either **Handsfree** or **Headset**.



## Displays

```
10+24 buttons
                               FIND
```

There are 10 memory buttons and 12 dual memory buttons on the telephone you are viewing. Press  to begin looking at what is on each button.

```
B01:L06:Line 001
                               FIND
```

A line appears on the button. You cannot store a feature or number on it.

```
B02:#Reply Msg...
CLR  TEL#  FEATR
```

A feature is stored on this button. Press  to see the feature code. A full list of names and codes for features is included in the index.

```
Code:F#65...
CLR  TEL#  FEATR
```

Shows the feature code stored on a button. Press  to see the button number and feature name.

```
B03:160455512...
CLR  TEL#  FEATR
```

The button has a telephone number stored on it. Press  to see the rest of the number.

```
Extern1 tel #...
CLR  TEL#  FEATR
```

The autodial is an external number. Press  to see what line or pool the call is programmed to go out on.

```
Intern1 tel #...
CLR  TEL#  FEATR
```

The autodial is an internal number. Press  to see more information.

```
B04:Intercom...
                               FIND
```

The button is used for intercom. Press  to see more information about the button. You cannot store a feature or number on it.

```
B05:Ansr 93
                               FIND
```

The button is used for an Answer DN. You cannot store a feature or number on it.

```
B06:Blank button
CLR  TEL#  FEATR
```

Either nothing is stored on the button or you have just cleared the button by pressing CLR.

```
B10:Handsfree
                               FIND
```

The button is occupied by the Handsfree feature. You cannot store a feature or number on it.

For other displays, see “Common feature displays” on page 229.



# Programming Hunt Groups

The Hunt Groups feature allows a group of Norstar sets to be called by a single directory number ensuring that calls are easily routed to the appropriate group.



The Incoming Line Group (ILG) functionality is now accomplished through the Hunt Group feature. When upgrading to Compact ICS 6.0 any lines previously belonging to an ILG (CICS versions previous to 4.0) are not automatically converted to broadcast Hunt Groups, they must be programmed. Please refer to “Assigning or unassigning lines to a group” on page 158.

Hunt Groups are used in situations where a group of people performing the same task are required to answer a number of related phone queries. Some typical uses of Hunt Groups are:

- a sales department answering questions on product prices or availability
- a support department answering questions concerning the operation of a product
- an emergency department answering calls for help.

Hunt Groups can be used to route calls to a support service such as a Help Line for a software company. Specialists dealing with Product A can be in one group, and specialists dealing with Product B can be in another group. Incoming calls hunt for the next available set in the group. If no set is available, the call can be placed in a queue or routed to an overflow set.

The Hunt Groups subheading in system programming is the area where programming changes are made to the following:

- members of a group
- position of a group member
- what lines are assigned to a group
- how incoming calls are distributed
- how long the system looks for available members
- where a call goes if all members are busy

Note: Videophones should not be placed in Hunt Groups. Hunt Groups allow one B channel connection at a time and videophones use two B channels.

Features affected by Hunt Groups include:

- Auto Attendant
- Call Forward All Calls
- Call Forward No Answer
- Call Forward on Busy
- Group Pickup
- Transfer via Hold
- Priority Call
- Line Redirection
- Page Zones
- Voice Call

Note: Fixed external cadencing is provided for all external Hunt Group calls regardless of whether or not they have been answered and transferred.

## Adding or removing members from a group

Members of the group can be any Norstar set or ISDN terminal. A Norstar set can be in more than one Hunt Group but is considered a member in each Hunt Group, increasing the total number of members in the system.

There can be only one appearance of the same Hunt Group on a set. Hunt Group DNs cannot be members of other Hunt Groups. A DN can be associated with a member of a Hunt Group and is called a member DN.

Consult your customer service representative to determine your Hunt Group number range.

Note: Only a three digit DN length works with Hunt Groups.

1. Place the programming overlay on a T7316, M7310 or M7324 telephone.
2. Press  \* \* 2 6 6 3 4 4 (CONFIG). The display shows **Password:**.
3. Press      (ADMIN). The display shows **Terminals&Sets**.
4. Press  until the display shows **System prgrming**.
5. Press . The display shows **Hunt groups**.
6. Press . The display shows **Show group**.
7. Enter the Hunt Group number you want to program (1-6).
8. Press . The display shows **Member DNs:**.
9. Press . The display shows the members for that group.
10. Press **ADD** to add a member or press **REMOVE** to remove a member from the group.
11. Press  to exit or  to continue programming.

## Moving members of a group

Member order within a Hunt Group is important. The member order determines how a call is routed through a Hunt Group.



1. Place the programming overlay on a T7316, M7310 or M7324 telephone.
2. Press  \* \* 2 6 6 3 4 4 (CONFIG). The display shows **Password:**.
3. Press      (ADMIN). The display shows **Terminals&Sets**.
4. Press  until the display shows **System prgrming**.
5. Press . The display shows **Hunt groups**.
6. Press . The display shows **Show group**.
7. Enter the Hunt Group number you want to program (1-6).
8. Press . The display shows **Member DNs:**.
9. Press . The display shows the members for that group.

10. Press **MOVE** to move an existing member to another place within the Hunt Group. The display shows the member number followed by an arrow.
11. Enter the new position number for the extension.
12. Press  to exit or  to continue programming.

## Assigning or unassigning lines to a group

Configure the prime set for a Hunt Group's line to None to avoid delayed ring transfer of external Hunt Group calls to the prime set before the Hunt Group can receive the call.

A line can be assigned to only one group.

1. Place the programming overlay on a T7316, M7310 or M7324 telephone.
2. Press  \* \* 2 6 6 3 4 4 (CONFIG). The display shows **Password:**.
3. Press 2 3 6 4 6 (ADMIN). The display shows **Terminals&Sets.**
4. Press  until the display shows **System Prgrming.**
5. Press . The display shows **Hunt groups.**
6. Press . The display shows **Show group.**
7. Enter the Hunt Group number you want to program (1-6).
8. Press . The display shows **Member DNs:**.
9. Press . The display shows **Line assignment.**
10. Press . The display shows **Show line:**.
11. Enter the line number you want to program and press **SCAN** to go to the first line assigned to this group, or press **LIST** to go to the first line in the system.
12. Press **CHANGE** to program the line as **Unassigned** or **Assigned**.  
\*HGnn\* means the line is assigned to another Hunt Group.
13. Press  to exit or  to continue programming.

## Assigning a distinctive ring pattern to a Hunt Group

You can assign distinctive ring patterns to your Hunt Group so that calls can be rated in priority for the group.

These distinctive ring patterns, have the same characteristics as for line and extension distinctive ring patterns. Refer to “Changing the ring on the telephone” on page 152.

The Hunt Group distinctive ring pattern determines how a call will ring within the Hunt Group. If members of the group have ring patterns assigned to their telephones that are higher than the ring patterns of the incoming line or the Hunt Group, then the Hunt Group will use the ring of the corresponding member telephones.

If the incoming call (line) has a higher ring pattern assigned than the Hunt Group, the Hunt Group will ring with the line ring pattern.

1. Find the heading **Hunt Groups**.
2. Press  until the display shows **Member extns.:**
3. Press  until the display shows **Dstnct Ring: NONE**.
4. Press **CHANGE** to toggle to the ring pattern number you want to assign to the Hunt group line. (**None, 2, 3, 4**)
5. Press  to exit or  to continue programming.

## Setting the distribution mode

There are three modes of call distribution:

- **Broadcast**—rings each set in the group simultaneously. Calls are handled one at a time. Subsequent calls are queued. As soon as a call is picked up, the call next in the queue is presented to the Hunt Group without having to wait for queue time-out.

In Broadcast mode, a single incoming call rings simultaneously at all the sets in a group. This way, all receptionists in the group can share the load of answering large volumes of calls. All sets automatically display the calling line identification (CLID), if available. A familiar

example is a fund-raising campaign where a group of operators are waiting to take each call as it comes in.

- Sequential—starts the call at the first set in the Hunt Group and distribution is complete when the first free set has been found. Simultaneous calls can be presented. Distribution is order based.

In Sequential mode, you can program your top salesperson to be the first member of the group to receive incoming calls.

- Rotary—the call starts at the set after the one which answered the last call. Distribution is complete when the next free set has been found. Simultaneous calls can be presented. Distribution is order based.

In Rotary mode, you can ensure that all your helpline people are receiving calls on an equal basis, rather than one person receiving the majority of calls. The call rings at one set at a time in a round robin fashion.

If a Hunt Group has available members but nobody answers the call, the call is routed through the Hunt Group list until either someone answers the call or the queue time-out occurs. In the latter case, the call is routed to the overflow position. Once a call goes to the overflow position it is no longer a Hunt Group call.

1. Place the programming overlay on a T7316, M7310 or M7324 telephone.
2. Press  \*  2  6  4  (CONFIG). The display shows **Password:**.
3. Press    4  (ADMIN). The display shows **Terminals&Sets.**
4. Press  until the display shows **System Prgrming.**
5. Press . The display shows **Hunt Groups.**
6. Press . The display shows **Show Group.**
7. Enter the Hunt Group number you want to program (1-6).
8. Press . The display shows **Member DNs:**.
9. Press  until the display shows **Mode.**
10. Press **CHANGE** to set the mode: **Sequential, Rotary, Broadcast.**
11. Press  to exit or  to continue programming.



## Setting the hunt delay

This setting allows you to program the number of rings the system permits at a Hunt Group set before moving on to the next set in the Hunt Group.

1. Place the programming overlay on a T7316, M7310 or M7324 telephone.
2. Press          (CONFIG). The display shows **Password:**.
3. Press      (ADMIN). The display shows **Terminals&Sets.**
4. Press  until the display shows **System prgrming.**
5. Press . The display shows **Hunt groups.**
6. Press . The display shows **Show group.**
7. Enter the Hunt Group number you want to program (1-6).
8. Press . The display shows **Member DNs:**.
9. Press  until the display shows **Hunt delay.**
10. Press **CHANGE** to select the setting: 1, 2, 3, 4, 5, 6, 7, 8, 9, 10.
11. Press  to exit or  to continue programming.

## Programming busy line setting

A Hunt Group is considered busy if one of two scenarios exists:

- all of its members are being presented an incoming Hunt Group call
- all of its members are active on a Hunt Group call

There are three routing options if all members are busy:

- BusyTone—the caller gets a busy tone
- Overflow—the call is routed to an overflow position
- Queue—the call stays in the system for a period of time. Within this period of time, the call is presented to a member if one becomes available. When the time-out occurs, the call is presented to an overflow position.

1. Place the programming overlay on a T7316, M7310 or M7324 telephone.
2. Press  \* \* 2 6 6 3 4 4 (CONFIG). The display shows **Password:**.
3. Press      (ADMIN). The display shows **Terminals&Sets.**
4. Press  until the display shows **System Prgrming.**
5. Press . The display shows **Hunt groups.**
6. Press . The display shows **Show group.**
7. Enter the Hunt Group number you want to program (1-6).
8. Press . The display shows **Member DNs:**.
9. Press  until the display shows **If busy:**.
10. Press **CHANGE** to set the mode: **BusyTone, Overflow, Queue.**
11. Press  to exit or  to continue programming.

## Programming the queue time-out

This setting allows you to program the number of seconds a call remains in the Hunt Group queue before it is routed to the overflow position.



1. Place the programming overlay on a T7316, M7310 or M7324 telephone.
2. Press  \* \* 2 6 6 3 4 4 (CONFIG). The display shows **Password:**.
3. Press      (ADMIN). The display shows **Terminals&Sets.**
4. Press  until the display shows **System Prgrming.**
5. Press . The display shows **Hunt groups.**
6. Press . The display shows **Show group.**
7. Enter the Hunt Group number you want to program (1-6).
8. Press . The display shows **Member DNs:**.
9. Press  until the display shows **Q Timeout:**.
10. Press **CHANGE** to set the queue time-out: **15, 30, 45, 60, 120, 180.**

11. Press  to exit or  to continue programming.

## Programming the overflow set

This setting allows you to program the overflow set to which the Hunt Group calls are to be routed. Unless the overflow position is a Hunt Group set, the call ceases to be a Hunt Group call. If the overflow set is a Hunt Group set, the call is treated as a new call and goes to the bottom of the queue.

The overflow set can be a set DN number associated with a voice mailbox.

1. Place the programming overlay on a T7316, M7310 or M7324 telephone.
2. Press  \* \* 2 6 6 3 4 4 (CONFIG). The display shows **Password:**.
3. Press 2 3 6 4 6 (ADMIN). The display shows **Terminals&Sets.**
4. Press  until the display shows **System Prgrming.**
5. Press . The display shows **Hunt Groups.**
6. Press . The display shows **Show Group.**
7. Enter the Hunt Group number you want to program (1-6).
8. Press . The display shows **Member DNs.**
9. Press . The display shows **Overflow.**
10. Press . The display shows **Overflow HGrp.**
11. Press **CHANGE** to change the overflow position.
12. Enter the new overflow position.
13. Press  to exit or  to continue programming.

## Setting the name

This setting allows you to program the Hunt Group name, such as SERVICE or SALES. The name can be up to seven characters in length.

1. Place the programming overlay on a T7316, M7310 or M7324 telephone.
2. Press  \* \* 2 6 6 3 4 4 (CONFIG). The display shows **Password:**.
3. Press      (ADMIN). The display shows **Terminals&Sets.**
4. Press  until the display shows **System Prgrming.**
5. Press . The display shows **Hunt groups.**
6. Press . The display shows **Show group.**
7. Enter the Hunt Group number you want to program (1-6).
8. Press . The display shows **Member DNs:**.
9. Press . The display shows **Name:**.
10. Press **CHANGE**.
11. Using the dialpad, enter the name of the Hunt Group.
12. Press  to store the name.
13. Press  to exit or  to continue programming.

# Using the Hospitality features

This section describes the Hospitality Services feature which is used to administer room and alarm services in small to medium-sized facilities such as hostels, motels, or hospitals.

There are three types of sets that make up this type of system:

**Common set**—this telephone can be found in the lobby, office, or common area, and is not associated with a room. This type of set cannot access all of the features.

**Room set**—this telephone resides in a specific room and can be used by both guests and cleaning staff to set alarms or indicate room condition. Up to five sets can be assigned to the same room number, such as for fax lines, internet dial-up, etc.

**Administration set**—this telephone must be a two-line display set and is usually configured with a password to allow secure administration of room occupancy and condition services and alarm services.

## Hospitality passwords

There are two passwords within the hospitality feature. One provides secure access to the administration set, and one provides secure access to a room condition setting from each room set for housekeeping staff.

### Desk pswd

Change this password frequently, to maintain security.

1. Place the appropriate programming overlay on the set you are using to do programming.
2. Press          (CONFIG). The display shows **Password:**.
3. Press      (ADMIN). The display shows **Terminals&Sets.**
4. Press  until the display shows **Hospitality.**

5. Press .
6. **Desk Pswd:4677** displays.
7. Press **CHANGE**.
8. **New Pswd:** displays
9. Enter a new password, then press **OK**.

## Cond pswd

Change this password frequently, to maintain security.

1. Place the appropriate programming overlay on the set you are using to do programming.
2. Press          (**CONFIG**). The display shows **Password:**.
3. Press      (**ADMIN**). The display shows **Terminals&Sets**.
4. Press  until the display shows **Hospitality**.
5. Press .
6. Press
7. **Cond Pswd:None** displays.
8. Press **CHANGE**.
9. **New Pswd:** displays
10. Enter a new password, then press **OK**.

## Room/desk information

There are two aspects to programming room information.

- First you must program specific DNs to a specific room and set up the room occupancy filters, which determine what types of calls can be made from a room set at various states of occupancy.  
Note: You can assign up to five DNs to the same room number.
- Then you need to administer the room occupancy and state of the room.

## Programming room information

Use this setting to assign set DNs to a specific room.

1. Place the appropriate programming overlay on the set you are using to do programming.
2. Press          (CONFIG). The display shows **Password:**.
3. Press      (ADMIN). The display shows **Terminals&Sets.**
4. Press  until the display shows **Hospitality.**
5. At the Hospitality heading, press  until **Room/desk info** displays.
6. Press . **Show set: displays.**
7. Enter a room set number or press **LIST** and press  until you find the DN of the set you want to assign to a room.
8. Press . **Room #:None** displays.
9. Press **CHANGE** and enter the room number, then press **OK** to accept the change.
10. Repeat step 6 for all the sets you want to assign.
11. Press . **Adm pwd req'd:Y** displays
12. Press **CHANGE** and choose **Y** or **N**, depending on your security requirements.

## Call restrns

You can set up call restrictions based on room occupancy states. This setting affects the Room occupancy feature.

1. Place the appropriate programming overlay on the set you are using to do programming.
2. Press          (CONFIG). The display shows **Password:**.
3. Press      (ADMIN). The display shows **Terminals&Sets.**

4. Press  until the display shows **Hospitality**.
5. At the Hospitality heading, press  until **Call restrms** displays.
6. Press . **Vacant:00** displays.
7. Press **CHANGE** and enter the filter that defines the restrictions for your hospitality system.  
The Restriction Filters section in the *Modular ICS 5.0 Installer Guide* describes how to set up filters.
8. Repeat steps 2 and 3 for the other room occupancy states.

The table below shows an example of a call restrictions setup.

Room Occupancy	Filter	Description
Vacant	11	no calls allowed except 911
Basic	11	no calls allowed except 911 and internal extensions
Mid	12	no calls allowed except 911, 1800, 188 and internal extensions
Full	13	no call restrictions

## Service times

You can set the time when occupied rooms change from Service done to Service required. This setting affects the Room condition feature.

1. Place the appropriate programming overlay on the set you are using to do programming.
2. Press          (CONFIG). The display shows **Password:**.
3. Press      (ADMIN). The display shows **Terminals&Sets**.
4. Press  until the display shows **Hospitality**.
5. At the Hospitality heading, press  until **Service time** displays.
6. Press . **Hour: 00** displays.



7. Press **CHANGE** and enter the hour (00 to 23).

If the number is less than 13, the display shows **AM**. Press **CHANGE** to select **PM**, if required. Press **OK** to accept.

8. Press . **Minutes: 00** displays.
9. Press **CHANGE** and enter the minutes (00 to 59).

## Using the room/set programming

This section describes how the room occupancy and room condition settings are used.

### Setting dialing filters by room state

1. Press    .
2. Enter the Desk admin password if you are prompted for a password.
3. The set displays: **0c of rm#:**
4. Enter the room number and press **OK**.
5. The set displays **rrrrr:Vacant**.
6. Press the **CHANGE** display key and select the required status for the room set.
7. To program other rooms, press the **FIND** or **NEXT** display key and return to step 3.
8. Press  to exit.

Note: Setting the room state to Vacant cancels any outstanding alarms.

### Setting the room condition

You can use this feature on a room set or administration set to:

- set the room state to service done (**SrvC done**)
- set the room state to Needs service (**Needs srvC**)
- query the state of the room

## Using the room set

1. Press     on a digital set  
or      on an analog set.
2. At the prompt, set the status of the room.  
Note: You may be required to enter a Room condition password.  
Press  to indicate **Set to srv done**.  
Press  to indicate **Set to needs srv**.  
The set displays the selected prompt.
3. Press  to exit.

## Using the admin set

1. Press    .
2. Enter the Desk admin password if you are prompted for a password.  
The set displays: **Cd of rm#:**
3. Enter the room number and press **OK**.  
The set displays **rrrrr:Vacant**.
4. To update the condition, press **CHANGE** and select the required status.  
To query the condition of other rooms, press the **FIND** or **NEXT** displays keys.
5. Press  to exit.

# Programming the alarm feature

If you want to allow the room sets to program wake-up alarms, there are a couple of program settings that need to be entered.

1. Place the appropriate programming overlay on the set you are using to do programming.
2. Press          (CONFIG). The display shows **Password:**.
3. Press      (ADMIN). The display shows **Terminals&Sets**.
4. Press  until the display shows **Hospitality**.
5. At the Hospitality heading, press  until **Alarm** displays.
6. Press . **Attn attempts:3** displays.

7. Press **CHANGE** until you find the number you want (1-5).
8. Press . **Retry interval:4** displays.
9. Press **CHANGE** until you find the number you want (2, 4, 6, or 8).
10. Press . **Attn duration: 15** displays.
11. Press **CHANGE** until you find the number of seconds you want (10, 15, 20, 30, 40, 50).
12. Press . **Time format:12 hr** displays.
13. Press **CHANGE** to choose either **12hr** or **24hr**.
14. Press . **Expired alarms** displays.
15. Press . **Notify set:None** displays.
16. Press **CHANGE** to enter a set DN to be notified.
17. Press . **Use tone:N** displays.
18. Press **CHANGE** to choose either **Y** (yes) or **N** (no).
19. Press  to exit or  to continue programming.

## Using the Administration set to control alarms

Only a Hospitality Services set can use this alarm administration feature. This feature is also associated with a room number, and cannot be used on common sets.

Use this feature to:

- query a current or last alarm time set for a room
- assign an alarm time for any room
- change an alarm time for any room
- cancel an pending alarm for any room

To program the alarm, follow these steps:

1. Press    .
2. Enter the Desk admin password if you are prompted for a password. The set displays: **al of rm#:**
3. Enter the room number.

4. Press **VIEW**. The set displays **Alarm: 07:00am OFF:**.  
If the alarm time is correct, press the **ON/OFF** display key.  
If you want to change the time, enter a new four-digit alarm time.  
If the clock uses a 24-hour format, enter an hour between 00 and 23, and minutes between 00 and 59. The set displays: **Alarm ON hh:mm**  
If the clock uses a 12-hour format, enter the time, then when the set displays: **hh:mm AM or PM?**, press **AM** or **PM**. The set displays: **Alarm ON hh:mm**.
5. Press **EXIT** to exit.

## Using the alarm

To set an alarm on a digital telephone:

1. Press **CALL** **8** **7** **5**. The displays shows **Alarm:07:00 OFF**
2. Do one of the following:  
If the alarm is correct, press **ON/OFF**.The set displays: **Alarm:07:00am ON**. Press **DONE** to exit.  
If you need to change the alarm time, press **CHG**. The set displays: **Enter time:**
3. To enter a new time, do one of the following:  
If the clock uses a 24-hour format, enter an hour between 00 and 23, and minutes between 00 and 59. The set displays: **Alarm ON hh:mm**  
If the clock uses a 12-hour format, enter the time, then when the set displays: **hh:mm AM or PM?**, press **AM** or **PM**. The set displays: **Alarm ON hh:mm**.

To set an alarm on an analog set:

1. Press **Link** **\*** **8** **7** **5**. A tone sounds.
2. Enter a four-digit alarm time:  
If the clock uses a 24-hour format, enter an hour between 00 and 23, and minutes between 00 and 59. A tone sounds.  
If the clock uses a 12-hour format, enter the time, then press **\*** to select am or **#** to select pm. A tone sounds.

To enter a new time, repeat the above steps and enter a new time. This overwrites the existing entry.

## Canceling an alarm

Canceling the alarm time for any set cancels the alarm time for all the sets in the same room.

Digital set: Press  # 8 7 5 .

Analog set: Press  # 8 7 5 .

## Turning off an alarm

When the alarm rings, the user can release the ring by doing one of the following, depending on the type of set in the room:

Digital set: Press any button except .

Analog set: Lift and replace the handset.

 acts like a snooze alarm and will temporarily disable the alarm for a programmed period. Refer to “Service times” on page 168.

If the user is on a call when the alarm sounds, they can press any button except , which would release the call instead.



# Telephone features

## Installing Business Series Terminals

If you are connecting a Business Series Terminal for the first time, refer to the following illustrations as a guide.

### Installing the Business Series Terminal connections

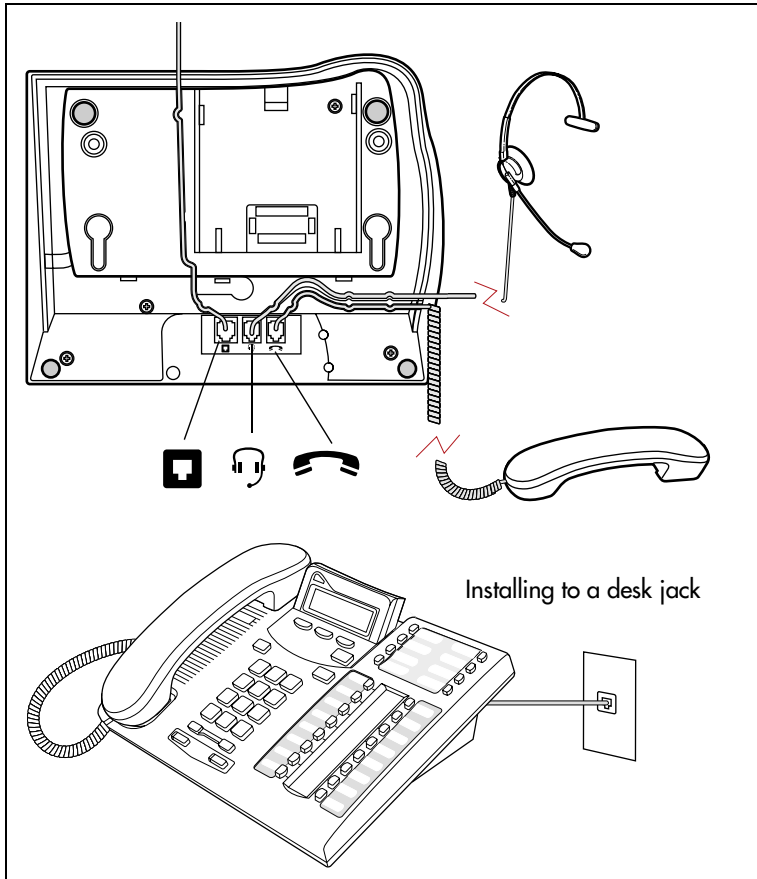

# Mounting a Business Series Terminal on the wall

## Mounting a Business Series Terminal on the wall

Installing without the angled base

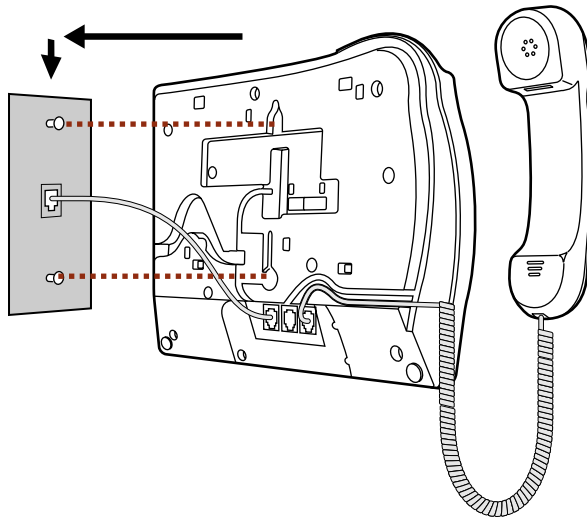



## Mounting a Business Series Terminal using the stand

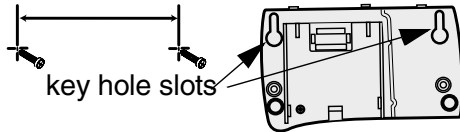
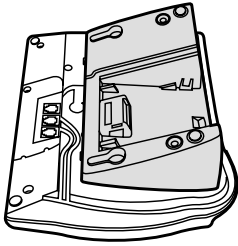

Use the key hole slots on the stand to mark the location for the screws. Tighten screws for a secure fit.

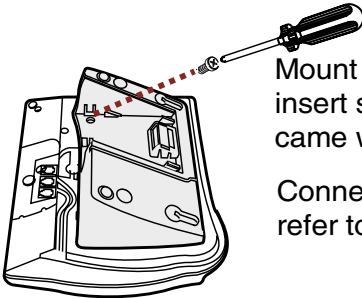

Mount the stand as shown and insert screw. Use the screw that came with your keystation.

Connect cords to the keystation, refer to cord connections

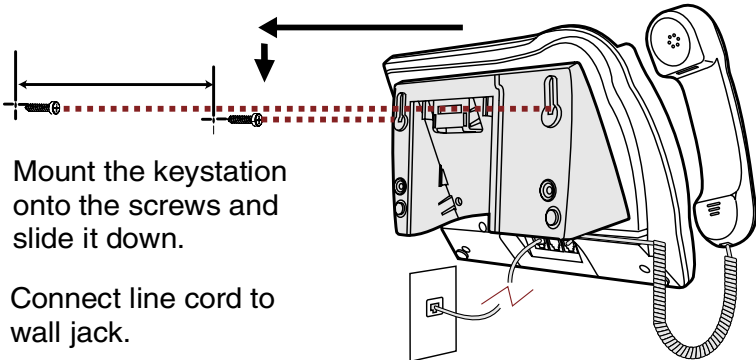

Mount the keystation onto the screws and slide it down.

Connect line cord to wall jack.

# Installing Norstar telephones

If you are connecting a Norstar telephone for the first time, refer to the illustrations below and use as a guideline.

## Installing a Norstar telephone

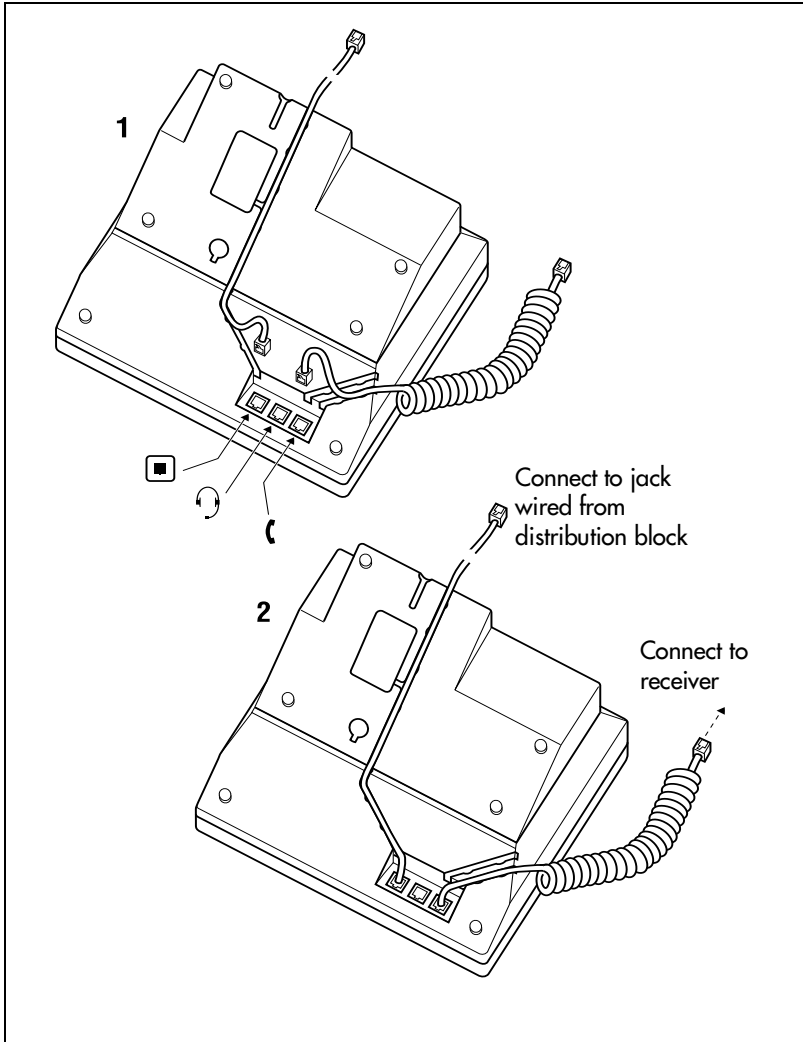

## Mounting a Norstar telephone on the wall

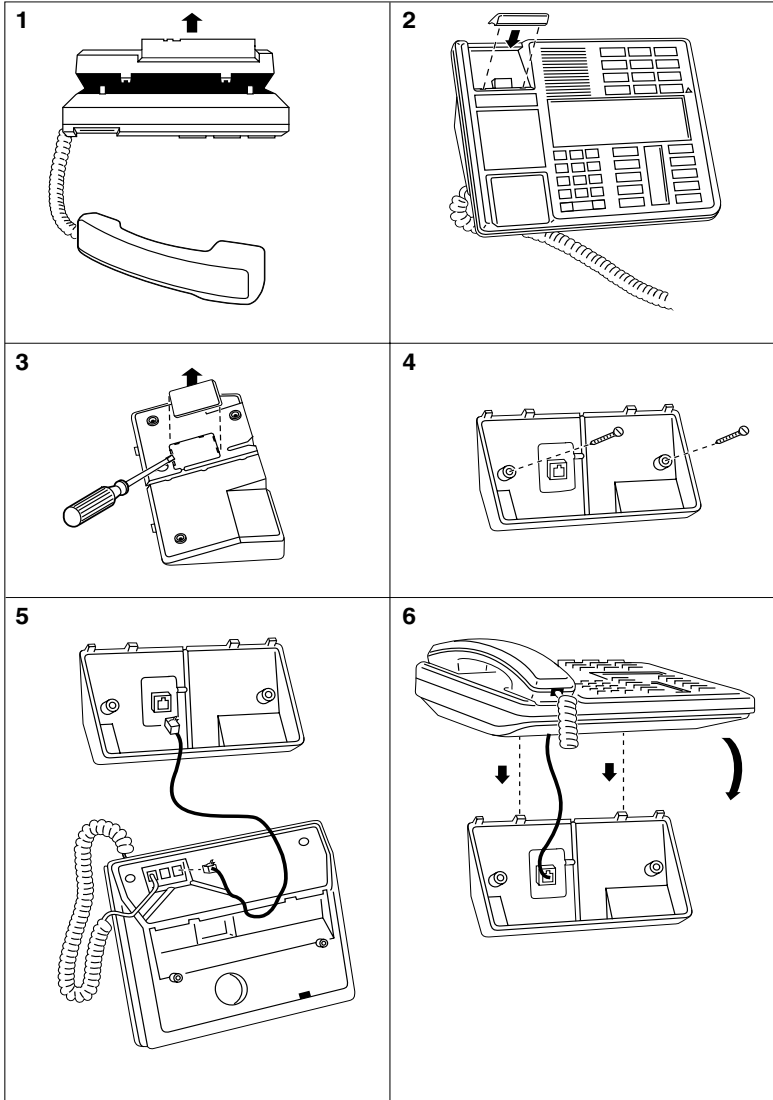

## Naming a telephone or a line

You can assign names to identify external lines, target lines, and telephones assigned to specific people. During a call, the name (if programmed) is shown on the telephone display instead of the external line number or internal telephone number of the caller. Step-by-step instructions for adding or changing the name of a telephone or a line are in “Changing the name of a telephone” on page 32.

Telephone names and line names can contain both letters and numbers, but cannot be longer than seven characters. You cannot use the # and \* symbols.



**Tip** - *You can give the same name to two or more telephones, or to a telephone and a line in your system. To avoid confusion, avoid such duplication. Use initials, abbreviations, or even nicknames to give each telephone a unique name.*

*If automatic telephone relocation is turned on, the name and internal number of a telephone are saved if the telephone is moved within your system.*

## Moving telephones

If automatic telephone relocation is enabled in programming by your installer or customer service representative, you can move your telephone from one Norstar jack to another without losing any of its custom programming.

## Stopping calls from ringing at your telephone: Do Not Disturb (DND)

### Stopping calls

Press    to stop calls from ringing at your telephone.

Only priority calls ring at your telephone. A line button flashes when you receive a call, but the call does not ring.

## Refusing to answer a call

While you are on a call, you can refuse to answer a second call (including a priority call).

Press **[☎] 8 5** while your telephone is ringing.

## Canceling Do Not Disturb

Press **[☎] # 8 5**.

### Displays

Allow calls

Your telephone receives calls normally.

## Using Do Not Disturb

Once you turn Do Not Disturb on, calls are forwarded to the prime telephone only if there is no other telephone on which the line appears. If there is another telephone that shares the same line, the call may be answered by that person. (The Delayed Ring Transfer feature transfers all unanswered calls to the prime telephone after a specified time.)

Do Not Disturb prevents voice calls from alerting at your telephone. Voice calls are presented as normal intercom calls.



**Tip** - *Norstar sets that are members of a Hunt Group can temporarily leave a Hunt Group by activating this feature. Hunt Group calls arriving while a set is in Do Not Disturb mode are routed to the next member in the Hunt Group. For more information on Hunt Groups see “Programming Hunt Groups” on page 155.*

## Using Background Music

Listen to music through your telephone speaker by pressing   .

Your installer or service representative makes this feature available through programming. You need to supply a music source, such as a radio, and have it attached to your ICS.



In accordance with U.S. copyright law, a license may be required from the American Society of Composers, Authors and Publishers or a similar organization if radio or TV broadcasts are transmitted through the Background Music feature of this telecommunication system.

Nortel Networks hereby disclaims any liability arising out of the failure to obtain such a license.

## Turning Background Music off

The music stops automatically if you make or answer a call or if you press

.

## Using the device attached to the internal analog terminal adapter

The internal analog terminal adapter (I-ATA) connects a standard analog voice device to your Compact ICS. These include such devices a single-line telephone or a data communication device, such as a modem or fax machine. Unlike an external adapter, the I-ATA only supports a device that is located on the same premises as your ICS.

You activate all of the features available from the I-ATA by pressing   on your telephone and entering a feature or access code. On some telephones, you use FLASH instead of Handsfree/Mute.

If your telephone or device does not have Handsfree/Mute, you must use the Hook Switch (located under the handset) to enter feature codes. Press the Hook Switch for approximately half a second, then enter the rest of the code.

To make an external call using the device attached to the I-ATA, you must access an external line. To access an external line, lift the handset and enter the external access code. The external access code is 9 or the number programmed by your installer or customer service representative.

The feature codes for the I-ATA the telephone use **\*** and **#**. If your telephone does not have **\***, press **1** instead. If your telephone does not have **#**, press **3** instead.

To make an external call, lift the handset and enter the external access code followed by the external telephone number. In most cases, the external access code is 9.

- Alternate line      **Link**  **2**  
 Allows you to switch between using your two intercom paths. When a path is in use, you hear an error tone informing you that the path is already in use.
- Call Forward      **Link**  **\*** **4** **Cancel** **Link**  **#** **4**  
 Directs your calls to another telephone connected to your Norstar system. Enter the feature code followed by the internal number of the telephone to receive the forwarded calls. Call Forward cannot be used with a telephone that is not connected to your Norstar system.
- Call Park      **Link**  **\*** **7** **4**  
 Parks the call on hold. The call can be retrieved from any other telephone within the system. After an external call is parked, and is not answered within a specified time, the call returns to the I-ATA. An unanswered intercom call does not return to the I-ATA  
 The I-ATA can only park calls on X09. X is 1, or the number assigned by your installer or customer service representative as the call park code. You hear an error tone if you attempt to park a second call.
- Call Pick-up – directed      **Link**  **\*** **7** **6** <plus the ringing number>  
 Allows you to answer a ringing telephone within your Norstar system.
- Call Pick-up – group      **Link**  **\*** **7** **5**  
 Allows you to answer a ringing telephone within your Norstar system.

- Call Queuing**       \* 8 0 1  
 Allows you to answer the first incoming external call to your telephone, while you are on a call. All other incoming callers hear a busy signal unless there is another telephone programmed to ring for the call.
- Camp-on**       \* 8 2 <plus internal number>  
 Allows you to reroute an external call to another Norstar system telephone.
- Class of Service password**       \* 6 8 <plus a COS password>  
 Allows you to override restrictions on the telephone or line using a Class of Service password before you enter the restricted number.
- Conference**       \* 3  
 Allows you to establish a three-way conference between you, one external caller and one intercom caller. To establish a conference call:
- Make or answer the first call.
  - Enter  2 . This automatically puts the first caller on hold.
  - Make or answer the second call. If the second caller is busy, replace the handset and enter  2 to return to the first caller.
  - Enter  \* 3 to complete the conference call.
- Conference Hold**      Allows you to put the two conferenced callers on hold. The held callers remain conferenced. To put the conference on hold:
- Enter  2 to put the two conferenced callers on hold.
  - Enter  2 to restore the three-way call.
  -
- Split Conference**      Allows you to alternate between two parties in a three-way conference call. To consult with one caller and put the other caller on hold:
- Enter  # 3 to split the conference.
  - Enter  2 to alternate between calls.
  - Enter  \* 3 to restore the three-way call.



Disconnecting One Party	<p>Allows you to disconnect one party in a three-way conference call. To disconnect a party:</p> <ul style="list-style-type: none"> <li>• Enter <input type="text" value="Link"/> # <input type="text" value="3"/> to put one caller on hold. You are connected with the other call.</li> <li>• Replace the handset.</li> <li>• Lift the handset and enter <input type="text" value="Link"/> <input type="text" value="2"/>. You are connected with the caller on hold.</li> </ul>
Hold	<p><input type="text" value="Link"/> <input type="text" value="2"/></p> <p>Allows you to put an active call on hold and allows it to be picked up from other telephones. When Tones are turned on, a held call reminder tone is heard on external calls only.</p> <p>Retrieve a call on Hold.</p> <p>Enter <input type="text" value="Link"/> <input type="text" value="2"/>.</p>
Hold (continued)	<p><b>Exclusive Hold</b></p> <p><input type="text" value="Link"/> * <input type="text" value="7"/> <input type="text" value="9"/></p> <p>Allows you to put an active call on hold and prevents it from being picked up from other telephones. When Tones are turned on, a held call reminder tone is heard on external calls only.</p>
Last Number Redial	<p><input type="text" value="Link"/> * <input type="text" value="5"/></p> <p>Automatically dials the last external telephone number you dialed.</p>
Link	<p><input type="text" value="Link"/> * <input type="text" value="7"/> <input type="text" value="1"/></p> <p>Generates a Link signal to access non-Norstar features available from other systems or carriers.</p>
Line pools	<p>A line pool allows several telephones to access a group of lines used for outgoing calls. To access a line pool:</p> <ul style="list-style-type: none"> <li>• Enter the line pool access code.</li> <li>OR</li> <li>• Enter <input type="text" value="Link"/> * <input type="text" value="6"/> <input type="text" value="4"/> &lt;plus the line pool code&gt;.</li> </ul>
Messages	<p><input type="text" value="Link"/> * <input type="text" value="1"/> Cancel <input type="text" value="Link"/> # <input type="text" value="1"/></p> <p>Generates a longer Link signal. Use this feature when you want to release a call from your line but retain the use of the line for another call.</p>

- Page**                     \* 6 0 <plus code 1-3> <plus zone 0-6>  
 Allows you to make an announcement to all Norstar telephones programmed to receive a page, as well as any other connected paging equipment. You must enter a paging zone. See “Paging” on page 117 for more information.
- Page (Intercom)**  
 \* 6 1 <plus zone code>
- Page (External)**  
 \* 6 2
- Page (Intercom and External)**  
 \* 6 3 <plus zone code>
- Pause**                     \* 7 8  
 Generates a 1.5-second delay in the sequence of numbers you are entering (for Tone or Pulse dialing).
- Priority Call**             \* 6 9  
 Allows you to interrupt an internal call in progress on a Norstar telephone using Voice Call Deny or Do Not Disturb. The calls at the telephone you are calling are automatically put on hold.  
  
 Telephones must be programmed to use Priority Call. See “Priority Call” on page 68 for more information.
- Privacy**                     \* 8 3  
 Prevents another telephone that shares your line from joining your current call, or permits another telephone that shares your line to join the call.
- Ring Again**             \* 2 Cancel  # 2  
 Allows you to queue a call to another Norstar telephone that is busy or is not answered, or to a busy line in a line pool. You can only use Ring Again on calls placed on an intercom line. When the telephone is available, you are alerted with one short ring from your telephone.

**Reply to a Ring Again signal** To connect with a Ring Again request when you are on a call (or your telephone is off-hook):

- Enter  . This automatically places your call on hold.
- To return to the caller on hold, enter  .

To connect with a ring again request when your telephone is on-hook:

- Lift the handset. The Ring Again number is automatically redialed.

If you do not respond to the Ring Again signal within 30 seconds, Ring Again is canceled.

**Saved Number Redial**  \*

Allows you to save an external number while you are on a call or while the called telephone is ringing. To automatically redial the saved number:

- Enter  \*  .

**System Speed Dial**  \*  <plus the speed dial code>

Allows you to use a speed dial code to quickly dial preprogrammed telephone numbers. See “Using Speed Dial” on page 88 for more information.

You cannot program personal speed dial numbers for the telephone connected to the I-ATA.

**Timed Release**  \*

Generates a longer Link signal. Use this feature when you want to release a call from your line but retain the use of the line for another call.

**Transfer** Allows you to transfer a call. To transfer a call you must have an available intercom line.

- Enter  \*  .
- Enter the transfer destination number.
- Replace the handset.

To Transfer using Conference

- Enter  .
- Make the second call.
- Enter  \* .
- Replace the handset.

**Trunk Answer**  \*

Allows you to pick up a ringing external call on a line for which Ringing Service is turned on.

Voice Call

 \* 6 6 <plus the intercom number>

Allows you to make a voice announcement or begin a conversation through the speaker of a Norstar telephone without making the telephone ring.

## Using a data communication device with the I-ATA

The internal analog terminal adapter (I-ATA) can connect a data communication device such as a fax machine, modem or answering machine to the Compact ICS. In some cases, these devices require additional programming to work properly.

### Turning off tones that can interfere with data transmissions

The tones used for Held Line Reminder, Call Waiting, and Ring Again can disrupt the operation of a device or the transmission of data. Lift the handset and enter  \* 8 0 9 to turn these tones off for the device. Enter  # 8 0 9 to turn the tones back on.

### Programming answering machines or modems to answer calls automatically

The device connected to the Compact ICS using the I-ATA can ring for an external line, or be set up to ring when Ringing Service (Night Service) is turned on. Contact your installer or customer service representative to have these features programmed for your system.

### Using the I-ATA with modems and fax machines

The I-ATA is designed to be compatible with commercial fax and modem equipment. The Compact ICS has been shown to support data transmission rates of up to and including 28.8 kilobits per second (Kbps).

The maximum data transmission rate is subject to the quality of the end-to-end channel and cannot be guaranteed.

---

## Troubleshooting for the device attached to the I-ATA

Check the following before you call a repair person:

- Check to see that the data parameters (for example, Parity or Baud Rate) are set correctly.
- Ensure that tones are turned off for the I-ATA using  \* 8 0 9 .
- Make sure you are dialling out on an intercom or external line. Use  2 to choose an alternate line. Contact your installer or customer service representative to change the prime line for the telephone or device.
- Substitute a single-line telephone for your data communication device. If you receive a dial tone on the single-line telephone, the problem might be with the data communication device.



Integrated Services Digital Network (ISDN) technology provides a fast, accurate and reliable means of sending and receiving data, image text and voice information through the telephone system.

By using Basic Rate Interface (BRI), your ISDN service allows for faster transmission speeds and the addition of a variety of powerful business applications, including remote LAN access, videoconferencing, file transfer and Internet access.

Your installer configures your ISDN services and terminal equipment.

## ISDN BRI

Compact ICS supports the following ISDN services:

- incoming calls
- outgoing calls
- Calling Line Identification Presentation
- Sub-addressing
- bearer capabilities
- teleservices

The Call Forward All Calls feature can be used from ISDN terminals connected to Compact Plus.

Note: Norstar sets can accept voice calls only. Video and data calls do not alert at a Norstar set.

Although an ISDN S-loop or LT-loop can support up to eight devices, the loop has a limit of two B-channels. If both B-channels are in use, other devices on that loop cannot make or receive calls until a B-channel is available, or until both B-channels are available in the case of a video terminal. Thus, the number of terminals installed must take into account whether you require dedicated access for the terminals on that loop.

Note: Norstar set features, other than Transfer and Call Forward All Calls, are not available to ISDN terminals. In addition, you cannot retrieve a parked call, or reach a Direct-Dial set by using the Direct-Dial digit from an ISDN terminal.

## Line access from an ISDN terminal

ISDN terminals do not have line keys or intercom keys as do Norstar telephones. To make an outgoing call from an ISDN terminal, access an external line by entering a line pool code or by using the ARS feature.

## ISDN BRI features

Selected ISDN network features can be used from a Norstar telephone. Your central office switch (ISDN network) determines which features are available to you.

## Network Name Display for BRI

Your Norstar system displays the name of an incoming call when it is available from the service provider. Name information can be displayed on a Norstar set but not on an ISDN terminal. If the Calling Party Name has the status of private it may be displayed as Private name. If the Calling Party Name is unavailable it may be displayed as Unknown name.

Your Norstar system displays the name of the called party on an outgoing call, when it is provided by your service provider.

Your Norstar system sends the Business Name concatenated with the set name on an outgoing call but only after the Business Name has been programmed.

The available features include:





- Receiving Connected Name
- Receiving Calling Name
- Receiving Redirected Name
- Sending Connected Name
- Sending Calling Party Name



---

Consult your customer service representative to determine whether or not this feature is compatible with your service provider.

## Name and number blocking for BRI

When activated,     allows you to block the outgoing name and/or number on a per-call basis. Name and number blocking can be used with a Norstar set but not with an ISDN terminal.

Consult your customer service representative to determine whether or not this feature is compatible with your service provider.

## Service provider features

Consult your customer service representative to determine if the new ISDN features are supported with your service provider.

## Call Forward

Call Forward allows you to forward your calls to an external telephone number.

1. Select an ISDN line by selecting a line button, a line pool, or the Handsfree button, or by lifting the handset (if an ISDN line is your prime line).
2. Consult your service provider for the appropriate feature code to enter on your dialpad. Listen for three tones followed by dial tone.
3. Enter the internal number of the telephone to which you want your calls forwarded. If the call is answered, stay on the line for at least five seconds to activate the Call Forward feature.

## Canceling Call Forward

1. Select an ISDN line by selecting a line button, a line pool, or the Handsfree button, or by lifting the handset (if an ISDN line is your prime line).
2. Consult your service provider for the appropriate feature code to enter on your dialpad. Listen for a series of tones.
3. Press .

## Calling the number your calls are forwarded to

1. Select an ISDN line by selecting a line button, a line pool, or the Handsfree button, or by lifting the handset (if an ISDN line is your prime line).
2. Consult your service provider for the appropriate feature code to enter on your dialpad.

## Automatic Call Back

If you call a number that is busy, enter the feature code designated by your service provider to receive a distinctive ring at your set when the line becomes available for calls.

## Automatic Recall

Automatic Recall allows you to automatically dial the number of the last call you received. You may not see the number on the display if the information is not available from your service provider, or you do not have Caller ID as part of your ISDN service.

Consult your service provider for the appropriate feature code to enter on your dialpad.

## MCID

The MCID feature allows you to use     to have call information recorded on the central office system for an incoming call on a specific line (EUROISDN lines, only).

The user must invoke the feature code without hanging up, and within 30 seconds (time varies on different networks) after the caller hangs up.

## Network Call Diversion

This feature is a network function that allows forwarding and redirection of calls outside the Norstar network when using an ETSI ISDN line. Functionality is similar to that of External Call Forward (ECF). NCD

redirects calls using the same line on which they arrive. Call forward is efficient since there is no need for additional outside lines.

## **ISDN BRI terminals**

Your Compact ICS supports up to 8 Basic Rate Access loops (four 2B+D channels) that can be used for fully digital connections to ISDN networks and devices. Loops are connections between the ICS and devices or between the ICS and the network.

Each loop provides two separate B-channels that can be used to make two simultaneous voice or data calls, or one data call and one voice call.

## **ISDN applications**

ISDN terminal equipment delivers a wide range of powerful business applications:

### **Videoconferencing and video telephony**

Videoconferencing offers instant visual and audio contact between distant parties using either studio-based or desktop ISDN terminals.

### **Desktop conferencing**

ISDN allows computer users in distant locations to share and edit any image, data or text file on their own computer screens while they discuss the information.

### **File transfer**

The ISDN network allows you to transfer files containing data, text, images, data, or audio clips, faster and cheaper than with a conventional modem.

## **Telecommuting**

Convenient retrieval, processing and storage of files is possible for the employee working at home by using ISDN lines to give high-speed access to information resources at the office.

## **Group 4 fax**

ISDN fax applications save money by increasing both transmission speed and the quality of resolution.

## **Remote LAN access**

ISDN provides an affordable and fast means for employees at remote sites (at home or branch offices) to access local area networks (LANs).

## **Leased line backup**

Essential backup for leased lines can be provided using ISDN as required, rather than duplicating costly permanent leased lines.

## **LAN to LAN bridging**

Local area network (LAN) bridge/routers allow flexible interconnection between LANs using ISDN, with charges only incurred when information is actually transmitted.

## **Internet and database access**

The fast call set up and high bandwidth of ISDN are ideal for accessing information services such as the Internet and databases.

# Using System features

## Using alternate or scheduled services

There are three types of Services to make your Norstar system handle calls differently on different days and at different times of the day: Ringing service, Restriction service and Routing service.

Each of the three services, and the six schedules available to each service, are customized for you by your installer or customer service representative. They program which telephone is used to turn Services on and off, and display what Services are in use. This is called the control telephone.

## Preventing certain calls from being made

Restriction service prevents a user from making certain kinds of calls from a telephone or from lines that are available at the telephone. The restrictions are programmed by your installer or customer service representative.

## Making additional telephones ring

Ringing service makes additional telephones ring for incoming calls on external lines. For instance, all incoming external calls can ring at a security guard's telephone during the night, or calls to one attendant can ring at another attendant's telephone during lunch. It does not suppress your normal ringing assignment.

## Changing the lines used by outgoing calls

Routing service allows you to assign alternate routes to calls. In this way you can take advantage of lower costs available on particular routes on certain days and at certain times. Both the regular and alternate routes are programmed by your installer or customer service representative.

## Turning Services on and off

The master control for how different services and their schedules are used by your system is in programming. There are three settings: Manual, Automatic and Off.

- Manual allows you to turn the service on and off at any time from a control telephone using a feature code.
- Automatic allows you to use the preassigned stop and start time for a service. You are able to start and stop the service by entering the appropriate feature code at a control telephone. If you select this setting, you use the start and stop times programmed by your installer or customer service representative.
- Off prevents the service from being activated.

You need the programming template found at the front of this guide. See “Getting started with Norstar” on page 13 for more information.

1. Press  \* \* 2 6 6 3 4 4 .
2. Press      (the default System Coordinator password).
3. Press  twice.
4. Press  at **Services**.
5. Press  until you see the Service you want to program.
6. Press  and  until you see the schedule you want to program.
7. Press  and use **CHANGE** to select the setting that works best for your office: **Off**, **Manual** or **Automatic**.

Each schedule can have its own configuration of a Service which works independently of automatic start and stop times. For example, there may be a version of Restriction service called Night Schedule that prevents anyone from making long distance calls. But calling it Night Schedule does not mean it can only be used with a schedule. You can turn the Night Schedule for Restriction Service on or off as needed any time of the day or night. If you decide to run a service on a schedule, the system uses the start and stop times used for that schedule.

## An example of how to turn on a Service manually

You may have Ringing service (your night service) set up to run according to the Night Schedule. You may decide you want that ringing arrangement to come into effect only when it is turned on and off manually.

You need the programming template found at the front of this guide. See “Getting started with Norstar” on page 13 for more information.

1. Press  \* \* 2 6 6 3 4 4 .
2. Press      (the default System Coordinator password).
3. Press  twice.
4. Press  at **Services**. The display shows **Ringing Service▶**.
5. Press . The display shows **Sched:Night▶**.
6. Press  and use **CHANGE** to set the Service to **Manual**.

Night Schedule for Ringing Service no longer follows the schedule but can be turned on and off by using the feature code and selecting Night Ringing. See “Turning Services on and off using feature codes” on page 199.

## Turning Services on and off using feature codes

The master control for services is in programming. See “Turning Services on and off” on page 198. Day-to-day use of Services is controlled using the following feature codes.

<input type="text" value="☎"/> 8 7 1	Turns on Ringing service. When used at the direct-dial telephone, it activates the alternate direct-dial telephone (extra-dial telephone).
<input type="text" value="☎"/> # 8 7 1	Turns off Ringing service.
<input type="text" value="☎"/> 8 7 2	Turns on Restriction service.
<input type="text" value="☎"/> # 8 7 2	Turns off Restriction service.
<input type="text" value="☎"/> 8 7 3	Turns on Routing service.
<input type="text" value="☎"/> # 8 7 3	Turns off Routing service.

To turn a Service on

1. Enter the appropriate feature code from a control telephone.
2. For Restriction and Routing service you have to enter the System Coordinator or Basic password.
3. Press **NEXT** to move through the schedules until the display shows the version of the service you want to be turned on.
4. Press **OK** to select the setting, or press **QUIT** to exit the feature without making any changes.

To turn a Service off

1. Enter the appropriate feature code from a control telephone.
2. For Restriction and Routing service you have to enter the System Coordinator or Basic password.



***Do not confuse activating Normal service with canceling a Service.***

Setting a Service to Normal is not the same as canceling a Service using a feature code. If you set the Service to Normal, the normal version of a Service overrides any automatic schedule and remains in effect until you manually cancel it. If you cancel the Service, you return to the automatic schedule.

## Viewing the active Services from a two-line display telephone

When a Service is active, the control telephone display shows **Services ON**.

1. Press **LIST**. The display shows the first active Service and the schedule that is in use.
2. If there are several active Services, press **NEXT** to see them all.
3. Press **EXIT** to exit the feature.



## Viewing the active Services from a one-line display telephone

1. Press    . The first active Service displays.
2. Press  to move through the active schedule.
3. Press  to exit.

### Displays

```
<Sched> Restr'n
EXIT          NEXT
```

You are viewing the active Services. Press  or NEXT to see the other active Services. Press  or EXIT to quit.

```
<Sched> Restr'n
QUIT   OK   NEXT
```

The name of the current Restriction service schedule is displayed. Press  or NEXT to see the other Ringing service schedules. Press  or OK to select the desired schedule.

```
<Sched> Ringing
EXIT          NEXT
```

You are viewing the active Services. Press  or NEXT to see the other active Services. Press  or EXIT to quit.

```
<Sched> Ringing
QUIT   OK   NEXT
```

The name of the current Ringing service schedule is displayed. Press  or NEXT to see the other Ringing service schedules. Press  or OK to select the desired schedule.

```
<Sched> Routing
EXIT          NEXT
```

You are viewing the active Services. Press  or NEXT to see the other active Services. Press  or EXIT to quit.

```
<Sched> Routing
QUIT   OK   NEXT
```

The name of the current Routing service schedule is displayed. Press  or NEXT to see the other Routing service schedules. Press  or OK to select the desired schedule.

```
<Sched> until *
QUIT   OK   NEXT
```

Press  or OK to select this schedule,  or NEXT to see the next available schedule, or  or QUIT to exit. If you select this schedule, it is in effect until the next automatic schedule takes effect.

```
No services ON
```

You have entered the Show Services feature code and there is no active Service.

Services	ON	There is a Service active in your system. Press <input type="checkbox"/> or <u>LIST</u> to view the active Services.
	LIST	

For other displays, see “Common feature displays” on page 229.

Services that have been turned on automatically are indicated by an asterisk (\*) before the name on the display. You can neither manually activate nor cancel scheduled services, although you can override them by manually turning on another schedule.

The control telephone can override Services that are turned on and off according to a schedule at any time by entering a Services feature code, and selecting a different schedule. This override remains in effect until it is canceled. If you select a schedule with an asterisk (\*), the next automatic service schedule comes into effect at the programmed time.

Direct-dial calls to a direct-dial telephone ring at the extra-dial telephone (the extra-dial telephone is designated by your installer or customer service representative) only when you enter the Ringing service feature code (  8  7  1) at that direct-dial telephone. Note that only the extra-dial telephone is activated, not the actual Ringing service (unless that direct-dial telephone is a control telephone).



**Tip** - *Norstar provides six service schedules named Night, Lunch, Evening, Sched 4, Sched 5, and Sched 6. Your installer or customer service representative can change these names to suit your business.*

## Using passwords

Your passwords prevent unauthorized or unintentional changes to your Norstar system. To keep your telephone service secure, distribute the password only to selected personnel or make use of the basic password described below. Record your password in a secure place and change it periodically.

If you forget the administration or basic passwords, you cannot do any programming. Call your customer service representative to assign a new password.

The password is a one to six-digit number.

The default System Coordinator password is **A D M I N**, which is the same as **2 3 6 4 6**.

One password cannot be a subset of another one. For example, you cannot have 123 and 12345.

## Using a Basic password

In addition to a System Coordinator password, there is a Basic password. This allows you to delegate some of the duties of being a system coordinator to someone else without allowing access to sensitive programming.

The default Basic password is **B A S I C** or **2 2 7 4 2**.

You can enter the Basic password after the following feature codes:

- **\* \* U S E R** (User Preferences)
- **\* \* T I M E** (to change the system time and date)
- **\* 8 3 1** (turn System Answer on or off)
- **\* 8 3 2** (turn Custom Call Routing on or off)

Because the Basic password can be used to change the time, you should give it out with care and change it when necessary (for example, when an employee leaves the company). If restrictions, routing or other services operate on a schedule, changing the time can allow someone to bypass the programming.

## Changing passwords

You need the programming template found at the front of this guide. See “Getting started with Norstar” on page 13 for more information.

1. Press **\* \* 2 6 6 3 4 4**.
2. Press **2 3 6 4 6** (the default System Coordinator password).
3. Press **Next** four times.
4. Press **Show** at **Passwords**.

5. Press  until you see **PROGRMING Pswds ▶**.
6. Press .
7. Press  until you see the name of the password you want to change.
8. Use , **CHANGE** and the dialpad to enter the new password. Press **OK** to accept the new password.

You cannot erase or eliminate the ability to program passwords.

## Clearing a Call Log password

If an individual has forgotten their Call Log password, you can clear it in programming. The individual can then enter a new password from his or her telephone.

You need the programming template found at the front of this guide. See “Getting started with Norstar” on page 13 for more information.

1. Press  \* \* 2 6 6 3 4 4 .
2. Press      (the default System Coordinator password).
3. Press  four times.
4. Press  at **Passwords**.
5. Press  until the display shows **Call log Pswds**.
6. Press  and enter the internal telephone number of the telephone where you want to clear the Call Log password.
7. Press , then press **CLR** to clear the password.

## Hospitality password

There are two passwords within the Hospitality feature. One provides secure access to the administration set for programming the service, and one provides secure access to a room condition setting from each room set for housekeeping staff.

## Desk pswd

Change this password frequently, to maintain security.

At Hospitality:

1. Press .
2. Desk Pswd:4677 displays.
3. Press CHANGE.
4. New Pswd: displays
5. Enter a new password, then press OK.

## Cond pswd

Change this password frequently, to maintain security.

At Hospitality:

1. Press .
2. Press .
3. Cond Pswd:None displays.
4. Press CHANGE.
5. New Pswd: displays
6. Enter a new password, then press OK.

# Using special telephones

## Direct-dial

You can reach the direct-dial telephone by dialing a single digit. The direct-dial telephone is usually in a central location, such as a attendant's desk. It is usually the prime telephone or the central answering position (CAP).

The direct-dial telephone can send up to 30 messages and can invoke Services to activate the extra-dial telephone.

You cannot forward calls to a direct-dial telephone that is outside your Norstar system. See “Making changes to Call Forward No Answer” on page 35.

Note: ISDN terminals cannot use the Direct-Dial digit to reach a Direct-Dial set.

## Changing the direct-dial telephone assignments

Your installer or customer service representative sets up the direct-dial telephone.

You can change which direct-dial telephone a telephone is assigned to, or assign it no direct-dial telephone.

You need the programming template found at the front of this guide. See “Getting started with Norstar” on page 13 for more information.

1. Press   \* \*       .
2. Press      (the default System Coordinator password).
3. Press  at **Terminals&Sets**.
4. Enter the internal number of the telephone you want to program and press . The display shows **Capabilities**.
5. Press .
6. Press  until the display shows **D-Dial**.
7. Press **CHANGE** to select either **Set.1** or **None**.

Any number of telephones can be assigned to call the direct-dial telephone.



**Tip** - *The digit you dial in order to get the direct-dial telephone to ring can be programmed by your installer or customer service representative*

## Hotline

A hotline telephone calls a preset internal or external telephone number when you pick up the handset (or press the key marked Handsfree/Mute).



**Tip** - *Label the telephone to inform anyone using it that Hotline is active.*

## Bypassing a Hotline

Press a line button, or use the Pre-Dial or Automatic Dial feature before you pick up the handset or press the key marked Handsfree/Mute on a hotline telephone. See the Telephone Feature Card or see “Changing how you dial your calls” on page 67.

## Making a telephone a hotline telephone

You can set up a telephone as a hotline.



**Tip** - *A Hunt Group set DN can be specified as a Hotline telephone. For more information on Hunt Groups see “Programming Hunt Groups” on page 155.*

You need the programming template found at the front of this guide. See “Getting started with Norstar” on page 13 for more information.

1. Press  \* \* 2 6 6 3 4 4 .
2. Press      (the default System Coordinator password).
3. Press  at **Terminals&Sets**.
4. Enter the internal number of the telephone you want to program and press . The display shows **Capabilities**.
5. Press .

6. Press  until the display shows **Hot.line**.
7. Press **CHANGE** to select the type of call the hotline makes: **None**, **Intrnl**, or **Extrnl**.

Internal assigns an internal number.

External assigns an external number. If you select an external number, you can select the line on which the call is made: the prime line, an external line, a line in a line pool, or a line selected by the routing table. If you select a line pool, you have to specify the line pool access code. If you select the routing table, the number dialed is treated as a destination code and is routed according to the routing tables.

A telephone prime line, line pool access codes, and access to a line pool can be programmed by your installer or customer service representative.

## Control telephone

The control telephone allows you to place the telephones and external lines for which it has responsibility into and out of service schedules. See ‘Using alternate or scheduled services’ on page 197.

## Using Set lock

Set lock limits the ways in which you can customize your telephone. There are three levels of Set Lock: Full, Partial, and no set lock. With no set lock, you have access to all features on your telephone.

Partial prevents:

- |  |   |
|--|---|
| <ul style="list-style-type: none"> <li>• programming autodial buttons</li> <li>• programming user speed dial numbers</li> <li>• programming feature buttons</li> <li>• moving line buttons</li> <li>• changing the display language</li> </ul> | <ul style="list-style-type: none"> <li>• changing dialing modes (Automatic Dial, Pre-Dial, and Standard Dial)</li> <li>• using Voice Call Deny</li> <li>• saving a number with Saved Number Redial</li> </ul> |
|--|---|



Full, in addition to the restrictions outlined for Partial lock, prevents:

- |                             |                                |
|-----------------------------|--------------------------------|
| • changing Background Music | • using Call Forward all calls |
| • changing Privacy          | • using Send Message           |
| • changing Do Not Disturb   | • using Trunk Answer           |
| • using Ring Again          | • activating Services          |

## Changing Set Lock programming for a telephone

You need the programming template found at the front of this guide. See “Getting started with Norstar” on page 13 for more information.

1. Press  \* \* 2 6 6 3 4 4 .
2. Press      (the default System Coordinator password).
3. Press  at **Terminals&Sets** and enter the internal number of the telephone you want to program.
4. Press  .
5. Press  until the display shows **Restrictions**.
6. Press  twice.
7. Use **CHANGE** to select one of the three options: **None**, **Partial** and **Full**.

## Using an auxiliary ringer

An auxiliary ringer is a separate device that has to be connected to Norstar.

## Turning the auxiliary ringer for a telephone on or off

You need the programming template found at the front of this guide. See “Getting started with Norstar” on page 13 for more information.

1. Press  \* \* 2 6 6 3 4 4 .
2. Press      (the default System Coordinator password).
3. Press  at **Terminals&Sets**.
4. Enter the internal number of the telephone you want to program and press  . The display shows **Capabilities**.

5. Press .
6. Press  until the display shows **Aux. ringer**.
7. Use **CHANGE** to select **Y** (Yes) or **N** (No).

Your installer or customer service representative can program the auxiliary ringer to start ringing for incoming lines as part of Ringing Service.

## Using Host System dialing signals

You can access host systems, such as private branch exchanges (PBX) from Norstar by using host system signaling features (also known as end-to-end signaling). These features either send a special signal to the host system or allow you to program delays required by host systems in external autodial or speed dial sequences.

## Link

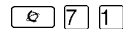

If your Norstar system is connected to a private branch exchange (PBX), you can use a Link signal to access special features. On some telephones, Link is called FLASH.

The Link signal can be included as part of a longer stored sequence on an external autodial button or in a speed dial code. The Link symbol () uses two of the 24 spaces in a dialing sequence.

## Preventing a telephone from using Link

Link can be restricted at individual telephones.

You need the programming template found at the front of this guide. See “Getting started with Norstar” on page 13 for more information.

1. Press  \* \* 2 6 6 3 4 4.
2. Press 2 3 6 4 6 (the default System Coordinator password).
3. Press  and enter the internal number of the telephone you want to program.

4. Press .
5. Press  three times. The display shows **Restrictions**.
6. Press  twice.
7. Press  three times. The display shows **Allow link:**.
8. Press **CHANGE** to choose **Y** (Yes) or **N** (No).



**Tip** - If your Norstar system is connected to a private branch exchange (PBX), program Link onto a memory button for one-touch access.

## Pause



The Pause feature enters a 1.5-second delay in a dialing sequence on an external line. This is often required for signaling remote devices, such as answering machines, or when reaching through to PBX features or host systems.

You can program more than one pause in an external autodial or speed dial sequence.

The Pause symbol () uses one of the 24 spaces in a dialing sequence.

For pulse dialing,  inserts a 1.5-second pause into the dialing sequence.

## Long Tones

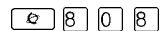



The Long Tones feature allows you to control the length of a tone so that you can signal devices such as fax or answering machines which require tones longer than the standard 120 milliseconds.

1. While on a call, press   .
2. Press the dialpad buttons to produce the appropriate tones. Each tone sounds for as long as you hold down the button.

Long tones can be used on any call except a conference call. You can use internal lines of the Norstar system to activate a device connected to an analog terminal adapter (ATA) in another area of your office, or external lines to access devices outside the Norstar system.

## Displays

### Long Tones:

At the appropriate time, press any dialpad button. Hold each button down for as long as necessary. Press  or  to cancel Long Tones.

## Programmed Release



The Programmed Release feature performs same function as  in a programmed dialing sequence. When the system encounters Programmed Release in a dialing sequence, it stops dialing and hangs up the call.

The Programmed Release symbol () takes up two of the 24 spaces in a programmed dialing sequence.

The system ignores any digits or commands that follow a Programmed Release in a programmed dialing sequence.

## Run/Stop



Run/Stop inserts a break point into a sequence of dialed numbers or characters used for automatic dialing. This may be necessary when you are connecting to a PBX or similar host system.

For example, you can call a company with an automated attendant that instructs you to dial the internal number you need. You can program the company number, a Run/Stop, then the internal number on one external autodial button. Press the autodial button once to dial the company number. When you hear the automated attendant, press the autodial button again to dial the internal number.

The Run/Stop symbol () uses one of the 24 spaces in an autodial or speed dial sequence.

You can include up to three Run/Stop commands in a dialing string. The system ignores a fourth Run/Stop, and any digits or commands that follow it in a programmed dialing sequence.

## Wait for Dial Tone

 8 0 4

Wait for Dial Tone causes a sequence of numbers to pause until dial tone is present on the line before continuing to dial. This is useful if you must dial a remote system and then wait for dial tone from that system before dialing the rest of your number.

The Wait for Dial Tone symbol () uses two of the 24 spaces in an autodial or speed dial sequence.

### Displays

Invalid code

You have entered a code that can only be used in a programmed autodial or speed dial sequence, not on a call you dial directly. Programmed Release and Run/Stop are for use in programmed dialing sequences only.

## Using pulse dialing for a call

If your external telephone lines use pulse dialing, you can temporarily switch to tone dialing by pressing  after selecting the line. Tone dialing allows your Norstar telephone to communicate with devices and services that respond to tone signals, such as automatic switchboards, and fax or answering machines.

## Using your Norstar system from an external location

You can use the lines and some of the features of a Norstar system from outside the system. You can do this over the public telephone network when you are away from the office, or you can call from another system, over a private network.

An example of how remote access works is a sales representative who spends a lot of time out of the office needs to make long distance calls to

the European office. Your Norstar system has a leased line to Europe with reduced transatlantic charges. You provide that sales representative with a Class of Service password that gives access to the transatlantic line. The sales representative can then telephone into the Norstar system from a hotel, enter their Class of Service password, and use the leased transatlantic line to make calls.

Remote users can access Norstar lines, line pools, the page feature, and remote administration (if enabled through Software Keys). The exact facilities available to you through remote access vary depending on how your installer or customer service representative set up your system.

## Controlling access to your Norstar system

It is important to maintain the security of your Norstar system by limiting access to authorized users and limiting those users to the features they need.

	<b><i>Remote users can make long distance calls.</i></b>
<p>Remember that a remote user can make long distance calls that are charged to your company and can make page announcements in your office.</p>	

## Direct inward system access (DISA)

Control access to your Norstar system with direct inward system access (DISA). Access to your Norstar system from the public telephone network should always be controlled with DISA. If your installer or customer service representative programs the line used for remote access to answer a call automatically and wait for a DISA internal number, callers hear a stuttered dial tone and must enter a Class of Service password before they are allowed into the system.

## Class of Service (COS)

To control the level of telephone service a remote user can access, your installer can assign a remote filter and remote package to the line used for remote access. The remote filter restricts the numbers that can be dialed on the line, and the remote package restricts the use of line pools and the page

feature. To change the restrictions for the line, the user can enter their Class of Service (COS) password when the system answers with DISA, or can dial the DISA internal number and enter their Class of Service password.

## Maintaining security

To maintain the security of your system, the following practices are recommended:

- Warn anyone to whom you give the remote access number to keep it confidential.
- Change Class of Service passwords often.
- Warn anyone to whom you give a Class of Service password to remember it and not to write it down.
- Remove the Class of Service password of anyone who leaves your company.

## Accessing Norstar remotely over the public network

1. Dial the Norstar system's remote access number.
2. When you hear a stuttered dial tone, enter your COS password.
3. Wait for the system dial tone.

If your system is using System Answer or CCR, you may enter the DISA number or Auto DN once your call has been automatically answered by one of the features.

To use the system remotely, you must use a telephone with tone dialing to call the system.

Remote access is possible only on lines that your installer or customer service representative programs to allow auto-answer calls.

To use features on a remote Norstar system, press  followed by the feature code. Even if you are calling from a Norstar system, press  instead of .

In certain situations, you may experience lower volume levels when using Norstar remotely.

## Tones

You may hear some of the following tones while accessing Norstar remotely.

Tone	What it means
Busy tone	Dialed a busy line pool access code. You hear system dial tone again after five seconds.
Norstar system dial tone	You may use the Norstar remotely.
Fast busy tone	You have done one of the following <ul style="list-style-type: none"> <li>• Entered an incorrect COS password. Your call is disconnected after five seconds.</li> <li>• Taken too long while entering a COS password. Your call is disconnected after five seconds.</li> <li>• Tried to use a line pool or feature not permitted by your Class of Service. You hear system dial tone again after five seconds.</li> <li>• Dialed a number in the Norstar system which does not exist. Your call is disconnected after five seconds.</li> </ul>
Stuttered dial tone	Enter your COS password.

## Using Class of Service (COS) passwords

Class of Service passwords permit controlled access to a system's resources both by internal and remote users. When you enter a Class of Service password at a telephone, the restriction filters associated with your Class of Service password apply, rather than the normal restriction filters.

Similarly, when a remote user enters a Class of Service password on an incoming auto-answer line, the restriction filters and remote package associated with their Class of Service password apply, rather than the normal restriction filters and remote package. COS passwords are programmed by either your customer service representative or installer.

Users should memorize their COS passwords instead of writing them down. Employee COS passwords should be deleted when they leave the company. Typically, each user has a separate password. Several users can share a password or one user can have several passwords.



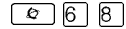

## Changing your Class of Service



You must enter a Class of Service password each time you want to make a call that is normally restricted on a line or telephone.

To change the restriction filters on a line or telephone:

1. Press  6  8.
2. Enter your six-digit COS password.

COS passwords allow you to define individual passwords and determine the restriction filters, and remote package associated with each.



**Tip** - *If you use your Norstar system from outside the office, you may have to enter a Class of Service password to gain access to the system. See “Using your Norstar system from an external location” on page 213.*

### Displays



(Blank display) Enter your password. It is not shown on the display.

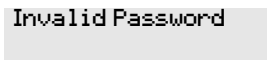

You have entered a password that is not programmed into your system.



# General System features

The following features are available for the entire Norstar system.

## Disconnect supervision



When Disconnect Supervision is assigned to a line, the Norstar system monitors it to detect if an external caller hangs up. This allows the system to release the line for other uses. Your installer or customer service representative assigns disconnect supervision.

## Hunt Groups

Your Norstar system now allows you to establish Hunt Groups in your system. Hunt Groups are a group of Norstar sets that can be called by a single directory number. The Hunt Groups feature ensures calls are easily routed to the appropriate people. For more information on Hunt Groups see “Programming Hunt Groups” on page 155.

## Internal numbers

Each telephone in the Norstar system has its own internal number. The length of internal numbers in your system can be from two to seven digits. All numbers in your system are the same length. Your installer or customer service representative sets the length of internal numbers (called the DN length).

To find out your internal number, use the Button Inquiry feature (  \*  ) on an intercom button. On the M7100 or T7100 telephone, Button Inquiry shows your internal number followed by the function assigned to your single-memory button.

## Line assignment

Any of the lines in your system can be assigned to any of your telephones. Your installer or customer service representative assigns lines to telephones in Configuration programming. Lines can be assigned to appear only, appear and ring, or to ring only.

Usually, only the lines that are appropriate for a particular person appear at that person's telephone. When a line is assigned to a telephone it is automatically given a line button on that telephone, if a button is available. The M7100 T7100 telephones do not have line buttons.

Calls on lines that ring but do not appear at a telephone are presented at an intercom button.

You may be able to answer a call on a line that does not appear or ring at your telephone. To pick up such a call, use Call Pickup, Call Park, or Trunk Answer.

A telephone may have buttons assigned for lines 001 to 003, but have only lines 001 and 002 programmed to ring as well. An incoming call on any of the three lines causes a line button indicator to flash, and the telephone can be used to answer the call. This is especially useful for people who monitor other telephone lines, but want only their own lines to ring.

## Target line

A target line is used to route a call directly to a particular telephone or group of telephones.

Target lines are used only for incoming calls and appear on the Intercom button. A single incoming line may provide connections to several different target lines. This allows each person or department in the office to have their own number without having a separate external line for each number.

**Note:** Although target lines can be set to Private (default is Public), features such as Call Pickup can still answer these calls at remote telephones.

## Line pools

A line pool allows each telephone access to external lines from a group (or pool) of external lines. You can access such lines by pressing an intercom button and entering a line pool access code or by pressing a memory button programmed with the line pool feature code and a line pool access code.

## Overflow call routing

If a call comes in for a target line that is busy, Norstar routes the call to the prime telephone for that target line. If there is no prime telephone assigned to the target line or if a call cannot be directed to a target line, the call goes to the prime telephone for the external line used.

Overflow routing for incoming calls is used with the Routing Service programmed by your installer. A Service must be active for overflow routing to be in effect. Overflow routing is not available in normal service.



**Tips** - *When you make a call and the programmed route is busy, you hear the expensive route warning tone. Your telephones displays an expensive route warning. To avoid using the normal, expensive route, release your call.*

*Overflow routing directs calls using different line pools. Therefore, a call may be affected by different line filters when it is handled by overflow routing.*

## M7100 and T7100 telephones

Because these sets do not have line buttons, they sometimes works slightly differently from other Norstar telephones. Where other telephones can require that you select a line button to answer a call, on the these sets you simply pick up the receiver. Where other telephones require you to select a line button to take a call off hold, you press  on the these sets.

Also on these sets, you can answer a second call by pressing . Your active call is put on hold and you are connected to the waiting call. You can have no more than two calls at a time.

There is no Handsfree button on these sets. When applicable, special instructions for the sets are included with each feature description.

## Memory buttons

Memory buttons are the buttons with indicators on the M7208, M7310, and M7324 telephones and the T7208 and T7316 Business Series Terminals. The M7310 also has dual buttons without indicators. There is a single memory button, without an indicator, on the M7100 and T7100 telephones.

Memory buttons can be used as answer, autodial, line, and programmed feature buttons. Line, intercom and answer buttons must have indicators.





## One-line display

The M7100, M7208, T7100, and T7208 telephones have a one-line display. Other sets have a second line on the display which shows the functions of the three buttons directly below it. These indicators are known as display buttons.

Some display buttons, such as TRANSFER and ALL, are simply shortcuts which are not available on a one-line display.

Other display buttons, such as OK and SHOW, perform essential functions. For a one-line display telephone, use the following buttons instead of these display buttons.

### Substitutes for display buttons

Display button	Dialpad button	Display button	Dialpad button
<u>OK</u>		<u>CANCEL</u>	#
<u>QUIT</u>		<u>VIEW</u>	#
<u>ADD</u>	*	<u>OVERRIDE</u>	#
<u>SHOW</u>	#	<u>BKSP</u>	 

All displays listed in this book are shown as they appear on the two-line display.

## Prime line

Your telephone can be programmed to select an internal or external line or a line pool automatically whenever you lift the handset or press the button marked Handsfree/Mute. This is your prime line.

## Private lines

A private line is exclusive to a particular telephone. Calls that are put on hold or left unanswered on a private line cannot be picked up at any telephone except the prime telephone.

## Volume bar

The volume bar controls the volume of the handset, telephone ringer, handsfree speaker, and headset. Press either end of the volume bar

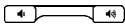

to adjust the volume.





# Troubleshooting

## Using the alarm telephone

An alarm telephone displays Norstar's system alarm codes, should they occur. It is a Norstar telephone with a two-line display (T7310, T7316, M7310 or M7324 telephones) that the installer or customer service representative has assigned as an alarm telephone.

## Reporting and recording alarm codes

If an alarm message appears on the alarm telephone display

1. Record the alarm number.
2. Press **TIME** and record the time displayed.
3. Call your installer or customer service representative and report the alarm code.
4. After speaking to your installer or customer service representative, press **CLEAR**.

### Displays



Alarm:	61-4-2
TIME	CLEAR



Report this alarm and the time it occurred to your installer or customer service representative.

## Testing the telephone

If you suspect something is wrong with a button, the speaker, the displays, or some other part of the telephone hardware, you can do a quick test to see which part of the telephone is broken.









**Tip** - Ensure that the function of a button matches the label by pressing    then the button.

You can end the telephone testing session anytime by pressing  or , unless you are testing those buttons. The test feature times-out after 30 minutes of no activity.

## Testing the telephone display







Use a display test if you suspect that one of the indicators on the telephone is not working.

1. Press    . The display shows **Display test**.
2. Press **TEST** or  to go ahead with a display test.
3. Adjust the contrast for the telephone display so you are able to see the test results clearly. Enter a number to change the contrast or press **DOWN** and **UP**.
4. Press **OK** or  to go ahead with the test.

During the test, the display should be filled with solid, dark blocks and all the indicators next to the buttons on the telephone should be turned on. Any Busy Lamp Field (BLF) or CAP modules that are attached to the telephone should be completely lit. You lose any information that was showing on the BLF before the test started.







Pressing any button ends the test.

## Testing the telephone buttons

1. Press    , then  or **NEXT**.
2. Press **TEST** or  to go ahead with a button test.
3. Press button to see its function. If the button you pressed uses an indicator, it should turn on when you test the button.
4. Pressing the  button puts **Rls button** on the display briefly and returns you to the **Button test** display.

## Testing the speaker in the telephone handset

The handset test is not available if you have a headset plugged into the telephone.



1. Press    , then  or **NEXT** twice. The display shows **Handset test**.
2. Press **TEST** or  to go ahead with a handset test.

3. Pick up the handset and listen. You should hear dial tone through the handset at a maximum volume. The volume is reset to maximum only while the test is going on.

Pressing any button or hanging up ends the test.



## Testing the telephone headset

The headset test is not available to telephones that do not have a headset jack or a headset plugged in.

1. Press  8 0 5, then  or **NEXT** until the display shows **Headset test.**
2. Press **TEST** or  to go ahead with a headset test.

You should hear dial tone through the headset. The volume is reset to a default level during the test. Pressing any button ends the test.



## Testing the telephone speaker

1. Press  8 0 5, then  or **NEXT** until the display shows **Speaker test.**
2. Press **TEST** or  to go ahead with a speaker test.

You should hear page tone through the telephone speaker at the maximum volume. The volume returns to its previous setting when you end the test.

Pressing any button ends the test.

## Testing the power supply to a telephone

1. Press  8 0 5, then  or **NEXT** until the display shows **Power test.**
2. Press **TEST** or  to go ahead with a power supply test.

You should see all the indicators on the telephone go on and hear ringing at maximum volume. When the test has ended, the display should briefly show **Power OK.**

The test lasts for five seconds or until you press a button.



# Common feature displays

You may see the following displays when you use a feature.

Access denied

Someone is already using programming, or the feature you are trying to use is not compatible with the configuration of the telephone or line.

Denied in admin

You have tried to use a feature, but you have not been given access to it in administration programming.

Feature timeout

You have taken more than 15 seconds to press a button in response to a display.

Inactive feature

You have entered a feature code that is used by an application program that your system does not have.

Invalid code

You have entered an invalid feature code.

Not available

You have tried to use a feature that is not available in the present setup of your Norstar system.

Set locked

You cannot use the feature you have chosen because your telephone is locked. See "Using Set lock" on page 208.

1234567890123...

VIEW→ OK

Press **#** or press VIEW→ or ←VIEW to view a number that is too long to fit on the display. Press  or OK when you are finished.

5

This indicates a long distance call. (May be available with Call Display services.)

39>21

Either you are receiving an internal call from telephone 39 forwarded by telephone 21 or you have an Answer button for telephone 21 and an internal call from 39 is ringing on 21.

21

TRANSFER

You are connected to an internal call. Press TRANSFER to transfer the call.

21 calling9

You are receiving a call from telephone 21.

Call 21?

YES NO

You have received a Ring Again offer for a call to an internal telephone. Press the flashing internal line button or YES to call the number again. On M7100 or T7100 telephones, just lift the handset. Otherwise, press NO or wait 30 seconds for the Ring Again offer to expire. For an explanation of Ring Again, see “Using Ring Again” on page 70.

Camped: 21

CALLBACK

The person to whom you camped the call did not answer it. The call has come back to you. Press the line button or CALLBACK to reconnect to the call.

Line001

TRANSFER

You are connected to an external call. Press TRANSFER to transfer the call.

Line001>21

Either you are receiving an external call forwarded from telephone 21 or you have an answer button for telephone 21 and an external call is ringing on that telephone.

Line001 transfer

The call on line 001 is being transferred to you by someone else in your Norstar system.

Line001 waiting

A camped call is waiting. Press the line button or use Call Queuing to answer the call. Press  if you have M7100 or T7100 telephones.

No calls waiting

You tried to use Call Queuing but no call was ringing at your telephone.

No line selected

There is no call ringing at your telephone. If you have a flashing line button but your telephone is not ringing, press the line button to answer the call on that line.

Not in service

The telephone to which you directed a call is not in service or is otherwise unavailable. The call is returned to your telephone.

Parked call

CALLBACK

No one answered the call you parked. The call has come back to you.

Pick up receiver

You have used the Call Queuing feature without picking up the handset. Auto Handsfree has not been assigned to your telephone. You must use the handset or the button labeled Handsfree/ Mute to answer a call.

Priority> 21  
BLOCK

You are receiving a priority call. If you are on another call, inform the person you are speaking to that the call is about to be put on hold. Press the flashing line indicator of the priority call or wait until the call connects automatically (in eight seconds). The priority call goes through when you hear the next beep. Your active call is placed on Exclusive Hold. It is reconnected automatically when the priority call ends (unless you transfer the priority call, in which case you must press the line button of your original call to reconnect). Use DND (    ) or press **BLOCK** to reject a priority call.

Release a call

You have no free line buttons on which to receive a call. Release one of your current calls and try again to answer the incoming call.

Use line pool?  
YES NO

You have received a Ring Again offer for a line pool. Press the flashing internal line button or **YES** to use the line pool. On M7100 or T7100 telephones, just lift the handset. Otherwise, press **NO** or wait 30 seconds for the Ring Again offer to expire.

Hold or release

You cannot program a feature button while you are on a call.

Release calls

You have tried to use a feature while you were on a call or had calls on hold. Release the call or calls, before using the feature.

Line in use

The line is in use. Make the call using normal methods or wait until the line is free.

No button free

You have tried to make, receive or pick up a call when no line button was available. Some features require you to have a button free. Releasing calls can free up line buttons.

Make calls first

The feature you tried to use requires you to be on an active call at your telephone. This display also appears when information about a call has been cleared by a system reset.

No free lines

All the lines or line pools available to the telephone are in use. This display also appears when you have tried to dial an external number or use a feature that conflicts with the lines, line pools or prime line used by the telephone. This must be corrected by your customer service representative or installer.

No line selected

The telephone has been set up to dial an external number on a prime line but the telephone does not have a prime line. This must be corrected by your customer service representative or installer.

In use:21



You have tried to program redirection while someone else is programming redirection. Only one person can program line redirection at a time.

Incoming only

The line you are trying to use for redirecting calls is for incoming calls only. Choose an outgoing line.

9\_

QUIT BKSP OK

Continue entering digits. Press  or  or BKSP to delete incorrect digits. Press  or OK when you are finished.

Invalid number

You have entered an invalid line pool code or an invalid destination code.

Line denied

You have selected a line that is private to another telephone.

Restricted call

The destination you have chosen for line redirection is restricted.



# Index

## Symbols

☒ Long Distance symbol 229



Autobumping

canceling #815 129

using 815 129

autodial button

external \*1 84, 86

internal \*2 84

Background Music

canceling #86 182

turning on 86 182

Button Inquiry \*0 90, 135,

219, 225

Call Duration Timer 77 61

Call Forward

canceling #4 107

using 4 107

Call Information 811 46, 47

Call Log

entering 812 131

external calls 813 128

options \*84 128

password \*85 130, 131

viewing 812 129

Call Park ☐ ☐ 103

Call Pickup 76 49

Call Queuing 801 95

Call Transfer

canceling #70 100, 101

using ☐ ☐ 55, 99

Camp-on 82 102

Class of Service 68 217

Conference Call

M7100 telephone #3 53,

54

using 3 53, 54, 55

using ☐ 53

Contrast Adjustment \*☐ ☐

136

Custom Call Routing \*832

75, 203

Dialing Modes \*82 67

Directed Pickup 76 49

Do Not Disturb

canceling #85 181

turning on 85 68, 180,

181

Exclusive Hold 79 94

Feature Button

erasing \*1 137

programming \*3 137

General page 60 145

Group Listening

canceling #802 56

using 802 56

Hide message display 806

148

Host System Dialing Signals

Link 71 210

Long Tones 808 211

Pause 78 211

Programmed Release

\*89 212

Run/Stop \*9 212

Wait for Dial Tone 804

213

Language

English \*☐ ☐ ☐ ☐ 136

French \*☐ ☐ ☐ ☐ 136

Spanish \*☐ ☐ ☐ ☐ 136

Last Number Redial ☐ 86

Line Button, moving \*81 147

Line Pool Access **6** **4** 66

Line Redirection

canceling #84 112

using 84 112

Message

canceling **#** **f** 121

sending **f** 120

viewing ones you sent **f**  
122

viewing **6** **5** 121

Page

combined zone **6** **3** 117

external zone **6** **2** 117

internal zone **6** **1** 117

using **6** **0** 103, 104,  
117

Password

Basic **B** **A** **S** **I** **C** 27,  
203

Call Log \*85 131

System

Coordinator **A** **D** **M** **I**  
**N** 24, 27, 30, 32, 33,  
34, 35, 36, 37, 38, 39,  
203

Password, Call Log \*85 131

Priority Call **6** **9** 68

Privacy 83 61

Restriction Service

turning off #872 199

turning on 872 199

Ring Again

canceling **#** **2** 70

using **2** 70

Ring Type **\*** **6** 148

Ring Volume \*80 148

Ringing Service

turning off #871 199

turning on 871 199

Routing Service

turning off #873 199

turning on 873 199

Saved Number Redial **6** **7**  
90

Services, viewing 870 201

Speed Dial

adding user **\*** **4** 88

making calls **0** 90

Static Time and Date 806  
123

System Answer \*831 74,  
203

System Answer, Custom  
Call Routing, recording a  
greeting \*833 82, 83

Testing

display 805 226

power supply 805 227

telephone buttons 805  
226

telephone handset 805  
226

telephone headset 805  
227

telephone speaker 805  
227

Time and Date \*\*8463 203

Time and

Date **\*** **\*** **T** **I** **M** **E** 27

Trunk Answer 800 51

User Preferences **\*** **\***

**U** **S** **E** **R** 149, 203

Voice Call Deny

canceling #88 125

using 88 125

Voice Call **6** **6** 124

 Link symbol 210

 Pause symbol 211

 Programmed Release symbol  
212

- Run/Stop symbol 212
- Wait for Dial Tone symbol 213

## A

### access

- Class of Service 216
- external lines 221
- Norstar from outside the system 213
- remote 215
- using a COS 214
- using a DISA 214

Access denied 229

ADD 222

administration password (see System Coordinator password)

administration programming 14

Alarm 61-4-2 225

alarm codes

- reporting and recording 225

alarm telephone 225

Allow calls 181

allow redirect

- programming 113

Already joined 50, 63

Already parked 104

Alternate line (ATA feature code) 183

alternate services 197

analog terminal adapter

- dialing signals 212
- using dialing modes 67

analog terminal adapter, internal and features 182

- feature codes 188
- troubleshooting 189

announcement

- paging 117

Voice Call 124

Answer button 52

answering calls

- Answer button 52
- Call Display services 46
- Call Duration Timer 61
- Call Pickup 49
- central answering position 44
- Conference Calls 53
- Custom Call Routing 72
- distinctive ring patterns 43
- Group Listening 56
- Handsfree 56
- hearing aid compatibility 46
- prime telephone 43
- Privacy 60
- System Answer 71
- Trunk Answer 51
- using line buttons 42
- using SWCA keys 95
- using the Release button 45
- Voice Call 124

answering machine, and I-ATA 188–189

apply button cap labels 139

ATA (see analog terminal adaptor)

attendant telephone 75

Auto Attendant 71–84

Auto Call information (see Caller ID set)

Auto System Answer (see System Answer)

autodial

- line selection 85
- programming 84
- storing number on a memory button 84

- using Last Number Redial 87
- Autodial full 85
- automatic
  - Call information 48
  - Call Log 127
  - dial 67
  - Handsfree 59
  - Hold 93
  - release of a line (see Disconnect Supervision)
- Automatic Call Back, ISDN terminal feature 194
- Automatic Recall
  - ISDN terminal feature 194
- Automatic Telephone Relocation 180, 219
- auxiliary ringer 209
- B**
- Back 20
- Background Music 182
- Basic password 14, 149, 203
- BLSP 222
- blocking
  - calls, see Do Not Disturb and DND
- Business Series Terminals
  - wall mounting sets 176
- busy 63, 69
- busy tone
  - fast 216
- button cap labels
  - applying 139
- button caps
  - types of 140
- button defaults
  - M7100 telephone 145
  - M7208 telephone 145
  - M7310 telephone 141, 143

- M7316 telephone 141
- M7324 telephone 146
- T7310 telephone 139
- Button erased 85
- Button Inquiry 135
- buttons
  - Answer button 52
  - Button Inquiry 135
  - changing button
    - programming 150
  - display 17, 18
  - erasing programmed features 137
  - Feature 17
  - handsfree 17
  - Handsfree/mute 59
  - Hold 17
  - Last Number Redial 86
  - memory 17, 84, 222
  - moving line 147
  - numbering on all telephone types 150
  - programming features on buttons 137
  - Release 17, 45
  - Saved Number Redial 90
  - testing 225, 226
  - using a line button 65
  - using buttons 15
  - volume control 17
- bypassing
  - a Hotline telephone 207
- C**
- call
  - ways to make a 63
- Call 221? 230
- Call blocked 69
- Call Display information 46
- Call Duration Timer 61

- Call Forward
  - ATA feature code 183
  - Call Forward No Answer 35
  - Call Forward on Busy 37, 109
  - Forward no answer 108
  - forwarding to voice mail 111
  - ISDN terminal feature 193
  - overriding 108
  - programming 35, 108, 109
- Call Forward and Line
  - Redirection, differences 115
- Call information
  - automatic 48
  - changing what information is shown first 48
  - displaying information 46
  - getting information for a call on hold 47
  - getting information for a current call 47
- Call Log 127
  - Autobumping 129
  - automatic 127
  - calling from within 130
  - deleting log items 129
  - logging call manually 128
  - options 128, 152
  - using 127
- call overflow 221
- Call Park 103
  - ATA feature code 183
- Call Pick-up
  - ATA feature code 183
- Call Pickup
  - Directed Pickup 49
  - Group Pickup 49
- Call Pick-up (Directed)
  - ATA feature code 183
- Call Queuing 95
  - ATA feature code 184
- Call Transfer 99
- Call Transfer (ATA feature code) 187
- Call(s) bumped 132
- Callback 105
- Caller ID set 48
- Calling 69
- calls
  - using Do Not Disturb 180
- Camp denied 102
- Camp max 102
- Camp to 102
- Camped 102
- ~~CAMPED~~ 230
- camping calls (see Camp-on)
- Camp-on 102
  - ATA feature code 184
- Can't ring again 64, 70
- ~~CANCEL~~ 222
- Cancel denied 122
- CAP (see central answering position)
- CCR (see Custom Call Routing)
- central answering position
  - answering calls 44
  - M7324 telephone 44
  - sending messages 120
  - telephone 44, 205
  - using 44
- Class of Service
  - ATA feature code 184
  - changing 217
  - using a password 215, 216
- Cleared>LINENAM 122
- communicating in the office
  - paging 117–120

- sending messages using
  - display 120
  - Voice Call 124
- cond pswd, programming 205
- Conf. on hold 55
- Conference busy 55
- Conference Call
  - ATA feature code 184
  - by releasing privacy 61
  - removing yourself from 55
  - using the Conference feature 53
- contrast adjustment 136
- control telephone 200, 208
- Custom Call Routing
  - attendant telephone 75
  - customizing 73
  - language choice 76
  - using 72
- customizing your telephone
  - adjusting ring volume 148
  - Button Inquiry 135
  - changing ring type 148
  - contrast adjustment 136
  - User Preferences 149

## D

- date and time
  - changing 27
- default
  - button assignments 144
- deleting
  - Call Log items 129
  - messages from list 122
  - programmed features 137
- Denied in admin 229
- desk pswd 205
- desktop conferencing 195
- dial pad

- entering numbers and letters 32
- dial tone
  - Norstar system 216
  - stuttered 216
- Dial voice call 125
- dialing
  - automatic dial 67
  - direct extension 73
  - options 152
  - pre-dial 67
  - saved number 90
  - standard dial 67
  - switching from pulse to tone 213
- dialing modes 67
- dialing signal
  - Link 210
  - Long Tones 211
  - Pause 211
  - Programmed Release 212
  - run/stop 212
  - switching from pulse to tone 213
  - Wait for Dial Tone 213
- direct extension dialing, using Custom Call Routing and System Answer 73
- direct inward system access 214
- direct-dial telephone
  - programming 206
- Directed Pickup 49
- directing calls, using Custom Call Routing 72
- DISA (see direct inward system access)
- disconnect
  - from conference 55

- releasing a call, accidentally
  - 62
  - supervision 219
- Disconnect Supervision 219
- display
  - button equivalents for one-line display 222
  - buttons 17
  - Call information 47
  - changing the language 136, 152
  - contrast 152
  - display buttons 18
  - making darker or lighter 136
  - one-line 222
  - testing 226
- distinctive ring patterns(DRP)
  - answering a call 43
- distinctive rings 148
- DN (see internal numbers)
- DND 102
- DND transfer 43
- DNs 25
- Do Not Disturb
  - on Busy 38
  - see also DND 180
- Do not disturb 64, 69, 101
- Do Not Disturb on Busy 110
- DRT 43
- E**
- ending a call 45
- Enter code 138
- Enter digits 86, 89
- Enter zone 119
- entering names and numbers 31
- erasing
  - Call Log items 129
  - messages from list 122
  - programmed features 137
- Evening Sched 202
- Exchanged 147
- Exclusive Hold 68, 94
- Expensive route 64
- external
  - page 117
- external access to Norstar 213
- external autodial
  - programming 84
- external Call Forward (see Line Redirection)
- external paging equipment 120
- extra-dial telephone 202
- F**
- F\_ 138
- fast busy tone 216
- fax machine, and I-ATA 188–189
- Feature button 17
- feature button 17
- Feature code 138
- Feature moved 138
- Feature timeout 229
- Features
  - adjusting ring volume 148
  - Autobumping 129
  - autodial 84
  - auxiliary ringer 209
  - Background Music 182
  - Button Inquiry 135
  - Call Display 46
  - Call Duration Timer 61
  - Call Forward 107
  - Call Information 46
  - Call Log 127
  - Call Park 103
  - Call Pickup 49
  - Call Queuing 95
  - Call Transfer 99

- Callback 105
- Camp-on 102
- changing ring type 148
- Class of Service password 217
- Conference Calls 53
- contrast adjustment 136
- Custom Call Routing 75
- dialing modes 67
- dialing signal
  - Link 210
  - Long Tones 211
  - Pause 211
  - Programmed Release 212
  - run/stop 212
  - Wait for Dial Tone 213
- Do Not Disturb on Busy 110
- Exclusive Hold 94
- Handsfree 56
- hiding the message or calls display 148
- Hold 93
- language choice 136
- Last Number Redial 86
- line pools 65
- Line Redirection 111–116
- Messages 120
- moving line buttons 147
- paging 117–120
- priority call 68
- Privacy 60
- Restriction service 197
- Ring Again 70
- ring type 148
- Ringling service 197
- Routing service 197
- Saved Number Redial 90
- sending messages using display 120

- Set Lock 208
- Speed Dial 88
- System Answer 74
- Test a Telephone 225–227
- Time and Date 203
- Trunk Answer 51
- User Preferences 149
- Voice Call 124
- Voice Call Deny 125
- features
  - Do Not Disturb 180
  - Group Listening 56
- file transfer 195
- Flash (feature) 210
- Forward denied 111
- Forward> 111
- forwarding calls 35
  - Call Forward 107
  - Call Forward delay 109
  - Call Forward on Busy 109
  - Do Not Disturb on Busy 110
  - Forward no answer 108
  - Line Redirection 111–116

## **G**

- Get call first 104
- greetings, Auto Attendant
  - changing the language 76
  - Custom Call Routing 72
  - customizing 79
  - pre-recorded 78
  - recording 81
- Group 4 fax 196
- group answering
  - SWCA keys 95
- Group Listening 56
- Group Pickup 49

## **H**

- handling many calls at once
  - Call Queuing 95



- Hold 93
- handset
  - testing 226
- handset speaker
  - testing 227
- Handsfree
  - making calls 57
  - muting 57, 59
- handsfree
  - changing voice path 152
- Handsfree Answerback
  - programming 60
  - Voice Call 124
- handsfree button 17
- Heading 20
- headset
  - changing voice path 152
  - Handsfree requirement 59
  - testing 227
- hearing aid compatibility 46
- Hidden number 64, 87, 91
- Hold
  - ATA feature code 185
  - automatic 93
  - button 17
  - Conference Call 54
  - exclusive 94
  - listening while on hold 94
  - retrieving call 93
  - using SWCA keys 95
- Hold or release 132
- Hold or release 231
- Hospitality 165, 167
- hospitality
  - password 204
- host system signaling
  - Link 210
  - Pause 211
  - Programmed Release 212
  - run/stop 212
  - Wait for Dial Tone 213
- Hotline
  - bypassing 207
  - setting up the telephone 207
- Hunt Groups 36, 38, 39, 41, 50, 52, 68, 70, 71, 93, 104, 107, 108, 109, 110, 118, 124, 155, 181, 207, 219
  - adding or removing members 156
  - Answering incoming calls 41
  - assigning and unassigning lines 158
  - Broadcast mode 159
  - moving members 157
  - programming busy line setting 161
  - programming the overflow set 163
  - programming the queue time-out 162
  - Rotary mode 160
  - Sequential mode 160
  - setting the distribution mode 159
  - setting the hunt delay 161
  - setting the name 164
- I-ATA (see analog terminal adapter, internal 182
- In use 122
- In use 232
- In use SETNAME 132
- Inactive feature 229
- incoming calls
  - SWCA keys 96
- Incoming Line Groups (ILG) 155
- Incoming only 232

- installer programming 14, 24
- integrated services digital network (see ISDN) 191
- Intercom 114
- Intercom # 86
- internal analog terminal adapter (see analog terminal adapter, internal) 182
- internal numbers
  - length of 219
- internal page 117
- Internet access 196
- Invalid code 89, 213
- Invalid code 229
- Invalid location 147
- Invalid number 86, 101, 104
- Invalid number 232
- Invalid Password 217
- Invalid zone 119
- ISDN
  - applications 195–196
  - capacity 191
  - equipment 195–196
  - Internet access 196
- L**
- LAN access 196
- LAN bridge 196
- LAN router 196
- language
  - changing on the display 136, 152
  - choice for Auto Attendant 76
- Last Number Redial
  - programming 87
- Last Number Redial (ATA feature code) 185
- Last Number Redial, using 86
- leased line backup 196
- length of call, timing 61
- length of internal numbers 219
- letters, entering with dial pad 32
- limiting
  - access to Norstar 214
  - telephone feature use 208
  - telephone programming 208
  - using alternate or scheduled services 197
- line
  - changing the name 34
  - target 220
- Line 001 waiting 230
- line appearances
  - using SWCA keys 95
- line assignment 220
- line button
  - moving 42, 147
  - using to choose a line 65
- Line denied 51, 64
- Line denied 232
- Line hung up 102
- Line in use 231
- line indicators
  - description 42
- line pool 65–66, 221
- line pool and ATA 185
- Line Redirection 111–116
- Line Redirection 114
- Line Redirection and Call Forward, differences 115
- line, changing the name 180
- Line001 callback 44
- Line001 hung up 101
- Line001 to prime 44
- Line001 transfer 230
- Link
  - ATA feature code 185
  - using 210
- Link, programming 210

- LIST 151
- listening on hold 94
- log space
  - programming 131
- logging a call manually 128
- Logit (see Call Log)
- long distance call
  - indicator 229
- long distance calls, using COS
  - password 213
- Long Tones 211
- Long Tones 212
- Lunch Sched 202
- M**
- M7100 telephone 85
  - button defaults 145
  - Button Inquiry 135
  - Call Conference 53
  - Call Park 103
  - Call Queuing 230
  - Call Transfer 101
  - camping a call 102, 103
  - Conference Call 54
  - Conference Call on hold 54
  - Hold 93
  - Incoming Line Group button
    - 42, 65
  - internal numbers 219
  - line assignment 220
  - Line Redirection 111
  - memory buttons 222
  - one-line display 222
  - Ring Again 230, 231
  - Speed Dial 88
  - standard dial 67
  - Transferring a call 101
  - Voice Call 124
- M7208 telephone
  - button defaults 145
  - memory buttons 222
  - one-line display 222
  - splitting a Conference Call
    - 54
- M7310 telephone 15
  - button defaults 143
  - memory buttons 222
  - splitting a Conference Call
    - 54
  - troubleshooting 225
- M7324 telephone 15
  - button defaults 146
  - central answering position
    - 44
  - memory buttons 222
  - splitting a Conference Call
    - 54
  - troubleshooting 225
- maintaining security 215
- Make calls first 231
- making calls
  - dialing modes 67
  - priority call 68
  - using a line button 65
  - using line pools 65
  - using Ring Again 70
  - with automatic Handsfree 59
- memory buttons 17, 84, 222
- Message denied 123
- Message list 123
- Message to 123
- Messages
  - ATA feature code 185
  - cancelling a sent message
    - 121
  - hiding display 148
  - removing from list 122
  - sending 120

- sending using the display
  - 120
  - viewing 121
- Messages & Calls 123, 132
- Microphone muted 125
- modem, and I-ATA 188–189
- monitoring
  - calls 52, 220
  - line pool status 70
  - lines (see also Disconnect Supervision) 219
  - telephone status 70
  - transferred calls 105
- Move line from 147
- Move line to 147
- moving
  - telephones 180
- music, background 182
- muting voice call tones 124

**N**

- names
  - spelling out 31
- Network Call Diversion 194
- New calls begin 132
- Next 20
- night control phone (see control telephone)
- Night Sched 202
- Night Service (see Services)
- 9\_ 63
- 9\_ 232
- No button free 123
- No button free 231
- No call on 104
- No calls waiting 230
- No free lines 232
- No info to log 133
- No last number 64, 87

- No line selected 64
- No line selected 230, 232
- No line to use 114
- No log assigned 133
- No number saved 91
- No number stored 89, 123
- No resume item 133
- No services ON 201
- No voice call 125
- Norstar system dial tone 216
- Not available 229
- Not in service 64, 101, 103, 111
- Not in service 230
- numbers, entering with dial pad
  - 32

**O**

- OK 222
- On another call 64, 69
- On hold 94
- one button access to features 46
- one button dialing (see Autodial)
- outgoing calls
  - SWCA keys 97
- Outgoing line 114
- overflow call routing 221
- OVERRIDE 222
- overriding
  - Call Forward 108

**P**

- page
  - ATA feature code 186
  - external equipment 120
  - programming 118
  - shortcut codes 117
  - types 117
  - zones, programming 118
- Page choice 119
- Page timeout 119

- Paging ALL 119
- Paging busy 119
- Park denied 104
- Parked call 230
- Parked on 104
- parking a call
  - retrieving 103
- Parking full 104
- password 165
  - Basic 149, 203
  - Call Log 130–131
  - changing 202
  - Class of Service 216
  - clearing Call Log 204
  - cond pswd 205
  - desk pswd 205
  - Hospitality password 204
  - System Coordinator 202, 203
  - User Preferences 149
- Pause 211
  - ATA feature code 186
- pause in a sequence of numbers (see Wait for Dial Tone)
- personal programming 14
- phone 97
- Pick up receiver 230
- Pickup 51
- Pickup denied 50, 51
- pickup group 49
- Please wait 69
- Pool code 114
- power supply
  - testing 227
- pre-dial 67
- Press a button 86, 135, 138
- Press a line 147
- Press held line 55
- prime line 208, 223
- prime telephone 43
- priority call
  - ATA feature code 186
- priority call (see also Call Queuing) 68
- Priority denied 69
- Priority 223 231
- Privacy
  - ATA feature code 186
  - changing status 60
- private branch exchange, accessing from Norstar (see also host system dialing signals) 210
- private call 61
- private line 223
- Program and HOLD 86, 89, 138
- Program and OK 86, 89, 138
- Programmed 86
- Programmed Release 212
- programming 167
  - hospitality cond password 205
  - hospitality desk password 205
  - hospitality password 204
  - system features
    - Call Forward 35, 38
    - changing the name of a line 34
    - changing the name of a telephone 32
    - System Speed Dial 29
    - time and date 27
- telephones
  - Call Forward 35, 38
  - changing number of rings before forwarding call 36
  - changing the name of a

- telephone 32
- Do Not Disturb 180
- Do Not Disturb on Busy 38
- programming basics
  - administration programming 14
  - Basic password 14
  - customizing your Norstar 14
  - entering passwords 24
  - installer programming 14
  - personal programming 14
  - programming indicator  $\triangleleft$  20
  - programming map 20, 22–24
  - programming overlay 18
  - recording changes 13
  - starting and ending a session 24
  - understanding programming 13
- programming lines
  - changing the name of a line 180
- programming system features
  - adding or removing telephones from Custom Call Routing groups 77
  - attendant telephone 75
  - changing the language used by System Answer and Custom Call Routing 76
  - changing the number of rings for Custom Call Routing 77
  - changing the number of rings for System Answer 76
  - Restriction service 197, 198
  - Ringling service 197

- Routing service 197
- System Speed Dial 88
- programming telephones
  - allowing Line Redirection 113
  - auxiliary ringer 209
  - Call Display 48
  - Call Forward delay 109
  - Call Pickup 49
  - changing the name of a telephone 180
  - direct-dial telephones 206
  - external autodial button 84
  - Forward no answer 108
  - Forward on busy 109
  - Handsfree 59
  - HF Answerback 60
  - Hotline 207
  - Last Number Redial 87
  - Link 210
  - page zone 118
  - paging 118
  - priority call 68
  - Redirect ring 113
  - Saved Number Redial 91
  - Set lock 208
  - User Speed Dial 88

## Q

- QUIT 222









## R

- recording programming 13
- redialing
  - external number 86
- Redir by 114
- Redirect ring
  - programming 113
- Redirect $\frac{1}{2}$ denied 114
- redirection loops 115

- refusing to answer second call
  - 181
- Release a call 103
- Release a call 231
- Release button 17, 45
  - icons 17
- Release calls 231
- releasing
  - from conference 55
- releasing a call
  - accidentally 62
- remote access 213–215
- remote use
  - Class of Service password 216
  - security 214
  - using lines and features from outside the system 213
- replying to a message 121
- reporting and recording alarms 225
- Restr'n 201
- Restricted call 64, 101
- Restricted call 232
- restricting
  - access to Norstar 214
  - feature use (see Set Lock)
  - telephone feature use 208
  - telephone programming 208
  - using alternate or scheduled services 197
- Restriction service 197
- retrieval codes
  - Call Park 103
- retrieving
  - held call 93
  - parked call 103
- ring
  - auxiliary ringer 209
  - changing ring type 148, 152
  - changing the number of rings before call is forwarded 36
  - description of types 42, 148
  - ring volume 148
  - Ringling service 199
- Ring Again 70
- Ring Again (ATA feature code) 186
- Ring Again? 65, 70
- Ringling 201
- ringling
  - distinctive ring patterns 43
- Ringling service 197
- RLS button 45
- Routing 201
- routing calls, using Custom Call Routing 72
- Routing service 197
- run/stop signal 212
- S**
- Saved Number Redial
  - using 90
- Saved Number Redial, programming 91
- saving a number (see Saved Number redial)
- Sched 4 202
- Sched 5 202
- Sched 6 202
- scheduled services 197
- security
  - recommendations 215
  - system 214
- Select a line 65, 89
- Select line out 114
- Select line(s) 114, 115

- Send message? 65
  - Service Modes (see Services)
  - Service Modes ON 202
  - Service Schedules
    - Evening Sched 202
    - Lunch Sched 202
    - Night Sched 202
    - Sched 4 202
    - Sched 5 202
    - Sched 6 202
  - Services
    - overriding 202
    - Restriction service 197
    - Ringling service 197
    - Routing service 197
    - Trunk Answer 51
    - turning off and on using
      - feature codes 199
    - viewing active schedules
      - 200
  - Set Lock 208–209
  - Set locked 229
  - Set profile 221
  - SHOW 222
  - Show 20
  - signal
    - Link 210
    - Long Tones 211
    - Pause 211
    - Programmed Release 212
    - run/stop 212
    - Wait for Dial Tone 213
  - special telephones 205
  - Speed Dial
    - adding or changing 29
    - changing User Speed Dial
      - 151
    - choosing a system code 30
    - choosing the display 31
    - host system signaling codes
      - 88
      - making a call 88
      - programming 29
      - programming User 88
      - selecting a line 30
  - splitting a Conference Call 54
  - standard dial 67
  - Start of list 123
  - Still in transfer 101
  - stop calls from ringing at set 180
  - stuttered dial tone 216
  - suspending a call (see also Call Park and Hold)
  - SWCA
    - no free call keys 97
    - using 95
  - System Answer 71
    - attendant telephone 75
    - customizing 73
    - language choice 76
  - system dial tone 216
  - System Speed Dial 88
  - System Speed Dial (ATA feature code) 187
- T**
- T7316 telephone
    - splitting a Conference Call
      - 54
  - target line 220
    - changing the name 180
  - telecommuting 196
  - telephone
    - alarm 225
    - attendant 75
    - Call Display information 48
    - central answering position
      - 44, 205
    - changing the name 180



- control 200, 208
- direct-dial 205
- extra-dial 199, 202, 205
- Feature button 17
- handsfree button 17
- Hold button 17
- Hotline 207
- log calls automatically 127
- M7310, illustration 15
- M7324, illustration 15
- moving 180
- prime 205
- prime telephone 43
- Release button 17
- stop ringing using DND 180
- testing 225–227
- volume control 17
- testing
  - buttons 225, 226
  - Custom Call Routing 84
  - display 226
  - ending a session 226
  - handset 226
  - headset 227
  - power supply 227
  - System Answer 84
  - telephone 225
  - telephone speaker 227
- Their list full 123
- 3 parties only 55
- time and date
  - \*\*8463 203
  -        27
  -  806 123
  - changing 27
  - displayed instead of
    - messages and calls 148
    - length of a call 61
- time savers
  - autodial 84
  - Saved Number Redial 90
  - Speed Dial 88
  - Timed Release
    - ATA feature code 187
  - tone
    - camped call tones 102
    - controlling length 211
    - remote access tones 216
    - voice call 124
  - Tones (ATA feature code) 188
  - tracking incoming calls
    - Call Log 127
  - transfer (see Call Transfer)
  - Transfer denied 101
  - transferring calls 99
    - Callback 105
    - Custom Call Routing 72
    - parking a call 103
    - using Camp-on 102
  - transmission rates, with internal
    - analog terminal adapter 188
  - troubleshooting
    - internal analog terminal
      - adapter 189
    - reporting and recording
      - alarms 225
    - testing the headset 227
    - testing the power supply 227
    - testing the speaker in the
      - handset 226
    - testing the telephone
      - buttons 226
    - testing the telephone display
      - 226
    - testing the telephone
      - speaker 227
    - using the alarm telephone
      - 225

Trunk Answer 51  
ATA feature code 187, 188

## U

understanding programming 13  
Unequipped line 114  
Unknown name 131  
Unknown number 89  
until \* 201  
UPDATE 25  
Use line pool? 231  
User Preferences 149–153  
☎ \* \* U S E R 203  
User Speed Dial 88, 151  
using DND 180  
using Norstar remotely 213–215  
using this guide 13

## V

videoconferencing 195  
VIEW 222  
viewing  
    active Services 200  
    Call Log 129  
    messages 121, 122  
voice  
    changing voice path 152  
Voice Call 124–125  
Voice call 125  
voice mail  
    accessing your Norstar  
    system 133  
    using Call Forward 111  
volume  
    bar 223  
    control 223

## W

Wait for Dial Tone 213  
wall mounting  
    BST sets 176

## Y

Your list full 123

## Backup programming overlays

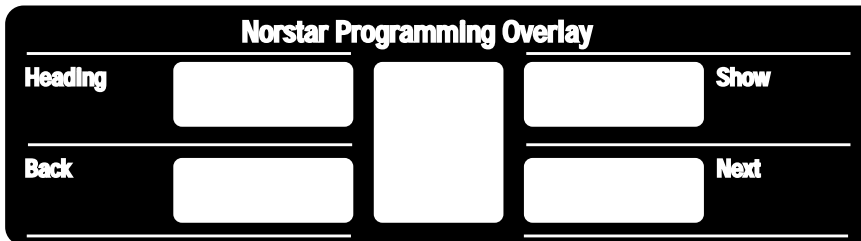
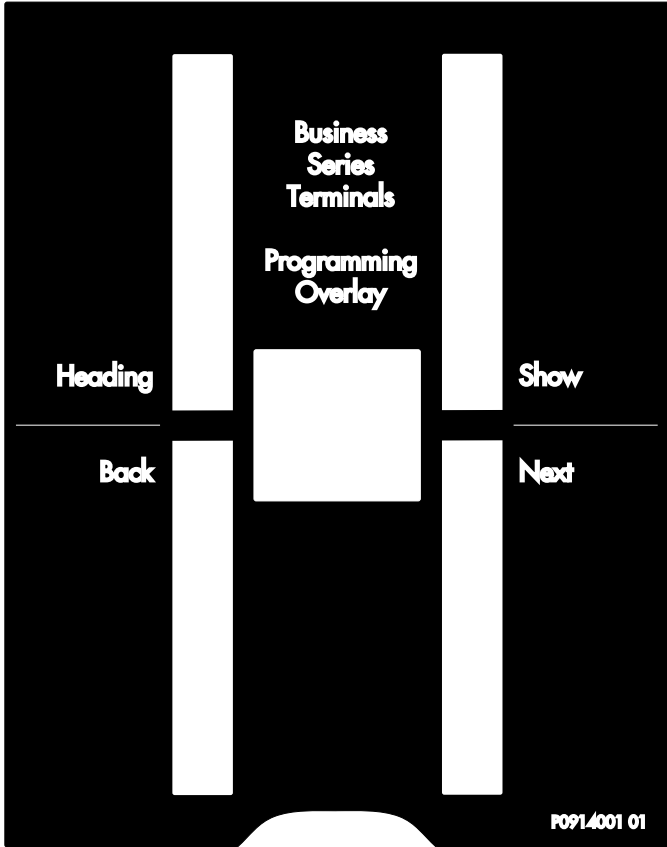

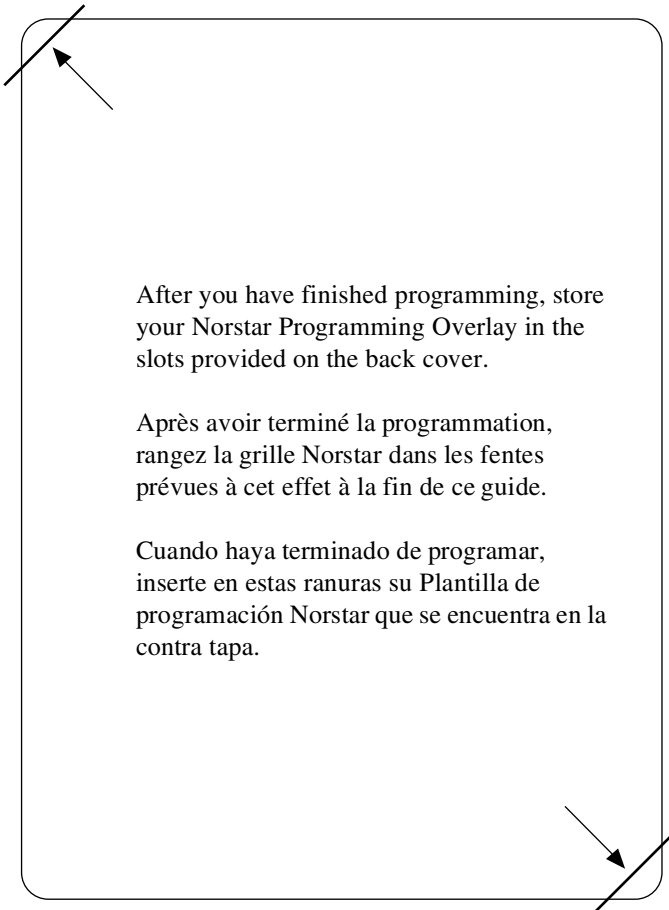
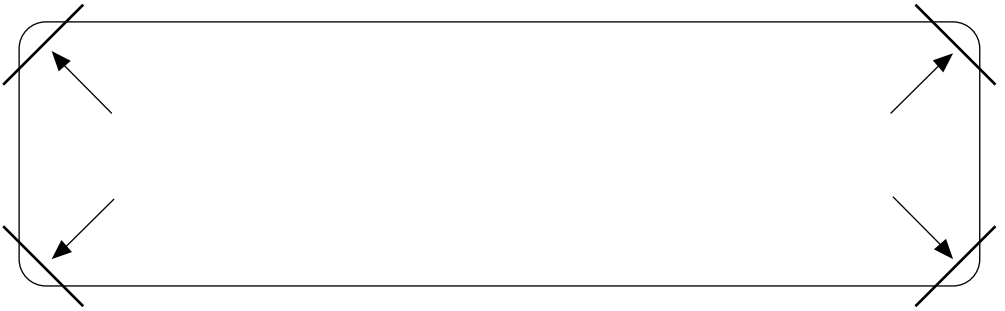

After you have finished programming, store your Norstar Programming Overlay in the slots provided on the back cover.

Après avoir terminé la programmation, rangez la grille Norstar dans les fentes prévues à cet effet à la fin de ce guide.

Cuando haya terminado de programar, inserte en estas ranuras su Plantilla de programación Norstar que se encuentra en la contra tapa.