

Modular ICS Companion Installer Guide

(to be used with MICS-XC software)

Norstar, Meridian and Companion are trademarks of
Nortel Networks

© Nortel Networks 2002

Table of Contents

Regulations 1

- Federal Communications Commission (U.S. only) 1
- Companion Base Stations 1
- Activation (U.S. only) 1
- Safety 2

Norstar Companion basics 3

- What's new with Norstar 5

Planning the installation 7

- Planning checklist 7
- Required equipment and supplies 7
- Configuring Station Modules 7
- Configuring expansion modules 8
 - On a mini system 9
 - On a midi system 9
 - On a maxi system 10
 - On a mega system 11
- ICS numbering 14

Installation 17

- Installation checklist 17
- Connecting expansion modules 18
- Installing Remote Power Interconnect (RPI) units 18
 - Mounting the RPI unit 20
 - Wiring the RPI 22
 - RPI Connector Overview 23
- Installing base stations 30
 - Positioning a base station 30
 - Mounting a base station 31
- Installing portable telephones 34
- Installing external antennas and lightning surge arrestors 35
 - Installing external antenna and lightning surge arrestor procedures for the United States of America 37
 - Planning for an outdoor external antenna (USA) 38
 - Installing a lightning surge arrestor (USA) 39

Installing external antenna and lightning surge arrestor
procedures for Canada 41

Powering up the system 49

Programming 51

- Installation programming 51
- Programming tools 52
 - The Norstar Programming Record 52
 - Exiting programming 52
 - Viewing your programming updates 53
- Template defaults 53
- Startup programming 55
 - Performing Startup 55
 - Changing the default template 56
- Entering programming 56
 - Entering programming for system coordinators 57
 - Entering programming using other passwords 58
- Norstar features 58
 - Portable features 58
- Registration password 58
 - Changing the Registration password 59
- Companion programming 60
 - Registration 60
 - Radio data 62
 - System logical identifier (LID) 66
- Software keys (U.S. only) 67

Registering individual portables 73

- Registering the C3060 73
 - C3060 Icons 73
 - To register the C3060 74
 - To confirm that the C3060 is registered 75
- Deregistering the C3060 76
- Measuring RSSI for a C3060 77
 - Measuring undirected RSSI 77
 - Measuring directed RSSI 78
- Registering the C3050 80
 - C3050 Icons 80

-
- To register the C3050 80
 - To confirm that the C3050 is registered 82
 - Deregistering the C3050 83
 - To deregister the C3050 83
 - Measuring RSSI for a C3050 84
 - To measure undirected RSSI 84
 - Measuring directed RSSI 85
 - Registering the C3020 (Canada only) 86
 - To register the C3020 86
 - Deregistering the C3020 (Canada only) 88
 - To deregister the C3020 88
 - Measuring RSSI for a C3020 (Canada only) 89
 - Measuring undirected RSSI 90
 - Measuring directed RSSI 90
 - Measuring directed RSSI using your portable 91
 - After registering the portables 92

Testing 93

- Testing the Companion portable telephones 93
- Testing the base stations 93
- Testing the system coverage 94

Troubleshooting 95

- Problems with a portable telephone 95
- Problems with a base station 95
 - Replacing a base station 97
 - Verifying Radio Credits (U.S. only) 98
- Problems with an RPI 99
- Problems with wireless communication 100
 - Obtaining a Recovery Key 100
 - Obtaining a Regression Key (U.S. only) 100
- Alarm codes 102
- Event messages 106

Specifications 113

- Norstar Companion system components 113
 - Remote Power Interconnect 113
 - Base station 114

Upgrading your system 119

Adding Companion to a mini, midi, maxi, or mega system 119
Upgrading an RPI-8 to an RPI-16 119

Glossary 121

Index 129

Backup programming overlays 137

Regulations

Federal Communications Commission (U.S. only)

The Federal Communications Commission (FCC) has designated UTAM Inc. to manage the installation and relocation of Unlicensed Personal Communication Services (UPCS). This includes Norstar Companion Base Stations and Portable Telephones.

Companion Base Stations

The radiated and conducted emissions of the Companion Base Station radios must not exceed the requirements for digital cordless telephones as outlined in FCC Part 15-subpart D (DOC RSS-130 documents in Canada). Do not install the Base Station in ducts, plenums, or hollow spaces used to transport environmental air.

Note: In Canada, Base Stations may be installed where the duct, plenum or hollow space is created by a suspended ceiling having lay-in panels or tiles, in accordance with CE Handbook Rule 60-402.

Activation (U.S. only)

Wireless communication on a Companion system cannot be activated until installation at its authorized location is verified and approved by UTAM Inc. This system is equipped with an automatic mechanism for disabling wireless operation in the event it is moved outside the area where its operation has been approved by UTAM Inc. This mechanism complies with FCC requirements.

Safety



Do not connect the administration set or Base Stations directly to a CO line.

Doing so may result in equipment damage.



The Norstar administration set and base stations must not be used as off-premises equipment.

Installers must check the lightning surge arrestors at the cable entry point to the building with special attention to the grounding. Report any problems to your telephone company in writing.

Do not install Norstar administration sets and base stations outside of the building because they are not lightning protected.

Norstar Companion basics

Norstar Companion provides mobility in the workplace. With Companion, your telephone can go with you, allowing you to make and receive calls while on the move. Calls that used to ring just at your desk can also appear and ring at your portable. This is called twinning. Twinning works provided that the portable is assigned the desk telephone DN as an Answer DN. Wireless twinning is improved by assigning the same answer key to your Norstar desk telephone and to your wireless portable telephone.

The portable telephones can access most Norstar business features such as call forward, call transfer, conferencing, and voice mail. Companion on Norstar consists of four main components:

ICS and Norstar XC software - Norstar MICS-XC software manages the telephone traffic between Companion base stations and portable telephones. Base stations are connected to the ICS in the same way as Norstar sets. Companion portable telephones are registered on the system and do not take up any ports on the system. Up to 60 portable telephones and up to 32 base stations (32 cells) can be connected to the system.

Companion base stations — Base stations are positioned throughout the coverage area to send and receive calls between the portable telephones and the ICS. The base stations use advanced digital radio technology and support handoff and roaming within the coverage area which can be up to 160,000 square meters (three million square feet) when using the maximum number of base stations.

Before the base stations can be used in the United States, UTAM codes must be obtained and entered using an administration terminal or Norstar Remote Utilities (NRU). Please see *Software keys (U.S. only)* on page 67 for more detailed information.

Companion Portable Telephones — The portable telephones used with your Norstar system are small, lightweight units with fully digital performance to provide clear voice quality. Companion portable telephones feature a two line, 16-character, alphanumeric display. For more information on the portable used with your MICS-XC system, refer to the *Companion Portable Telephone User Guide* that is supplied with it.

Before the portables can be used in the United States, portable credits must be obtained. Please refer to *Software keys (U.S. only)* on page 67.

Administration and Maintenance Tools — Programming the Companion system is easily and quickly done through a T7316 Business Series Terminal or an M7310 or M7324 Norstar set. You can assign portable telephones to the system, check base station parameters, and enable and disable registration using set programming.

System programming can also be performed using Norstar Remote Utilities (NRU) software on a personal computer.

Companion Diagnostic Software allows diagnostics to be run on the wireless system. Diagnostics can be run either locally or remotely via a personal computer.

CallPilot 100/150 or Norstar Voice Mail — CallPilot 100/150 replaces Norstar Voice Mail on new Modular ICS systems.

If you are using Norstar Voice Mail with your Companion system, Version 3.0 is recommended as a minimum Voice Mail software version.

For information on how to access Norstar Voice Mail using your Norstar Companion portable, refer to the *Portable Telephone Feature Card* that is supplied with it.

What's new with Norstar

This release reflects new features in the Modular ICS-XC software. For a list of these changes, refer to the *Modular ICS Installer Guide*.

For a complete list of features supported on Companion portables refer to the *Modular ICS Companion System Coordinator Guide*.

Planning the installation

Planning checklist

- Verify that you have approval from UTAM Inc. (U.S. only)
- Verify that a site planner determined base station locations and recorded them in the *Provisioning Record*.

Required equipment and supplies

- Companion portable telephones
- Companion base stations
- Companion Remote Power Interconnect device or plug top Power Supplies
- Companion ID Labels (See *Step 1: Obtain the Companion ID* on page 68.)

Configuring Station Modules

When installing wireless capabilities, use only the last two, or highest numbered, ports for connecting the Companion base stations.

Each Station Module allows you to connect up to 16 additional Norstar telephones to the system.

Maximum number of Norstar telephones on a system

mini	midi		maxi				mega			
ICS	SM3	SM4	SM5	SM6	SM7	SM8	SM9	SM10	SM11	SM12
32	48	64	80	96	112	128	144	160	176	192

Each Station Module that is used for Norstar Companion allows you to connect up to 16 base stations to the system.

Maximum number of Norstar Companion base stations on a system

mini	midi		maxi		mega	
ICS	SM3	SM4	SM7	SM8	SM13	SM14
16	16	32	16	32	16	32

Configuring expansion modules

With the addition of an Expansion Cartridge or a Combo Cartridge in the ICS, you can add Trunk Modules and/or Station Modules to increase your system capacity.

Previous users of the Norstar 0X32 system should note that the Key Service Unit (KSU) has been renamed the Integrated Communication System (ICS).

Installed in ICS	Additional modules allowed		
	Trunk	Station	Maximum
XC system Combo cartridge (6-port + Services) (maxi)	6	6	6
Combo and 6-port cartridges (mega)	6	12*	12
Two Combo cartridges (mega)	6	12*	12
Two 6-port cartridges (mega)	6	12*	12

*The last two ports are reserved for Companion use only.

Note: For each type of expanded system above, Norstar Companion capability is supported. Ensure you have the correct Modular ICS software to support wireless capability.

On a mini system

Note: Port 1 and 2 are on the ICS.

On a mini or non-expanded system, port 1 on the ICS (station ports 101 to 132) is used for both base stations and Norstar sets. No fiber ports are used since no Station Module is required. Directly connect your base stations or Norstar sets to port 1 on the ICS via a wiring distribution panel.

On a midi system

On midi and maxi systems, the highest numbered ports can be used for *both* base stations and Norstar sets. Therefore, sets and base stations can share the two highest numbered fiber ports.

A system expanded to four ports (midi size) includes one 2-port expansion cartridge with fiber ports numbered 3 and 4, and 1 and 2 on the ICS. The base stations *must* be physically connected (via a Station Module) to fiber ports 3 and 4 only. If only one Station Module supporting base stations is required, connect it to the highest-numbered port (port 4).

Two-port Expansion Cartridge

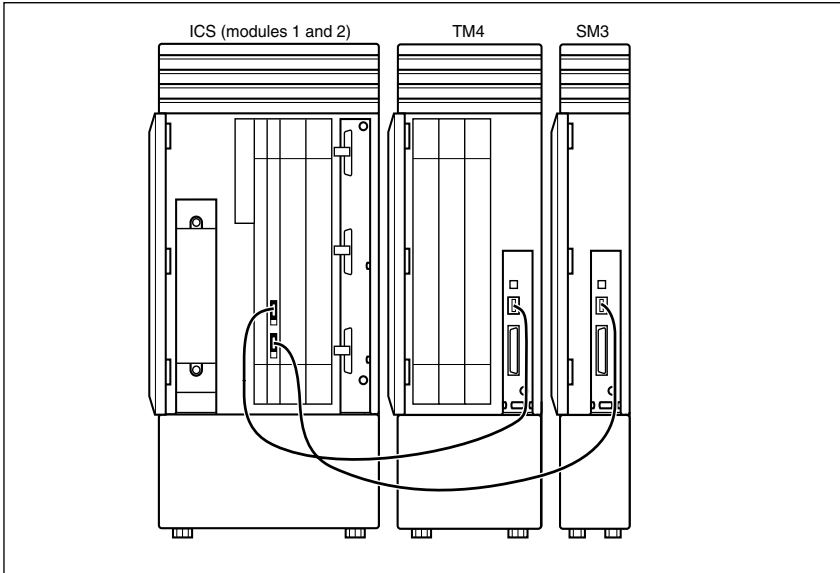

On a maxi system

A system expanded to eight ports (maxi size) includes one 6-port expansion cartridge with fiber ports numbered 3 to 8, and 1 and 2 on the ICS. The base stations *must* be physically connected, via a Station Module, to fiber ports 7 and 8 only. There is a maximum number of two Station Modules per base station. Refer to *Six-port Expansion Cartridge with Companion* on page 11

If only one Station Module supporting base stations is required, connect it to the highest-numbered port (port 8).



Tip - If Both ports 7 and 8 are used for connecting Station Modules supporting base stations, connect Trunk Modules starting at port 6 and working down. Connect Station Modules for the desk sets beginning at port 3 and working up.

Six-port Expansion Cartridge with Companion

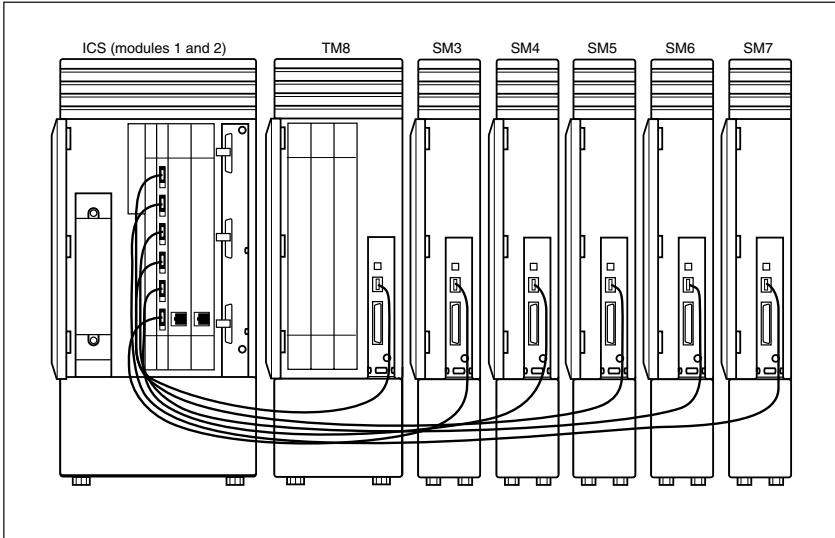

On a mega system

Keep in mind that 10 station modules is the limit for regular Norstar sets, and two station modules for Companion base stations is the limit on an XC configuration.

For example, a system expanded to 14 ports (mega size) includes two 6-port expansion cartridges with fiber ports numbered 3 to 14 on the expansion cartridges, and 1 and 2 on the ICS. The base stations *must* be physically connected to fiber ports 13 and 14 only. *12-port Expansion Cartridge with Companion* on page 12



Tip - In the fully expanded mega configuration, Station Modules 13 and 14 are reserved for base stations only.

12-port Expansion Cartridge with Companion

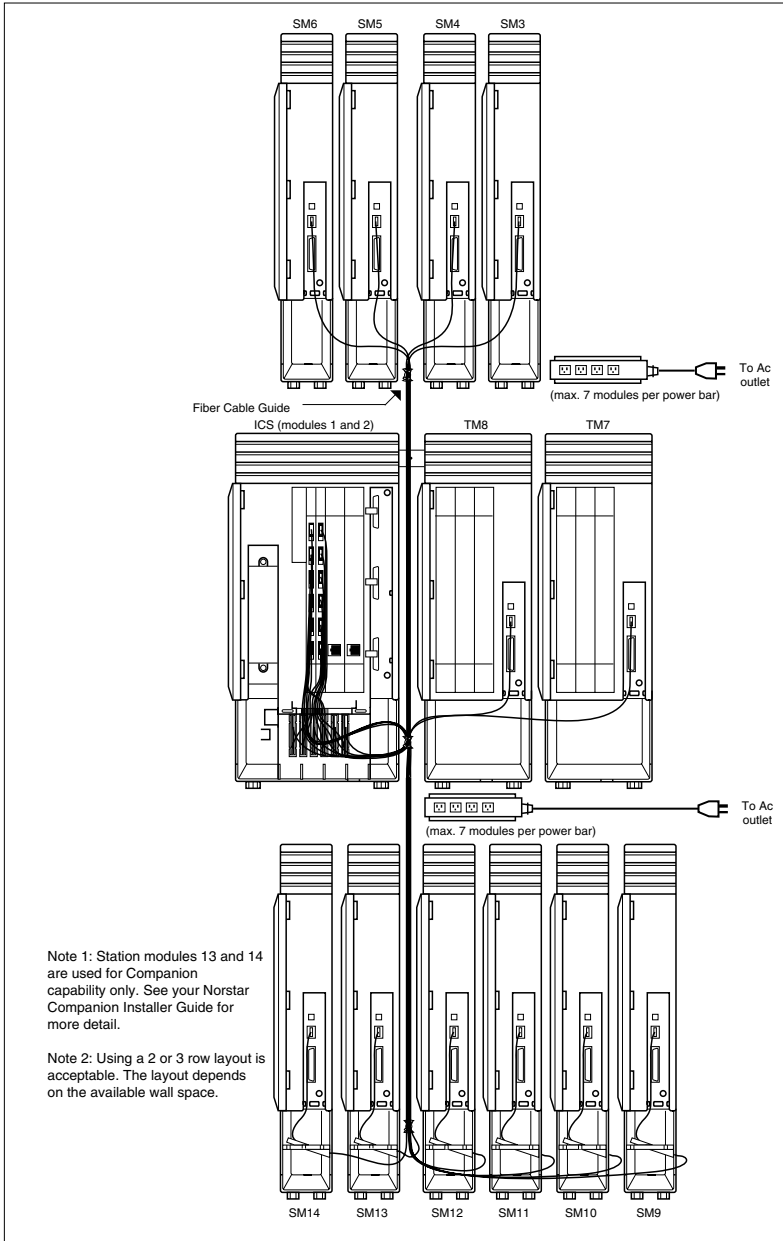

Routing fiber cables

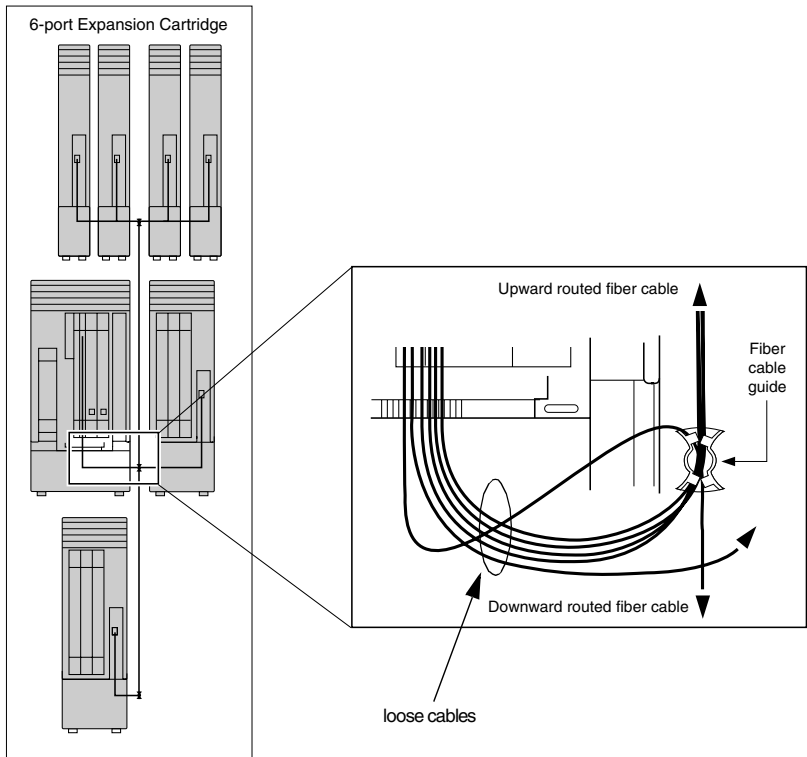

ICS numbering

Non-expanded system (ICS alone) numbering

Module #	Lines	Line ports	B1 DN	B2 DN	DN ports	Base station ports	Portable DN
ICS (#2)	001-048	201-248	---	---	---	---	637-696
ICS (#1)	---	---	21-52	53-84	101-132	101-132	637-696

Two-port Expansion Cartridge and ICS numbering

Expansion module #	Lines	Line ports	B1 DN	B2 DN	DN ports	Base station ports	Portable DN
#4	049-072	401-412	269-284	333-348	401-416	401-416	637-696
#3	073-096	301-312	253-268	317-332	301-316	301-316	637-696
ICS (#2)	001-048	201-248	---	---	---	---	---
ICS (#1)	---	---	221-252	285-316	101-132	---	---

Six-port Expansion Cartridge and ICS numbering

Expansion module #	Lines	Line ports	B1 DN	B2 DN	DN ports	Base station ports	Portable DN
#8	049-072	801-812	333-348	461-476	801-816	801-816	637-696
#7	073-096	701-712	317-332	445-460	701-716	701-716	637-696
#6	097-108	601-612	301-316	429-444	601-616	---	---
#5	109-120	501-512	285-300	413-428	501-516	---	---
#4	121-132	401-412	269-284	397-412	401-416	---	---
#3	133-144	301-312	253-268	381-396	301-316	---	---
ICS (#2)	001-048	201-248	---	---	---	---	---
ICS (#1)	---	---	221-252	349-380	101-132	---	---

Twelve-port expanded system and ICS numbering

Expansion module #	Lines	Line ports	B1 DN	B2 DN	DN ports	Base station ports	Portable DN
#14	---	---	---	---	---	1401-1416	637-696
#13	---	---	---	---	---	1301-1316	637-696
#12	---	---	397-412	589-604	1201-1216	---	---
#11	---	---	381-396	573-588	1101-1116	---	---
#10	---	---	365-380	557-572	1001-1016	---	---
#9	---	---	349-364	541-556	901-916	---	---
#8	049-072	801-812	333-348	525-540	801-816	---	---
#7	073-096	701-712	317-332	509-524	701-716	---	---
#6	097-108	601-612	301-316	493-508	601-616	---	---
#5	109-120	501-512	285-300	447-492	501-516	---	---
#4	121-132	401-412	269-284	461-476	401-416	---	---
#3	133-144	301-312	253-268	455-460	301-316	---	---
ICS (#2)	001-048	201-248	---	---	---	---	---
ICS (#1)	---	---	221-252	413-444	101-132	---	---



Tip - Port 3 is the bottom fiber cable port on the two-port and the six-port Expansion Cartridge in slot 2. Port 9 is located on the leftmost Expansion Cartridge in slot 1.

Refer to the Modular ICS Installer Guide for details.

Installation

Installation checklist

When installing a Norstar system with Companion components, follow this installation checklist:

- complete the wiring
- install the Remote Power Interconnect units*
- install the base stations*
- install the external antennas and lightning surge arrestors*
- mount the Integrated Communication System (ICS) and expansion modules (as required)
- install the NVRAM Cartridge (if required)
- install the ROM Software Cartridge
- install the Expansion Cartridge and Trunk Cartridges (as required)
- connect the expansion modules*
- install the emergency telephone(s)
- install the Norstar telephones
- install the single-line telephones
- install the optional equipment
- power up the system
- program the system and register the portables

* Procedures that are specific to Companion are included in this document. For all other procedures, see the *Modular ICS Installer Guide*.

Connecting expansion modules



Installation planning is required for base stations.

Before connecting any Station Modules required for base stations, please see *Configuring expansion modules* on page 8 for more information on the installation rules involved.

In order to keep the default port and extension numbering, connect Trunk Modules to the Expansion Cartridge beginning at the top and working down; connect Station Modules to the Expansion Cartridge beginning at the bottom and working up.

Installing Remote Power Interconnect (RPI) units



The RPI unit should have the DC backup power supplied by a UL listed UPS.

The UPS should have an output voltage rating of 44 to 50 V DC, with a maximum fault current limit of 6 A to protect the RPI output wiring. Otherwise, it may be necessary to use class 1 wiring.



The RPI units must always be installed inside a building.

The AC outlet powering the RPI should be installed near the equipment and should be easily accessible.

The length of the RPI cord, from the outside surface of the unit to the plug, should be a minimum of 1.3 m (4 1/2 ft.) and a maximum of 4.6 m (15 ft.).

RPI unit

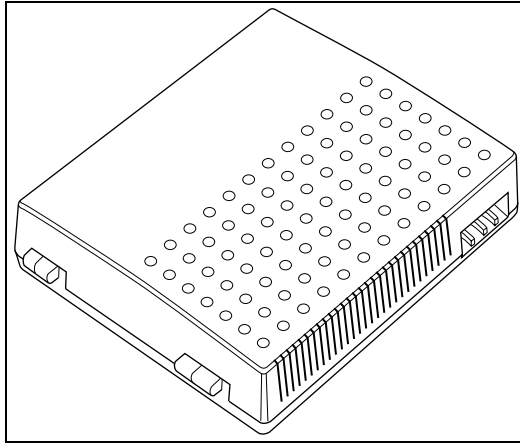

There are two versions of the RPI unit: the RPI-8 BIX UL, which supports up to eight base stations; and the RPI-16 BIX UL, which supports up to 16 base stations. Each RPI has a connection board and either one (RPI-8 BIX UL) or two (RPI-16 BIX UL) power supply units (PSUs). The maximum input power consumption of an RPI is 240 W. If a UPS 48 V DC backup source is used, the maximum input power requirement of the RPI is 140 W.

You can upgrade an RPI-8 BIX UL to an RPI-16 BIX UL by installing a second PSU to the RPI-8 BIX UL. Refer to *Upgrading an RPI-8 to an RPI-16* on page 119.

If RPIs are distributed throughout the site, the number and type of RPIs depend on the placement and powering plan of the base stations.

To determine how many base stations and how many PSUs you need for the number of base stations, use the following table:

RPI Requirements

Base stations	RPI-16 and RPI-8 required	PSUs required
1–8	1 RPI-8	1 PSU
9–16	1 RPI-16	2 PSUs
17–24	1 RPI-16 and 1 RPI-8	3 PSUs
25–32	2 RPI-16	4 PSUs

Mounting the RPI unit

1. Position the screw holes for the RPI using the dimensions shown in the following figure.

RPI mounting holes

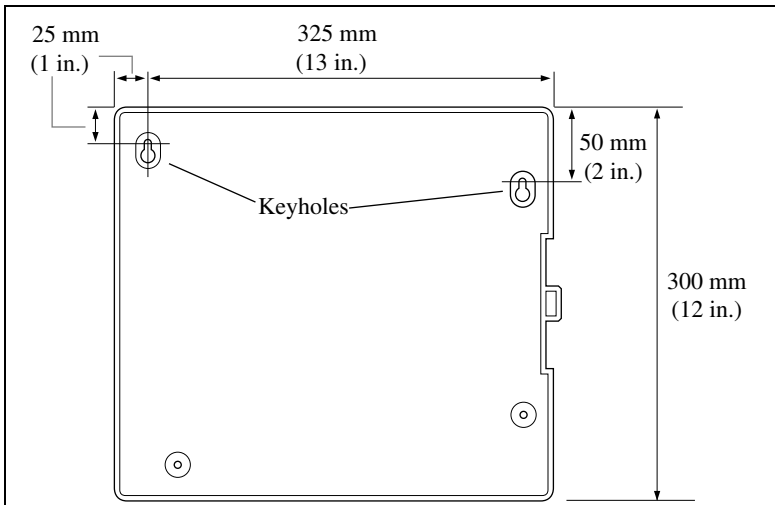

To provide adequate ventilation and to prevent overheating, leave a clearance of at least 125 mm (5 in.) around the RPI.

If you are mounting two RPIs, one above the other, leave a clearance of at least 300mm (12 in.) between them to provide adequate ventilation and to prevent overheating.

Mount RPIs at least 300 mm (12 in.) from the ceiling.

2. Insert wall plugs in the holes.
3. Partially screw in two #10 50-mm (2-in.) screws for the keyholes.
4. Open the hinged cover with a screwdriver by pushing in and then down to release the catch on the right side. You can remove the cover by lifting it off its hinges.

Opening the RPI cover

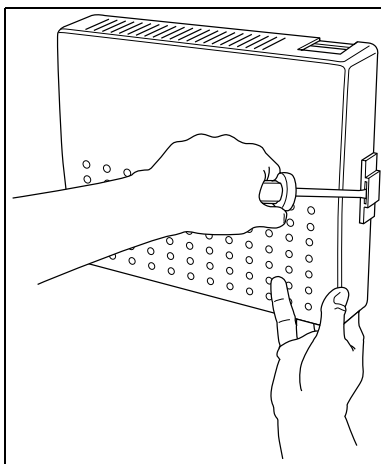

5. Hang the RPI on the two keyhole screws and tighten them.
6. Install the remaining two screws.
7. Feed the power cord through the bottom of the RPI and route it through the clip and around the strain relief support as shown in the following figure.
8. Route the power cord to the input power socket just to the left of PSU 1. Connect the plug to the socket.

Note: Distinctive labeling of RPIs may help to diagnose any future problems.

RPI components

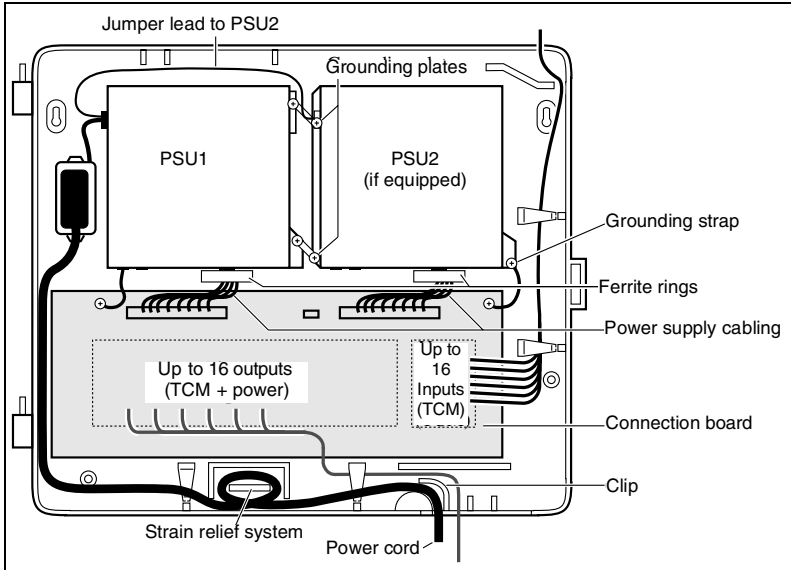

Unplug the RPI power cord.



Do not apply power to the RPI until its installation and wiring are complete.

The RPI-8, which has only one power supply unit, has grounding straps and plates fitted so it can be upgraded to an RPI-16 (see illustration *RPI components*).

Wiring the RPI



Do not run unprotected power cables outdoors.

The maximum two-way DC loop resistance for power pairs, including interconnections for each base station, is 75 ohms. You need one or two power pairs between the RPI and the base station, depending on the wire size of the power pairs and the distance between the base station and the RPI.

Maximum power cabling distance (approximate)

Depending on the size of cable you are using, you should remember the maximum cabling distances allowed between the RPI and the base station.

Wire size	Single-pair	Double-pair
0.6 mm (22 AWG)	800 m (2,500 ft.)	1200 m (4,000 ft.)
0.5 mm (24 AWG)	500 m (1,500 ft.)	1000 m (3,000 ft.)



When using two power pairs, ensure they are connected with the same polarity.

RPI Connector Overview

The following illustration shows where the input and output connectors are located on the RPI connector board.

RPI connector board

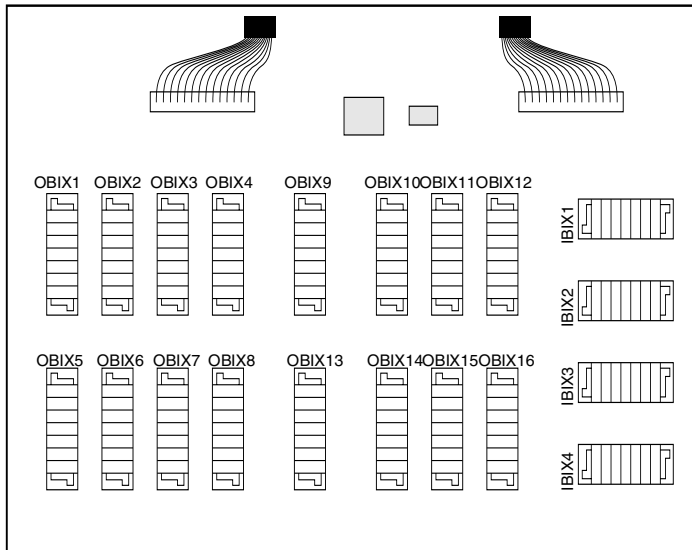

Output connections

Feed the output pairs in through the bottom of the RPI and route the pairs to the output connectors as shown in the following illustration. If only one pair is used for powering a base station, connect the power pair to -PWR(1) and +PWR(1). If two pairs are used to power a base station, connect one pair to -PWR(1) and +PWR(1), and the second pair to -PWR(2) and +PWR(2).



Ensure both pairs have the same polarity.

Connecting two power pairs with opposing polarities may damage the base station and RPI.

Output connector pinout

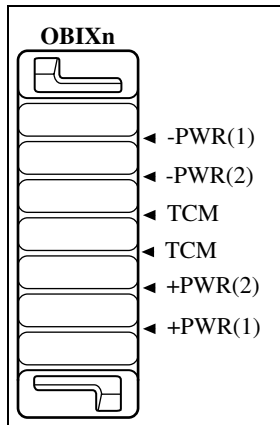

Input connections

Feed the TCM input pairs from the ICS distribution frame through the top of the RPI and route the pairs to the input connectors (IBIX1 to IBIX4) as shown in the following illustration. There may be fewer than 16 input pairs in any given RPI installation.

Input connector pinout

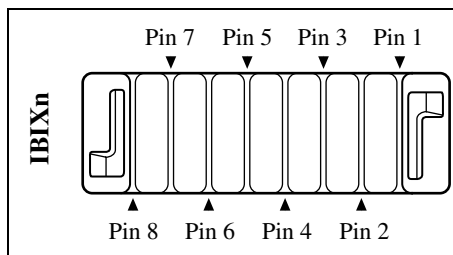

Input wiring

Connector	Pin	Signal	Output connector
IBIX1	1, 2	TCM 1	OBIX1
	3, 4	TCM 2	OBIX2
	5, 6	TCM 3	OBIX3
	7, 8	TCM 4	OBIX4
IBIX2	1, 2	TCM 5	OBIX5
	3, 4	TCM 6	OBIX6
	5, 6	TCM 7	OBIX7
	7, 8	TCM 8	OBIX8
IBIX3	1, 2	TCM 9	OBIX9
	3, 4	TCM 10	OBIX10
	5, 6	TCM 11	OBIX11
	7, 8	TCM 12	OBIX12
IBIX4	1, 2	TCM 13	OBIX13
	3, 4	TCM 14	OBIX14
	5, 6	TCM 15	OBIX15
	7, 8	TCM 16	OBIX16

RPI-8 BIX wiring chart

Pin	RPI Connector Board	Label	Wire color
26	OBIX1 BS1	-PWR	White-Blue
1			Blue-White
27		TCM	White-Orange
2			Orange-White
28		+PWR	White-Green
3			Green-White
29	OBIX2 BS2	-PWR	White-Brown
4			Brown-White
30		TCM	White-Slate
5			Slate-White
31		+PWR	Red-Blue
6			Blue-Red
32	OBIX3 BS3	-PWR	Red-Orange
7			Orange-Red
33		TCM	Red-Green
8			Green-Red
34		+PWR	Red-Brown
9			Brown-Red
35	OBIX4 BS4	-PWR	Red-Slate
10			Slate-Red
36		TCM	Black-Blue
11			Blue-Black
37		+PWR	Black-Orange
12			Orange-Black
38	OBIX5 BS5	-PWR	Black-Green
13			Green-Black
39		TCM	Black-Brown
14			Brown-Black
40		+PWR	Black-Slate
15			Slate-Black

Pin	RPI Connector Board	Label	Wire color
41	OBIX6 BS6	-PWR	Yellow-Blue
16			Blue-Yellow
42		TCM	Yellow-Orange
17			Orange-Yellow
43		+PWR	Yellow-Green
18			Green-Yellow
44	OBIX7 BS7	-PWR	Yellow-Brown
19			Brown-Yellow
45		TCM	Yellow-Slate
20			Slate-Yellow
46		+PWR	Violet-Blue
21			Blue-Violet
47	OBIX8 BS8	-PWR	Violet-Orange
22			Orange-Violet
48		TCM	Violet-Green
23			Green-Violet
49		+PWR	Violet-Brown
24			Brown-Violet

RPI-16 BIX wiring chart

Pin	RPI Connector Board	Label	Wire color
26	OBIX9 BS9	-PWR	White-Blue
1			Blue-White
27		TCM	White-Orange
2			Orange-White
28		+PWR	White-Green
3			Green-White
29	OBIX10 BS10	-PWR	White-Brown
4			Brown-White
30		TCM	White-Slate
5			Slate-White
31		+PWR	Red-Blue
6			Blue-Red
32	OBIX11 BS11	-PWR	Red-Orange
7			Orange-Red
33		TCM	Red-Green
8			Green-Red
34		+PWR	Red-Brown
9			Brown-Red
35	OBIX12 BS12	-PWR	Red-Slate
10			Slate-Red
36		TCM	Black-Blue
11			Blue-Black
37		+PWR	Black-Orange
12			Orange-Black
38	OBIX13 BS13	-PWR	Black-Green
13			Green-Black
39		TCM	Black-Brown
14			Brown-Black
40		+PWR	Black-Slate
15			Slate-Black

Pin	RPI Connector Board	Label	Wire color
41	OBIX14 BS14	-PWR	Yellow-Blue
16			Blue-Yellow
42		TCM	Yellow-Orange
17			Orange-Yellow
43		+PWR	Yellow-Green
18			Green-Yellow
44	OBIX15 BS15	-PWR	Yellow-Brown
19			Brown-Yellow
45		TCM	Yellow-Slate
20			Slate-Yellow
46		+PWR	Violet-Blue
21			Blue-Violet
47	OBIX16 BS16	-PWR	Violet-Orange
22			Orange-Violet
48		TCM	Violet-Green
23			Green-Violet
49		+PWR	Violet-Brown
24			Brown-Violet
50			
25			

Installing base stations

Before installing wireless equipment, ensure that a site planner has determined base station locations and recorded them.

Before installing or relocating wireless equipment in the United States, verify that you have approval from UTAM Inc. by calling the Nortel Customer Response Center at **1-800-321-2649**. You will be given codes and credits that are necessary to activate the system. Please see *Software keys (U.S. only)* on page 67 before calling.

Positioning a base station

Avoid installing base stations on large concrete or marble columns. This affects radio coverage. If possible, place the base station at least 1m (40 in.) from such columns. Do not mount a base station where metalwork is near the antenna housings. Be careful not to damage existing wiring or panels.

Do not position base stations in ducts, plenums, or hollow spaces used to transport environmental air except where the duct, plenum or hollow space is created by a suspended ceiling having lay-in panels or tiles. If more than one Companion base station is required in one cell to meet traffic demands, position all the base stations at the same cell center, as follows:

- USA: a minimum of 54 in. and a maximum of 9 ft. 9 in. apart from the center of one base station to the center of the next
- Canada: a minimum of 9 cm and a maximum of 1.5 m apart from edge to edge



Never mount base stations in rows.

Position base stations away from an office area or where a portable is used by at least the amounts shown in the following table. Installing the base station on the ceiling or high on walls helps to maintain these minimum distances.

Minimum distance between office areas and base stations

Number of base stations in the cell	Minimum distance between office areas and base stations
1	1 m (40 in.)
2	1.4 m (56 in.)
3	1.8 m (72 in.)
4	2 m (80 in.)

Mounting a base station

Base stations can be mounted on a wall or on a ceiling. When mounting on a wall, install them with their covers at the bottom, as shown in the following illustrations. Allow for clearances around the base station as indicated in the following illustration.

Clearance for the base stations

Clearance conditions	Canada	USA
Clearance from all other objects	9 cm	3.5 in.
Vertical clearance from base station center to base station center	27 cm	54 in.
Horizontal clearance from base station center to base station center	41 cm	54 in.

To mount a base station:

1. Fasten the bracket into position using two #8 38-mm (1½-in.) screws.
2. Route the cable from the ICS through the top (or bottom) opening.
3. Wind any excess cable around the posts to secure it, then fasten it under the strain relief.
4. Connect the wires to the BIX connector on the bracket termination board as shown in the following illustration.

The polarity of the TCM connections is not important. If two power pairs are brought in, they must be connected with the same polarity to the base station bracket termination board.



Ensure that the RPI is off before connecting power pairs to the base station.

Bracket termination board

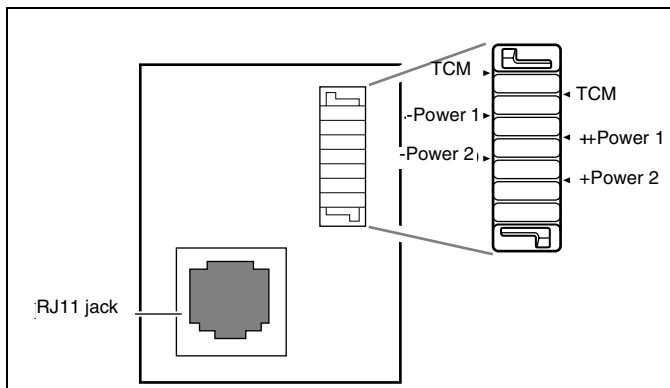

5. Mount the base station onto the bracket, snapping it into position.
6. Connect the power RJ11 jumper lead to the RJ11 jacks on the termination board and the base station.
7. For plug-top power supplies only, connect the power supply connector to the base station power connector. Make sure the base station is powered by a class 2 plug-top power source only.



Inserting the power supply connector in the wrong direction may damage the plug-top power supply and the base stations.

Position the power supply connector in the proper direction and push it into place securely.

8. Record the associated ICS port number in the space provided on the printed label affixed on the lower right corner of the mounting bracket.

Include the labeling information for each Companion base station on the completed installation floor plans.
9. Slide the cover onto the bracket, using the guide to position it properly. Snap it into place.

Sliding cover onto bracket

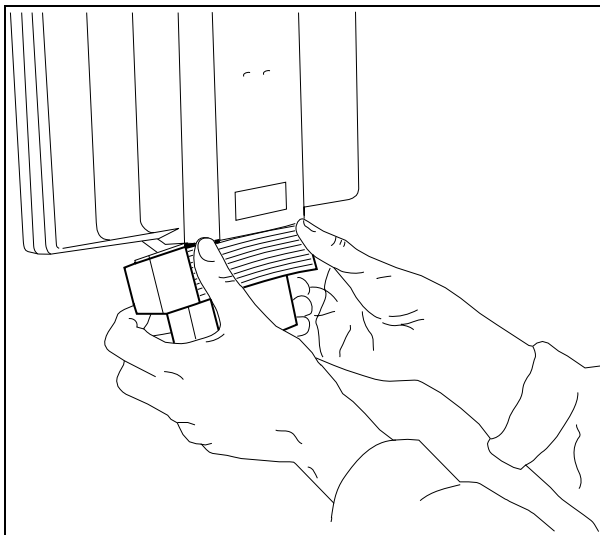

Installing portable telephones

To use Norstar Companion portables, you must first install radio base stations to transceive radio signals to and from the portable telephones, then bring the system on-line. *Installing base stations* on page 30

Companion Portable Telephones are installed differently than traditional desk sets. There are no direct connections between the portables and the Norstar system.

Do the following:

- Install the batteries and battery charging units for each portable, using the instructions that come with the portable.
- Register each Companion portable for use with the Norstar system. For complete instructions, see the Registration information beginning on page 73.

Note: Up to 60 portables can be installed on a Norstar wireless system. Each portable telephone must be registered to a DN before it can be used. By default, no Companion portables are assigned to the DNs.

The range of portable extensions available for wireless registration is 637 to 696. This means that the digit 6 is not available as a destination code.

Installing external antennas and lightning surge arrestors

When installing external antennas and lightning surge arrestors:

- The antenna should always be mounted vertically. Refer to the figure *Installed antenna and lightning surge arrestor (USA)* on page 37.
- Use #8, 12 mm to 50 mm ($1/2$ -in. to 2 in.) screws to mount the antenna bracket and lightning surge arrestor bracket to the wall.
- Always ensure that the antenna is clear of any adjacent obstruction, particularly metal. If more than one external antenna is used at a cell center, space them at least 1 m (40 in.) apart to avoid radio interference problems.
- When running the coaxial cable inside or outside, do not kink, stretch, or crush the cable. This will seriously affect its performance. The minimum recommended bending radius is 200 mm (8 in.).
- The coaxial cable length must not exceed 10 m.
- Use RG-58AU coaxial cables to connect the antennas to the base stations.

- Depending on site requirements, a proprietary extension cable can be attached between the lightning surge arrester and the antenna or between the lightning surge arrester and the base station. The total cable length should always be kept as short as possible and the recommended extension cable used only if absolutely necessary.
- You must install a lightning surge arrester for each outdoor external antenna.



FCC requirements.

In the United States, the FCC requires that only certified antennas be connected to Companion base stations.



Do not install the external antenna or the lightning surge arrester during an electrical storm.

Always turn off the base station power before connecting the coaxial cable of an outdoor external antenna.

Always install the lightning surge arrester at the cable entry point into the building.

Connect the lightning surge arrester to ground before connecting the coaxial cable.

Installing external antenna and lightning surge arrester procedures for the United States of America

Installed antenna and lightning surge arrester (USA)

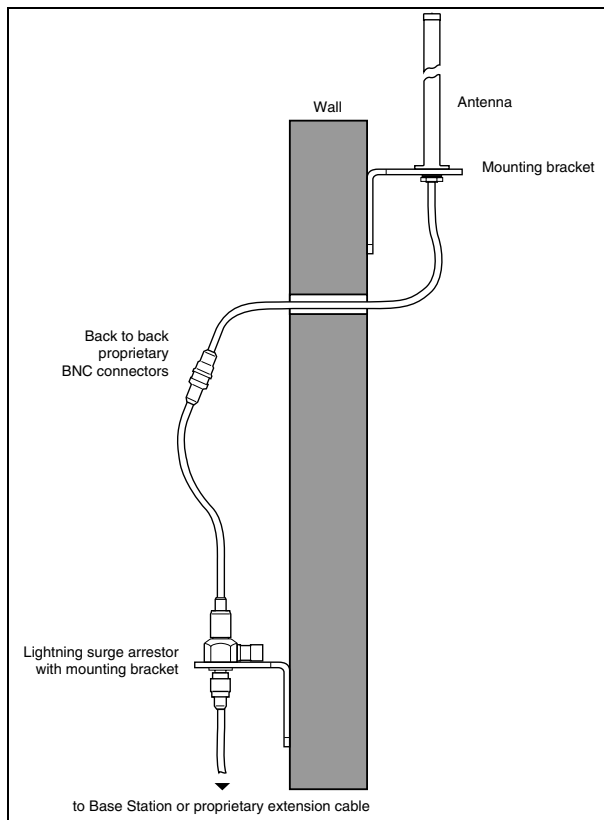

To ensure only recommended antennas are used:

- the external antenna connectors on the base station are special proprietary BNC connectors
- antennas are supplied with cables already attached and terminated with special proprietary BNC plugs to join with the connector on the base station
- cables are not supplied with exterior antennas

Planning for an outdoor external antenna (USA)

When planning to install an outdoor external antenna:

- Locate the antenna on the external wall of the building.
- Keep the outdoor external antenna as close as possible to the base station serving it. The base station itself must be indoors. The recommended mounting height is 13 ft to 16 ft above ground.
- Always install a lightning surge arrestor between an outdoor antenna and a base station.

Installing an outdoor external antenna (USA)

To install an outdoor external antenna, follow these steps:

1. Drill a hole for the coaxial cable.
2. Install conduit for the antenna cable according to local building and wiring codes.
3. Screw the antenna bracket to the wall so that the antenna is positioned vertically on the exterior wall of the building.
4. Loosen the nut on the antenna.
5. Slide the antenna into the slot of the bracket and tighten the nut.
6. Feed the coaxial cable through the wall to the lightning surge arrestor on the interior wall.

Antenna with antenna bracket (USA)

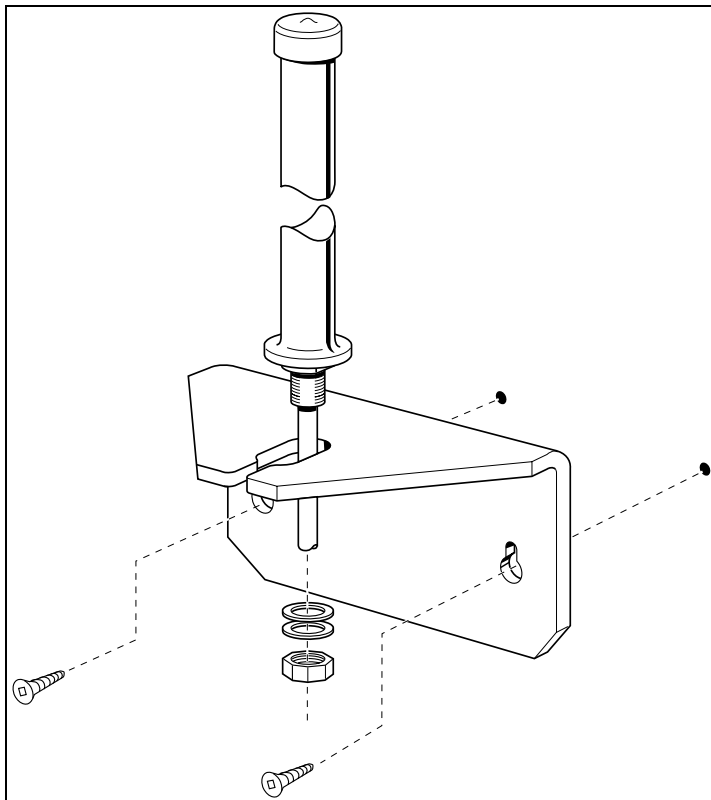

Installing a lightning surge arrestor (USA)

Install the lightning surge arrestor to protect the Companion components from electrical surges.

To install a lightning surge arrestor, follow these steps:

1. Mount the lightning surge arrestor on the interior wall as close as possible to the entry point of the coaxial cable from the outdoor external antenna.

Lightning surge arrester and bracket (USA)

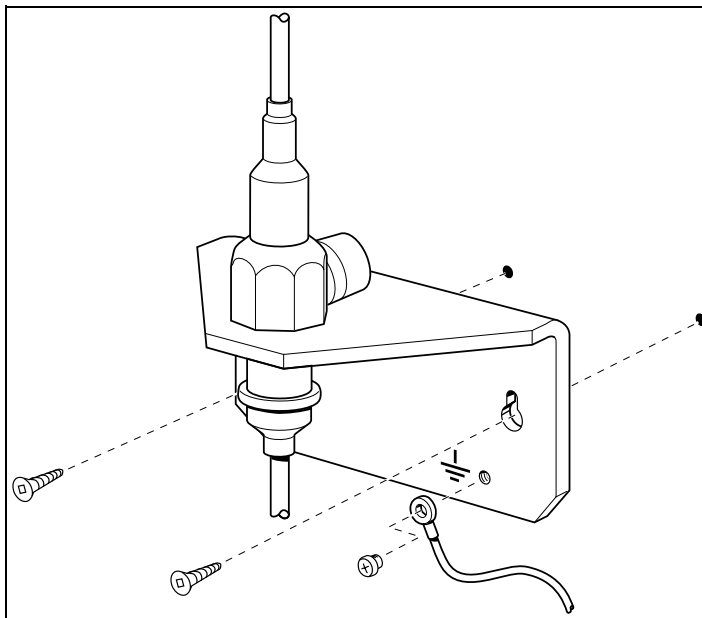

Before you connect the ground lead to the lightning surge arrester, attach it to an approved ground.



Tip - *The recommended wire gauge is 6 AWG. Connect the ground lead to the building ground. Do not connect to a ground rod or series of ground rods. If you cannot connect the ground lead to the building ground, connect it to the steel frame of the building. The connection should be no more than 6 to 10ft.*

You can also connect the ground lead to the 120 V ac conduit (which is connected to the building ground), but this is not a preferred installation.



Tip - *The connector between the antenna and the lightning surge arrestor and between the lightning surge arrestor and the base station is a proprietary BNC connector and requires alignment before a connection can be made.*

2. Route and connect the coaxial cable from the outdoor external antenna to the lightning surge arrestor.
3. Route and connect the coaxial cable from the lightning surge arrestor to the appropriate base station connector.

Installing external antenna and lightning surge arrestor procedures for Canada

There are three types of external antennas:

- indoor directional
- indoor omni-directional
- outdoor omni-directional

There are separate installation procedures for each type. You must also install a lightning surge protector for each outdoor external antenna installed.

The following are requirements for installing external antennas:

- If you are installing an external antenna on a metal surface greater than 1 8cm in diameter, position the antenna perpendicular to the surface.
- When running the co-axial cable inside or outside, do not to kink, stretch, or crush the cable. This will seriously affect its performance. The minimum recommended bending radius is 20 mm.
- Always ensure that the antenna is clear of any adjacent obstruction, particularly metal. If more than one external

antenna is used at a cell center, they should be spaced at least 0.5 m from each other to avoid radio interference problems.

- Use RG-58/U co-axial cables to connect the antennas to the base stations.



Only passive antennas are allowed to be connected to the Companion base stations.

The co-axial cable connecting the external antenna to a Companion base station must have an impedance of 50 ohms.

Installing an indoor directional external antenna (Canada)

The indoor directional external antenna comes with its own back plate for mounting. The recommended mounting height on a wall is halfway between the floor and the ceiling.

For some applications you can mount the antenna on the ceiling, for example, in a stairwell.

Indoor directional external antenna (Canada)

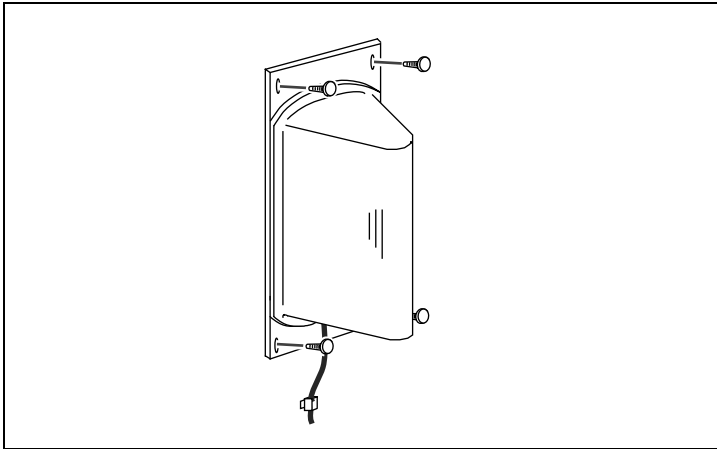

1. Mount the antenna using four screws.
2. To prevent undue stress on the co-axial cable, secure it to the mounting surface.
3. Connect the antenna to the appropriate base station radio.

Note: The co-axial cable length must not exceed 10 m.

Installing an indoor omni-directional external antenna (Canada)

When installing an indoor omni-directional external antenna:

- Use the bracket supplied to mount the antenna on a wall or ceiling.

Note: Use of a bracket other than the one supplied may not provide the necessary clearance between the floor or wall and the antenna.

- Install the bracket so that the external antenna is vertical. The recommended mounting height on a wall is half way between the floor and the ceiling.

Installing an indoor omni-directional external antenna (Canada)

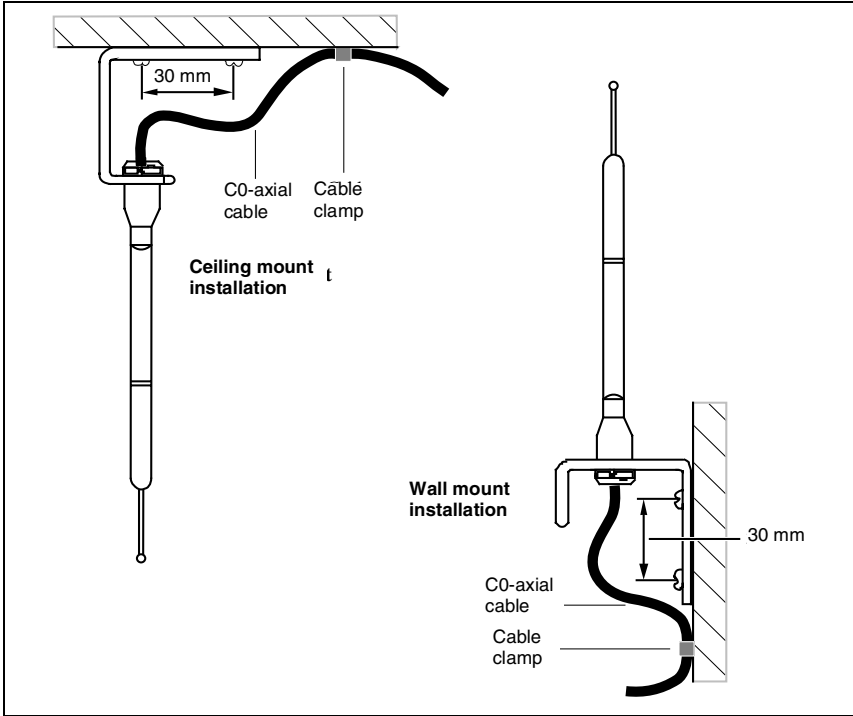

1. Insert the antenna in the bracket so that the antenna is vertical.
2. Mount the bracket to the wall or ceiling using two screws.
3. To prevent undue cable stress on the co-axial cable, secure it to the mounting surface with a clamp.
4. Connect the external antenna to the appropriate base station radio.

Note: The length of the co-axial cable must not exceed 10 m.

Installing an outdoor omni-directional external antenna (Canada)

When installing an outdoor omni-directional external antenna:

- Locate the antenna on the external wall of the building.

Note: The antenna must be mounted on a vertical surface.

- Keep the outdoor omni-directional external antenna as close as possible to the base station serving it. The base station itself must be indoors. The recommended mounting height is 4 m to 5 m above ground level.
- Always install a surge protector between an outdoor omnidirectional antenna and a base station.

Note: The connector on the outdoor omni-directional antenna is a TNC female connector, so you need an adapter to connect it to the standard BNC co-axial cables needed for the surge protector and the base station. You can also use a co-axial cable with a TNC male connector on one end and BNC male connector on the other end.



Fit lightning protection to the antenna if appropriate. Refer to Installing a lightning surge arrester (USA) on page 39.



Important points to remember:

- Do not install the external antenna or the lightning surge protector during an electrical storm.
- Always turn off the base station power before connecting the co-axial cable of an outdoor external antenna.
- Always install the antenna at the cable entry point into the building.
- Connect the lightning surge protector to ground before connecting the co-axial cable.

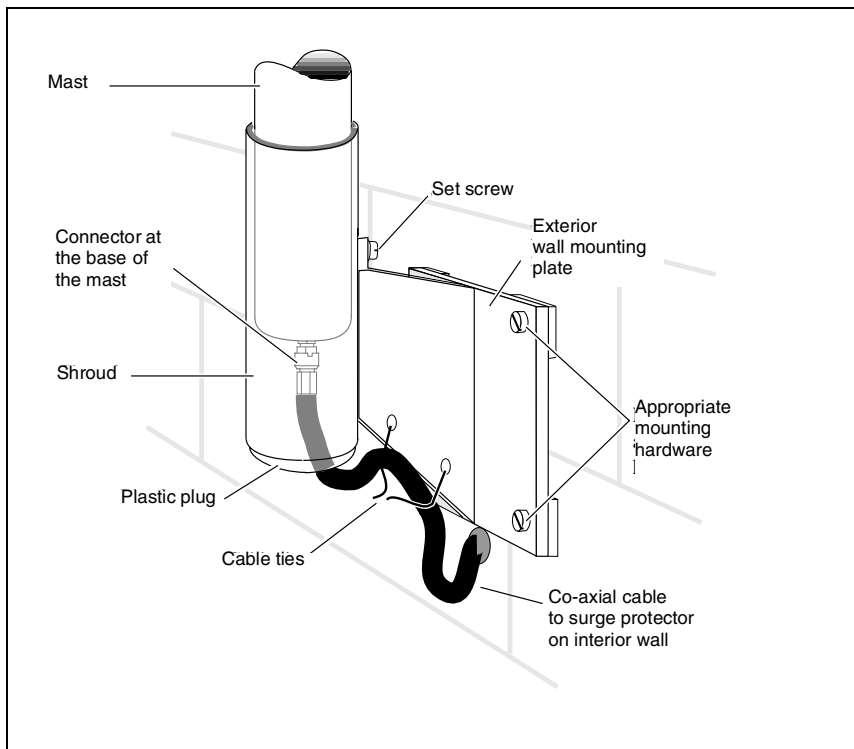
Installing the outdoor omni-directional external antenna (Canada)

To install an outdoor omni-directional external antenna, follow these steps:

1. Screw the antenna mounting plate vertically to the exterior wall of the building with lag bolts or other appropriate hardware as shown in the illustration, *Installing the outdoor omni-directional external antenna (Canada)*.
2. Feed one end of the co-axial cable up through the bottom of the antenna shroud and attach the BNC connector to the base of the mast.
3. Slide the mast down into the shroud until it fits.

4. Rotate the mast until the threaded hole in the base of the mast is aligned with the set screw hole in the shroud, and then tighten the set screw.
5. Route the co-axial cable along the bottom edge of the plate between the shroud and the wall plate and tie the cable up.

Note: The total length of the co-axial cables from the outdoor external antenna to the base station must not exceed 10 m.

6. Insert the plastic plug into the base of the shroud to keep the weather out.
7. Feed the co-axial cable through the wall to the surge protector on the interior wall.

Installing a lightning surge protector (Canada)

Install the lightning surge protector for the outdoor omnidirectional antenna to protect it from electrical surges. The recommended lightning surge protector is part number A0382082. Refer to the installation instructions that come with the antenna for more details on its installation.

To install a lightning surge protector, follow these steps:

1. Mount the surge protector on the interior wall, shown in the following illustration, as close as possible to the entry point of the co-axial cable from the outdoor external antenna. Follow the installation instructions that come with the surge protector.

Installing the lightning surge protector (Canada)

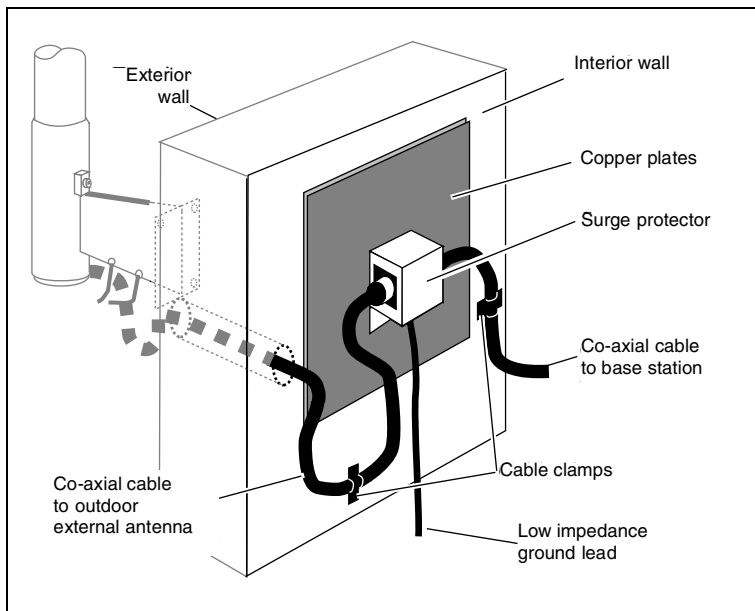

2. Before you connect the ground lead to the surge protector, attach it to an approved ground. The recommended wire gauge is 6 AWG (4 mm). Connect the ground lead to the building ground. **Do not connect to a ground rod or series of ground rods.** If you cannot connect the ground lead to the building ground, connect it to the steel of the building. The connection should be no more than two to three meters. You can also connect the ground lead to the 120 V ac conduit connected to the building ground, but this is **not** a preferred solution.
3. Route and connect the co-axial cable from the outdoor external antenna to the surge protector.
4. Route and connect the co-axial cable from the surge protector to the appropriate base station BNC connector.

Note: The total length of the co-axial cables from the outdoor external antenna to the base station must not exceed 10 m.

Powering up the system

If you added a base station that requires a software update, the system begins downloading the software to the base station. The Administration Terminal display shows **BS-1 Dload Start**. Press **CLEAR** to clear the message. When the base station software is downloaded, the Administration Terminal shows **BS-1 Dload Done**. Press **CLEAR** to clear the message. Some Base Stations may not be powered up at the same time, and this message repeats at the beginning of each download.

In the United States, the display shows one of the following messages after powering up:

If display shows	See
UTAM code need'd	System logical identifier (LID) on page 66.
UTAM test failed	Alarm codes on page 102 in the Troubleshooting chapter.



A loss of UTAM information occurs when upgrading U.S.-based MICS-XC systems.

UTAM Recovery Codes are required.

Programming

Programming is performed by the installer or the customer service representative. The interface allows you to change settings for the entire Norstar system, plus settings for individual telephones and external lines. Most of the settings can also be programmed by a system coordinator who has a SysCoord+ password. This password is distributed only by the installer to avoid system complications.



Programming affects system operation.

Only a qualified installer or customer service representative should perform startup, installation and maintenance programming. Some of the settings affect the correct operation of the system.

Installation programming







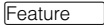

Before you attempt to program the Companion sets, familiarize yourself with the *Programming* section of the *Modular ICS Installer Guide*. The section explains the four types of passwords and the menus each password can access. Not that that the Companion prompts are only visible through the MICS-XC software.

For information about Companion set programming using the System Coordinator and Basic passwords, refer to the *Modular ICS Companion System Coordinator Guide*.

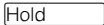
Programming tools

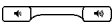
As with all Modular ICS programming, you can use a T7316 Business Series Terminal or an M7310 or M7324 Norstar set to perform the programming.

In this book, all processes requiring dialpad buttons are presented in the Business Series Terminal button icons. If you are using one of the other telephones, use the appropriate overlay, and then refer to the table below for corresponding button faces:

Button Name	T7000, T7100, T7208, T7316	M7100, M7208, M7310, M7324
Feature		
Hold	 	 
Volume Control		
Release		

Programming overlays are included with the *Programming Record*.

The Norstar Programming Record

The *Programming Record* provides a convenient way to record what you have programmed. There is a special section for Companion-specific records that includes charts for recording the handset information and the base station information.

Photocopy pages from the record, as necessary.

Exiting programming

Norstar stores your changes automatically as soon as you alter any settings.

When you have completed your programming session, press . The display briefly reads **End of session**.

Viewing your programming updates

If any of the changes you have made to programming have not immediately taken effect, you see an **UPDATE** display button when you leave programming. The display shows you how many telephones have not been currently updated due to the system being busy with other programming or the telephone is in use.

Press **DN5** to see the specific sets where programming changes have not been updated. Items disappear from the list as they are updated, and **UPDATE** disappears once all changes are complete.

Template defaults

This section describes only the defaults that apply to Companion programming. For all other default settings, refer to *Programming Record*.

Note: (U.S. only). Before registering Companion portable telephones you must first obtain and enter a certain number of portable credit keys. Also keep in mind, before the base stations can be recognized by the XC system, you must obtain and enter a UTAM Activation Key. Please refer to Software keys (U.S. only) on page 67 before setting up your wireless system.

Companion defaults

Setting	Default
Startup defaults	
MICS-XC template	PBX
Start DN	221 (may be different for upgraded systems)

Setting	Default
Passwords defaults	
Reg. pswd	72346 (RADIO)
System programming	
Registration Registration Portable DNs	
	N Available
Radio data Re-evaluation Status Schedule Radio credits (U.S. only)	
	Required Not scheduled No defaults assigned
Radios Cell Assignment Antenna Type	
	Unassigned Internal
Cells Cell radios Cell nghbrs Cell rad nghbrs	
	Unassigned Unassigned Unassigned
Note: DID Companion defaults are the same as PBX defaults.	

Startup programming

Before you perform Companion programming, your system should be running and configured.

Startup programming is explained in the *Modular ICS Installer Guide*.



Startup erases programming.

Startup erases any existing programmed data, and resets the system to factory defaults.

Performing Startup

1. Enter the Startup access code from a M7310, M7324 or T7316 telephone dialpad, by pressing

* * S T A R T U P which is the same as
 * * 7 8 2 7 8 8 7 .

To be accepted, the Startup code must be entered no later than 15 minutes after the Norstar system has been powered up.

If 15 minutes have elapsed since you powered up the system, turn system power off and on, to prepare for the Startup process.

2. Enter the Installer password. The default is

C O N F I G which is the same as
 2 6 6 3 4 4 .



Tip - *The Installer password shown is the default normally used for Startup. For a system which has already been programmed, the Installer password might have been changed in programming and recorded in the Programming Record.*

Changing the default template

After entering the Startup access code and Installer password the display shows **Reset memory?**.

1. Press **YES** to select a default template. The display shows the current template.
2. Press **CHANGE** to choose the appropriate template.



Changing template resets programming.

If you change your system template, your programming will be reset.

Entering programming

After performing Startup, use programming to change default settings as required.

Headings and subheadings in programming help you to keep track of where you are.

Companion programming falls under System prgrming and has the following subheadings:

Registration	lets you enable and disable registration and verify which portable DNs are available
Radio data	lets you view and change cell and radio settings

For other programming operations refer to *Modular ICS Installer Guide*.

Entering programming for system coordinators

The person on staff who is in charge of making changes on the Norstar system is called the system coordinator. The everyday Companion programming done by system coordinators is described in *Modular ICS Companion System Coordinator Guide*.

Some system coordinators need to be able to program more advanced settings and functions in order to carry out the day-to-day requests and upkeep of the Norstar system. These coordinators are usually dedicated communications specialists who work with large Norstar systems or other telephone systems like PBX or Centrex.

By using a special password, a system coordinator can see and change many, but not all, of the programming settings used by an installer. In this guide, programming that can be changed only by an installer is marked in the heading. If you are programming using the System Coordinator Plus password, you do not see these items when you move through programming.

1. Press which is the same as . The display shows **Password:.**
2. Enter the System Coordinator Plus password. The default password is **SCPLUS (727587)**. The display shows **Terminals&Sets.** Three triangular indicators ► appear on the vertical display between the rows of buttons.
3. Place the programming overlay over the buttons pointed to by the indicators ►.

Entering programming using other passwords

A set of the most often used headings and subheadings is available by using a System Coordinator password. This level of access is designed for the average user who takes care of the day-to-day changes to the Norstar system, but who does not need to use more advanced programming. The default password is ADMIN (23646).

Norstar features

Refer to *Modular ICS Companion System Coordinator Guide* for a complete list of features supported on Companion portables.

Portable features

For information about the features of your handsets, refer to the *Portable Telephone User Guide* that is supplied with your portable.

External paging system (customer supplied)



Tip - *The external paging feature is supported on the Companion portable telephone. For more information on paging with a Norstar supported portable telephone, see Modular ICS Installer Guide.*

Registration password

Before anyone can begin making portable telephone calls, the portable telephones must be registered for use with the Norstar system. The recommended steps are as follows:

1. Change the registration password for your system.
2. Enable registration for the system.
3. Confirm the availability of directory numbers (DNs) for each Companion portable telephone.

4. Individually register each Companion portable telephone.
5. Disable registration for the system.

Changing the Registration password

To ensure unauthorized portables are not registered to your system, a separate level of password access is provided. You can, and should, set your own password to prevent unauthorized handsets from registering on your system. You can change the Registration password in Passwords.



Change password to avoid incorrect registration.

To ensure accurate registration, change the Registration password before registering any portables. If there is another wireless system in radio range, and both systems have the same Registration password and registration enabled, you may accidentally register on the other system.

The default Registration password is **RADIO**
().

Use **CHANGE**, the dialpad and **OK** to program the Registration password.

Record the password in the *Programming Record*.



Tip - You can choose any combination of one to six digits. It is easier to remember the password if the digits spell a word. Provide this password only to selected personnel to prevent unauthorized access to programming. The implications of such access may include the rearrangement of line assignments, which could affect the operation of the Norstar system.

Companion programming

Companion programming is found under the **System programming** heading. It includes the following subheadings:

Registration



Software Keys are required to activate wireless capabilities (U.S. only).

To take advantage of the wireless capabilities available to your Norstar system, you must first enable a certain number of portable credits using Software Keys purchased through Nortel Networks. Keys are obtained and entered into the system by the installer. For more detailed information on enabling Norstar Companion, refer to the Software keys (U.S. only) on page 67.

You must enable registration for the entire Norstar system to allow individual portables to register.

The options are Yes (Y) and No (N).

- Yes indicates that Registration is enabled.
- No is the default and indicates that Registration is not enabled.

Use and **CHANGE** to enable or disable registration. Press **CREDITS** (U.S. only) to view the credits available.



Registration should normally be disabled.

For security reasons, and to prevent unauthorized users from being registered to your system, set registration to N when you have finished registering the portables.

Portable DNs

Once registration is enabled for your Norstar Companion system, a series of extension numbers (637 to 696) automatically becomes available for registration. Check that an extension number is still available before registering a portable telephone to it.



Tip - *The extension numbers are based on a system with three-digit DNs. If your system has more, the first number will be repeated.*

However, your system may also have a different starting DN (default 221), so these extensions will reflect that difference.

- If the extension number shows a status of Available, that extension number is ready for registering a Companion portable telephone.
- If the extension number shows a status of Registered, a Companion portable telephone is already registered to that extension number. In this case, you can either pick a different extension number, or de-register the current portable telephone. You must perform deregistration at the portable and in either an Installer or System Coordinator programming session.

Press to view registered and available DNs.

Note: The DN range 637 to 696 can be used by either portable telephones or ISDN S-loops. You can assign all 60 of the DNs to S-loops and none to portable telephones. You can assign up to 30 DNs to portable telephones, leaving 30 for S-loops. Within these two limits you can choose a combination of ISDN and portable telephone DNs. For more information, refer to *Modular ICS Installer Guide*.

Deregistering a portable

Deregister an extension number when:

- the portable must be replaced due to loss or breakage
- the owner departs and you want to assign the handset to someone else with a different telephone number

Press and **DEREG** to deregister a DN.



Tip - *This procedure does not clear the registration data in the portable. You must also deregister from the portable telephone itself using on-the-air deregistration. For instructions, see the Portable Telephone Registration Instructions or Deregistering the C3050 on page 83.*

Radio data

Note: (U.S. only). Before registering Companion portable telephones you must first obtain and enter a certain number of portable credit keys. Also, before the base stations can be recognized by the MICS-XC system, you must obtain and enter a UTAM Activation Key. Please refer to Software keys (U.S. only) on page 67 of this document before setting up your wireless system.

Re-evaluation

Re-evaluation automatically assigns the base station radios to cells and determines which cells are neighbors. When adding or removing base stations, Re-evaluation needs to be applied to the system.



Schedule re-evaluation during slow periods.

Plan on conducting a re-evaluation of your Norstar Companion when the system is not busy with calls. Wireless calls may be lost during the re-evaluation process.

After installing Norstar Companion components and obtaining the proper number of UTAM activation keys (see *Software keys (U.S. only)* on page 67), you need to verify that wireless re-evaluation has occurred. Alarm code messages *can* be used to indicate whether or not wireless re-evaluation has occurred:

Alarm	Definition	Re-eval occurred?
21	Re-eval in progress	No
22	Re-eval complete	Yes
23	Cell configured. Failed to come on line	No

Please refer to the *Alarm and Event Code Manual* for more information on alarm messages and the actions that should be taken to resolve any problems.

Re-evaluation Status

Press to see the Re-evaluation status. If the display reads **REQUIRED**, you can carry out the re-evaluation by pressing **CONTINUE** and following the prompts.

Re-evaluation Schedule

This setting allows you to select whether to proceed or to schedule the next Re-evaluation.

The default setting is **Not scheduled**. If you want to schedule a re-evaluation, press **CHANGE**. You can begin re-evaluation by pressing **NOW**, or schedule re-evaluation by pressing **LATER**. You are prompted to enter a time and date.

Radios

Radio programming settings apply to base stations.

Radio credits (U.S. only)

Press **CREDIT** to see the number of radio credits available and the total number of radio credits. Verify that the total number of radio credits is enough to support the system you have just installed. The number of radio credits must be double the number of base stations you have installed. If the total number of radio credits is not enough for the system, you may need to obtain additional credits. See *Software keys (U.S. only)* on page 67.

Cell Assignment

A cell is the area covered by one or more radios in close proximity. As you move around your office, while on a call with your portable, the call is handed off from one cell to another. A call on a portable can be handed off from one cell to another only if those cells are programmed as neighbors. The Norstar system automatically assigns cell neighbors and re-evaluates the cell-to-cell configuration when base stations are added or removed.

This setting allows you to determine if a base station radio is assigned to a cell in the Companion system.

Press and enter the radio number to see the radio setting: Assigned or **Unassigned** or select **LIST** to see all in sequence.

Antenna Type

Installer password required

This setting allows you to select the type of antenna to use for each base station in a system.

Press and enter the five-digit radio number or select **LIST** to see all in sequence.

Use **CHANGE** to select the appropriate setting: **Internal** or **External**.

Cells

Cell programming allows you to examine the cell radio and cell neighbor configuration. Choose the cell you want to examine by pressing and the cell number (01 to 32) or select LIST to see all in sequence. When in the list mode, there is a softkey that allows you to FIND a specific cell number.

From a specific cell number, select to see all Cell radios, Cell neighbors and Cell radio neighbors.

Cell radios

This sub-heading allows you to view the five-digit number of any radios assigned to this cell.

For example, if radio 07012 is in the cell, the display shows **07012 assigned**. Press and enter the five-digit radio number to view the setting: Assigned or **Unassigned**. Select LIST to see all in sequence. Select SCAN to go to the list or next radio with a setting **Assigned**.

Cell nghbrs

This sub-heading allows you to view the two-digit number of any cells that border a particular cell in a system. You can then remove any of them or add more cells. Press and enter the cell number to see the settings: Assigned or **Unassigned**. Select LIST to see each neighbor in sequence. Select SCAN to see the first/next cell **Assigned**.

For example cell 01, the display shows **Nghbr:03** and **Nghbr:04**. This means that cells 03 and 04 have been assigned as cell neighbors.

Cell rad nghbrs

This sub-heading allows you to view the two-digit number of any cells that border a particular cell in a system, these are called cell neighbors. As well, you can view any cells that border the cell neighbors. Press and enter the cell number to see the settings: Assigned or **Unassigned**. Select LIST to see each neighbor in sequence. Select SCAN to see the first/next cell **Assigned**.

For example cell 01, the display shows **Rad nghbr:03**, **Rad nghbr:04**, and **Rad nghbr:11**. Cell 11 does not appear as a cell neighbor (see the example under Cell nghbr), so it must be a neighbor of cell 03 or 04.

System logical identifier (LID)

This setting allows you to change the code by which the system identifies itself to portables and which the portables use to request service from the system. The default setting is randomly generated by the system at start-up. When the system logical identifier (LID) is changed, all portables must register again.

When changing the system LID, you can enter any hexadecimal number between 0500 and FFFE.

Note: Hexadecimal characters can only range from 0 to 9 and A to E.)



Changing system LID de-registers all portables.

If you change the system LID, you invalidate the registration of all the portables in the system. Portables must be re-registered before they can be used.

There are only two reasons to modify the system LID.

- The site has multiple systems, and you want users to be able to move from system to system without changing slots on their portable telephones. All systems must be set to the same system LID.
- Two systems that are located near each other were accidentally assigned the same system LID. Users of one system can access the other system.

Note: This highly unlikely situation could occur, for example, in an office building occupied by multiple organizations.

Use and CHANGE to modify the System LID.

Software keys (U.S. only)

The United States FCC has appointed UTAM Inc. as the body responsible for coordinating and verifying the installation or relocation of unlicensed, personal wireless communication devices. To comply with UTAM Inc., Norstar uses keys and credits to control user capacity and to ensure system location verification. These software keys and credits are required to activate Norstar Companion services on a new or upgraded system. The credits *should* have been purchased at the time the order was placed.



Base stations must be installed and powered first.

Base stations must be installed and powered before entering any UTAM Activation Keys. Verify that the base station LED status is solid red and green before entering any UTAM keys. Failure to follow the correct order of UTAM key entry may result in a disabled Norstar Companion system.



Call Nortel Networks Customer Response Center at 1-800-321-2649 to verify that you have approval from UTAM Inc. when initially installing wireless equipment or relocating wireless equipment.

Failure to receive approval prevents you from enabling wireless communication on the Companion system. You must provide the Companion ID each time you are requesting codes or credits.

A disabled wireless system means that base stations and portables are not operational, but registration information is retained. These devices may be reactivated by returning the system to its previous configuration or by entering a UTAM Recovery Key. A new system is activated by entering a UTAM Activation Key.

The Software keys can be obtained and entered using the following steps.

Step 1: Obtain the Companion ID

The Companion ID Label is sent to each customer once radio credits have been purchased. In order to implement the credits and take advantage of the Norstar Companion capability, you must obtain two sets of keys. One is the Credit Key and the other is the UTAM Activation Key. The keys are available by calling the Nortel Customer Response Center. You must provide the following information as shown on the Companion ID label:

- your Companion ID number
- the zip code
- the number of radio credits already purchased (if applicable)

Step 2: Obtain the System Identification Number

Obtain the System ID (SysID) by pressing

, or

on any programming set.

This information is also available by accessing **Software keys** in an Installer programming session:

1. Place the programming overlay on an M7310, M7324, or T7316 telephone.
2. Press . The display reads **Password:**.
3. Enter the most recent Installer password. The display reads **Terminals&Sets**.
4. Press until the display reads **Software keys**.
5. Press The display reads **SysID:** followed by the unique System Identification Number.
6. Press to continue in **Software keys** or to exit.

Record the Companion ID and the SysID in the *Modular ICS Programming Record*.

Step 3: Call the Nortel Customer Response Center

1. To obtain your two sets of keys call the Nortel Networks Customer Response Center at: **1-800-321-2649**.
2. Follow the voice prompts for Norstar products. When you are asked for the information concerning your request, provide the following:
 - the Companion ID (on the label);
 - the customer's zip code (on the label); and
 - the System ID (see Step 1).

3. Indicate the number of radio credits you require. You need two credits for every base station in your system.
4. You are given two keys, the UTAM Activation Key and the Credit Key. The keys consist of three separate numeric strings that contain eight digits each.

UTAM Activation Key

This key activates wireless capability for a new system or a system upgrade which involves base stations. The software recognizes base station radios as **Radio credits**. There are two radios for each Norstar Companion base station. See **Radio credits (U.S. only)** on page 64 for information on viewing the available number of radio credits.

Portable Credit Key

This key predefines the maximum number of portables that can be registered to the system. Systems can only register as many portables as there are available Portable Credits. A maximum of 60 Companion portable telephones may be registered.



Record your keys in the Programming Record.

In the case of an upgrade, you receive new keys. You need the old and new keys to re-activate the system following a system restart.

Step 4: Enter the keys

You may enter the keys in either order: UTAM Activation Key first or Credit Key first. Keys are entered by first accessing **Software keys** in a programming session.

1. Press . The display reads **SysID:**.
2. Press . The display reads **Password keys.**

3. Press . The display reads **Key 1:..**
4. Enter the 8 digit password number for Key 1. Use **BKSP** to make corrections. The display reads **Key 2:..**
5. Enter the eight-digit password number for Key 2. Proceed as above until you have finished entering Key 3. The display reads **Entry successful.**
6. Repeat steps 3 through 5 for the other key.
7. Press until the display reads **Software keys** or  to exit.

The system automatically starts reevaluation and the display shows **Re-Eval in prog.**, **Re-Eval complete**, **System online**, as the reevaluation runs its course.

Note: If the UTAM Activation Code entry is unsuccessful, the display shows **Invalid code**. If this happens, reenter the code or call Nortel Customer Response Center at **1-800-321-2649** for assistance.

Step 5: Configure base stations and portables

Once you have entered the required keys to activate the base stations and to obtain enough portable credits, you can proceed with programming these items with the MICS-XC system.

Configure your base stations

Companion base stations are recognized by the MICS-XC system once the UTAM activation keys have been entered. To verify whether or not the base stations have been properly recognized, see Radio data on page 62 for information on the re-eval process.

Register your Companion portables

Norstar Companion Portable telephones are added to the system using the portable registration process. Refer to the *Modular ICS Companion System Coordinator Guide* for more information on registering Companion portables.



Tip - *If your system has been powered down for an extended period of time your System ID may have changed. Contact the Nortel Networks Customer Response Center to obtain a UTAM Regression Key.*

If your Norstar Companion system seems disabled (all keys were input but base stations and portables are not operational), contact the Northern Customer Response Center to obtain a UTAM Recovery Key.

Registering individual portables







Registering the C3060

The following section describes the procedures involved in registering Companion C3060 portable telephones. To register each portable with the Norstar system, you must do two things:

- Register the portables by entering the Registration password on each one.
- Verify that the portable functions correctly.

C3060 Icons

The following table identifies the C3060 portable telephone icons:

C3060	Icon function
	Mute button
	Hang up button
	Answer button
	Feature button
	Telephone directory button
	Service directory button

To register the C3060

1. Turn on registration for your system.
2. Press **Menu** ***** ***** *****. The display shows **ADMINISTRATION** and three softkeys, **SYS**, **PINFO**, **DATA**.
3. Press **SYS**. The display shows **WIRELESS SYSTEMS**.

Note: Wireless Systems is a registration list of names for up to six different systems. If the list is full, and you must add another system, de-register an existing system name.

4. Press **ADD** to establish a radio link. The display briefly shows **Adding SYSTEM: (next system number)**. If **ADD**, not available, start over at step 1 again.

The display shows **Pswd:** for an established radio link.

The display shows **No connection** for a radio link not established.

5. Enter the registration password. The default password is **7PQRS** **2ABC** **3DEF** **4GHI** **6MNO** (**RADIO**). The display shows **DN:**.

The display shows **Invld Pswd** for a wrong password.

6. Enter the three-digit Directory Number (DN) between 637 and 696. The display shows **Enter name**.



The display shows **Invld DN** when the DN is wrong.

The display shows **Reg failed** when the registration fails.

If you try to register the C3060 to the same system twice, the display shows the registered name. For example **Registered as NORTEL 1**.







7. Enter up to 16 characters for the system name. For example, NORTEL 1.
 - Press the dial pad key until the letter you need appears on the display. For example, press key 5 three times to display the letter L.
 - Press SPACE to add a blank space to the name.
 - Press BACKSP to delete the previous character.
 - Press  if the next letter is on the same button.
8. Press SAVE . The display shows the registered name. For example, NORTEL 1 registered .
9. Turn off registration for your system.

To confirm that the C3060 is registered

1. Select the system you just registered.
 - a. Press  to power off the portable, and press  again to power on the portable.

If the display shows the system name that you just registered, proceed to step 2.

If the display shows a different system name or **No system selected**, then:

- b. Press    .
- c. Press SYS.
- d. Press  or  until the display shows the system name you just registered.
- e. Press SELECT. Then press OK or END to exit Administration.

2. Make a call.
 - a. Press . You hear dial tone, and the display shows LTHK. If you do not hear dial tone, check that you have selected the correct system and that the associated desk telephone is idle or register the portable again.
 - b. Dial the number of a working telephone. The telephone must ring to confirm the registration.
3. Receive a call.
 - a. If the portable has the same extension number as a desk telephone, make sure the desk telephone is idle and Call Forward is not active.
 - b. On another working telephone, dial the telephone number of the registered portable. The portable must ring to confirm the registration.

If you do not hear dial tone, or if the portable does not ring, refer to *Troubleshooting*. If you continue to experience difficulty registering the portable, contact your distributor.

Deregistering the C3060

You can deregister the C3060 two ways:





- from the portable
- from the Administration Terminal

If you are in radio range of the system deregistering the C3060 from the portable clears registration information stored in the portable and the system. For example, you may want to deregister the portable before you assign it to another DN on the same system.

Deregistering the C3060 from the Administration Terminal does not clear registration data from the portable. Use this method if the portable were lost or stolen or if you want to assign it to another system.

If a portable is registered on other systems, it will still be available on those systems. You deregister one system at a time.

Note: If you are out of range of the system, this procedure clears registration data only from the portable.







1. Press    . The display shows **ADMINISTRATION** and three softkeys, **SYS**, **FINFO**, **DATA**.
2. Press **SYS**. The display shows **WIRELESS SYSTEMS**.
3. Press **ERASE**. The display shows **Erase item?**.
4. Press **OK**. The display shows **Deregistering...** and then **Item erased**.

Measuring RSSI for a C3060

The Receive Signal Strength Indicator (RSSI) is a measurement of the signal strength the base station receives from the portable. The strongest RSSI value the display shows is **-44** dBm. The weakest RSSI value the display shows is approximately **-94** to **-100** dBm.

Measuring undirected RSSI

You can measure the signal strength between a portable and a system-selected base station using undirected RSSI.

1. Press . The display shows **MENU**.
2. Press  or  until the display shows **Feature request**.
3. Press **SELECT**. The display shows **Feature:**.
4. Press   . The display shows the radio ID of the base station to which the portable is linked, followed

by the signal strength and power mode. For example, 14112 - 67.

Hand-off occurs normally between the cells.

Note: In this example, the module is 14, the port is 11 and the radio is 2. The signal strength measured by the base station is -67 dBm.

5. To end the connection, press .

Measuring directed RSSI

You may want to measure the RSSI between a portable and a specific base station radio. For example, you may suspect that one of the two radios in a base station is not working properly. You can also use directed RSSI to prevent hand-off while you find a cell edge. To measure the RSSI of a specific radio, you must be in range of two base stations—the one you want to measure and another base station.

Note: You cannot measure the directed RSSI of both radios in the base station at the same time.







Before you measure directed RSSI, use the *Programming Record* to find and note the following:

- the five-digit ID of the base station radio you want to measure. Do this by mapping the base station location to the TCM port.
The first four digits indicate the TCM port to which the base station is connected.
The last digit indicates the number of the radio on the base station.
For example, the number 03142 on the base station is connected to TCM port 0314, and 2 is the radio number. The number might be printed on a label attached to the base station mounting bracket.

- the radio IDs of all other base stations in the same location
1. Follow steps 1 to 5 of *Measuring undirected RSSI* on page 77.

If the display shows the ID of a base station neighboring the one you want to measure, proceed to step 2.

If the display shows the ID of the base station you want to measure, move out of the cell boundary range so that hand-off occurs and then continue with step 2. To end the undirected RSSI connection, press .

2. Press . The display shows **MENU**.
3. Press  or  until the display shows **Feature request**.
4. Press **SELECT**. The display shows **Feature:**.
5. Press   .
6. Enter the five-digit ID code for the base station radio you want to measure. This mode displays the radio ID of the base station to which the portable is linked, followed by the signal strength and power mode. For example, **14112 - 67**.

Hand-off does not occur as you move between the cell boundaries. The link drops when you move out of range.

Note: In this example, the module is **14**, the port is **11** and the radio is **2**. The signal strength measured by the base station is **-67** dBm.

7. To end the connection, press .











Registering the C3050

The following section describes the procedures involved in registering Companion C3050 portable telephones. To register each portable with the Norstar system, you must do two things:

- Register the portables by entering the Registration password on each one.
- Verify that the portable functions correctly.

C3050 Icons

Some C3050 portable telephone icons for Canada and the United States are different but have the same functions. The following table identifies these icons:

C3050 Canada or C3050 Rev 2 US	Icon function	C3050 US Rev 1
	Mute button	
	Hang up button	
	Answer button	
	Menu button	
	Telephone directory button	

To register the C3050

1. Turn on registration for your system.
2. Open the portable flap. The portable displays the current system name or **No system selected** for two seconds.
3. Press **[System]**. The portable displays **WIRELESS SYSTEMS**. Your portable can be registered to a maximum of nine different systems.

4. Press the **ADD** key to establish a radio link. The portable displays **Adding SYSTEM:#** for two seconds, then it displays **Pswd:**.
If a radio link is not established, the portable displays **No connection**. Close the flap, and repeat the procedure from step 1.
5. Enter the Registration password. The default is **7PQRS 2ABC 3DEF 4GHI 6MNO** (RADIO). The portable displays **DN:**.
If the registration password is not correct, the portable displays **Invalid Pswd**. Close the flap and repeat the procedure from step 1.
6. Enter the DN (between 637 and 696). The portable displays **Enter name**.
If the DN is incorrect, the portable displays **Invalid DN**. If the registration fails, the portable displays **Reg failed**.
If you try to register the C3050 to the same system twice, the portable displays the registered name, for example **Registered as NORTEL 1**.
7. Enter up to 16 characters for the system name, for example **NORTEL 1**. If you are registering to only one system, use the portable telephone user's name.

Press the key that has the letter. For example, to enter **A**, press **2ABC**, to enter **B**, press **2ABC 2ABC**.

Press **SPACE** to add a blank space to the name.

Press **BACKSP** to remove a mistake.





Press **◀** or **▶** to move the cursor backward or forward.
8. Press **SAVE**. The portable displays the registered name, for example **NORTEL 1 registered**.
9. Turn off registration for your system.

To confirm that the C3050 is registered

1. Close, then open the portable flap.

If the portable displays the system name that you just registered, proceed to step 5.

If the portable displays a different system name, or **No system selected**, proceed to step 2.

2. Press **System**. The portable displays **WIRELESS SYSTEMS**.
3. Press the scroll keys ( or ) until the system name is displayed.
4. Press **SELECT** (or **OK** if the correct system is already selected).
5. Press **Line** or . You hear a dial tone, and the portable displays .
6. If you do not hear a dial tone, check that you have selected the correct system and try to register the portable again.
7. Close the flap on the portable, and set the Ringer Control Switch to .
8. If the portable is twinned with a desk telephone, make sure the desk telephone is idle and Call Forward is not active.
9. On another working telephone, dial the telephone number of the registered portable. If the portable rings, it is functioning properly.

If you do not hear a dial tone, or if the portable does not ring, refer to the *Troubleshooting* section in this guide. If you still cannot register the portable, contact your system supplier.

Deregistering the C3050

You can deregister the C3050 in two ways:

- from the portable
- from the administration set

You can deregister the portable to clear information stored in the portable and the system. To do this, you must be within the coverage area. For example, you may want to deregister the portable before you assign it to another DN.

You can also deregister a portable using the Norstar administration set. You could use this method if the portable was lost or stolen, or if you wanted to assign it to another system. This procedure does not clear registration data from the portable.

If the portable is registered on other systems, it is still available on those systems. You deregister from one system at a time.

To deregister the C3050

1. Open the flap on the portable.
2. Press **System**. The portable displays **WIRELESS SYSTEMS** and **ADD**.
Note: *Do not* select **ADD**.
3. Press the scroll keys (∇ or \triangle) to display the system name that you want to deregister.
4. Press **ERASE**. The portable displays **Erase item?**.
5. Press **OK**. The portable displays **Deregistering...** and then **Item erased**.

Measuring RSSI for a C3050

The Receive Signal Strength Indicator (RSSI) is a measurement of the signal strength the base station receives from the portable. The base station controls the power transmitting mode of the portable. When the base station receives a weak signal, it instructs the portable to transmit in high-power. When the base station receives a strong signal, it instructs the portable to transmit in low-power. The strongest RSSI value the portable displays is **-45** dBm (in the US) and **-44** dBm (in Canada). The weakest RSSI value the portable displays is approximately **-94** to **-100** dBm.

To measure undirected RSSI

You can measure the signal strength between a portable and a system-selected base station radio using undirected RSSI.

1. Open the portable flap.
2. Press **Line** or .
3. Press *** 8^{TUV} 9^{WXYZ} 8^{TUV}**. The portable displays the radio ID of the base station that the portable is linked to, followed by the signal strength, for example **03142 - 54**. Hand-off occurs normally between the cell boundaries.

In this example, the module is **03**, the port is **14**, and the radio is **2**. The signal strength measured by the base station is **-54** dBm.

4. To end the connection, press **End** or  or close the flap.

Measuring directed RSSI

You may want to measure the RSSI between a portable and a specific base station radio. For example, you may suspect that one of the two radios in a base station is not working properly. You can also use directed RSSI to prevent hand-off while you find a cell edge. To measure the RSSI of a specific radio, you must be in range of two base stations—the one you want to measure and another base station.

You cannot measure the directed RSSI of both radios in the base station at the same time.



Before you begin to measure directed RSSI

Use the *Companion Provisioning Record* to find the following:

- the five-digit ID of the base station radio you want to measure, by mapping the base station location to the time compression multiplex (TCM) port. The first four digits indicate the TCM port to which the base station is connected. The last digit indicates the number of the radio on the base station. For example, the number 03142 on the base station is connected to TCM port 0314, and 2 is the radio number. The number may be printed on a label affixed to the lower right corner of the base station mounting bracket.
- the radio IDs of all other base stations in the same location.

To measure directed RSSI using your portable

1. Repeat steps 1 to 3 of *To measure undirected RSSI on page 84*.
2. When the portable displays the base station ID you want to measure, move out of the cell boundary range so that hand-off occurs, and press or .

3. Press **Line** or .
4. Press  **8^{TUV}** **9^{WXYZ}** **9^{WXYZ}**.
5. Enter the five-digit ID code for the base station radio you want to measure. The portable displays this ID followed by the signal strength, for example **03142 - 54**. Hand-off does not occur as you move between the cell boundaries. The link drops when you move out of range.

In this example, the module is **03**, the port is **14**, and the radio is **2**. The signal strength measured by the base station is **-54** dBm.

6. To end the connection, press **End**,  or close the flap.

Registering the C3020 (Canada only)

The following section describes the procedures involved in registering Companion C3020 portable telephones. To register each portable with the Norstar system, you must do two things:

- Register the portables by entering the Registration password on each one.
- Verify that the portable functions properly.

To register the C3020

1. On the Administration set, turn on registration in a general programming session.
2. On the portable, press **Shift**, then press **Memory**.
3. Press **Office**.
4. Check the portable display.

If the portable has space for another system, the display shows **Office n: Free**.

If the display does not show **Office n: Free.**, follow the procedures in *Deregistering the C3020 (Canada only)* on page 88 to overwrite the system number then return to step 2 of this procedure.

5. Press **(Shift)**, then press **(Memory)**. The display shows **Registering....**
6. Next, enter the Registration password when the display shows **Pswd:**. The default is **(7PRS) (2ABC) (3DEF) (4GHI) (6MNO) (RADIO)**.

If the display does not clear after entering the password, then you may be using the wrong password.

7. Wait for the display to clear. When it shows **DN:**, enter the internal number (637-666) you want to assign to the portable. When the display clears, it shows **Reg'n complete.**
8. On the administration set, turn off registration in general programming, **Companion**, subheading **Registration**.

To confirm that the C3020 is registered

1. To check that the portable has a dial tone, press **(Line)**.

If you hear a dial tone, go to step 2.

If you do not hear a dial tone, check that you have selected the correct system number and press **(Line)** again. If you do not hear dial tone try to register the portable again.

2. Make sure that the flap is closed and the Ringer Control Switch is in the bottom position. Make sure the portable telephone is idle and call forward is not active.

3. On a working telephone, dial the telephone number of the registered portable.
 - If the portable rings, it is functioning properly.
 - If the portable does not ring, try to register the portable again.

If you do not hear a dial tone, or if the portable does not ring, refer to the Troubleshooting section in this guide.

Deregistering the C3020 (Canada only)

You can deregister the C3020 in two steps:

- from the portable
- from the administration set (For more information about using the Norstar administration set, see the *Modular ICS System Coordinator Guide*.)

For example, you may want to deregister the portable before you assign it another number on the same system.

You can also deregister a portable using the administration set. You could use this method if the portable was lost or stolen or if you wanted to assign it to another system. This procedure does not clear registration data from the portable.

If the portable is registered on other systems, it is still available on those systems. You deregister one system at a time.

To deregister the C3020

1. Press **(Shift)**, then press **(Memory)**.
2. Press **(Office)**. The display shows **Office n:**.
3. Press either **(Shift)** then **(#)**, or **(Shift)** then **(*)** until you display the system you want to deregister.

4. Press **(Shift)**, then press **(0)**. The display shows **Deregister?**.
5. Press **(Shift)**, then press **(0)** again. The display shows **Deregistering...** and then **Deregistered**.
6. To continue using the portable, press **(Release)**.

Measuring RSSI for a C3020 (Canada only)

The Receive Signal Strength Indicator (RSSI) is a measurement of the signal strength the base station receives from the portable.

The base station controls the power transmitting mode of the portable.

- When the base station receives a weak signal, it instructs the portable to transmit in high-power.
- When the base station receives a strong signal, it instructs the portable to transmit in low-power.

The strongest RSSI value the portable displays is -44 dBm. The weakest RSSI value the portable displays is approximately -85 to -95 dBm.



Receive Signal Strength Indicator overrides normal display.

You cannot receive calls while measuring Receive Signal Strength Indicator.

Measuring undirected RSSI

You may want to measure the Receive Signal Strength Indicator between a portable and a base station radio.

1. Press **(Line)**. Wait for dial tone.
2. Press **(*)**. Enter the feature code: **(8^{TUV}) (9^{WXY}) (8^{TUV})**.
The display shows the radio ID of the base station to which the portable is linked, followed by the signal strength, for example **03121 - 67**. In this example, the module is 03, the port is 12, and the radio is 1. The signal strength is -67dBm.
3. Read your measurement. Hand-off occurs normally.
4. To end the connection, press **(Release)** or close the flap.

Measuring directed RSSI

You may want to measure the Receive Signal Strength Indicator between a portable and a specific base station radio. For example, you may suspect that a radio in a base station is not working properly. You can also use directed Receive Signal Strength Indicator to prevent hand-off while you find a cell edge. To measure the Receive Signal Strength Indicator of a desired radio, you must be in range of two base stations—the one you want to measure, and another base station.



Receive Signal Strength Indicator applies to one radio in a base station.

You cannot measure the directed Receive Signal Strength Indicator of the other radio in the base station to which you are connected.

Before you begin measuring directed RSSI

Use the *Companion Provisioning Record* to find and note the following:

- the five-digit radio ID of the base station you want to measure, by mapping the base station location to the TCM port. The first four digits indicate the TCM port to which the base station is connected. The last digit indicates the number of the radio on the base station. For example, the number 03122 identifies radio 2 on the base station connected to TCM port 0312.
- the radio IDs of all other base stations in the same location.

Measuring directed RSSI using your portable

1. Perform an undirected Receive Signal Strength Indicator by following steps 1 to 3 in *To measure undirected RSSI on page 84*. To direct the Receive Signal Strength Indicator to the other radio of the base station, move out of range until hand-off occurs before moving on to step 2.
2. Press **(Line)**. Wait for dial tone.
3. Press **(*)** **(8^{TUV})** **(9^{WXY})** **(9^{WXY})**.
4. Enter the five-digit ID code for the base station radio you want to measure. The display shows this ID followed by the signal strength, for example **03121 - 67**. If you have not established a connection with the desired base station radio, you hear a tone when you hold the portable to your ear.
5. Read your measurement. The system drops the link when you move out of range of your base station (no hand-off).
6. To end the connection, press **(Release)**, or close the flap.

After registering the portables

When you have completed programming the system, use the following checklist to ensure you completed the required tasks.

- Register the portables.
- Verify Portable Credits.
- Ensure that you registered all the required portables.
- Verify that all portables are available for use.
- Test each portable to verify it is operating properly.
- Disable Master Registration when you have finished registering the portables.

For the steps involved in operating a Norstar Companion portable, see the *Companion Portable Telephone User Guide* that is supplied with the portable.

When you distribute the portables, tell the users that the portables are registered and give them the corresponding extension numbers.



Tip - *You can register a portable to more than one system. You cannot register a portable to more than one extension number per system. You cannot register more than one portable to one extension number.*

If a portable telephone is used in more than one Norstar or Companion system, the user must know which registration slot number was used to register the portable telephone with each system. It is preferable that each user register the system they use most in slot 1.

If a portable telephone is lost or broken, you can deregister it from the system before replacing it with another portable telephone.

Testing the Companion portable telephones

You must register all portable telephones before testing them. For more detail on registering portable telephones, refer to *Modular ICS Companion System Coordinator Guide* and the Telephone Registration Instructions.

1. Verify that the portable telephone is ON.
2. Establish a connection to get internal dial tone. If no dial tone is present, the portable telephone may not be registered. Try to register the portable telephone again.
3. Verify that the portable telephone is using the correct registration slot.
4. Verify that the portable telephone can make a call.
5. Verify that the portable telephone has been assigned the correct extension number by calling a wired telephone and viewing the line number displayed.

Testing the base stations

1. Verify that the ICS is ON.
2. Verify that re-evaluation is complete.
3. Verify that the base station has been powered up correctly by checking that the green light is ON and the red light is OFF.

If the red light is flashing, it indicates that one of the following problems may exist:

- The base station is not connected to the ICS.
- The base station is faulty and should be replaced.

A solid red light indicates that both radios on the base station are busy, that the ICS is downloading data to the base stations, or that one or both radios have not been assigned to a cell.

4. Using the directed Received Signal Strength Indication (RSSI) feature on a portable telephone verify that you can establish a link with every radio on the system while within the cell range of the radio. Using another portable, establish a second link with the other radio on the same base station and check that the red light is ON while both radios are active.

Testing the system coverage

Using the undirected Received Signal Strength Indication feature on a portable telephone, verify that the base stations are handing off calls and serving the coverage area as intended. To check valid handoff, move from one cell to another. As you do this the radio number shown on the portable telephone display changes.

To test system coverage at critical points, follow these steps:

1. Make a call. Move over the entire coverage area, including stairs, elevators and critical points, while maintaining the call on the portable. You should maintain good quality speech throughout the area you are moving in.
2. Check that you can receive a call while at these critical points. If a significant hole in the coverage area is found and the base stations are working properly according to the above tests, refer to *Companion Site Planning Guide*. You may need to redeploy the base stations or add an additional cell.

Troubleshooting

The following sections describe some basic troubleshooting techniques to try with a malfunctioning portable telephone or base station.

Problems with a portable telephone

1. Verify that the portable is compatible with the software version.
2. Verify that the portable is ON and that the battery is not low, by checking the power indicator on the portable.
3. If no dial tone is present:
 - a. Verify that the dialtone is available from the ICS.
 - b. The portable may not be registered. Try to register the portable refer to the *Modular ICS Companion System Coordinator Guide*.
4. Check that the portable is using the correct registration slot.
5. Verify that the portable has been assigned the correct internal number by calling it from another telephone.

Problems with a base station

1. Verify that the green light is ON.
2. Verify that the red light is not solid.

A solid red light indicates that both radios on the Companion base station are busy, that the ICS is downloading data to the base stations, or that one or both radios have not been assigned to a cell.

3. Verify that the red light is not flashing.

The red light flashes for about 15 seconds when a base station powers up. This is normal. If the red light continues to flash, one of the problems may have occurred:

- The ICS or Station Module is not ON.
 - The base station is not connected to the ICS or Station Module.
 - The wiring to the base station is not correct.
 - The TCM wiring length between the base station and the ICS or Station Module exceeds 1200 m.
 - There is a faulty ICS, Station Module, or RPI.
 - The two-way DC loop resistance of the power pairs between the Remote Power Interconnect (RPI) and the base station exceeds 75 ohms. Measure the loop resistance with an ohmmeter. If the resistance exceeds 75 ohms, install a second power pair, or power the base station with a plug-top power supply.
 - The base station is faulty.
4. Verify that the power cord of the RPI is properly connected to a working AC outlet. If the base station is powered locally, verify that the power supply is properly connected to a working AC outlet and that the power supply cable is properly connected to the base station power connector
5. If an external antenna is installed, verify that the external antenna coaxial cable is properly connected to the BNC connector of the base station and that the corresponding radio is programmed to have an external antenna (see *Installing external antenna and lightning surge arrestor procedures for the United States of America* on page 37).

Note: Ensure there are not any bridge taps on the TCM.

Replacing a base station

To replace a base station, you do not have to power down the ICS. When you replace a base station, no portable registration information is lost. After a short boot sequence, the base station should be functioning normally.

To replace a base station, follow these steps:

1. If the base station is powered locally, unplug the power supply from the AC outlet and unplug the power supply connector from the base station
2. Remove the cover from the base station mounting bracket.
3. If an external antenna is installed, unplug its coaxial cable from the base station.
4. Unplug the teledapt cable from the base station.
5. While holding the base station, to prevent it from falling, apply upward pressure to the base station.
6. Lift the base station away from the bracket.
7. Carefully install the new base station onto the bracket.
8. Gently press down to snap it into position.
9. Reconnect the teledapt cable to the base station connector.
10. Reconnect the power supply connector and external antenna coaxial cable to the connectors from which they were removed.
11. If the base station is powered locally, plug the power supply into the AC outlet.

The red light on each base station will flash for about 15 seconds while powering up. This is normal.

Verifying Radio Credits (U.S. only)

You need the programming template found at the front of the *Modular ICS System Coordinator Guide*.

1. Press
().
2. Press (the default Installer password).
3. Press until you reach **System Prgrming**.
4. Press once.
5. Press until you see **Companion**.
6. Press . The display shows **Registration**.
7. Press until the display shows **Radio credits**.
8. Press once. The display shows **nnn Available**. Press and the display shows **nnn Total**. Verify that the total number of Radio Credits is enough to support the system you have just installed.

Note: The number of Radio Credits must be double the number of base stations you have installed. Each base station has two radios so each base station requires two credits.

Note: As each base station is initialized the number of available Radio Credits will decrease accordingly.

Problems with an RPI

To troubleshoot an RPI, follow these steps:

1. Verify that the RPI is plugged into a working AC outlet.
2. Verify that all the connections to the RPI, including the power cord, jumper lead, input and output, and so on, are correct and secured.
3. Verify the power supply:
 - Verify the power cord fuse.
 - Verify the green internal RPI light is on.
 - Verify the base station green light is on.
 - Verify that the red light is not solid. A solid red light indicates that both radios on the base station are busy, that the ICS is downloading data into the base stations, or that one or both radios have not been assigned to a cell.
 - Verify that the red light is not flashing. The red light flashes for about 15 seconds when a base station is powered up. This is normal.
4. If none of the base stations connected to the RPI, or to one of its power supply units, is functioning correctly, replace the RPI or power supply unit.



Tip - *The left power supply unit provides power through output connectors OK1 to OK8 or OBIX1 to OBIX8, and the right power supply unit provides power through OK9 to OK16 or OBIX9 to OBIX16.*

If only one or a few of the base stations seem faulty, Problems with a base station on page 95.

Problems with wireless communication



(U.S. only) If you are relocating a base station, call the Nortel Networks Customer Response Center at **1-800-321-2649** to verify that you have approval from UTAM Inc. Please have your System ID number ready when you call.

Taking a base station out of service causes radio coverage to degrade.

Obtaining a Recovery Key

A disabled Norstar Companion system implies that base stations and portables are not operational. UTAM registering information is, however, retained.

To reactivate Norstar Companion communication on a disabled system, you require a UTAM Recovery Key. To obtain and enter the Recovery Key, follow the procedures for the UTAM Activation Key explained in *Software keys (U.S. only)* on page 67.

Obtaining a Regression Key (U.S. only)

You may need a Regression Key if one of the following conditions occurs:

- a defective ICS is replaced
- an ICS has lost its System Identification Number (SysID) due to a power outage for more than 72 hours

If you need a Regression Key, follow these steps:

1. Record the new System Identification Number once the system is powered up. See *Step 2: Obtain the System Identification Number* on page 69 for more information.
2. Locate the following information in the *MICS-XC Programming Record*.
 - the original SysID
 - all previously entered radio and portable credit keys
3. Call Nortel Networks Customer Response Center at **1-800-321-2649** to request a Regression Key.
4. Provide them with the original and new SysID, Companion ID, customer address and zip code. See *Software keys (U.S. only)* on page 67.
5. Make a note of the new Regression Key.

A Regression Key cannot be reused. Please do not record this Key in the *Programming Record*.

6. Enter the Regression Key. Follow the same procedure for entering software keys on page 69.

Once the keys have been entered, the previous SysID is restored.

7. Re-enter all radio and portable credit keys recorded in *Programming Record*.
8. Verify that the correct number of Radio Credits is available. Refer to *Verifying Radio Credits (U.S. only)* on page 98.
9. Re-enter all programming data using information from the *Programming Record*.
10. Reregister all portables.

Alarm codes

For a complete list of Norstar alarms, consult the *Norstar Alarm & Event Code Manual*. Also consult the *Modular ICS Installer Guide*.

Displays

Example display	Meaning	Possible causes and actions
Alarm: 21	Wireless re-evaluation in progress	Scheduled or required re-evaluation of wireless base stations in system
Alarm: 22	Wireless re-evaluation complete	Scheduled or required re-evaluation of wireless base stations in system
Alarm: 53	A single radio has been removed from service due to an error. An accompanying event message indicates an explicit reason for the radio failure.	
Alarm: 54	A software download to the base stations has started.	
Alarm: 55	The base station download is complete.	
Alarm: 68	An upgrade has been performed.	A trunk or station module has been added to a system to which base stations are already connected. The base stations must be moved to the highest numbered ports on the system.
Alarm: 200	Insufficient radio credits	
Alarm: 201	Radio credits decreased	
Alarm: 202	UTAM key required	(U.S. only) Valid UTAM Activation Key required. <i>Radio data</i> on page 62

Example display	Meaning	Possible causes and actions
Alarm:203	UTAM test failed	(U.S. only) System detected an incorrect configuration, possibly due to malfunctioning equipment.
Alarm:204	Evaluation override is finished	
Alarm:205	Disablement test active	
Alarm:206	Disablement test is finished	
Alarm:207	System startup	System initialization is beginning
Alarm:208	System online	System initialization is finished
Alarm:209	Demo system	
Re-Eval required	System Re-evaluation required	<p>This message occurs when a new base station is added to the system or is moved to a different port.</p> <p>Run System Reevaluation immediately or schedule a System Reevaluation. See <i>Re-evaluation</i> on page 62.</p>
Re-Eval recommended	System Re-evaluation recommended	<p>base station may have lost power for longer than 3 minutes or was replaced with a new base station.</p> <p>You may</p> <ul style="list-style-type: none"> - run System Reevaluation immediately - schedule System Reevaluation or - <u>CANCEL</u> to disregard message <p>See <i>Re-evaluation</i> on page 62.</p>

Example display	Meaning	Possible causes and actions
UTAM key read	System disabled	<p>Common message for a new installation, see <i>Software keys (U.S. only)</i> on page 67. The only other time this alarm should appear is if you are rebuilding a system:</p> <ol style="list-style-type: none"> 1. Enter a UTAM Activation Key. See <i>Software keys (U.S. only)</i> on page 67. 2. Obtain a Regression Key. See <i>Obtaining a Regression Key (U.S. only)</i> on page 100.
UTAM test failed	System is disabled. This alarm appears only after a restart	<ul style="list-style-type: none"> - Ensure there is power to the base stations and RPI or plug-top power supply - Ensure that the location and number of base stations is correct - Ensure that there are at least four terminals and base stations - Ensure that there are sufficient Radio Credits to support the number of base stations you have connected - Restart the system with the correct system configuration. -The system may require a UTAM Recovery Key. See <i>Obtaining a Recovery Key</i> on page 100.

Example display	Meaning	Possible causes and actions
Radio cred read	Too many base stations have been connected to the system. This message appears only after a restart.	<p>Too many base stations have been connected and the total available Radio Credits are insufficient to accommodate all the radios. Wireless communication remains disabled. System Reevaluation may be disabled.</p> <ol style="list-style-type: none"> 1. Verify the total and available number of radio credits. See <i>Verifying Radio Credits (U.S. only)</i> on page 98. 2. Remove the excess base stations and restart the system. To determine the number of connected base stations to remove, subtract the total number of radio credits from the total number of connected base stations. Remember that each base station has two radios. See <i>Problems with an RPI</i> on page 99. If you have increased the number of base stations you may need a new UTAM Activation Key to cover the increase in Radios. See <i>Software keys (U.S. only)</i> on page 67. If Radio Credits are required then reevaluation is disabled. See <i>Re-evaluation</i> on page 62.

Event messages

Event message display	Cause
Evt:275-3546 58	(U.S. only) Unable to activate all registered portables. The system ran out of portable credits. One event is generated per portable that failed to activate. The repetition of the corresponding alarm code 59 indicates how many additional credits must be purchased.
Evt:301-1031 55	The base station (on port 0103 in this case) cannot successfully receive the data image. Both radios belonging to the base station are disabled. This may occur if the flash EEPROM is faulty. Two events are raised: one for the B1 channel radio (as in this case) and another for the B2 channel radio. A corresponding alarm code 53 occurs.
Evt:302-1031 55	The base station (on port 0103 in this case) cannot be written to during data transfer. Both radios belonging to the base station are disabled. The base station flash EEPROM is faulty. Two events are raised: one for the B1 channel radio (as in this case) and another for the B2 channel radio. A corresponding alarm code 53 occurs.
Evt:303-1031 5	The base station (on port 0103 in this case) cannot be synchronized with the other base stations in the system. Both radios belonging to the base station are disabled. The base station hardware is faulty. Two events are raised: one for the B1 channel radio (as in this case) and another for the B2 channel radio. A corresponding alarm code 53 occurs.
Evt:304-1032	A B2 channel radio (radio 2 on port 0103 in this case) cannot be synchronized with other radios because of system overload.

Event message display	Cause
Evt:305-01032 S5	<p>A B2 channel radio (radio 2 on port 0103 in this case) cannot be synchronized because the B1 radio was disabled in maintenance.</p> <p>Both radios belonging to the base station (on port 0103 in this case) are disabled. The B1 radio must be operational to synchronize both radios of the base station with other radios in the system. Two events are raised: one for the B1 channel radio and another for the B2 channel radio. A corresponding alarm code 53 occurs.</p>
Evt:306-01031 S5	<p>A radio (0103-1 in this case) cannot be synchronized because there are no B2 channel radios.</p> <p>Both radios belonging to the base station (on port 0103 in this case) are disabled. Two events are raised: one for the B1 channel radio in this case) and another for the B2 channel radio. A corresponding alarm code 53 occurs.</p>
Evt:307-0109100 S5	<p>A recoverable RIM fault has occurred</p> <p>The RIM is reset. If a link is active when this error occurs, the link is dropped. The radio (0109-1 in this case) is returned to service.</p>
Evt:307-0109101 S5	<p>An unrecoverable RIM fault has occurred</p> <p>The radio (0109-1 in this case) is disabled and taken out of service. If a link is active when this error occurs, the link is dropped. A corresponding alarm code 53 occurs.</p>
Evt:307-0109102 S5	<p>The built-in self-test on the base station has failed</p> <p>The radio (0109-1 in this case) is disabled and taken out of service. If a link is active when this error occurs, the link is dropped. A corresponding alarm code 53 occurs.</p>
Evt:308-0103 S5	<p>The base station is connected to a system that supports a radio protocol that the ICS does not understand.</p>

Event message display		Cause
Evt:664	58	There is a bad signature.
Evt:665	54	(U.S. only) there are insufficient radio credits.
Evt:666	55	(U.S. only) radio credits decreased.
Evt:667	55	(U.S. only) UTAM keys are required.
Evt:668	55	(U.S. only) UTAM test failed.
Evt:669	55	Evaluation override is finished.
Evt:670	55	Disablement test is active.
Evt:671	55	Disablement test is finished.
Evt:672	55	System initialization is beginning.
Evt:673	55	System initialization is finished.
Evt:675	55	Demo system.
Evt:831	55	Software error dealing with base station.
Evt:832	55	System problem with locating portable telephones.

Event message display		Cause
Evt:833	S5	The radio driver software which directly controls the base stations' device has experienced an internal error.
Evt:834	S5	System problem with locating portable telephones.
Evt:835	S5	Wireless system access error.
Evt:836	S5	Wireless system access error.
Evt:837	S5	Trying to register an incompatible wireless device.
Evt:840	S5	Wireless system software error in dealing with a portable telephone.
Evt:841	S5	Wireless system software error.
Evt:842	S5	Portable does not support specific display character.
Evt:843	S5	Internal radio driver error.
Evt:848	S5	A cell manager has been unable to register with the router.
Evt:849	S5	Synchronization error.
Evt:850	S5	Synchronization error.
Evt:851	S5	Base station software error.

Event message display	Cause
Evt:852 55	The Data Transfer server has been told by the base station that an error has occurred.
Evt:853 55	The Data Transfer server has been told by the base station that an error has occurred.
Evt:854 55	Invalid event for Data Transfer.
Evt:855 55	Internal wireless subsystem software error.
Evt:856 55	Internal wireless subsystem locator error.
Evt:859 55	All possible wireless telephone numbers have been registered to portable telephones. No directory number is available to handle the registration Link setup request.
Evt:864 55	A base station has received a corrupted stimulus message.
Evt:865 55	The base station does not understand the received stimulus message. This occurs when you are trying to use a type of portable that the system does not support.
Evt:869 55	Wireless subsystem language loading error.
Evt:870 55	Firmware downloading to base station.
Evt:871 55	Base station download is complete.
Evt:872 55	Wireless subsystem error.

Event message display	Cause
Evt:873 S5	Wireless subsystem Common Signaling Channel server software error.
Evt:877 S5	Wireless auto-admin (Re-Eval) subsystem detected that a data re-evaluation is required.
Evt:878 S5	Wireless data re-evaluation has started.
Evt:879 S5	Wireless data re-evaluation has completed.
Evt:881 S5	Wireless auto-admin (Re-Eval) indicating that a configured cell failed to come on-line. Alarm 23 displays cell that failed.
Evt:884 S5	The Wireless auto-admin (Re-Eval) subsystem has detected an error.
Evt:885 S5	Sequencer functionality has detected an error.
Evt:886 S5	The Wireless auto-admin (Re-Eval) Initial Intelligence component has detected an error.
Evt:887 S5	The Wireless auto-admin (Re-Eval) radio Sniffing component has detected an error.
Evt:888 S5	The Wireless auto-admin (Re-Eval) Radio Manager has detected an error.

Specifications

This chapter provides the specifications for Companion equipment.

Norstar Companion system components

Remote Power Interconnect

The Remote Power Interconnect (RPI) device power lines are protected by 3 A, 250 V anti-surge fuses. Each output has short-circuit protection. The length of the cord, from the outside surface of the unit to the plug, should be a minimum of 1.4 m (4.5 ft.) and a maximum of 4.2 m (15 ft.).

Part no.	RPI-8: NTE023AA (A0667940) RPI-16: NTE024AA (A0667941)
Color	Dolphin Gray
Height	35.6 cm (14 in.)
Width	30.5 cm (12 in.)
Depth	7.6 cm (3 in.)
Input voltage	80 to 270 V AC
Input frequency	40 to 70 Hz
Output voltage	48 V DC
Output current	1.1 A
Operating temperature	0°C to 50°C (32°F to 122°F)

Base station

The base station consists of two printed circuit boards: the Line Interface Module (LIM) and the Dual Radio Interface Module (RIM). The base station provides connectors for a terminating line cord, external antennas, and a power supply cord. Only passive antennas may be connected to the antenna sockets on the base station.

Base station

Part no.	NTAE20AA (A0401506 in the US) NT0P30DA-93 (A0403378 in Canada)
Color	Dolphin Gray
Height	20 cm (8 in.)
Width	32 cm (12 in.)
Depth	5 cm (2 in.)
Weight	less than 1 kg (less than 2 lbs)
Input voltage	12 to 50 V DC
Maximum loop length (TCM)	1200 m (4,000 ft.)
Operating temperature	5°C to 40°C (+32°F to +120°F)
Relative humidity	5 to 85% (condensation may occur)
Peak power rating	15 dBm (US) 10 dbm (Canada)

If a plug-top power supply is required, use only the power supply recommended for use with the base station. Other usage invalidates any approval given to this apparatus.

Base station plug-top power supply

Part no.	A0386334
Color	Dolphin Gray
AC supply voltage	120 V
AC supply frequency	60 Hz
Secondary voltage	12 V
Secondary current	800 mA
Operating temperature	5°C to 40°C (+32°F to +120°F)
Relative humidity	5 to 85% (condensation may occur)
Height	10 cm (4 in.)
Width	10 cm (4 in.)
Depth	6 cm (2 in.)

External antenna assembly (For the US)

Part no.	antenna: NTAE50AA (A0637293)
Frequency range	1.92 to 1.93 GHz
Peak power rating	+13.5 dBm
Peak antenna gain	between -1.2 and 1.5 dBi
Polarization	nominally vertical
Input impedance	50 Ω nominal
Voltage standing wave ratio	better than 1.5:1
Extension cable loss	below 4.5 dB
Lightning surge arrestor circuit current	3 kA
Lightning surge arrestor waveform pulse	$8_{/20}$ μ S
Lightning surge arrestor repetition	20 times

Outdoor omni-directional antenna (For Canada)

Part no.	A0383818
Frequency range	944 to 952 MHz
Peak power rating	10 mW minimum
Peak antenna gain	4 dBi maximum
Polarization	vertical
Input impedance	50 Ω nominal
Temperature	-50 °C to +55 °C
Humidity	0% to 100%
Length	49.0 cm maximum
Width	3.5 cm maximum
Weight	1.0 kg maximum

Indoor omni-directional antenna (For Canada)

Part no.	A0383447
Frequency range	944 to 952 MHz
Peak power rating	10 mW minimum
Peak antenna gain	2.5 dBi maximum
Polarization	vertical
Input impedance	50 Ω nominal
Temperature	-18 °C to +55 °C
Humidity	5% to 95%
Length	21.0 cm maximum
Width	3.0 cm maximum
Weight	0.25 kg maximum

Indoor directional antenna (For Canada)

Part no.	A0383817
Frequency range	944 to 952 MHz
Peak power rating	10 mW minimum
Peak antenna gain	5 dBi maximum
Polarization	vertical
Input impedance	50 Ω nominal
Temperature	-18 °C to +55 °C
Humidity	5% to 95%
Length	21.0 cm maximum
Width	8.0 cm maximum
Depth	13.0 cm maximum
Weight	0.5 kg maximum

Lightning surge protector (For Canada)

Part no.	A0382082
Surge capability	50 000 A (repeatable)
Turn-on threshold	600 V dc
Turn-on time	2.5 ns
Impedance	50 ohms
Operating frequency range	125 MHz to 1 GHz

Upgrading your system

Adding Companion to a mini, midi, maxi, or mega system

On a mini system (non-expanded), only module 1 (ports 101 to 132) can be used for Companion base stations and/or wireline sets. Module 2 is used for trunk modules only.

On a midi system (2- port expansion) ensure that Station Modules 3, or 4, or both are available to connect Norstar sets or base stations. base stations cannot be connected to any other module.

On a maxi system (6-port expansion), ensure that the Station Modules 7, or 8, or both are available to connect Norstar sets or base stations. Base stations cannot be connected to any other module.

Upgrading an RPI-8 to an RPI-16



Only distributors and authorized service personnel are permitted to upgrade an RPI-8.



Do not power up the RPI until the installation is complete. This includes the installation of base station cross-connectors.

If you are adding extra lines for base stations, always power down the RPI before you begin.

To upgrade an RPI-8 to an RPI-16

1. Power down the RPI.
2. Unscrew the grounding straps and plates.
3. Add the second power supply unit (A0385554, NPS 50376L106) and screw down the grounding straps, the grounding plates, and the power supply unit.
4. Plug the output of the power supply unit into the connector board.
5. Connect the jumper lead from PSU 1 to the lead from PSU 2, as shown in *RPI connections*.
6. Power up the RPI.

RPI connections

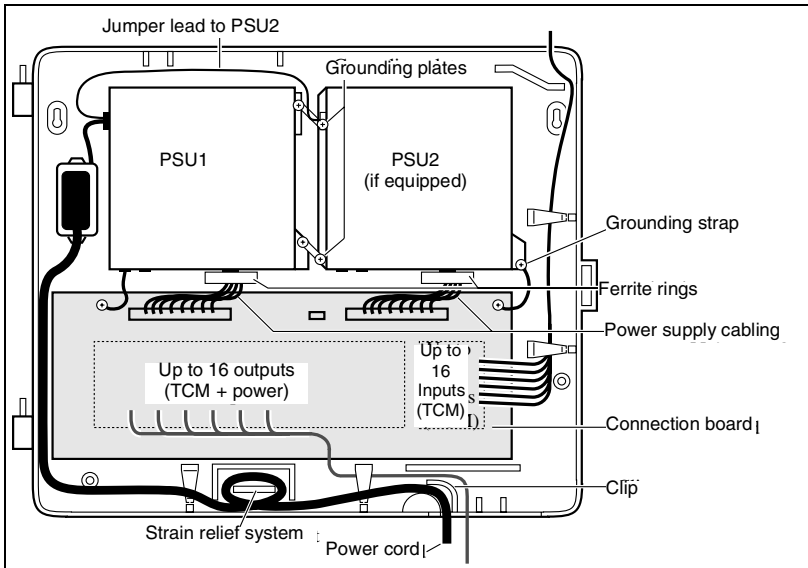

Glossary

A

alarm code: A number that appears on the alarm telephone's display, informing you that the ICS has detected a fault in the system.

Analog Terminal Adapter (ATA): A device that permits the connection of analog telecommunication devices such as fax machines, answering machines, and single line telephones to the Norstar system. Programmed defaults for the ATA are automatically assigned by the Norstar system.

Answer button: A telephone button with an indicator that is used to monitor another telephone. The answer button indicates incoming calls destined for the other telephone. Someone working at a telephone with answer buttons (an attendant, for example) can receive all ringing and visual indication of incoming calls for other telephones, and answer those calls when necessary.

One telephone can have up to four Answer buttons. An Answer button is automatically assigned to a telephone when that telephone is assigned an Answer DN.

Answer DN: The internal or directory number (DN) of a telephone that is monitored by an

Answer button. You can assign up to four Answer DNs to a telephone under Line Access in Terminals and Sets programming.

antenna: A built-in antenna inside each base station. External antennas can also be used to extend radio coverage to hard-to-reach places such as tunnels or stairwells.

Antenna type: A programming setting that lets you select the type of antenna used for each base station radio in your Norstar Companion system. Settings are Internal and External.

B

Base station: A Companion component that is mounted on walls and ceilings to provide a radio link to an office or other area where Companion portable telephones are used. Each base station houses two radios that allow portables to send and receive calls through the ICS. See also UTAM Inc.

C

Call Forward: A feature that forwards all the calls arriving at your telephone to another telephone in your Norstar system. You can also forward calls from your Norstar Companion portable. To have calls

forwarded outside the system, use Line Redirection.

Call Transfer: See Transfer.

Cell: The area covered by one or more radios in close proximity within a Norstar Companion system. Calls on portable telephones are passed from one cell to another as the user moves around the office.

Cell assignment: A heading in programming that lets you determine whether a cell has radios, any neighboring cells, or any neighboring radios.

Cell neighbor: A cell that physically adjoins another cell.

Combo Cartridge: A cartridge that allows you to connect Trunk Modules and Station Modules to the ICS to expand the system's capacity for trunks and telephones. Combo Cartridges provide six-port or 12-port expansion and Services functionality with each cartridge. (See also Expansion Cartridge.)

Companion: The name for Northern Telecom communication systems which use radio technology to transmit and receive signals between its components and the Norstar system.

Companion Wireless provides mobility in the workplace. Calls that used to ring just at your Norstar set

can also appear and ring at your portable.

Companion ID: An eight character (alphanumeric) number assigned by Northern Telecom to identify each Companion wireless system. This Companion ID is sent to each customer once radio or portable credits have been purchased. The Companion ID must be provided each time keys or credits are obtained using the Nortel Customer response center.

Companion portable telephone: Hand-held wireless sets which allow complete mobility within the reach of Companion base stations or an external antenna. Portables offer many but not all Norstar features and share much of the same programming as "wired" desk sets.

Conference: The Conference feature allows you to establish a three-person call at your Norstar telephone. It can also be used on your Norstar Companion portable.

credits: See Portable Credits.

D

defaults: The settings for all Norstar features when the system is first installed. Settings are changed from their defaults in programming. In this manual, default settings are shown in **bold** text.

destination code: A two- to seven-digit number that the system interprets and then translates into the digits that you want dialed out. Both the code and its associated dialed digits are assigned under Routing service in Services programming.

Directed Receive Signal Strength Indicator: A measurement of the signal strength between a portable and a specific base station radio. You require the 5-digit ID of the base station radio that you want to measure.

See also Receive Signal Strength Indicator.

Directory number (DN): A unique number that is automatically assigned to each telephone or data terminal. The DN, also referred to as an internal number, is often used to identify a telephone when settings are assigned during programming. Default DN assignments start at 221.

DN: See Directory number.

E

event message: Event messages are stored in the system log and displayed during a Maintenance session. They record a variety of events and activities in the Norstar system.

Expansion Cartridge: A cartridge that allows you to connect Trunk Modules and Station Modules to the ICS to expand the system's capacity for trunks and telephones. There are two Expansion Cartridges: a two-port Expansion Cartridge and a six-port Expansion Cartridge. (See also Combo Cartridge.)

External paging: A feature you can use to make voice announcements over an externally-mounted loudspeaker connected to the Integrated Communication System. The external speaker is not a Norstar component and must be supplied by the customer.

H

Handoff: An activity of Companion wireless components. Handoff is when the system "finds" a new cell to maintain the link between a portable telephone and the ICS.

I

ICS (integrated communication system): The central hardware component in the Norstar system. The ICS has its own processor and memory, and provides a physical point of connection for the various types of devices, telephones, and expansion modules used in Norstar.

The ICS can function on its own as a basic system (with 32 Norstar telephones and up to 48 external lines), or with the addition of Trunk

Modules (TM) that supports more external lines, or Station Modules (SM) that support more Norstar telephones.

incoming line group (ILG): A group of lines used for incoming calls. Incoming line groups provide telephone access to several incoming lines without taking up many line buttons. A line is assigned to be part of an incoming line group in Installer programming.

Installer password: A one-to six-digit password that prevents unauthorized access to Installer-oriented programming. The Installer password can be assigned and changed in Passwords programming.

Integrated Services Digital Network (ISDN): A digital telephone service that allows for a combination voice and data connection over a single, high-speed connection. ISDN service can operate over the same copper twisted-pair telephone line as analog telephone service.

Intercom button: A button that provides access to internal lines used for calls within a Norstar system and access to external lines through a line pool or external code. A telephone may be assigned zero to eight Intercom buttons. This is done during an Installer programming session.

Intercom keys: See Intercom button.

K

Key Service Unit (KSU): Please see Integrated Communication System (ICS).

L

Line Pool:

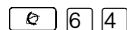

A group of lines used for making external calls. Line pools provide an efficient way of giving a telephone access to external lines without taking up many line buttons. A line is assigned to be part of a line pool in an Installer programming session.

M

M7310 telephone: A telephone that has a two-line display, three display buttons, 10 programmable memory buttons with indicators, and 12 dual memory programmable buttons without indicators. An M7310 can be equipped with a Busy Lamp Field.

M7324 telephone: A telephone with a two-line display, three display buttons, and 24 programmable memory buttons with indicators. An M7324 telephone can be equipped with a CAP module.

Module: A component of the Norstar key system. Includes the

Integrated Communication System, Trunk Module and Station Module.

O

OPS: Off premise station.

OPX: Off premise extension.

overlay: See Programming overlay.

P

Passwords: A programming section that lets you assign or change COS passwords, Call log passwords, or any of the programming passwords. Once you access the Passwords section, you can only modify the passwords for your level of programming.

Portable Credits (U.S. only):

Predefine the maximum number of portables that can be registered to the system. Systems can only register as many portables as there are available Portable Credits. To register additional portables, you must obtain Portable Credit Keys for the number of additional portables you need. You can obtain additional keys whenever you need to expand the number of portables, up to a maximum of 60 portables for each XC 2.0 system.

portable telephone: See Companion portable telephone.

Prime line: The line on your telephone that is automatically

selected when you lift the receiver, press the Handsfree/Mute button or use an external dialing feature.

A Prime Line is assigned to a telephone during Installer programming.

Private line: See Private to.

Private to: A line can be assigned, during Installer programming, to one telephone as a private line. The line cannot appear on any other telephone, except the prime telephone for that line. Private lines cannot be placed into line pools.

programming: Setting the way the Norstar system will work. Programming includes system-wide settings and individual telephone and line settings.

programming overlay: A paper template that is placed over the top four memory buttons with indicators on the M7310 or M7324 telephone during programming. The overlay labels indicate the special function that each of the four buttons takes on during programming. The overlay is found at the back of the Norstar Companion Installer Guide or System Coordinator Guide.

R

Radio Credits (U.S. only): The XC 2.0 system recognizes base stations as *Radio credits*. The number of Radio Credits licenced to the

system is embedded in the UTAM Activation Key. Two radio credits are needed for each base station.

Radio Data: The section of Companion programming that contains all the headings to set up cells and radios in your Norstar Companion system.

Receive Signal Strength Indicator (RSSI): A measurement of the signal strength that the base station receives from a particular portable. The strongest value is about -35 dBm; the weakest value is approximately -94 to -100 dBm.

Recovery Key (U.S. only): See UTAM Recovery Key.

Reevaluation: A heading under radio data that lets you re-assign the proper cell configuration to each radio in a base station. Use it when you've added or removed base stations in your Norstar Companion system.

Registration: The procedure for assigning an extension on the Norstar system to a Companion portable telephone. Registration is controlled using System Coordinator programming and performed "over the air" using the portable itself.

Registration password: a password that prevents unauthorized users from registering portables on the Norstar Companion system.

Regression Key (U.S. only): Restores the previous system security number so that previously applied UTAM Activation Keys and Portable Credit Keys can be reentered to restore full system operation. Also required in cases of system recovery. This key cannot be reused.

Remote access: The ability to dial into a Norstar system from outside the system and make use of selected Norstar features. The lines, features, and dialing capabilities available to a remote user are determined by the Class of Service.

If the remote access line is answered with DISA, the user must enter a Class of Service password to gain access to the Norstar system's features.

Remote paging: This feature allows remote users to use the Norstar paging feature. Access to this feature is governed by the Class of Service for the call. See Remote Access and Class of Service.

Remote Power Interconnect (RPI) device: An interface providing remote power for the base stations. Each RPI can power up to 8 or 16 base stations.

Routing: See Routing Service.

Routing service: A programming section that allows outgoing calls to be directed automatically based on

the numbers a caller dials. For Norstar systems linked in a network, routing can create a transparent or coordinated dialing plan. It can also be used to direct calls to the least expensive lines according to a Services schedule (sometimes called least cost routing).

Roaming: Roaming is the ability of a portable telephone to make and receive calls anywhere within the coverage area of a Norstar Companion system.

RSSI: See Receive Signal Strength Indicator.

S

Software Keys (U.S. only): Keys and credits administered by UTAM Inc. to control user capacity and to ensure system location verification for unlicensed, personal wireless communication devices. They must be obtained and entered into your Norstar Companion system in order to activate wireless capability.

See also UTAM Inc.



Station Module: A module that allows you to connect up to 16 additional telephones to your Norstar system.

System Coordinator password: A one- to six-digit password that prevents unauthorized access to system programming. The system coordinator password can be

assigned and changed in programming.

System Logical Identifier (LID): a 4-digit number by which the system identifies itself to portable telephones and which the portable telephones use to request service from the system. Only the Installer can change the System LID.

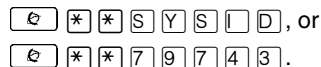
System ID: The System ID (or System Security number) can be accessed on any M7324 or M7310 telephone display by pressing

, or
.

The number is required in order to obtain the keys that will activate your Norstar Companion system's wireless capability.

See also Software Keys.

T

M7316 Business Series Terminal: A telephone that has a two-line display, three display buttons, 10 programmable memory buttons with indicators, and 12 memory programmable buttons without indicators. This set can be used to as a programming set for the system installer.

Target lines: Lines used to answer incoming calls only. A target line routes a call according to digits it receives from an incoming trunk.

They are referred to by line numbers in the same way as physical lines.

Transfer: A feature that lets you redirect a call to another telephone in your Norstar system, over a network or outside your Norstar system. It also works with a Norstar Companion portable.

Trunk Module: A module that allows you to install additional Trunk Cartridges in your system to provide up to 12 additional trunks.

Twinning: With the XC 2.0 system, the ability of users who have both a wireline (desk) telephone and Companion portable telephone to answer calls from either device. Twinning is made possible either through assigning Answer DN's or configuring target lines.

U

Undirected Receive Signal Strength Indicator:

A measurement of the signal strength between a portable and the base station radio that the portable is currently linked to.

See also Receive Signal Strength Indicator.

UTAM Activation Key (U.S. only): Activates the wireless capability on a new system and in system upgrades involving a change to the number of base stations supported.

UTAM Inc. (U.S. only): The Federal Communications Commission (FCC) has appointed UTAM Inc. as the body responsible for coordinating and verifying the installation or relocation of personal wireless communication devices operating between 1.92 GHz and 1.93 GHz. This allows UTAM Inc. to monitor and control the level of wireless activity within this band for a specified geographical location.

UTAM Recovery Key (U.S. only): Reactivates a Companion wireless system that has been disabled and restores the Companion system to its previous radio credit capacity. See the troubleshooting chapter.

W

wireless: See Companion.

Index

A

activating

- disabled system 1, 68
- wireless communication 1, 68, 101

activation key (see UTAM)

alarm code

- Alarm 200 102
- Alarm 201 102
- Alarm 202 102
- Alarm 203 103
- Alarm 204 103
- Alarm 205 103
- Alarm 206 103
- Alarm 207 103
- Alarm 208 103
- Alarm 209 103
- Alarm 21 102
- Alarm 22 102
- Alarm 53 102
- Alarm 54 102
- Alarm 55 102
- Alarm 68 102
- Radio cred read 105
- Re-Eval recommended 103
- Re-Eval required 103
- UTAM key read 104
- UTAM test failed 104

antenna

- co-axial cable length 43, 44, 48
- indoor directional external antenna 42
- indoor omni-directional external antenna 43
- installation 35–41

- installation restrictions 41
- lightning surge protector 41
- outdoor omni-directional external antenna 45
- type, selecting 64

B

backup power 18

Base Station

- signal strength (see Receive Signal Strength Indicator)

base station

- configuring 9, 11, 71
- connecting to ICS 7
- connecting to Station Module 7
- DC loop resistance 96
- disabling 97
- display messages
 - UTAM code read 49
 - UTAM test failed 49
- installation planning 18, 30
- installation, connecting to ICS 10–12
- mounting 31–33
- planning locations 7
- plug-top power supply 114
- port allocation 18
- port numbering 14–15
- positioning 30–31
- power up 49
- radio credits 30
- red light 94
- replacing 97
- site planning 30
- specifications 113, 114
- termination board 32

- testing 93
- troubleshooting 95–96
- updating software for 49
- using in US 4
- UTAM recognition of 30
- wiring length
 - power pair(s) 22
 - TCM lines 96

C

- C3050 portables
 - deregistration 83
 - registration 80–82
- cells (see Companion, cells)
- clearance, RPI 20
- Companion
 - antenna 64
 - base stations 3, 30
 - cells, programming
 - cell nghbrs 65
 - cell rad nghbr 66
 - cell radios 65
 - cells, assignment 64
 - coverage area 3
 - Diagnostic Software 4
 - ID 68
 - portable telephone (see portable telephone)
 - programming 51–72
 - Provisioning Record 30
 - re-evaluation
 - scheduled 63
 - status 63
 - registration 60–63
 - system logical identifier 66
 - wireless
 - on a maxi system 9, 10
 - on a mega system 11
 - on a midi system 9
 - on a mini system 9

- conducted emissions 1
- connecting expansion modules
 - 10, 11, 13

D

- default
 - password 54
 - Startup 53
 - template, changing 56
- deregistration
 - C3050 portables 83
- diagnostics, running on remote system 4
- disabled system, activating 68

E

- equipment and supplies
 - installation checklist 7
- event message
 - Evt 275-3546 S8 106
 - Evt 301-1031 S5 106
 - Evt 302-1031 S5 106
 - Evt 303-1031 S5 106
 - Evt 304-01032 106
 - Evt 305-01032 S5 107
 - Evt 306-01031 S5 107
 - Evt 307-0109100 S5 107
 - Evt 307-0109101 S5 107
 - Evt 307-0109102 S5 107
 - Evt 308-0103 S8 107
 - Evt 664 S8 108
 - Evt 665 S4 108
 - Evt 666 S5 108
 - Evt 667 S5 108
 - Evt 668 S5 108
 - Evt 669 S5 108
 - Evt 670 S5 108
 - Evt 671 S5 108
 - Evt 672 S5 108

Evt 673 55 108
Evt 675 55 108
Evt 831 55 108
Evt 832 55 108
Evt 833 55 109
Evt 834 55 109
Evt 835 55 109
Evt 836 55 109
Evt 837 55 109
Evt 840 55 109
Evt 841 55 109
Evt 842 55 109
Evt 843 55 109
Evt 848 55 109
Evt 849 55 109
Evt 850 55 109
Evt 851 55 109
Evt 852 55 110
Evt 853 55 110
Evt 854 55 110
Evt 855 55 110
Evt 856 55 110
Evt 859 55 110
Evt 864 55 110
Evt 865 55 110
Evt 869 55 110
Evt 870 55 110
Evt 871 55 110
Evt 872 55 110
Evt 873 55 111
Evt 877 55 111
Evt 878 55 111
Evt 879 55 111
Evt 881 55 111
Evt 884 55 111
Evt 885 55 111
Evt 886 55 111
Evt 887 55 111
Evt 888 55 111

Expansion Cartridge
 installation planning 8
 six-port 11
 twelve-port 11
 two-port 10
expansion equipment
 installation checklist 8
expansion modules
 connecting 10, 13, 18
 installation 11
 routing fibers for 13
external antenna, installing 35–
 41
external paging, portable
 telephones 58

F

features

 Norstar 58
 portable 58

Federal Communications

 Commission (FCC)
 certification, antennas 36
 designation of UTAM Inc. 1

I

ICS (see Integrated
 Communication System)

initializing the system

 Startup programming 51–56

Installation

 Antenna 41–48

installation

 base station 7, 18, 30–33
 checklist 7, 17
 configuring expansion
 modules 8
 equipment and supplies
 checklist 7

- expansion modules 18
- external antenna 35
- lightning surge arrestor 35–41
- lightning surge protector 47
- planning 7–15
- RPI 18–25
- Station Module 7

Installer password 55

installing equipment

- external antenna 35–41

Integrated Communication System (ICS)

- numbering 14
- see also KSU 8

invalid code, UTAM 71

K

keys

- activation (see UTAM)
- recovery (see UTAM)

KSU (Key Service Unit) see ICS (Integrated Communication System)

L

LID (see system logical identifier)

lightning protection 2

lightning surge arrestor

- installing 35–41

Lightning surge protector

- Installing 47–48

M

maxi system, configuring base station 9

mega system, configuring base station 11

midi system, configuring base station 9

mini system, configuring base station 9

module numbering

- six-port Expansion Cartridge 14
- twelve-port Expansion Cartridge 15
- two-port Expansion Cartridge 14

mounting RPI 20

N

non-expanded system (ICS alone) numbering 14

Norstar features 58

Norstar Programming Record 52

Norstar Remote Utilities (NRU)

- using to program system 4

Norstar Voice Mail, system requirements 5

Nortel Customer Response Center

- regression key 101
- software keys 68
- verifying UTAM wireless approval 30

P

paging from portable telephones 58

password

- defaults 54
- Installer 55

plug-top power supply 114

port allocation 18

portable DNs 61

portable registration 72

- portable telephone
 - deregistration 83
 - description 4
 - DN range 35
 - features 58
 - installing 34
 - registration 35, 80–82
 - signal strength (see Receive Signal Strength Indicator)
 - system maximum 35
 - testing 93
 - troubleshooting 95
 - using in US 4
- power supply
 - for an RPI 19
 - plug-top 114
- power up, startup messages for base stations 49
- programming
 - Companion 51–72
 - entering for System Coordinators 57
 - entering with other passwords 58
 - exiting 52
 - overview 51–52
 - registration for portable telephones 60–63
 - Startup 55–56
 - system 51–72
 - system logical identifier 66
 - tools 52
 - using Norstar Remote Utilities (NRU) 4
 - viewing updates 53
- programming record 52
- provisioning record 30
 - using 7

R

- radiated emissions 1
- radio credits 64
- Receive Signal Strength Indicator
 - C3020, directed 91
 - C3020, undirected 90
 - C3050, directed 85
 - C3050, undirected 84
 - measuring undirected/directed for C3050 model 78
- re-evaluation (see Companion re-evaluation)
- registration
 - C3050 portables 80–82
 - disabling 60–63
 - enabling 60–63
- Remote Power Interconnect (see RPI)
- replacing a base station 97
- RPI (Remote Power Interconnect)
 - backup power requirements 18
 - cabling distance 22
 - clearance 20
 - DC loop resistance 22, 96
 - installing 18–28
 - part number 113
 - power supply 19, 119
 - technical specifications 113
 - troubleshooting 99
 - upgrading RPI-8 to RPI-16 22
- wiring 22–30
 - input connections 24
 - output connections 24

RPI-16 BIX UL, capacity 19

RPI-8 BIX UL

capacity 19

upgrading 119

RSSI (see Receive Signal Strength Indicator)

S

safety 2

signal strength (see Receive Signal Strength Indicator)

six-port Expansion Cartridge 11, 14

software keys 67

software, ICS and Norstar XC 2.0 3

Startup programming 55–56

Station Module

base station capacity 7

installation planning 7

SysID

loss of 100

recording 101

system

activating 101

activation 1, 68

programming 51–72

requirements for Norstar Voice Mail 5

testing coverage 94

upgrading 119

System Coordinators

entering programming 57

System Coordinators, entering programming 57–??

system logical identifier 66

T

TCM connections

Base Stations 32

polarity of 32

technical specifications

Base Station 114

base station 113, 114

plug-top power supply 114

RPI 113

template, changing default 56

testing

base station 93

portable telephone 93

system coverage 94

troubleshooting

base station 95–96

portable telephone 95

Remote Power Interconnect 99

twelve-port Expansion Cartridge 11

module numbering 15

twinning 3

two-port Expansion Cartridge 10

module numbering 14

U

uninterruptible power supply (see UPS)

upgrading

RPI-8 to RPI-16 (see RPI-8 BIX UL)

system 119

UPS (uninterruptible power supply) 18

UTAM

activation key 68

approval 1, 7, 30

invalid code 71

recovery key 68, 72

regression key 72, 100–101

V

viewing programming 53

Voice Mail, system requirements
5

W

wireless capabilities (see
Companion)

wireless communication
activation approval 1, 68,
101
regression key 100–101

wireless equipment 30

wireless, antenna installation 35

wiring, RPI 18–30

Backup programming overlays

