

# **Modular ICS 6.1 System Coordinator Guide**

Norstar, Meridian and Companion are trademarks of  
Nortel Networks

© Nortel Networks 2003



# Table of Contents

## **Getting started with Norstar 13**

- Using this guide 13
  - Emergency 911 Dialing 13
- Understanding programming 14
- Before you start 15
- What you need to do programming 15
- Using Buttons 16
  - Using the buttons under the display 19
  - The programming overlay 19
- A map for using programming 23
- Starting and ending a session 27
- Ending a session 27

## **Frequently used programming operations 29**

- Changing the display time & date 29
- Adding or changing a system speed dial 31
- Program a name for a speed dial 33
- Changing the name of a telephone 34
- Changing the name of a line 35
- Making changes to Call Forward No Answer 37
- Making changes to Call Forward on Busy 39
- Making Changes to Do Not Disturb on Busy 40
- What would you like to do next? 41

---

## **Answering calls 43**

- Answering calls in Hunt Groups 43
- Answering an incoming call 43
  - Line buttons 44
  - Rings you may hear 45
- Sorting calls by distinctive ring patterns 46
- Answering calls at a prime telephone 47
- Expanding telephone capacity 48
  - Using a CAP module 48
  - Using a KIM in a central answering position 50

- Release button 55
- Hearing aid compatibility 55
- Viewing information about a call on the display 55
  - Using Call Information for a particular call 56
  - Displaying Call Information before or after answering 57
  - Displaying Call Information for a call on hold 57
  - Making Call Display information appear automatically 58
  - Changing which information is shown first about a call 58
- Picking up a call ringing at another telephone 59
  - Answering ringing telephones using Directed Pickup 59
  - Answering any ringing telephone using Group Pickup 60
  - Changing a telephone pickup group 61
  - Trunk Answer 62
  - Answering a call using Trunk Answer 62
  - Answer DNs and Answer keys 63
- Creating a Conference Call 64
  - Disconnecting one party 65
  - Independently holding two calls 65
  - Putting a conference on hold 66
  - Splitting a conference 66
  - Removing yourself from a conference 66
- Listening to a call as a group 68
  - Canceling Group Listening 68
- Using handsfree/mute 68
  - Answering calls without lifting the receiver 69
  - Making calls without lifting the receiver 70
  - Muting the set 70
  - Changing a regular call to handsfree 70
  - Changing a handsfree to a regular call 71
  - Using handsfree 71
  - Changing handsfree for a telephone 72
  - Handsfree Answerback 73
- Turning Privacy on or off for a call 74
  - Creating a conference by releasing privacy 75
  - Making a call private 75
- Checking call length using Call Duration Timer 75
- Disconnecting by accident 76
- Time 76

---

## **Making calls 77**

- Choosing a line using a line button 79
- Line pools 80
  - Using a line pool to make a call 81
  - Programming a memory button with a line pool 81
  - Making calls from an ISDN terminal 82
- Changing how you dial your calls 82
  - Using Standard dial 82
  - Using Automatic dial 82
  - Using Pre-dial 83
- When the internal number you called is busy 83
  - Priority Call 83
  - Making a priority call 84
  - Giving a telephone the ability to make priority calls 84
  - Using Ring Again 85

---

## **Time savers for making calls 87**

- Storing a number on a memory button for Autodial 87
  - Adding an autodial button 87
  - Choosing a line for Autodial 88
  - Using intercom as the line for Autodial 88
- Using Last Number Redial 90
- Preventing a telephone from using Last Number Redial 90
- Using Speed Dial 91
  - Making a speed dial call 92
  - Changing and adding System Speed Dials 92
  - Adding or changing User Speed Dial 92
- Using Saved Number Redial 94
  - Dialing a saved number 94
- Blocking Saved Number Redial 95

---

## **Handling many calls at once 97**

- Using Hold 97
  - Retrieving a held call 97
  - Holding automatically 97
  - Listening on hold 98
  - Holding a call exclusively 98
- Using Call Queuing 99

---

## **Transferring calls 101**

- Using the transfer feature 101

- Transferring a call 101
- Transferring external calls 102
- Canceling a transfer 103
- Using Camp-on 104
- Parking a call 106
  - Retrieving a parked call 106
  - Using Call Park 106
- Using system-wide call appearance (SWCA) 108
  - Incoming calls 109
  - Outgoing calls 111
  - No free call keys 111
- Using Callback 112

---

## **Forwarding your calls 113**

- Forwarding your calls to another Norstar telephone 113
  - Canceling Call Forward 113
  - Using Call Forward at your telephone 114
  - Overriding Call Forward 114
  - Changing the automatic Call Forward settings for a telephone 115
  - Changing Forward no answer 115
  - Changing the delay before a call is forwarded 115
  - Forward on busy 116
  - DND on Busy 116
  - Call Forward and Voice Mail 117
- Line Redirection 118
  - Turning on Line Redirection 118
  - Canceling Line Redirection 119
  - Allowing a telephone to redirect calls 120
  - Turning the redirect ring for a telephone on or off 120
  - How Line Redirection is different from Call Forward 122
  - Using Line Redirection 123
- Centralized voice mail and auto attendant 124
  - Using a centralized voice mail system 124

---

## **Communicating in the office 125**

- Paging 125
  - Making a page announcement 125
  - Activating and deactivating the ability to page 126
  - Creating page zones 126

- 
- Using Page with external paging equipment 128
  - Sending messages 128
    - Sending a message 128
    - Canceling a message you have sent 130
  - Viewing your messages 130
    - Replying to a message 130
    - Replying to a message using an analog telephone connected to an ASM 131
    - Removing items from your message list 132
    - Removing items from your message list using an analog telephone connected to an ASM 132
    - Viewing messages you have sent 133
  - Using Voice Call 134
    - Muting Voice Call tones 134
    - Answering a Voice Call with handsfree 135
    - Blocking Voice Calls using Voice Call Deny 135
- 

## **Tracking your incoming calls 137**

- Using Call Log 137
    - Call Log options 138
    - Logging a call manually 138
    - Enabling and disabling autobumping 139
    - Viewing your Call Log 139
    - Viewing a Call Log item 139
    - Erasing log items 140
    - Making a call using Call Log 140
    - Creating a password to your Call Log 141
    - Changing your Call Log password 141
    - Deleting an assigned password 142
    - Programming a telephone to log calls automatically 142
  - Using external Voice mail 144
- 

## **Customizing your telephone 145**

- Finding out what a button does using Button Inquiry 145
- Changing the set display contrast 146
- Changing the language on the display 146
- Programming a feature code onto a memory button 147
  - Programming feature buttons 147
  - Erasing a feature button 147
- Labeling your set 149

- Applying button labelling 149
  - Business Series Terminals 149
  - Norstar button caps 150
  - Default button assignments 150
    - T7316E Business Series Terminal button defaults 151
    - T7316 Business Series Terminal button defaults 153
    - M7310 telephone button defaults 155
    - M7324 telephone button defaults 157
    - M7208 and T7208 button defaults 158
    - M7100 and T7100 button defaults 159
    - Rules of default button assignment 159
  - Moving line buttons 161
  - Changing the type of ring 162
  - Adjusting the Ring volume 162
  - Hiding the message or calls indication 162
- 

## **User Preferences 163**

- Using User Preferences 163
    - Changing button programming 164
    - Changing User Speed Dial 165
    - Changing Call Log options 166
    - Changing how calls are dialed 166
    - Changing the language used on the display 167
    - Making the display lighter or darker 167
    - Changing the ring type 167
- 

## **Programming Hunt Groups 169**

- Adding or removing members from a group 171
  - Moving members of a group 172
- Assigning or unassigning lines to a group 173
- Setting the distribution mode 174
- Setting the hunt delay 175
- Programming busy line setting 176
- Programming the queue time-out 177
- Programming the overflow set 177
- Setting the name 178
- Allowing/disallowing an auxiliary ringer 179
- Assigning a distinctive ring pattern to a Hunt Group 179
- Using Silent Monitor 180



---

Feature notes 183

---

## **Using the Hospitality features 185**

- Hospitality passwords 185
  - Room/desk information 187
    - Programming room information 187
    - Using the room/set programming 189
  - Programming the alarm feature 191
    - Using the Administration set to control alarms 192
    - Using the alarm 193
    - Canceling an alarm 194
    - Turning off an alarm 194
- 

## **Telephone features 195**

- Installing Business Series Terminals 195
  - Installing Norstar telephones 197
  - Naming a telephone or a line 199
  - Moving telephones 199
  - Stopping calls from ringing at your telephone: Do Not Disturb (DND) 200
    - Stopping calls 200
    - Refusing to answer a call 200
    - Canceling Do Not Disturb 200
    - Using Do Not Disturb 200
  - Using Background Music 201
    - Turning Background Music off 201
- 

## **ISDN PRI and BRI 203**

- ISDN PRI 203
  - ISDN PRI features 204
    - Network Name Display for PRI 204
    - Name and number blocking for PRI 205
    - Emergency 911 Dialing 205
    - Two-way DID 205
    - Call by Call service selection for PRI 206
    - Dialing Plan and PRI 207
  - ISDN BRI 208
    - Line access from an ISDN terminal 209
  - ISDN BRI features 209
    - Network Name Display for BRI 209
-

- Name and number blocking for BRI 210
- Service provider features 210
  - Call Forward 210
  - Canceling Call Forward 211
  - Calling the number your calls are forwarded to 211
  - Automatic Call Back 211
  - Automatic Recall 211
  - MCID (profile 2) 212
  - Network Call Diversion (profile 2) 213
  - Overlap dialing (profile 2) 213
- ISDN BRI terminals 213
- ISDN applications for BRI and PRI 213
  - Videoconferencing and video telephony 213
  - Desktop conferencing 214
  - File transfer 214
  - Telecommuting 214
  - Group 4 fax 214
  - Remote LAN access 214
  - Leased line backup 214
  - LAN to LAN bridging 215
  - Internet and database access 215

---

## **Using System features 217**

- Using alternate or scheduled services 217
  - Preventing certain calls from being made 217
  - Making additional telephones ring 217
  - Changing the lines used by outgoing calls 218
- Turning Services on and off 218
  - An example of how to turn on a Service manually 219
- Turning Services on and off 220
  - Viewing the active Services on a two-line display 221
  - Viewing the active Services on a one-line display 222
- Using passwords 224
  - Using a Basic password 224
  - Registration password 225
  - Changing passwords 225
  - Clearing a Call Log password 226
  - Hospitality passwords 227
  - Silent Monitor password 228
- Using special telephones 228

- Direct-dial 228
  - Changing the direct-dial telephone assignments 229
  - Hotline 230
    - Bypassing a Hotline 230
    - Making a telephone a hotline telephone 230
  - Control telephone 231
  - SM Supervisor 232
- Using Set lock 232
  - Changing Set Lock programming for a telephone 233
- Using an auxiliary ringer 233
  - Turning the auxiliary ringer for a telephone on or off 233
- Using Host System dialing signals 234
  - Link 234
    - Preventing a telephone from using Link 235
  - Pause 236
  - Long Tones 236
  - Programmed Release 237
  - Run/Stop 237
  - Wait for Dial Tone 238
  - Using tone dialing for a call 238
- Using your Norstar system from an external location 239
  - Controlling access to your Norstar system 240
  - Direct inward system access (DISA) 240
  - Class of Service (COS) 240
  - Maintaining security 241
  - Accessing Norstar remotely over the public network 241
- Tones 242
  - Using Class of Service (COS) passwords 242
  - Changing your Class of Service 243

---

## **General System features 245**

- Set profile 245
- Line profile 245
- Pulse or tone dialing 246
- Disconnect supervision 246
- Hunt Groups 246
- Internal numbers 247
- Line assignment 247
- Target line 248

- Line pools 249
- Overflow call routing 249
- M7100 and T7100 telephones 250
  - Memory buttons 250
  - One-line display 251
  - Prime line 251
  - Private lines 252
  - Volume bar 252

---

## **Troubleshooting 253**

- Using the alarm telephone 253
- Reporting and recording alarm codes 253
- Testing the telephone 254
  - Testing the telephone display 254
  - Testing the telephone buttons 255
  - Testing the speaker in the telephone handset 255
  - Testing the telephone headset 255
  - Testing the telephone speaker 256
  - Testing the power supply to a telephone 256

---

## **Common feature displays 257**

---

## **Glossary 261**

---

## **Index 279**

- Backup programming overlays 305

# Getting started with Norstar

Your Norstar digital key system has many powerful features that can be customized to keep up with changes in your workplace.

## Using this guide

The person who is responsible for adding or moving telephones or making changes to the system is called the system coordinator. This guide is designed to give the system coordinator all the information he or she needs to carry out these kinds of jobs.

The first section contains step-by-step instructions about changing the time and date, deciding how many rings it takes before a call is forwarded, and other day-to-day programming. Once you understand these basic steps, you can move on to the many other features described in the second section of the guide, and refer to the first section only from time to time.

You can look at the contents page for an overview of the features that are available, or check the index for specific features or messages displayed on your telephone.

## Emergency 911 Dialing

Emergency 911 Dialing is the capability to access a public emergency response system by dialing the digits 9 1 1.



### *Emergency 911 Dialing*

State and local requirements for support of Emergency 911 Dialing service by Customer Premises Equipment vary. Consult your local telecommunications service provider regarding compliance with applicable laws and regulations.



## Understanding programming

When your system is installed, your installer or customer service representative programs it to work with your telephone lines, with your private network, if you have one, and with optional equipment. They customize the system for your office. All programming is recorded in the *Modular ICS 6.1 Programming Record*.

You may want to further customize your system. For example, you can change how some features work, or adapt the system to changes in your office. Programming allows you to change settings that probably need to be updated regularly because of staff turnover or new business contacts. You can also assign features and program buttons on individual telephones.

There are four ways to customize and maintain your Norstar system:

- Initial programming is performed for you by your installer or customer service representative. It deals mostly with how the system interacts with lines, telephones, and other equipment.
- Your programming as a system coordinator changes how features work for the system, as needed. It requires a System Coordinator password.
- A Basic programming password is available to allow individuals other than the system coordinator to make changes without giving access to sensitive programming capabilities.
- Personal programming is available to anyone through the Feature button on their Norstar telephone. It allows individuals to change how their telephone works to suit themselves.



## Before you start

Before you begin programming, plan what changes you want to make. Record the changes in the *Norstar Programming Record* so that you have the information at hand. For example, if you are going to program system speed dial numbers, fill out the page in the *Norstar Programming Record* so that you have all the numbers and codes handy once you start programming.



## What you need to do programming

Programming is performed using a telephone that can show two lines of information on its display. Examples of telephones with two-line displays are shown on page 16.

You need a programming overlay to show which buttons to press when you are performing programming. See *The programming overlay* on page 19.

When you use a telephone for programming, it is taken out of service. This means it is unable to receive or make calls, and the call forward features do not work. Do not use the main reception telephone for programming because you may lose incoming calls.

## Using Buttons

The two-line telephone you use for everyday calling can be used for changes and maintenance. Examples of telephones with two-line displays are shown in the illustration.

### Sets used for programming and maintenance

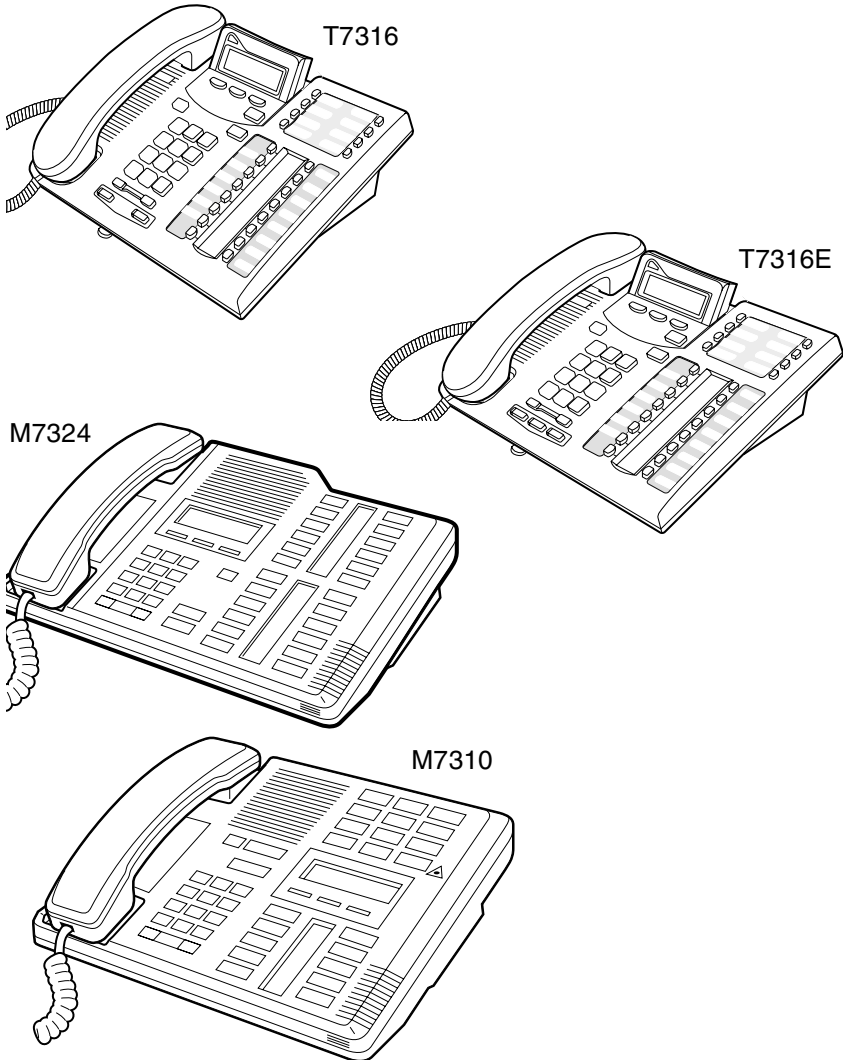



The next illustration numbers the buttons that are used for both day-to-day communication and programming on the T7316 set. The following table describes what each numbered area is used for.

### Business Series Terminal programming buttons

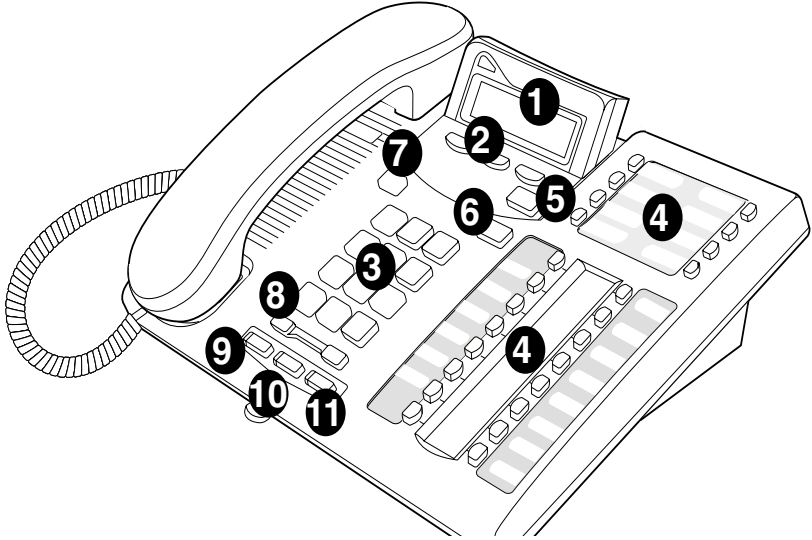





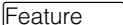

<b>1</b> Display	Shows instructions for everyday calling as well as for programming.
<b>2</b> Display buttons	Have a variety of uses. The current use is shown on the display above each button.
<b>3</b> Dialpad	Used for dialing numbers when you are making calls. For programming, the dialpad is also used for entering numbers and letters
<b>4</b> Memory buttons	Dial a number or feature code stored on the button.
<b>5</b> Feature button	Allows you to enter a feature code while using or programming the telephone.
<b>6</b> Hold button	Puts an active call on hold.
<b>7</b> Release button	Hangs up an active call or ends programming.

<p><b>8</b> Volume rocker switch</p>	<p>Turns the volume you hear through the handset up or down. During programming this switch is used to adjust settings, such as for the display contrast.</p>
<p><b>9</b> Mute</p>	<p>Mutes the transmitter in the handset.</p>
<p><b>10</b> Handsfree</p>	<p>Allows you to speak to and hear a call without using the handset or headphones.</p>
<p><b>11</b> Headset</p>	<p>Activates the headset feature.</p>

This guide uses the icons for Business Series Terminal T7316E buttons in feature code examples. Your telephone may have different labels, or the buttons may be in slightly different locations. Refer to the table below for comparable Norstar icons

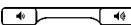
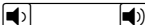
**Telephone buttons**

<p><b>Business Series Terminals</b> T7316 and T7316E</p>	<p><b>Button description</b></p>	<p><b>Norstar sets</b> M7310, M7324</p>
	<p><b>Feature</b></p>	
<p>Handsfree:  (T7316E)</p> <p>Mute: </p>		<p><b>Handsfree/Mute</b></p>
	<p><b>Hold</b></p>	
	<p><b>Volume Control</b></p>	
	<p><b>Release</b></p>	

## Using the buttons under the display

The three display buttons are used both for telephone features and programming. What each button does depends on what the display shows. Some display instructions that you may see when making changes on the system include OK, CHANGE, or COPY. In this guide, display button instructions are underlined.

### Display buttons

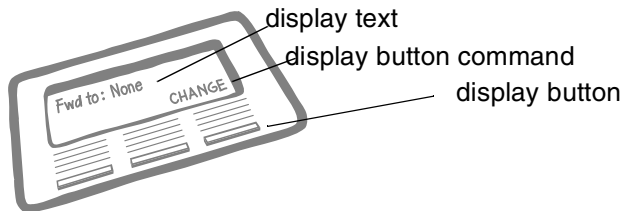

## The programming overlay

When you begin programming, a group of buttons on the telephone become the buttons for moving through programming headings and settings. The programming overlay is a paper cutout that is included with the Programming record. It relabels the four buttons to name the actions you use during programming. If you lose the overlay, there is an extra overlay included in the back of this book that can be printed and cut out.

The diagram below shows how the headings are used to navigate the programming menus.

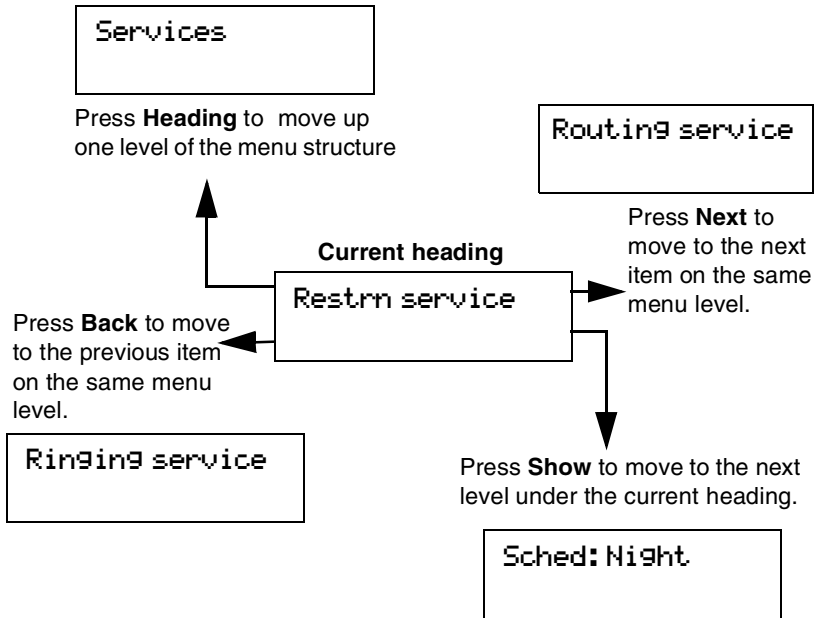

Programming buttons are active or inactive at different stages of programming. A button is active (meaning you can use that option), when the indicator next to it is lit (◀ or ▶).

## Business Series Terminal programming overlay

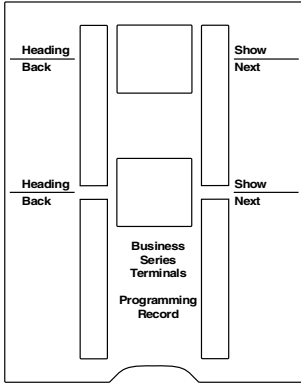

**T7316E programming set**

**T7316 programming set**

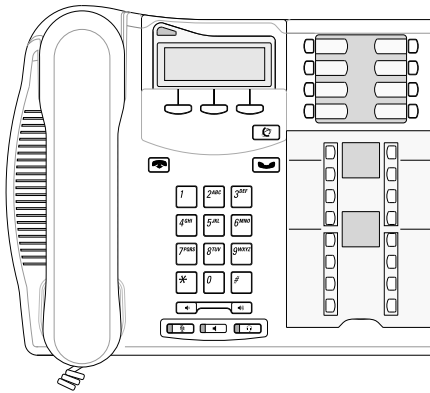

**Overlay placed over keys with indicators**

### Placing the programming overlay on Norstar sets

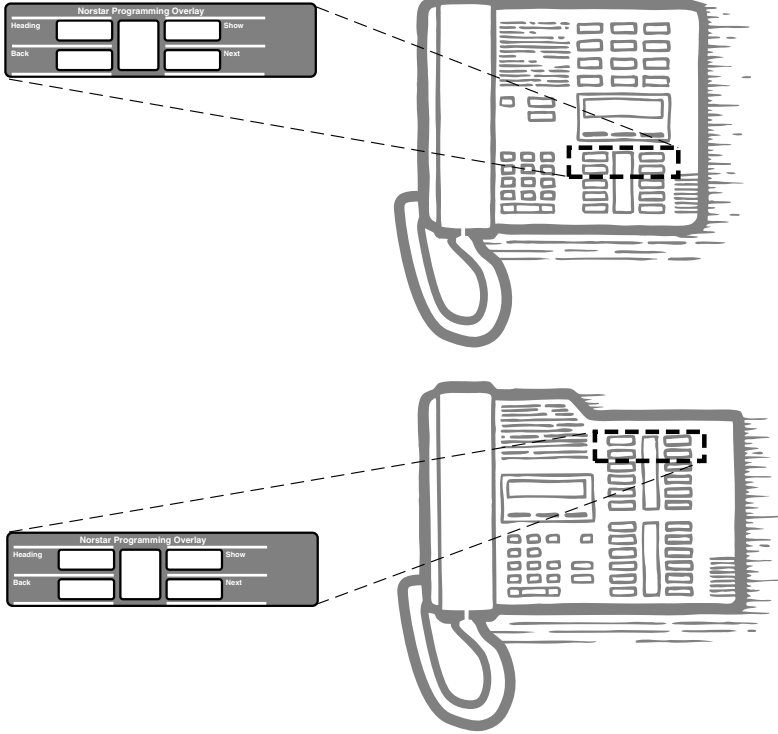

Displays the heading for the current level

Displays the first setting within a menu level



Moves back one item on the current level

Moves display one item forward on the current menu level

## A map for using programming

The tables on the following three pages show the headings that display when you move through the display menu after pressing **☰ \* \* C O N F I G** and entering the password (the default password is **A D M I N** or **2 3 6 4 6**).

The default Basic password (**B A S I C** or **2 2 7 4 2**) can be used with a limited number of feature codes, including **\* \* T I M E** and the codes for turning call services on and off. For more information, see *Using passwords* on page 224.

### Terminals&Sets

Customize each telephone on the system. You can change where a call is forwarded, give a telephone a name, or allow certain features to be used at a telephone. You can change the button programming on any telephone on the system.

### Lines

Show the active lines. Coordinator can rename lines.

### Services

Turn services on or off: Ringing service, Restriction service, and Routing Service.

### Sys speed dial

Program up to 255 different telephone numbers so internal users can dial them with a three-digit code (001-255).

### Passwords

Change or erase the password you use for programming, or the one you use for Call log. On an XC system, you can change the Companion portable telephone registration password.

### Time&Date

Change the time, date, or both.

### System prgrming

Access the headings that define Hunt Groups, Hospitality services. Enter the BusName, which displays on caller ID lines.

On a MICS-XC system, access registration records for Companion portable telephones so you can disable or enable the sets.

## System Coordinator user interface

<b>Terminals &amp; Sets</b>	<b>Show set</b> Enter digits or press LIST.	<b>Capabilities</b>	<b>Fwd no answer</b>	<b>Fwd to</b> Fwd delay
			<b>Fwd on busy</b>	<b>Fwd to</b>
			<b>DND on busy</b>	
			<b>Handsfree</b>	
			<b>HF answer back</b>	
			<b>Pickup grp</b>	
			<b>Page zone</b>	
			<b>Paging</b>	
			<b>D-Dial</b>	
			<b>Priority call</b>	
			<b>Hotline</b>	<b>Intrn #</b> Extrn# ... Use prime line
			<b>Aux. ringer</b>	
			<b>Allow redirect</b>	
			<b>Redirect ring</b>	
			<b>ATA settings</b>	<b>ATA ans timer</b> Msg Indicate
		<b>Name</b>		
		<b>User preferences</b>	<b>Model</b>	
			<b>Button progrming</b>	<b># of buttons</b> B01 ... BXX CLR TEL# FEATR
				<b>KIM X or CAP X</b>
			<b>User speed dial</b>	<b># of speed dialers</b> Spd # 255-279
			<b>Call log opt'ns</b>	<b>No one answered</b> Unanswered by me Log all calls No autologging
			<b>Dialing opt'ns</b>	<b>Standard dial</b> Pre-dial Automatic dial
			<b>Language</b>	
			<b>Display cntrst</b>	
			<b>Ring type</b>	
			<b>Voice path</b>	<b>Dflt: Handsfree</b> Headset
		<b>Restrictions</b>	<b>Set restrictions</b>	<b>Set lock (Partial, Full, None)</b>
				<b>Allow last no</b>
				<b>Allow saved no</b>
				<b>Allow link</b>
		<b>Telco features</b>	<b>1st Display</b>	
			<b>Called ID</b>	



Note: Some headings will only show if required by the selected options for the previous heading.

















Lines	Show lines	Name	
	Enter digits or press LIST		
Services	Ringng service	Sched: Night Evening Lunch Sched 4 Sched 5 Sched 6	Off, Manual, Auto
	Restrn services	Sched: Night Evening Lunch Sched 4 Sched 5 Sched 6	Off, Manual, Auto
	Routing service	Sched: Night Evening Lunch Sched 4 Sched 5 Sched 6	Off, Manual, Auto
Sys speed dial (001-255)	Speed dial # Enter digits or press LIST	add/change tel #  Use prime line Display digits Name	
Passwords	Call Log pswds	Show set	Log pswd
	Progrming pswds	Sys admin: 23646 Basic: 22742	
	Reg. pswd (MICS-IX, only)		
	Hospitality	Desk pswd: 4677 Cond pswd:None	
	SM pswd: 745368		
Time&Date	Hour		
	Minutes		
	Year		
	Month		
	Day		











<b>System Prgmrng</b>	<b>Hunt Group</b>	<b>Show Group</b>	<b>Member DNs</b>	
			<b>Line assignment</b>	<b>Show line Unassigned/Assigned</b>
			<b>Mode</b>	<b>Broadcast Sequential Rotary</b>
			<b>Hunt Delay</b>	
			<b>If Busy</b>	<b>BusyTone/Queue</b>
			<b>Q Timeout</b>	
			<b>Overflow</b>	
			<b>Name</b>	
			<b>Aux. Ringer</b>	
			<b>Distnct ring</b>	
		<b>Registration</b>	<b>Registration</b>	
		<b>Companion (MICS-XC only)</b>	<b>Portable DNs</b>	<b>Show DN Available/unavailable</b>
			<b>Radio data</b>	<b>Re-evaluation Status</b>
				<b>Radios</b>
			<b>Cells</b>	<b>Show Cell Cell radios/Cell nghbrs/Cell rad nghbrs</b>
	<b>BusName</b>			
	<b>Hospitality</b>	<b>Room/desk info</b>	<b>Show set</b>	<b>Room #</b>
		<b>Service time</b>	<b>Hour</b>	<b>Adm pwd req'd</b>
		<b>Alarm</b>	<b>Minutes</b>	
			<b>Attn attempts</b>	
			<b>Retry intrvl</b>	
			<b>Attn duration</b>	
			<b>Time format</b>	<b>12 hr/24 hr</b>
			<b>Expired alarms</b>	<b>Notify set</b>
				<b>Use tone</b>

## Starting and ending a session





As system coordinator the first steps in making any change to the Norstar system are always the same.

Jan 1 12:00pm Press .

Feature: Press        . This is the same as pressing        .

Password: RETRY Press     . This is the same as pressing     . Press RETRY to re-enter the password if you enter an incorrect character.

Terminals&Sets The display shows the first of the seven headings available for administration programming.

     is the password, unless the password has been changed. Check the Programming Record for the most recent password.

## Ending a session

Display digits:Y CHANGE Press  to end the session.

End of session After a few seconds, the time and date reappears on the display.

The system makes any changes you indicated in programming as soon as you move away from a setting, either by using the navigation buttons or by pressing .

You can see if the changes you made to telephone programming have taken effect by pressing the UPDATE display key. The display shows you how many telephones have not been updated.

Press DNE to see the specific extensions where programming changes have not taken effect yet. Items disappear from the list as they are updated.

Record any changes you make in the *Modular ICS 6.1 Programming Record*. If there is a problem with the system, the installer needs to see a history of the changes you have made.











Remember to inform people in your office of any changes you have made that affect them. For example, you may change system speed dial codes or change the number of rings before an unanswered telephone is forwarded.











# Frequently used programming operations

The following sections highlight the most frequently used programming operations. To consult these or other programming operations, see either the Table of Contents or the Index.

## Changing the display time & date

Jan 1 12:00pm Press .

Feature: Press        
(which is the same as     .

Password: Press      (B A S I C) or  
      (A D M I N)

The passwords can be changed. See *Using passwords* on page 224 for more information.

## Entering letters and numbers using the dialpad

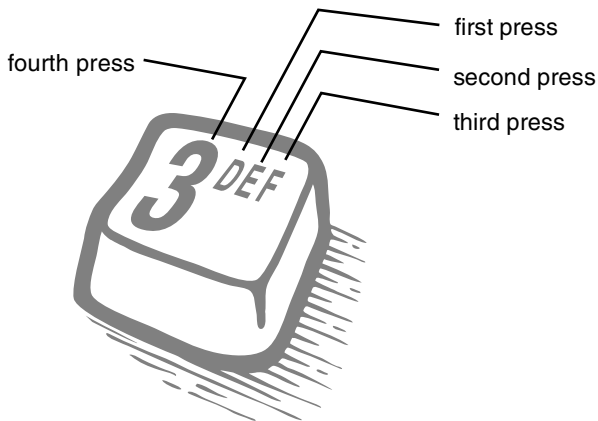

In this example, you are changing the time to 1:30 p.m.

Hour:01  
NEXT CHANGE

Press CHANGE.

Hour:\_\_\_  
CANCL

Press the dialpad buttons to enter the hour. Use two digits for all hours. The clock on the display shows either one or two digits.

AM  
OK CHANGE

The display prompts you to choose a.m. or p.m. Press CHANGE and OK to select p.m.

Hour:01  
NEXT CHANGE

Press NEXT.

Minutes:00  
NEXT CHANGE

Press CHANGE.

Minutes:\_\_\_  
CANCL

Press the dialpad buttons to enter the minutes.

If you are only changing the time and not the date, press  to end your session.

In this example, you are changing the date to July 15, 1998.

Minutes:30  
NEXT CHANGE

Press NEXT.

Year:01  
NEXT CHANGE

Press CHANGE.

Year:\_\_\_  
CANCL

Press the dialpad buttons to enter the year.

Year:02  
NEXT CHANGE

Press NEXT.

Month:01  
NEXT CHANGE

Press CHANGE.

Month:\_\_\_  
CANCL

Press the dialpad buttons to enter the month.

Use numbers for the months: 01 is January; 12 is December.

Month:07  
NEXT CHANGE

Press NEXT.

Day:01  
NEXT CHANGE

Press CHANGE.

Day:\_  
CANCL

Press the dialpad buttons to enter the day.

Day:15  
CANCL

Press  to end your session.

End of session

The clock controls the schedules used for services such as ringing and routing services.

After a power failure, the clock is behind by the length of time power was lost. For example, if the power is out for two minutes, the clock is two minutes behind.

## Adding or changing a system speed dial

You program a speed dial on your Norstar so that anyone in your office can dial a frequently used number using a three-digit code (001-255).









To change a speed dial that already exists, follow the same steps. The new programming overwrites the previous number and settings.

### Begin the programming session





Jan 1 12:00PM

Press .

Feature:

Press        .

Password:  
RETRY

Press     .

## Choose a speed dial code

Terminals&Sets▶

Press  three times.

Sys Speed Dial▶

Press .

Speed dial #:\_

Press   .

LIST

You can pick any system speed dial code between 001 and 255.

Speed dial #:001▶

Press .

FIND

## Add or change the telephone number

001:No number

Press CHANGE.

CHANGE

001:\_

CANCL

OK

Use the dialpad to program the telephone number that you want to add. The telephone number can be up to 24 digits long.

001:nnnnnnnn\_

CANCL

BKSP

OK

Your display shows the telephone number, which is represented by the row of n-characters shown here. Press OK.

## Select a line for the speed dial code

001:nnnnnnnn

CLR

CHANGE

Press .

Use prime line

CHANGE

Press CHANGE to see your options: Use prime line, a specific line (for example Use line: 01), a line pool (for example Pool code:71), or Use routing tbl.

Stop pressing CHANGE when the display shows the prime line again.

Use prime line

CHANGE

In this example, the system selects the prime line automatically to dial speed dial code 001. This is the most common choice.

If you assign a specific line to a system speed dial number, only telephones with an appearance of that line can use the speed dial number.



## Choose what shows up on the display

Use prime line  
CHANGE

Press .

Display digits:Y  
CHANGE

Your choices are Yes and No. Yes means the display shows the telephone number.

Press CHANGE.

Display digits:N  
CHANGE

No means the display shows a name for the code.

## Program a name for a speed dial

The system has a standard name to display, so it is not necessary for you to program one. However, if you have chosen not to display the telephone number, you may want a specific name.

**Alpha tagging feature:** This feature offers name display for calls coming in over lines that offer number-only display services.

If you specify a name for a speed dial, and that person calls in on an external line, the speed dial name you specify acts as the name display for the call if the call number matches the number in the speed dial list. If the telephone has also been configured to display Caller ID (Caller ID set) with the name of a caller first (1st display), then the name you program for the speed dial code is the name that displays.

For example: If you create a speed dial for the courier company you use, and assign the name Courier with the following process, when that company calls you, Courier would appear on the display for the call.

Display digits:N  
CHANGE

Press .

Name:Sys Spd Di...  
CHANGE

Press .

...al 001 ...  
CHANGE

This is the name the display shows if you do not change it. Press CHANGE.

Name:\_\_\_\_\_  
-->

Decide the name you want to give to the speed dial code.

Press the dialpad button that has the first letter of the name until the display shows the letter you want.

Name:S  
BKSP -->

Press -->.

Name:S\_ Use the dialpad and **-->** until you have the entire  
 <-- BKSP --> name.

The name can be up to 16 characters long, including spaces.  
 Press # on the numeric dialpad to add spaces.

Name:SAVINGS BANK Press **Next**.  
 <-- BKSP -->

Name:SAVINGS BA... Press **[End Call]** to end your session.  
 CLR CHANGE

Or you can press **Heading**, then **Next** to program another speed dial number.

End of session

## Changing the name of a telephone

### Begin the programming session

Jan 1 12:00pm Press **[Clear]**.

Feature: Press **\* \* 2 6 6 3 4 4**.

Password: Press **2 3 6 4 6**.  
 RETRY

### Change the name of a telephone

Terminals&Sets▶ Press **Show**.

Show set: LIST Enter the internal number (DN) of the telephone or  
 voice mail extension. In this example, the DN is  
 221.

If the set has already been given a name, it appears after DN#: on the display.

221:221▶ Press **Show** then **Next**.  
 FIND

Name:221 This is the name the display shows if you do not  
 CHANGE change it. Press **CHANGE**.

Decide what name you want to give to the telephone number.

Name: \_ \_ \_ \_ \_  
-->

Press the numeric dialpad button that has the first letter of the name until the display shows the letter you want.

Name: J  
BKSP -->

Press -->.

Name: J \_ \_  
<-- BKSP -->

Use the dialpad and --> until you have the entire name.

Name: JEAN B  
<-- BKSP -->

Press  to use the name you have entered.

The name can be up to seven characters long, including spaces.

Name: JEAN B  
CLR CHANGE

Press  to end your session.

You can press  once to continue programming this telephone, or press  twice to return to the Terminals&Sets heading.

End of session

## Changing the name of a line

### Begin the programming session

Jan 1 12:00pm

Press .

Feature:

Press .

Password:  
RETRY

Press .

### Change the name of a line

Terminals&Sets▶

Press .

Lines▶

Press .

```
Show line:___
          LIST
```

Enter the three-digit number of the line you want to name. In this example, the line is 002.

This is the name the display shows if you don't change it.

```
Line002:Line002▶
          FIND
```

Press .

```
Name:Line002
          CHANGE
```

Press CHANGE.

Decide what name you want to give to the line.

```
Name:___
          -->
```

Press the dialpad button that has the first letter of the name, until the display shows the letter you want.

```
Name:L
      BKSP  -->
```

Press -->.

```
Name:L___
<--    BKSP  -->
```

Use the dialpad and --> until you have the entire name.

The name can be up to seven characters long, including spaces.

```
Name:LOCAL
<--    BKSP  -->
```

Press  to use the name you entered.

```
Name:LOCAL
CLR    CHANGE
```

Press  to end your session.

You can press  once to continue programming this line, or press  twice to return to the Lines heading.

```
End of session
```

# Making changes to Call Forward No Answer

## Begin the programming session

Jan 1 12:00PM

Press  .

Feature:

Press         .

Password:

RETRY

Press      .

## Change where a call goes when there is no answer

Terminals&Sets▶

Press  .

Show set:\_\_\_\_\_

LIST

Enter the internal number (DN) of the telephone or voice mail extension. In this example the DN is 225.

If the set has been given a name, it appears on the display.

225:225

FIND

Press  .

Capabilities▶

Press  .

Fwd no answer▶

Press  .

Fwd to:None

CHANGE

Press CHANGE and enter the internal number where you want the calls to be sent. In this example the internal number is 221.

You can press CLR to change the destination back to None.

## Change the number of times the telephone rings before it is forwarded

Fwd to:221  
CLR CHANGE

Press .

Forward delay:4  
CHANGE

Use the **CHANGE** button to choose the number of times the telephone rings before it is forwarded.

Your choices are 2, 3, 4, 6 and 10 rings.

Forward delay:3  
CHANGE

Press  to end your session.

You can press  to continue programming capabilities for this telephone, or press  four times to return to the Terminals and Sets heading.

End of session



**Tip** - If the Norstar set is a member of a Hunt Group, the Call Forward no answer feature is overridden and the Hunt Group call continues to ring until the hunt time has expired. For more information about Hunt Groups, see *Programming Hunt Groups* on page 169.

# Making changes to Call Forward on Busy

## Begin the programming session

Jan 1 12:00PM Press .

Feature: Press        .

Password: Press     .

RETRY

## Change where a call goes when a telephone is busy

Terminals&Sets▶ Press .

Show set: LIST Enter the internal number, which gets assigned as the intercom number, of the telephone extension. In this example, the intercom number is 225.

If the set has been given a name, it appears on the display.

225:225 FIND Press .

Capabilities▶ Press .

Fwd no answer▶ Press .

Fwd on busy... Press .

Fwd to:None CHANGE Press CHANGE and enter the internal number where you want the calls to be sent. In this example, the internal number is 221.

You can press CLR to change the destination back to None.

Fwd to:221 CLR CHANGE Press  to end your session.

You can press  to continue programming capabilities for this telephone, or press  three times to return to the Terminals and Sets heading.

End of session



**Tip** - If the Norstar set is a member of a Hunt Group, the Call Forward on busy feature is overridden and the Hunt Group call continues to ring until the hunt time has expired. For more information about Hunt Groups, see *Programming Hunt Groups* on page 169.

## Making Changes to Do Not Disturb on Busy

When you are on a call and a second call comes in, your telephone rings softly to alert you to the second call. You can turn this feature on or off for each telephone.

### Begin the programming session

Jan 1 12:00Pm

Press .

Feature:

Press .

Password:

RETRY

Press .

### Change Do Not Disturb on Busy

Terminals&Sets▶

Press .

Show set: \_

LIST

Enter the internal number of the telephone extension. This becomes the number for the intercom button. In this example, number is 225.

If the set has been given a name, it appears on the display.



225:225                      Press  .  
                                     **FIND**

Capabilities▶              Press  .

Fwd no answer▶            Press  twice.

DND on Busy:IN            Press **CHANGE** to turn the feature on.  
                                     **CHANGE**

DND on Busy:IV            A second press turns it off again. Press  to end  
                                     **CHANGE**                      your session.

Press  to continue programming capabilities for this telephone, or  
 press  three times to return to the Terminals and Sets heading.

End of session

For more information about Call Forward and similar settings, see *Forwarding your calls to another Norstar telephone* on page 113.

## What would you like to do next?

Some of the most common programming tasks are listed below. For a comprehensive list of settings and instructions, see either the Table of Contents or the Index.

- |  |   |
|--|---|
| Redirect calls coming in on a line.                                      | See <i>Turning on Line Redirection</i> on page 118.                   |
| Allow individuals to answer calls that are ringing at another telephone. | See <i>Picking up a call ringing at another telephone</i> on page 59. |
| Assign telephones to different zones for paging.                         | See <i>Paging</i> on page 125.  |
| Turn the night service on and off.                                       | See <i>Making additional telephones ring</i> on page 217.             |

Use a Basic password so others can take care of programming such as changing user speed dials, changing names, and changing the time and date.

See *Using passwords* on page 224.

# Answering calls

## Answering calls in Hunt Groups

Your Norstar system now allows you to establish Hunt Groups in your system. Hunt Groups are a group of Norstar set DN's that can be called by a single directory number. The Hunt Groups feature ensures calls are easily routed to the appropriate people. You can program:

- the members for a Hunt Group
- member position within a Hunt Group
- how calls are distributed
- how long a call spends looking for available members
- what happens if all members are busy

For more information about Hunt Groups see *Programming Hunt Groups* on page 169.

## Answering an incoming call

There are three indications of an incoming call: ringing, a line button flashing, and a message on the display. You do not necessarily receive all three indications for any particular call. For example, you may have a line that has been set up not to ring at your telephone. If so, you see only a flashing line button. There are many possible combinations, depending on how your system is set up. See *Choosing a line using a line button* on page 79 for more information on the use of lines.

If you receive a priority call and your telephone has no free internal line buttons, you cannot transfer the priority call, you must accept or release it.

## Line buttons

One line button for each line is assigned to your telephone. Press the line button to select the line you want to answer or use to make a call. Having several line buttons gives you immediate access to more than one line.



The M7100 or T7100 sets have two intercom paths which are used instead of line buttons to answer and make calls. Each set can be assigned two lines. You can press  to switch between two calls, one active and one on hold.



### What line indicators mean

- |   |   |  |
|---|---|--|
| ▶ | Flashing on and off for equal lengths of time | There is an incoming call on the line                                      |
| ▶ | Flashing on and off more quickly              | You have placed a call on hold   |
| ▶ | Flashing on for longer than off               | Someone else has put a call on hold on that line                           |
| ▶ | On, not flashing                              | You are connected to the call on that line or the line is in use elsewhere |
|   | Off   | The line is free   |

The **T7316E telephone** displays a set of icons in place of flashing arrows when it is connected to a system with version 6.1 or newer software. If you connect a T7316E telephone to a system that is running version 6.0 or previous versions, the standard line indicators display.

The **KIM** also displays some of these icons. Note that this piece of hardware is only supported by version 6.1 and later software.

- |   |             |  |
|---|-------------|--|
|  | Active call | The line is active and/or you are connected to this telephone. |
|  | Ringing     | A call is coming into this line.                               |
|  | Hold        | The call on this line is on Hold at this telephone.            |

	Call forward	The call on this line has been forwarded.
	Active button	The feature assigned to this button is active.

Flash rate indicators for T7316E and KIM icons

On, not flashing	You are connected to the call on that line or the line is in use elsewhere or the service indicated is active
Off	The line is free
Flashing on and off for equal lengths of time	Existing alert rate
Flashing on and off more quickly (twinkle)	I-hold
Flashing on for longer than off (blink)	U-hold

## Rings you may hear

A double beep every 10 seconds	A call has been camped to your telephone.
A long single ring	There is an external call on the line for you.
A shorter double ring	There is an internal call on the line for you or a call is being transferred to you.
A brief single ring	A call is being redirected on one of your redirected lines. You cannot answer this call.
Three beeps descending in tone	You are receiving a priority call.

## Sorting calls by distinctive ring patterns

When lines, telephones and Hunt groups are configured on your system, they can be assigned one of four distinctive ring patterns (DRP). The default for all telephones is 1 and the default for lines and Hunt groups is None, which is the lowest priority. The highest priority is 4.

**Call ringing:** When multiple calls are presented to the telephone, the call with the highest priority DRP setting will be the call that rings at the telephone.

**Call answering:** When multiple calls are presented to a telephone, and the user picks up the handset, the call with the highest priority DRP setting is the call that is presented.

**Note:** External calls always have a higher priority than internal calls.

**Note:** If the ring type is changed on a telephone after the DRPs are set on the line, the line DRPs are overwritten by the telephone settings. If the DRPs are set for a line after telephone programming, then the telephone ring programming is overridden by the line DRP program. Refer to the *Modular ICS 6.1 Installation Guide* for information about setting distinctive ring for lines. If the call is to a Hunt group, and the Hunt group DRP is higher than the line DRP, the Hunt group DRP will take precedence within the Hunt group. Refer to *Assigning a distinctive ring pattern to a Hunt Group* on page 179.

## Answering calls at a prime telephone

Each line in a Norstar system can be assigned a prime telephone. Calls not answered at their normal destinations are transferred to the prime telephone. The prime telephone is usually the attendant's telephone. The installer or customer service representative programs a prime telephone for a line.

### Displays

DND from 221	The person at telephone 221 has forwarded a call to you using Do Not Disturb.
DND transfer	The system has transferred a call to you from a telephone with Do Not Disturb turned on.
DRT Line001	Nobody answered this call so the system transferred it to you.
Line001 callback CALLBACK	Someone has camped, parked or transferred a call on line 001, but no one has answered it. Press <b>CALLBACK</b> or the line button to connect to the call.
Line001 to Prime	There is no telephone that can receive a call on line 001 so the system has transferred it to you.
Line002>Line157	The call coming in on line 002 was intended for target line 157. Line 157 is busy, so the call has come to you.

For other displays, see *Common feature displays* on page 257.

## Expanding telephone capacity

You can add additional memory buttons to M7324 telephones using a CAP module and to T7316E telephones using a KIM (T24 key indicator module). If you add the modules without identifying them as CAPs (central answering positions) in programming, the user can program the module buttons as an expanded memory button set.

However, if you want to designate one or more users to be central answering positions for your system, you can program the modules to support lines, and, in the case of the KIM, also multiple target lines and Hunt group appearances. This configuration of the KIM is called an eKIM.

Both systems provide similar features and are programmed using the same headings. These configurations are briefly described in this section. For details about configuring the KIM as an eKIM, refer to the *Modular ICS 6.1 Installer Guide*.

### Using a CAP module

A central answering position that uses a Norstar M7324 telephone and a CAP module is programmed as a CAP by your installer or customer service representative. You can have five CAPs in a Norstar Modular system. It is best if the CAP is the prime telephone and direct-dial telephone for the lines and telephones it serves.

A CAP module is an add-on device that provides 48 extra memory or line buttons. You can connect one or two Norstar CAP modules to the telephone to increase the number of lines it can handle.



When a CAP module is first plugged into your telephone, some of the module buttons are already programmed to dial an internal number.

### Norstar M7324 set with added CAP module

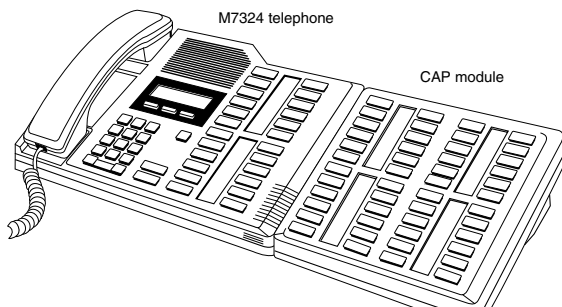

## Customizing your CAP module

If your installer has programmed the CAP module to be the central answering position for your system, you can move external lines onto the CAP module by using   \*  8  1 . See *Moving line buttons* on page 161.

Any of the buttons on your CAP module that do not select lines can be programmed to dial internal or external numbers automatically. You can program features onto CAP module buttons. See *Time savers for making calls* on page 87 and *Customizing your telephone* on page 145 for information on programming memory buttons.

Buttons on a CAP module cannot be assigned as answer buttons.

## Monitoring telephones with the CAP module

The indicators ► beside internal autodial buttons on your CAP module show the status of Norstar telephones.

### The indicator is on when the telephone has:

- an active call
- Do Not Disturb turned on

### The indicator is off when a telephone has:

- no active call
- a call on hold and no other active call



**Tip** - *You can send up to 30 messages from a CAP.*

## Using a KIM in a central answering position

When you deploy a CAP consisting of a T7316E telephone and one or more KIMs, the modules can be configured as eKIMs by your installer. If you do not need lines or hunt group appearances on the KIMs, there is no requirement for any system configuration. This configuration of the KIM is called an ordinary KIM (OKIM) and you can install up to nine modules on a T7316.

On all KIMs, at each telephone you can use the memory programming feature to:

- provide feature access (Refer to *Programming a feature code onto a memory button* on page 147)
- provide access to line pools (Refer to *Programming a memory button with a line pool* on page 81)

- provide one-press external autodial (Refer to *Storing a number on a memory button for Autodial* on page 87)
- configure system-wide call appearances (SWCA) by assigning SWCA feature codes

### **Norstar T7316E telephone with added KIM**

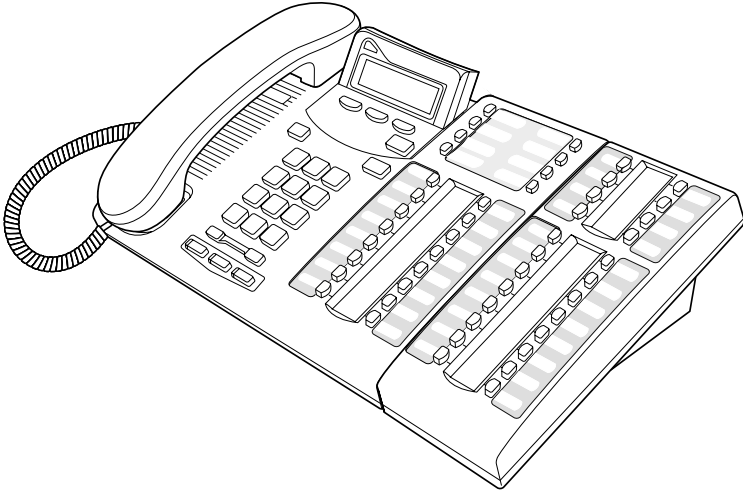

An extended KIM (eKIM) provides the same functionality as the OKIM plus the ability to support multiple lines, target lines and Hunt groups. A T7316E can support a maximum of four eKIMs. Your system can support a maximum of five CAPS using eKIMs. Note that this total includes any T7324 CAPS.

## Cold starting the KIM

If your KIM fails, or if you want to erase programming on the KIM, there are two types of cold start.



**TIPs** - If you are cold starting an eKIM that has line or Hunt group assignments, the cold start will erase current programming, and insert the line appearances, starting with the top, left button. After all the line appearances are assigned to lines, the system adds target line or Hunt Group appearances. If any buttons are left, the system will populate the buttons with autodialer assignments.

Use  \*  to view button assignments after a cold start.

For both types of cold starts:

1. Unplug and replug the T7316E line cable.

The telephone will restart and all the icons will flash. When the telephone icons stop flashing, the KIM module icons start flashing.

2. At this point, do one of the following:
  - **KIM single-module cold start**

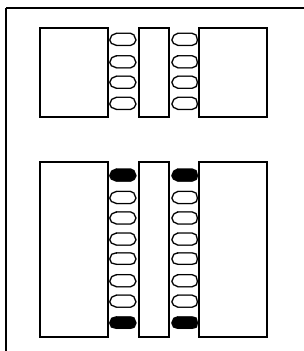

If you just want to cold start an individual module, on that module, simultaneously press the two top and two bottom buttons on the lower button set, as shown in the following diagram. The KIM displays a random pattern of icons as the KIM resets.

- **KIM multi-module cold start**

If you want to cold start all the KIMs attached to your telephone, simultaneously press the top two buttons on the upper button set, and the bottom two buttons on the lower button set, as shown in the following diagram.

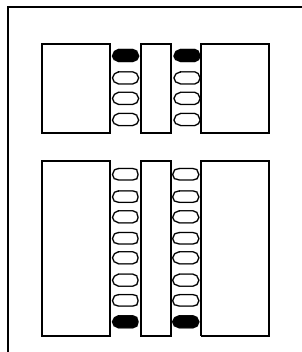

## Customizing your KIM module

You can move external lines, target lines or hunt group appearances onto the eKIM by using    . See *Moving line buttons* on page 161.

Any of the buttons on your KIM that do not select lines can be programmed to dial internal or external numbers automatically. You also still can program features directly onto KIM buttons. Refer to *Time savers for making calls* on page 87 and *Customizing your telephone* on page 145 for information about programming memory buttons.

## eKIM button programming for CAP

Any lines and target lines assigned to the T7316E, which overflow to the eKIM, must be assigned by your installer. You can, however, use the Coordinator password to assign the telephone to the hunt groups for which you want to provide an appearance. Refer to *Programming Hunt Groups* on page 169 for information about programming hunt group appearances.

Designating features or autodial numbers to the eKIM buttons, can be programmed using the `Button Programng`, which is found under `User Preferences` under `Terminals&Sets`.

You need the programming template found at the front of this guide. See *A map for using programming on page 23* for more information.

1. Press         .
2. Press      (the default System Coordinator password). **Terminal&Sets** displays.
3. Press . **Show set:** displays.
4. Enter the DN number of the T7316E which is attached to the eKIM you want to program, then press **OK**.
5. Press . **Capabilities** displays.
6. Press  two times until the display shows **User Preferences**.
7. Press . **Model** displays (7316E+<n>KIM).
8. Press . **Button programming** displays.
9. Press the **KIM** softkey for the KIM for which you want to program buttons.

**Note:** If no KIM softkeys appear, it means the KIM was not configured as a CAP in programming.



10. Press  until you find the button you want to program.
11. Press **TEL#** to enter an autodial number, or press **FEATR** to enter a feature code and feature programming. To make the button blank, press **CLR**.



## Monitoring telephones from the KIM

The indicator icons beside the buttons on your KIM show the status of system telephones or lines assigned to the KIM. Refer to *What line indicators mean* on page 44 for a description of the T7316E and KIM icons.

---

## Release button

Pressing  ends a call. You do not have to put the receiver down.  also ends feature programming.

While you are on a call, do not press  to end a feature you are using. If you do, you disconnect the call. Use  instead.





## Hearing aid compatibility

The receivers on all Norstar telephones and Business Series Terminals are compatible with hearing aids as defined in the FCC rules, Part 68, section 68.316. Not all hearing aids are optimized for use with a telephone.

## Viewing information about a call on the display

If you subscribe to Call Display services from your local telephone company, one line of information about an external caller is displayed after you answer. Depending on the setting, and the external information available, either the caller's name or telephone number is displayed.

When you transfer an external call to another Norstar user, this information is displayed on the target telephone.

Call Display information becomes available between the first and second ring of an incoming call. If you answer before the Call Display information is available on your display, and you press    , you see only the line number or line name.

To use logging features with Call Display, see *Using Call Log* on page 137.

## Using Call Information for a particular call

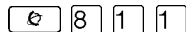

Call Information allows you to see information about incoming calls. This information is more detailed than the Call Display information you can receive automatically. For external calls, you can display the name of the called-party telephone, telephone number, and the line name. For an internal call, you can display the name of the called-party telephone and the internal number of that telephone. You can see information for ringing, answered, or held calls.

Call Information is available for calls even if they have been transferred, forwarded or rerouted in some way.

Names and numbers for external calls are displayed only if you have subscribed to Call Display services from your telephone company.



**Tip** - *Call Log displays the same information as Call Information, along with the date and time of the call, and the number of times the caller called.*

Once you answer a call, new calls coming in on lines configured with CLID to telephones with CLID allowed, present the prompt: **LineXXX Calling** for two rings, and then the CLID of the caller will display for three seconds (XXXXXX).





If the call is being forwarded, the CLID will also display the number from which the call was forwarded (XXXXXX>YYY).





This transient prompt will disappear if you press a programmed feature key, external autodialer, answer key, feature key, line key, intercom key, any dialpad key, shift key (M7310), or handsfree key. As well, an incoming Priority call or Voice call will clear the display and display the information for the Priority or Voice call.







## Displaying Call Information before or after answering

To find out who is calling or to display information about your current call:





1. Press    .
2. Press  or VIEW to display more information about an external call.

Call Display information becomes available between the first and second ring of an incoming call. If you answer before the Call Display information is available on your display, and you press    , you see only the line number or line name.

## Displaying Call Information for a call on hold

1. Press    . The display reads **Select a call**.
2. Select the line on hold. Information about the call is displayed.
3. Press  or VIEW to display more information about an external call.



**Tip** - *If your telephone automatically displays Call Display information for a call, you still need to press     before you can press  or VIEW to display more information about the call.*

## Making Call Display information appear automatically

Each telephone that rings for an external line can display Call Display information for that line. After the call is answered, Call Display information is always shown at the telephone that answered the call. Your installer or customer service representative can program telephones to have automatic Call Display.

This feature is not available to ISDN terminals.

## Changing which information is shown first about a call

Depending on the services you subscribe to, Call Display information may contain up to three parts:

- the name of the caller
- the number of the caller
- the name of the line in your system that the call is on.

For each telephone, you can determine which information is displayed first.

You need the programming template found at the front of this guide. See *Getting started with Norstar* on page 13 for more information.

1. Press         .
2. Press      (the default System Coordinator password).
3. Press  and enter the internal number of the telephone you want to program.
4. Press .

5. Press  four times.
6. Press .
7. Choose a setting at **1stDisplay:** using the **CHANGE** button. The choices are **Name**, **Numbr** or **Line**.

You may see **Unknown name** or **Unknown number** on the display if the information is not available from your telephone company. You may see **Private name** or **Private number** on the display if the caller blocks that information.

## Picking up a call ringing at another telephone

You can pick up a call ringing at another telephone by using Directed Pickup or Group Pickup.

### Answering ringing telephones using Directed Pickup

You can answer any telephone that is ringing in your Norstar system, except private lines.

1. Press   .
2. Enter the internal number of the ringing telephone.

To use Call Pickup (Directed Pickup), the telephone must be ringing. If, for example, the auxiliary ringer is ringing, but the call is not ringing at a telephone, the call cannot be answered using Directed Pickup. It must be answered normally at a telephone that has a flashing indicator for the call, or by using Trunk Answer. You can answer a call that is ringing because someone has transferred the call to a telephone and the call is ringing on an intercom button.



**Tip** - *Directed pickup can retrieve calls that are ringing on an Answer DN. While you may enter the internal number of the telephone you hear ringing, it may be calls from another telephone you are answering.*



### **Privacy issue**

Target lines can be designated as Private (default is Public), however, such features as Call Pickup can still answer these lines at remote telephones. Only physical, analog lines set to Private are blocked from Call Pickup.

## **Answering any ringing telephone using Group Pickup**

Your Norstar system can be divided into nine pickup groups. If you are a member of a pickup group, you can pick up a call that is ringing at any telephone in your pickup group.

1. Press   .

Group Pickup cannot be used to retrieve a camped call.

If there is more than one incoming call at a telephone in a pickup group, a call ringing on an external line is answered first, followed by calls on the prime line and, finally, calls on internal lines.



**Tip** - *A Hunt Group call ringing at a Norstar set DN that is also a member of a call pickup group can be picked up by any Norstar set in that call pickup group. For more information about Hunt Groups, see Programming Hunt Groups on page 169.*

## Changing a telephone pickup group

Telephones can be put into and taken out of pickup groups.

You need the programming template found at the front of this guide. See *Getting started with Norstar* on page 13 for more information.

1. Press         .
2. Press      (the default System Coordinator password).
3. Press  and enter the internal number of the telephone you want to program.
4. Press  twice.
5. Press  five times.
6. Press **CHANGE** at **PICKUP GRP:** to assign the telephone to pickup group (1-9) or remove it from a pickup group (**None**).

### Displays

**Already joined**

You are already connected to the telephone that made the call you are trying to pick up. This can happen if you are on a call to a co-worker and your co-worker dials the number of a telephone in your pickup group, and you attempt to pick up that call.

**Pickup denied**

There is no call that you can pick up or the ringing call was answered.

You have tried to pick up a call on someone else's private line.

**Pickup:**

Enter the internal number of the telephone that is ringing. (You may use an internal autodial button to do this.)

If you decide not to answer a ringing call after activating Directed Pickup, press .

## Trunk Answer

The Trunk Answer feature allows you to answer a ringing call anywhere in the system from any telephone in the system. The line you are answering does not have to appear or ring at the telephone you are using.

Trunk Answer works only with calls that are ringing on lines for which a Ringing Service schedule is active and if Trunk Answer is enabled by your installer or customer service representative.

## Answering a call using Trunk Answer

Press  8 0 0.



**Tip** - *If there is more than one incoming call on lines in a Ringing Service, the Trunk Answer feature picks up the external call that has been ringing the longest.*

### Displays

Line denied

You have tried to pick up a call on someone else's private line.

Pickup denied

The call that is ringing is on a line that is not in a Ringing Service.

---

## Answer DNs and Answer keys

You can use an Answer DN button to monitor calls on another telephone. The calls that come to the monitored telephone that provide an appearance on the Answer DN button are determined by the system-wide Anskey setting.

Answer DN buttons are useful for attendants who monitor incoming calls for one or several other people. For example, a secretary may have appearances for three different bosses on her answer buttons. Once a call for boss A is answered by the secretary, the appearance stops at that set. This allows for another (simultaneous) call to come in on the same line. The same is true for boss B and boss C. When incoming call traffic becomes high, the calls can then be routed to a Hunt Group to optimize call handling. For more information about Hunt Groups, see *Programming Hunt Groups* on page 169.

Answer DNs are assigned under **Terminals&Sets** under **Lines, Line Assgn.** This setting assigns the DN of another telephone to one of your telephone buttons.

Answer keys are assigned under **System Prgrming, Featr settings.** This setting determines which calls will appear at the bottom. There are three levels: Basic, Enhanced, and Extended.

You need an Installer password to do this programming. See the *Modular ICS 6.1 Installer Guide* for more information.

- ISDN terminals cannot be assigned Answer DNs to monitor other telephones, but ISDN terminals can be monitored.
- You cannot make calls using Answer DNs.

If more than one call is ringing at a telephone, the first call appears on the attendant Answer DN button. Any subsequent calls appear on intercom buttons, if they are available.





**Tip** - *More than one attendant may have an Answer DN button for the same telephone. This allows two or more attendants to handle calls for a busy person.*

*Each telephone can handle calls for up to eight other people using a separate Answer DN button for each person.*



## Creating a Conference Call

You can talk to two people at once.

1. Make sure you have two calls, one active and one on hold.
2. Press  .
3. Press the appropriate button to retrieve the held call.

This is automatic on the M7100 and T7100 telephones.

You can create a conference when you are on a call.

1. Make a second call.
2. Press  .
3. Press the button where the first call is on hold to create a conference.

Only the person who established the conference can process the conference by using the procedures described in this section.



**Tip** - *You can create a conference by releasing privacy on a call. See Turning Privacy on or off for a call on page 74.*







## Disconnecting one party

You can disconnect one party from a conference and continue talking to the other.

You can activate this feature on all Norstar and Business Series terminals except for M7100 or T7100 models.

1. Press the line button of the call that you want to disconnect. The call that you want to keep is automatically put on hold.
2. Press . The call is disconnected.
3. Press the line button of the held call to speak to the remaining person.

On a T7100 or on an M7100 set:

1. Press  # 3 , to place one caller on hold. Press  again, to put the caller you want to keep on hold.
2. Press . The call is disconnected.
3. Press  to speak to the remaining party.

## Independently holding two calls

For all telephones except the M7100 and T7100 sets, you can put the two people in a conference call on hold independently so that they cannot talk to each other.

1. Press the line button of one person. The other person is automatically put on hold.
2. Press . The second person is put on hold.

You can re-establish the conference.

1. Take one call off hold.
2. Press  3 .
3. Take the other call off hold.

## Putting a conference on hold

You can put a conference on hold, allowing the other two people to continue speaking to each other by pressing .

You can reconnect to the conference by pressing either of the held line buttons. For the M7100 telephone, press .





## Splitting a conference

You can talk with one person while the other person is on hold.

You can activate this feature on all Norstar and Business Series terminals except for M7100 or T7100 models.

1. Press the line button of the person you want to speak to. The other person is automatically put on hold.

On an M7100 or a T7100 set:

1. Press   . The first party is on hold.
2. Press , if necessary, to switch parties.

You can re-establish the conference.

1. Press  .
2. Take the held call off hold. This is not necessary.

## Removing yourself from a conference

You can remove yourself from a conference, and connect the other two callers through your Norstar system.

1. Enter the Transfer feature code   .

When you remove yourself from a conference using the Transfer feature, and both callers are from outside your system, one of the callers must have called you on a disconnect supervised line, or the call is be disconnected.

## Displays

3 Parties only

You are trying to add a fourth party to your conference call, or to join two conferences together. Release one call from the conference before adding another, or keep the two conferences separate.

Conf. on hold

You have put a conference call on hold.

Conference busy

You have tried to make a conference call, but your system is already handling its maximum number of conference calls.

Line001 221  
TRANSFER





You are on a conference with the two lines or telephones shown. You can drop out of the conference and leave the other two parties connected (Unsupervised Conference) by pressing **TRANSFER** or by entering the Transfer feature code.

Press held line

You have activated the Conference feature with one call active and another on hold. Press the line button for the call on hold to bring that person into the conference.





For other displays, see *Common feature displays* on page 257.

## Listening to a call as a group

To allow people in your office to listen in on a call using Group Listening, press    .

You hear the voice of the caller through the speaker of your telephone. Continue to speak to the caller through the telephone receiver. The microphone of your set is off, so the caller does not hear people in your office.

## Canceling Group Listening

Group Listening is canceled automatically when you hang up or when you press     .



**Tip** - *Keep the receiver away from the speaker, or you may hear feedback. The higher the volume, the more the feedback. Press  to prevent feedback when hanging up.*

## Using handsfree/mute

The ability to use handsfree must be turned on or off for each telephone. The type of handsfree can be changed. Refer to *Changing handsfree for a telephone* on page 72.

Handsfree must be set to **Std** or **Auto** in system programming for a telephone to be able to use a headset. This programming is performed by someone with the Installer password.

If the telephone is set to Auto, the next incoming call defaults to the voice path used by the last call. For instance, if you answered your last call using the headset button, the next call will automatically default to the headset if you do not make any changes before answering the call. If you plug in a

headset, the telephone will automatically switch the voice path to headset. This will not change the mute status of the call. You can also change the voice path by choosing either the handsfree or headset key.

**T7316E voice path features:** The T7316E telephone must be set to **Auto** to allow activate the handsfree, which is located under the dial pad, beside the mute and headset keys.

## Answering calls without lifting the receiver

1. Press the line button for the ringing call.  
This step is not necessary if you have a prime line assigned to your telephone.
2. Press the handsfree button. The internal microphone and speaker of the telephone automatically turn on.

**Note:** The T7316E telephone has a handsfree button located below the dialpad. This button only works if the telephone is wired to a system running version 6.1 or newer software, and **Handsfree** is set to **Auto**.

Handsfree is not available for M7100 or T7100 telephones.



**Tip** - *Direct your voice toward the telephone. The closer you are to the telephone, the easier it is for the microphone to transmit your voice clearly to your listener.*

## Making calls without lifting the receiver

1. Press the handsfree/mute button. If you do not have a prime line assigned to your telephone, press a line button. The internal microphone and speaker of the set are automatically turned on.

**Note:** The T7316E telephone has a handsfree button located below the dialpad. This button only works if the telephone is wired to a system running version 6.1 or newer software, and **Handsfree** is set to **Auto**.

2. Dial your call.
3. Speak normally.

## Muting the set

1. Press the handsfree/mute button to switch off the telephone microphone so that you can speak privately to someone in your office while you are on a handsfree call.
2. Press the button labeled handsfree/mute to turn the microphone back on again and continue your call.

**Note:** The T7316 and T7316E telephones have a mute button located below the dialpad. Refer to the T7316 and T716E user cards for specifics about using this button.

## Changing a regular call to handsfree

1. Press the handsfree/mute button.

**Note:** The T7316E telephone has a handsfree button located below the dialpad. This button only works if the telephone is wired to a system running version 6.1 or newer software.

2. Hang up the receiver.

---

## Changing a handsfree to a regular call

Lift the receiver.

### Using handsfree

On models with separate handsfree and mute buttons:

- The indicator next to the handsfree button is solid when you handsfree is active and off when the telephone is set to handset or headset.
- The indicator next to the Mute button blinks when you mute the microphone and turns off when the microphone is open.

**Note:** Other models of telephones have only one button for both functions. In this case, when the telephone is on handsfree and the microphone is on, the light is solid. If the telephone is on handsfree and the microphone is off (mute), the light flashes.

Wait for your caller to finish speaking before you speak. The microphone and speaker cannot both be on at once. The voice of your caller may be cut off if you both speak at the same time. Noises such as a tapping pencil could be loud enough to turn on your microphone and cut off the incoming sounds.

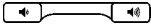
To prevent a possible echo, keep the area around your telephone free of paper and other objects that might screen your microphone. Turning down the microphone volume — press the left end of  while speaking — prevents echoes. When you change the volume level, both the microphone and speaker volume are adjusted. This is needed in order to prevent feedback problems.

Place the telephone so that any unavoidable local noise, such as an air conditioner, is behind it. This limits the amount of disruptive background noise.



**Tip** - *In open-concept environments, use the receiver when handsfree communication is not necessary or when you need privacy during a call. Another option is to use a headset.*

## Changing handsfree for a telephone

You can program the type of handsfree used with each telephone or activate handsfree answerback.

You need the programming template found at the front of this guide. See *Getting started with Norstar* on page 13 for more information.

1. Press  \* \* 2 6 6 3 4 4 .
2. Press      (the default System Coordinator password).
3. Press  and enter the internal number of the telephone you want to program.
4. Press  twice.
5. Press  three times.
6. Choose a setting at **Handsfree:** using the **CHANGE** button.

There are three ways to set handsfree for a telephone:

Handsfree:None  
CHANGE

Handsfree is not available to the telephone.

Handsfree:Std  
CHANGE

A standard version of handsfree described *Using handsfree/mute* on page 68. Not available for T7316E telephones.



**Need Handsfree**

This prompt appears if you attempt to use handsfree or headset and the telephone not been configured with **Auto** under **Handsfree**.

**Handsfree:Auto  
CHANGE**

You can make or answer a call without having to pick up the receiver or press the button marked handsfree/mute. The internal microphone of the telephone and the speaker turn on automatically when you press a line or intercom button to make or answer a call.

For other displays, see *Common feature displays* on page 257.

Both **Auto** and **Standard** handsfree allow you to use a headset with a Norstar telephone or a **Business Series Terminal**.

A handsfree/mute button is automatically assigned to a Norstar telephone that is programmed with handsfree and is always located in the lower right-hand corner of the numeric dialpad.

For T7208 and T7316 telephones, this button is a handsfree-only button. The mute button is located under the dial pad.

The handsfree setting for T7316E only displays **Auto** or **None**. The handsfree button on this telephone is located under the dialpad. If **Handsfree** is set to **None**, the handsfree button does not function. Also, if the T7316E is attached to a system with software older than version 6.1, it acts like the T7316 telephone, and the handsfree button is not active.

## Handsfree Answerback

Handsfree Answerback allows you to answer a voice call without lifting the receiver.

This feature is always turned off for M7100 or T7100 telephones.

You can turn handsfree answerback on or off for a telephone that is programmed to use handsfree.

You need the programming template found at the front of this guide. See *Getting started with Norstar* on page 13 for more information.

1. Press         .
2. Press      (the default System Coordinator password).
3. Press  and enter the internal number of the telephone you want to program.
4. Press  twice.
5. Press  four times.
6. Choose a setting (Yes or No) at **HF answerback:** using the **CHANGE** button.

## Turning Privacy on or off for a call

Lines in your system can be configured to have automatic privacy. If a line is not programmed with privacy, anyone with the line assigned to their telephone can join your call by pressing the line button. If a line is programmed with privacy, only one person at a time can use the line.

Privacy control cannot be used on internal or conference calls.

When another telephone joins a call, the participants on the call hear a tone, and a message appears on the Norstar display. You cannot join a call without this tone being heard.

## Creating a conference by releasing privacy

If a line is programmed with privacy, you can turn privacy off to allow another person with the same line to join in your conversation and form a conference. All the rules applicable to a conference apply except there is only one line in use, instead of the usual two. This means that you cannot split a conference set up using Privacy.

1. Press   .
2. Tell the other person to press the line button and join your conversation.

Only two Norstar or Business Series Terminal telephones, in addition to the external caller, can take part in this kind of conference.

## Making a call private

If a line is programmed not to have privacy, you can turn privacy on for a call, preventing other people with the same line from joining your conversation.

## Checking call length using Call Duration Timer

With this feature you can see how long you spent on your last call, or how long you have been on your present call.

### Displays

221 02:47

The display shows the last call you made, or the current call, and the total elapsed time.

Line001 01:45

You parked your last call. The display shows the period the call was parked. This display only shows when the call is active at, or has just been released by, your telephone.

## Disconnecting by accident

If you accidentally drop the receiver back into the telephone cradle while answering a call, you can quickly retrieve the call.

Pick up the receiver again or press the button labeled handsfree/mute within one second to be reconnected to your call.

## Time



Use this feature to display the current date and time while you are on a call.

# Making calls

There are many ways to make a call, depending on the programming and the type of call, as follows:

- Pick up the receiver and dial. The Norstar system supports three methods of dialing. See *Changing how you dial your calls* on page 82.
- Pick up the receiver, press a line button, and dial (if the call is not on your prime line).
- Press the button labeled handsfree/mute and dial to talk without using the receiver. See *Using handsfree/mute* on page 68.
- Press the button labeled handsfree/mute, then press a line button, and dial to talk without the receiver if the call is not on your prime line.
- Press a line button and dial to talk without the receiver if Automatic handsfree is assigned to your telephone.
- Use one of the features that make dialing easier. See *Time savers for making calls* on page 87.

## Displays

221 busy  
PRIORITY            LATER

The telephone you have called has no internal lines available. Press LATER to use the Ring Again or Message features or press PRIORITY to make a priority call.

9\_  
QUIT            BKSP

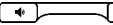
You are dialing using Pre-dial. To erase an incorrect digit, press the left end of  or BKSP. When the number is complete, select a line or lift the receiver.

95551234  
                                 TRANSFER

This prompt remains on your display as long as you are on a call you have dialed. To transfer the call, press TRANSFER.

Already joined	Your telephone is already connected to the telephone you are trying to call. Check your active line buttons, and return to that call.
Calling 221 PRIORITY      LATER	Wait for the telephone to be answered. If no one answers, press <u>LATER</u> to use the Ring Again (page 85) or Message (page 128) feature, or press <u>PRIORITY</u> to make a priority call.
Can't ring again	You cannot use Ring Again on your current call. You can only use Ring Again while you have a busy signal on an internal call or line pool request or while an internal call is ringing.
Do not disturb PRIORITY      LATER	The telephone you are calling has Do Not Disturb turned on. Press <u>LATER</u> to use the Ring Again or Messages features, or press <u>PRIORITY</u> to make a priority call.
Expensive route	You have dialed a number, but the least expensive route that the system is programmed to use is busy. Unless you release the call, it goes through on a more expensive route.
Hidden number	The last number you dialed or the number you saved for Saved Number Redial was a speed dial number that displayed a name rather than the number. The number is dialed correctly, but you cannot see it.
Line denied	You have attempted to use the private line assigned to another user.
Line001 TRANSFER	Enter the digits of the number you want to dial.
No last number	You have not dialed an external telephone number since the last power interruption or system reset.
No line selected	Either you have no prime line or your prime line is busy. Select a line manually before dialing.
Not in service	You have entered the number of a telephone that is not in service.

On another call  
LATER

The telephone you have called is on another call. Press LATER to use the Ring Again or Message features.

Restricted call

The call you are trying to make has been restricted in programming. A possible reason is time-of-day restrictions on certain calls.

Ring Again?  
YES NO EXIT

Press YES to use Ring Again. Press NO to send a message. See *Sending messages* on page 128 and *Turning on Ring Again* on page 86.

Select a line

Either you have no prime line, or the prime line is in use, or the line programmed for an autodial number, speed dial number, or Hotline is in use. Select a line and dial again.

Send message?  
YES NO

Press YES to send a message. See *Messages*.

For other displays, see *Common feature displays* on page 257.

## Choosing a line using a line button

You have one line button for each line assigned to your telephone. Press the line button to select the line you want to answer or use to make a call. Having several line buttons allows you immediate access to more than one line.

The M7100 and T7100 telephones each have two intercom paths which are used instead of line buttons to answer and make calls. Each set can be assigned two lines. You can press  to switch between two calls, one active and one on hold.

## Line pools

A line pool is a group of external lines that can be shared by many telephones. You can use a line in a line pool to make an external call.

The MICS system can have 15 non-PRI line pools and a maximum of four PRI line pools, depending on the hardware and profile configuration for your system. A telephone can be programmed to access any number of line pools. You can have several different line pools for your system, each one giving you access to a different set of external lines. It is one way of sharing lines across telephones in a system.

A line pool access code is a number you dial to get a non-PRI line pool. The access code can be up to four digits long. Your installer or customer service representative programs the line pool access codes and gives each telephone access to a line pool.



PRI line pools are accessed using destination codes. Destination codes differ from line pool codes, in that PRI line pools are assigned to specific routes that are then assigned a destination code. Destination codes can also be assigned to schedules, so that different pools are used at different times of the day.

Everyone in the office should have a list of the line pool access codes and destination codes for the line pools their telephones can use.



## Using a line pool to make a call

Use this process to make a line pool call:

1. Press   .
2. Enter a line pool access code or destination code.

If you have a free internal line, you can make a call using a line pool without entering the feature code first.

1. Select an internal line (intercom).
2. Dial the line pool access code or destination code.



**Tip** - *If no lines are available in the line pool, you can use Ring Again at the busy tone. You are notified when a line in the line pool becomes available. See Using Ring Again on page 85.*

## Programming a memory button with a line pool

When you program a button with the line pool feature code, you must enter a line pool access code or destination code after the feature code. The programmed line pool button accesses a specific line pool, not the line pool feature. See *Programming feature buttons* on page 147 for more information.







If you program a button with an indicator to access a line pool, when all the lines in a line pool are busy, the indicator for the line pool button turns on. The indicator turns off when a line becomes available.

## Making calls from an ISDN terminal

ISDN terminals do not have line keys or intercom keys as do Norstar telephones. To make an outgoing call from an ISDN terminal, access an external line by entering a line pool code or by using the ARS feature.

## Changing how you dial your calls

To change how you dial your calls, use this feature:

1. Press    .
2. Press  or **NEXT** until the dialing mode you want appears.
3. Press  or **OK** to select the displayed dialing mode.

The dialing modes feature code cannot be programmed onto a memory button.

## Using Standard dial

Standard dial allows you to make a call by selecting a line and dialing the number. If you have a prime line, it is selected automatically when you lift the receiver or press the handsfree button.

You cannot use Standard dial on an M7100 or a T7100 telephone unless you pick up the receiver first. If you have this type of telephone, use the Automatic dial or Pre-dial feature for on-hook dialing.

## Using Automatic dial

Automatic dial allows you to dial a number without selecting a line. Your prime line is selected as soon as you start dialing a number.

Automatic dial does not work if your telephone has no prime line or if your prime line is in use.

Telephones connected to an analog terminal adapter (ATA) cannot use Automatic dial.

## Using Pre-dial

Pre-dial allows you to enter a telephone number, check it, then change it before actually making the call. The call is not dialed until you select a line or line pool, or pick up the receiver. You can pre-dial both external and internal numbers. You must, however, select the correct type of line (external or internal) for the type of number you entered.



**Tip** - *If your telephone starts ringing while you are pre-dialing a number, you can stop the ringing by turning on Do Not Disturb (☎ 8 5). This does not affect numbers you are entering.*

*You cannot pre-dial a telephone number if all the lines on your telephone are busy.*

## When the internal number you called is busy

There are a couple of methods you can use if the telephone you are calling is currently busy.

### Priority Call

If you get a busy signal or a Do Not Disturb message when you call someone in the office, you can interrupt them. Use this feature for urgent calls only.



**Tip** - Priority calls cannot be made to Hunt Group DNs. For more information about Hunt Groups, see *Programming Hunt Groups* on page 169.

## Making a priority call

1. Press   .
2. Wait for a connection, then speak.

A person who receives a priority call while on another call has eight seconds to accept or block the call. For information about blocking calls, see *Stopping calls from ringing at your telephone: Do Not Disturb (DND)* on page 200. If the person does nothing, the priority call feature puts their active call, including conference parties, on Exclusive Hold and connects your call.

## Giving a telephone the ability to make priority calls

You need the programming template found at the front of this guide. See *Getting started with Norstar* on page 13 for more information.

1. Press         .
2. Press      (the default System Coordinator password).
3. Press  and enter the internal number of the telephone you want to program.
4. Press  twice.
5. Press  nine times. The display shows **Priority call:**.

## 6. Press CHANGE to choose Y (Yes) or N (No)

### Displays

Call blocked

You tried to place a priority call to another Norstar telephone. The person you called has blocked your call. Try to call later.

Please wait

The party you are calling has eight seconds to decide whether to accept or reject your priority call.

Priority denied

The telephone you are calling has already received a priority call or is unable to receive priority calls.

You can make a priority call only while your telephone displays:

221 busy

PRIORITY

LATER

The set you are trying to call has call on all assigned lines.

Calling 221

PRIORITY

LATER

Do not disturb

PRIORITY

LATER

The set you are trying to call has the Do Not Disturb feature activated.

On another call

PRIORITY

LATER

The set you are trying to call is busy because the person is on another line.

## Using Ring Again

Use Ring Again when you call someone on your Norstar system and their telephone is busy or there is no answer. Ring Again can tell you when they hang up or next use their telephone. You can use Ring Again to tell you when a busy line pool becomes available.



**Tip** - *The Ring Again feature cannot be used when calling a Hunt Group DN. For more information about Hunt Groups, see Programming Hunt Groups on page 169*

## Turning on Ring Again

1. Press   before you hang up.

Using Ring Again cancels any previous Ring Again requests at your telephone.

## Canceling Ring Again

1. Press    to cancel a Ring Again request.

### Displays

Can't ring again

You cannot use Ring Again on your current call. You can only use Ring Again while you have a busy signal on an internal call or line pool request, or while an internal call is ringing.

Ring Again?  
YES      NO      EXIT

Press YES to use Ring Again. Press NO if you prefer to send a message.

# Time savers for making calls

## Storing a number on a memory button for Autodial

You can program memory buttons for one-touch dialing of internal or external telephone numbers.

Buttons used for lines, answer DNIs, or handsfree/mute cannot be used as autodial buttons.

If the power to your Norstar system is off for more than three days, autodial numbers, and some other system programming, may be lost from the memory.

### Adding an autodial button

Use these features to program external and internal numbers.

1. Press    to program an external number.

Press    to program an internal number.

2. Choose a button and then enter the number as if you were dialing it.

When programming Autodial you can use:

- Last Number Redial
- Saved Number Redial
- destination codes — use the Intercom line as the line
- host system signaling

## Choosing a line for Autodial

To include a line selection for an external number, press the line or intercom button before you enter the number. To select a line pool, press a programmed line pool button, or press the button labeled Intercom and enter a line pool access code.

If you select a line before pressing the autodial button, the call goes out on the line you have selected instead of the line that is part of the autodialer programming.

For the M7100 and T7100 telephones, an external autodialer can be programmed only by using a line and not a line pool.





**Tip** - *If you do not include a line selection in an autodial number, the call uses your prime line (if you have one).*

## Using intercom as the line for Autodial

If you press the Intercom button as the line for an external autodial number, you must include a valid line pool access code or a destination code. If line pool access codes or destination codes are changed, remember to reprogram autodial numbers.

### Displays



987\_   
 QUIT BKSP OK

Continue to enter digits until the number is complete. Press  or  or **BKSP** to erase an incorrect digit. Press  or **OK** when you are finished.

Autodial full

The memory allotted to autodial numbers in your Norstar system is full.



Button erased	While programming external Autodial, you erased the button by pressing  or <u>OK</u> before entering any digits.
Enter digits QUIT OK	Enter the number you want to program. Choose the line first, if necessary, then enter the number exactly as if you were making a call.
Intercom #: _ QUIT	Enter the internal telephone number you want to program.
Invalid number	You are programming an internal autodial button and have entered a number that is not an internal number on your system.  Enter a valid internal number.  If the number you are entering is a destination code, use external autodial.
Press a button QUIT	Press the memory button you want to program.
Program and HOLD	Enter the number you want to program onto the button, then press  .
Program and OK QUIT OK	Enter the number you want to program onto the button, then press  or <u>OK</u> . You may include a line or line pool selection in an autodial sequence by selecting the line before entering any digits.
Programmed	The number is stored on the button.

For other displays, see *Common feature displays* on page 257.

## Using Last Number Redial

Press   to redial the last external number you dialed.

Last Number Redial records a maximum of 24 digits.



**Tip** - If you have a programmed Last Number Redial button, you can use Button Inquiry (    ), then press the Last Number Redial button followed by (  ) to check the last number before you dial it.

## Preventing a telephone from using Last Number Redial

Last Number Redial can be restricted at individual telephones.

You need the programming template found at the front of this guide. See *A map for using programming* on page 23 for more information.

1. Press         .
2. Press      (the default System Coordinator password).
3. Press  and enter the internal number of the telephone you want to program.
4. Press .
5. Press  three times. The display shows **Restrictions.**
6. Press  twice.
7. Press . The display shows **Allow last no.:**
8. Press **CHANGE** to choose Y (Yes) or N (No).

## Displays

Hidden number

The last number you dialed was a speed dial number that displayed a name rather than the number. The number is dialed correctly, but you cannot see it.

No last number

You have not dialed an external telephone number since the last power interruption or system reset.



**Tip** - You can copy a number onto an autodial button using Last Number Redial.

## Using Speed Dial

Norstar provides two types of speed dialing: system and personal.

- **System Speed Dial** programming allows you to assign a maximum of 255 three-digit speed dial codes (001-255) to the external numbers your co-workers call most frequently.
- **User Speed Dial** programming allows individuals to program a maximum of 24 speed dial numbers that are personal to their telephone. These numbers also have three-digit codes (256-279)



Speed dial numbers are subject to the same restriction filters as regularly dialed numbers. Your installer or customer service representative can program system speed dial numbers to bypass dialing restrictions.

Speed dial numbers may include host system signaling codes.

## Making a speed dial call



**Tip** - There is no difference between using User Speed Dial and using System Speed Dial. They differ only in how you program them.





1. Press   to quickly dial external telephone numbers that have been programmed onto speed dial codes.
2. Enter the appropriate three-digit speed dial code.

## Changing and adding System Speed Dials





The system coordinator assigns numbers to System Speed Dial codes for the entire system. See *Adding or changing a system speed dial* on page 31.

## Adding or changing User Speed Dial

To add or change a User Speed Dial number on your telephone:

1. Press   .
2. Enter a three-digit code from 256 to 279 that you want to associate with a telephone number.
3. To include a line selection for this number, press the line or intercom button. To select a line pool, press a programmed line pool button, or press the Intercom button and enter a line pool access code.  
For the M7100 and T7100 sets, you can select only a line pool.
4. Enter the number you want to program.
5. Press  or OK.

## Displays

<pre>01:9_ CANCL  BKSP  OK</pre>	<p>Continue entering the number you want to program. You can change the number by pressing <b>BKSP</b> or  . When you are finished, press  or <b>OK</b>.</p>
<pre>Enter digits QUIT      OK</pre>	<p>Enter the telephone number you want to program exactly as if you were dialing it normally. When you are finished, press  or <b>OK</b>.</p>
<pre>Invalid code</pre>	<p>You have entered a code outside the code range (001-255 for system, 256-279 for user codes).</p>
<pre>No number stored</pre>	<p>There is no number stored on the speed dial code you have dialed.</p>
<pre>Program and HOLD</pre>	<p>If you want to program a line or line pool selection for this speed dial number, select the line or line pool. Otherwise, enter the telephone number exactly as if you were dialing it normally. When you are finished, press .</p>
<pre>Program and OK QUIT      OK</pre>	<p>If you want to program a line or line pool selection for this speed dial number, select the line or line pool. Otherwise, enter the telephone number you want to program exactly as if you were dialing it normally. When you are finished, press <b>OK</b>.</p>
<pre>Select a line</pre>	<p>There is no line associated with the speed dial number you are trying to use. Select a free external line or line pool and enter the speed dial feature code again.</p>
<pre>Unknown number</pre>	<p>The system cannot dial the number stored. Reprogram the number.</p>

For other displays, see *Common feature displays* on page 257.

## Using Saved Number Redial

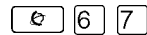

You can use this feature while you are on an external call that you dialed to save the number so that you can call it again later.

Each telephone can save one number at a time with Saved Number Redial, not one number for each line.





**Tip** - You can copy a number onto an autodial button using Saved Number Redial.

Saved Number Redial records a maximum of 24 digits.

### Dialing a saved number

Press    when you are not on a call.

If you have a programmed Saved Number Redial button, you can use Button Inquiry (  ) to check the last number before you dial it.

## Blocking Saved Number Redial

Saved Number Redial can be restricted at individual telephones.

You need the programming template found at the front of this guide. See *A map for using programming* on page 23 for more information.

1. Press         .
2. Press      (the default System Coordinator password).
3. Press  and enter the internal number of the telephone you want to program.
4. Press .
5. Press  three times. The display shows **Restrictions.**
6. Press  twice.
7. Press  twice. The display shows **Allow saved no.:**
8. Press **CHANGE** to choose **Y** (Yes) or **N** (No).

### Displays

Hidden number

You have saved a speed dial number that displays a name rather than the number. The number is dialed correctly, but you cannot see it.

No number saved

You have tried to save the number of an incoming call. You can only save numbers that you have dialed yourself.





# Handling many calls at once

## Using Hold

You can temporarily suspend a call by pressing .

When a call is on hold, its indicator flashes on all telephones that have access to the line. The call can be retrieved from any of these telephones.

On the M7100 and T7100 sets,  alternates between two lines. One line is active, the other is on hold. These sets cannot retrieve a call placed on hold by another telephone.



**Tip** - Answered Hunt Group calls can be placed on hold at the answering telephone. For more information about Hunt Groups, see *Programming Hunt Groups* on page 169.

## Retrieving a held call

You can connect to a call on hold by pressing the flashing line button of the held call.

## Holding automatically

If your line has been programmed with full autohold, you can switch from one call to another and have your calls put on hold automatically.

Press the line button of the caller to whom you want to speak. Your current caller is put on hold automatically.

## Listening on hold

If you have been put on hold, you can hang up the receiver while you wait for the other person to return.





1. Press .
2. Hang up the receiver.
3. Press the line button of the call. You may hear indications from the far end that you are on hold, for example, tones or music.
4. When the person you were talking to returns, you hear them through your telephone speaker. Lift the receiver and talk.



**Tip** - *If Automatic handsfree has been assigned to your telephone, you can use the handsfree/mute feature instead of Listen on Hold.*

## Holding a call exclusively

You can put a call on Exclusive Hold so that it can be retrieved only at your telephone.

Press    or  . The line appears busy on all other telephones, and the call cannot be picked up by anyone else in the office.

### Displays

On hold: LINENAM

You have placed one or more calls on hold. The name of the line that has been held the longest is displayed.

---

## Using Call Queuing

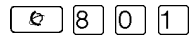

If you have more than one call ringing at your telephone, use this feature code to choose the call that has the highest priority.

Call Queuing answers incoming external calls before callback, camped, and transferred calls.







# Transferring calls

## Using the transfer feature

Transfer allows you to direct a call to a telephone in your Norstar system, within the network, or external to the network.

### Transferring a call

1. Press   .
2. Call the person to whom you want to transfer the call.
3. If you want to talk to the person to whom you are transferring the call, wait for them to answer, then speak to them before proceeding.
4. When you are ready to complete the transfer, press  or **JOIN**.

You cannot use Last Number Redial, Saved Number Redial, a speed dial code, Priority Call or Ring Again to dial the number for a transfer.

Depending on how a private network call is routed, it may not always be possible for the system to return a transferred call to you if the transferred call is not answered. When transferring a call to a private network destination, stay on the line until the person to whom you are transferring the call answers.

You cannot use the Line Pool feature code to access a line pool for a transfer. To use a line pool, use a programmed line pool button, or press the key labelled Intercom and enter a line pool access code or a destination code.

If you have an auxiliary ringer programmed to ring for calls on an external line, and you transfer a call on that line without announcing the transfer, the auxiliary ringer rings for the transferred call.

## Transferring external calls

If an external call is transferred to a busy telephone, or not answered after a few rings, the call automatically rings again at the telephone from which it was transferred, and the display indicates that the telephone was busy or that no one answered.

When transferring an external call to an external number, the external call you are trying to transfer must be an incoming call on a disconnect supervised line.





While on a conference call, you can remove yourself from the conference and connect the other two callers using the Transfer feature. However, if both of the other people are from outside the system, at least one of the outside callers must have called you and both of the outside calls must be on disconnect supervision lines.

**Note:** Transfer via Hold on DID lines is not supported. Once a call is answered, the line appearances on all other sets are free immediately to take other calls. This allows a greater number of calls to be received. Use the Call Park feature to transfer a call.

In certain situations, you may experience lower volume levels when transferring an external call to an external person, or when transferring two external callers from a conference call.

## Canceling a transfer

You can reconnect to the person you are trying to transfer at any time before the transfer is complete.

1. Press     or **CANCL**.
2. If you are not reconnected to your original call, press  and then press the line key of the original call, which is now on hold.

### Displays





```
221>222
CANCL  RETRY  JOIN
```

You are talking to the person you want to transfer the call to. Press **RETRY** if you decide to transfer the call to someone else. Press  or **JOIN** to transfer the call.

```
221 no reply
          CALLBACK
```

The person to whom you tried to transfer a call did not answer. Press **CALLBACK** or the flashing line button to reconnect to the call. On the 7100 telephones, lift the receiver.

```
Do not disturb
CANCL  RETRY  JOIN
```

The person to whom you tried to transfer a call has Do Not Disturb active on their telephone. Press **JOIN** to transfer the call anyway. Press **RETRY** to transfer the call to someone else. Press **CANCL** or the flashing line button to reconnect to the call (on M7100 or T7100 telephones, press    ).

```
Invalid number
CANCL  RETRY
```

You entered an invalid internal number. Press **RETRY** and enter the number again.

```
Line001 hung up
```

The external caller you were transferring hung up before the transfer was complete.

```
Line001>221
CANCL  RETRY  JOIN
```

Press **JOIN** to transfer the call on line 001 to telephone 221. Press **RETRY** if, after talking to the person at extension 221, you decide to transfer the call to someone else.

```
Not in service
CANCL  RETRY
```

The telephone to which you are trying to transfer a call is out of service.

```
Restricted call
CANCL  RETRY
```

You cannot transfer the call because of telephone or line restrictions.

Still in transfer  
CANCL RETRY

Complete the transfer in progress before you access a new feature, answer another alerting call, or select an outgoing line.

Transfer denied  
CANCL RETRY

Your transfer cannot be completed for one of these reasons:

- All the resources needed to perform a transfer are in use. Try again later.
- You have tried to transfer an external call to another external party. Some restrictions apply.
- You cannot transfer a conference call.



Transfer to:2  
CANCL RETRY

Press RETRY if you entered the wrong internal number or if the person to whom you are transferring the call is unavailable.

For other displays, see *Common feature displays* on page 257.

## Using Camp-on

You can transfer an external call to another telephone within the system, even if all of its lines are busy.

1. Press   .
2. Dial the number of the telephone you want to camp the call to.

Camped calls appear on a line button on the receiving telephone, if one is available. If there is no line button available, you receive a message on the display and hear Camp tones.

Each set can handle only one camped call at a time.



## Displays

221 Camp max  
CALLBACK

You tried to camp a call to a telephone that already has a camped call. The call has come back to you. Press the CALLBACK button or the line button to reconnect to the call.

On M7100 or T7100 telephones, just pick up the receiver.

221 DND  
CALLBACK

The person to whom you redirected a call has Do Not Disturb active on the telephone. The call has come back to you. Press the CALLBACK button or the line button to reconnect to the call. On M7100 and T7100 telephones, just pick up the receiver.

Camp denied

You have tried to camp an internal call. You can only camp external calls.

Camp to:  
CANCL

Dial the number of the internal telephone to which the call is sent.

Camped: 221  
CALLBACK

The telephone to which you camped a call did not answer the call. The call has come back to you. Press CALLBACK or the line button to reconnect to the call. On M7100 or T7100 telephones, just pick up the receiver.

Line001 hung up

A call you camped has come back to you, but the caller hung up before you could reconnect.

Not in service  
CALLBACK

The telephone to which you have camped a call is out of service or is being used for programming. The call has come back to you. Press CALLBACK or the line button to reconnect to the call. On M7100 or T7100 telephones, just pick up the receiver.

Release a call

The line that the camped call is on is in use or that line does not appear at your telephone. Release the line or release an internal line.

For other displays, see *Common feature displays* on page 257.

## Parking a call

You can suspend a call so that it can be retrieved from any telephone in your system.

1. Press   .
2. Use the Page feature (  ) or press **PAGE** to announce the retrieval code displayed by your telephone.

### Retrieving a parked call

1. Select an internal line.  
On M7100 or T7100 telephones, pick up the receiver.
2. Dial the Call Park retrieval code.

### Using Call Park

When you park a call, the system assigns one of 25 codes for the retrieval of the call. These codes consist of the Call Park prefix, which may be any digit from 1 to 9, and a two-digit call number between 01 and 25. For example, if the Call Park prefix is 1, the first parked call is assigned Call Park retrieval code 101. The call park prefix is assigned during system programming. Check your *Modular ICS Programming Record* if you are unsure about what range your system uses.

The Norstar system assigns Call Park codes in sequence, from the lowest to the highest, until all the codes are used. This round-robin approach means that a greater variety of codes are used, which makes it easier for a call to reach the right person when more than one incoming call is parked.

The highest call number, which is made up of the Call Park prefix followed by 25, is used only by T7100/M7100 telephones, analog telephones, or devices connected to the

system using an analog terminal adapter (ATA) or an Analog Station Module (ASM). Analog telephones or devices cannot use the other Call Park codes.

Your installer or customer service representative programs both the Call Park prefix and the delay before parked calls are returned to the originating telephone. External calls parked for longer than the programmed delay are returned to your telephone.



**Tip** - Answered Hunt Group calls are parked in the same manner as other calls. For more information about Hunt Groups, see *Programming Hunt Groups* on page 169.

Call Park can be disabled by your installer or customer service representative.

### Displays

Already Parked

The person you were talking to has already parked your call. You cannot park the same call.

No call to park

You have attempted to use Call Park with no active call on your telephone. If the call you want to park is on hold, reconnect to it before you park it.

Invalid number

You have entered an invalid retrieval code.



No call on: 101

There was no call on the retrieval code you entered.

Park denied

You have tried to park a conference call. Split the conference and park the calls separately. The person who retrieves the calls can reconnect the conference.

Parked on: 402  
PAGE      EXIT

Record the code shown. Use Page (  ) or press **PAGE** to announce the call and its retrieval code.











Parking full

All available retrieval codes are in use.  
Transfer the call or take a message instead.

For other displays, see *Common feature displays* on page 257.

## Using system-wide call appearance (SWCA)

This feature allows a call to maintain an appearance on the System Wide Call Appearance (SWCA) buttons to a group of users for the life of the call. SWCA codes can be assigned to up to 16 program buttons with indicators on each telephone in a group.

See *Programming a feature code onto a memory button* on page 147 for general information about setting or changing key programming for a telephone. SWCA keys can be assigned to memory keys using  \*  to assign the SWCA feature codes:  \*    to  \*   .

Refer to the *Module ICS 6.1 Installer Guide* for information about programming buttons through the programming interface.



**TIPS** - *Telephones without assigned SWCA keys can still retrieve a SWCA call by entering the feature code that was used to park the call, providing that they have a free intercom key with which to accept the call. However, there is no indication on these telephones to show which codes were used to park which call. This information can be communicated by the person who parked the call by using a voice call or by using the Page feature to provide a verbal alert.*

*A call can also be parked on the system by entering a SWCA code, if there are no assigned SWCA user keys on the telephone.*



**Tips** - *Since SWCA keys use the park feature, check with your system administrator to ensure that park is turned on for your system.*

*A SWCA call on park that exceeds the park timeout timer is released from the SWCA button and rings again at the original telephone.*

Each group telephone must either have a line appearance of the call coming in, or a free intercom button to be able to retrieve a SWCA call. The number of SWCA keys that can be assigned will depend on available buttons on the telephone. T7316, T7316E, T7316E+KIM, and T7324 telephones provide the broadest use of this feature since they have the most memory keys with indicators. Companion, M7000/T7000 and M7100N/T7100 telephones do not have line or intercom buttons, therefore, they cannot be assigned SWCA lines.

## Incoming calls

When you answer an external call, the system can react in one of two ways, depending on what settings were specified in system programming:

- the call may be transferred automatically to a free SWCA key when you answer the call. To park the call, and free your line, press the SWCA key or press . The call becomes available to any other telephone that has that SWCA key.

OR

- you may need to press a free SWCA button to transfer the call manually to a SWCA key. In this case, when you transfer the call, the call parks on the line, and the line the call came in on is released.

When you put a call on hold, the system can react in one of two ways if you have SWCA keys defined:

- when you put the call on Hold, the call transfers to a free SWCA key and all the other extensions with corresponding SWCA keys display a flashing indicator beside the button. The call can be picked up at any other extension. If the call automatically transferred to a SWCA key when it was answered, then this option puts the call on hold at the same key.

OR

- when you put the call on Hold, it stays on hold on the line that it came in on. To make the call available to other extensions, press a free SWCA key to transfer the line.

Calls with appearances on SWCA keys show a solid indicator when the call is active. On the extension where the call is active, an Intercom or Line button also becomes active.

**SWCA indicators, call status states (auto assign)**

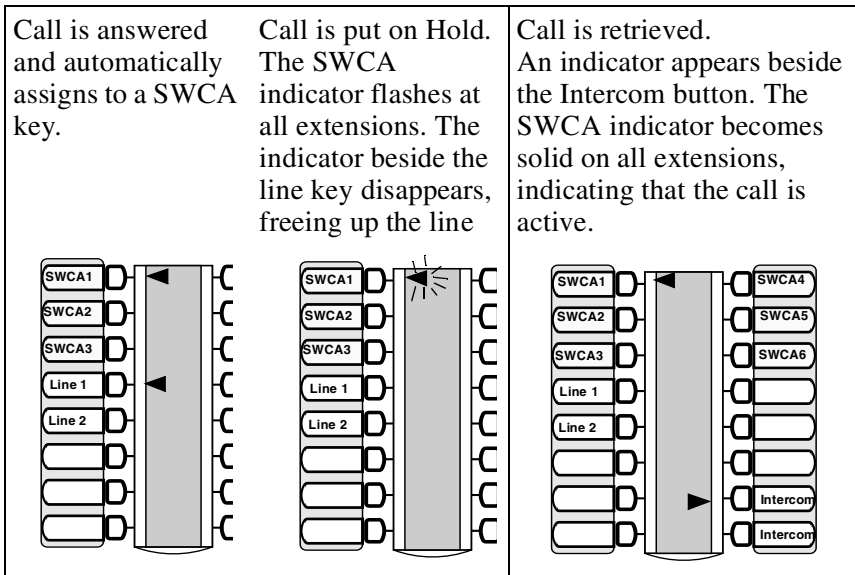

---

## Outgoing calls

When you make an outgoing call using the intercom key on your telephone, the call is automatically transferred to the first available SWCA key. Solid indicators appear beside the intercom button and the SWCA key on your telephone. All other telephones in the group also see a solid indicator beside the SWCA key, indicating that the line for that key is in use. If you put the call on hold (or press the SWCA key), the SWCA key indicator fast-flashes on your telephone, and slow-flashes on the other telephones in the group. The call can then be picked up by any other telephone in the group.

## No free call keys

If all the SWCA keys are currently occupied when a new call comes in, you can still put the call on Hold.

- If a SWCA key has been freed up between the time you answered the call, and when you want to put the call on Hold, the call will transfer to the free SWCA key, or you can manually transfer it to a free SWCA key. The call will act as described in *Incoming calls* on page 109.
- If all SWCA keys are still occupied when you put the new call on Hold, the call will be held at your telephone on the line it came in on. When a SWCA key becomes free, you can take the call off hold and press the free SWCA key so the call has a group-wide appearance.

These principles also apply to outgoing calls.

## Using Callback

When you direct a call you have answered to another telephone, the system monitors the call to make sure it is answered. If no one answers the call within a set length of time, the system directs it back to you.



Callback generates a variety of displays. Most occur after a set delay and are listed in the index. Some occur immediately if the telephone to which you are directing a call is out of service or otherwise unavailable. These are listed with the descriptions of the specific features such as Transfer or Camp-on.



# Forwarding your calls

## Forwarding your calls to another Norstar telephone

Use this feature to forward your calls within your system or network.

1. Press  .
2. Enter the number of the internal telephone to which you want your calls forwarded.

Use Line Redirection to forward calls outside the system. Line redirection takes precedence over Call Forward.





**TIP** - T7316E telephones display this call forwarding icon when a call has been forwarded: 

## Canceling Call Forward

1. Press   .

## Using Call Forward at your telephone

When you use  , all calls go to the destination you select, regardless of how Forward on busy and Forward no answer are programmed.



**Tip** - *If your telephone is a member of a Hunt Group, the Call Forward all calls setting is overridden by the Hunt Group routing for Hunt Group calls. For more information about Hunt Groups, see Programming Hunt Groups on page 169.*

If the telephone to which you forwarded your calls does not have the same external lines as your telephone, the forwarded calls appear on intercom buttons.

If a call is forwarded, it does not ring but the line indicator flashes on your telephone. You can answer the call by pressing the button next to the flashing indicator.



**Tip** - *Beware of creating call-forward loops*

*If you are one of a group of people who regularly forward their calls to one another, be aware that it is possible to set up forward loops where a call is forwarded from one telephone to another in a circle, and is never answered anywhere.*

## Overriding Call Forward

If you call someone who has their calls forwarded to you, your call rings at that telephone even though they are forwarding their calls to you.

---

## Changing the automatic Call Forward settings for a telephone

Call forwarding occurs automatically when a call is not answered or the line is busy. These automatic options are changed in programming.

For step-by-step instructions, see *Change where a call goes when there is no answer* on page 37.

### Changing Forward no answer

Forward no answer redirects unanswered calls to another telephone on your Norstar system.



**Tip** - If the set is a member of a Hunt Group, the Call Forward no answer feature is overridden and the Hunt Group call continues to ring until the hunt time has expired. For more information about Hunt Groups, see *Programming Hunt Groups* on page 169.

Line Redirection takes precedence over Forward no answer.

For instructions for changing Forward no answer refer to *Change where a call goes when there is no answer* on page 37.

### Changing the delay before a call is forwarded

You can assign the number of times that the incoming call rings at your telephone before the call is forwarded. To estimate the delay time in seconds, multiply the number of rings by six.

For step-by-step instructions, see *Change the number of times the telephone rings before it is forwarded* on page 38.

## Forward on busy

Forward on busy redirects your calls to another telephone on your Norstar system when you are busy on a call, or when you have Do Not Disturb activated at your telephone. For step-by-step instructions, see *Making changes to Call Forward No Answer* on page 37.

Line Redirection takes precedence over Forward on busy. Calls that are redirected by Line Redirection are not affected by any Call Forward features or Call Forward programming.

Telephones that have Forward on busy active can receive priority calls. If you are busy on a target line call, another call to that target line is redirected to the prime telephone for that target line.



**Tip** - *If the set is a member of a Hunt Group, the Call Forward on busy feature is overridden and the Hunt Group call continues to ring until the hunt time has expired. For more information about Hunt Groups, see *Programming Hunt Groups* on page 169.*

## DND on Busy

When you are busy on a call and a second call comes in, your telephone rings softly to alert you to the second call. If you find this second ring distracting, you can have the system prevent a second call from disturbing you by assigning Do Not Disturb (DND) on Busy to your extension.

When DND on Busy is turned on for the telephone, internal and private network callers hear a busy tone instead of ringing when you are on the telephone. External callers are transferred to the prime set used in your system. For step-by-step instructions, see *Making Changes to Do Not Disturb on Busy* on page 40.

If you use DND on Busy, the line indicator for an external incoming call flashes, but your telephone does not ring.

Forward on busy takes priority over DND on Busy.

If an external call uses a target line, the call is processed according to the programming of the target line. If the target line is busy, the caller may hear a busy tone or the call may be routed to the prime set for the target line regardless of the DND on Busy programming for the telephone.



**Tip** - *If a telephone is a member of a Hunt Group and the telephone activates this feature, the telephone does not receive notification of incoming Hunt Group calls while on a call. The DND on busy feature overrides the Hunt Group. For more information about Hunt Groups see Programming Hunt Groups on page 169.*

## Call Forward and Voice Mail

If you want a voice mail system to pick up unanswered calls automatically, do either of the following:

- use the internal number of your voice mail as the destination when you program Forward no Answer and Forward on busy

Note: If the voice mail hardware is attached to another system on the private network, the forwarded number for the voice mail system will be an external number on all systems in the network, except the one to which the voice mail system is directly connected.

- make the ring delay greater than the delay used by your voice mail system, if your voice messaging system or service automatically retrieves calls

## Displays

Forward denied

There are several reasons why you may get this message. For instance, you cannot forward your calls to a telephone that has been forwarded to your telephone.

Forward>221

CANCL

Your calls are being forwarded to telephone 221.

Not in service

Two or more telephones are linked in a forwarding chain, and one of them is out of service or is being used for programming.

For other displays, see *Common feature displays* on page 257.

## Line Redirection

Line Redirection allows you to send your external calls to a telephone outside the office. You may choose to redirect all your external lines or only some of them.

Line Redirection takes precedence over the Call Forward feature. If both features are active on a telephone, incoming external calls on redirected lines are routed to the specified Selective Line Redirection (SLR) external destination. Incoming internal calls are forwarded to the specified Call Forward destination.

You cannot use the Line Redirection feature on an M7100 or a T7100 telephone, or on a telephone connected to an ATA.

### Turning on Line Redirection



Follow these steps to turn on Line Redirection:



1. Press  8 4 .
2. Select the outgoing line to be used for redirected calls.
3. Enter the number to which calls are redirected.

Refer to the list below for suggestions.

4. Select the lines to be redirected.

In step 3, you can enter the telephone number to which you want to redirect calls, using one of the following methods:

- Press an external autodial button.
- Enter an external telephone number (using no more than 24 digits) then press  or **OK**.
- Press  or **OK** if the line you have chosen as the outgoing line is a private network line that does not require you to dial digits.

If you use **ALL** to redirect all your lines, it is important that you wait until all the lines on your telephone light up before pressing  or **OK**. If you press  or **OK** before all the lines light up, those lines not lit are not redirected.



**Tip** - *The line chosen for redirecting calls on other lines can be used normally when it is not busy on a redirected call. To avoid redirection failing because the chosen line is in use, choose a line pool with several lines in it.*



**Tip** - *The system does not check that the number you give for line redirection is a valid one. If you redirect to an invalid number, redirection fails. Using an autodial button to enter the redirection number helps avoid this possibility. An autodial button used for line redirection must be programmed to use a specific line.*

## Canceling Line Redirection

When you are ready to resume service, use this procedure to cancel line redirection.

1. Press    .
2. Select the lines you no longer want to be redirected.

## Allowing a telephone to redirect calls

You can use programming to determine if a set can use the redirect calls feature and turn it on or off.

You need the programming template found at the front of this guide. See *Getting started with Norstar* on page 13 for more information.

1. Press         .
2. Press      (the default System Coordinator password).
3. Press  and enter the internal number of the telephone you want to program.
4. Press  twice.
5. Press  four times. The display reads **Allow redirect.:**
6. Press **CHANGE** to select **Y** (Yes) or **N** (No).

## Turning the redirect ring for a telephone on or off

You can program a telephone to ring briefly (200 milliseconds) when a call is redirected to one of the lines assigned to it.

You need the programming template found at the front of this guide. See *Getting started with Norstar* on page 13 for more information.

1. Press         .
2. Press      (the default System Coordinator password).



3. Press  and enter the internal number of the telephone you want to program.
4. Press  twice.
5. Press  three times. The display reads **Redirect ring:**.
6. Press **CHANGE** to select **Y** (Yes) or **N** (No).



**Tip** - *If a telephone has redirect ring enabled, it rings briefly for redirected calls on one of its lines even if another telephone set up the line redirection.*

### Displays while redirecting lines

Intercom

You selected the intercom button as the facility to place the call on. Enter a line pool code or a destination code.

Line Redirection  
QUIT ADD REMOVE

Press **\*** or **ADD** to begin redirection. Press **#** or **REMOVE** to cancel a previous redirection.

No line to use

You have one external line on your telephone, but you need a second line to perform line redirection. Redirect your external line using a line pool as the outgoing line.

Outgoing line

You are attempting to redirect a line and the line you have chosen is the outgoing line you have selected as a destination. You cannot redirect a line to itself. Select another line.

Pool code: \_\_  
QUIT



Enter a valid line pool access code.

Redir by 221  
OVERRIDE

You have attempted to redirect a line, but someone else has already redirected that line. Press **\*** or **OVERRIDE** to override the previous redirection and redirect the line as you want.

Redirect denied	You can redirect calls only on individual lines.
Select line out QUIT	Select the line that is used to redirect calls out of the system.
Select line(s) QUIT ALL	Press the lines to be redirected. To undo a line selection, press it again. Press <u>ALL</u> to redirect all your lines.
Select line(s) ALL OK	Continue to press the lines to be redirected. Press  or <u>OK</u> when you are finished.
Unequipped line	The line you are attempting to redirect cannot be redirected because the hardware does not support redirection.

### Displays while canceling redirection

Select line(s) QUIT ALL	Press the lines that are no longer to be redirected. The lines light up as you press them. Once you cancel redirection for a line you cannot restore it by pressing the line again. Press <u>ALL</u> to cancel redirection for all your lines. To end, press  or <u>OK</u> .
Select line(s) ALL OK	Continue to press the lines that are no longer to be redirected. Press  or <u>OK</u> when you are finished.

For other displays, see *Common feature displays* on page 257.

## How Line Redirection is different from Call Forward



Call Forward forwards all calls that arrive at a particular telephone to another telephone within the Norstar system. Line Redirection redirects only the lines you specify, no matter which telephones they appear on, to a telephone outside the Norstar system. Line Redirection takes precedence over Call Forward.

---

## Using Line Redirection

You redirect lines at a telephone, but once redirected, the lines are redirected for the entire system.

You can redirect only lines that appear at line buttons on your telephone.

You can answer the telephone if it rings while you are in the middle of programming Line Redirection, but none of the Norstar call handling features are available until the feature times out. If you need to use a Norstar feature to process the call, quit Line Redirection programming by pressing . Do not press  or you disconnect the call you are trying to process.

While you are programming Line Redirection you do not receive any indication of calls that do not actually ring at your telephone.

Be careful to avoid redirection loops. If for example, you redirect your lines to your branch office and your branch office redirects its lines to you, you can create a redirection loop. If these calls are long distance, you end up paying charges.

In certain situations, callers may experience lower volume levels when you redirect calls to an external location.

## Centralized voice mail and auto attendant

How centralized voice mail and auto attendant systems are accessed, depends on which node users are attached.

### Using a centralized voice mail system

If your system is part of a network that uses just one Meridian voice mail or Norstar voice mail system, how the users access the system will depend on which node they reside.

Users with telephones attached to the same system as the voice mail system use the internal prompts () to access messages.







Users with telephones attached to any other nodes, will be prompted to enter a mailbox number, then a password and the # key at the end of the sequence. The subsequent voice prompts will be the same ones that the users encounter when they dial into a system from a remote site. As well, instead of using the  key to access feature codes, users use the  key () , just as they would if they were dialing into their own system from a remote location.

# Communicating in the office

## Paging

Paging allows you to make announcements over the Norstar system using the telephone speakers, or an external loudspeaker system, if one is available.



### Making a page announcement



1. Press   .
2. Choose a page type. Page types are:
  -  through the telephone speakers (internal page)
  -  through an external speaker (external page)
  -  both internal and external (combined page)
3. If necessary, choose a zone.
4. Make your announcement.
5. Press .





**Tip** - Instead of entering the Page feature code followed by the page type, you can enter the following shortcut codes.

Page zone 0 is all zones.

Internal    and zone (0 to 6)

External    (code 2 has no zones)

Combined    and zone (0 to 6)

## Activating and deactivating the ability to page

You need the programming template found at the front of this guide. See *Getting started with Norstar* on page 13 for more information.

1. Press  \* \* 2 6 6 3 4 4 .
2. Press      (the default System Coordinator password).
3. Press  and enter the internal number of the telephone you want to program.
4. Press  twice.
5. Press  seven times. The display reads **Pa9ing9**.
6. Press **CHANGE** to select the setting: **Y** (Yes) or **N** (No).

## Creating page zones

Each telephone can be assigned to one of six zones for receiving pages.



**Tip** - Hunt Group DNs cannot be included in a page zone. For more information about Hunt Groups, see *Programming Hunt Groups* on page 169.

You need the programming template. See *Getting started with Norstar* on page 13 for more information.

1. Press  \* \* 2 6 6 3 4 4 .
2. Press      (the default System Coordinator password).
3. Press  and enter the internal number of the telephone you want to program.

4. Press  twice.
5. Press  six times. The display reads **Page Zone**.
6. Press **CHANGE** to select the setting: 1, 2, 3, 4, 5, 6 or None.

You can make a telephone part of a page zone only if the telephone has paging set to 'Y' (Yes).

A zone is any set of Norstar telephones that you want to group together for paging, regardless of their location. The maximum number of sets in a page zone is 50.

Your installer programs whether a tone sounds before a page begins, and the maximum number of seconds a page can last before it is automatically turned off.



**Tip** - Make sure that everyone who needs to make page announcement has a list showing which telephones are in which page zones. Enter this information into your Modular ICS 6.1 Programming Record.

## Displays

Enter zone:___ <span style="float: right;">ALL</span>	Enter the desired page zone number (0- 6) or press <b>ALL</b> .
Invalid zone	You have entered a page zone code that is not between 0 and 6.
Page choice: SETS    SPKR    BOTH	Select the type of page you want. See the list in <i>Making a page announcement</i> on page 125.
Page timeout	The time allotted for paging has expired.
Paging ALL	You are making a page. The display shows the page zone you have chosen. Press <input type="text" value="E"/> or <input type="text" value="A"/> when you are finished.
Paging busy	A page is already being made in the page zone you have requested.

For other displays, see *Common feature displays* on page 257.



**Tip** - *You can make an announcement to one person by placing a voice call to their telephone.*

## Using Page with external paging equipment

When you make a page that uses external paging equipment — external page or combined page — the Long Tones feature is automatically activated for the external paging system only. This allows you to control optional equipment with the Long Tones feature.

## Sending messages

The Messages feature allows you to leave a message on the display of another digital set or to analog telephones connected to an Analog Station Module (ASM). The Messages feature indicates if you have any messages waiting.

The Messages feature uses a message waiting list to keep a record of your internal messages and your external voice mail messages if you subscribe to a voice message service with visual message waiting indication.

### Sending a message

You can leave a message on the display of another telephone in your Norstar system.

You can send up to four messages to different telephones, including your voice message center. If your telephone is a



direct-dial telephone or a central answering position (CAP), you can send up to 30 messages.

Only the designated direct-dial telephone for an analog telephone connected to an Analog Station Module (ASM) can send messages to analog telephones by pressing   . Depending on the programming setup, the analog telephone provides either a Stuttered Dial Tone or a Message Waiting Lamp to inform the user of messages pending.

If your reply to a message is forwarded or is answered at another telephone using the Call Pickup feature, the message remains on your telephone until you cancel it or successfully contact the telephone that sent the message.

For analog telephones connected to an ASM, the message waiting indicator remains on until the user invokes     . If the analog telephone has the Message Reply Enhancement feature set to Yes, the message waiting indicator is turned off automatically after the reply call is answered no matter from where the call is answered. For more information about the Message Reply Enhancement feature, see the *Norstar Modular ICS 6.1 Installer Guide*.

1. Press   .
2. On a telephone with a two-line display, press **FLD**.  
Note: This step is not necessary on a telephone with a one-line display.
3. Enter the internal number of the person to whom you want to send the message. The person's display reads **Message for you**.
4. On analog telephones connected to an Analog Station Module (ASM), the message waiting indicator is activated.

## Canceling a message you have sent

1. Press **[⏪] [#] [1]**. The display reads **Cancel for:**.
2. Enter the internal number of the person to whom you sent the message.

## Viewing your messages

You can receive up to four messages from different telephones, including your voice message center. A single message from your voice message center may pertain to several voice messages.

On a telephone with a one-line display

1. Press **[⏪] [6] [5]**. The display shows the first message.
2. Press **[\*]** or **[#]** to move through your messages.

On a telephone with a two-line display

1. Press **MSG**. The display shows your first message.
2. Press **NEXT** to move through your messages.

## Replying to a message

You can call the person who sent a message or your voice message center while you are viewing the message.

On a telephone with a one-line display

Press **[0]**.

On a telephone with a two-line display

Press **CALL**.

If you want to call your voice message center using a line other than the programmed line, exit your message list and dial the

voice message center telephone number using normal dialing methods.

## Replying to a message using an analog telephone connected to an ASM

On an analog telephone connected to an Analog Station Module

Press  \* 6 5 . The system automatically retrieves and connects the user to the oldest message sender. (The message can originate from either the designated direct-dial telephone or the internal voice mail system.)

If the analog telephone has the Message Reply Enhancement feature set to Yes, and the sender is the designated direct-dial telephone, the message waiting indicator is turned off automatically after the reply call is answered, no matter from where the call is answered.

For analog telephones connected to an ASM, using the Message Waiting Reply feature (  \* 6 5 ), retrieves only internal messages sent to the user.

Analog telephones connected to an ASM cannot retrieve external messages by using the Message Waiting Reply feature (  \* 6 5 ). For external messages, users must call back the external voice mail center to retrieve their messages. When doing so, the message waiting indicator on the analog telephone is turned off automatically.



**Tip** - *If there is no voice mail system installed, only the designated direct-dial telephone can send messages to an analog telephone connected to an Analog Station Module (ASM) using   . The analog telephone can in turn invoke a single digit access code to reach the designated direct-dial telephone and retrieve messages.*



**Tip** - *If the designated direct-dial telephone of an analog telephone connected to an Analog Station Module (ASM) is changed, messages sent by the previous designated direct-dial telephone are kept in the incoming message list of the analog telephone until they are retrieved.*

## Removing items from your message list

You can erase a message while you are viewing it in your message list. If the message is from your voice message center, this only erases the message notification at your telephone. You need to erase the voice message at your voice message center. Refer to your voice message center documentation.

On a telephone with a one-line display

Press .

On a telephone with a two-line display

Press ERASE.

## Removing items from your message list using an analog telephone connected to an ASM



To remove both internal and external messages on an analog telephone connected to an Analog Station Module

Press  #   to invoke the Cancel Message Waiting feature.

On analog telephones connected to an ASM, the Cancel Message Waiting feature cancels the oldest message received. The system no longer provides either a Stuttered Dial Tone or a Message Waiting Lamp if there are no messages pending.

## Viewing messages you have sent

On a telephone with a two-line display, you can view the messages you have sent.

1. Press  .
2. Press SHOW to display your first sent message.
3. Press NEXT to move through your sent messages.

### Displays

```
Cancel denied
```

You have entered an invalid number when attempting to cancel a message.

```
Cleared>LINENAM
NEXT
```

You have cleared an external message from your message waiting list. The message itself exists in your voice message center until you erase it there.

```
In use: 221
```

You are trying to call from your message waiting list. The line that you want to use is being used by the identified Norstar user.

```
L001:LINENAMMSG
NEXT CALL CLEAR
```

You are viewing your message list. The display shows the number and name of the line that was used for your voice mail message.

```
Message denied
```

You have tried to send a message to an invalid internal number or to a telephone that is out of service.





```
Message list
SHOW ADD EXIT
```

SHOW appears only if you have outstanding messages. Press SHOW to review messages you have sent. Press ADD to send a new message.

```
Message to:
```

Enter the internal number of the telephone to which you want to send a message.

```
Messages & Calls
MSG CALLS
```

You have one or more messages and one or more new Call Logs. Press     to change the first line of the display to the current time and date.

No button free

You have no line button free with which to reply to a message.

No number stored

There has been no number programmed for the voice message center. Contact your voice messaging service provider.

Start of list  
NEXT

You are at the beginning of your list of messages. Press **NEXT** to move through your messages.

Their list full

You are trying to send a message to a user whose message waiting list is full.

Your list full

You have tried to send a message but list of sent messages on your set is full. Cancel one of the messages you have sent, if possible, or wait until you have received a reply to one of those messages.

For other displays, see *Common feature displays* on page 257.

## Using Voice Call

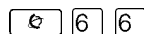

Use this feature to make an announcement or begin a conversation through the speaker of another telephone in the system.



**Tip** - *Hunt Groups cannot accept voice calls. Answer buttons have no appearances for voice calls, and the telephone does not ring for voice calls. For more information about Hunt Groups, see Programming Hunt Groups on page 169. For more information about Answer buttons, see Answer DNs and Answer keys on page 63.*

## Muting Voice Call tones

When a voice call begins at your telephone, you hear a beep every 15 seconds as a reminder that the microphone is on.

To stop it from beeping, pick up the receiver or press the handsfree/mute key.

## Answering a Voice Call with handsfree

If handsfree answerback is assigned to your telephone, you can respond to a voice call without touching the telephone.

Handsfree answerback is not available to the M7100 or the T7100 telephones.

When someone makes a voice call to you, simply start talking. Your telephone microphone picks up your voice.

Once you have answered a voice call, you can put it on hold, transfer it, or otherwise treat it as a normal call.

## Blocking Voice Calls using Voice Call Deny

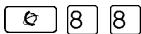

Use this feature to prevent voice calls to your set. The result is that Voice calls ring like regular internal calls. Your other calls proceed normally.

### Canceling Voice Call Deny

Press    .

### Displays

Dial voice call

Dial the internal number or press the internal autodial button of the person to whom you want to speak.

Microphone muted

Your handsfree microphone is muted. Press the handsfree/mute key or pick up your receiver to respond to the voice call.

Voice call

The line is open for you to speak.

### No voice call

The telephone receiving the call cannot accept voice calls for one of the following reasons:

- it is active or ringing with another call
- Call Forward is turned on
- Do Not Disturb is turned on
- Voice Call Deny is turned on
- it is not a Norstar telephone.

Your call proceeds automatically as a regular ringing call.



# Tracking your incoming calls

## Using Call Log

Telephones can automatically log Call Display information for calls on an external line. The line must appear on that telephone but it does not have to be a ringing line.

If your system is equipped with the appropriate equipment, and you have subscribed to the call information feature supplied by your service provider, you are able to capture information about incoming callers in your call log. The same feature is supplied by an ISDN service package that comes with calling line identification (CLID).

Call Log creates a record of incoming external calls. For each call, the log can contain:

- sequence number in the Call Log
- name and number of the caller
- indication if the call was long distance
- indication if the call was answered, and identify who answered it
- time and date of the call
- number of repeated calls from the same source
- name of the line that the call came in on

Call Log can help you to

- keep track of abandoned or unanswered calls
- track patterns for your callers, for example, volume of calls and geographical location of calls
- record caller information quickly and accurately
- build a personal telephone directory from log items

The long distance indicator and the name and number of the call may not be shown in the log. This information depends on the Call Display services provided by your local telephone company and the local telephone company of the caller.

To use the features on the following pages, your telephone must have spaces available in its Call log. Your installer or customer service representative programs each telephone with an appropriate number of spaces.

## Call Log options

With this feature, you can select the type of calls to be stored in your Call Log. Choose from four Autolog options: **No one answered**, **Unanswered by me**, **Log all calls**, **No autologging**.

1. Press    . The display shows the current option.
2. Press  or **NEXT** to change the option.
3. Press  or **OK** to select the display option.

## Logging a call manually

If your calls are not automatically logged, you can manually log call information when you are connected to an external call. Storing information for your current call can be helpful in many situations.





For example, you may want to

- record caller information without using paper and pencil
- record only selected calls of your choice, rather than relying on the automatic Call Log
- quickly record caller information before a caller hangs up

## Enabling and disabling autobumping







Your log has a set number of items that it can hold. When it becomes full, new calls cannot be logged. When your log is full, Autobumping automatically deletes the oldest Call Log item when a new call is logged.

Press     to enable autobumping.

Press      to disable autobumping.



## Viewing your Call Log

To view your log:

1. Press    . The display shows the number or previously read items (old) and the number of new, unread items (new) in the log.
2. Press  or OLD to view old items.  
Press  or NEW to view new items.  
Press  or RESUME to display the last item you viewed, the last time you viewed your Call Log.



Names and numbers for external callers are displayed only if you have subscribed to Call Display services from your local telephone company.

## Viewing a Call Log item



Press   or MORE to view the information for a call log item.

## Erasing log items

You should routinely erase log items to make space for new items in your log.

1. Display the item you want to erase.
2. Press  or **ERASE**.
3. Press  to exit.

If you accidentally erase an item, you can retrieve it.

1. Press  or **UNDO** immediately.
2. Press  to exit.

## Making a call using Call Log

You may find it helpful to place calls from within your Call Log. The number stored for each call may vary, depending on the type of call. For example, if the call was placed from a Centrex or PBX system, the first few numbers may need to be trimmed before you can make the call. If the number you want to call is long distance, or if you want to use a line pool, you may need to add numbers.

To place a call:

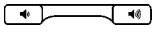
1. Display the log item for the call you want to place.
2. Display the associated telephone number.
3. Press  or **TRIM**, once for every digit that you want to remove.
4. Dial any extra digits required.
5. Press an external line or line pool button.
6. Lift the receiver. (This is not necessary if handsfree is programmed at your telephone.) The displayed number is dialed.

---

## Creating a password to your Call Log

To access your Call Log through a password:

1. Press **[☎] [\*] [8] [5]**. The display reads **New Password:**.
2. Enter your four-digit password.  
The display reads **Repeat. New:**.
3. Re-enter your four-digit password. The display reads **Password changed**, which confirms that your password has been assigned.

To enter Call Log using your password:

1. Press **[☎] [8] [1] [2]** to enter Call Log. If you have programmed a password, the display reads **Password:**.
2. Enter your four-digit password.

If you forget your Call Log password, it can be deleted in programming. See *Using passwords* on page 224.





## Changing your Call Log password

Use this procedure when you want to change the Call Log password for your telephone.

1. Press **[☎] [\*] [8] [5]**. The display reads **Old Password:**.
2. Enter your old password.  
The display reads **New Password:**.
3. Enter your new four-digit password.  
The display reads **Repeat. New:**.
4. Re-enter your password.  
The display reads **Password changed**, which confirms that your password has been changed.

## Deleting an assigned password



Use this procedure when you want to delete an assigned password.

1. Press    . The display reads **Old Password:**.
2. Enter your old password.
3. The display reads **New Password:**.
4. Press  or **OK**.  
The display reads **No Pswd assigned**, which confirms that your password has been deleted.

## Programming a telephone to log calls automatically

Your installer or customer service representative can program each telephone to automatically log calls coming in on a line.

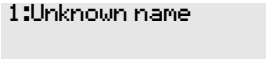
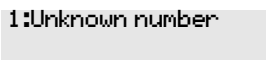
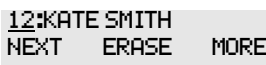
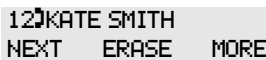
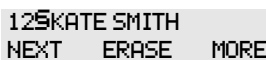
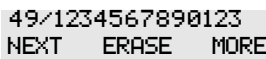
### Displays

	The caller name is unavailable.
	The caller number is unavailable.
	_ indicates a new item.
	⌋ indicates that the call was answered.
	Ⓔ indicates a long distance call.
	↙ indicates that the stored number has been shortened to its final 11 digits. Press   or <b>MORE</b> to display additional information about the call.

Call(s) bumped

One or more log entries have been deleted by the Autobumping feature while you are looking at the Call Log.

Hold or release

Hold or release your active call before entering Call Log.

In use: SETNAME

The external line is in use.

Jan 4 9:00a 3X  
NEXT ERASE MORE

The repeat call counter, shown along with time and date, indicates the number of calls you received from the same caller.

Line001 )227  
NEXT ERASE MORE

This call was answered at another telephone (227).

Line001 )Logit  
NEXT ERASE MORE

This call was logged manually.

Line001  
NEXT ERASE MORE

This call was not answered.

Messages & Calls  
MSG CALLS

There are one or more items in your message waiting list, and there are one or more new items in your Call Log. Press     to change the first line of the display to the current time and date.

New calls begin

You have viewed your last old log item and now view your new log items.

No info to log

No information is available for the call.

No log assigned

No log space has been assigned to the telephone.

No resume item

The resume item has been removed because of Autobumping, repeat call update, or log reallocation while you are looking at the Call Log.

For other displays, see *Common feature displays* on page 257.

## Using external Voice mail

If you subscribe to a voice message service outside your office, you can access that service through your Norstar system. Your installer or customer service representative programs your Norstar telephone to indicate when you have a voice message waiting on a particular line.

To find out if your external voice message service works with Norstar, or if you have any problems with your service, contact your voice message service provider.



# Customizing your telephone

## Finding out what a button does using Button Inquiry



You can use this feature to check the function of any line, intercom, or programmed button on your telephone.

On the M7100 and the T7100 telephones, Button Inquiry shows your internal number followed by the function assigned to your single memory button.

### Displays

```
001 <LINENAME>
      SHOW      OK
```

The display shows the number and name of the line. Press SHOW to view the redirection status of the line.

```
123456789012345...
      VIEW→     OK
```

Press **#** or press VIEW→ or ←VIEW to view a number that is too long to fit on the display. Press  or OK when you are done.

```
221 <SETNAME>
NEXT  VIEW→
```

The display shows the directory number of the telephone, and the assigned name. Press NEXT to see the first line assigned to ring at the intercom button.

```
<Feature name>
      SHOW      OK
```

The name of the feature assigned to a button is displayed when you press the button. Press **#** or SHOW for additional information.

```
Press a button
EXIT
```

Press the button you want to check. Press  or EXIT when you are finished.

For other displays, see *Common feature displays* on page 257.

## Changing the set display contrast

Use this feature to adjust the contrast on your set.

1. Press **[☎] [\*] [7]**.
2. Press a number on the dialpad to choose the contrast level you prefer.

On a two-line telephone, you can use the **UP** and **DOWN** display buttons to adjust the contrast. The number of contrast levels available varies from one telephone model to another.

## Changing the language on the display

You can select the language used on the display of each set. The languages supported depends on which Profile was installed on your system at Startup.

English is the default first language.

Refer to the *Modular ICS 6.1 Installer Guide* for a list of languages supported by each profile. Check the programming guide to determine which Profile was assigned to your system.

You can program **[☎] [\*] [5] [0] [1]**, the first language code, on to a memory button. If you want subsequent languages to display, you can keep pressing the button until the language code you want appears on the display.

You cannot program **[☎] [\*] [5] [0] [2]** or **[☎] [\*] [5] [0] [3]** onto a memory button.

## Programming a feature code onto a memory button

You can program a feature code onto a memory button. In some cases, pressing the button a second time cancels the feature.

### Programming feature buttons

Any memory button not programmed as an external or internal line, target line, Answer button, or handsfree/mute button, is available for features.

1. Press **[☎] [\*] [3]**.
2. Press the memory button you want to program with a feature.
3. Enter the appropriate feature code you want to assign onto the button.

The following feature codes cannot be programmed onto a memory button: Long Tones and any code beginning with **[\*]** except **[☎] [\*] [5] [0] [1]** (Language Choice) and **[☎] [\*] [7]** (Contrast Adjustment).



**Tip** - When you program a button with the line pool feature code, you must enter a line pool access code after the feature code. The programmed line pool button accesses a specific line pool, not the line pool feature.

### Erasing a feature button

1. Press **[☎] [\*] [1]**.
2. Press the feature button.
3. Press **[☎]** or **[OK]** to erase the button.

## Displays

<pre>&lt;Feature name&gt;   SHOW      OK</pre>	<p>The name of the feature assigned to a button is displayed when you press the button. <u>SHOW</u> appears when there is more information available. Press <b>#</b> or <u>SHOW</u> for additional information.</p>
<pre>Enter code:</pre>	<p>If you are checking a speed dial button, enter the three-digit speed dial code that you want to check.</p>
<pre>F_ QUIT      CLEAR</pre>	<p>Enter the feature code, or press <b>☞</b> or <u>QUIT</u> to quit programming or <u>CLEAR</u> to clear the numbers you have entered. The system accepts the entry as soon as you enter a valid feature code.</p>
<pre>Feature code: QUIT</pre>	<p>Press <b>☞</b> and enter the feature code you want to assign to the button. You cannot enter invalid codes.</p>
<pre>Feature moved</pre>	<p>You programmed a button with a feature that was already programmed onto another button. The feature has moved to the button you just programmed. Its original button is now blank.</p>
<pre>Press a button EXIT</pre>	<p>Press the button you want to check. Press <b>☞</b> or <u>EXIT</u> when you are finished.</p>
<pre>Program and HOLD</pre>	<p>Enter the number you want to program and press <b>☞</b>. To erase the button, just press <b>☞</b>.</p>
<pre>Program and OK QUIT      OK</pre>	<p>Enter the number you want to program and press <u>OK</u>. To erase the button, just press <b>☞</b> or <u>OK</u>.</p>

For other displays, see *Common feature displays* on page 257.

## Labeling your set

The Business Series Terminals have label strips that come with each telephone. You can print the label for each button on your telephone and install the strip beside the buttons. The Norstar M-series telephones have individual keycap labels. This section suggests the process for setting up the labelling for your set.

### Applying button labelling

Before you apply button labels, use the Button Inquiry feature (☎ \* 0) to verify the button functions, and to avoid activating features as you put the labels onto the buttons. For more information refer to *Finding out what a button does using Button Inquiry* on page 145.

### Business Series Terminals

The T-series telephones are labelled beside the buttons. You can use the Desktop Assistant utility to make changes and print a new label card. Your system administrator can access this application from the system CD or it can be downloaded from <http://www.nortelnetworks.com> (Choose: Customer Support/Software Distribution, under Product Selection choose Desktop Assistant).

### Business Series Terminal T7316 button label locations

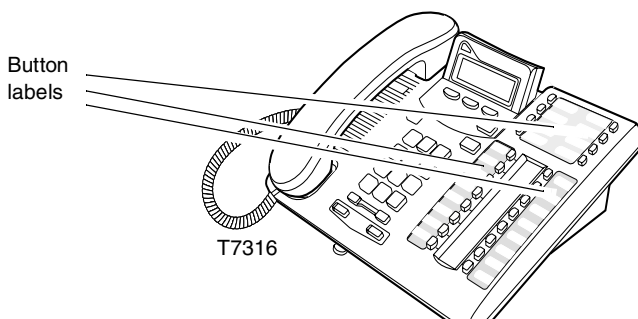

## Norstar button caps

The Norstar M-series has two types of button caps:

- **Unlabeled, clear button caps** with appropriate green or grey paper for line numbers, telephone numbers, and features
- **Pre-printed, colored button caps** in green or grey

### Some examples of pre-printed button caps

Green caps	Grey caps
Line 1	Last No.
Handsfree Mute	Speed Dial



**Tips** - *To make identification of line types easier, use preprinted green button caps for lines that support incoming and outgoing calls. Use clear button caps for target lines that are incoming only.*

## Default button assignments

During Startup, the Norstar installer chooses one of the available templates. Default features are assigned automatically to the programmable buttons on installed sets. These defaults vary depending on the template you choose, and the style of telephone.

The default features are listed mapped out below.



**Tips** - *Norstar M-series telephones are shipped from the factory with the button caps in place for the Square template.*

*Please consult your customer service representative to determine the type of template programmed into your system. Not all templates are available in all software loads.*

## T7316E Business Series Terminal button defaults

The default button assignments for the T7316E Business Series Terminal (BST) depend on the template applied. Refer to your Programming Records to identify the current button programming for each telephone or group of telephones.

Note also that this telephone has a separate handsfree button (under the dial pad). Also, the current incoming call on this telephone defaults to the voice path last used. For example, if you answered the previous call using your headset, the next call will come in over your headset.

Line numbering starts on button 09.

### T7316E BST upper buttons (PBX/DID template)

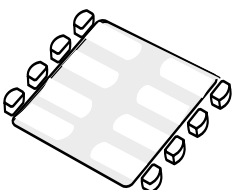
01 <input type="text" value="Contrast"/>		05
02 <input type="text" value="Show Time"/>		06 <input type="text" value="Sys Park"/> (DID only)
03		07 <input type="text" value="Send Msg"/>
04		08 <input type="text" value="Speed dial"/>

### T7316E BST lower buttons (PBX and DID)

PBX template		DID template	
09 <input type="text" value="Sys Park"/>	17 <input type="text" value="Call Timer"/>	09 <input type="text" value="Line&lt;xx&gt;"/>	17 <input type="text" value="Call Timer"/>
10 <input type="text" value="Saved No."/>	18 <input type="text" value="Ring Again"/>	10 <input type="text" value="Saved No."/>	18 <input type="text" value="Ring Again"/>
11 <input type="text" value="Call Fwd"/>	19 <input type="text" value="DND"/>	11 <input type="text" value="Call Fwd"/>	19 <input type="text" value="DND"/>
12 <input type="text" value="Pick-Up"/>	20 <input type="text" value="Conf/Trans"/>	12 <input type="text" value="Pick-Up"/>	20 <input type="text" value="Conf/Trans"/>
13 <input type="text" value="Page"/>	21 <input type="text" value="Last No."/>	13 <input type="text" value="Page"/>	21 <input type="text" value="Last No."/>
14 <input type="text" value="Transfer"/>	22 <input type="text" value="Voice Call"/>	14 <input type="text" value="Transfer"/>	22 <input type="text" value="Voice Call"/>
15 <input type="text" value="Time/Date"/>	23 <input type="text" value="Intercom"/>	15 <input type="text" value="Time/Date"/>	23 <input type="text" value="Intercom"/>
16 <input type="text" value="Receive msg"/>	24 <input type="text" value="Intercom"/>	16 <input type="text" value="Receive msg"/>	24 <input type="text" value="Intercom"/>

**T7316E BST upper buttons (Hybrid template)**

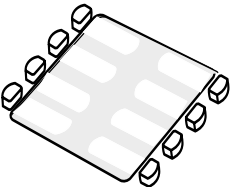
01 <input type="text" value="Contrast"/>		05 <input type="text" value="Saved No."/>
02 <input type="text" value="Show Time"/>		06 <input type="text" value="Sys Park"/>
03 <input type="text" value="Privacy"/>		07 <input type="text" value="Send Msg"/>
04 <input type="text"/>		08 <input type="text" value="Speed dial"/>

**T7316E BST upper buttons (Centrex template)**

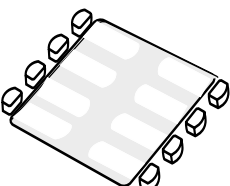
01 <input type="text" value="Contrast"/>		05 <input type="text" value="Saved No."/>
02 <input type="text" value="Show Time"/>		06 <input type="text" value="Sys Park"/>
03 <input type="text"/>		07 <input type="text" value="Send Msg"/>
04 <input type="text"/>		08 <input type="text" value="Speed dial"/>

**T7316E BST lower buttons (Hybrid and Centrex)**

Hybrid template		Centrex template	
09 <input type="text" value="Line&lt;xx&gt;"/>	17 <input type="text" value="Call Timer"/>	01 <input type="text"/>	09 <input type="text" value="Call Timer"/>
10 <input type="text" value="Line Pool"/>	18 <input type="text" value="Ring Again"/>	02 <input type="text" value="Call Fwd"/>	10 <input type="text" value="Ring Again"/>
11 <input type="text" value="Call Fwd"/>	19 <input type="text" value="DND"/>	03 <input type="text" value="Pick-Up"/>	11 <input type="text" value="DND"/>
12 <input type="text" value="Pick-Up"/>	20 <input type="text" value="Conf/Trans"/>	04 <input type="text" value="Page"/>	12 <input type="text" value="Conf/Trans"/>
13 <input type="text" value="Page"/>	21 <input type="text" value="Last No."/>	05 <input type="text" value="Transfer"/>	13 <input type="text" value="Last No."/>
14 <input type="text" value="Transfer"/>	22 <input type="text" value="Voice Call"/>	06 <input type="text" value="Time/Date"/>	14 <input type="text" value="Voice Call"/>
15 <input type="text" value="Time/Date"/>	23 <input type="text" value="Intercom"/>	07 <input type="text" value="Leave msg"/>	15 <input type="text" value="Intercom"/>
16 <input type="text" value="Receive msg"/>	24 <input type="text" value="Intercom"/>	08 <input type="text" value="Flash"/>	16 <input type="text" value="Intercom"/>

**T7316E BST upper buttons (Square template)**

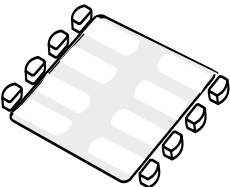
01 <input type="text" value="Contrast"/>		05 <input type="text" value="Svd N redial"/>
02 <input type="text" value="Show Time"/>		06 <input type="text" value="Sys Park"/>
03 <input type="text" value="Privacy"/>		07 <input type="text" value="Send Msg"/>
04 <input type="text"/>		08 <input type="text" value="Speed dial"/>

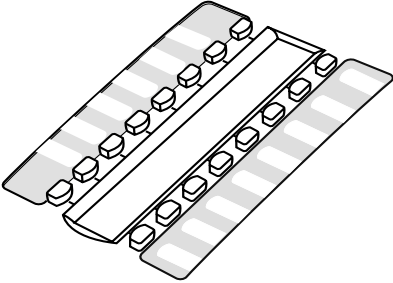

**T7316E BST lower buttons (Square template)**

Button #/ Function	Square template	Button #/ Function
09 <input type="text" value="Line&lt;xx&gt;"/>		17 <input type="text" value="Call Timer"/>
10 <input type="text" value="Line&lt;xx&gt;"/>		18 <input type="text" value="Ring Again"/>
11 <input type="text" value="Call Fwd"/>		19 <input type="text" value="DND"/>
12 <input type="text" value="Pick-Up"/>		20 <input type="text" value="Conf/Trans"/>
13 <input type="text" value="Page"/>		21 <input type="text" value="Last No."/>
14 <input type="text" value="Transfer"/>		22 <input type="text" value="Voice Call"/>
15 <input type="text" value="Time/Date"/>		23 <input type="text" value="Intercom"/>
16 <input type="text" value="Receive msg"/>		24 <input type="text" value="Intercom"/>

**T7316 Business Series Terminal button defaults**

The default button assignments for the T7316 Business Series Terminal (BST) depend on the template applied. Refer to your Programming Records to identify the current button programming for each telephone or group of telephones.

Note the button numbering for some of buttons of this telephone are not consecutive. This is because the buttons are mapped to the M7310. However, since there is no second level to the memory buttons on this telephone, the button numbers only reflect the lower level. In Button programming, however, the absent button numbers appear, but they are not valid programming for this telephone.

These examples show defaults for a system with three-digit internal numbers. The defaults do not actually exist on any telephone, as no telephone has an autodial button for itself. The position that would be taken by the autodial button for itself is blank.

### T7316 BST upper buttons

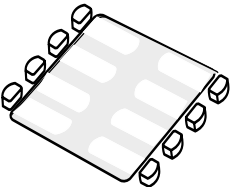
Button 23 <input type="text" value="Set 227"/>		Button 31 <input type="text" value="Set 231"/>
Button 25 <input type="text" value="Set 228"/>		Button 33 <input type="text" value="Set 232"/>
Button 27 <input type="text" value="Set 229"/>		Button 24 <input type="text" value="Set 239"/>
Button 29 <input type="text" value="Set 230"/>		Button 26 <input type="text" value="Set 240"/>

### T7316 BST lower buttons

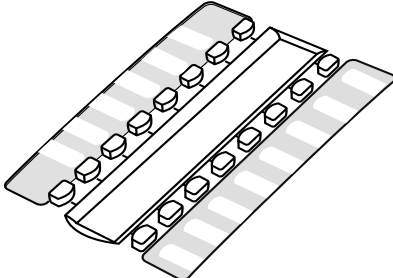
Button #/ Function	PBX template	Button #/ Function
11 <input type="text" value="Set 221"/>		17 <input type="text" value="Set 224"/>
13 <input type="text" value="Set 222"/>		19 <input type="text" value="Set 225"/>
15 <input type="text" value="Set 223"/>		21 <input type="text" value="Set 226"/>
01 <input type="text" value="DND"/>		06 <input type="text" value="Conf/Trans"/>
02 <input type="text" value="Transfer"/>		07 <input type="text" value="Last No."/>
03 <input type="text" value="Call Fwd"/>		08 <input type="text" value="Voice Call"/>
04 <input type="text" value="Pick-Up"/>		09 <input type="text" value="Intercom"/>
05 <input type="text" value="Page"/>		10 <input type="text" value="Intercom"/>

DID template		Square template	
11 <input type="text" value="Set 221"/>	17 <input type="text" value="Set 224"/>	11 <input type="text" value="Set 221"/>	17 <input type="text" value="Set 224"/>
13 <input type="text" value="Set 222"/>	19 <input type="text" value="Set 225"/>	13 <input type="text" value="Set 222"/>	19 <input type="text" value="Set 225"/>
15 <input type="text" value="Set 223"/>	21 <input type="text" value="Set 226"/>	15 <input type="text" value="Set 223"/>	21 <input type="text" value="Set 226"/>
01 <input type="text" value="Line&lt;xx&gt;"/>	06 <input type="text" value="Conf/Trans"/>	01 <input type="text" value="Line 1"/>	06 <input type="text" value="Conf/Trans"/>
02 <input type="text" value="Transfer"/>	07 <input type="text" value="Last No."/>	02 <input type="text" value="Line 2"/>	07 <input type="text" value="Last No."/>
03 <input type="text" value="Call Fwd"/>	08 <input type="text" value="Voice Call"/>	03 <input type="text" value="Call Fwd"/>	08 <input type="text" value="Voice Call"/>
04 <input type="text" value="Pick-Up"/>	09 <input type="text" value="Intercom"/>	04 <input type="text" value="Pick-Up"/>	09 <input type="text" value="Intercom"/>
05 <input type="text" value="Page"/>	10 <input type="text" value="Intercom"/>	05 <input type="text" value="Page"/>	10 <input type="text" value="Intercom"/>

Hybrid template		Centrex template	
11 <input type="text" value="Set 221"/>	17 <input type="text" value="Set 224"/>	11 <input type="text" value="Set 221"/>	17 <input type="text" value="Set 224"/>
13 <input type="text" value="Set 222"/>	19 <input type="text" value="Set 225"/>	13 <input type="text" value="Set 222"/>	19 <input type="text" value="Set 225"/>
15 <input type="text" value="Set 223"/>	21 <input type="text" value="Set 226"/>	15 <input type="text" value="Set 223"/>	21 <input type="text" value="Set 226"/>
01 <input type="text" value="Line 1"/>	06 <input type="text" value="Conf/Trans"/>	01 <input type="text" value="Line&lt;xx&gt;"/>	06 <input type="text" value="Conf/Trans"/>
02 <input type="text" value="Line pool"/>	07 <input type="text" value="Last No."/>	02 <input type="text" value="Transfer"/>	07 <input type="text" value="Last No."/>
03 <input type="text" value="Call Fwd"/>	08 <input type="text" value="Voice Call"/>	03 <input type="text" value="Call Fwd"/>	08 <input type="text" value="Voice Call"/>
04 <input type="text" value="Pick-Up"/>	09 <input type="text" value="Intercom"/>	04 <input type="text" value="Pick-Up"/>	09 <input type="text" value="Intercom"/>
05 <input type="text" value="Page"/>	10 <input type="text" value="Intercom"/>	05 <input type="text" value="Link"/>	10 <input type="text" value="Intercom"/>

### M7310 telephone button defaults

The default button assignments for the M7310 telephone depend on the template applied. The exception is the default numbering for the dual memory buttons. Refer to *Using Buttons* on page 16.

### M7310 lower button assignments

The following tables map the positions for the lower set of buttons for the Norstar M7310 telephone.

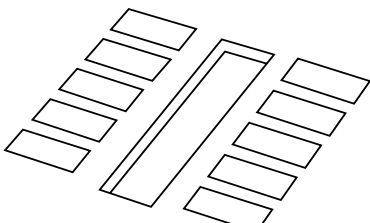
Button #/ Function	Square template	Button #/ Function
01 <input type="text" value="Line 1"/>		06 <input type="text" value="Conf/Trans"/>
02 <input type="text" value="Line 2"/>		07 <input type="text" value="Last No."/>
03 <input type="text" value="Call Fwd"/>		08 <input type="text" value="Voice Call"/>
04 <input type="text" value="Pick-Up"/>		09 <input type="text" value="Intercom"/>
05 <input type="text" value="Page"/>		10 <input type="text" value="Intercom"/>

PBX template		Hybrid template	
01 <input type="text" value="DND"/>	06 <input type="text" value="Conf/Trans"/>	01 <input type="text" value="Line 1"/>	06 <input type="text" value="Conf/Trans"/>
02 <input type="text" value="Transfer"/>	07 <input type="text" value="Last No."/>	02 <input type="text" value="Line pool"/>	07 <input type="text" value="Last No."/>
03 <input type="text" value="Call Fwd"/>	08 <input type="text" value="Voice Call"/>	03 <input type="text" value="Call Fwd"/>	08 <input type="text" value="Voice Call"/>
04 <input type="text" value="Pick-Up"/>	09 <input type="text" value="Intercom"/>	04 <input type="text" value="Pick-Up"/>	09 <input type="text" value="Intercom"/>
05 <input type="text" value="Page"/>	10 <input type="text" value="Intercom"/>	05 <input type="text" value="Page"/>	10 <input type="text" value="Intercom"/>

Centrex template		DID template	
01 <input type="text" value="Line&lt;xx&gt;"/>	06 <input type="text" value="Conf/Trans"/>	01 <input type="text" value="Line&lt;xx&gt;"/>	06 <input type="text" value="Conf/Trans"/>
02 <input type="text" value="Transfer"/>	07 <input type="text" value="Last No."/>	02 <input type="text" value="Transfer"/>	07 <input type="text" value="Last No."/>
03 <input type="text" value="Call Fwd"/>	08 <input type="text" value="Voice Call"/>	03 <input type="text" value="Call Fwd"/>	08 <input type="text" value="Voice Call"/>
04 <input type="text" value="Pick-Up"/>	09 <input type="text" value="Intercom"/>	04 <input type="text" value="Pick-Up"/>	09 <input type="text" value="Intercom"/>
05 <input type="text" value="Link"/>	10 <input type="text" value="Intercom"/>	05 <input type="text" value="Page"/>	10 <input type="text" value="Intercom"/>

**M7310 with dual memory buttons**

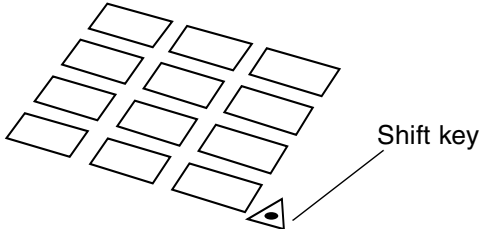
*12 <input type="text" value="Set 233"/>	*20 <input type="text" value="Set 237"/>	*28 <input type="text" value="Set 241"/>	<p>Note: This example shows defaults for a system with three-digit internal numbers. The defaults do not actually exist on any telephone, as no telephone has an autodial button for itself. The position that would be taken by the autodial button for itself, is blank.</p> <p>* These settings are produced using the shift key, located beside the upper set of buttons.</p>
11 <input type="text" value="Set 221"/>	19 <input type="text" value="Set 225"/>	27 <input type="text" value="Set 229"/>	
*14 <input type="text" value="Set 234"/>	*22 <input type="text" value="Set 238"/>	*30 <input type="text" value="Set 242"/>	
13 <input type="text" value="Set 222"/>	21 <input type="text" value="Set 226"/>	29 <input type="text" value="Set 230"/>	
*16 <input type="text" value="Set 235"/>	*24 <input type="text" value="Set 239"/>	*32 <input type="text" value="Set 243"/>	
15 <input type="text" value="Set 223"/>	23 <input type="text" value="Set 227"/>	31 <input type="text" value="Set 231"/>	
*18 <input type="text" value="Set 236"/>	*26 <input type="text" value="Set 240"/>	*34 <input type="text" value="Set 244"/>	
17 <input type="text" value="Set 224"/>	25 <input type="text" value="Set 228"/>	33 <input type="text" value="Set 232"/>	
			

## M7324 telephone button defaults

The default button assignments for the M7324 telephone depend on the template applied during startup. Refer to *Using Buttons* on page 16.

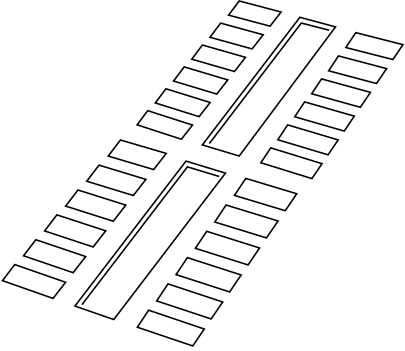
# Function	Square template	# Function
01 <input type="text" value="Line 1"/>		13 <input type="text" value="Call Fwd"/>
02 <input type="text" value="Line 2"/>		14 <input type="text" value="Speed Dial"/>
03		15 <input type="text" value="Last No."/>
04		16 <input type="text" value="Saved No."/>
05		17 <input type="text" value="Conf/Trans"/>
06		18 <input type="text" value="Transfer"/>
07		19 <input type="text" value="DND"/>
08		20 <input type="text" value="Pick-Up"/>
09		21 <input type="text" value="Voice Call"/>
10		22 <input type="text" value="Page"/>
11		23 <input type="text" value="Intercom"/>
12		24 <input type="text" value="Intercom"/>

PBX template		Hybrid template	
01	13 <input type="text" value="Call Fwd"/>	01 <input type="text" value="Line 1"/>	13 <input type="text" value="Call Fwd"/>
02	14 <input type="text" value="Speed Dial"/>	02 <input type="text" value="Line pool"/>	14 <input type="text" value="Speed Dial"/>
03	15 <input type="text" value="Last No."/>	03	15 <input type="text" value="Last No."/>
04	16 <input type="text" value="Saved No."/>	04	16 <input type="text" value="Saved No."/>
05	17 <input type="text" value="Conf/Trans"/>	05	17 <input type="text" value="Conf/Trans"/>
06	18 <input type="text" value="Transfer"/>	06	18 <input type="text" value="Transfer"/>
07	19 <input type="text" value="DND"/>	07	19 <input type="text" value="DND"/>
08	20 <input type="text" value="Pick-Up"/>	08	20 <input type="text" value="Pick-Up"/>
09	21 <input type="text" value="Voice Call"/>	09	21 <input type="text" value="Voice Call"/>
10	22 <input type="text" value="Page"/>	10	22 <input type="text" value="Page"/>
11	23 <input type="text" value="Intercom"/>	11	23 <input type="text" value="Intercom"/>
12	24 <input type="text" value="Intercom"/>	12	24 <input type="text" value="Intercom"/>

Centrex template		DID template	
01	Line<xx>	13	Call Fwd
02		14	Speed Dial
03		15	Last No.
04	Link	16	Link
05		17	Conf/Trans
06		18	Transfer
07		19	DND
08		20	Pick-Up
09		21	Voice Call
10		22	Page
11		23	Intercom
12		24	Intercom

### M7208 and T7208 button defaults

The default button assignments for the M7208 and the T7208 sets are the same, depending on which template was applied.

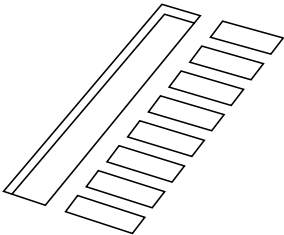
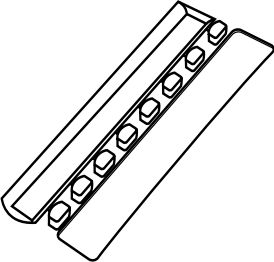
M7208 button set	Square template	T7208 button set
	01	Line 1
	02	Line 2
	03	Last No.
	04	Page
	05	Conf/Trans
	06	Speed Dial
	07	Intercom
	08	Intercom
		

Centrex template	Hybrid template	PBX template	DID template
01 <input type="text" value="Line&lt;xx&gt;"/>	01 <input type="text" value="Line 1"/>	01 <input type="text" value="Pick-Up"/>	01 <input type="text" value="Line&lt;xx&gt;"/>
02 <input type="text" value="Transfer"/>	02 <input type="text" value="Line pool"/>	02 <input type="text" value="Transfer"/>	02 <input type="text" value="Transfer"/>
03 <input type="text" value="Last No."/>	03 <input type="text" value="Last No."/>	03 <input type="text" value="Last No."/>	03 <input type="text" value="Last No."/>
04 <input type="text" value="Link"/>	04 <input type="text" value="Page"/>	04 <input type="text" value="Page"/>	04 <input type="text" value="Page"/>
05 <input type="text" value="Conf/Trans"/>	05 <input type="text" value="Conf/Trans"/>	05 <input type="text" value="Conf/Trans"/>	05 <input type="text" value="Conf/Trans"/>
06 <input type="text" value="Speed Dial"/>	06 <input type="text" value="Speed Dial"/>	06 <input type="text" value="Speed Dial"/>	06 <input type="text" value="Speed Dial"/>
07 <input type="text" value="Intercom"/>	07 <input type="text" value="Intercom"/>	07 <input type="text" value="Intercom"/>	07 <input type="text" value="Intercom"/>
08 <input type="text" value="Intercom"/>	08 <input type="text" value="Intercom"/>	08 <input type="text" value="Intercom"/>	08 <input type="text" value="Intercom"/>



**Tips** - The default Page button activates the External Page option (  ).

## M7100 and T7100 button defaults

For all templates, the one programmable button on the M7100 and the T7100 sets is defaulted to .

## Rules of default button assignment

- Line and Intercom buttons are assigned by default templates and can be changed in programming.
- Handsfree/mute and answer DN buttons are not assigned by default. If these features are defined, however, they are automatically assigned to specific buttons, as described on this and the following page.
- None of these buttons can be assigned to M7100 or T7100 telephones, as telephones have only one program button.





- The handsfree/mute feature appears on the bottom right-hand button on the M7310 telephone and the bottom button on the M7208 telephone, moving the Intercom button(s) up one position. The Business Series Terminals have a separate mute button, which is located under the numeric dialpad, beneath the volume rocker button. The T7316E telephone also has a separate handsfree button, located beside the mute button, however, this button only works if the telephone is connected to a system that is version 6.1 or later.
- Each telephone can have up to eight Intercom buttons. These buttons assign to the position above the handsfree/mute button, if there is one, at the bottom right-hand button position, if there is two columns of buttons.
- Each telephone can have up to eight answer DN buttons. On the M7310 and T7316/T7316E telephones, they appear above Intercom buttons in the right column and continue up from the bottom in the left column, replacing the features on those buttons. On the M7208 and T7208 telephones, answer DN buttons appear above the Intercom buttons and below external line buttons in a single column.
- External line buttons appear in ascending line order, starting at the top button in the left column of the M7310 Norstar and M7208 and T7208 telephones. If more than five external lines are assigned to an M7310 telephone, or more than 12 to an M7324 telephone, assignment continues down the buttons on the right column, erasing the features on those buttons. Line buttons have priority over feature access buttons but not handsfree/mute, Intercom, or answer DN buttons.  
The T7316 starts lines at button 01, which is the fourth button down, on the left side of the lower button set.  
The T7316E starts line numbering at button 09, which is the left top corner of the lower button set. Refer to the



default charts for specific button placement for these telephones.

## Moving line buttons

You can move external lines, hunt group appearances, and target line appearances to different buttons on your telephone, to arrange your lines in the way that makes the most sense to you. If you have a CAP, you cannot move intercom, answer keys or handsfree/mute buttons onto the module, but you can move your lines over to the modules. If you have a T7316E CAP with eKIMs you can move lines, target line appearances and hunt group appearances over to the KIM.

1. Press    .
2. Press the button you want to move the line from.
3. Press the button you want to move the line to.

### Displays

Exchanged

The two buttons you selected have exchanged position.

Invalid location

You have tried to move a line to a button that cannot be used as a line button, such as an intercom button, handsfree/mute button, or an answer button.

Move line from:  
QUIT

Press the button of the line you want to move. Press  or QUIT when you have finished moving lines.

Move line to:  
QUIT







Press the button you want to move the line to. Neither of the buttons is erased. The lines, or the line and feature, simply switch places.

Press a line

The button you are trying to move is not a line button. If you are trying to switch a line and a feature, move the line to the feature button and not the feature button to the line.



## Changing the type of ring

You can choose one of four distinctive rings for your telephone. This makes it easier to identify your telephone in an open office.

1. Press  \* .
2. Press , , , , or **NEXT**. You hear the selected ring for two seconds.
3. Repeat until you hear the ring you prefer, then press  or **OK**.





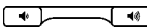





## Adjusting the Ring volume

Use this feature to adjust the ring volume.

1. Press  \*  . The telephone rings.
2. Press  to adjust the volume; left end for lower and right end for higher.

## Hiding the message or calls indication

The display that shows you have messages or calls can be replaced with the current time and date. You can retrieve your message and call information by using the display buttons that appear on the second line of the display. If you are using a telephone with a single-line display, the message or call indication is hidden.

1. Press    . The current time and date appears on the top line of the display.
2. Press **MSG** or    to see your messages, or press **CALLS** or     to see your calls.

### Restoring the messages and calls indication

Press  #   .

# User Preferences

The User Preferences section of programming allows you to program memory buttons, speed dial codes and other settings for any Norstar or BST telephone on the system.

For example, an employee may want to have the Do Not Disturb feature programmed onto a memory button or create a speed dial code. Instead of programming from the each specific set, you can go into programming on the telephone nearest you to make the change.

## Using User Preferences

1. Press        (      ).
2. Enter the Basic password (the default password is     ). (Note: You can also use the Coordinator password to change User preferences.

By using a Basic password, it is possible to have someone else do day-to-day upkeep of the telephone programming without giving out access to sensitive programming. See *Using passwords* on page 224.

After you enter the proper password, the display shows you the telephone with the lowest internal number followed by its name (For example, **221:Reception**).

1. Press  to move through all the telephones on the system.
2. Press  when you see the telephone you want to change. The display reads the model number of the telephone at the extension.

The display shows **Connect set** if no telephone is connected at that internal number.

You cannot make changes if the model is **Other**.

3. Press  to move through all the subheadings in **User Preferences**.

User Preferences programming is available under the heading **Terminals&Sets**.

### Sub-headings in User Preferences

User preferences
Model
Button prgrming
User speed dial
Call log opt'ns
Dialing opt'ns
Language
Display cntrst
Ring type

### Changing button programming

1. Press  at **Button prgrming**. The display shows the number of buttons on the telephone. An example is shown in **Displays** at the end of this section.  
If the telephone has a CAP module, you can press **CAP1** or **KIM1** to see the buttons on the module.
2. Press  to move through all the buttons on the telephone. Refer to *Default button assignments* on page 150 for button number mapping for each type telephone.
3. Use the display buttons to change the programming for a button.

## The display buttons used in button programming.

<u>CANCL</u>	Moves you out of a setting without making any changes to it.
<u>CLR</u>	Erases the button.
<u>TEL#</u>	Programs the key as an autodial number for an internal or an external number. If it is an external autodial number, you must choose a line, line pool, or the routing table for the call to use.
<u>CHANGE</u>	Used when you are setting up an external autodial number. Press <u>CHANGE</u> until you see the type of line or pool you want the number to use.
<u>FEATR</u>	Press to store a feature code on the button.
<u>FIND</u>	Locates a specific button on a telephone by entering its number. Button numbers are shown in the illustrations.
<u>LIST</u>	Takes you to a list of feature codes. Press <input type="text" value="Next"/> to move through the list and press <u>OK</u> when you see the feature you want to program on the button.

Note: User Preferences programming cannot change the buttons that are used by lines, intercom, and the handsfree feature, which are assigned by the system administrator. Refer to the *Modular ICS 6.1 Installer Guide* for details.

## Changing User Speed Dial

1. Press  at **User Speed Dial**. The display shows the number of speed dial codes that are available.
2. Press  to see the first speed dial code (256).
3. Press  to move through all the speed dial codes.
4. Press  to find the code you want to change.
5. Press CHANGE and enter the telephone number the same way you would dial it on the telephone.
6. Press OK.

7. Press  and choose the line (or enter a code for a line pool) the speed dial code should use.

Use the line pool code to select a particular line pool for use with Speed Dial. If you select **Use routing tbl1**, a line or pool is chosen by the routing programming according to the initial digits in the number.

The route you choose for a User Speed Dial code must be one that the telephone can use. For example, if the telephone does not have access to Line Pool B and you use that pool code with the speed dial code, the code does not work. Lines and line pools are assigned to the telephones by the system administrator. Refer to the *Modular ICS 6.1 Installer Guide* for details.

To change a system speed dial code, see *Adding or changing a system speed dial* on page 31.

## Changing Call Log options

1. Press  at **Call log opt'ns...**
2. Press **CHANGE** until you see the option you want to use. See *Call Log options* on page 138.

## Changing how calls are dialed

1. Press  at **Dialing opt'ns...**
2. Press **CHANGE** until you see the option you want to use.

Descriptions for dialing options are found on the *Telephone Feature Card*, or see *Changing how you dial your calls* on page 82.

## Changing the language used on the display

Press CHANGE at **Language:** until you see the language you want to use. See *Changing the language on the display* on page 146.

## Making the display lighter or darker

Press CHANGE at **Display contrast** until you see the value you want to use.

The display contrast on the telephone you are using for the programming session does not change when you are programming another telephone.

## Changing the ring type

At **Ring type:**, press CHANGE until you see the option you want to use.

Descriptions for ringing options are found on the *Telephone Feature Card* or in *Changing the type of ring* on page 162.

### Displays

```
10+24 buttons
FIND
```

There are 10 memory buttons and 12 dual memory buttons on the telephone you are viewing. Press  to begin looking at what is on each button.

```
B01:L06:Line 001
FIND
```

A line appears on the button. You cannot store a feature or number on it.

```
B02:#Reply Msg...
CLR TEL# FEATR
```

A feature is stored on this button. Press  to see the feature code. A full list of names and codes for features is included in the index.

```
Code:F#65...
CLR TEL# FEATR
```

Shows the feature code stored on a button. Press  to see the button number and feature name.

<pre>B03:160455512... CLR  TEL#  FEATR</pre>	<p>The button has a telephone number stored on it. Press <input type="text" value="Show"/> to see the rest of the number.</p>
<pre>Externl tel #... CLR  TEL#  FEATR</pre>	<p>The autodial is an external number. Press <input type="text" value="Show"/> to see what line or pool the call is programmed to go out on.</p>
<pre>Internl tel #... CLR  TEL#  FEATR</pre>	<p>The autodial is an internal number. Press <input type="text" value="Show"/> to see more information.</p>
<pre>B04:Intercom...                                 FIND</pre>	<p>The button is used for intercom. Press <input type="text" value="Show"/> to see more information about the button. You cannot store a feature or number on it.</p>
<pre>B05:Ansr 93                                 FIND</pre>	<p>The button is used for an Answer DN. You cannot store a feature or number on it.</p>
<pre>B06:Blank button CLR  TEL#  FEATR</pre>	<p>Either nothing is stored on the button or you have just cleared the button by pressing <u>CLR</u>.</p>
<pre>B10:Handsfree                                 FIND</pre>	<p>The button is occupied by the handsfree feature. You cannot store a feature or number on it.</p>

For other displays, see *Common feature displays* on page 257.



# Programming Hunt Groups

The Hunt Groups feature allows a group of Norstar or BST telephones to be called by a single directory number ensuring that calls are easily routed to the appropriate group.



The Incoming Line Group (ILG) functionality is now accomplished through the Hunt Group feature. When upgrading from a pre-Modular ICS 4.0 system to a Modular ICS 6.1 system, any lines previously belonging to an ILG are not automatically converted to broadcast Hunt Groups. You must go in and program them to the new feature. Please refer to *Assigning or unassigning lines to a group* on page 173.

Hunt Groups are used in situations where a group of people performing the same task are required to answer a number of related phone queries. Some typical uses of Hunt Groups are:

- a sales department answering questions on product prices or availability
- a support department answering questions concerning the operation of a product
- an emergency department answering calls for help.

Hunt Groups can be used to route calls to a support service such as a Help Line for a software company. Specialists dealing with Product A can be in one group, and specialists dealing with Product B can be in another group. Incoming calls hunt for the next available telephone in the group. If no telephone is available, the call can be placed in a queue or routed to telephone designated as the overflow set.

The Hunt Groups subheading in system programming is the area where programming changes are made to the following:

- members of a group
- member position in a group
- what lines are assigned to a group
- how incoming calls are distributed
- how long the system looks for available members
- where a call goes if all members are busy

**Note:** Videophones should not be programmed as members of a Hunt Group. Hunt Groups allow one B channel connection at a time and videophones use two B channels.

Features affected by Hunt Groups include:

- Call Forward All Calls
- Call Forward No Answer
- Call Forward on Busy
- Group Pickup
- Transfer via Hold
- Priority Call
- Line Redirection
- Page Zones
- Voice Call

## Adding or removing members from a group

A DN for a telephone can be associated as a member of a Hunt Group, and is called a member DN.

Members of the group can be any Norstar or Business Series Terminal telephone, ISDN terminal, or portables. A telephone can be in more than one Hunt Group but is considered a member in each Hunt Group, increasing the total number of members in the system.

There can be only one appearance of the Hunt Group on a telephone, no matter how many lines are assigned to the group.

Hunt Group DNs cannot be members of other Hunt Groups.

Consult your customer service representative to determine your Hunt Group number range.

1. Place the appropriate programming overlay on your programming set.
2. Press          (CONFIG). The display shows **Password:**.
3. Press      (ADMIN). The display shows **Terminals&Sets**.
4. The display shows **Terminals&Sets**.
5. Press  until the display shows **System Programming**.
6. Press . The display shows **Hunt groups**.
7. Press . The display shows **Show group**.
8. Enter the Hunt Group number you want to program (1-30) or press  to scroll through the groups.

9. Press  . The display shows **Member DNs**.
10. Press  . The display shows the first group member, if there are members.
11. Press **ADD** and enter a telephone DN to add a member to the group. Press **REMOVE** to remove a member from the group. Press  to move through the list.
12. Press  to exit or  to continue programming.

## Moving members of a group

Member order within a Hunt Group is important. The member order determines how a call is routed through a Hunt Group.

1. At **Hunt groups**, press  . The display shows **Show group**.
2. Enter the Hunt Group number you want to program (1-30) or press  to scroll through the groups.
3. Press  . The display shows **Member DNs**.
4. Press  . The display shows the members for that group.
5. Press **MOVE** to move an existing member to another place within the Hunt Group. The display shows the member number followed by an arrow.
6. Enter the new position number for the extension.
7. Press  to exit.

## Assigning or unassigning lines to a group

You can assign one or several lines to a hunt group.

Hunt group line notes:

- Configure the prime set for a Hunt Group line to **None** to avoid delayed ring transfer of external Hunt Group calls to the prime set before the Hunt Group can receive the call.
- A line can be assigned to only one group.
- Do not assign any hunt group lines to individual telephones. If any of the telephones that are part of the hunt group have the line assigned, remove the line from the telephone before assigning it to the hunt group.

1. At **Hunt groups**, press . The display shows **Show group**.
2. Enter the Hunt Group number you want to program (1-30) or press  to scroll through the groups.
3. Press . The display shows **Member DNs:**.
4. Press . The display shows **Line assignment**.
5. Press . The display shows **Show line:**.
6. Enter the line number you want to program or press **SCAN** to go to the first line assigned to this group, or press **LIST** to go to the first line in the system.
7. Press **CHANGE** to program the line as **Unassigned** or **Assigned**.  
\*HGnn\* means the line is assigned to another Hunt Group.
8. Press  to exit or  to continue programming.

## Setting the distribution mode

There are three modes of call distribution:

- **Broadcast**—rings each telephone in the group simultaneously. Calls are handled one at a time, while succeeding calls are queued. As soon as a call is picked up, the call next in the queue is presented immediately to the group.

In Broadcast mode, a single incoming call rings simultaneously at all the telephones in a group. This way, all receptionists in the group can share the load of answering large volumes of calls. All telephones automatically display the calling line identification (CLID), if available. A familiar example is a fund-raising campaign where a group of operators are waiting to take each call as it comes in.

- **Sequential**—starts the call at the first telephone in the Hunt Group. Distribution is complete when the first idle telephone is found. Simultaneous calls can be presented. Distribution is order based.

In Sequential mode, you can program your top salesperson to be the first member of the group to receive calls.

- **Rotary**—the call starts at the telephone after the one which answered the last call. Distribution is complete when the next idle telephone has been found. Simultaneous calls can be presented. Distribution is order based.

In Rotary mode, you can ensure that all your helpline people are receiving calls on an equal basis, rather than one person receiving the majority of calls. The call rings at one set at a time in a round robin fashion.

If a Hunt Group has available members but nobody answers the call, the call is rerouted through the list until someone answers the call. If all lines are busy, the call is routed according to whatever has been set for the busy line setting. Refer to 'Programming busy line setting' on page 176.

1. At **Hunt Groups**, press . The display shows **Show group**.
2. Enter the Hunt Group number you want to program (1-30) or press  to scroll through the groups.
3. Press . The display shows **Member DNs:**.
4. Press  until the display shows **Mode**.
5. Press **CHANGE** to set the mode: **Broadcast**, **Sequential**, **Rotary**.
6. Press  to exit or  to continue programming.

## Setting the hunt delay

This setting allows you to program the number of rings the system permits at a Hunt Group telephone before moving on to the next telephone in the Hunt Group.

1. At **Hunt Groups**, press . The display shows **Show group**.
2. Enter the Hunt Group number you want to program (1-30) or press  to scroll through the groups.
3. Press . The display shows **Member DNs:**.
4. Press  until the display shows **Hunt delay**.
5. Press **CHANGE** to select the setting: **1, 2, 3, 4, 5, 6, 7, 8, 9, 10**.
6. Press  to exit or  to continue programming.

## Programming busy line setting

A Hunt Group is considered busy if one of two scenarios exists:

- all of its members are being presented an incoming Hunt Group call
- all of its members are active on a Hunt Group call

There are three routing options if all members are busy:

- **BusyTone**—the caller gets a busy tone (PRI lines only)
- **Overflow**—the call is routed to an overflow position. If the overflow DN is the hunt group DN for that same hunt group, the overflow option will not appear.
- **Queue**—the call stays in the system for a period of time. Within this period of time, the call is presented to a member if one becomes available. When the time-out occurs, the call is presented to an overflow position.

1. At **Hunt groups**, press . The display shows **Show group**.
2. Enter the Hunt Group number you want to program (1-30) or press  to scroll through the groups.
3. Press . The display shows **Member DNs:**.
4. Press  until the display shows **If busy:**.
5. Press **CHANGE** to set the mode: **BusyTone**, **Overflow**, **Queue**.
6. Press  to exit or  to continue programming.



## Programming the queue time-out

This setting allows you to program the number of seconds a call remains in the Hunt Group queue before it is routed to the overflow position.

1. At **Hunt groups**, press . The display shows **Show group**.
2. Enter the Hunt Group number you want to program (1-30) or press  to scroll through the groups.
3. Press . The display shows **Member DNs:**.
4. Press  until the display shows **Q Timeout:**.
5. Press **CHANGE** to set the queue time-out: **15, 30, 45, 60, 120, 180**.
6. Press  to exit or  to continue programming.

## Programming the overflow set

This setting allows you to program the overflow telephone to which the Hunt Group calls are to be routed. Unless the overflow position is a Hunt Group telephone, the call ceases to be a Hunt Group call. If the overflow telephone is a Hunt Group telephone, the call is treated as a new call and goes to the bottom of the queue.

The overflow telephone can be a DN number associated with a voice mailbox.

1. At **Hunt groups**, press . The display shows **Show group**.
2. Enter the Hunt Group number you want to program (1-30) or press  to scroll through the groups.

3. Press  . The display shows **Member DNs:**.
4. Press  until the display shows **Overflow:**.
5. Press **CHANGE** to change the overflow position.
6. Enter the new overflow position.
7. Press  to exit or  to continue programming.

## Setting the name

This setting allows you to program the Hunt Group name, such as Service or Sales. The name can be up to seven characters in length. This name becomes the CLID display name when the DN is called.

1. At **Hunt groups**, press  . The display shows **Show group**.
2. Enter the Hunt Group number you want to program (1-30) or press  to scroll through the groups.
3. Press  . The display shows **Member DNs:**.
4. Press  until the display shows **Name:**.
5. Press **CHANGE**.
6. Use the dialpad to enter the name of the Hunt Group.
7. Press  to store the name.
8. Press  to exit or  to continue programming.

## Allowing/disallowing an auxiliary ringer

This setting allows you to allow/disallow an external ringer to sound when a call comes in for a specific hunt group. If you allow this service, you must have an auxiliary ringer properly installed on your system. Refer to *Using an auxiliary ringer* on page 233.

1. At **Hunt Groups**, press . The display shows **Show Group**.
2. Enter the Hunt Group number you want to program (1-30) or press  to scroll through the groups.
3. Press . The display shows **Member DNs:**.
4. Press  until the display shows **Aux. Ringer:**.
5. Press **CHANGE** to choose **Y** (yes) to turn the ringer on or **N** (No) to disallow an auxiliary ringer.
6. Press  to exit or  to continue programming.

## Assigning a distinctive ring pattern to a Hunt Group

You can assign distinctive ring patterns to your Hunt Group so that calls can be rated in priority for the group. These distinctive ring patterns have the same characteristics as for line and extension distinctive ring patterns.

The Hunt Group distinctive ring pattern determines how a call will ring within the Hunt Group. If members of the group have ring patterns assigned to their telephones that are higher than the ring patterns of the incoming line or the Hunt Group, then the Hunt Group will use the ring of the corresponding member telephones.

If the incoming call (line) has a higher ring pattern assigned than the Hunt Group, the Hunt Group will ring with the line ring pattern.

1. At **Hunt groups**, press . The display shows **Show group**.
2. Enter the Hunt Group number you want to program (1-30) or press  to scroll through the groups.
3. Press . The display shows **Member DNs:**.
4. Press  until the display shows **Distinct Ring:NONE**.
5. Press **CHANGE** to toggle to the ring pattern number you want to assign to the Hunt group line. (**None, 2, 3, 4**)
6. Press  to exit or  to continue programming.

## Using Silent Monitor

When silent monitor is activated on your system, you can use your SM supervisor two-line display telephone to monitor Hunt group calls based on which DN you select to monitor.

Refer to the *Modular ICS Installation Guide* for detailed information about the fields that make up this feature.

To start a session, on a silent monitor supervisor telephone:

1. Enter     .
2. Type in the SM password (default: **SILENT (745368)**)
3. Enter the DN of the hunt group telephone you want to monitor and press **OK**.

If that telephone is currently on a Hunt group call, you will be automatically connected to the call. If the telephone is

idle or not on a hunt group call, you will be prompted to pick another DN to monitor.



**Tips** - Your telephone is muted by default at the beginning of any monitoring session. Press the handsfree/mute button or the display key under JOIN to enter the conversation.

To end a session: Press , or press the display key under OTHER or EXIT.

While attempting to monitor a call, or during a call, you may get one of the following prompts:

```
OBSERVE
  RETRY   OK
```

Enter the DN for the Hunt Group telephone that you want to monitor. If you make a mistake entering a DN number, press RETRY and re-enter the number. If the number you entered is correct, press OK.

The system redisplay this prompt if it is unable to establish a session with the telephone DN that you enter.

```
OTHER JOIN EXIT
```

While a call is being monitored, you can choose to:

- move to another Hunt group member (OTHER)
- join the current conversation (JOIN)
- exit the silent monitoring (EXIT)

```
OTHER LEAVE EXIT
```

When you join a monitored call, you can choose to:

- move to another Hunt group member (OTHER)
- mute your telephone out of the current conversation (this does not disconnect silent monitoring) (JOIN)
- exit the silent monitoring (EXIT)

```
Access denied
```

You tried to start a monitoring session on a telephone that does not support the feature.

Needs Handsfree	You entered the silent monitor feature code without picking up the handset, and the telephone does not support handsfree operation.
Release calls	You entered the silent monitor feature code on a telephone that already has an active call. To continue, you will have to release it.
Your number	You entered your own DN.
Invalid number	The DN you entered is invalid for your system.
Not in Service	The DN you entered did not respond to the system.
Not HG member	The DN you entered is not a Hunt Group member.
Supervisor	The DN you entered belongs to another Supervisor. You cannot monitor SM supervisor telephones.
Not Supported	The DN you entered belongs to a portable telephone or an ISDN terminal.
DN: Idle OTHER                    EXIT	The current call on the telephone you are monitoring is either not a Hunt Group call, or the call came in on a line key on that telephone. Note: You should not assign lines which are assigned to the hunt group to individual hunt group members
Need I/C key	No intercom key is currently available to support the feature.

---

## Feature notes

- You can only monitor external hunt group calls.
- You must release all calls on your supervisor telephone before you attempt to run a monitoring session.
- The DN you choose to monitor must be a designated member of a hunt group.
- The supervisor telephone can be part of a hunt group. Supervisor telephones cannot be monitored.
- If the hunt group call gets transferred, the session is dropped because the call is no longer a hunt group call.
- If any of the parties release the call, the monitoring session is dropped, and the supervisor will be prompted to pick another DN to monitor.
- To transfer a session to your handset when you start the monitoring session in handsfree mode, press the OTHER key and re-enter the DN, otherwise the session will continue on your telephone speaker.
- If your telephone is in Silent Monitor idle mode, and you press the Intercom key, the monitoring session will terminate.
- You can monitor calls that are forwarded to a hunt group member.
- If the call is parked, attached to a SWCA key, put on Hold, or camped, Silent Monitor will drop the monitoring session and the supervisor will receive an indication that the hunt group telephone is now idle.
- If the current hunt group call is part of a conference call, it cannot be monitored.
- You can initiate a session on a Hunt group telephone with Do Not Disturb or Auto Privacy are active.

- Using a headset automatically defaults Silent Monitor to mute. This is the recommended way of using the Silent Monitor feature.
- Messages received by the supervisor during a silent monitoring session, will not provide an indication on the display.
- Attempting to initiate any feature keys on the supervisor set, while a session is active, will terminate the silent monitoring session.
- A priority call or ring again call will be indicated on the display. The monitoring session will terminate if the call is accepted.
- If a line is assigned to both a ringing group and a hunt group, calls coming in over this line cannot be monitored.
- If a voice call coming into a supervisor telephone is accepted, any active monitoring session will be released.
- T7316 telephones used as supervisor may experience problems using mute and unmute when joining or leaving a silent monitor session.

**MCDN constraints:** The attendant cannot break-in to a call which is being monitored. Trunk Anti-Tromboning (TAT) will not be applied to a call that is currently being monitored. If a call has already had TAT applied, the call cannot be monitored.



# Using the Hospitality features

This section describes the Hospitality Services feature which is used to administer room and alarm services in small to medium-sized facilities such as hotels, motels, or hospitals.

There are three types of sets that make up this type of system:

**Common set**—this telephone can be found in the lobby, office, or common area, and is not associated with a room. This type of telephone is used for public access, and cannot access the admin or room features.

**Room set**—this telephone resides in a specific room and can be used by both guests and cleaning staff to set alarms or to indicate room condition. Up to five DN's can be assigned to the same room number, such as for fax lines, internet dial-up, etc.

**Administration set**—this telephone must be a two-line display telephone, and is usually configured with a password to allow secure administration of room occupancy and condition services and alarm services.

## Hospitality passwords

There are two passwords within the hospitality feature. One provides secure access to the administration set, and one provides secure access to a room condition setting from each room set for housekeeping staff.

## Desk pswd

Change this password frequently, to maintain security.

1. Place the appropriate programming overlay on the set you are using to do programming.
2. Press          (CONFIG). The display shows **Password:**.
3. Press      (ADMIN). The display shows **Terminals&Sets**.
4. Press  until the display shows **Hospitality**.
5. Press . **Desk Pswd:** displays. (default:4677)
6. Press **CHANGE**. **New Pswd:** displays
7. Enter a new password, then press **OK**.

## Cond pswd

Change this password frequently, to maintain security.

1. Place the appropriate programming overlay on the set you are using to do programming.
2. Press          (CONFIG). The display shows **Password:**.
3. Press      (ADMIN). The display shows **Terminals&Sets**.
4. Press  until the display shows **Hospitality**.
5. Press . **Desk Pswd:** displays
6. Press . **Cond Pswd:None** displays.
7. Press **CHANGE**. **New Pswd:** displays
8. Enter a new password, then press **OK**.

## Room/desk information

There are two aspects to programming room information.

- First you must program individual DNs to a specific room and set up the room occupancy filters, which determine what types of calls can be made from a room set at various states of occupancy.

Note: You can assign up to five DNs to the same room number.

- Then you need to administer the room occupancy and state of the room.

### Programming room information

Use this setting to assign set DNs to a specific room.

1. Place the appropriate programming overlay on the set you are using to do programming.
2. Press          (CONFIG). The display shows **Password:**.
3. Press      (ADMIN). The display shows **Terminals&Sets**.
4. Press  until the display shows **Hospitality**.
5. Press . **Room/desk info** displays.
6. Press . **Show set: displays**.
7. Enter a room set number or press LIST and press  until you find the DN of the set you want to assign to a room.
8. Press . **Room #:None** displays.
9. Press CHANGE and enter the room number, then press OK to accept the change.

10. Press  . **Adm fwd read:Y** displays
11. Press **CHANGE** and choose **Y** or **N**, depending on your security requirements.

## Call restrns

Call restrictions can be set up by the system administrator. Refer to the *Modular ICS Installer Guide* for details.

## Service times





You can set the time when occupied rooms change from Service done to Service required. This setting affects the Room condition feature.

1. Place the appropriate programming overlay on the set you are using to do programming.
2. Press          (CONFIG). The display shows **Password:**.
3. Press      (ADMIN). The display shows **Terminals&Sets**.
4. Press  until the display shows **Hospitality**.
5. At the Hospitality heading, press  until **Service time** displays.
6. Press  . **Hour: 00** displays.
7. Press **CHANGE** and enter the hour (00 to 23).  
If the number is less than 13, the display shows **AM**. Press **CHANGE** to select **PM**, if required. Press **OK** to accept.
8. Press  . **Minutes: 00** displays.
9. Press **CHANGE** and enter the minutes (00 to 59).

## Using the room/set programming

This section describes how the room occupancy and room condition settings are used.

### Setting dialing filters by room state

1. Press    .
2. Enter the Desk admin password if you are prompted for a password.

The set displays: **0c of rm#:**

3. Enter the room number and press **OK**.

The set displays **rrrrr:Vacant.**

4. Press the **CHANGE** display key and select the required status for the room set.
5. To program other rooms, press the **FIND** or **NEXT** display key and return to step 3.
6. Press  to exit.

Note: Setting the room state to Vacant cancels any outstanding alarms.

### Setting the room condition

You can use this feature on a room set or administration set to:

- set the room state to service done (**Srvc done**)
- set the room state to Needs service (**Needs srvc**)
- query the state of the room

### Using the room set:

1. Press     on a digital set  
or      on an analog set.
2. At the prompt, set the status of the room.

Note: You may be required to enter a Room condition password.

Press  to indicate **Set to srv done**.

Press  to indicate **Set to needs srv**.

The set displays the selected prompt.

3. Press  to exit.

### Using the admin set:

1. Press    .
2. Enter the Desk admin password if you are prompted for a password.

The set displays: **Cd of rm#:**

3. Enter the room number and press **OK**.

The set displays **rrrrr:Vacant**.

4. To update the condition, press **CHANGE** and select the required status.

To query the condition of other rooms, press the **FIND** or **NEXT** displays keys.

5. Press  to exit.

## Programming the alarm feature

If you want to allow the room sets to program wake-up alarms, there are a couple of program settings that need to be entered.

1. Place the appropriate programming overlay on the set you are using to do programming.
2. Press          (CONFIG). The display shows **Password:**.
3. Press      (ADMIN). The display shows **Terminals&Sets**.
4. Press  until the display shows **Hospitality**.
5. Press . **Room/desk info** displays.
6. Press  until **Alarm** displays.
7. Press . **Attn attempts:3** displays.
8. Press **CHANGE** until you find the number you want (1-5).
9. Press . **Retry intrvl:4** displays.
10. Press **CHANGE** until you find the number you want (2, 4, 6, or 8).
11. Press . **Attn duration: 15** displays.
12. Press **CHANGE** until you find the number of seconds you want (10, 15, 20, 30, 40, 50).
13. Press . **Time format:12 hr** displays.
14. Press **CHANGE** to choose either **12hr** or **24hr**.
15. Press . **Expired alarms** displays.
16. Press . **Notify set:None** displays.
17. Press **CHANGE** to enter a set DN to be notified.
18. Press . **Use tone:N** displays.

19. Press **CHANGE** to choose either **Y** (yes) or **N** (no).
20. Press  to exit or  to continue programming.

## Using the Administration set to control alarms

Only a Hospitality Services set can use this alarm administration feature. This feature is also associated with a room number, and cannot be used on common sets.

Use this feature to:

- query a current or last alarm time set for a room
- assign an alarm time for any room
- change an alarm time for any room
- cancel an pending alarm for any room

To program the alarm, follow these steps:

1. Press    .
2. Enter the Desk admin password if you are prompted for a password.

The set displays: **al of rm#:**

3. Enter the room number.
4. Press **VIEW**. The set displays **Alarm: 07:00am OFF:**

If the alarm time is correct, press the **ON/OFF** display key.

If you want to change the time, enter a new four-digit alarm time.

If the clock uses a 24-hour format, enter an hour between 00 and 23, and minutes between 00 and 59. The set displays: **Alarm ON hh:mm**



If the clock uses a 12-hour format, enter the time, then when the set displays: **hh:mm AM or PM?**, press **AM** or **PM**. The set displays: **Alarm ON hh:mm**.

5. Press  to exit.

## Using the alarm

To set an alarm on a digital telephone:

1. Press  **8** **7** **5**. The displays shows **Alarm:07:00 OFF**

2. Do one of the following:

If the alarm is correct, press **ON/OFF**. The set displays: **Alarm:07:00am ON**. Press **DONE** to exit.

If you need to change the alarm time, press **CHG**. The set displays: **Enter time:**

3. To enter a new time, do one of the following:

If the clock uses a 24-hour format, enter an hour between 00 and 23, and minutes between 00 and 59. The set displays: **Alarm ON hh:mm**

If the clock uses a 12-hour format, enter the time, then when the set displays: **hh:mm AM or PM?**, press **AM** or **PM**. The set displays: **Alarm ON hh:mm**.

To set an alarm on an analog set:

1. Press  **\*** **8** **7** **5**. A tone sounds.

2. Enter a four-digit alarm time:

If the clock uses a 24-hour format, enter an hour between 00 and 23, and minutes between 00 and 59. A tone sounds.

If the clock uses a 12-hour format, enter the time, then press **\*** to select am or **#** to select pm. A tone sounds.

To enter a new time, repeat the above steps and enter a new time. This overwrites the existing entry.

## Canceling an alarm

Canceling the alarm time for any set cancels the alarm time for all the sets in the same room.

Digital set: Press  # 8 7 5 .

Analog set: Press  # 8 7 5 .

## Turning off an alarm

When the alarm rings, the user can release the ring by doing one of the following, depending on the type of set in the room:

Digital set: Press any button except .

Analog set: Lift and replace the handset.

 acts like a snooze alarm and will temporarily disable the alarm for a programmed period. Refer to *Service times* on page 188.

If the user is on a call when the alarm sounds, they can press any button except , which would release the call instead.

# Telephone features

## Installing Business Series Terminals

If you are connecting a Business Series Terminal for the first time, refer to the following illustrations as a guide.

### Installing the Business Series Terminal connections

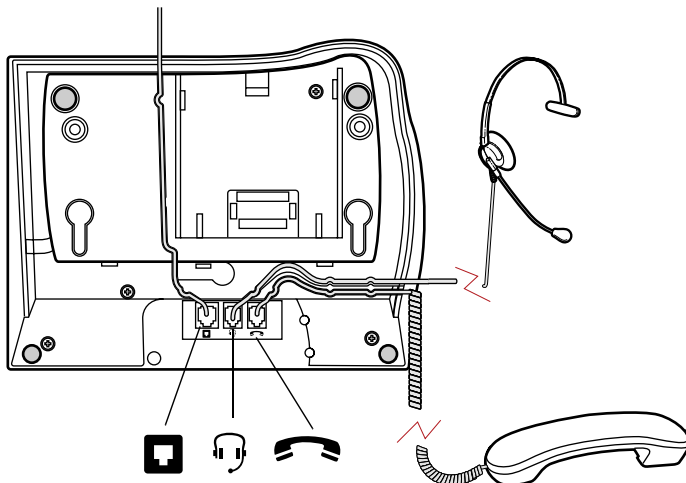

Installing to a desk jack

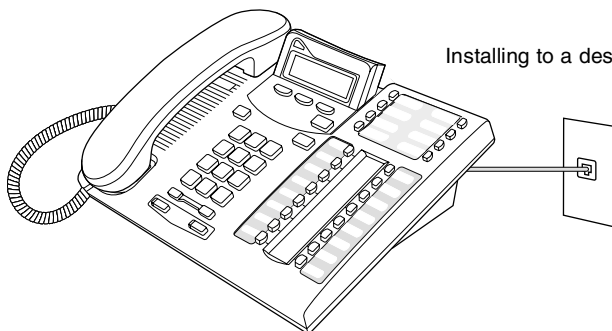

### Mounting a Business Series Terminal on the wall

Installing without the angled base

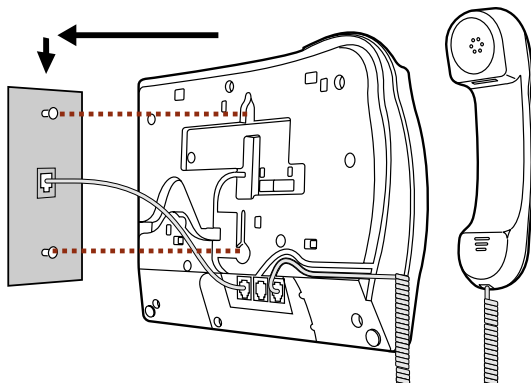

### Mounting a Business Series Terminal using the stand

Tighten screws for a secure fit.

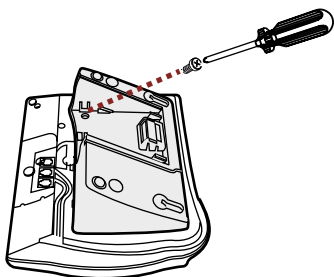

Mount the stand as shown and insert screw. Use the screw that came with your keystation.

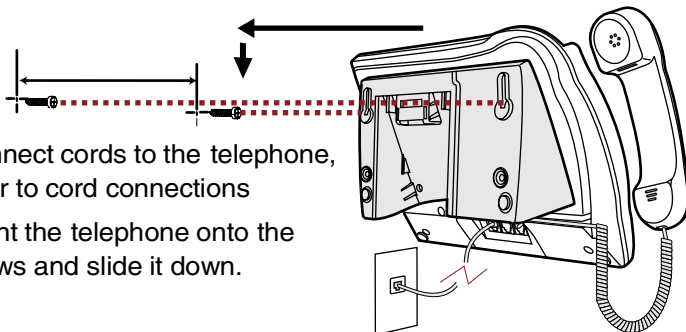

Connect cords to the telephone, refer to cord connections

Mount the telephone onto the screws and slide it down.

Connect line cord to wall jack.

# Installing Norstar telephones

If you are connecting a Norstar telephone for the first time, refer to the following illustrations as a guide.

## Installing a Norstar telephone

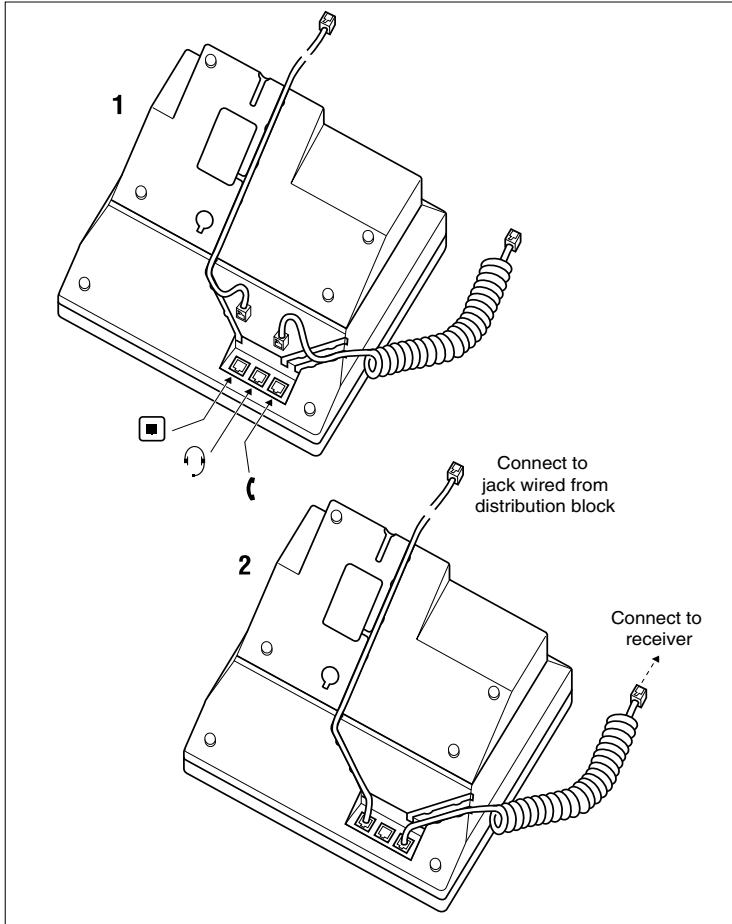

## Mounting a Norstar telephone on the wall

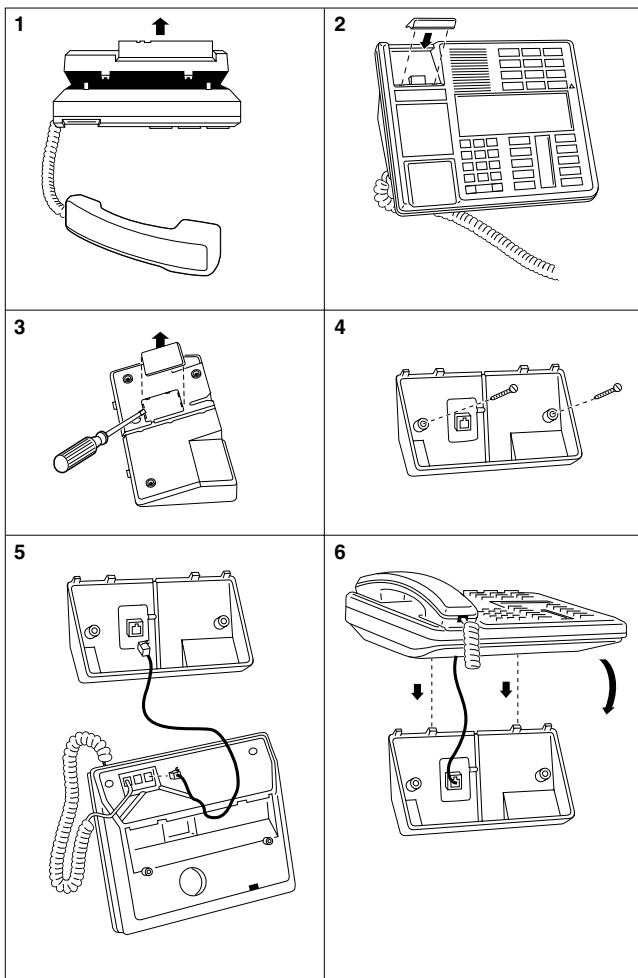

## Naming a telephone or a line

You can assign names to identify external lines, target lines, and each telephone. During a call, the name, if programmed, is shown on the telephone display instead of the external line number or internal telephone number of the caller. Step-by-step instructions for adding or changing the name of a telephone or a line are in *Changing the name of a telephone* on page 34.

Telephone names and line names can contain both letters and numbers, but cannot be longer than seven characters. You cannot use the # and \* symbols.



**Tip** - *You can give the same name to two or more telephones, or to a telephone and a line in your system. To avoid confusion, avoid such duplication. Use initials, abbreviations, or even nicknames to give each telephone a unique name.*

*If automatic telephone relocation is turned on, the name and internal number of a telephone are saved if the telephone is moved within your system.*

## Moving telephones



You may be required by law to report any telephone moves to your local telecommunications carrier or 911 service provider. For further details, consult your local carrier, your local 911 service provider, and/or your local telecommunications service provider.

If automatic telephone relocation is enabled in programming by your installer or customer service representative, you can move your telephone from one Norstar jack to another without losing any of its custom programming. If you want to replace

a telephone and cancel the programming, ensure that the relocation setting is off.

## Stopping calls from ringing at your telephone: Do Not Disturb (DND)

### Stopping calls

Press    to stop calls from ringing at your telephone.

Only priority calls ring at your telephone. A line button flashes when you receive a call, but the call does not ring.

### Refusing to answer a call

While you are on a call, you can refuse to answer a second call (including a priority call).

Press    while your telephone is ringing.

### Canceling Do Not Disturb

Press    .

### Displays

Your telephone receives calls normally.

### Using Do Not Disturb

Once you turn Do Not Disturb on, calls are forwarded to the prime telephone only if there is no other telephone on which the line appears. If there is another telephone that shares the same line, the call may be answered by that person. The Delayed Ring Transfer feature transfers all unanswered calls to the prime telephone after a specified time.



Do Not Disturb prevents voice calls from alerting at your telephone. Voice calls are presented as normal intercom calls.



**Tip** - Norstar and BST telephones that are members of a Hunt Group can temporarily leave a Hunt Group by activating this feature. Hunt Group calls arriving while a telephone is in Do Not Disturb mode are routed to the next member in the Hunt Group. For more information about Hunt Groups, see *Programming Hunt Groups* on page 169.

## Using Background Music

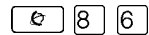





Use this feature to active the optional music feature. You will hear whatever music source is attached to the Modular ICS.

Your installer or service representative makes this feature available to all telephones in programming. You need to supply a music source, such as a radio, and have it attached to your ICS.



In accordance with U.S. copyright law, a license may be required from the American Society of Composers, Authors and Publishers or a similar organization if radio or TV broadcasts are transmitted through the Background Music feature of this telecommunication system. Nortel Networks hereby disclaims any liability arising out of the failure to obtain such a license.

## Turning Background Music off

The music stops automatically if you make or answer a call, or press     to turn it off.



# ISDN PRI and BRI

Integrated Services Digital Network (ISDN) technology provides a fast, accurate and reliable means of sending and receiving data, image text and voice information through the telephone system.

By using Primary Rate Interface (PRI) or Basic Rate Interface (BRI), your ISDN service allows for faster transmission speeds and the addition of a variety of powerful business applications, including remote LAN access, videoconferencing, file transfer and Internet access.

Your installer configures ISDN services and terminal equipment.

## ISDN PRI

PRI is economical because separate analog trunks and data circuits are not needed for Direct Inward Dialing (DID), Direct Outward Dialing (DOD), and data transfer.

With PRI there is greater flexibility because B channels can be dynamically reconfigured to accommodate changes in traffic with the Call by Call feature. For more information, see *Call by Call service selection for PRI* on page 206.

PRI offers fast information access because channel usage is optimized to allow you the full benefit of available bandwidth and real-time connectivity.

PRI lines are configured as DID lines. Incoming calls on a PRI line can appear on a DID button or on an intercom button depending on how your target lines are assigned to the telephones. Outgoing calls are made using the intercom buttons.

PRI lines can be accessed from all devices such as Norstar telephones, Business Series Terminals (BST telephones), ISDN sets, and wireless handsets.

## ISDN PRI features

Selected ISDN network features can be used from a Norstar telephone. Your central office switch (ISDN network) determines which features are available to you.

### Network Name Display for PRI

Your Norstar system displays the name of an incoming call when it is available from the service provider. Name information can be displayed on a Norstar or BST telephone, but not on an ISDN terminal. If the Calling Party Name has the status of *private*, it may be displayed as **Private name**. If the Calling Party Name is unavailable, it may be displayed as **Unknown name**.

Your Norstar system displays the name of the called party on an outgoing call, when it is provided by your service provider.

The Business Name concatenates with the set name on an outgoing call. This can only occur if the Business Name has been programmed.

The available features include:

- receiving Connected Name
- receiving Calling Name
- receiving Redirected Name
- sending Connected Name
- sending Calling Party Name

---

Consult your customer service representative to determine which of these features is compatible with your service provider.

## **Name and number blocking for PRI**

When activated,   8  1  9 allows you to block the outgoing name and/or number on a per-call basis. Name and number blocking can be used with a Norstar or BST telephone, but not with an ISDN terminal.

Consult your customer service representative to determine whether or not this feature is compatible with your provider.

## **Emergency 911 Dialing**

Modular ICS 6.1 with the ISDN PRI feature is capable of transmitting the telephone number and internal extension number of a calling station dialing 911 to the Public Switched Telephone Network. State and local requirements for support of Emergency 911 Dialing service by Customer Premises Equipment vary. Consult your local telecommunications service provider regarding compliance with applicable laws and regulations.

If transmission of internal extension numbers is not required or desired, then it is recommended that the System Coordinator maintain a site map or location directory that allows emergency personnel to rapidly locate a Norstar or BST telephone, given its DID number. This list should be kept up to date and readily available, and can be included with the Programming Record.

## **Two-way DID**

With PRI, the same lines can be used for receiving direct inward dialing (DID) and for making direct outward dialing (DOD) calls.

The dialing plan determines how calls are routed.

Consult your customer service representative to determine whether or not this feature is compatible with your service provider.

## **Call by Call service selection for PRI**

PRI lines can be dynamically allocated to different service types with the Call by Call feature. PRI lines do not have to be pre-allocated to a given service type.

Call types that may be available, depending on your service provider are:

- Public**      Public calls connect your telephone with a Central Office (CO). DID and DOD calls are supported.
- Private**     Private calls connect your telephone with a private network. DID and DOD calls are supported. A private dialing plan may be used.
- Tie**            Tie lines are private incoming and outgoing lines that connect Private Branch Exchanges (PBX) such as Norstar.
- FX**            Foreign Exchange calls connect your telephone to a remote CO. It provides the equivalent of local service at the distant exchange.
- Outwats**     Outwats is for outgoing calls. This allows you to originate calls to telephones in a specific geographical area called a zone or band. Typically a flat monthly fee is charged for this service.

**Inwats** Inwats is a type of long distance service which allows you to receive calls originating within specified areas without a charge to the caller. A toll-free number is assigned to allow for reversed billing.

Consult your customer service representative to determine whether or not this feature is compatible with your provider.

## Dialing Plan and PRI

The Dialing Plan supports PRI connectivity to public and private networks. The dialing plan is a collection of features responsible for processing and routing incoming and outgoing calls. All PRI calls must go through a dialing plan.

### The Dialing Plan

- allows incoming calls to be routed to telephones, based on service type and digits received
- allows Enbloc dialing by buffering user-dialed digits until a complete DN has been dialed
- provides the ability to map user-dialed digits to a service type on a Call by Call basis
- allows long distance carrier selection via user-dialed Carrier Access Codes

Depending on the type of dialing plan chosen, you may also need to specify a Private DN length so the system knows when the user has completed dialing.

Refer to the Networking chapter in the *Modular ICS 6.1 Installer Guide* for more details about dialing plans. Consult your customer service representative to determine how your dialing plan is configured.

## ISDN BRI

Modular ICS 6.1 supports a maximum of 30 ISDN sets on the system.

The following ISDN services are supported:

- incoming calls
- outgoing calls
- Calling Line Identification Presentation (CLID)
- sub-addressing
- bearer capabilities
- teleservices

The Call Forward All Calls feature can be used from ISDN terminals connected to Modular ICS.

**Note:** Norstar and BST telephones can accept voice calls only. Video and data calls do not alert at a Norstar or BST telephone.

Although an ISDN S-loop or LT-loop can support up to eight devices, the loop has a limit of two B-channels. If both B-channels are in use, other devices on that loop cannot make or receive calls until a B-channel is available, or until both B-channels are available, in the case of a video terminal. Thus, the number of terminals installed must take into account whether you require dedicated access for the terminals on that loop.

**Note:** System telephone features, other than Transfer and Call Forward All Calls, are not available to ISDN terminals. In addition, you cannot retrieve a parked call, or reach a Direct-Dial set by using the Direct-Dial digit from an ISDN terminal.



---

## Line access from an ISDN terminal

ISDN terminals do not have line keys or intercom keys, as do Norstar telephones and Business Series Terminals. To make an outgoing call from an ISDN terminal, access an external line by entering a line pool code or by using the ARS feature.

## ISDN BRI features

Selected ISDN network features can be used from a Norstar or BST telephone. Your central office switch (ISDN network) determines which features are available to you.

### Network Name Display for BRI

Your Norstar system displays the name of an incoming call when it is available from the service provider. Name information can be displayed on a Norstar or BST telephone, but not on an ISDN terminal. If the Calling Party Name has the status of *private* it may be displayed as **Private name**. If the Calling Party Name is unavailable it may be displayed as **Unknown name**.

Your Norstar system displays the name of the called party on an outgoing call, when it is provided by your service provider.

As with PRI, your Norstar system sends the Business Name concatenated with the set name on an outgoing call, but only if a Business Name has been entered for the set.

The available features include:

- receiving connected name
- receiving calling name
- receiving redirected name
- sending connected name
- sending calling party name

Consult your customer service representative to determine whether or not this feature is compatible with your service provider.

## **Name and number blocking for BRI**

When activated,  8  1  9 allows you to block the outgoing name and/or number on a per-call basis. Name and number blocking can be used with a Norstar set but not with an ISDN terminal.

Consult your customer service representative to determine whether or not this feature is compatible with your service provider.

## **Service provider features**

Consult your customer service representative to determine if the new ISDN features are supported with your service provider.

### **Call Forward**

Call Forward allows you to forward your calls to an external telephone number.

1. Select an ISDN line by selecting a line button, a line pool, or the handsfree button, or by lifting the handset (if an ISDN line is your prime line).
2. Consult your service provider for the appropriate feature code to enter on your dialpad. Listen for three tones followed by dial tone.
3. Enter the internal number of the telephone to which you want your calls forwarded. If the call is answered, stay on

the line for at least five seconds to activate the Call Forward feature.

## Canceling Call Forward

1. Select an ISDN line by selecting a line button, a line pool, or the handsfree button, or by lifting the handset (if an ISDN line is your prime line).
2. Consult your service provider for the appropriate feature code to enter on your dialpad. Listen for a series of tones.
3. Press .

## Calling the number your calls are forwarded to

1. Select an ISDN line by selecting a line button, a line pool, or the handsfree button, or by lifting the handset (if an ISDN line is your prime line).
2. Consult your service provider for the appropriate feature code to enter on your dialpad.

## Automatic Call Back

If you call a number and it is busy, enter the appropriate feature code designated by your service provider to receive a distinctive ring at your set when the line becomes available for calls.

## Automatic Recall

Automatic Recall allows you to automatically dial the number of the last call you received. You may not see the number on the display if the information is not available from your service

provider, or if you do not have Caller ID as part of your ISDN service.

Consult your service provider for the appropriate feature code to enter on your dialpad.

## MCID (profile 2)

The MCID feature allows you to enter     to have call information recorded on the central office system for an incoming call on a specific line (ETSI EURO ISDN lines, only).

The user must invoke the feature code either during the active call or within 30 seconds (time varies on different networks) after the caller hangs up, but before the user hangs up.

### MCID prompts

Call traced	The MCID request was accepted by the network.
No response	No response to the MCID request.
Not incoming	MCID can only be invoked on received calls.
Not available	The caller information is not available. The CO is not able to log the information or it is not an ETSI BRI/PRI type of call.
Not subscribed	MCID feature is not subscribed to.
Invalid state	MCID is not allowed in the current state of the call.
Not allowed	Invalid interaction with another supplementary service.

## **Network Call Diversion (profile 2)**

This feature is a network function that allows forwarding and redirection of calls outside the Norstar network when using an ETSI ISDN line. Functionality is similar to that of External Call Forward (ECF). NCD redirects calls using the same line on which they arrive. Call forward is efficient since there is no need for additional outside lines.

## **Overlap dialing (profile 2)**

This feature allows a break in the dialing sequence when dialing on ETSI PRI lines that require overlap dialing.

## **ISDN BRI terminals**

Your Modular ICS allows connection of eight Basic Rate Access loops (four 2B+D channels) that can be used for fully digital connections to ISDN networks and devices. Loops are connections between the ICS and devices or between the ICS and the network.

Each loop provides two separate B-channels that can be used to make two simultaneous voice or data calls, or one data call and one voice call.

## **ISDN applications for BRI and PRI**

ISDN terminal equipment delivers a wide range of powerful business applications:

### **Videoconferencing and video telephony**

Video conferencing offers instant visual and audio contact between distant parties using either studio-based or desktop ISDN terminals.

## **Desktop conferencing**

ISDN allows computer users in distant locations to share and edit any image, data or text file on their own computer screens while they discuss the information.

## **File transfer**

The ISDN network allows you to transfer files containing data, text, images, data, or audio clips, faster and cheaper than with a conventional modem.

## **Telecommuting**

Convenient retrieval, processing and storage of files is possible for the employee working at home by using ISDN lines to give high-speed access to information resources at the office.

## **Group 4 fax**

ISDN fax applications save money by increasing both transmission speed and the quality of resolution.

## **Remote LAN access**

ISDN provides an affordable and fast means for employees at remote sites (at home or branch offices) to access local area networks (LANs).

## **Leased line backup**

Essential backup for leased lines can be provided using ISDN as required, rather than duplicating costly permanent leased lines.

## **LAN to LAN bridging**

Local area network (LAN) bridge/routers allow flexible interconnection between LANs using ISDN, with charges incurred only when information is actually transmitted.

## **Internet and database access**

The fast call set up and high bandwidth of ISDN are ideal for accessing information services such as the Internet and databases.





# Using System features

## Using alternate or scheduled services

There are three types of Services to make your Norstar system handle calls differently on different days and at different times of the day: Ringing service, Restriction service and Routing service.

Each of the three services, and the six schedules available to each service, are customized for you by your installer or customer service representative. They program which telephone is used to turn Services on and off, and display what Services are in use. This is called the control telephone.

### Preventing certain calls from being made

Restriction service prevents a user from making certain kinds of calls from a telephone or from lines that are available at the telephone. The restrictions are programmed by your installer or customer service representative. For example, you might want to restrict long distance dialing between certain hours of the day.

### Making additional telephones ring

Ringing service makes additional telephones ring for incoming calls on external lines. For example, all incoming external calls can ring at a security telephone during the night. Or calls to one attendant can ring at another telephone during lunch. This service does not suppress your normal ringing assignment.

## Changing the lines used by outgoing calls

Routing service allows you to assign alternate routes to calls during different schedules. In this way you can take advantage of lower costs available on particular routes on certain days and at certain times. Both the regular and alternate routes are programmed by your installer or customer service representative.

Note: Your system administrator can also assign alternate routes for destination codes that are defined to run on a schedule. In this case, alternate routes are offered only in the case where the original route is not available. Refer to the section on least-cost routing in the *Modular ICS Installer Guide*.

## Turning Services on and off

The master control for how different services and their schedules are used by your system is in programming. There are three settings: **Manual**, **Automatic** and **Off**.

- **Manual** allows you to turn the service on and off at any time from a control telephone using a feature code.
- **Automatic** allows you to use the preassigned stop and start time for a service. You are able to start and stop the service by entering the appropriate feature code at a control telephone. If you select this setting, you use the start and stop times programmed by your installer or customer service representative.
- **Off** prevents the service from being activated. In the case of restriction settings and routing, this means that the Normal schedule will be in effect.

You need the programming template found at the front of this guide. See *Getting started with Norstar* on page 13 for more information.

1. Press         .
2. Press      (the default System Coordinator password).
3. Press  twice. **Services** displays
4. Press . **Ringin9 Service** displays.
5. Press  until you see the service you want to program.
6. Press  and  until you see the schedule you want to program.
7. Press  and use **CHANGE** to select the setting that works best for your office: **Off**, **Manual** or **Automatic**.

Each schedule can have its own configuration of a Service which works independently of automatic start and stop times. For example, there may be a version of Restriction service called Night Schedule that prevents anyone from making long distance calls. But calling it Night Schedule does not mean it can only be used with a schedule. You can turn the Night Schedule for Restriction Service on or off, as needed, any time of the day or night. If you decide to run a service on a schedule, the system uses the start and stop times used for that schedule.

## An example of how to turn on a Service manually

You may have Ringing service, as your night service, set up to run according to the Night Schedule. You may decide you want that ringing arrangement to come into effect only when it is turned on and off manually.

You need the programming template found at the front of this guide. See *Getting started with Norstar* on page 13 for more information.

1. Press         .
2. Press      (the default System Coordinator password).
3. Press  twice. **Services** displays
4. Press . **Ringng Service** displays.
5. Press . The display reads **Sched:Night**.
6. Use **CHANGE** to set the Service to **Manual**.

Night Schedule for Ringing Service no longer follows the schedule but can be turned on and off by using the feature code and selecting Night Ringing. See *Turning Services on and off* on page 220.

## Turning Services on and off

The master control for services is in programming. See *Turning Services on and off* on page 218. Day-to-day use of Services is controlled using the following feature codes.

Turns on Ringing service. When used at the direct-dial telephone, it activates the alternate direct-dial telephone (extra-dial telephone).

Turns off Ringing service.

Turns on Restriction service.

Turns off Restriction service.

Turns on Routing service.

Turns off Routing service.

**To turn a Service on:**

1. Enter the appropriate feature code from a control telephone.
2. For Restriction and Routing service you have to enter the System Coordinator or Basic password.
3. Press **NEXT** to move through the schedules until the display shows the version of the service you want to be turned on.
4. Press **OK** to select the setting, or press **QUIT** to exit the feature without making any changes.

**To turn a Service off:**

1. Enter the appropriate feature code from a control telephone.
2. For Restriction and Routing service you have to enter the System Coordinator or Basic password.

***Do not confuse activating Normal service with canceling a Service.***

Setting a Service to Normal is not the same as canceling a Service using a feature code. If you set the Service to Normal, the normal version of a Service overrides any automatic schedule and remains in effect until you manually cancel it. If you cancel the Service, you return to the automatic schedule.

**Viewing the active Services on a two-line display**

When a Service is active, the control telephone display reads **Services ON**.

1. Press **LIST**. The display shows the first active Service and the schedule that is in use.
2. If there are several active Services, press **NEXT** to see them all.

3. Press **EXIT** to exit the feature.

## Viewing the active Services on a one-line display

1. Press **[\*]** **[8]** **[7]** **[0]**. The display shows the first active Service.
2. Press **[#]** to move through the active schedule.
3. Press **[END]** to exit.

### Displays

```
<Sched> Restr'n
EXIT          NEXT
```

You are viewing the active Services. Press **[#]** or **NEXT** to see the other active Services. Press **[END]** or **EXIT** to quit.

```
<Sched> Restr'n
QUIT   OK   NEXT
```

The name of the current Restriction service schedule displays. Press **[#]** or **NEXT** to see the other Ringing service schedules. Press **[\*]** or **OK** to select the desired schedule.

```
<Sched> Ringing
EXIT          NEXT
```

You are viewing the active Services. Press **[#]** or **NEXT** to see the other active Services. Press **[END]** or **EXIT** to quit.

```
<Sched> Ringing
QUIT   OK   NEXT
```

The name of the current Ringing service schedule displays. Press **[#]** or **NEXT** to see the other Ringing service schedules. Press **[\*]** or **OK** to select the desired schedule.

```
<Sched> Routing
EXIT          NEXT
```

You are viewing the active Services. Press **[#]** or **NEXT** to see the other active Services. Press **[END]** or **EXIT** to quit.

```
<Sched> Routing
QUIT   OK   NEXT
```

The name of the current Routing service schedule displays. Press **[#]** or **NEXT** to see the other Routing service schedules. Press **[\*]** or **OK** to select the desired schedule.

```
<Sched> until *
QUIT   OK   NEXT
```

Press **[\*]** or **OK** to select this schedule, **[#]** or **NEXT** to see the next available schedule, or **[END]** or **QUIT** to exit. If you select this schedule, it is in effect until the next automatic schedule takes effect.

No services ON

You have entered the Show Services feature code and there is no active Service.

Services ON  
LIST

There is a Service active in your system. Press [\*] or LIST to view the active Services.

For other displays, see *Common feature displays* on page 257.

Services that have been turned on automatically are indicated by an asterisk (\*) before the name on the display. You can neither manually activate nor cancel automatically-scheduled services, although you can override them by manually turning on another schedule.

The control telephone can override Services that are turned on and off according to a schedule at any time by entering a Services feature code, and then selecting a different schedule. This override remains in effect until it is canceled. If you select a schedule with an asterisk (\*), the next automatic service schedule comes into effect at the programmed time.

Direct-dial calls to a direct-dial telephone ring at the extra-dial telephone only when you enter the Ringing service feature code ([\*] 8 7 1) at that direct-dial telephone. Note that only the extra-dial telephone is activated, not the actual Ringing service. This is the case unless that direct-dial telephone is a control telephone. The extra-dial telephone is designated by your installer or customer service representative.



**Tip** - Norstar provides six service schedules named Night, Lunch, Evening, Sched 4, Sched 5, and Sched 6. Your installer or customer service representative can change these names to suit your business.

## Using passwords

Your passwords prevent unauthorized or unintentional changes to your Norstar system. To keep your telephone service secure, distribute the password only to selected personnel or make use of the basic password described below. Record your password in a secure place and change it periodically.

If you forget the administration or basic passwords, you cannot do any programming. Call your customer service representative to assign a new password.

The password is a one to six-digit number. It is advised to make your password at least six digits long for security reasons. If you press **CHANGE** but do not enter a new password, the existing password is erased. Anyone can then access programming without a password.

The default System Coordinator password is  , which is the same as  .

One password cannot be a subset of another one. For example, you cannot have 123 and 12345.

### Using a Basic password

In addition to a System Coordinator password, there is a Basic password. This allows you to delegate some of the duties of being a system coordinator to someone else without allowing access to sensitive programming.

The default Basic password is  or  .



You can enter the Basic password after the following feature codes:

- \* \* U S E R to access User Preferences
- \* \* T I M E to change the system time and date

Because the Basic password can be used to change the time, you should give it out with care and change it when necessary, for example, when an employee leaves the company. If restrictions, routing or other services operate on a schedule, changing the time can allow someone to bypass the programming.

## Registration password

The Registration password is used to control the registration of Companion portables to the Norstar system. See the *Modular ICS Companion System Coordinator Guide* for more information.

## Changing passwords

You need the programming template found at the front of this guide. See *Getting started with Norstar* on page 13 for more information.

1. Press  \* \* 2 6 6 3 4 4 .
2. Press      (the default System Coordinator password).
3. Press  four times. **Passwords** displays.
4. Press  . **Call Log Pswds** displays.
5. Press  until you see **Programing Pswds** ▶.
6. Press  . **Sys Admin:** displays.

7. Press  until you see the name of the password you want to change.
8. Use , **CHANGE** and the dialpad to enter the new password. Press **OK** to accept the new password.

You cannot erase or eliminate the ability to program passwords.

## Clearing a Call Log password

If an individual has forgotten their Call Log password, you can clear it in programming. The individual can then enter a new password from his or her telephone.

You need the programming template found at the front of this guide. See *Getting started with Norstar* on page 13 for more information.

1. Press         .
2. Press      (the default System Coordinator password).
3. Press  four times. **Passwords** displays.
4. Press . **Call Log Pswds** displays.
5. Press  and enter the internal telephone number of the telephone where you want to clear the Call Log password.
6. Press , then press **CLR** to clear the password after the **Log Pswd:** prompt.

---

## Hospitality passwords

There are two passwords within the Hospitality feature. One provides secure access to the administration set for programming the service, and one provides secure access to a room condition setting from each room set for housekeeping staff.

### Desk pswd

Change this administration password frequently, to maintain security.

At Hospitality:

1. Press . **Desk Pswd:** displays. (default is 4667)
2. Press **CHANGE**. **New Pswd:** displays
3. Enter a new password, then press **OK**.

### Cond pswd

Change this password frequently, to maintain security.

At Hospitality:

1. Press . **Desk Pswd:** displays.
2. Press . **Cond Pswd:None** displays.
3. Press **CHANGE**. **New Pswd:** displays
4. Enter a new password, then press **OK**.

## Silent Monitor password

Users must enter a password when they use      to monitor Hunt group calls.

It is advisable to change this password frequently.

At **SM PAsswd** (default: 745368 (SILENT)):

1. Press **CHANGE**.

**NEW Pswd:** displays

2. Use the keypad to enter a new password.
3. Press **OK**.

## Using special telephones

### Direct-dial

You can reach the direct-dial telephone by dialing a single digit. The direct-dial telephone is usually in a central location, such as at the desk of an administrative assistant or attendant. You can have up to five direct-dial telephones for your Norstar system. It is usually the prime telephone or the central answering position (CAP).

The direct-dial telephone can send up to 30 messages and can invoke Services to activate the extra-dial telephone.

You cannot forward calls to a direct-dial telephone that is outside your Norstar system. See *Making changes to Call Forward No Answer* on page 37.

**Note:** ISDN terminals cannot use the Direct-Dial digit to reach a Direct-Dial set.

## Changing the direct-dial telephone assignments

Your installer or customer service representative sets up the direct-dial telephone.

You can change which direct-dial telephone a telephone is assigned to, or assign it no direct-dial telephone.

You need the programming template found at the front of this guide. See *Getting started with Norstar* on page 13 for more information.

1. Press         .
2. Press      (the default System Coordinator password).
3. Press  at **Terminals&Sets**.
4. Enter the internal number of the telephone you want to program and press . The display reads **Capabilities**.
5. Press .
6. Press  until the display reads **D-Dial**.
7. Press **CHANGE** to select **Set1, Set2, Set3, Set4, Set5** or **None**.

Any number of telephones can be assigned to call the direct-dial telephone.



**Tip** - *The digit you dial in order to get the direct-dial telephone to ring can be programmed by your installer or customer service representative.*

*The Norstar system cannot verify that the number you assign as an external direct-dial telephone is valid. Check the number before assigning it as a direct-dial telephone, and call the direct-dial telephone after you've assigned it in order to test it.*

## Hotline

A hotline telephone calls a preset internal or external telephone number when you pick up the receiver (or press the handsfree button).



**Tip** - *Label the telephone to inform anyone using it that Hotline is active.*

## Bypassing a Hotline

Press a line button, or use the Pre-Dial or the Automatic Dial feature before you pick up the receiver or press the handsfree button on a hotline telephone. See the *Telephone Feature Card* or see *Changing how you dial your calls* on page 82.

## Making a telephone a hotline telephone

You can set up a telephone as a hotline.



**Tip** - *A Hunt Group set DN can be specified as a Hotline telephone. For more information about Hunt Groups, see *Programming Hunt Groups* on page 169.*

You need the programming template found at the front of this guide. See *Getting started with Norstar* on page 13 for more information.

1. Press         .
2. Press      (the default System Coordinator password).
3. Press  at **Terminals&Sets**.

4. Enter the internal number of the telephone you want to program.
5. Press  . The display reads **Capabilities**.
6. Press  .
7. Press  until the display reads **Hotline**.
8. Press **CHANGE** to select the type of call the hotline makes: **None**, **Intrnl**, or **Extrnl**.
  - Internal assigns an internal number.
  - External assigns an external number.

If you select an external number, you can select the line on which the call is made:

- the prime line
- an external line
- a line in a line pool, and a line pool access code  
For this type of line, you must specify the line pool access code.
- a line selected by the routing table  
For this type of line, the number dialed is treated as a destination code and is routed according to the routing tables.

A prime line, line pool access codes, and access to a line pool can be programmed by your installer or customer service representative.

## Control telephone

The control telephone allows you to place the telephones and external lines for which it has responsibility into and out of service schedules. See *Using alternate or scheduled services*

on page 217. Settings for this telephone can be copied from one control telephone to another.

## SM Supervisor

A telephone designated as an SM Supervisor allows you to monitor Hunt group calls without or without a conference tone indicator to the other two parties. See *Using Silent Monitor* on page 180.

## Using Set lock

Set lock limits the ways in which you can customize your telephone. There are three levels of Set Lock: **Full**, **Partial**, and **None**. **None** allows you to access all features on your telephone.

Partial prevents:

- |  |   |
|--|---|
| <ul style="list-style-type: none"><li>• programming autodial buttons</li><li>• programming user speed dial numbers</li><li>• programming feature buttons</li><li>• moving line buttons</li><li>• changing the display language</li></ul> | <ul style="list-style-type: none"><li>• changing dialing modes (Automatic Dial, Pre-Dial, and Standard Dial)</li><li>• using Voice Call Deny</li><li>• saving a number with Saved Number Redial</li></ul> |
|--|---|

Full, in addition to the restrictions outlined for Partial lock, prevents:

- |   |  |
|---|--|
| <ul style="list-style-type: none"><li>• changing Background Music</li><li>• changing Privacy</li><li>• changing Do Not Disturb</li><li>• using Ring Again</li></ul> | <ul style="list-style-type: none"><li>• using Call Forward all calls</li><li>• using Send Message</li><li>• using Trunk Answer</li><li>• activating Services</li></ul> |
|---|--|



## Changing Set Lock programming for a telephone

You need the programming template found at the front of this guide. See *Getting started with Norstar* on page 13 for more information.

1. Press         .
2. Press      (the default System Coordinator password).
3. Press  at **Terminals&Sets** and enter the internal number of the telephone you want to program.
4. Press .
5. Press  until the display reads **Restrictions**.
6. Press  twice.
7. Press  until the display reads **Set lock**.
8. Use **CHANGE** to select one of the three options: **None**, **Partial** and **Full**.

## Using an auxiliary ringer

An auxiliary ringer is a separate device that has to be connected to Norstar. Refer to the section on installing optional equipment in the *Modular ICS 6.1 Installer Guide*.

### Turning the auxiliary ringer for a telephone on or off

You need the programming template found at the front of this guide. See *Getting started with Norstar* on page 13 for more information.

1. Press         .
2. Press      (the default System Coordinator password).

3. Press  at **Terminals&Sets**.
4. Enter the internal number of the telephone you want to program and press . The display reads **Capabilities**.
5. Press .
6. Press  until the display reads **Aux. ringer**.
7. Use **CHANGE** to select **Y** (Yes) or **N** (No).

Your installer or customer service representative can program the auxiliary ringer to start ringing for incoming lines as part of Ringing Service.

## Using Host System dialing signals

You can access host systems, such as private branch exchanges (PBX) from Norstar by using host system signaling features (known as end-to-end signaling). These features either send a special signal to the host system or allow you to program delays required by host systems in external autodial or speed dial sequences.

### Link

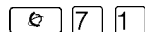

If your Norstar system is connected to a private branch exchange (PBX), you can use a Link signal to access special features. On some telephones, Link is called FLASH.

The Link signal can be included as part of a longer stored sequence on an external autodial button or in a speed dial code. The Link symbol (**☎**) uses two of the 24 spaces in a dialing sequence.

## Preventing a telephone from using Link

Link can be restricted at individual telephones. You need the programming template found at the front of this guide. See *Getting started with Norstar* on page 13 for more information.

1. Press  \* \* 2 6 6 3 4 4 .
2. Press      (the default System Coordinator password).
3. Press  and enter the internal number of the telephone you want to program.
4. Press  . **Capabilities** displays.
5. Press  three times. The display reads **Restrictions**.
6. Press  twice.
7. Press  three times. The display reads **Allow link:**.
8. Press **CHANGE** to choose **Y** (Yes) or **N** (No).



**Tip** - *If your Norstar system is connected to a private branch exchange (PBX), program Link onto a memory button for one-touch access.*

## Pause

 7 8

The Pause feature enters a 1.5-second delay in a dialing sequence on an external line. This is often required for signaling remote devices, such as answering machines, or when reaching through to PBX features or host systems.





You can program more than one pause in an external autodial or speed dial sequence.

The Pause symbol () uses one of the 24 spaces in a dialing sequence.

For pulse dialing,  inserts a 1.5-second pause into the dialing sequence.

## Long Tones



The Long Tones feature allows you to control the length of a tone so that you can signal devices such as fax or answering machines which require tones longer than the standard 120 milliseconds.

1. While on a call, press    .
2. Press the dialpad buttons to produce the appropriate tones. Each tone sounds for as long as you hold down the button.

Long tones can be used on any call except a conference call. You can use internal lines of the Norstar system to activate a device connected to an analog terminal adapter (ATA) in another area of your office, or external lines to access devices outside the Norstar system.

## Displays

Long Tones:

At the appropriate time, press any dialpad button. Hold each button down for as long as necessary. Press  or  to cancel Long Tones.

## Programmed Release



   

The Programmed Release feature performs same function as  in a programmed dialing sequence. When the system encounters Programmed Release in a dialing sequence, it stops dialing and hangs up the call.

The Programmed Release symbol () takes up two of the 24 spaces in a programmed dialing sequence.

The system ignores any digits or commands that follow a Programmed Release in a programmed dialing sequence.

## Run/Stop

Run/Stop inserts a break point into a sequence of dialed numbers or characters used for automatic dialing. This may be necessary when you are connecting to a PBX or similar host system.

For example, you can call a company with an automated attendant that instructs you to dial the internal number you need. You can program the company number, a Run/Stop, then the internal number on one external autodial button. Press the autodial button once to dial the company number. When you hear the automated attendant, press the autodial button again to dial the internal number.

The Run/Stop symbol (**#**) uses one of the 24 spaces in an autodial or speed dial sequence.

You can include up to three Run/Stop commands in a dialing string. The system ignores a fourth Run/Stop, and any digits or commands that follow it in a programmed dialing sequence.

## Wait for Dial Tone

**#** 8 0 4

Wait for Dial Tone causes a sequence of numbers to pause until dial tone is present on the line before continuing to dial. This is useful if you must dial a remote system and then wait for dial tone from that system before dialing the rest of your number.

The Wait for Dial Tone symbol (**#**) uses two of the 24 spaces in an autodial or speed dial sequence.

### Displays

Invalid code

You have entered a code that can be used only in a programmed autodial or speed dial sequence, not on a call you dial directly. Programmed Release and Run/Stop are for use in programmed dialing sequences only.

## Using tone dialing for a call

If your external telephone lines use tone dialing, you can temporarily switch to tone dialing by pressing **#** after selecting the line. Tone dialing allows your Norstar telephone communicate with devices and services that respond to tone signals, such as automatic switchboards, and fax or answering machines.

## Using your Norstar system from an external location

You can use the lines and some of the features of a Norstar system from outside the system. You can do this over the public telephone network when you are away from the office, or you can call from another system, over a private network.

An example of how remote access works is a sales representative who spends a lot of time out of the office and who needs to make long distance calls to the European office. Your Norstar system has a leased line to Europe with reduced transatlantic charges. You provide the sales representative with a Class of Service (COS) password that gives access to the transatlantic line. The sales representative can then telephone into the Norstar system from a hotel, enter their Class of Service password, and use the leased transatlantic line to make calls.

Remote users can access Norstar lines, line pools, the page feature, and remote administration, if that features is enabled through Software Keys. The exact facilities available to you through remote access vary, depending on how your installer or customer service representative set up your system.



**Tip** - *If the loop start line used for remote access is not supervised, auto-answer does not function and the caller hears ringing instead of a stuttered tone or the system dial tone.*

## Controlling access to your Norstar system

It is important to maintain the security of your Norstar system by limiting access to authorized users and limiting those users to the features they need.



### ***Remote users can make long distance calls.***

Remember, a remote user can make long distance calls that are charged to your company and can make page announcements in your office unless you create the proper restrictions for external access lines.

## Direct inward system access (DISA)

Control access to your Norstar system with direct inward system access (DISA). Access to your Norstar system from the public telephone network should always be controlled with DISA. If your installer or customer service representative programs the line used for remote access to answer a call automatically and wait for a DISA internal number, callers hear a stuttered dial tone and must enter a Class of Service password before they are allowed into the system.

## Class of Service (COS)

To control the level of telephone service a remote user can access, your installer can assign a remote filter and remote package to the line used for remote access. The remote filter restricts the numbers that can be dialed on the line, and the remote package restricts the use of line pools and the page feature. To change the restrictions for the line, the user can enter their Class of Service (COS) password when the system answers with DISA, or can dial the DISA internal number and enter their Class of Service password.



## Maintaining security

To maintain the security of your system, the following practices are recommended:

- Warn anyone to whom you give the remote access number, to keep it confidential.
- Change Class of Service passwords often.
- Warn anyone to whom you give a Class of Service password, to remember it and not to write it down.
- Remove the Class of Service password of anyone who leaves your company.

## Accessing Norstar remotely over the public network

1. Dial the Norstar system remote access number.
2. When you hear a stuttered dial tone, enter your COS password.
3. Wait for the system dial tone.

To use the system remotely, you must use a telephone with tone dialing to call the system.

Remote access is possible only on lines that your installer or customer service representative programs to auto-answer calls.

To use features on a remote Norstar system, press  followed by the feature code. Even if you are calling from a Norstar system, such as within a private network, press  instead of .

In certain situations, you may experience lower volume levels when using Norstar remotely.

## Tones

You may hear some of the following tones while accessing Norstar remotely.

Tone	What it means
Busy tone	Dialed a busy line pool access code. You hear system dial tone again after five seconds.
Norstar system dial tone	You may use the Norstar remotely.
Fast busy tone	<p>You have done one of the following</p> <ul style="list-style-type: none"> <li>• Entered an incorrect COS password. Your call is disconnected after five seconds.</li> <li>• Taken too long while entering a COS password. Your call is disconnected after five seconds.</li> <li>• Tried to use a line pool or feature not permitted by your Class of Service. You hear system dial tone again after five seconds.</li> <li>• Dialed a number in the Norstar system which does not exist. Your call is disconnected after five seconds.</li> </ul>
Stuttered dial tone	Enter your COS password.

## Using Class of Service (COS) passwords

Class of Service passwords permit controlled access to system resources both by internal and remote users. When you enter a Class of Service password at a telephone, the restriction filters associated with your Class of Service password apply, rather than the normal restriction filters. Similarly, when a remote user enters a Class of Service password on an incoming auto-answer line, the restriction filters and remote package associated with their Class of Service password apply, rather than the normal restriction filters and remote package. COS passwords are programmed by either your customer service representative or installer.



Users should memorize their COS passwords instead of writing them down. Typically, each user has a separate password. Several users can share a password or one user can have several passwords.

Individual COS passwords should be deleted when an employee leaves the company. Group COS passwords should be changed if one of the group members leaves the company.

## Changing your Class of Service

You must enter a Class of Service password each time you want to make a call that is normally restricted on a line or telephone.

To change the restriction filters on a line or telephone:

1. Press   .
2. Enter your six-digit COS password.

COS passwords allow you to define individual passwords and determine the restriction filters, and remote package associated with each.



**Tip** - *If you use your Norstar system from outside the office, you may have to enter a Class of Service password to gain access to the system. See Using your Norstar system from an external location on page 239.*

### Displays

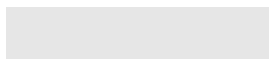

(Blank display) Enter your password. It is not shown on the display.

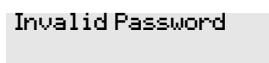

You have entered a password that is not programmed into your system.



# General System features

The following features are available for the entire Norstar system.

## Set profile

Set profile allows you to view but not change the programming settings for each Norstar set. You can access Set Profile from any M7310, M7324, or T7316/T7316E telephone, even while you are on a call.

1. Press **[☎] [\*] [\*] [S] [E] [T]**.
2. Enter the internal number of the telephone whose programming you want to review.
3. Use **BACK**, **SHOW** and **NEXT** to navigate through the settings.

## Line profile

Line profile allows you to view but not change the programming settings for each Norstar line. You can access Line Profile from any M7310, M7324, or T7316/T7316E telephone, even while you are on a call.

1. Press **[☎] [\*] [\*] [L] [I] [N] [E]**.
2. Enter the number of the line whose programming you want to review.
3. Use **BACK**, **SHOW** and **NEXT** to navigate through the settings.

## Pulse or tone dialing

If your external lines use pulse dialing, you can switch temporarily to tone dialing to communicate with devices such as answering machines, to access the features that PBX systems may offer, or to use another Norstar system remotely.

Press **#** while on an active line. Once you hang up, your telephone returns to pulse dialing.

## Disconnect supervision

When Disconnect Supervision is assigned to a line, the Norstar system monitors it to detect if an external caller hangs up. This allows the system to release the line for other uses. Your installer or customer service representative assigns disconnect supervision.

## Hunt Groups

Your Norstar system allows you to establish Hunt Groups. Hunt Groups are a group of Norstar or BST telephones which can be called by a single directory number. The Hunt Groups feature ensures calls are easily routed to the appropriate people.



You can also monitor hunt group calls using the Silent Monitoring feature.

For more information about Hunt Groups and the Silent Monitoring feature see *Programming Hunt Groups* on page 169.

---

## Internal numbers

Each telephone in the Norstar system has its own internal number. The length of internal numbers in your system can be from three to seven digits. All numbers in your system are the same length. Your installer or customer service representative sets the length of internal numbers, called the DN length. The default DN length is three.

To find out your internal number, use the Button Inquiry feature (  \*  ) on an intercom button. On the M7100 or the T7100 sets, Button Inquiry shows your internal number, followed by the function assigned to your single-memory button.

## Line assignment

Any of the lines in your system can be assigned to any of your telephones. Your installer or customer service representative assigns lines to telephones in **Configuration** programming, under **Terminals&Sets**. Lines can be assigned to appear only, appear and ring, or to ring only.

Usually, only the lines that are appropriate for a particular person appear at their telephone. When a line is assigned to a telephone, it is automatically given a line button on that telephone, if a button is available. The M7100 and the T7100 sets do not have line buttons.

Calls on lines that ring, but which do not appear at a telephone, are presented at an intercom button.

You may be able to answer a call on a line that does not appear or ring at your telephone. To pick up such a call, use Call Pickup, Call Park, or Trunk Answer.

A telephone may have buttons assigned for lines 001 to 003, but have only lines 001 and 002 programmed to ring as well. An incoming call on any of the three lines causes a line button indicator to flash, and the telephone can be used to answer the call. This is especially useful for people who monitor other telephone lines, but want only their own lines to ring.

## Target line

A target line is used to route a call directly to a particular telephone or group of telephones. Target lines are used only for incoming calls. A single incoming line may provide connections to several different target lines. This allows each person or department in the office to have their own number without having a separate external line for each number.



**Tip** - *The maximum number of target lines available in the fully expanded XC system is 192.*

*Maxi system: lines 157-284*

*Expanded: lines 157-348*



### **Privacy issue**

You can set a target line to Private (default is Public), however, such features as Call Pickup can still answer these lines at remote telephones.



## Line pools

A line pool allows each telephone access to external lines from a group (or pool) of external lines. You can access such lines by pressing an intercom button and entering a line pool access code or a destination code, or by pressing a memory button programmed with the line pool feature code and a line pool access code.

## Overflow call routing

If a call comes in for a target line that is busy, Norstar routes the call to the prime telephone for that target line. If there is no prime telephone assigned to the target line, or if a call cannot be directed to a target line, the call goes to the prime telephone for the external line used.

Overflow routing for incoming calls is used with the Routing Service programmed by your installer. A Service must be active for overflow routing to be in effect. Overflow routing is not available in Normal service.





**Tips** - *When you make a call and the programmed route is busy, you hear the expensive route warning tone and see a display indicating that an expensive route is being used. To avoid using the normal, expensive route, release your call.*

*Because overflow routing directs calls using different line pools, a call may be affected by different line filters when it is handled by overflow routing.*

*If you are not sure how the filters are assigned, refer to the Programming Record for a description of line filters and for a list of line assignments.*

## M7100 and T7100 telephones

These telephones do not have line buttons, therefore, they work differently from other Norstar telephones.

- Where other telephones can require that you select a line button to answer a call, on the these telephones you simply pick up the receiver.
- Where other telephones require you to select a line button to take a call off hold, you press  on the these telephones.
- Also on these telephones, you can answer a second call by pressing . Your active call is put on hold and you are connected to the waiting call. You can have no more than two calls at a time.

There is no handsfree button on these telephones. When applicable, special instructions are included with each feature description.

### Memory buttons

Memory buttons are the buttons with indicators on the M7208, M7310, M7324, T7208, and T7316/T7316E telephones. The M7310 also has dual buttons without indicators. There is a single memory button, without an indicator, on the M7100 and the T7100 telephones.

Memory buttons can be configured as answer, autodial, line, and programmed feature buttons. Line, intercom and answer buttons must have indicators, and are programmed by the system administrator.

## One-line display







The M7100, M7208, T7100 and T7208 telephones have a one-line display.

Other telephones have a second line on the display which shows the functions of the three buttons directly below it. These indicators are known as display buttons.

Some display buttons, such as TRANSFER and ALL, are simply shortcuts which are not available on a one-line display.

Other display buttons, such as OK and SHOW, perform essential functions. For a one-line display telephone, use the following buttons instead of these display buttons.

### Substitutes for display buttons

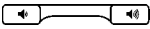
Display button	Dialpad button	Display button	Dialpad button
<u>OK</u>		<u>CANCEL</u>	
<u>QUIT</u>		<u>VIEW</u>	
<u>ADD</u>		<u>OVERRIDE</u>	
<u>SHOW</u>		<u>BKSP</u>	

All displays listed in this book are shown as they appear on the two-line display.

## Prime line

Your telephone can be programmed to select an internal or external line or a line pool automatically whenever you lift the receiver or press the handsfree button. This is your prime line.

## Private lines

A private line is exclusive to a particular telephone. Calls that are put on hold or left unanswered on a private line cannot be picked up at any telephone except the prime telephone.

## Volume bar

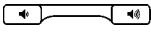
The volume bar controls the volume of the receiver, telephone ringer, handsfree speaker, and headset. Press either end of the volume bar  to adjust the volume.

# Troubleshooting

## Using the alarm telephone

An alarm telephone displays Modular MICS system alarm codes, should they occur. Alarm telephones are Norstar telephones or Business Series Terminals with two-line displays that are specifically assigned by the installer to receive system alarm codes.

## Reporting and recording alarm codes

If an alarm message appears on the alarm telephone display:

1. Record the alarm number.
2. Press TIME and record the time displayed.
3. Call your installer or customer service representative and report the alarm code.
4. After speaking to your installer or customer service representative, press CLEAR.

### Displays



Alarm:	61-4-2
TIME	CLEAR



Report this alarm and the time it occurred to your installer or customer service representative.

## Testing the telephone

If you suspect something is wrong with a button, the speaker, the displays, or some other part of the telephone hardware, you can do a quick test to see which part of the telephone is broken.









**Tip** - *Ensure that the function of a button matches its label by pressing    and then pressing the button to see its function.*

*You can end the telephone testing session anytime by pressing  or , unless you are testing those buttons. The test feature times-out after 30 minutes of no activity.*

### Testing the telephone display







Use a display test if you suspect that one of the indicators on the telephone is not working.

1. Press    . The display reads **Display test**.
2. Press **TEST** or  to go ahead with a display test.
3. Adjust the contrast for the telephone display so you are able to see the test results clearly. Enter a number to change the contrast or press **DOWN** and **UP**.
4. Press **OK** or  to go ahead with the test.

During the test, the display should be filled with solid, dark blocks and all the indicators next to the buttons on the telephone should be turned on. Any Busy Lamp Field (BLF) or CAP modules or KIMs attached to the telephone should be completely lit. You lose any information that was showing on the BLF before the test started.







Pressing any button ends the test.

## Testing the telephone buttons

1. Press    , then  or **NEXT**.
2. Press **TEST** or  to go ahead with a button test.
3. Press the button to see its function. If the button you pressed uses an indicator, it turns on when you test the button.
4. Pressing the  button puts **Rls button** on the display briefly and returns you to the **Button test** display.







## Testing the speaker in the telephone handset

The handset test is not available if you have a headset plugged into the telephone.

1. Press    , then  or **NEXT** twice. The display reads **Handset test**.
2. Press **TEST** or  to go ahead with a handset test.
3. Pick up the handset and listen. Dial tone sounds through the handset at maximum volume. The volume is reset to maximum only while the test is going on.
4. Pressing any button or hanging up ends the test.

## Testing the telephone headset







The headset test is not available to telephones that do not have a headset jack or a headset plugged in.

1. Press    , then  or **NEXT** until the display reads **Headset test**.
2. Press **TEST** or  to go ahead with a headset test.

You should hear dial tone through the headset. The volume is reset to a default level during the test.

3. Pressing any button ends the test.







### Testing the telephone speaker

1. Press    , then  or **NEXT** until the display reads **Speaker test**.
2. Press **TEST** or  to go ahead with a speaker test.

A page tone sounds through the telephone speaker at the maximum volume. The volume returns to its previous setting when you end the test.

3. Pressing any button ends the test.

### Testing the power supply to a telephone

1. Press    , then  or **NEXT** until the display reads **Power test**.
2. Press **TEST** or  to go ahead with a power supply test.

You should see all the indicators on the telephone go on and hear ringing at maximum volume. When the test has ended, the display should briefly show **Power OK**.

The test lasts for five seconds or until you press a button.



# Common feature displays

You may see the following displays when you use a feature.

Access denied

Someone is already using programming, or the feature you are trying to use is not compatible with the configuration of the telephone or line.

Denied in admin

You have tried to use a feature, but you have not been given access to it in administration programming.

Feature timeout

You have taken more than 15 seconds to press a button in response to a display.

Inactive feature

You have entered a feature code that is used by an application program that your system does not have.

Invalid code

You have entered an invalid feature code.

Not available

You have tried to use a feature that is not available in the present setup of your Norstar system.

Set locked

You cannot use the feature you have chosen because your telephone is locked. See *Using Set lock* on page 232.

1234567890123...  
VIEW→ OK

Press **#** or press **VIEW→** or **←VIEW** to view a number that is too long to fit on the display. Press **☺** or **OK** when you are finished.

S

This indicates a long distance call. (May be available with Call Display services.)

239>221

You are receiving an internal call from telephone 239 forwarded by telephone 221 or you have an Answer button for telephone 221 and an internal call from 239 is ringing on 221.

221  
TRANSFER

You are connected to an internal call. Press **TRANSFER** to transfer the call.

221 calling

You are receiving a call from telephone 221.

Call 221?  
YES NO

You have received a Ring Again offer for a call to an internal telephone. Press the flashing internal line button or YES to call the number again. On M7100 or T7100 telephones, just lift the receiver. Otherwise, press NO or wait 30 seconds for the Ring Again offer to expire. For an explanation of Ring Again, see *Using Ring Again* on page 85.

Camped: 221  
CALLBACK

The person to whom you camped the call did not answer it. The call has come back to you. Press the line button or CALLBACK to reconnect to the call.

Line001  
TRANSFER

You are connected to an external call. Press TRANSFER to transfer the call.

Line001>221

You are receiving an external call forwarded from telephone 221 or you have an answer button for telephone 221 and an external call is ringing on that telephone.

Line001 transfer

The call on line 001 is being transferred to you by someone else in your Norstar system.

Line001 waiting

A camped call is waiting. Press the line button or use Call Queuing to answer the call. Press  if you have M7100 or T7100 telephones.

No calls waiting

You tried to use Call Queuing but no call was ringing at your telephone.

No line selected

There is no call ringing at your telephone. If you have a flashing line button but your telephone is not ringing, press the line button to answer the call on that line.

Not in service

The telephone to which you directed a call is not in service or is otherwise unavailable. The call is returned to your telephone.



Parked call  
CALLBACK

No one answered the call you parked. The call has come back to you.

Pick up receiver

You have used the Call Queuing feature without picking up the receiver. Auto handsfree has not been assigned to your telephone. You must use the receiver or the button marked handsfree/mute to answer a call.

Priority> 221  
BLOCK

You are receiving a priority call. If you are on another call, inform the person you are speaking to that you are about to put the call on hold. Press the flashing line indicator of the priority call or wait until the call connects automatically (eight seconds). The priority call goes through when you hear the next beep. Your active call is placed on Exclusive Hold. It is reconnected automatically when the priority call ends, unless you transfer the priority call, in which case you must press the line button of your original call to reconnect). Use DND (  ) or press **BLOCK** to reject a priority call.

Release a call

You have no free line buttons on which to receive a call. Release one of your current calls and try again to answer the incoming call.

Use line pool?  
YES NO

You have received a Ring Again offer for a line pool. Press the flashing internal line button or **YES** to use the line pool. On M7100 and T7100 telephones, just lift the receiver. Otherwise, press **NO** or wait 30 seconds for the Ring Again offer to expire.

Hold or release



You cannot program a feature button while you are on a call.

Release calls

You have tried to use a feature while you were on a call or had calls on hold. Release the call or calls, before using the feature.

Line in use

The line is in use. Make the call using normal methods or wait until the line is free.

No button free	You have tried to make, receive or pick up a call when no line button was available. Some features require you to have a button free. Releasing calls can free up line buttons.
Make calls first	The feature you tried to use requires you to be on an active call at your telephone. This display appears when information about a call has been cleared by a system reset.
No free lines	All the lines or line pools available to the telephone are in use. This display appears when you have tried to dial an external number or use a feature that conflicts with the lines, line pools or prime line used by the telephone. This must be corrected by your customer service representative or installer.
No line selected	The telephone has been set up to dial an external number on a prime line but the telephone does not have a prime line. This must be corrected by your customer service representative or installer.
In use:221	You have tried to program redirection while someone else is programming redirection. Only one person can program line redirection at a time.
Incoming only	The line you are trying to use for redirecting calls is for incoming calls only. Choose an outgoing line.
9_ QUIT BKSP OK	Continue entering digits. Press   or <u>BKSP</u> to delete incorrect digits. Press  or <u>OK</u> when you are finished.
Invalid number	You have entered an invalid line pool code or an invalid destination code.
Line denied	You have selected a line that is private to another telephone.
Restricted call	The destination you have chosen for line redirection is restricted.

# Glossary

## A

**access code:** Different sequences of characters used to gain access to these Norstar features: Line pools, Call park, external lines, Direct-Dial telephone, Auto DN, and DISA DN. Destination codes are also a form of access code.

**alarm code:** A number that appears on the alarm telephone display, informing you that the ICS has detected a fault in the system.

**alarm telephone:** A telephone that is designated to receive reports of Norstar system problems. This function is usually assigned to a prime telephone, but this can be changed under **Feature settings** in **Sys Programming**.

**Answer button:** A telephone button with an indicator that is used to monitor another telephone. The answer button indicates incoming calls destined for the other telephone. Someone working at a telephone with answer buttons (an attendant, for example) can receive all ringing and visual indication of incoming calls for other telephones, and answer those calls when necessary.

One telephone can have up to four Answer buttons. An Answer button is automatically assigned to a telephone when that telephone is assigned an Answer DN.

**Answer DN:** The internal or directory number (DN) of a telephone that is monitored by an Answer button. You can assign up to four Answer DNs to a telephone under Line Access in Terminals and Sets programming.

**Autobumping:**    

A feature that determines what the system does with new Call Log items when your Call Log is full. When

Autobumping is on, a new log entry causes the oldest entry to be deleted. If Autobumping is off, your Norstar system does not log calls when your log is full.

**autodial button:** A memory button that, if programmed, provides one-touch dialing of external or internal numbers.

**autolog options:**    

A feature that allows you to select the type of calls that are stored in your Call Log. You can choose to log calls that were not answered by anyone within the system, to log calls that were unanswered at this telephone but which were answered elsewhere in the system, to log all calls answered and not answered at this telephone, or to not have calls automatically logged.

**Automatic Dial:** A feature that allows you to dial without having to pick up the receiver or select a line. You must have a prime line to use Automatic Dial. Automatic Dial is assigned under **Dialing options** in **Terminals&Sets** programming.

**Automatic handsfree:** A feature which automatically activates handsfree operation when you make or answer a call. Automatic handsfree is assigned under handsfree in **Terminals&Sets** programming.

**Automatic Hold:** A feature that automatically places an active call on hold when you select another line. **Automatic Hold (Full AutoHold)** is assigned in **Lines** programming.

**Automatic Privacy:** See Privacy.

**Automatic Daylight Savings Time:** A feature that switches the system to standard or daylight savings time at pre-programmed times. It is

turned on or off under **Daylight time** in **Sys PRGRMNG**.

### Automatic Telephone

**Relocation:** A feature that allows a telephone to retain personal and system programming when the telephone is plugged into a different Norstar modular jack. **Automatic Telephone Relocation** is enabled under **Set relocation** in **Sys PRGRMNG**.

**auxiliary ringer:** A separate external telephone ringer or bell which can be programmed to ring when a line or a telephone rings. An auxiliary ringer may be programmed to ring only when the system is in a particular schedule. Programming of an auxiliary ringer is done in **Services** programming after the feature has been enabled under **Capabilities in Terminals&Sets** programming.

## B

### Base station (XC 3.0 only): A

Companion component that is mounted on walls and ceilings to provide a radio link to an office or other area where Companion portable telephones are used. Each base station houses two radios that allow portables to send and receive calls through the ICS. (See also Companion Wireless)

**Background Music:** A feature that allows you to hear music from the speaker of your Norstar telephone. It is available only if a music source has been attached to the ICS and the feature has been enabled under **Feature settings** in **Sys PRGRMNG**.

**Basic password:** A one- to six-digit password that prevents unauthorized access to the most commonly-used telephone settings. The Basic password can be assigned and changed in **Passwords** programming.

**Business series terminals** These terminals were developed to replace the Norstar M-series terminals. Therefore, their functionality closely parallels the M-series terminals.

**busy lamp field (BLF):** A device with a liquid crystal display (LCD) panel of indicators that shows the status of up to 24 telephones in the Norstar system. The BLF attaches to the M7310 and T7316/T7316E telephones.

**button caps:** Interchangeable plastic caps that fit over the buttons of Norstar telephones. They are used to indicate the features programmed onto each programmable memory button. Button caps are either pre-printed or have clear windows that allow you to insert labels.

**Button Inquiry:**  \*

With this feature you can check the function of each programmable button on your system telephone.

## C

**Call Duration timer:**

A feature that allows you to see how long you spent on your last call, or how long you have been on your present call.

**Call Forward:**

A feature that forwards all the calls arriving at your telephone to another telephone in your Norstar system. To have calls forwarded outside the system, use Line Redirection.

**Call Forward No Answer:** A feature that forwards all calls arriving at your telephone to another designated telephone in your Norstar system after a specific number of rings. **Call Forward No Answer** is assigned under **Capabilities in Terminals&Sets** programming.

**Call Forward On Busy:** A feature that forwards all calls at your telephone to another designated telephone if your telephone is busy. This feature is assigned under **Capabilities in Terminals&Sets** programming.

**Call Forward Override:** An automatic system feature that allows you to call someone and ask them to stop forwarding their calls to you.

**Call Information:**

Call Information allows you to display information about incoming calls. For external calls, you can display the caller name, telephone number and the line name. For an internal call, you can display the name of the caller and the internal number. You can obtain information about ringing, answered, or held calls.

**Call Log:**

Enter your Call Log to view a record of incoming calls. The log could contain the following information for each call: sequence number in the Call Log, name and number of caller, long distance indication, indication if the call was answered, time and date of the call, number of repeated calls from the same source, and name of the line that the call came in on. See **Autobumping**, **Autolog** options, and **Call Log** for further information.

**Call Park:**

With this feature you can place a call on hold so that someone can retrieve it from any other telephone in the Norstar system by selecting an internal line and entering a retrieval code.

The retrieval code appears on the display of your telephone when you park the call. You can park up to 25 calls on the system at one time.

**Call Park Callback:** See **Callback**.

**Call Park prefix:** The first digit of the retrieval code of a parked call. This digit cannot conflict with the first digit of any existing DNs, Line Pool access codes, the Direct-dial digit, or the external line access code. The default Call Park prefix digit is 1. It may be set to none, in which case Call Park is disabled. **Call Park Prefix** is assigned under **Access codes in Sys Prgrmmng**.

**Call Pickup Directed:**

A feature that allows you to answer a call ringing at any system telephone by entering the internal number of that telephone before taking the call. **Call Pickup Directed** is enabled under **Feature settings in Sys Prgrmmng**.

**Call Pickup Group:** See **Pickup Group**.

**Call Queuing:**

If you have several calls waiting at your telephone, you can invoke the **Call Queuing** feature to answer them in order of priority. Priority is given to incoming calls, followed by callback and camped calls.

**Callback:** If you park, camp, or transfer a call to another telephone and it is not answered there, it will ring again at your telephone. How long the system will wait before **Callback** occurs is set under **Feature settings in Sys Prgrmmng**.

**Camp-on:**

A feature that allows you to reroute a call to a telephone even if all the lines on that telephone are busy. To answer a camped call, use **Call Queuing** or select a line if the camped call appears on your telephone. Priority is given to queued calls. Note: Systems which use a centralized voice mail system attached to a Meridian 1, can provide this service to all nodes of the network.

**Camp timeout:** The length of a delay before a camped call is returned to the telephone that camped the call. The length of delay is set under **Feature settings** in **Sys Programming**.

### Central answering position

**(CAP):** An M7324 telephone and one or more CAP modules or a T7316E telephone and one or more KIMs that are designated as a CAP under **CAP assign** in **Sys Programming**. The CAP provides backup answering and can be used to monitor the telephones within a Norstar system. Buttons can also be programmed under **Button Programming**, in this configuration.

**Class of Service (COS):** The set of Norstar features and lines available to the user for a call. The Class of Service for a call is determined by the restriction filters and remote access packages assigned to the telephone in **Lines** programming. The Class of Service for a call can be changed by entering a six-digit Class of Service password. (Internal users cannot change their access to features with a COS password, only their restriction filters.) **Class of Service** and **Class of Service Passwords** are assigned in **Passwords** programming. See Remote Access.

### Class of Service password:

A six-digit code that allows you to switch from your current Class of Service to one that allows you to dial numbers prohibited by your current Class of Service.

**Companion Wireless:** The name for Nortel Networks communication systems which use radio technology to transmit and receive signals between its components and the Norstar system. Companion Wireless provides mobility in the workplace. Calls that used to ring just at your Norstar set can also appear and ring at your portable.

### Companion portable telephone:

Hand-held wireless sets which allow complete mobility within the reach of Companion base stations or an external antenna. Portables offer many, but not all, Norstar features and share much of the same programming as wired desk sets.

### Conference:

A feature allows you to establish a three-person call at your Norstar telephone.

### contrast adjustment:

Allows you to set the contrast level of your telephone display.

**control telephone:** A control telephone can place the lines for which it has responsibility in or out of a Service Mode.

The direct-dial telephone is a control telephone for directing calls to the extra direct-dial telephone. A telephone is made a control telephone and has lines assigned to it in **Services** programming.

### Coordinated Dialing Plan: (CDP)

This dialing plan uses a steering code to identify each node in a private network. This one-digit code becomes part of the set DN number rather than a separate code. In this way, system A might have codes in range 2100 to 2999, whereas system B might have codes in range 3100 to 3999.

**COS:** See Class of Service.

**cursor:** A short horizontal line that appears on the system telephone display to indicate that characters can be entered using the dialpad.



## D

**data terminal:** A device, such as a modem, that can be used to transfer data instead of sound over a telephone network. You cannot use Norstar programming to set up such devices. See the documentation that accompanies the device.

**date:** See Show Time or Time and Date.

**defaults:** The settings for all Norstar features when the system is first installed. Settings are changed from their defaults in programming. In this manual, default settings are shown in **bold** text.

### **Delayed Ring Transfer (DRT) to prime:**

After a specified number of rings, this feature transfers an unanswered call on an external line, to the prime telephone associated with that line. This feature is activated under **Feature settings in Sys Prgrmmng**.

**destination code:** A two- to seven-digit number that the system interprets and then translates into the digits that you want dialed out. Both the code and its associated dialed digits are assigned under Routing service in Services programming.

**dialing restriction:** See Restriction filter.

**dialing modes:**

This feature allows you to set the dialing mode of your telephone. Norstar supports three dialing modes: Automatic Dial, Pre-Dial, and Standard Dial. All three modes support on-hook dialing, meaning you can dial a call without picking up the receiver. The special features of the Automatic and Pre-Dial modes are available only when you dial on-hook.

**Direct-dial:** A feature that allows you to dial a designated telephone in your Norstar system with a single digit, such as the main receptionist. As many as five direct dial sets can be established. Each telephone in the system is assigned to one direct-dial telephone. There is a single, system wide digit for calling the assigned direct-dial telephone of any telephone. Direct-dial telephones are established in System programming. Telephones are assigned to a direct-dial telephone under **Capabilities in Terminals&Sets** programming.

**Direct-dial #:** A digit used system-wide to call the Direct-dial telephone. The digit is assigned under **Access codes in Sys Prgrmmng**.

**Direct-dial number:** The digit used to call the direct-dial telephone.

### **Direct inward system access (DISA):**

The feature that allows remote users to dial directly into the Norstar system and use Norstar features. Callers will hear stuttered dial tone and will be required to enter a Class of Service password to gain access to the system. See Remote Access.

**directed pickup:** See Call Pickup Directed.

**Directory number (DN):** A unique number that is automatically assigned to each telephone or data terminal. The DN, also referred to as an internal number, is often used to identify a telephone when settings are assigned during programming.

Default DN assignments start at 221.

**DISA DN:** The received number assigned to the Norstar direct inward system access facility. If a caller dials a number that is assigned to the DISA DN, the caller hears stuttered dial tone and must enter a Class of Service

password. Once the password is accepted, the caller hears system dial tone and can use Remote Access features. See Remote Access.

**Disconnect Supervision:** A setting that enables the Norstar system to detect if an external caller hangs up. Once an external caller hangs up, the Norstar system can disconnect its line. **Disconnect Supervision** is enabled under **Trunk/Line** data in **Lines** programming.

**display:** A liquid crystal display (LCD) on the telephone that guides you through feature operation and programming.

**display button:** The Norstar M7310 telephone and M7324 telephone and the Business Series Terminal T7316 and T7316E are each equipped with three buttons located directly beneath the display. During feature operation or programming, some or all of these buttons may be used to provide further options. If an option is available, it is shown in the bottom row of the two-row display, directly above the corresponding display button. Display buttons are represented in this manual as underlined capital, such as OK.

**DN:** See Directory number.

**Do Not Disturb:**   

A feature that stops calls from ringing at your telephone. Only Priority Calls will ring at your telephone. A line button will flash when you receive a call, but the call will not ring.

**DTMF:** See Dual tone multifrequency.

**dual tone multifrequency:** Two distinct telephone signaling tones used for dialing.

---

## E

**Emergency 911 dialing:** The capability to access a public emergency response system by dialing the digits 9-1-1. State and local requirements for support of Emergency 911 Dialing service by Customer Premises Equipment vary. Consult your local telecommunications service provider regarding compliance with applicable laws and regulations.

**emergency telephone:** A single-line telephone, also referred to as a 500/2500 telephone, that becomes active when there is no power to the ICS.

**evening schedule:** See Schedules, and Services.

**event message:** Event messages are stored in the system log and displayed during a Maintenance session. They record a variety of events and activities in the Norstar system.

**exceptions:** See Overrides.

**external call:** A call to a destination outside the Norstar system.

**External Call Forward:** See Line Redirection.

**external code:** The number you dial to get an external line. By default it is 9, but this can be changed under **Access codes** in **Sys Programming**. You do not always need an external code. It is primarily to support the M7100 and T7100 telephones, and single-line telephones using an Analog Terminal Adapter.

**external line:** A line on your system telephone used for making calls to destinations outside the Norstar system.



**external music source:** See Music source.

**external paging:** A feature you can use to make voice announcements over an externally-mounted loudspeaker connected to the ICS. The external speaker is not a Norstar component and must be supplied by the customer.

## F

**feature button:** Many Norstar features are invoked by pressing the Feature () button followed by a feature code. The feature button is also used to exit a feature.

**feature code:** A number that is used to activate a particular feature.

**Feature programming:**  \*  3  
Allows you to program a feature code onto a memory button.

**Forward:** See Call Forward.

**Full Autohold (on idle line):** When this feature is on, if you select an available line and then do something that selects another line, the first line is put on hold. **Full Autohold** is enabled under **Trunk/Line** data in **Lines** programming.

**Full handsfree:** See handsfree.

## G

**Group Listening:**  8 0 2  
A feature that allows you to have others in your office hear a caller through your telephone speaker. The caller hears you only when you speak into the receiver. They cannot hear other people in the office.

You can cancel Group Listen for the current call. Group Listen is cancelled automatically when you hang up the Group Listen call.

## H

### Handsfree:

A feature you can use to make calls without using the telephone receiver. **Full Handsfree** is activated under **Capabilities in Terminals&Sets** programming. When it is activated, a handsfree/mute button is automatically assigned to the telephone.

### Handsfree (HF) Answerback:

When activated, this feature automatically turns on the microphone at a telephone receiving a Voice Call so that the person receiving the call can respond without lifting the receiver. It is activated under **Capabilities in Terminals&Sets** programming.

**Handsfree/Mute button:** See handsfree.

**Hardware:** A section in programming that shows what equipment has been installed in the ICS. This section is accessed by the installer.

**headset:** A head-mounted or ear-mounted telephone receiver that is used instead of the hand-held receiver. Headsets are not Norstar components and must be supplied by the customer.

**Held (Line) Reminder:** A system telephone rings and displays the message **On hold: LINENAM** when an external call has been placed on hold for a certain period of time. The **Held Line Reminder** feature and **Remind delay** are set under **Feature settings in Sys** programming.

**HF Answerback:** See handsfree answerback.

**Hold button:** 

This button is used to suspend calls so that the person using the telephone can perform another task without disconnecting the caller.

**Hook Switch Flash:** See Link time.

**Host system signaling:** (Also referred to as end-to-end signaling.) System telephones can access a remote system or dial a number on an alternate carrier by means of host feature activation, such as Link, Pause and Run/ Stop.

**Hospitality** The Hospitality features allow business which use hospitality telephones, or room-based telephones, to control access, alarms, and maintenance duties through the telephones.

**Hotline:** This feature automatically calls a pre-assigned number when the telephone receiver is lifted or the handsfree/mute button is pressed. A Hotline number can be an internal or external number. Hotline is assigned under **Capabilities** in **Terminals&Sets** programming.

**Hunt group:** The hunt groups feature allows a group of sets to be called by a single directory number ensuring that calls are easily routed to the appropriate group.

---

## I

**I/C:** An abbreviation of intercom.

**ICS (integrated communication system):** The central hardware component in the Norstar system. The ICS has its own processor and memory, and provides a physical point of connection for the various types of devices, telephones, and expansion modules used in Norstar.

The ICS can function on its own as a basic system (with 32 system telephones and up to 48 external lines), or with the addition of Trunk Modules (TM) that supports more external lines, or Station Modules (SM) that support more system telephones.

**Integrated Services Digital Network (ISDN):** A digital telephone service that allows for a combination voice and data connection over a single, high-speed connection. ISDN service can operate over the same copper twisted-pair telephone line as analog telephone service.

**intercom button:** A button that provides access to internal lines used for calls within a Norstar system and access to external lines through a line pool or external code. A telephone may be assigned zero to eight Intercom buttons. This is done under **Line access** in **Terminals&Sets** programming.

**intercom keys:** See Intercom button.

**internal line:** A line on your telephone dedicated to making calls to destinations inside your Norstar system. An internal line may still connect you with an external caller if you use it to access a line pool or to pick up a call using Norstar call handling features such as Call Park or Call Pickup Directed.

**internal number:** A number, also referred to as a Directory Number or DN, that identifies a Norstar telephone or device.

**internal user:** Someone using a system telephone within a Norstar system.

**ISDN:** See integrated services digital network.

**ISDN DN:** A directory number (DN) used by ISDN terminal equipment connected to the ICS. The system uses a maximum of thirty ISDN DNs.

## K

**key indicator module (KIM):**

This module is configured similarly to the CAP module except that, as an eKIM, it can support multiple target lines and Hunt Group DNs. You can

attach one or more module to a T7316E telephone.

## L

### **Last Number Redial:** [6] [5]

A feature that allows you to redial the last external number you dialed.

### **Fixed line:**

A telecommunications line between two service points leased from a communications carrier for private use, usually incurring a monthly service rate. Fixed lines setting is used solely by data modules.

**Least cost routing:** See Routing service.

**line:** The complete path of a voice or data connection between one telephone (or other device) and another.

**Lines:** A programming section that allows you to assign settings to each trunk and external line. Lines programming can be done by an Installer or a System Coordinator Plus. A System Coordinator can program the name of a line.

**Line number:** A number that identifies an external line. The total number of lines depends on how many Trunk Modules are installed.

### **Line Pool:** [6] [6] [4]

A group of lines used for making external calls. Line pools provide an efficient way of giving a telephone access to external lines without taking up many line buttons. A line is assigned to be part of a line pool under **Trunk** Line data in **Lines** programming.

### **Line Redirection:** [6] [8] [4]

A feature that allows you to redirect all calls on an incoming line to a destination outside the Norstar system. Once a line is redirected it cannot be answered within the Norstar system.

The system may be set up to give a brief ring when a call comes in on a redirected line, under **Capabilities** in **Terminals&Sets** programming.

This feature differs from Call Forward in two ways: It redirects only external calls, not internal calls, and it redirects calls to destinations outside the system. Call forward redirects calls only to destinations inside the Norstar system. See Call Forward.

### **Link:** [6] [7] [1]

If your Norstar system is connected to a Private Branch Exchange (PBX), you can use a Link signal to access special features. The Link signal can also be included as part of a longer stored sequence on an External Autodial button or in a Speed Dial code. The Link symbol (LS) uses two of the 24 spaces in a dialing sequence.

### **Long Tones:** [6] [8] [0] [8]

A feature that allows you to control the length of a tone so that you can signal devices such as fax or answering machines which require tones longer than the standard 120 milliseconds.

**Lunch schedule:** See Schedules, and Services.

## M





**M7000 telephone** This telephone has a no display. It does have four memory buttons. (Note this telephone is only supported on systems running Profile 2, 3, or 4).

**M7100 telephone:** A telephone with a single line display and one programmable memory button without an indicator.

**M7208 telephone:** A telephone with a single-line display and eight programmable memory buttons with indicators.

**M7310 telephone:** A telephone that has a two-line display, three display buttons, 10 programmable memory buttons with indicators, and 12 dual memory programmable buttons without indicators. An M7310 can be equipped with a Busy Lamp Field.

**M7324 telephone:** A telephone with a two-line display, three display buttons, and 24 programmable memory buttons with indicators. An M7324 telephone can be equipped with a CAP module.





**Malicious Caller ID (MCID)** This feature is a European ETSI-based network feature that allows a user to use     record the caller information at the service provider.

**memory buttons:** Buttons that can be programmed to dial frequently used features or numbers automatically. See M7100/T7100, M7208/T7208, M7310, T7316/T7316E, and M7324 telephone entries for their exact memory button configurations.

**message:** A feature that allows you to send a message to another Norstar user. The Message feature also allows you to know if you have any messages waiting and maintains a Message Waiting List to keep a record of your internal messages and your (external) voice mail messages.

**Message Waiting Indicator:** PRI lines can provide the signal that cause the set to display a message-waiting message, or light a lamp on the set to indicate a voice message.

**Monitoring** See Silent Monitoring.

**Move Line buttons:**      
A feature that allows you to move assigned lines to different buttons (with indicators) on your telephone.

**Music source:** A radio or other source of music can be connected to the Integrated Communication System to provide music for the Music on Hold and Background Music features. A music source is not part of the Norstar system and must be supplied by the customer.

---

## N

**Names:** Names can be assigned to System Speed Dial numbers, external lines, telephones, and service schedules. This is done in programming. You can use up to 16 characters to name a System Speed Dial number, and seven characters to name a telephone, line, or schedule. If a Name has not been assigned, the line number or DN will appear on the display instead of a name.

**Network DN:** A number supplied by the ISDN network service provider for ISDN terminal equipment.

**Night schedule:** See Schedules, and Services.

---

## O

**On hold:** A setting, programmed under **Feature settings** in **System Programming**, that controls whether external callers hear music, periodic tones, or silence when they are placed on hold.

**overlay:** See Programming overlay.

**overflow:** A setting in **Routing Service** that allows users to decide what path an outgoing call will take if all the lines used in a particular route are in use when the call is made.

**Overrides:** One component of a restriction filter. Overrides are numbers you can dial even if they are forbidden by a more general restriction. See Restrictions.

## P

### Page: ☎ 6 0

A feature you can use to make announcements over the Norstar system. You can make page announcements over the telephone speakers and/or external speakers.

**Page Time out:** A setting that controls how long a Page Announcement can last. It can be assigned under **Feature settings** in **Sys Prgrmmng**.

**Page zone:** An area in the office that receives internal page announcements independently of the rest of the office.

Each page zone is identified by a number. Telephones are assigned to page zones under **Capabilities** in **Terminals&Sets** programming.

**Park prefix:** See Call park prefix.

**Park timeout:** The time before an unanswered parked call is routed back to the telephone that parked it. **Park timeout** is configured under **Feature settings** in **Sys Prgrmmng**.

**Password:** A password is a specific sequence of digits that you enter to gain access to Norstar programming, to override dialing restrictions, or to use remote access with DISA.

**Passwords:** A programming section that allows you to assign or change COS passwords, Call log passwords, or any of the programming passwords. Under **Passwords** programming, you can only modify the passwords for your level of programming.

### Pause: ☎ 7 8

A feature that enters a 1.5-second delay in a dialing sequence on an external line. This is often required for signaling remote devices, such as answering machines, or when reaching through to PBX features or host systems. The

Pause symbol (☎) uses one of the 24 spaces in a dialing sequence. For pulse dialing, [\*] inserts a 1.5 second pause into the dialing sequence.

**PBX:** private branch exchange.

### Pickup Group: ☎ 7 5

A telephone can be placed into one of nine call pickup groups. A call ringing at a telephone within a pickup group can be picked up at any other telephone within the same pickup group. A telephone is assigned to a pickup group under **Capabilities** in **Terminals&Sets** programming.

**Pool:** See Line pool.

**portable telephone:** See Companion portable telephone

**Pre-dial:** A feature that allows you to enter a number and check it on your telephone display before it is actually dialed. If the number is incorrect, you can edit it. The number is dialed only when you pick up the receiver or select a line.

**Primary Rate Interface (PRI):** An ISDN interface which uses 23 B channels and a D channel (23B+D) for profiles 1, 3 and 4, and D channel (30B+D) for Profile2.

**Prime line:** The line on your telephone that is automatically selected when you lift the receiver, press the handsfree/mute button or use an external dialing feature.

A **Prime Line** is assigned to a telephone under **Line** access in **Terminals&Sets** programming.

**Prime Set (prime telephone):** A telephone that provides backup answering for incoming calls on external lines. The prime telephone for a line will ring for any unanswered calls on that line. A prime telephone is assigned to a line under **Trunk/Line** data in **Lines** programming.

**Priority Call:** ☎ 6 9

If you get a busy signal when you call someone in your office, you can interrupt them for an urgent call. This feature is enabled for a telephone under **Capabilities in Terminals&Sets** programming.

**Privacy:** This feature determines whether a Norstar user may select a line in use at another telephone and join an established call. **Privacy** is enabled under **Trunk/Line** data in **Lines** programming, but can be turned on and off by users during individual calls.

**Private line:** See Private to.

**Private Monitoring** This feature allows a user with a two-line display telephone that has been designated as a supervisor telephone, to monitor Hunt group calls from external sources using ☎ \* 5 5 0.

**Private network:** A telephone network consisting of owned or leased telephone lines used to connect different offices of an organization independently of the public network.

**Private Network Identifier (PNI)** this is an identifying digit or set of digits assigned to each system in a private network with a Meridian system. These codes are provided by the Meridian system administrator when the node is brought on to the network.

**Private to:** Allows you to select the telephone that will use the line exclusively. The line cannot appear on any other telephone, except the prime telephone for that line. Private lines cannot be placed into line pools.

**Private lines** are assigned under **Trunk/Line** data in **Lines** programming.

**Programmed release:**

☎ \* 8 9 A feature that performs the function of the ☎ button in a programmed dialing sequence.

**programming:** Setting the way the Norstar system will work. Programming includes system-wide settings and individual telephone and line settings.

**programming overlay:** A paper template that is placed over the four memory buttons with indicators on the M7310, T7316, T7316E or M7324 telephone during programming. The overlay labels indicate the special function that each of the four buttons takes on in programming.

**public line:** An external line that can be assigned to any telephone and to many telephones. A line is assigned as Public under **Trunk/Line** data in **Lines** programming.

**public network:** The regular telephone network that connects most homes and businesses.

**Public Safety Answering Point (PSAP):** This is the first point of contact a caller reaches after dialing 911.

**pulse/tone dialing:** An external line setting for pulse or tone dialing. Pulse is the traditional method of dialing used by rotary-dial or push-button single-line telephones. Tone dialing allows telephones to communicate with other devices such as answering machines. Tone dialing is required to access the features that PBX systems may offer or to use another Norstar system remotely.

## R

**recall:** See Link time.

**receiver:** The handset of a telephone.

**receiver card:** An abbreviated list of system feature codes that is stored under the telephone receiver. The card is found on a perforated sheet that comes with a system telephone.



**Remind delay:** A feature that causes a telephone to beep and display the message **On hold: LINESAM** when a call has been on hold for a programmable period of time. This period is the Remind delay.

**Remote access:** The ability to dial into a Norstar system from outside the system and make use of selected Norstar features. The lines, features, and dialing capabilities available to a remote user are determined by the Class of Service. If the remote access line is answered with DISA, the user must enter a Class of Service password to gain access to the Norstar system features.

**remote access dial restriction:**  
See Remote restriction.

**Remote capability:** A subset of Norstar features that are available to users connected through remote access.

**Remote monitoring:** A feature that allows an off-site technician with a PC call in and troubleshoot your system through the built-in modem.

**Remote paging:** This feature allows remote users to use the Norstar paging feature. Access to this feature is governed by the Class of Service for the call. See Remote Access and Class of Service.

**Remote restriction:** A restriction filter applied to a line in order to control which digits can be dialed during an incoming remote access call. It is the equivalent of a set filter for a remote user.

**remote user:** Someone who calls into a Norstar system from a telephone outside that system and uses Norstar features or lines. See Remote Access.

**Restriction filter:** Through a combination of restrictions and overrides, restriction filters prevent certain telephone numbers or feature

codes from being dialed. Restriction filters can be applied to lines, sets, specific lines on a set, and to Class of Service passwords. The Norstar system can handle up to 100 restriction filters.



**Restriction service:** A Services section that allows you to assign alternate dialing filters to lines, telephones, lines on a particular telephone, and alternate remote filters to lines at specified times of the day and on specified days.

**restrictions:** One component of a Dialing filter. Restrictions are numbers you cannot dial when that dialing filter is in effect. See Exceptions.

**Ring Again:**  

A feature that can be used when you can't get through to someone on your Norstar system because their telephone is busy or there is no answer. Ring Again instructs the Norstar system to inform you when they hang up or next use their telephone.

**ring group:** A setting under Services that allows you to assign a number of different telephones to ring during one of the schedules. Up to 20 ring groups can be programmed by an installer or a system coordinator plus.

**ring type:**  \* 

A feature that allows you to select one of four distinctive rings for your telephone.

**ring volume:**  \*  

A feature that allows you to set the volume at which your telephone rings.

**ringing service:** A Services section that allows you to make additional telephones ring at specified times of the day and on specified days.

**Release button:** Ends a call in the same way that hanging up the receiver does. The Release button may also be used to end programming, Maintenance sessions, and feature operations.

**Routing:** See Routing service.

**Routing service:** A programming section that allows outgoing calls to be directed automatically based on the numbers a caller dials. For Norstar systems linked in a network, routing can create a transparent or coordinated dialing plan. It can also be used to direct calls to the least expensive lines according to a Services schedule (sometimes called least cost routing).

**Run/Stop:**  \* 

A feature that creates a break point in a programmed external dialing sequence. When you press a programmed key, the system dials the number up to the run/stop. When you press it again, the system dials the digits following the run/stop.

## S

**Saved Number Redial:**   

A feature that allows you to save the number of the external call you are on (providing you dialed the call) so that you can call it again later.

**Schedules:** Any of six different sets of services that can be applied to your Norstar system. A schedule can be activated manually from a control telephone or activated automatically at specified times. See also Services.

**Selective line redirection:** See Line Redirection.

**Service modes** See Services.

**Service Profile Identifier:** See SPID.

**Services:** A programming section that allows you to assign which telephones ring, which restrictions apply, and which call routing is used during any of six different schedules.

There are three services: Ringing service, Restriction service and Routing service, all found in Services programming.

**set:** A telephone.

**Set Copy:** A programming section that allows you to copy programmable settings from one telephone to another of the same type. Set Copy provides two options: duplicating System Data and User Data, or duplicating System Data only. Set Copy does not provide the same copy capability as **COPY**, which is more selective of the settings that can be duplicated.





**Set filter:** See Restriction filter.





**Set lock (telephone lock):** This feature allows you to limit the number of features that may be used or programmed at a telephone. Full set lock allows very few changes or features, Partial set lock allows some changes and features, and No set lock allows any change to be made and any feature to be used. Set lock is assigned under Capabilities in Terminals and Sets programming.

**Set relocation:** See Automatic Telephone Relocation.

**shift button:** A small triangular button beside the dual memory buttons on the upper half of the M7310 telephone. You press the shift button to store or access features on the top half of the dual memory buttons.

## Silent Monitoring

This feature allows a user with a two-line display telephone that has been designated as a supervisor telephone, to monitor Hunt group calls from external sources using  \*   .

**Show Time:**    

While on a call, accessing this feature allows you to see the current date and time on the Norstar telephone display.

**Startup programming:** When a Norstar system is first installed and powered up, Startup programming must be performed before any programming can be done. Startup initializes the system programming to defaults.

**Station:** An individual telephone or other Norstar device.

**System coordinator:** The person responsible for customizing the Norstar system through programming and for helping co-workers use the Norstar system.

**System coordinator password:** A one- to six-digit password that prevents unauthorized access to programming. The System coordinator password can be assigned and changed in Passwords programming.

**System coordinator plus:** A system coordinator who also performs technical and maintenance functions for the Norstar system.

**System coordinator plus password:** A one- to six-digit password that prevents unauthorized access to programming. The System coordinator plus password can be assigned and changed in Passwords programming.

**System coordinator programming:** The programming settings that are most commonly changed once the Norstar system is installed. Press **[☎] [\*] [\*] [C] [O] [N] [F] [I] [G]**, then **[A] [D] [M] [I] [N]** to access System coordinator programming.

**system data:** An option in the Set Copy function. System Data refers to the programmable system settings that apply to all telephones and lines.

**System programming:** A programming section that allows you to assign and maintain certain settings on the Norstar system. System programming is performed by an installer or system coordinator plus.

**System speed dial code:** A three-digit code (001 to 255) that can be programmed to dial a telephone number up to 24 digits long. System speed dial codes are programmed for the entire Norstar system under the System Speed programming heading.

**System ID:** The System ID (or System Security number) can be accessed on any programming telephone display by pressing **[☎] [\*] [\*] [S] [Y] [S] [I] [D]**, or **[☎] [\*] [\*] [7] [9] [7] [4] [3]**.

**System-wide Call Appearance (SWCA) keys** **[☎] [\*] [5] [2] [0]** to **[☎] [\*] [5] [3] [5]**. These 16 feature codes can be assigned to buttons with indicators on a group of telephones to provide call appearance for incoming calls that can be answered by any telephone in the group. At the same time, the indicator displays the current status of the call.

## T

**T7000 telephone** This telephone has a no display. It does have four memory buttons. This telephone functions in the same way as the M7000 telephone. (Note this telephone is only supported on systems running Profile 2, 3, or 4).

**T7100 Business Series Terminal:** A telephone with a single line display and one programmable memory button without an indicator.

**T7208 Business Series Terminal:** A telephone with a single-line display and eight programmable memory buttons with indicators.

**T7316 Business Series Terminal:**

A telephone that has a two-line display, three display buttons, 16 programmable memory buttons with indicators, and 12 memory programmable buttons without indicators.

**T7316E Business Series**

**Terminal:** This telephone has the same functionality as the T7316, with some additional features, such as a separate handsfree key, special display icons (when running on a MICS 6.1 or newer system), and CAP capability by adding KIMs.

**T7406 telephone:** This portable handset functions very similarly to the T7310 telephone. Functions and installation are all described in separate documentation specific to the telephone.

**Target lines:** Lines used to answer incoming calls only. A target line routes a call according to digits it receives from an incoming trunk. They are referred to by line numbers in the same way as physical lines.

**Telco features:** A programming section that allows you to specify the external telephone numbers that are dialed by the Message feature to retrieve voice messages, or to set up CLASS (CMS) services for lines and sets. Telco features are accessed by an installer or a system coordinator plus.

**Terminal equipment (TE):** A generic term for devices that connect to an ISDN network. Examples of ISDN TE are ISDN telephones, computers equipped with ISDN cards and video terminals.

**Terminals and Sets:** A programming section that allows you to assign and change settings that apply to the telephones and other devices

connected to the Norstar system. Terminals and Sets programming is performed by an installer or a system coordinator.

**Time and date:** A programming section that allows you to manually change time or date. The time and date can also be changed by pressing       and entering the Basic password or one of the programming passwords.

**Transfer:**

A feature that allows you to redirect a call to another telephone in your Norstar system, over a network or outside your Norstar system.

**Transfer Callback:** If a transferred call is not answered after a specific number of rings, the call will return to the telephone that made the transfer. The number of rings is assigned under Feature settings in System programming. Transfer Callback does not apply to calls transferred externally.

**Trunk:** The physical connection between the Norstar system and the outside world using either the public telephone system or a private network.

**Trunk Answer:**

A feature you can use to answer a call on any line that has an active Ringing service Service Mode, even if that line does not appear on your telephone. Trunk Answer is enabled in Services programming.

**U**

**Uniform Dialing Plan:** (UDP) This type of dialing plan uses a location code to identify each node on a private network. Dialing sequence: (destination code)+(location code)+DN.

**User Data:** User Data is an option in the Set Copy feature. User Data refers to the personal settings that are unique to an individual telephone, and are not programmed for the system. User Data is programmed at each telephone.

These settings, for example, include user Speed Dial and the assignment of programmable memory buttons.

**User Filter:** See Restriction filter.

**User Preferences:** a programming section that allows you to assign autodialers, user speed dial codes, display contrast, and other settings to a specific telephone or person. You do not have to program these settings at the person's telephone. User preferences are assigned in Terminals and Sets programming.

**User Speed Dial:**

Three-digit codes (256-279) can be programmed to dial external telephone numbers. User Speed Dial numbers are programmed for each telephone, and can be used only at the telephone on which they are programmed.

## V

**Voice Call:**

A feature you can use to make an announcement or begin a conversation through the speaker of another telephone in the Norstar system. The telephone you call will not ring. Instead, the person you call will hear a beep and then your voice. Their telephone will beep periodically to remind them that their microphone is open.

**Voice Call deny:**

A feature that prevents your telephone from receiving Voice Calls.

**Voice message center:** If you have subscribed to Call Display services you can receive visual Voice Message Waiting Indication, providing your

telephone has a display. If you have Voice Message Waiting Indication, you can program the telephone numbers required to access up to five different Voice Message Centers. You can also program which of the five Centers is to be accessed by each specific line.

## W

**Wait for dial tone:**

A feature that causes of sequence of numbers to pause until dial tone is present on the line before continuing to dial. The Wait for dial tone symbol (   ) uses two of the 24 spaces in a dialing sequence. This feature requires a Services or Combo Cartridge.

**wireless:** See Companion.



# Index

## Symbols

---

§ Long Distance symbol 257



Autobumping

canceling (#815) 139

enable (815) 139

autodial button

external (\*1) 87

internal (\*2) 87

autodial button, external (\*0) 90

Background Music

canceling (#86) 201

turning on (86) 201

Button Inquiry (\*0) 94, 247, 254

Call Forward

canceling (#4) 113

using (4) 113, 114

Call Information (811) 55

Call Log

entering (812) 141

options (\*84) 138

password (\*85) 141, 142

viewing (812) 139

Call Park (74) 106

Call Pickup (75) 60

Call Queuing (801) 99

Call Transfer

canceling (#70) 103

using (70) 66, 101

Camp-on (82) 104

Class of Service (68) 243

Conference Call

7100 sets (#3) 65

on Hold, 7100 sets (#3) 66

using (3) 64

Contrast Adjustment (\*7) 146

Dialing Modes (\*82) 82

Directed Pickup (76) 59

Do Not Disturb

canceling (#85) 200

turning on (85) 83, 200

Exclusive Hold (79) 98

Feature Button, programming (\*3)

147

Group Listening

canceling (#802) 68

using (802) 68

Hide message display (806) 162

Host System Dialing Signals

Link (71) 234

Long Tones (808) 236

Pause (78) 236

Programmed Release (\*89) 237

Run/Stop (\*9) 237

Wait for Dial Tone (804) 238

Last Number Redial (5) 90

Line Pool Access (64) 81

Line Redirection

canceling (#84) 120

using (84) 118

Message

canceling (#1) 130

sending (1) 129

viewing (65) 130

Page

combined zone (63) 125

external zone (62) 125

internal zone (61) 125

using (60) 106

Password

Basic 23, 224

Call Log (\*85) 141, 142

System Coordinator 29, 37, 39

System Coordinator (ADMIN)

27, 224

Priority Call (69) 84

Privacy (83) 75

Restriction Service

turning off (#872) 220

turning on (872) 220

Ring Again

canceling (#2) 86

using (2) 86

Ring Type (\*6) 162

Ring Volume (\*80) 162

Ringing Service

turning off (#871) 220

turning on (871) 220





Routing Service

turning off (#873) 220

- turning on (873) 220
- Services, viewing (870) 222
- Speed Dial
  - adding user (\*4) 92
  - making calls (0) 92
- Static Time and Date (806) 133
- Testing
  - display (805) 254
  - power supply (805) 256
  - telephone buttons (805) 255
  - telephone handset (805) 255
  - telephone headset (805) 255
  - telephone speaker (805) 256
- Time (803) 76
- Time and Date (\*\*TIME) 29, 225
- Trunk Answer (800) 62
- User Preferences (\*\*USER) 163, 225
- Voice Call (66) 134
- Voice Call Deny
  - canceling (#88) 135
  - using (88) 135

ø

- Page
  - using (60) 125

-  Link symbol 234
-  Pause symbol 236
-  Programmed Release symbol 237
-  Run/Stop symbol 238
-  Wait for Dial Tone symbol 238
- 2-way DID
  - PRI 205
- 7100 set
  - Call Park 106
- 7100 sets
  - CallBack 105
  - camping a call 105
  - Line Redirection 118
  - Ring Again 258
  - transferring a call 103
- 911
  - description 13
- 911 service 199
  - compliance 205
  - maintaining records 205

**A**

---

access

- change COS password 243
- dialtone for remote calls 242
- external lines 249
- fast busy tone for remote calls 242
- from outside the system 239
- remote access tones 242
- stuttered dial tone for remote
  - access 242
  - using a COS 240
  - using a DISA 240
- Access denied 257
- accidental release 76
- active services, display indicator 223
- ADD 251
  - adjusting the display 146
- administration password (see System Coordinator password)
- administration programming 14
- administration set
  - controlling alarms 192
  - hospitality 185
  - using 190
- alarm
  - cancel 194
  - Hospitality 191
  - turn off 194
  - using 193
- Alarm 61-4-2 253
- alarm number, recording 253
- alarm telephone, description 253
- alarms
  - controlling with admin set 192
  - query on admin set 192
  - reporting and recording codes 253
- all lines, redirection 119
- Allow calls 200
- allow redirect
  - programming 120
- Already joined 61, 78
- Already Parked 107
- alternate services 217
- analog telephone
  - answering a message 129
  - delaying snooze alarm 194
  - removing a message 132
  - replying to a message 131
  - sending messages 128
  - setting room, Hospitality 190
  - turn off alarm 194



- using wake-up alarms 193
- analog terminal adapter (see ATA)
- announcement
  - paging 125
  - Voice Call 134
- answer
  - programming Handsfree
    - answerback 73
  - Trunk answer 62
- answer button
  - assigning to sets 160
  - attendant 63
  - type 63
- answer DNs
  - answer key 63
- answering calls
  - Answer DNs 63
  - Call Display services 55
  - Call Duration Timer 75
  - Call Pickup 59
  - CAP 48
  - Conference Calls 64
  - directed pickup 59
  - distinctive ring patterns 46
  - ending a call 55
  - Group Listening 68
  - group pickup 60
  - Handsfree 69
  - hearing aid compatibility 55
  - line indicators 44
  - prime telephone 47
  - Privacy 74
  - several Hold calls 97
  - TAP 50
  - Trunk Answer 62
  - using line buttons 44
  - using SWCA keys 108
  - Voice Call 135
- answering incoming calls
  - hunt groups 43
- apply button labels 149
- assign an alarm time 192
- assign lines
  - Hunt Groups 173
  - sets 247
- ATA
  - dialing signals 236
  - using dialing modes 83
- attendant answer button 63

- Auto Call information (see Caller ID set)
- auto-answer, using COS password 242
- autobumping, enable/disable 139
- autodial
  - button inquiry 145
  - choosing a line 88
  - for M7100 and T7100 88
  - line pool access code 88
  - line selection 88
  - programming 87
  - set lock 232
  - storing number on a memory button 87
  - using intercom line for 88
  - using Last Number Redial 91
- Autodial full 88
- automatic
  - Call information 58
  - Call Log 137
  - dial 82
  - Handsfree 73
  - Hold 97
  - logging calls 142
  - release of a line, see Disconnect Supervision
  - restriction service 218
- automatic call back, ISDN terminal feature 211
- Automatic Call Forward, changing settings 115
- automatic recall, ISDN terminal feature 211
- automatic telephone relocation 199
- auxiliary ringer
  - Hunt Groups 179
- auxiliary ringer, programming 233

## B

---

- background music
  - licensing 201
  - set lock 232
  - turning off 201
  - using 201
- Basic
  - password 14, 163
  - password, changing 224
  - Restriction and Routing service 221
- basic

- answer button 63
  - BKSP 251
  - blocking
    - calls, see Do Not Disturb and DND
    - name and number 205
  - break point, host system dialing, Run/Stop 237
  - BRI
    - ISDN description 203
    - ISDN services 208
    - Name and Number Blocking 210
    - network features 209
    - Network Name Display 209
  - broadcast, Hunt Groups, programming 174
  - business name
    - features 209
    - name display, outgoing 204
  - Business Series Terminal
    - programming overlay 21
  - Business Series Terminals
    - Handsfree 69
    - installing 195
    - viewing line profile 245
    - viewing set profile 245
    - wall mounting sets 196
  - busy
    - call forward on busy 116
    - CLID display for incoming call 56
    - DND on busy 116
    - Do Not Disturb 40
    - Hunt Group line setting 176
    - Hunt Group routing 176
    - priority call 83
    - programming call forward 39
    - tone, remote access 242
  - busy 77, 85
  - busy tone
    - Hunt Group routing 176
  - button caps
    - clear 150
    - pre-printed, colored 150
  - button defaults
    - M7100/T7100 159
    - M7208 and T7208 158
    - M7310 155
    - M7310 dual memory buttons 156
    - M7310 lower buttons 155
    - M7324 telephone 157
    - T7316 Business Series Terminal 151, 153
  - Button erased 89
  - Button Inquiry 145
  - buttons
    - Answer DNS/answer key 63
    - assign handsfree and mute 73
    - Button Inquiry 145
    - CAP 48
    - changing programming 164
    - changing user speed dials 165
    - default assignment 150
    - dialpad 17
    - display 17, 19
    - eKIM 53
    - erasing programmed features 147
    - Feature 17, 18
    - handsfree 18
    - Hold 17, 18
    - labels, applying 149
    - Last Number Redial 90
    - line button assignment 247
    - line button indicators 248
    - line pool feature code 249
    - memory 17, 87, 250
    - moving line 161
    - mute 18
    - numbering on all telephone types 164
    - programming features on 147
    - Release 17, 18, 55
    - Saved Number Redial 94
    - TAP 53
    - testing 254, 255
    - using a line button 79
    - using buttons 16
    - volume control 18
  - bypassing a Hotline telephone 230
- ## C
- 
- call
    - disconnecting, conference call 65
    - ending a call 55
    - independent hold, on conference 65
    - overflow 249
    - redial last number 90
  - Call 221? 258

- Call blocked 85
- call blocking, turning privacy on 75
- Call by Call
  - FX calls 206
  - Inwats calls 207
  - Outwats calls 206
  - PRI 206
  - Private calls, DID and DOD 206
  - Public calls, DID and DOD 206
  - see also CbC 206
  - Tie calls 206
- call display, answering calls 55
- Call Duration Timer 75
- Call Forward
  - All Calls, set lock 232
  - All Calls, ISDN terminals 208
  - automatic, changing settings 115
  - Call Forward No Answer 37
  - Call Forward on Busy 39, 116
  - calling the number 211
  - cancel 211
  - canceled 113
  - change delay 115
  - Forward no answer 115
  - line redirection differences 122
  - No Answer, line redirection 115
  - overriding 114
  - programming 37, 115, 116
  - programming, no answer 37
  - service provider 210
  - to voice mail 117
  - using 114
- call indicators 43
- call information
  - changing what is shown first 58
  - displaying 57
  - displaying information 55
  - for specific call 56
  - getting information for a call on hold 57
  - service provider 137
- Call Log
  - autobumping, enable/disable 139
  - automatic 137
  - automatic logging 142
  - calling from within 140
  - clearing password 226
  - erasing items 140
  - logging a call manually 138
  - options 138
  - options, changing 166
  - password 141—142
    - canceled 142
    - changing 141
  - set 137
  - using 137
  - viewing 139
- Call Park
  - description 106
  - picking up calls 247
  - retrieval codes 106
- Call Pickup
  - Directed Pickup 59
  - message forwarded 129
  - picking up calls 247
- Call Queuing
  - 7100 series sets 258
  - using 99
- call restrictions, Hospitality, rooms 188
- Call traced 212
- Call Transfer 101—104
- call transfer
  - canceled 103
  - external calls 102
  - using 101
- Call(s) bumped 143
- Callback, using 112
- Caller ID set, automatic call information 58
- Calling 85
- calling party name 204
- calls
  - accidental release 76
  - allow line redirection programming 120
  - answering calls on CAP 48
  - answering calls on TAP 50
  - answering prime telephone 47
  - answering with direct pickup 59
  - answering with group pickup 60
  - answering with Handsfree 69
  - automatic dial 82
  - automatic display 58
  - automatic Hold 97
  - blocking the Link feature 235
  - call queuing 99
  - canceled call forward 113
  - canceled DND 200

- changing Call forward no answer
    - 115
  - changing how you dial 82
  - changing to Handsfree 70
  - checking duration 75
  - display call information 57
  - display call information for hold call
    - 57
  - external call transfer 102
  - forwarding to internal set 113
  - forwarding to voice mail 117
  - from within Call Log 140
  - holding several calls 97
  - listening while on Hold 98
  - making a private call 75
  - making from ISDN terminal 82
  - monitoring with CAP 50, 54
  - muting Handsfree 70
  - overriding call forward 114
  - programming 2-way DID 205
  - programming paging 126
  - putting on Exclusive hold 84
  - refusing second call 200
  - restriction services 217
  - retrieving a parked call 106
  - retrieving held call 97
  - routing outgoing calls 218
  - saved number redial 94
  - security on remote access 240
  - specific call information 56
  - standard dial 82
  - tracking incoming calls 137
  - using answer key 63
  - using DND 200
  - using Do Not Disturb 200
  - using line button 44
  - using Link for external calls 234
  - using Pause for external calls 236
  - using pre-dial 83
  - using ring again 85
  - using speed dial 92
  - ways to make a 77
- CAMP denied 105
- CAMP max 105
- CAMP to 105
- CAMPed 105, 258
- camping calls (see Camp-on)
- camp-on
  - tones 104
  - using 104
- Can't ring again 78, 86
- CANCEL 251
- cancel
  - a transfer 103
  - Call Forward 113
  - call log password 142
  - Do Not Disturb 200
  - group listening 68
  - Hospitality alarm 194
  - Line Redirection 119
  - pending alarm 192
  - sent message 130
  - voice call 135
- Cancel denied 133
- CANCL 165
- CAP
  - answering calls 48
  - customizing 49
  - DID 48
  - monitoring calls 50, 54
  - moving buttons 161
  - prime telephone 48
  - sending messages 129
  - telephone 48
  - telephone, direct dial 228
  - using 48
- central answering position (see CAP)
- centrex template
  - M7208 158
  - M7310 lower buttons 155
  - M7324 buttons 158
  - T7208 158
  - T7316 buttons 151, 152, 154
- CHANGE 165
- change
  - alarm time 192
  - automatic Call Forward 115
  - call log options 166
  - call log password 141
  - COS password 243
  - day 31
  - dial method 82
  - display contrast 167
  - hour 30
  - how calls are dialed 166
  - Hunt Group auxiliary ringer 179
  - Hunt Group Name 178
  - language on display 167

- line name 35
- minutes 30
- month 30
- ring type 162, 167
- user speed dial 165
- year 30
- choosing a line 79
- Class of Service
  - changing 243
  - managing passwords 243
  - using a password 242
- clear button caps 150
- Cleared>LINENAM 133
- CLID
  - display on busy 56
- clock, set 31
- CLR 165
- code, system speed dial 32
- colored button caps 150
- common set, Hospitality 185
- communicating in the office
  - paging 125–128
  - sending messages using display 128
- Companion, Registration password 225
- cond pswd, Hospitality 186
- cond pswd, programming 227
- condition, setting room condition 189
- Conf. on hold 67
- Conference busy 67
- conference call
  - by releasing privacy 75
  - cancel group listening 68
  - conference on Hold 66
  - disconnecting from 66
  - disconnecting one call 65
  - group listening 68
  - independent Hold 65
  - making 64
  - no privacy button 74
  - releasing privacy 64
  - removing yourself from 66
  - splitting 66
  - using the Conference feature 64
- connecting to ISDN network 213
- contrast adjustment 146
- control
  - calls, using alternate or scheduled services 217

- system security on remote calls 240
  - using DISA 240
- control telephone
  - enter Service feature code 221
  - setting service schedules 231
  - turn service off 221
  - turning services off/on 217
  - viewing active services 221
- custom programming, moving sets 199
- customizing CAP 49
- customizing KIM 53
- customizing your telephone
  - adjusting ring volume 162
  - Button Inquiry 145
  - changing ring type 162
  - contrast adjustment 146
  - User Preferences 163

## D

---

- data transfer, PRI 203
- date and time
  - changing 29
  - displayed instead of messages 162
  - displaying 76
  - length of a call 75
- date, change 225
- day, set 31
- default buttons
  - assignment 150
- defaults
  - button assignments 150
  - buttons, T7316 Business Series Terminal 151, 153
  - M7310 buttons 155
  - M7310 dual memory buttons 156
  - M7310 lower memory buttons 155
- delay
  - call forward no answer 115
  - hunt 175
- Delayed Ring Transfer 200
- delete
  - Call Log items 139
  - call log password 142
  - messages from list 132
  - programmed features 147
- Denied in admin 257
- deny voice call 135
- desk information, Hospitality 187

- desk pswd 227
- Desk pswd, programming 186
- desktop conferencing, ISDN applications 214
- destination code
  - line for external calls 231
- dial tone, stuttered 242
- Dial voice call 135
- dialing
  - 911 compliance 205
  - automatic dial 82
  - host system signals 234
  - modes 82
  - options 166
  - pre-dial 83
  - saved number 94
  - signal, Long Tones 236
  - signal, Pause 236
  - signal, Programmed Release 237
  - signal, run/stop 237
  - signal, switching from pulse to tone 238
  - signal, Wait for Dial Tone 238
  - standard dial 82
  - switching between pulse and tone 246
  - switching from pulse to tone 238
  - using Pause 236
- dialing filters, Hospitality room states 189
- dialing mode, set lock 232
- dialing plan
  - enblock dialing 207
  - PRI 207
- dialpad
  - change name 34
  - entering letters and numbers 29
  - entering numbers and letters 33
  - programming buttons 17
- DID
  - 2-way DID, PRI 205
  - calls, extra-dial telephone
    - ringing service 223
  - CAP lines 48
  - CbC private calls 206
  - CbC public calls 206
  - PRI description 203
- DID template
  - M7208 158
  - M7310 lower buttons 155
  - M7324 buttons 158
  - T7208 158
  - T7316 buttons 152, 155
- digital connections, to ISDN networks and devices 213
- direct dial, forward, external 228
- direct inward system access (DISA), see also DISA 240
- direct-dial telephone
  - programming 229
  - using 228
- DISA, COS password 240
- disable autobumping 139
- disconnect
  - from conference 66
  - releasing a call, accidentally 76
- disconnect supervision, assigning 246
- display
  - 2-line 17
  - automatic caller ID display 58
  - button equivalents for one-line display 251
  - buttons 17, 19
  - Call information 57
  - call information 56
  - changing contrast 146
  - changing first display 58
  - changing the language 167
  - contrast 167
  - Display digits 27
  - End of Session 27
  - name instead of number 199
  - network name, BRI 209
  - one-line 251
  - PRI Network Name Display 204
  - restoring message indication 162
  - system speed dial 33
  - time and date 76
- display buttons
  - one-line display 251
  - user preferences 165
- Display digits 27, 33
- distinctive ring patterns(DRP)
  - answering a call 46
- distinctive rings 162
- distribution modes, Hunt Groups 174
- DN (see internal numbers)
- DND 105
- DND from 47

DND on busy 116  
DND transfer 47  
DND, cancel 200  
DNs

- checking for updates 27
- rooms 187

Do Not Disturb

- canceling 200
- on Busy 40
- see also DND 200
- set lock 232
- using 200

Do not disturb 78, 85, 103  
Do Not Disturb on Busy, see also DND  
on busy 116  
DOD

- CbC private calls 206
- CbC public calls 206
- PRI description 203

DRT 47  
dual memory buttons, defaults 156  
duration of call 75

---

## E

echo, handsfree 71  
eKIM

- button programming 53

emergency 911 13, 205  
enable autobumping 139  
enbloc dialing, PRI dialing plan 207  
End of session 27  
ending a call 55  
ending test session 254  
enhanced, answer button 63  
Enter code 148  
Enter digits 89, 93  
Enter zone 127  
entering letters through the dialpad 29  
equipment, external page equipment  
128  
erasing

- Call Log items 140
- messages from list 132
- programmed features 147

Evening Sched 223  
Exchanged 161  
Exclusive Hold 84, 98  
Expensive route 78

expensive route warning tone 249  
extended, answer button 63  
external

- access to Norstar 239
- access, describing line pools 249
- access, using remote packages on  
line pools 240
- accessing voice mail 144
- autodial, programming 87
- Call Forward (see Line Redirection)  
page 125
- paging equipment 128

external calls

- assigning Long Tones 236
- line pool 231
- transferring 102
- using Link 234
- using Programmed Release 237

external line

- routing table 231

external line buttons 160  
external lines

- call forwarding 114
- name display 199

external number, last number redial  
description 90  
external page option, default page button  
159  
extra-dial telephone

- DID calls 223
- direct dial 228

extra-dial telephone, DID 223

---

## F

fast busy tone, remote access 242  
FEATR 165  
feature

- Message Reply Enhancement,  
analog telephones 131
- privacy 74
- using line redirection 123
- using page types 125
- voice call 134

feature button 17, 18, 232  
feature code, control telephone 221  
Feature moved 148  
feature programming

- add change speed dial number 32

- allow line redirect 120
- automatic call forward 115
- auxiliary ringer 233
- blocking redial numbers 95
- broadcasting to Hunt Groups 174
- call display, first display 58
- call forward no answer 37
- call forward on busy 39
- call restrictions, Hospitality 188
- change number of rings 38
- changing line name 35
- changing telephone name 34, 199
- direct dial telephone 229
- do not disturb on busy 40
- external autodial 87
- group pickup 60
- Handsfree 72
- handsfree answer back 73
- Hospitality alarm 191
- Hospitality passwords 185
- hotline on telephone 230
- hunt delay 175
- Hunt Group busy line setting 176
- Hunt Group queue timeout 177
- last number redial 90
- line redirect ring control 120
- line redirection 118
- Long Tones 236
- overflow set 177
- page zone 126
- paging 126
- Pause 236
- programmed release 237
- room/desk information 187
- Run/Stop dialing signal 237
- select speed dial line 32
- service times 188
- set lock 233
- system speed dial 31
- system speed dial name 33
- time and date 29
- Trunk Answer 62
- user speed dial 92
- using dialpad to enter letters 29
- using Link 234
- Wait for Dial Tone signal 238
- Feature timeout 257
- features
  - adjusting ring volume 162
  - Autobumping 139
  - autodial 87
  - auxiliary ringer 233
  - Button Inquiry 145
  - Call Display 55
  - Call Duration Timer 75
  - Call Forward 113
  - call forward, using 114
  - Call Information 56
  - Call Log 137
  - Call Park 106
  - Call Pickup 59
  - Call Queuing 99
  - Call Transfer 101
  - Callback 112
  - Camp-on 104
  - changing ring type 162
  - Class of Service password 243
  - Conference Calls 64
  - contrast adjustment 146
  - dialing modes 82
  - dialing signal
    - Programmed Release 237
    - run/stop 237
    - Wait for Dial Tone 238
  - Do Not Disturb 200
  - Do Not Disturb on Busy 116
  - Exclusive Hold 98
  - external call transfer 102
  - Group Listening 68
  - Handsfree 69, 71
  - hiding the message or calls display 162
  - Hold, many calls 97
  - independent Hold during
    - conference 65
  - Last Number Redial 90
  - limiting feature access 232
  - line pools 80
  - Line Redirection 118—123
  - Link 234
  - Messages, sending 128
  - moving line buttons 161
  - paging 125—128
  - Pause 236
  - PRI name and number blocking 205
  - priority call 83
  - Privacy 74



- programming on buttons 147
- remote access to the system 239
- Restriction service 217
- Ring Again 85
- ring type 162
- Ringling service 217
- Routing service 218
- Saved Number Redial 94
- sending messages using analog telephones 128
- sending messages using display 128
- Speed Dial 91
- Test a Telephone 254—256
- testing set features 254
- Time and Date 225
- User Preferences 163
- file transfer using ISDN 214
- filters, Hospitality room states 189
- FIND 165
- first display, changing 58
- Foreign Exchange, see also FX
- Forward denied 118
- Forward no answer, changing 115
- Forward> 118
- forwarding calls 37
  - Call Forward 113
  - Call Forward delay 115
  - Call Forward No Answer 115
  - Call Forward on Busy 116
  - direct dial 228
  - Do Not Disturb on Busy 116
  - Line Redirection 118—123
  - to voice mail 117
- Foward delay 38
- FX
  - CbC type 206
  - see also Foreign Exchange 206

## G

---

- green button caps 150
- grey button caps 150
- Group 4 fax, using ISDN applications 214
- group answering
  - SWCA keys 108
- Group Listening 68
- Group Pickup

- Hunt Groups 60
- using 60

## H

---

- handling many calls at once
  - Call Queuing 99
  - Hold 97
- handset speaker, testing 255
- Handsfree
  - assign button 73
  - automatic answer 73
  - changing to handsfree 70
  - exiting to handset 71
  - headset 73
  - indicators 71
  - making calls 70
  - muting the set 70
  - preventing echo 71
  - programming 72
  - talking in turn 71
  - using 71
- Handsfree 72
- Handsfree Answerback
  - programming 73
  - Voice Call 135
- handsfree button 18, 160
- headset
  - Handsfree requirement 73
  - testing 255
- hearing aid compatibility 55
- Hidden number 78, 91, 95
- Hold
  - automatic 97
  - button 17, 18
  - Conference Call 65
  - display call information 57
  - exclusive 98
  - exclusive hold 84
  - listening while on hold 98
  - putting conference on 66
  - re-establish conference call 65
  - retrieving call 97
  - using background music 201
  - using SWCA keys 108
- Hold or release 143, 259
- Hospitality
  - admin set, controlling alarms 192
  - alarm features 191

- cancel alarm 194
  - cond password 186
  - delaying alarm 194
  - desk password 186
  - passwords 185
  - room/desk information 187
  - service done 189
  - service times 188
  - set description 185
  - sets per room 187
  - setting room condition 189
  - setting room dialing filters 189
  - turn off alarm 194
  - using administration set 190
  - using room set 190
  - using room/set programming 189
  - using the alarm 193
  - hospitality
    - password 227
  - Host system dialing signals
    - Long Tones 236
    - Pause 236
    - programmed release 237
    - Run/Stop 237
    - system speed dial 91
    - using an ATA 236
    - Wait for Dial Tone 238
  - Hotline
    - bypassing the telephone 230
    - setting up the telephone 230
    - using with Handsfree button 230
  - hour, set 30
  - hunt group
    - moving on telephone 161
  - Hunt Groups
    - adding members 171
    - answer incoming calls 43
    - assigning lines 173
    - auxiliary ringer 179
    - broadcast conversion note 169
    - Broadcast mode 174
    - busy line setting 176
    - busy routing 176
    - call forward no answer 38
    - call forward on busy 40, 116
    - call forward no answer 115
    - call park 107
    - calls on Hold 97
    - cannot use Voice Call feature 134
    - creating 246
    - distribution modes 174
    - DND on busy 117
    - group pickup 60
    - hotline, set DN 230
    - hunt delay 175
    - incoming calls 174
    - member DN 171
    - moving members 172
    - no videophones 170
    - overflow set 177
    - paging 126
    - priority call 84
    - programming 169
    - queue time-out 177
    - removing members 171
    - rerouting to a Hunt Group 63
    - Rotary mode 174
    - Sequential mode 174
    - setting the name 178
    - simultaneous ring 174
    - temporarily leaving group 201
    - unassigning lines 173
    - use Do Not Disturb 201
    - using call forward 114
    - using ring again 85
    - where to use 169
  - hunt groups
    - system monitoring 232
  - hybrid template
    - M7208 158
    - M7310 lower buttons 155
    - M7324 buttons 157
    - T7208 158
    - T7316 buttons 152, 155
- I**
- 
- In use 133, 260
  - In use SETNAME 143
  - Inactive feature 257
  - incoming call
    - CLID display on busy 56
  - incoming calls
    - 2-way DID 205
    - hunt groups 43
    - indicators 43
    - overflow routing 249
    - simultaneous ring 174

- SWCA keys 109
    - tracking 137
    - using COS on auto answer 242
  - Incoming Line Groups (ILG), see Hunt Groups
  - Incoming only 260
  - indicators
    - active service display 223
    - call indicators on CAP 50
    - handsfree and mute 71
    - incoming call 43
    - line active 248
    - long distance call 257
    - memory buttons 250
    - message waiting, analog telephone 129
    - restoring message indicators 162
    - rings 45
  - installer programming 14
  - installing telephones 195—198
  - Integrated Services Digital Network (see ISDN)
  - Intercom 121
  - Intercom # 89
  - intercom button
    - answer button calls 63
    - autodial line 88
    - using as the line for Autodial 88
  - internal numbers, description of length 247
  - internal page 125
  - Internet access, using ISDN applications 215
  - Invalid code 93, 238, 257
  - Invalid location 161
  - Invalid number 89, 103, 107, 260
  - Invalid state 212
  - Invalid zone 127
  - Inwat, CbC type 207
  - ISDN
    - 2-way DID 205
    - applications 213—215
    - BRI features 209
    - BRI services 208
    - Call by Call 206
    - call forward all calls 208
    - connecting to 213
    - description 203
    - desktop conferencing, using 214
    - device support on BRI 208
    - dialing plan, PRI 207
    - emergency 911 205
    - equipment 213—215
    - file transfer, using 214
    - Group 4 fax, using 214
    - Internet access using 215
    - LAN access, using remote 214
    - LAN to LAN bridging, using 215
    - leased line backup, using 214
    - making calls from ISDN terminals 82
    - Network Name Display, BRI 209
    - ONN blocking, BRI 210
    - PRI name and number blocking 205
    - PRI Network Name Display 204
    - service provider features 210, 211
    - telecommuting, using 214
    - terminal line access 209
    - videoconferencing, using 213
  - ISDN terminal
    - Automatic Call Back 211
    - Automatic Recall 211
    - Call Forward 210
    - calling the call forward number 211
    - cancel Call Forward 211
    - no ONN 205
- ## K
- 
- KIM
    - buttons on eKIM 53
    - customizing 53
    - sending messages 129
    - using 50
- ## L
- 
- LAN
    - remote access using ISDN applications 214
    - router 215
    - to LAN bridging, ISDN applications 215
  - language
    - changing on the display 167
    - set lock 232
  - last number redial 90

- leased line backup using ISDN
  - applications 214
- length of call, timing 75
- length of internal numbers 247
- letters, entering with dialpad 33
- licensing, background music 201
- limiting
  - access to Norstar 240
  - telephone feature use 232
  - telephone programming 232
  - using alternate or scheduled services 217
- line
  - access from ISDN terminal 209
  - assign to Hunt Groups 173
  - assignment 247
  - button indicators 248
  - button moving 161
  - changing the name 35
  - changing the name of a line 199
  - choosing a line 79
  - choosing autodial 88
  - describing prime line 251
  - description of menu 23
  - for external call forwarding 114
  - Hunt Group busy line setting 176
  - indicators, description 44
  - line redirection, describing 118
  - picking up calls 247
  - pool 80–81
  - Redirection, canceling 119
  - Redirection, using 118–123
  - remote access to the system 239
  - replying to messages 130
  - retrieving a parked call 106
  - speed dial 32
  - target line 248
  - unassigning Hunt Groups 173
  - using line button to answer call 44
- Line 001 waiting 258
- line appearances
  - using SWCA keys 108
- line button
  - assignment 247
  - bypassing the Hotline button 230
  - CAP 48
  - joining call 74
  - moving 161
  - privacy 74
- Line denied 62, 78, 260
- Line hung up 105
- Line in use 259
- line pool
  - description 80, 249
  - external lines routing 231
  - memory button 249
  - overflow routing 249
  - programming buttons 147
  - programming memory button 81
  - using remote packages to restrict external access 240
- line pool access code
  - autodial 88
  - external calls 231
- line profile, viewing 245
- Line Redirection 121
- line redirection
  - all lines 119
  - allow programming 120
  - call forward no answer 115
  - call forwarding differences 122
  - programming 118
  - redirect ring control 120
  - using 123
- Line001 callback 47
- Line001 hung up 103
- Line001 to prime 47
- Line001 transfer 258
- LineXXX to prime 47
- Link
  - blocking 235
  - host system dialing signals 234
  - program on memory button 235
- LIST 165
- listening 68
- listening on hold 98
- log space, programming 142
- log, view call log 139
- logging a call manually 138
- Logit (see Call Log)
- long distance call
  - indicator 257
  - using COS password 239
- Long Tones 237
- loop start line, remote access 239
- Lunch Sched 223

**M**

- 
- M7100 telephone
    - Autodial 88
    - button defaults 159
    - Button Inquiry 145
    - Call Conference 64
    - Call Queuing 258
    - Conference Call on hold 66
    - Conference Call, independent Hold 65
    - Hold many calls 97
    - Incoming Line Group button 44, 79
    - internal numbers 247
    - line assignment 247
    - memory buttons 250
    - one-line display 251
    - Ring Again 259
    - special set features 250
    - Speed Dial programming 92
    - standard dial 82
    - Voice Call 135
  - M7208 telephone
    - button defaults 158
    - memory buttons 250
    - one-line display 251
  - M7310 telephone 16
    - button defaults 155
    - memory buttons 250
    - viewing line profile 245
    - viewing set profile 245
  - M7324 telephone 16
    - button defaults 157
    - CAP 48
    - memory buttons 250
    - viewing line profile 245
    - viewing set profile 245
  - maintaining security 241
  - Make calls first 260
  - making calls
    - dialing modes 82
    - Handsfree 70
    - priority call 83
    - using a line button 79
    - using line pools 80
    - using Ring Again 85
    - with automatic Handsfree 73
  - managing COS passwords 243
  - manual, restriction service 218
  - member DN, Hunt Groups 171
  - members
    - adding to Hunt Groups 171
    - moving Hunt Group members 172
    - remove from Hunt Group 171
  - memory buttons 17
    - CAP 48
    - default assignment 150
    - erasing features 147
    - indicators 250
    - Link 235
    - M7310 156
    - power off 87
    - programming feature codes 147
    - programming with line pool 81
    - storing autodial numbers 87
  - menus, top level 23
  - Message denied 133
  - Message list 133
  - Message Reply Enhancement 131
  - Message to 133
  - message waiting indicator, analog telephone 129
  - messages
    - alarm messages, recording 253
    - analog telephone, answer 129
    - canceling a sent message 130
    - forwarded to Call Pickup 129
    - hiding display 162
    - KIM 129
    - removing from list 132
    - replying 130
    - restoring call indication 162
    - sending 128
    - sending, using the display 128
    - viewing 130, 133
  - Messages & Calls 133, 143
  - microphone
    - muting 70
    - using correctly 71
  - Microphone muted 135
  - MICS, maximum target lines 248
  - MICS-XC, maximum target lines 248
  - minutes, set 30
  - monitoring
    - answer DN's and answer key 63
    - calls 248
    - calls with CAP 50, 54
    - line pool status 85

lines, see also Disconnect  
 Supervision 246  
 telephone status 85  
 transferred calls 112

month, set 30

Move line from 161

Move line to 161

moving  
 911 service note 199  
 automatic telephone relocation 199  
 Hunt Group members 172  
 line buttons, set lock 232  
 telephones 199

music  
 background, licensing 201  
 turning off 201

mute  
 assign button 73  
 button icon 18  
 button positioning on sets 160  
 indicators 71  
 muting the set in Handsfree 70  
 voice call tones 134

## N

---

name  
 changing telephone name 199  
 display, BRI lines 209  
 Hunt Groups 178  
 PRI Network Name Display 204  
 system speed dial 33

name and number blocking  
 BRI 210  
 PRI 205  
 see also ONN 205

needs service, Hospitality 189

Network Call Diversion 213

Network Name Display  
 available features 204  
 BRI 209  
 PRI 204

New calls begin 143

night control phone (see control  
 telephone)

Night Sched 223

night schedule, restriction service 219

Night Service (see services and ringing  
 service)

9. 77, 260

no answer, refusing second call 200

No button free 134, 260

No call on 107

No call to Park 107

No calls waiting 258

No free lines 260

No info to log 143

No last number 78, 91

No line selected 78, 258, 260

No line to use 121

No log assigned 143

No number saved 95

No number stored 93, 134

No response 212

No resume item 143

No services ON 223

No voice call 136

Norstar system dial tone 242

Norstar telephones  
 installing 197  
 mounting on a wall 198  
 set profile, viewing 245  
 viewing line profile 245

Not allowed 212

Not available 212, 257

Not in service 78, 103, 105, 118, 258

Not incoming 212

Not subscribed 212

numbers, entering with dialpad 33

## O

---

OK 251

On another call 79, 85

On hold 98

one button dialing (see Autodial)

one-line display  
 7100 and 7208 sets 251  
 display button equivalents 251

ONN blocking, BRI 210

outgoing calls  
 SWCA keys 111

outgoing calls, 2-way DID 205

Outgoing line 121

Outwats, CbC type 206

overflow  
 call routing 249  
 expensive route warning 249

- Hunt Group routing 176
- set Hunt Groups 177
- overlap dialing 213
- overlay 15, 19, 22, 305
- OVERRIDE 251
- overriding
  - Call Forward 114
  - services, manually 223

## P

---

### page

- default button 159
- external equipment 128
- making an announcement 125
- programming 126
- shortcut codes 125
- types 125
- zones, programming 126
- Page choice 127
- Page timeout 127
- Paging ALL 127
- Paging busy 127
- Park denied 107
- Parked call 258
- Parked Call, retrieving 106
- Parked on 107
- Parking full 108
- password
  - Basic 163, 224
  - Call Log 141—142
    - changing 141
  - Call Log, canceling 142
  - change COS 243
  - changing 224, 225
  - Class of Service 242
  - clearing Call Log 226
  - cond pswd 227
  - description of menu 23
  - desk 186
  - desk pswd 227
  - entering 27
  - Hospitality 186
  - hospitality 185
  - Hospitality password 227
  - managing COS passwords 243
  - registration (Companion) 225
  - room condition 186
  - security practices 241

- System Coordinator 14, 224
- system speed dial code 32
- user preferences 163
- pause
  - Host system dialing signals 236
  - in a sequence of numbers, see Wait for Dial Tone
- PBX
  - link feature 234
  - programming Run/Stop dialing sequence 237
  - Tie CbC service 206
- PBX template
  - M7208 158
  - M7310 lower buttons 155
  - M7324 buttons 157
  - T7208 158
  - T7316 buttons 151, 152, 154
- personal programming 14
- phone 111
- Pickup receiver 259
- Pickup 61
- Pickup denied 61, 62
- pickup group, changing 61
- Please wait 85
- Pool code 121
- power failure, clock 31
- power off, affect on memory buttons 87
- power supply, testing 256
- pre-dial 83
- pre-printed button caps 150
- Press a button 89, 145, 148
- Press a line 161
- Press held line 67
- prevent calls, restriction services 217
- PRI
  - 2-way DID 205
  - Call by Call 206
  - Dialing Plan 207
  - DID 203
  - DOD 203
  - emergency 911 205
  - ISDN description 203
  - name and number blocking 205
  - Network Name Display 204
- prime line
  - description 251
  - external call routing 231
  - standard dial 82

- system speed dial 32
- prime telephone
  - answering calls 47
  - CAP 48
  - direct dial 228
  - overflow routing 249
  - TAP 50
  - using DND 200
- priority call
  - exclusive hold 84
  - see also Call Queuing 43, 83
- Priority denied 85
- Priority>223 259
- privacy
  - changing status 74
  - conference call 64
  - creating conference call 75
  - set lock 232
- private
  - branch exchange, accessing from
    - Norstar (see also host system dialing signals) 234
  - call 75
  - CbC type 206
- private dialing plan, Call by Call 206
- private line, description 252
- Private name 59, 204, 209
- private network, enblock dialing 207
- Private number 59
- Program and HOLD 89, 93, 148
- Program and OK 89, 93, 148
- Programmed 89
- Programmed Release, host system
  - dialing signals 237
- programming
  - administration programming 14
  - administration set 15
  - alarm feature, Hospitality 191
  - alarms 192
  - auxiliary ringer 233
  - Basic password 14
  - basics 14
  - broadcast mode 174
  - busy line setting 176
  - Call Display 58
  - Call Forward 37, 40
  - Call Forward delay 115
  - call forward on busy 39
  - Call Pickup 59
  - call restrictions, Hospitality 188
  - CAP 49
  - changes, planning 15
  - changing buttons, users 164
  - changing the name of a line 35
  - changing the name of a telephone
    - 34, 199
  - check DNs 27
  - condition password 186
  - customizing your Norstar 14
  - direct-dial telephones 229
  - entering passwords 27
  - external autodial button 87
  - features on buttons 147
  - Forward no answer 115
  - group pickup 60
  - Handsfree 72
  - Handsfree Answerback 73
  - hospitality cond password 227
  - hospitality desk password 227
  - hospitality password 227
  - Hospitality passwords 185
  - Hotline telephone 230
  - hunt delay 175
  - installer programming 14
  - KIM 53
  - line redirection 118
  - Link 234
  - log space 142
  - Long Tones 236
  - overflow set, Hunt Groups 177
  - overlay 15
  - page zone 126
  - paging 126
  - Pause 236
  - personal programming 14
  - programmed release 237
  - programming indicator ◀ 20
  - programming indicator ▶ 20
  - programming map 23–27
  - programming overlay 19
  - queue timeout 177
  - recording changes 14
  - Restriction service 217, 218
  - Ringing service 217
  - room/desk information 187
  - Routing service 218
  - Run/Stop dialing signal 237
  - service times, Hospitality 188



- Set lock 232
  - set lock 233
  - starting and ending a session 27—28
  - system and user speed dial 91
  - System Coordinator 27
  - system speed dial 31
  - telephones
    - Call Forward, do not disturb 40
    - Do Not Disturb 200
    - Do Not Disturb on Busy 40
    - priority call 83
    - time and date 29
    - top-level menu description 23
    - user preferences 163
    - User Speed Dial 92
    - Wait for Dial Tone signal 238
  - programming record 14
  - programming telephones
    - block Link 235
    - blocking Redial 95
    - Last Number Redial 90
  - public network
    - dialing plan, PRI 207
    - enblock dialing 207
    - remote access to Norstar 241
  - Public, CbC type 206
  - pulse dialing
    - selecting on the set 238
    - switching 246
- Q**
- 
- query alarm 192
  - queue
    - Hunt Group routing 176
    - Hunt Group timeout 177
- QUIT 251
- R**
- 
- recording alarm codes 253
  - recording changes 14
  - redial
    - last number 90
    - saved number 94
  - Redial by 121
  - redirect ring, programming 120
  - Redirect denied 122
  - redirection
    - all lines 119
    - cancelling 119
    - lines 118
    - loops, avoiding 123
    - programming 118
    - ring control 120
    - using 123
  - refusing to answer second call 200
  - Registration password 225
  - Release a call 105, 259
  - Release button
    -  55
    - icons 18
  - Release calls 259
  - releasing
    - accidentally 76
    - from conference 66
  - relocation, automatic relocation, telephones 199
  - remote access 239—241
    - change COS password 243
    - fast busy tone 242
    - loop start line 239
    - managing COS passwords 243
    - security 240
    - stuttered dial tone 242
    - system dial tone 242
    - through public network 241
    - tones 242
    - using ISDN with LAN 214
    - using COS password 240
  - remove
    - from a conference call 66
    - Hunt Group members 171
    - message, analog telephone 132
    - messages 132
  - replying to a message
    - analog telephone 131
    - digital phone 130
  - reporting alarm codes 253
  - Restr'n 222
  - Restricted call 79, 103, 260
  - restricting
    - access to Norstar 240
    - access using COS password 240
    - feature use, see Set Lock
    - telephone feature use 232
    - telephone programming 232

- using alternate or scheduled services 217
- restriction service
  - control telephone 221
  - filters, COS for remote access calls 242
  - naming 219
  - Night schedule 219
  - preventing calls 217
  - turning off/on 218
- retrieval codes, Call Park 106
- retrieving
  - held call 97
  - parked call 106
- ring
  - auxiliary ringer 233
  - changing ring type 162, 167
  - changing the number of rings
    - before call is forwarded 38
  - description of types 45, 162
  - ring volume setting 162
  - Ringling service 219
  - rotary mode 174
  - sequential 174
  - simultaneous rings 174
- Ring Again 85
  - 7100 series terminals 259
  - set lock 232
- Ring Again? 79, 86
- ring delay, call forwarding 117
- Ringling 222
- ringing
  - distinctive ring patterns 46
- ringing service
  - restriction services 217
  - Trunk Answer 62
- rings
  - change number for call forward 38
  - setting Hunt Group delay 175
- room
  - setting condition 189
  - using room programming 189
- room information, programming 187
- room set
  - description 185
  - using 190
- rooms set
  - call restrictions 188
- rotary mode, Hunt Groups 174

- Routing 222
- routing
  - 2-way DID 205
  - external lines 231
  - Hunt Group routing options 176
  - overflow 249
- routing service
  - control telephone 221
  - outgoing calls 218
  - overflow routing 249
- run/stop, host system dialing signals 237

## S

---

- saved number redial
  - set lock 232
  - using 94
- Sched 4 223
- Sched 5 223
- Sched 6 223
- scheduled services 217
- schedules, viewing active 221
- second call, refusing 200
- security
  - managing COS passwords 243
  - practices 241
  - system 240
  - using COS password 240
  - using DISA 240
- Select a line 79, 93
- Select line out 122
- Select line(s) 122
- Send message? 79
- sending messages
  - set lock 232
  - using feature 128
- sent message, cancelling 130
- sequential mode, Hunt Groups 174
- Service
  - control telephone 221
  - overflow routing 249
  - routing service 218
  - turn off 221
  - turn on manually 219
- service done, Hospitality 189
- Service Modes, see Services
- service provider features
  - 911 service 199
  - Automatic Call Back 211



- Automatic Recall 211
- Call Forward 210
- call information 137
- calling the forwarded number 211
- canceling Call Forward 211
- Service Schedules
  - Evening Sched 223
  - Lunch Sched 223
  - Night Sched 223
  - Sched 4 223
  - Sched 5 223
  - Sched 6 223
- service times, Hospitality 188
- Services
  - description of menu 23
  - display indicator for active services 223
  - overriding 223
  - Restriction service 217
  - Ringin service 217
  - set lock 232
  - Trunk Answer 62
  - turning off and on using feature codes 220
  - turning off/on 218
  - using control telephone to set 217
  - viewing active schedules 221
- Services ON 223
- set
  - date 30
  - types of Hospitality sets 185
  - using administration set 190
  - using room set 190
  - using set programming 189
- Set Lock
  - Full 232
  - limiting access to features 232
  - partial 232
  - programming 233
  - using 232–233
- Set Locked 257
- set profile, viewing 245
- SHOW 251
- Show set 34
- signal
  - Link 234
  - Long Tones 236
  - Pause 236
  - Programmed Release 237
  - run/stop 237
  - Wait for Dial Tone 238
- simultaneous ring, Hunt Groups 174
- snooze, delaying alarm 194
- speakers
  - telephone, testing 256
  - voice call 134
- special telephones 228
- speed dial
  - 7100 sets 92
    - add/change number 32
    - changing user buttons 165
    - choosing a system code 32
    - code 92
    - display 33
    - entering name 33
    - making a call 92
    - programming for User 92
    - selecting a line 32
    - system programming 31
    - using 91
- splitting a Conference Call 66
- square template
  - M7208 158
  - M7310 lower buttons 155
  - M7324 buttons 157
  - T7208 158
  - T7316 buttons 151, 152, 154
- standard dial
  - prime line 82
  - selecting a line 82
- Start of list 134
- Still in transfer 104
- stop calls from ringing at set 200
- stuttered dial tone 240, 242
- suspending a call
  - see also Call Park and Hold
  - using Call Park 106
- SWCA
  - no free call keys 111
  - using 108
- system access, changing programming passwords 224
- system code, system speed dial 32
- System Coordinator
  - maintaining 911 records 205
  - password 14
  - programming 27
  - Restriction and routing service 221

- system dial tone 242
- system monitor telephone
  - using 232
- System prgrming, description of menu 23
- system speed dial
  - add or change number 32
  - description 91
  - description of menu Sys speed dial 23
  - display numbers 33
  - host system signaling codes 91
  - name 33
  - select a line 32
- system time and date, change 225

## T

---

- T7100 Business Series Terminal
  - autodial 88
  - button defaults 159
  - Button Inquiry 145
  - Call Conference 64
  - Call Queuing 258
  - Conference Call on hold 66
  - Conference Call, independent Hold 65
  - Hold many calls 97
  - Incoming Line Group button 79
  - internal numbers 247
  - line assignment 247
  - memory buttons 250
  - one-line display 251
  - Ring Again 259
  - special set features 250
  - Speed Dial programming 92
  - standard dial 82
  - Voice Call 135
- T7208 Business Series Terminal
  - button defaults 158
  - memory buttons 250
  - one-line display 251
- T7316 Business Series Terminal
  - administration set 16
  - button defaults 151, 153
  - memory buttons 250
  - overlay 21
  - viewing line profile 245
  - viewing set profile 245
- T7316E
  - TAP 50
- talking in turn, Handsfree feature 71
- TAP
  - answering calls 50
  - prime telephone 50
  - telephone 50
  - using 50
- target line
  - changing the name 199
  - description 248
  - maximum 248
  - overflow 249
- target lines
  - moving on telephone 161
- TEL# 165
- telecommuting using ISDN applications 214
- telephone
  - 7100 special set features 250
  - 911 199, 205
    - accessing external voice mail 144
    - adjusting the display contrast 146
    - administration display 17
    - administration sets, illustration 16
    - alarm 253
    - announcement 134
    - answer message on analog telephone 129
    - answer prime telephone 47
    - answering voice call 135
    - assigning lines 247
    - automatic relocation 199
    - auxiliary ringer 233
    - blocking link 235
    - blocking redial feature 95
    - button inquiry 145
    - buttons 17
    - bypassing the Hotline set 230
    - Call Display information 58
    - call forward 37
    - call information 56
    - call indicators 45
    - call log, viewing 139
    - cancel a sent message 130
    - cancel DND 200
    - cancel voice call 135
    - CAP 48, 228
    - changing direct dial telephone 229

- changing line name 199
- changing set name 199
- changing the name 34
- control service schedules 231
- control set 221
- default button assignment 150
- denying voice call 135
- dialpad buttons 17
- direct-dial 228
- directed pickup 59
- disconnect supervision 246
- display buttons 19
- display call information 57
- DND 200
- ending test session 254
- erasing call log items 140
- extra-dial 220, 223, 228
- Feature button 17, 18
- group pickup 60
- handsfree button 18
- hiding display 162
- Hold button 17, 18
- Hold call information 57
- Hospitality administration set 190
- Hospitality room set 190
- Hospitality service sets 185
- Hotline 230
- Hunt Group overflow set 177
- installing BST sets 195
- installing Norstar sets 197
- last number redial 90
- line profile, viewing 245
- log calls automatically 137
- logging call manually 138
- Long Tones 236
- making calls from ISDN terminal 82
- memory buttons 17
- moving custom programming 199
- mute 18, 70, 134
- name display 199
- Norstar telephone overlay 22
- prime 228
- programming paging 126
- pulse dialing 238
- refusing second call 200
- Release button 17, 18
- remove messages 132
- replying to a message 130
- retrieving a parked call 106
- ring indicators 45
- sending messages 128
- sent messages, viewing 133
- setting up a hotline 230
- stop ringing using DND 200
- system monitor, hunt groups 232
- system speed dial 31
- T7316E and KIM 50
- testing 254–256
- turn off music 201
- using background music 201
- viewing messages 130
- viewing set profile 245
- volume control 18
- telephone speakers, testing 256
- telephones
  - set lock 232
- template, button assignments 151, 153
- Terminal Answering Position (see TAP)
- terminal connections, BST sets 195
- Terminals&Sets, description 23
- testing
  - buttons 254, 255
  - ending session 254
  - telephone 254
- Their list full 134
- 3 Parties only 67
- Tie, CbC type 206
- time
  - change 225
  - service times, Hospitality 188
- time and date
  -  \* \* T I M E 225
  -  \* \* T I M E 29
  -  806 133
- changing 29
- displaying 76
- hiding message indication 162
- length of a call 75
- time savers
  - autodial 87
  - Saved Number Redial 94
  - Speed Dial 91
- Time&Date, description of menu 23
- timeout, Hunt Group queues 177
- tones
  - camped call tones 104
  - controlling length 236
  - dialing, switching 246

expensive route 249  
 fast busy, remote access 242  
 remote access tones 242  
 stuttered dial tone, remote access 242  
 system dial tone 242  
 voice call 134  
 top-level menus 23  
 tracking incoming calls, Call Log 137  
 transfer  
   calls, monitoring 112  
   cancelling 103  
   see Call Transfer  
 Transfer denied 104  
 transferring calls 101  
   Callback 112  
   parking a call 106  
   using Camp-on 104  
 troubleshooting  
   reporting and recording alarms 253  
   testing handset speaker 255  
   testing telephone buttons 255  
   testing telephone display 254  
   testing telephone speaker 256  
   testing the headset 255  
   testing the power supply 256  
   using the alarm telephone 253  
 Trunk Answer  
   feature 62  
   picking up calls 247  
   set lock 232  
 turning off background music 201

## U

unassigning lines, Hunt Groups 173  
 Unassigned line 122  
 Unknown name 59, 204, 209  
 Unknown name 142  
 Unknown number 59  
 Unknown number 93  
 until\* 222  
 Use line Pool? 259  
 Use prime line 32  
 User Preferences 163–168  
   ☎ \* \* U S E R 225  
 user preferences  
   Basic password 163  
   change display contrast 167

change how calls are dialed 166  
 change languages on display 167  
 change ring type 167  
 changing button programming 164  
 changing speed dial 165  
 display buttons 165  
 password 163  
 subheadings 164  
 user call log options 166  
 user programming 14  
 user speed dial  
   changing 165  
   description 91  
   programming 92  
   set lock 232  
 using  
   alarms 193  
   background music 201  
   Call Forward 114  
   Call Log 137  
   DND 200  
   Do Not Disturb 200  
   Hospitality administration set 190  
   Hunt Groups 169  
   Last Number Redial 90  
   line redirection 123  
   Link 234  
   name and number blocking 205  
   Norstar remotely 239–241  
   the room set 190  
   this guide 13

## V

videoconferencing, using ISDN  
   applications 213  
 VIEW 251  
 viewing  
   active Services 221  
   Call Log 139  
   messages 130, 133  
 Voice Call 134–135  
   answering 135  
   cancel 135  
   deny 135  
 Voice call 135  
 Voice Call Deny, set lock 232  
 voice mail  
   accessing your Norstar system 144

- using Call Forward 117
- voice message center, viewing messages 130
- volume
  - bar, description 252
  - button 18
  - set control 252

## W

---

- Wait for Dial Tone, Host system dialing signals 238
- wake-up
  - cancel alarm 194
  - setting alarm 191
  - turn off alarm 194
  - using sets 193
- wall mounting
  - BST sets 196
  - Norstar sets 198

## Y

---

- year, set 30
- Your list full 134





# Backup programming overlays

