

HP Jornada 700 Series Handheld PC

User's Guide



i n v e n t

Part number Fxxxx-xxxxx
Printed in Singapore
Edition 1

Copyright

The information contained in this document is provided “as is” and is subject to change without notice.

Hewlett-Packard Company makes no warranty of any kind with regard to this manual, including, but not limited to, the implied warranties of merchantability and fitness for a particular purpose. Hewlett-Packard Co. shall not be liable for any errors contained herein or for incidental or consequential damages in connection with the furnishing, performance, or use of this manual or the examples herein.

© Hewlett-Packard Co. 2001.

This document contains proprietary information that is protected by copyright. All rights are reserved. No part of this document may be photocopied, reproduced, adapted, or translated to another language without the prior written consent of Hewlett-Packard Co., except as allowed under the copyright laws.

The programs that control this product are copyrighted and all rights are reserved. Reproduction, adaptation, or translation of those programs without prior written permission of Hewlett-Packard Co. is also prohibited.

Microsoft, ActiveSync, Outlook, Pocket Outlook, Expedia, AutoRoute Express, MapPoint, Windows, Windows NT, the Windows logo, and the MS Windows for H/PC 2000 logo are either registered trademarks or trademarks of Microsoft Corporation in the United States and/or other countries. Microsoft products are licensed to OEMs by Microsoft Licensing, Inc., a wholly owned subsidiary of Microsoft Corporation.

All other brand names and product names used in this document are trade names, service marks, trademarks, or registered trademarks of their respective owners.

Hewlett-Packard Singapore (Pte) Ltd.
Asia Pacific Personal Computer Division
452 Alexandra Road
Singapore 119961

Table of Contents

1 Welcome	1
Using this guide	2
Learning about HP Jornada	4
2 Getting started	11
HP Jornada hardware features	12
Setting up your HP Jornada	16
Using your HP Jornada	24
3 Connecting to your desktop PC	31
Connecting for the first time	31
Connecting to your desktop PC	43
Connecting to another PC	45
Browsing your HP Jornada desktop	46
Synchronizing data	47
Transferring files	54
4 Staying organized	55
Using Microsoft Pocket Outlook	55
Using HP viewer	60
Capturing data with HP quick pad	63
Infrared send/receive of PIM data	64
Recording and playing voice memos	67
5 Getting down to business	71
Working with Microsoft Pocket Office	72
Using Microsoft InkWriter	78
Backing up and restoring data	78
Using OmniSolve from LandWare	82
Using Yahoo! Messenger	82
6 Accessing e-mail	85
Deciding how and why you want to connect	85
Creating Connections	88
Running the HP dialup Setup Wizard	91
Using your connections	102
7 Optimizing your HP Jornada	113
Adding programs, fonts, sounds, and images	114
Accessories	118
Using PC Cards, CompactFlash Cards, and Smart Cards	119

Managing memory	123
Managing battery power	125
Fine-tuning performance.....	132
Security	139
HP security control panel.....	140
Traveling with your HP Jornada	144
8 Troubleshooting	147
Maintaining your HP Jornada	147
Troubleshooting basic problems.....	149
Troubleshooting remote connections	157
Display.....	159
Resetting	159
9 Support and service	163
Web site	163
Customer support	163
Service	163
Contacting Hewlett-Packard worldwide.....	164
Appendix A Ergonomics	167
Setting up and using equipment	167
What is RSI?	167
What causes RSI?	167
RSI symptoms	168
Avoiding RSI	168
Setting up your working environment.....	168
Reducing eye strain	169
Preventing muscle stiffness.....	169
Taking frequent short breaks.....	169
Appendix B Migrating data from other devices.....	171
Transferring data from a palm-sized, pocket or handheld PC.....	171
Migrating data from Palm devices.....	173
Appendix C Using the Keyboard in Terminal Server Client	175
Creating extended keyboard characters in the Terminal Server Client window (TSC)	175
Glossary	177
Index.....	183
Warranty.....	193
One year limited hardware warranty	193
Limitation of warranty	193
Limitation of liability and remedies	194
HP software product license agreement and HP software product limited warranty	196

1 | Welcome

Congratulations on purchasing the Hewlett-Packard Jornada 700 Series Handheld PC (H/PC), a mobile device powered by the Microsoft® Windows® for Handheld PC (H/PC) 2000 operating system. The size and capabilities of the HP Jornada H/PC let you keep your most important business and personal information current and close at hand. Your HP Jornada supports the latest version of Microsoft Pocket Outlook, so you can check e-mail and manage your appointments and contacts while on the road. Your HP Jornada is also the perfect companion to your desktop or notebook PC. It allows you to take vital business data and documents with you when away from the office, then easily transfer updated information back to your PC upon return. A powerful, reliable, mobile business partner, HP Jornada offers you the highest quality in performance and battery life as well as rich programs and utilities designed by Hewlett-Packard.

If you are familiar with Microsoft Windows products and notebook PCs, you will notice that your HP Jornada has many of the same characteristics, making it easy for you to be productive quickly.

In this chapter, you will find:

- An overview of this User's Guide and other sources of help and information
 - A list and brief descriptions of the built-in applications, including MS Windows for H/PC 2000 software and special HP applications
 - An introduction to HP Jornada features and a description of the advantages of using the HP Jornada
-

Using this guide

This User's Guide will give you a quick and effective introduction to your HP Jornada. Although great care has been taken to ensure the accuracy of procedures and artwork, some of the screens displayed on your HP Jornada may differ from the ones that appear in this User's Guide.

Detailed, step-by-step instructions for using the programs on your HP Jornada are also included in online Help, so you do not have to carry this guide when you travel. (For more information on using online Help, see the **Using Help on your HP Jornada** section in chapter 2.)

Conventions

This User's Guide includes certain visual cues that will help you find the information you want easily.



A shortcut, another way to do something, or expanded information about the topic.



Caution or warning information about the topic. This is important information that should be observed to prevent loss of data or damage to the HP Jornada.



Helpful information related to the topic.

Finding information

This guide describes what is included with your HP Jornada, provides an overview of the installed programs, and describes how to set up communications between your device and desktop PC and between your device and the Internet. The following table lists the different types of information available to help you use your HP Jornada. Note that although this book introduces the programs on your device, it does not describe them completely. For more information, see the comprehensive online Help for each program.

Information	Source
Programs	<p>This User's Guide</p> <p>–or–</p> <p>Online Help on your device. On the Start menu, tap Help.</p>
Unfamiliar technical terms	<p>The glossary located at the end of this User's Guide.</p>
Synchronizing and exchanging files with a desktop PC (including information on connecting while traveling)	<p>This User's Guide.</p> <p>–or–</p> <p>Online Help on your device. On the Start menu tap Help.</p> <p>–or–</p> <p>Microsoft ActiveSync online Help on your desktop PC. In the ActiveSync window, click Help, and then click Microsoft ActiveSync Help.</p>
Tool tips	<p>Any toolbar button. Tap and hold the button and the button name will appear. (To avoid activating the toolbar button, drag off the button before lifting the stylus.) For more information, see the Using your HP Jornada section in chapter 2.</p>
Troubleshooting information on connections	<p>This User's Guide</p> <p>–or–</p> <p>The ActiveSync Troubleshooter on your desktop PC. In the ActiveSync window, click File, Click Connection Settings, and then click Help to activate the ActiveSync Troubleshooter.</p> <p>For more troubleshooting help visit the Microsoft Mobile Devices Web site at www.microsoft.com/mobile.</p>

Software updates, device drivers, and lists of compatible accessories	The HP Jornada Web site at www.hp.com/jornada .
Up-to-date information on MS Windows for H/PC 2000-based devices	The Microsoft Windows Mobile Devices Web site at http://www.microsoft.com/mobile/ .
Information on this release of MS Windows for H/PC 2000	Readme.doc file (located in the Microsoft ActiveSync folder on your Windows desktop PC).



The complete text of this User's Guide is available on the HP Web site at www.hp.com/jornada. You can download the User's Guide to your desktop PC and view it using the AdobeTM Acrobat Reader, available from the Adobe Web site at www.adobe.com.

Learning about HP Jornada





Hewlett-Packard has taken mobile computing to new levels of compatibility and convenience. With HP Jornada, you will notice many benefits not found in other, similar computers. For example, you can:

- Move the data you already have on an older palmtop or handheld PC to your HP Jornada. You can transfer information from older Windows CE devices and even some non-Windows CE devices. (See the Transferring PIM data from older palmtop PCs section in Appendix B.)
 - Use e-mail without a modem. Conveniently send e-mail automatically when you synchronize with your desktop PC. (See the Synchronizing data section in chapter 3.)
 - Take more data with you. A desktop Microsoft Word file may take up to 85 percent less space on your HP Jornada. (See the Transferring files section in chapter 3.)
 - Send voice messages to friends and colleagues—even those who do not have H/PC 2000 devices. You can save voice
-

messages in the compatible Wave audio format. (See the Recording voice memos section in chapter 4.)

- Keep Word, Access, and Excel files stored at work and at home synchronized. Update any file in any location, and once you synchronize, the file will be updated in every place it is stored. (See the Synchronizing data section in chapter 3.)
- Read online news and information while offline, or download Web pages for viewing later. (See the Browsing the Web section in Chapter 6.)
- Work any time, any place, with up to 9 hours of battery life. (See the Managing battery power section in chapter 7.)
- Synchronize mail messages, contacts, appointments, and tasks with your desktop or notebook PC in just a few steps. (See the Synchronizing data section in chapter 3.)
- Carry your HP Jornada with you. The HP Jornada weighs only 510 g (1.1 lb.), including batteries.
- Expand your functionality with PC Card accessories. (See the Accessories section in chapter 7.)

HP Jornada is your mobile computing companion. Several valuable features allow you to stay organized and in touch while you are on the road. For instance:

- The HP Jornada viewer application displays PIM data (contacts, calendar, and tasks) at a glance, allowing you to navigate to or view the data you need immediately. You can even view notes attached to appointments. 
- The HP Jornada dialup application leads you through the steps required to configure a dial-up connection and to access your e-mail and the Web. When you are ready to connect, just use the convenient dialup window on your HP Jornada desktop. 
- The HP Jornada quick pad provides a convenient place to jot down notes, names, telephone numbers, and other data for short-term storage. Information can be saved in quick pad for fast retrieval or sent to the appropriate database for long-term storage. 
- The HP Jornada backup application can back up and restore information to/from an optional CompactFlash 

Card or PC Card, safeguarding against loss of data while you are on the road—even if power is lost.

HP Jornada programs

Your HP Jornada already includes the full suite of software that you need to function as a mobile professional. Detailed information can be found in later chapters.



The programs listed below are pre-installed in ROM, so you will never need to reinstall them.

Microsoft Pocket Office

On the **Start** menu, point to **Programs**, point to **Office**, and then tap one of the following choices.



- **Pocket Word**—Take notes and compose documents, or transfer Microsoft Word files from your desktop PC to read and review while you are away from your office.



- **Pocket Excel**—View and edit price lists or financial forecasts on your HP Jornada, or fill out your expense form before you even land at the home office.



- **Pocket Access**—Take database information with you on the road, and fill in custom forms to update Access databases when you return to your office.



- **Pocket PowerPoint**—Create professional presentations on your desktop, and then take them with you to show on your HP Jornada. Or, use a PC Card VGA adapter (F1252A) to project them to an external monitor or VGA projector.

Microsoft Pocket Outlook

On the Start menu, point to Programs, point to Pocket Outlook, and then tap one of the following choices.





- **Calendar**—Never miss a meeting. Keep track of important dates and events or manage your schedule.





- **Contacts**—Take your address book with you so that you always have access to names, addresses, and telephone numbers. If you update your HP Jornada contacts list, just synchronize with your desktop PC and your contacts will
-

always be up to date.

- **Inbox**—Send and receive e-mail messages and synchronize your HP Jornada Inbox with Microsoft Outlook™ or Exchange™ on your desktop PC partner in a matter of minutes 
- **Tasks**—Keep track of to-do lists. Set an alarm or a reminder and HP Jornada will make sure you do not forget a task! 





Microsoft Explorers

On the **Start** menu, point to **Programs**, and then tap **Internet Explorer** or **Windows Explorer**. Or, double-tap the **Internet Explorer** or **My Handheld PC** icons on the desktop.

- **Microsoft Internet Explorer 4.01 for Handheld PC**—Browse the Web from your HP Jornada or subscribe to channel content with this version of Microsoft Internet Explorer 4.01 developed specifically for the H/PC. 
- **Windows Explorer**—Browse the files and folders on your HP Jornada. 

Communication

On the **Start** menu, point to **Programs**, point to **Communication**, and then tap one of the following choices.

- **ActiveSync™**—Synchronize your HP Jornada with your desktop or notebook PC over a network or dial-up connection from a remote location. 
 - **PC Link**—Establish the connection between your HP Jornada and desktop PC partner with a single tap. 
 - **Yahoo Messenger**—Send and receive messages instantly. Stay in touch with friends, family and associates whenever you are on line. 
 - **Remote Networking**—Connect to a dial-up server, RAS account, or Internet service provider. 
 - **Terminal**—Connect to online services that require VT-100 or TTY terminal emulation. 
-

Special HP Applications

On the **Start** menu, point to **Programs**, point to **HP Applications**, and then tap one of the following choices.



- **HP viewer**—Display Calendar, Task, and Contact information (Pocket Outlook) in as much detail as you need so that you are always in control of your schedule. Month View, Week View, and Day View help you manage your calendar even more efficiently. (HP viewer is also accessible through a desktop icon and an HP hot key.)



- **HP dialup**—Configure connections to the Internet and e-mail accounts or corporate network, and then dial in from a convenient pop-up window on your HP Jornada desktop. (HP dialup is also accessible through a desktop icon.)



- **HP quick pad**—Write simple notes and reminders on this electronic notepad, and then move the important information to Pocket Outlook or a Word document.



- **HP security**—Control access to your HP Jornada and the important information you have stored on it. Set passwords for accessing your device.



- **HP info exchange**—Exchange PIM data with PDA devices with IrDA capability (e.g., Palm PDA devices)



- **HP backup**—Protect your valuable data even when you are away from your office by backing up your Pocket Outlook data or your entire device to a CompactFlash or PC Card.



- **HP ChaiVM**—Allows you to view Java applets in Internet Explorer on your HP Jornada and provides developers with a complete runtime environment for integrating Java applications on the H/PC.

On the **Start** menu, point to **Programs**, point to **HP Utilities**, and then tap one of the following choices.



- **HP settings**—Adjust screen controls and sound volume to suit any work environment. Or, choose from four preset profiles for different environments, and change all options with the touch of a button.
-

- **HP hot keys**—Open programs, files, or folders with a single keystroke. The HP Jornada hot keys and hard icons are fully customizable, so you can configure them for one-touch access to your favorite programs or frequently used documents.



Accessories

On the **Start** menu, point to **Accessories**, and then tap one of the following choices.

- **Microsoft InkWriter®**—Jot quick notes or create sketches while in a meeting.
- **Microsoft Voice Recorder**—Record voice memos, reminders or other vital information for later playback.
- **Calculator**—Perform simple calculations in an on-screen calculator, and then copy the results to any open document.
- **World Clock**—Keep track of the time anywhere in the world and display useful travel information for both your home city and the city you are visiting.
- **OmniSolve®**—Perform complex mathematical and business calculations with this full-featured calculator from LandWare.



Games

- **Solitaire**—Pass the time at the airport, on the train, or during a not-so-interesting meeting or lecture with this classic game.



Additional H/PC-compatible software is available for download from the HP Jornada Web site at <http://www.hp.com/jornada/solutions>.





2 | Getting started

This section will help you start using your Hewlett-Packard Jornada 700 Series Handheld PC (H/PC). You will learn how to set up your HP Jornada, receive a brief introduction to MS Windows for H/PC 2000 operating system, and discover how to customize its features to work for you. When you have finished this chapter, you will have all the information you need to begin working with your HP Jornada.

This chapter includes step-by-step instructions to help you:

- Identify the hardware features of your HP Jornada
 - Connect the ac adapter
 - Install the main battery
 - Install the backup battery
 - Complete the MS Windows for H/PC 2000 Welcome Wizard
 - Put your HP Jornada to work for you
-

HP Jornada hardware features

The views below will introduce you to the various connectors, ports, and other features of your HP Jornada.

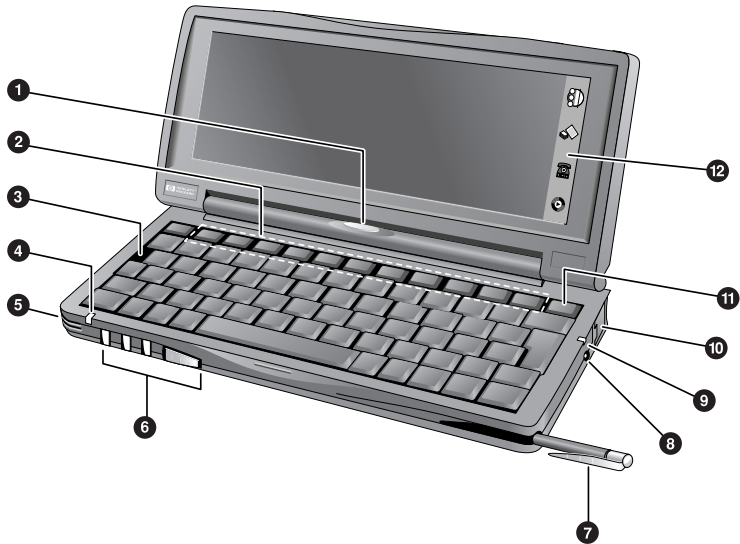

- ❶ **Appointment notification LED**—Notifies you of scheduled appointments, alarms, and reminders. (For more information on setting alarms and reminders, see the **Using Microsoft Pocket Outlook** section in chapter 4.)
- ❷ **HP hot keys**—Allow one-touch access to your favorite programs, folders, documents, or frequently used settings. (See the **Customizing the HP hot keys and hard icons** section in chapter 7.)
- ❸ **Reset button**—Restart your Jornada with the touch of a button.



The **Reset button** quickly reinitializes the MS Windows for H/PC 2000 operating system. (Warning: When you reset your HP Jornada, you will lose all unsaved data in any open documents. See the **Resetting** section in chapter 8.)

- 4 **Status LED**—A steady red light indicates that Voice Recorder is recording a voice memo; a flashing green light indicates that your Jornada display is off but the device is still turned on.
 - 5 **Microphone**—Allows you to record voice memos.
 - 6 **Audio buttons**—Enable you to listen to your favorite MP3 or WMA music files with Windows Media Player
 - 7 **Stylus and stylus slot**—Keeps your stylus within easy reach. (For more information, see the **Using the stylus and touch screen** section in this chapter.)
 - 8 **dc jack for ac power adapter**—Connect your HP Jornada to ac power to charge the main battery.
 - 9 **Battery charging LED**—Indicates the charging status of the main battery while connected to ac power.
 - 10 **Telephone connector (RJ-11)**—Enables you to connect a telephone line to the built-in modem (on models equipped with a built-in modem), keeping you in touch with the world. (For more information, see the **Connecting the telephone line** section in chapter 6.)
 - 11 **Instant-on/off**—No waiting for the Jornada to start up or shut down. Just press the on/off button to suspend operation, and later when you turn it back on again, you can start working exactly where you left off.
 - 12 **HP hard icons**—Adjust display and volume settings, check system status, backup your data, open a dialup connection, or play music files with just a tap of your stylus. (See the **Customizing the HP hot keys and hard icons** section in chapter 7.)
-

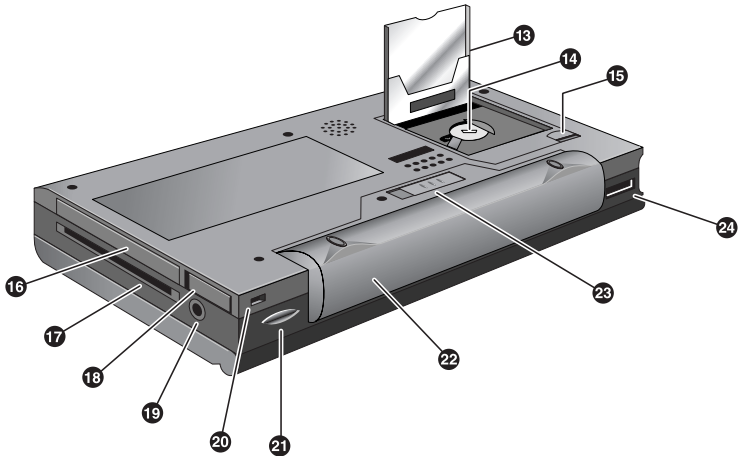

- 13 CompactFlash Type I card slot**—Enables you to add storage memory or use accessories on CompactFlash cards. (For more information, see the **Using PC Cards, CompactFlash Cards and Smart Cards** section in chapter 7. For a list of recommended accessory cards, go to the HP Jornada Web site at www.hp.com/jornada.)
 - 14 Backup battery compartment**—Holds a 3-V CR2032 coin-cell backup battery. (For information on replacing the backup battery, see chapter 7.)
 - 15 CompactFlash door release tab**—Slide the tab in the direction of the arrow to insert CompactFlash Cards or access the backup battery compartment.
 - 16 PC Card Type II card slot**—Enables you to use PC Cards (also called PCMCIA Cards) to expand memory, connect to an external monitor, or add other functionality to your HP Jornada. For information on how to use PC Card accessories, see the **Using PC Cards, CompactFlash Cards and Smart Cards** section in chapter 7. (For a list of recommended PC Cards, go to the HP Jornada Web site at www.hp.com/jornada.)
-

- 17 **Smart Card reader slot**— Smart Cards are designed with embedded chip technology that enables the highest standard in device security for HP Jornada owners. For information about using Smart Cards, see the **Using PC Cards, CompactFlash Cards and Smart Cards** section in chapter 7, or go to the HP Jornada Web site at <http://www.hp.com/jornada>.
 - 18 **PC Card release tab**—Flip the tab out and depress it to eject a PC Card from the Type II PC Card slot.
 - 19 **Earphone jack**—listen to your favorite music via the stereo earphone jack.
 - 20 **Security cable slot**—Allows you to keep your HP Jornada safe with the connection of an optional thin-wire security cable.
 - 21 **Infrared port (SIR IrDA-compliant transceiver)**—Enables you to send and receive files by infrared beam between your HP Jornada and another HP Jornada or palmtop PC, or between your HP Jornada and an infrared-equipped printer or desktop PC. (For more information, see the **Connecting by infrared** section in chapter 3 and the **Infrared transfer** section in chapter 8.)
 - 22 **Main battery**—Provides power to your HP Jornada for up to 9 hours of use. *Optional Extended battery is available for up to 24 hours of use.*
 - 23 **Main battery release tab**—Slide the tab to release the main battery for removal or replacement.
 - 24 **Serial Port (RS-232C)**—Connect your HP Jornada to your desktop PC to transfer files or synchronize Pocket Outlook data, or connect your HP Jornada directly to a printer, external modem, or other device. (For more information, see the **Connecting for the first time** section in chapter 3.)
-

Setting up your HP Jornada

Follow the steps in this section to start using your HP Jornada for the first time. As part of the setup process, you will connect the ac power adapter, install the main battery, install the backup battery, and complete the MS Windows for H/PC 2000 Welcome Wizard. To set up your HP Jornada, you will need to have your HP Jornada, the ac adapter, the HP Jornada Standard Battery, the backup battery (attached to the Quick Start Card), and the power cable.



Follow these steps in the order they are presented. Do not install the backup battery before connecting ac power and installing the main battery.

Connecting the ac adapter

To avoid running out of battery power, you can operate your HP Jornada on ac power using the supplied ac adapter. The ac adapter accepts 100 to 240 V, enabling you to connect to ac power anywhere in the world. When you travel, you may need adapters to accommodate different electrical outlets, but the HP Jornada ac adapter will safely convert ac line voltage to the dc voltage required by your HP Jornada.

Use only the supplied ac adapter (model HP F1279B, input specifications 100-240 V ac, 50-60 Hz, 1.5 A).

While your HP Jornada is connected to ac power, the main battery is charged automatically. The color of the LED indicates the status of the battery: Amber indicates that battery is charging, and green indicates that the battery is fully charged.

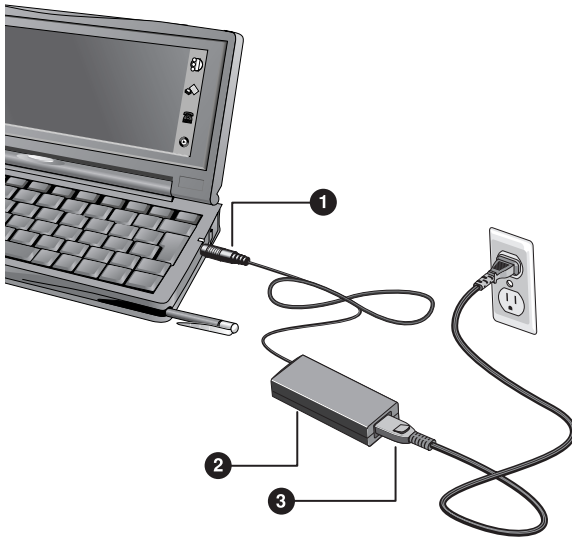

The ac adapter components: **1** dc plug, **2** ac adapter, and **3** power cable.

To connect to ac power

1. Connect the cable from the ac adapter to the dc jack on the right side of your HP Jornada.
2. Connect the power cable to the ac adapter.
3. Plug the power cable into an ac power outlet.

After you connect the ac adapter your HP Jornada will turn on automatically. However, you should install the main battery and install the backup battery before using your device.



Installing the main battery

The HP Jornada Lithium-Ion Battery provides power to your HP Jornada while it is not connected to ac power. Under normal operating conditions, the fully charged battery should provide power for up to 9 hours of continuous use; however, battery life will vary depending on how you use your HP Jornada.



Rechargeable **Lithium-Ion** batteries, unlike NiCD and NiMH batteries, are not subject to "memory effect," allowing you to fully recharge your batteries at any time regardless of battery power level.

The main battery fits into the bottom of your HP Jornada, as shown in the following diagram.

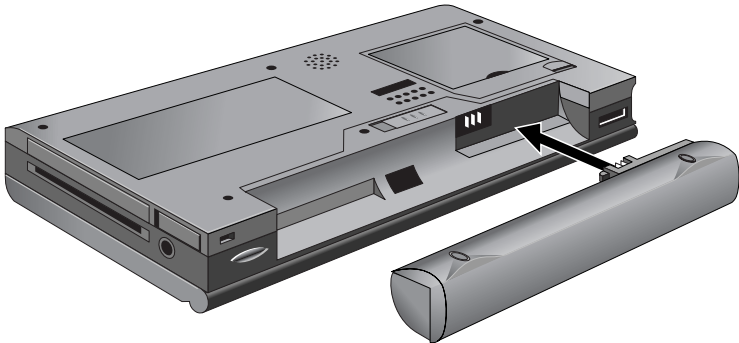

This bottom view of the HP Jornada shows how to install the main battery.

To install the main battery

- Place the main battery in the battery slot on the bottom of your HP Jornada and push firmly until it snaps into place.

The main battery should be partially charged when removed from the box. However, you should charge the main battery fully before operating your HP Jornada on battery power. Charging the main battery takes approximately 3.5 hours. When the battery is fully charged, charging stops automatically; the battery will not overcharge if left connected to ac power.



When the main battery charge is low, a low battery warning is displayed. If you see a low battery warning message displayed, connect ac power and charge your main battery immediately to avoid draining your backup battery, and possible data loss.

Do not mutilate, puncture, or dispose of batteries in fire. The batteries can burst or explode, releasing hazardous chemicals. Replace batteries only with the types recommended in this User's Guide. Discard used batteries according to the manufacturer's instructions.



Installing the backup battery

The backup battery protects your data when the main battery runs out of power. The backup battery does not provide enough power to operate your HP Jornada, but it will preserve your data while you replace the main battery or while you connect to ac power to recharge. The 3-V CR2032 coin-cell backup battery is attached to the HP Jornada Quick Start Card. Follow the procedure outlined below to install the backup battery.

To prevent loss of data, replace the backup battery as soon as a warning message appears on your screen indicating that backup battery power is low. (For detailed instructions on replacing the backup battery, see the **Managing battery power** section in chapter 7.)



To install the backup battery

1. Remove the backup battery from the HP Jornada Quick Start Card.
 2. Turn the Jornada upside-down and open the CompactFlash door.
 3. Use the tip of the stylus to carefully open the backup battery cover.
 4. Insert the battery **printed side up** in the battery compartment.
 5. Using the stylus tip, close the backup battery cover to secure the coin-cell battery, and then close the CompactFlash door.
-

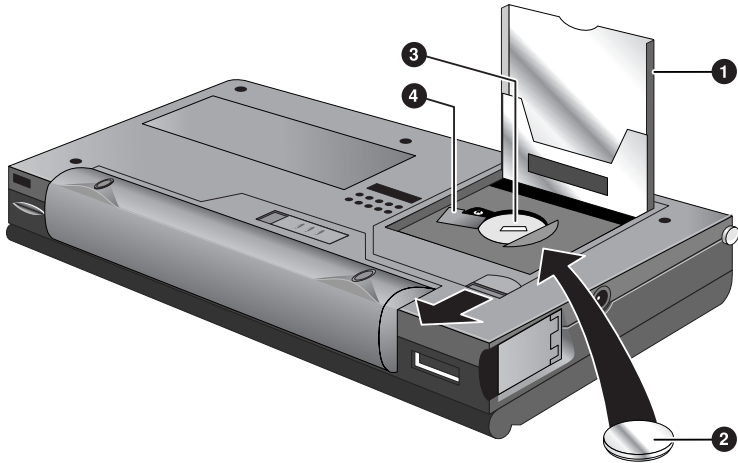

Installing the backup battery

- 1 CompactFlash door shown open
- 2 Coin-cell 3V CR2032 backup battery
- 3 Backup battery compartment
- 4 Backup battery cover in open position



Be sure to **close the backup battery cover before closing the CompactFlash door** in order to avoid damaging these components.

Using the stylus and touch screen

Use the stylus in much the same way you would use a mouse to navigate and select objects on screen. You can also use your fingertip to tap the touch screen, but the stylus provides the greatest accuracy.

For convenience, the stylus is stored in the stylus slot on the front of the HP Jornada. To remove the stylus, push on the stylus to release the catch as you slide it out of the slot.



The top of the stylus pops up to make it easy to remove the stylus. Pressing the top has no effect on the stylus function.

To navigate by using the stylus, follow these tips:

- Where you would normally click a mouse, simply tap the stylus on the touch screen to select an icon or activate a button.
- Double-tap instead of double-clicking on a mouse.
- Hold down the  key as you tap instead of right-clicking on a mouse.







To replace the stylus, insert the pointed end of the stylus into the slot and push until it clicks into place.

Following the Welcome Wizard

After you install the main battery, your HP Jornada will turn on automatically. At startup, the Hewlett-Packard welcome screen appears. Then, after a few moments, the MS Windows for H/PC 2000 Welcome Wizard begins. The Welcome Wizard presents a brief orientation that helps you to calibrate the touch screen and configure device settings such as the World Clock and Owner Identification.

Before you begin working, you may need to adjust the brightness and contrast of the display to compensate for different lighting conditions and viewing angles. You can use the keyboard to adjust both contrast and brightness.

To adjust screen brightness and contrast

1. To adjust the contrast, hold down the  key as you press  or .
2. To adjust the brightness, hold down the  key as you press  or .

To maximize battery life, minimize the brightness setting and then adjust contrast to achieve greater readability



The following sections describe the Welcome Wizard. To complete the Welcome Wizard, follow the instructions displayed in the taskbar area at the bottom of your screen. After you complete the Welcome Wizard, you can begin using your HP Jornada.

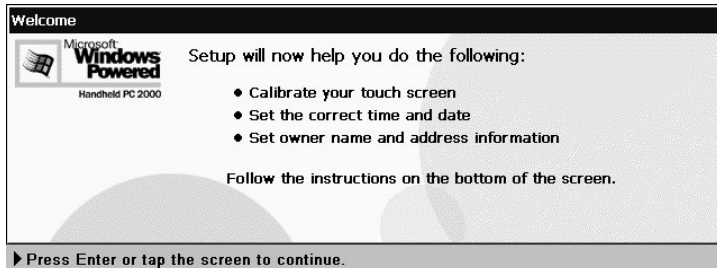

If your HP Jornada freezes during operation, you may need to perform a soft reset. To reset, use the stylus to press the reset button located on the left side of the HP Jornada keyboard. Your HP Jornada will restart automatically. Unsaved data in any open documents will be lost. For more information, see the **Resetting** section in chapter 8.

Calibrating the touch screen



Before you can use the stylus to navigate, you must calibrate the touch screen to align the image on the screen with the touch-sensitive coating. The first screen of the Welcome Wizard prompts you to calibrate the touch screen by tapping a series of targets at different locations on the screen.

From time to time, you might notice that the accuracy of your stylus tap diminishes. When this happens, you can return to this screen to calibrate your touch screen.

To calibrate the touch screen

- On the **Start** menu, point to **Settings**, tap **Control Panel**, and then double-tap the **Stylus** icon.

–or–

Press   .

You can also use the Stylus control panel to set options for double-tap rate and physical distance between taps.

Selecting your Home City

MS Windows for H/PC 2000 displays current time and regional information for the city you designate as your “Home City.” Tap the city nearest your home from the drop-down list on the **Home City** tab. If your city is not listed, you can use the World Clock control panel to add it later. (See the **World Clock** topic in online Help.)

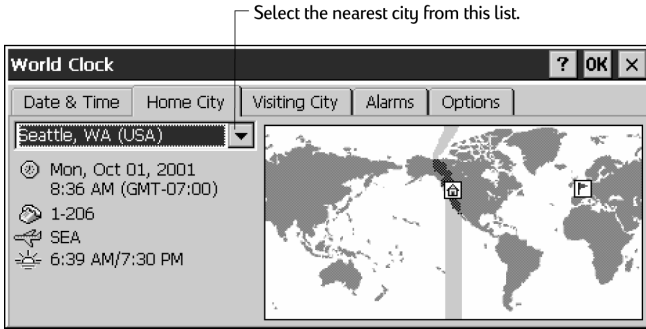

Setting the World Clock

MS Windows for H/PC 2000 uses the system clock to monitor your alarms and appointments as well as to ensure proper synchronization of the most current files and appointments with your desktop PC. So make sure you set the correct time and date. To set the time, type the current time in the box below the clock face, or drag the hands on one of the clocks to the correct time. To set the date, tap the current date on the calendar. (Tap ◀ or ▶ to change month or tap the month or year.)

You can set the clock settings again later using the World Clock control panel. (See the **World Clock** topic in online Help or tap the clock in the status area of the taskbar.)

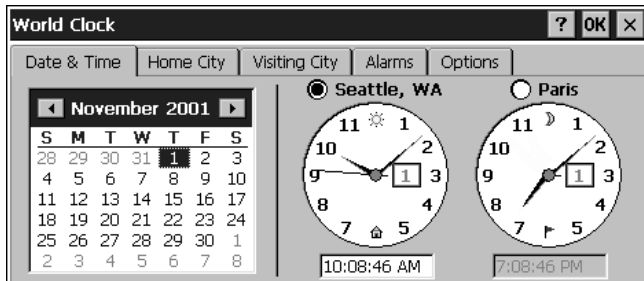

Adding owner information

You can set MS Windows for H/PC 2000 to display owner information, such as your name, address, and telephone number. You can also type a note to be displayed; for example, offering a reward for the safe return of your HP Jornada. To display your owner information each time you start your HP Jornada, tap **Start**, then tap **Settings**, and then tap **Control Panel**. Open the **Owner** control panel and select the **Display Owner Identification** check box under **At Power On**.

You can change the information you type here at any time using the Owner control panel. (See the **Settings** topic in online Help.)

Using your HP Jornada

After you complete the Welcome Wizard, you can begin using your HP Jornada and its built-in programs.

Welcome to MS Windows for H/PC 2000

Congratulations on purchasing a mobile device powered by MS Windows for H/PC 2000. The size and capabilities of your HP Jornada let you keep your most important business and personal information up to date and close at hand. Microsoft ActiveSync increases the power of your HP Jornada by letting you synchronize the information on your desktop or notebook PC with your device.

Using the Start menu and Taskbar

Use the Start menu to open settings, online Help, recently used documents, and programs such as the HP Applications. Just tap **Start**, and then tap the program or item you want to open. In addition to the **Start** menu, the taskbar contains buttons for the programs you have running, a status area, and a desktop icon.

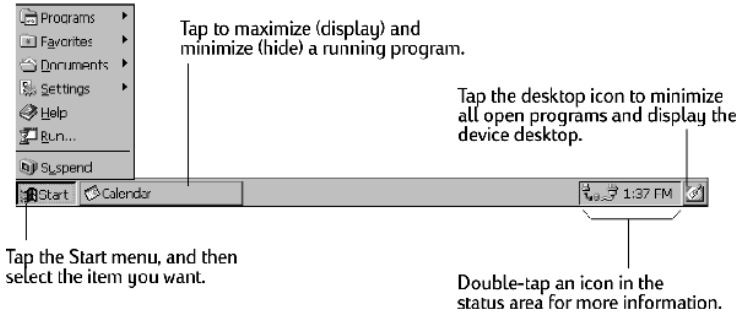

Using the command bars

Each program has a command bar located at the top of the program window. The command bar displays both menu names and toolbar buttons. Tap the slider and drag to switch between displaying toolbar buttons only or menu names and toolbar buttons. You can drag the slider to display only the buttons and menu names you want. You can also drag the slider down to move the toolbar buttons under the menus.

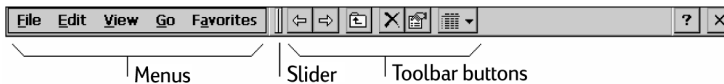

Using Help on your HP Jornada

You can get Help for specific programs, including MS Windows for H/PC 2000, as follows:

- For detailed procedures and overview information about a program, on the **Start** menu, tap **Help**, and then tap the program name.
- For MS Windows for H/PC 2000 Help, tap the **?** button in any program or dialog box where it appears.
- To learn the function of a specific button or control, tap and hold on a toolbar button and its name will appear in a ToolTip. Drag the stylus off the toolbar button before lifting to avoid activating the button.



Online Help uses the same font setting as Internet Explorer. Changing the font size in Internet Explorer will also change the font size in Help.

Turning your HP Jornada on and off

One of the most convenient features of MS Windows for H/PC 2000 and HP Jornada is “instant on.” With instant on, there is no waiting for HP Jornada to start up or shut down; you can start working immediately by pressing the On/Off key on the upper right corner of the keyboard. When you are finished, turn off your HP Jornada by pressing the On/Off key or by tapping **Suspend** on the **Start** menu. Turning off your HP Jornada simply suspends operation. When you turn it on again, you can resume working.



You can also set options in the Power control panel to turn your HP Jornada on and off automatically. For example, you can set your HP Jornada to turn on when you tap the touch screen with the stylus. To conserve battery power, you can set HP Jornada to auto-suspend or to turn itself off after a preset period of continuous idle time. By default, your HP Jornada will auto-suspend after 3 minutes while running on battery power. (For more information on these options and tips for conserving battery power, see the **Managing battery power** section in chapter 7.)







If the HP Jornada wakes up from a suspended state and there is no user activity for one minute, the Jornada will return to a suspended state. To avoid this, simply use any of the Jornada's functions or programs within the one-minute interval.

Using the HP Jornada keyboard

To provide full functionality in a smaller size, the HP Jornada keyboard lets you accomplish common tasks with a few convenient key combinations:

- To turn the caps lock on or off, press and hold the  key as you press the left  key. While caps lock is on, the  symbol appears in the status area of the taskbar.
-

- To activate (or deactivate) the numeric keypad, press and hold the  key as you press the  key. While the numeric keypad is activated, the  symbol appears in the status area of the taskbar.





Be sure the numeric keypad is deactivated and caps lock is off while you set your password and before you turn off your HP Jornada. Check for either the  or  symbols in the status area of the task bar at the lower right of the Jornada display screen. If either of these symbols appear, be sure to deactivate them before setting or re-entering your password.





-
- To type accented or international characters, press and hold the  key as you press the keys corresponding to the character (international versions only). International versions of the HP Jornada have slightly different keyboard layouts.

When using **Terminal Server Client**, the  key is not available for use in typing extended or international keyboard characters. See Appendix C for information on alternative keystroke combinations in **Terminal Server Client**.



-
- To generate extended characters or keyboard commands, hold down  or  as you press a key. Holding down the  key will activate the character or command printed in yellow, while pressing  will activate the character or command printed in blue.

You can also use the Keyboard control panel to adjust how quickly characters repeat when you hold down a key. To open the Keyboard control panel, press  .



Using HP Jornada settings

The HP Jornada settings application gives you access to many useful controls. Use the HP Jornada settings control panel to:

- Adjust your screen brightness and contrast in different lighting conditions
- Adjust speaker volume or quickly mute all sounds
- Check the remaining battery power
- Check the amount of system memory available

HP Jornada settings also enable you to save your preferred sound, contrast, and brightness settings in a custom profile, so you can change all your options with a single tap.

To open HP settings

- On the **Start** menu, point to **Programs**, point to **HP Utilities**, and then tap **HP settings**.

–or–

Tap the HP Jornada settings hard icon on the left side of the screen.

For more information about the HP Jornada settings application, refer to the **Using the HP settings application** section in chapter 7 or the **HP settings** topic in online Help.

Using the audio buttons

The audio buttons on the front of your HP Jornada enable you to play Windows Media Audio and MP3 music files using **Windows Media Player**.

There are three audio buttons and a sliding audio lock.



When locking the audio buttons, be sure to slide the audio lock button to the fully locked position to avoid accidental activation of Windows Media Player in your pocket or luggage.

When using **Windows Media Player**, the buttons control volume and play/stop functions.

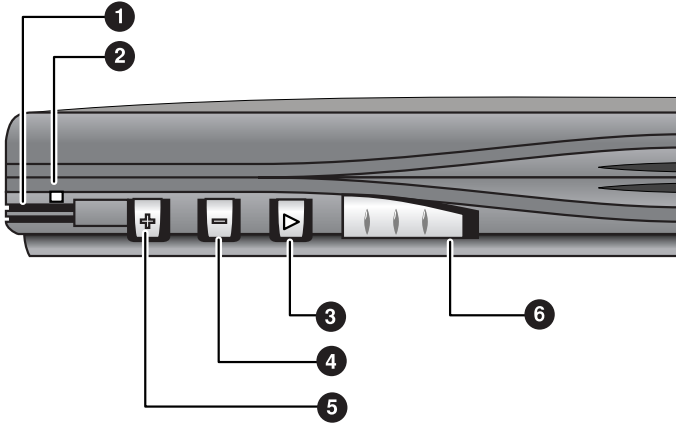

HP Jornada Audio buttons

- | | |
|---------------------|--------------------------|
| 1 Microphone | 4 Volume decrease button |
| 2 Status LED | 5 Volume increase button |
| 3 Play/Pause button | 6 Audio button lock |

When you press the Play button, Windows Media Player plays the currently selected play list. Play lists are selected from within the Windows Media Player application.

For more information about play lists and using Windows Media Player in general, see the Windows Media Player online help files.



Playback volume levels may vary considerably between different recording formats. To avoid uncomfortably high sound levels when listening to music via earphone, turn down the volume before you start playback. Then, adjust the volume to the desired listening level.



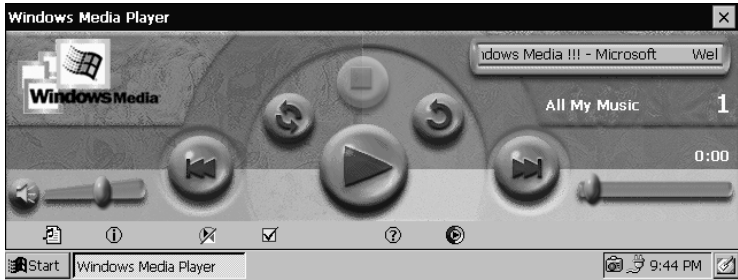

When an audio file is being played, appointment notification will not sound (even if sound and reminders have been set in the control panel), however, the appointment notification light will still flash.



When playing MP3 music files through the HP Jornada built-in speaker, reduce the bass setting. See *Setting bass and treble levels* in Chapter 7.

3 | Connecting to your desktop PC

Your HP Jornada 700 Series Handheld PC works perfectly as a standalone computer. But to get the most out of your HP Jornada, you will want to connect to your desktop or notebook PC. This chapter describes how to establish a connection between your HP Jornada and a desktop PC, and how to use your HP Jornada with a desktop PC—or with any PC that has Microsoft ActiveSync installed. You will learn to:

- Connect to your desktop PC
- Set up Microsoft ActiveSync
- Establish a partnership between your HP Jornada and your desktop PC
- Use Microsoft ActiveSync to browse the contents of your HP Jornada
- Synchronize Microsoft Pocket Outlook data and e-mail messages with Microsoft Outlook or Exchange
- Transfer files between your HP Jornada and a desktop PC
- Connect to and transfer files between your HP Jornada and a corporate network or home desktop PC over the Internet or by telephone line

Connecting for the first time

You can connect your HP Jornada to a desktop PC using a serial connection (with either the docking cradle—optional for the HP Jornada 710—or the serial sync cable), a USB connection (using the cradle only, USB A-to-B cable not included) or a network connection (with an optional PC Card network interface card). You can also connect to an infrared-equipped desktop or notebook PC (using the infrared port). Before you connect, you must install Microsoft ActiveSync on the desktop PC. Then, you can connect your HP Jornada and establish a partnership.

Setting up Microsoft ActiveSync and establishing a partnership

Microsoft ActiveSync enables you to synchronize the information on your desktop PC with the information on your HP Jornada. Synchronization compares the data on your device with your desktop PC and updates both computers with the most recent information. For example:

- Keep your Pocket Outlook data current by synchronizing your HP Jornada with Microsoft Outlook 2000 on your desktop PC. (Inbox synchronization with Outlook Express is not supported.)
- Synchronize Word and Excel documents, Access and other ODBC databases and tables, Mobile channels, and InkWriter documents between your HP Jornada and desktop PC. Your files are automatically converted to the correct format.

With Microsoft ActiveSync, you can:

- Back up and restore your HP Jornada data
- Add and remove programs on your HP Jornada
- Move and copy files (rather than synchronize files) between your device and your desktop PC

Microsoft ActiveSync includes several components. The Microsoft ActiveSync Setup Wizard detects which software components are needed and prompts you to set up only the necessary components. For instance:

- If you do not already have Outlook installed, the Setup Wizard will attempt to install Outlook 2000.
 - The Setup Wizard can add Inbox extensions to enable you to transfer messages to your desktop mail client—Exchange or Outlook.
-

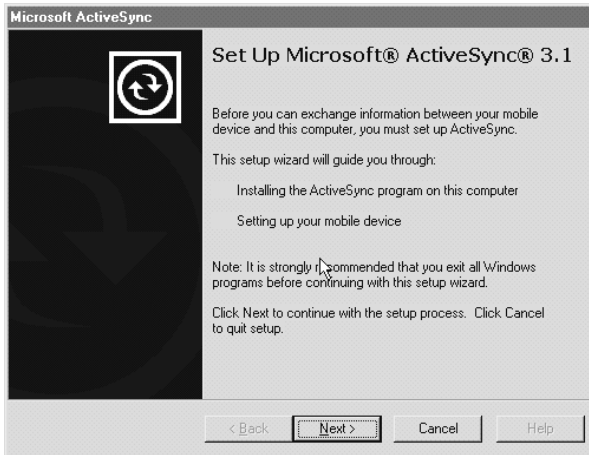

The Microsoft ActiveSync compact disc includes the following software options for your desktop PC.

- **Microsoft® ActiveSync**—Enables you to connect your HP Jornada to a desktop or notebook PC running Windows 95/98/NT/2000.
- **Microsoft® Outlook 2000**—Desktop PC software for managing your contacts, appointments, tasks, e-mail, and important documents, keeping them synchronized with your HP Jornada.
- **Microsoft® Internet Explorer** —Browse the Web with the latest version of the Microsoft browser software for your desktop PC.
- **Microsoft® Money 2000**—Synchronize the accounts on your HP Jornada with the US version of Microsoft Money 2000 on your desktop PC.

Please Note: Some software programs on the Microsoft CD-ROM are designed for Pocket PC devices, and are not compatible with your HP Jornada 700 Series Handheld PC.





There are many MS Windows for H/PC 2000 programs available, including freeware and shareware. Go to www.microsoft.com/mobile, or try searching the Web on the keyword “MS Windows for H/PC 2000” to find additional programs for your HP Jornada. Be sure to install only programs that are compiled for the StrongARM SA111X processor family.

Installing Microsoft ActiveSync

The minimum PC requirements for running Microsoft ActiveSync are as follows:

- Microsoft® Windows® 2000, Microsoft® Windows NT® Workstation 4.0 with Service Pack 3 or greater, or Microsoft® Windows 95/98..
 - Pentium processor for Windows NT (166 MHz required for Windows 2000)
—or—
486/66 DX or higher processor (Pentium® P90 recommended) for Windows 95/98.
 - 16 MB of memory for Windows 95/98 (more memory will improve performance), or 32 MB of memory for Windows NT 4.0 or Windows 2000 (64 MB recommended).
 - Hard disk drive with 10 to 50 MB of available hard disk space (actual requirements will vary, based on selection of features and current system configuration).
 - Available 9 or 25-pin communications port (adapter required for 25-pin communication port), Infrared port, or USB port (available for Windows 95/98 or Windows 2000 only).
 - CD-ROM drive.
 - VGA or higher resolution graphics card (SVGA 256-color recommended).
 - Keyboard.
 - Microsoft® Mouse or compatible pointing device.
-

Optional components:

- Audio card/speakers for sound.
- Modem and/or Ethernet LAN connection for remote synchronization.
- Microsoft Internet Explorer 4.0 or higher for Mobile Channels or Mobile Favorites support. (Internet Explorer 5.0 is included on the ActiveSync CD-ROM.)
- Additional 153 MB of disk space for Microsoft Outlook® 2000. 24MB system RAM recommended. (Microsoft Outlook 2000 is included on the ActiveSync CD-ROM.)

To install Microsoft ActiveSync

1. Insert the Microsoft ActiveSync compact disc into the CD-ROM drive on your desktop PC.
2. The Microsoft ActiveSync Setup Wizard should start automatically. If it does not start, click **Run** on the **Start** menu, and then type *d:\setup*, where *d* is the letter assigned to your CD-ROM drive.
3. Follow the instructions that appear on your screen to set up Microsoft ActiveSync.
4. After you complete the installation, the Microsoft ActiveSync **Get Connected** dialog box appears, prompting you to connect your HP Jornada.
 - If you connect via serial port using the docking cradle (optional on the HP Jornada 710) or sync cable, connect your device as described below in **Connecting by serial port**, and then click **Next**.
 - If you connect via USB port with the docking cradle, connect your device as described below in **Connecting by USB port**, and then click **Next**.
 - If you connect by infrared, click **Cancel**, and then skip to the section **Connecting by infrared**, later in this chapter.

Your HP Jornada will automatically detect the connection method (serial or USB) that you have used to connect to your desktop PC. Connect the cable type of your choice according to the instructions below, click **Next**, and ActiveSync will prompt you to complete the New Partnership Wizard.



Connecting by serial port

The HP Jornada uses a serial port to communicate with a desktop PC. Use the serial sync cable that was included with your HP Jornada to connect either the device or the cradle (optional on the HP Jornada 710) to a 9-pin serial communications port on your desktop PC. If the 9-pin serial port on your PC is in use by another device, or if your computer has no 9-pin serial port, you can obtain an adapter from your computer's manufacturer.



Turn on your desktop PC before connecting the sync cable or placing your HP Jornada in the docking cradle (optional on the HP Jornada 710). If the desktop PC is off, your HP Jornada or desktop PC may freeze on startup, forcing you to reset or restart. For information on resetting your HP Jornada, see **Resetting** in chapter 8.

To connect directly (without the docking cradle)

1. If it is attached, disconnect the telephone cable from your HP Jornada.
2. Connect the ac adapter to the dc jack on the right side of the HP Jornada, and then plug in the power cable.
3. Insert the 9-pin end of the serial sync cable into a serial port on your desktop PC.
4. Fully insert the flat end of the serial sync cable, arrow side up, into the serial port on your HP Jornada.

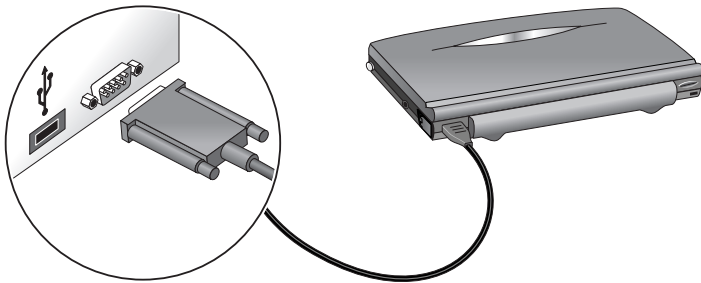

HP Jornada serial port connection

To connect via serial port using the docking cradle (optional on the HP Jornada 710)

1. Connect the **9-pin end** of the sync cable to a serial port on your desktop PC.
2. Slide the port cover on the back of the docking cradle to the right to expose the **Serial** port.
3. Fully insert the **flat end** of the sync cable, **arrow side up**, into the serial port on the back of the docking cradle.
4. **Turn off** your HP Jornada and **disconnect** any cables (telephone cable, ac adapter, sync cable, etc.) from your HP Jornada.
5. Connect the ac adapter to the dc jack on the back of the docking cradle, and then plug in the power cord.

Do not connect your HP Jornada to more than one source of ac power. You must disconnect the ac adapter from your HP Jornada before placing it in the docking cradle to avoid damaging your HP Jornada.



6. Align your HP Jornada in the docking cradle, and push down firmly until the HP Jornada snaps into place.

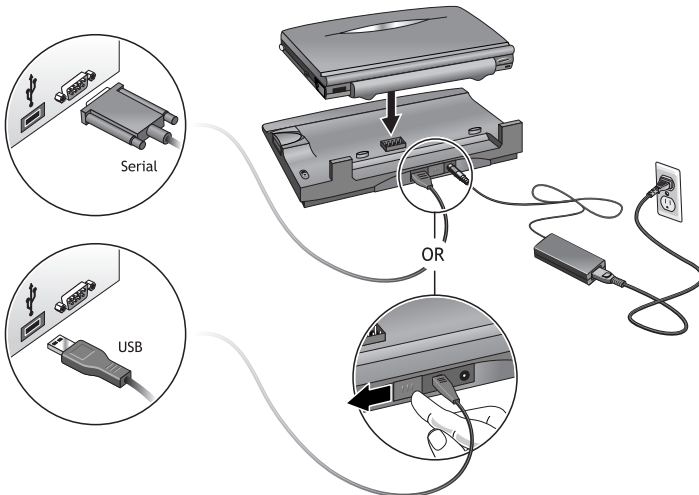

HP Jornada shown with docking cradle, ac adapter, and serial/USB methods of connection to a desktop PC

Connecting by USB port

Using the cradle (optional on the HP Jornada 710) you can also make a USB connection to your desktop PC. A standard USB A-to-B cable (not included) is required in order to make a USB connection.

To connect via USB port using the docking cradle

1. Connect the flat USB "A" connector to an available USB port on your desktop PC (cable not included).
2. Slide the port cover on the back of the docking cradle to the left to expose the USB port.
3. Insert the square USB "B" connector into the USB port on the back of the docking cradle
4. **Turn off** your HP Jornada and **disconnect** any cables (telephone cable, ac adapter, sync cable, etc.) from your HP Jornada.
5. Connect the ac adapter to the dc jack on the back of the docking cradle, and then plug in the power cord.
6. Align your HP Jornada in the docking cradle, and push down firmly until the HP Jornada snaps into place.

Your HP Jornada should start automatically and establish a connection to the desktop computer. To remove your HP Jornada from the docking cradle, push the release button on the cradle, and carefully lift your HP Jornada from the cradle.

If you are traveling without your docking cradle or you need to synchronize files with your home computer while the docking cradle is connected to your office PC, you can connect your HP Jornada directly to a desktop PC using only the serial sync cable. (See **Connecting by serial port** earlier in this chapter.)



You can also connect and synchronize by infrared. For more information, see the **Connecting by infrared** section in this chapter.

Establishing a partnership

After you set up Microsoft ActiveSync on your desktop PC, you are prompted to establish a partnership between your desktop PC

and your HP Jornada. The partnership enables your desktop PC to recognize your HP Jornada when transferring files or synchronizing data.

You can establish partnerships between your HP Jornada and up to two desktop PCs; for example, your home PC and your office PC. If you regularly synchronize your HP Jornada with both desktop PCs, you can ensure that important files, contacts, and calendar information are always up-to-date and identical on both desktop PCs, as well as on your HP Jornada.

Although you can establish partnerships with two desktop PCs, you can synchronize e-mail messages with only one desktop PC.



A single desktop PC can partner with many H/PCs or palmtop PCs. This is useful if you have more than one MS Windows for H/PC 2000 device, or if several mobile professionals share a single desktop PC.

The New Partnership Wizard

The first time you connect, the New Partnership Wizard on your desktop PC helps you establish a partnership and set options for synchronizing Pocket Outlook data, e-mail messages, and files between your HP Jornada and desktop PC.

To establish a partnership

1. When the **New Partnership** dialog box appears on your desktop PC screen, click **Yes** to synchronize, and then follow the instructions to complete the New Partnership Wizard.
 2. At the prompt, type a name and description for your HP Jornada. The name must start with a letter, and it can be anything you choose (up to 15 characters, no spaces).
 3. Select whether you want your HP Jornada to synchronize through a single partnership or multiple partnerships desktop PCs, by selecting the appropriate button.
 4. Select the personal information manager (PIM) application you plan to use from the list boxes.
 5. Set options for synchronization, indicating the types of files and information you want to synchronize.
-



If you choose to establish partnerships with more than one desktop PC, the desktop PCs must be configured with the same synchronization settings. In addition, each desktop PC must use the same PIM program (for example, Microsoft Outlook).



Regardless of the options you choose while completing the wizard, you can also synchronize at any moment by choosing the **Synchronize Now** command from the **File** menu of the ActiveSync window. For more information, see the **Synchronizing data** section in this chapter.



Troubleshooting partnerships

Your HP Jornada is designed to automatically detect the connection type and configure itself to communicate with you desktop PC. However, if you are unable to establish a connection between your HP Jornada and your desktop PC, double-tap the connection icon in the status area of the taskbar on your HP Jornada. The **Connection Status** dialog box may provide information about the problem.

Connection Methods

Each of these connection methods works with the HP Jornada H/PC; however, USB and infrared connectivity are not supported by Windows NT. A serial sync cable and cradle (optional on the HP Jornada 710) with serial/USB capability are included with your Jornada. Additional cables and cradles are available as optional accessories.

Connection method	Desktop PC operating system			
	Windows 95	Windows 98	Windows 2000	Windows NT
USB	No	Yes	Yes	No
Serial	Yes	Yes	Yes	Yes
Infrared	Yes	Yes	Yes	No

Checking connection methods on your H/PC and desktop PC

One possible source of trouble with making connections may be incompatible connection settings on either your HP Jornada or your desktop PC.

To check and set the desired connection method on your HP Jornada

1. From the Start menu, tap Settings, tap Control Panel, then double-tap **Communications**.
2. On the **PC Connection** tab, under **Connect using** make sure that the connection method you wish to use is displayed. If the correct connection method is not displayed, tap **Change**.

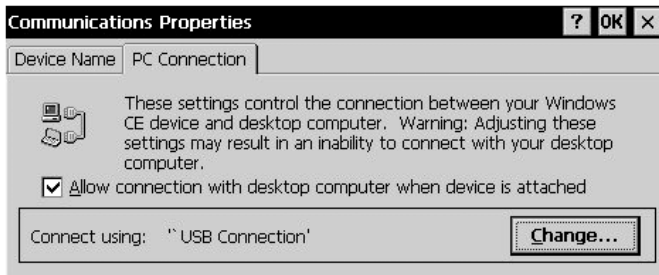

3. In the Change Connection dialog box, choose the desired connection method from the drop-down list.

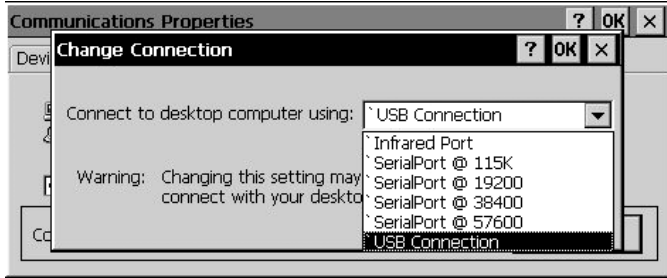

4. Tap OK twice to save your settings and exit.



To check the connection settings in ActiveSync on your desktop Computer

1. Depending upon your connection method, verify that the sync cable from your docking cradle (optional on the HP Jornada 710) or HP Jornada is connected to the listed serial port in the **Connection Settings** dialog box, or that **Allow USB Connection with this desktop computer** is selected.
 2. If you are connecting via infrared, be sure that **Allow serial or infrared connection to this COM port is selected** and that the correct IrDA COM port is displayed.
 3. If you continue to have difficulty synchronizing, in the Connection Settings dialog of the Microsoft ActiveSync window, clear the Allow check box for the type of connection you are using, and then click OK.
 4. After the connection is disabled, re-select the appropriate Allow check box and click OK to enable the connection again.
-

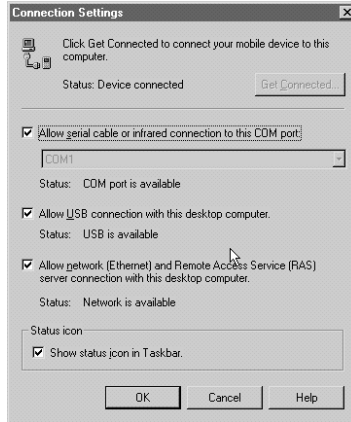

If these steps fail to correct the problem, use the ActiveSync Troubleshooter. The ActiveSync Troubleshooter provides detailed diagnostic steps to identify and correct common problems.

To start the ActiveSync Troubleshooter

1. On the desktop PC **Start** menu, point to **Programs**, click on **Microsoft ActiveSync**, and then choose **Connection Settings** from the **File** menu.
2. In the **Connection Settings** window, click **Help** to open the **ActiveSync Troubleshooter**.

Connecting to your desktop PC

After you have established a partnership, you have several options for connecting your device to your desktop PC in the future. You can set Microsoft ActiveSync to automatically detect your HP Jornada and establish a connection whenever you connect a sync cable. Using the COM port on your desktop PC is the easiest way for you to connect, unless the port is in use for other peripherals.

To enable automatic connection

1. On the desktop PC **Start** menu, point to **Programs** and click on **Microsoft ActiveSync**.
2. On the **Tools** menu in the Microsoft ActiveSync window, click **Options**.

3. On the Sync Mode tab, select either the "Continuously while the device is connected" or the "Only on connection" check box to activate automatic connection.

If you use the COM port of your desktop PC for other devices, or if you have disconnected your HP Jornada and need to re-establish the connection, you can establish a manual connection using the PC Link program on your HP Jornada.



To connect manually

1. On the HP Jornada **Start** menu, point to **Programs**, point to **Communications**, and then tap **PC Link**.
2. The **Connection Status** dialog box appears.
3. After a few moments a sound indicates that the connection has been established.

To close the connection

1. On your HP Jornada, double-tap the connection icon in the status area of the task bar.
2. In the Connection Status dialog box, tap **Disconnect**.

Connecting by infrared

The infrared port on your HP Jornada provides a convenient way to connect to an IrDA-equipped PC without using a cable or cradle (optional on the HP Jornada 710). Many notebook computers have built-in infrared ports; however, you may need to install and configure an infrared port on a desktop PC. To install the port, follow the manufacturer's instructions. More information about infrared drivers for Windows 95/98 or Windows 2000 is available on the MS Windows for H/PC 2000 Web site at www.microsoft.com/mobile. (Infrared connection is not available for Windows NT.)

Once connected, you can transfer files and synchronize Pocket Outlook data and e-mail messages just as if you had connected using a sync cable or a docking cradle.

To configure Microsoft ActiveSync for infrared connection

1. Open the ActiveSync window.
2. Choose **Connection Settings** from the **File** menu.
3. Click on **Allow serial cable or infrared connection to this COM port**.

To configure your HP Jornada for infrared connection

1. On your HP Jornada **Start** menu, point to **Settings**, tap **Control Panel**, and then double-tap the Communications icon.
2. On the **PC Connection** tab, if it does not say **Connect using Infrared Port**, tap **Change**, and then select **Infrared Port** from the list of available connections.

To establish an infrared connection

1. Line up the infrared port on your HP Jornada with the infrared device on your notebook or desktop PC.
2. On your HP Jornada **Start** menu, point to **Programs**, point to **Communications**, and then tap **PC Link**.

Connecting to another PC

In some cases, you may need to connect your HP Jornada to a desktop PC other than your partner. Or, if you have logged on to your desktop PC under a different user name or performed a factory default reset of your H/PC, your desktop PC will not recognize your HP Jornada as its partner.

In these cases, when you connect your HP Jornada to the desktop PC, the **New Mobile Device Detected** dialog box appears, offering you the option to synchronize, browse, or to restore data from an existing backup file.

If you choose **Synchronize**, the New Partnership Wizard will begin, and your HP Jornada will be designated as a partner of

the desktop PC. Contacts, Calendar, and Task information and information from any other services you choose to synchronize will be copied from the desktop PC to your HP Jornada.

If you choose **Browse**, your HP Jornada will be connected as a guest. As a guest, you can view files and folders on the HP Jornada, transfer files and folders, and manually back up or restore; however, you cannot synchronize data or automatically back up and restore data.

If you choose **Restore**, you are given the option to restore data from an existing backup file on the desktop PC. Restoring data in this way will replace all existing data on the HP Jornada with the data in the backup file on your PC.



If you have lost your HP Jornada or replaced it with another HP Jornada, you can use the Restore function to set up a new device with the exact same data and settings as the old one, provided you had previously performed a full backup to the desktop PC. When you connect the new device to your desktop PC for the first time, choose **Restore** rather than **Synchronize** or **Browse**. For more information, see the **Backing up and restoring data** section in chapter 5.

Browsing your HP Jornada desktop

While your HP Jornada is connected to a desktop PC, you can use Microsoft ActiveSync to browse the contents of your HP Jornada from your desktop. The ActiveSync window has an **Explore icon** on the toolbar. When you click the Explore icon, the contents of your HP Jornada are displayed just like any other folder on your desktop PC. You can cut, paste, and copy files between folders on your HP Jornada or transfer files between your HP Jornada and your desktop PC simply by dragging the file icons between the appropriate folders.



For more information about transferring files, including details on converting file types between Pocket Office and Office 2000 programs, see the **Transferring files** section later in this chapter.

You cannot open files or start programs stored on your HP Jornada by double-clicking their icons in the Mobile Device window on your desktop PC. When you double-click the icon for a file or program that is stored on your HP Jornada, Microsoft

ActiveSync displays the properties for that file or program, as if you had clicked **Properties** on the **File** menu.

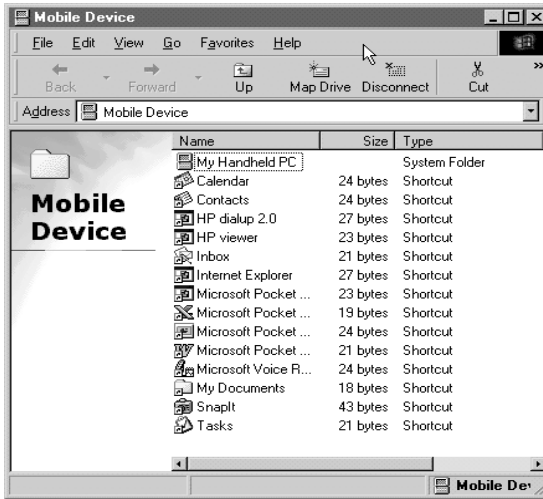

The Mobile Device window on your desktop PC displays the contents of your HP Jornada.

Synchronizing data

Microsoft ActiveSync enables you to synchronize data between your HP Jornada and desktop PC, so the names you add to your Contacts database and the appointments you add to your Calendar while traveling can be automatically updated on your desktop PC when you return. You can also synchronize messages in your HP Jornada Inbox with Microsoft Outlook or Microsoft Exchange on your desktop PC. And, you can synchronize files in the Synchronized Files folder on your HP Jornada. with files in a Synchronized Files folder inside your My Documents folder (Windows 95/98) or Personal folder (Windows NT and Windows 2000) on your desktop PC.

You can set ActiveSync either to synchronize automatically each time you connect your HP Jornada to your desktop PC or to synchronize continuously whenever the synchronized information changes, for as long as the computers are

connected. You can also synchronize at any moment by choosing clicking on the **Synchronize button** on the toolbar in the ActiveSync window.



Do not remove your HP Jornada from the docking cradle, disconnect the sync cable, or turn off your HP Jornada while synchronization is in progress.

Synchronizing selected data

You can synchronize some or all of the following items:

- **Pocket Outlook data**—Synchronize the Calendar, Contacts, or Tasks information on your HP Jornada with information stored in Outlook 2000 on your desktop PC.
- **E-mail messages**—Share messages between selected folders in your HP Jornada Inbox and Microsoft Exchange or Outlook 2000 on your desktop PC. For more information, see the **Synchronizing e-mail messages** section in this chapter.
- **Files**—Synchronize the contents of the Synchronized Files folder (inside My Documents) on your HP Jornada with files stored in your My Documents folder (Windows 95/98) or in your Personal folder (Windows NT) on your desktop PC.

To specify data to synchronize

1. On your desktop PC, open the **ActiveSync** window.
 2. On the **Tools** menu, click **Options**.
 3. On the **Sync Options** tab of the ActiveSync **Options** dialog box, select the check boxes beside the services you want to synchronize.
 4. To set specific options (for example, to indicate how many weeks of Calendar data to synchronize or to synchronize only active tasks), select the appropriate service, and then click **Settings**.
-



Reducing the amount of data to synchronize, for example, by synchronizing only 1 or 2 weeks of Calendar data, can significantly speed up the synchronization process. If you use Microsoft Outlook, Microsoft ActiveSync synchronizes only 2 weeks of calendar data by default.

Resolving synchronization conflicts

If the same item (for example, an appointment or a task) has been modified on both the desktop PC and on the HP Jornada, ActiveSync will indicate that a Synchronization conflict has occurred. When the **Resolve Conflicts** dialog box appears, you can either resolve the conflict by selecting one of the items to replace or you can ignore the conflict, leaving the data on both computers unchanged.

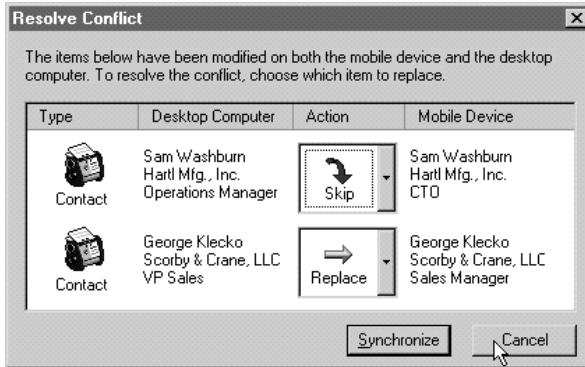

You can resolve each conflict manually, at the time of synchronization, or you can resolve conflicts automatically by setting a default option for conflict resolution.

To set a default option for conflict resolution

1. Open the Microsoft ActiveSync window.
2. On the **Tools** menu, click **Options**.
3. Click on the **Rules** tab of the **Options** dialog box.
4. Under **Conflict Resolution**, select the option you prefer to resolve conflicts.

Synchronizing e-mail messages

You can synchronize your HP Jornada Inbox with the e-mail program (Microsoft Outlook or Exchange) on your desktop PC partner. By synchronizing, you can take important messages with you when you travel, or you can use your desktop PC to send messages that you create on your HP Jornada.

When you synchronize:

- Messages are copied from the Inbox folder on your desktop computer to the Inbox folder on your HP Jornada (by default, only the messages received in the past 3 days are synchronized, and no attachments are copied).
- Messages on the two computers are linked. So, for instance, if you delete a message on your HP Jornada, it will also be deleted on your desktop PC the next time you synchronize.
- Messages in the Outbox folder on your HP Jornada are transferred to the Outbox on your desktop PC and then sent from that program.

Synchronizing from a remote location

The ActiveSync program on your HP Jornada enables you to synchronize files, e-mail messages, and Pocket Outlook data with your desktop PC, even when you are away from the office. You can do this by remote dial-up connection or LAN connection to your desktop PC. You can also connect to a computer not on a network (such as your home computer) and synchronize using a modem.



You can quickly and easily make connections to the Internet or a corporate network from remote locations using HP dialup. For more information on using HP dialup see *Creating Connections* in Chapter 6.

Before you can synchronize remotely, the desktop PC or network server must be configured for Remote Access Services (Windows NT) or Dial-Up Networking (Windows 95/98), and you must create a connection on your HP Jornada by using either the HP Jornada dialup application or the Remote Networking program. For information about setting up connections with **HP dialup**, see the **Setting up a remote connection to your network** section in chapter 6. For Remote Networking information, see the **Accessing a computer not on a network** section in this chapter. After you have set up for either type of connection, you can synchronize data. See the **To start remote synchronization** procedure later in this chapter.

Accessing a computer on your corporate network

To access a PC on your corporate network from a remote location, you must have an account provided by your network administrator, and you must set up a connection to your network server using **HP dialup** (see chapter 6). In addition, you must set up the target PC to receive your calls as follows.

- The target PC must be turned on.
- Microsoft ActiveSync must be set up on the target PC. (See the **Installing Microsoft ActiveSync** section earlier in this chapter.) Also, the synchronize setting on the **Sync Mode** tab under ActiveSync **Options** should be set to one of the **automatic** options.
- Microsoft ActiveSync must be running, and the **Waiting for mobile device to connect** status message must be shown in the ActiveSync window.
- In the Microsoft ActiveSync **Connection Settings** dialog box, the **Allow network (Ethernet) and Remote Access Service (RAS) server connection with this desktop computer** checkbox must be selected.
- Any folders or drives you want to access must be shared.

If you will be dialing in to a desktop PC running Windows 95, you must also have Dial-up Networking components set up on the target desktop PC.



Accessing a computer not on a network

If you want to dial in to a computer that is not on a network (such as your home PC with Windows 95/98), you must set up the target PC to receive your calls as follows.

- The target desktop PC must be turned on.
 - The target desktop PC must have a modem installed and configured and must be set to receive incoming calls. (Refer to the instructions from the manufacturer of your desktop PC modem.)
 - Dial-up Networking (Windows 95/98) or Remote Access Service (Windows NT) must be set up and configured so that your target PC can act as a server. (See your Windows documentation for further instructions.)
-

- Microsoft ActiveSync must be set up on the target PC (for instructions, see the **Installing Microsoft ActiveSync** section in this chapter). The synchronize setting on the **Sync Mode** tab under ActiveSync **Options** should be set to one of the **automatic** options.
- Microsoft ActiveSync must be running, and the **Waiting for mobile device to connect** status message should appear in the ActiveSync window.
- In the **Microsoft ActiveSync Connection Settings** dialog box, the **Allow network (Ethernet) and Remote Access Service (RAS) server connection with this desktop computer** checkbox must be enabled.
- Any folders or drives you want to access must be shared.

You need the following information to establish a Remote Networking connection:

- Your Windows user name and password, if you are required to log on to your computer
- Telephone number of the modem

To create a connection to a computer not on a network (such as a home computer), you will need to create a new connection using Remote Networking on your HP Jornada.



To create a Remote Networking connection

1. On the **Start** menu, point to **Programs**, point to **Communication**, and then tap **Remote Networking**.
2. In the Remote Networking folder, double-tap **Make New Connection**.
3. In the **Make New Connection** dialog box, tap **Dial-up**, and then tap **Next**.
4. If your HP Jornada is equipped with a built-in modem, select **Built-In Modem** from the list of modems. If you use a PC Card modem*, select the appropriate option for the PC card modem you have installed

* Modem purchased separately. Some Web sites/content may not be available.

5. Tap **TCP/IP Settings**, and then tap the **General** tab. Make sure the **Use Server-assigned IP Address** check box is selected.
6. On the **Name Servers** tab, tap **Server-assigned addresses**, and then tap **OK**.
7. Tap **Next**, and then fill in the telephone number you wish to dial. Tap **Finish**. A new icon appears, labeled with the name you chose, in your Remote Networking folder. This connection will also appear in your remote synchronization dialog box.

To set a dialing location for a Remote Networking connection, double-tap the icon for the connection in the Remote Networking folder. In the **Dial-up Connection** dialog box, tap **Dial Properties**, and then fill in the information as you would for a network or ISP connection using the HP Jornada dialup application.



To start remote synchronization



1. On your HP Jornada **Start** menu, point to **Programs**, point to **Communication**, and then tap **ActiveSync**.
 2. If you are connecting using a modem or dial-up connection, select the connection you will use from the list. All connections you have created either with the HP Jornada dialup application or Remote Networking will appear in this list.
–or–
If you are connecting over a network, tap **Network Connection**.
 3. In the **Connect to** list, select the name of the desktop PC to which you will connect. The **Connect to** list displays only the PCs with which you have already established a partnership.
 4. In the **User Logon** dialog box, type your user name, password, and domain if necessary, and then tap **Connect**.
-

Transferring files

You can copy files between your HP Jornada and desktop PC by dragging icons to or from the folders in the Mobile Device Explorer window, or by using the **Cut**, **Copy**, and **Paste** commands on the **Edit** menu.

Some files may need to be converted before you can use them on your HP Jornada. By default, Microsoft ActiveSync automatically converts files to the appropriate file type. However, you can choose not to convert files, or you can specify the conversions for each file type by changing options in the **File Conversion Properties** dialog box.

To set file conversion options

1. Open the **ActiveSync** window.
2. On the **Tools** menu, click **Options**, click the **Rules** tab, and then click **Conversion Settings**.
3. Click either the **Device to Desktop** or **Desktop to Device** tab.
4. Select the file type, and then click **Edit** to change conversion options. In most cases, you will be offered a single conversion option or no conversion at all.

When Microsoft Office files are converted to their corresponding Pocket Office formats, the Pocket Office files are compressed, so they require much less storage memory than they do on your desktop PC. During conversion, certain formatting or attributes may also be removed from the Pocket Office version; however, all formatting should be restored when the file is returned to the desktop PC. For specific details, see the sections on Microsoft Office programs in chapter 5 or refer to online Help for that program on your HP Jornada. Only Microsoft PowerPoint® 97 and 2000 files can be converted to Pocket PowerPoint.

4 | Staying organized

With your Hewlett Packard Jornada Handheld PC (H/PC), you can keep in touch with your office, home, and clients through e-mail and the Internet. You can connect in many ways using your HP Jornada and various accessories. This chapter will guide you through the options best suited to your needs.

Pocket Outlook also lets you set alarms and reminders so that you never forget an appointment or meeting. And, if you want a personal reminder, you can record voice memos to yourself with Microsoft Voice Recorder.

In this chapter you will find program information and basic procedures for:

- Pocket Outlook
- HP viewer
- HP quick pad
- Voice Recorder

For more information on these and other programs that come with your HP Jornada, see online Help.

Using Microsoft Pocket Outlook

Your HP Jornada comes with Microsoft Pocket Outlook, which includes Calendar, Contacts, Tasks, and Inbox. Using Microsoft ActiveSync, you can synchronize information on your HP Jornada with information in Microsoft Outlook or Microsoft Exchange on your desktop computer. Each time you synchronize, Microsoft ActiveSync compares the changes you made to data on your device and desktop PC and updates both computers.

With Inbox, you can send and receive e-mail messages, either by synchronizing with the mail program on your desktop PC (either Outlook or Exchange) or by connecting directly to your mail server through an Internet or network account.

To start Pocket Outlook

- On the **Start** menu, point to **Programs**, point to **Pocket Outlook**, and tap either **Calendar**, **Contacts**, **Inbox**, or **Tasks**.

–or–

Press one of the Calendar, Contacts, Inbox, or Tasks hot keys.



To switch quickly from one Pocket Outlook applications to another, tap the **Go** menu on the toolbar of the current Pocket Outlook application.

Keeping appointments with Calendar

Use Calendar to schedule appointments, meetings, and other events. Quickly check your appointments in one of several views (Day, Week, Month, Year, and Agenda).



To create a new appointment

1. On the **Start** menu, point to **Programs**, point to **Pocket Outlook**, and tap **Calendar**.

–or–

Tap the Calendar hot key.

2. On the **File** menu, tap **New Appointment**.
3. Type a description and the location of your appointment.
4. Select the time and date of your appointment.
5. To add notes, tap the Notes button, and then tap once in the notes area. Type your notes.
6. To assign the appointment to a category, tap the Categories button, and then select a category from the list.
7. Select other desired options, and when you are finished tap **OK**.

If you need to schedule a meeting with other people who use Outlook or Pocket Outlook, you can use Calendar to schedule the meeting. When attendees receive a meeting request, they can

choose to accept or decline the meeting. If they accept, the meeting is automatically placed in their schedule. In addition, their response is automatically sent back to you, and your calendar is updated.

Before you can send a meeting request, you must enter e-mail addresses in Contacts and set up Inbox to send and receive messages (see the Using Inbox section in chapter 6).

To create a meeting request



1. On the **Start** menu, point to **Programs**, point to **Pocket Outlook**, and then tap **Calendar**.

–or–

Tap the Calendar hot key.

2. On the **Tools** menu, tap **Options**, and then choose a mail transport:
 - If you send and receive messages using synchronization, select **ActiveSync**.
 - If you connect to an ISP or network, select the service you set up in Inbox or the HP Jornada dialup application.
3. Tap **OK**.
4. On the **File** menu, tap **Make Meeting**.
5. Enter the meeting information.
6. Select the contacts you want to invite.

Select other desired options, and then tap **OK**.

Inbox automatically creates a meeting request and sends it to the attendees the next time you connect to your mail server or synchronize with your desktop PC.

Your HP Jornada will remind you about your appointments and meetings by playing a sound, flashing the notification light, and/or displaying a message on the screen. To choose the way you prefer to be notified, open the appointment or meeting, tap , and then tap **Reminder Options**. You can silence an alarm without even opening your HP Jornada by pressing the blinking alarm-notification LED on the cover.



Managing names and addresses with Contacts

The Contacts program maintains a list of your friends and colleagues so that you can easily find the information you are looking for, whether you are at home or on the road. Using the infrared port, you can also quickly share Contacts information with other MS Windows for H/PC 2000–based mobile device users.



To create a new contact

1. On the **Start** menu, point to **Programs**, point to **Pocket Outlook**, and tap **Contacts**.
–or–
Tap the Contacts hot key.
2. On the **File** menu, tap **New Contact**.
3. Type a name.
4. Tap **Business** or **Personal** and type information in the appropriate fields. Supply an e-mail address to send meeting requests and e-mail messages to this contact.
5. To add a note or assign the contact to a category, tap **Notes/Categories**. Then, select the notes area and enter your notes, or select a category from the list.
6. When you are finished, tap **OK**.



You can send groups of contacts to another IrDA-equipped H/PC 2000–based device. To do this, line up the infrared ports on the two devices so that they are within 1 meter (3 feet) of one another. On the Contacts list, select the item(s) you want to send, and then on the **File** menu, tap **Send**. If you are receiving items, tap **Receive**. Category information and notes are not transmitted with the contact.

Keeping track of your workload with Tasks

The Tasks program helps you keep track of what you need to do. Enter the details for a task on the task card, and

then assign a category. You can even associate a date with the task and then set a reminder for yourself.

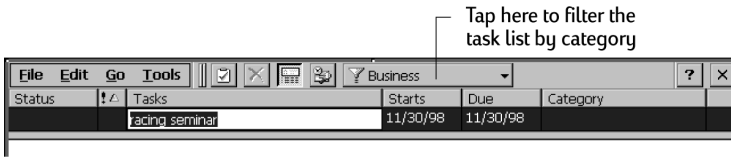

You can sort the list on any column by tapping the column heading (the column used for sorting the list displays a triangle in the heading). If you sort by status, active tasks are listed before completed tasks. Or, you can filter your list to show only a specific status of a task or tasks belonging to a specific category. When your list is filtered, the filter button is selected. Overdue tasks are displayed in red, bold text.

To create a new task



1. On the **Start** menu, point to **Programs**, point to **Pocket Outlook**, and tap **Tasks**.
—or—
Tap the Tasks hot key.
2. On the **File** menu, tap **New Task**.
3. Type a description of the task.
4. Select the start date, due date, and other information.
5. To add a note to a task, tap the Notes button, and then tap once in the note-taking area. Type your note, and then tap **OK**.
6. When you are finished, tap **OK**.

Managing your e-mail with Inbox

Use Inbox to send and receive e-mail messages. You can access your e-mail by synchronizing with your desktop PC or by connecting to a mail server through an Internet or network account. (For more information, see the **Using Inbox** section in chapter 6 and the **Synchronizing e-mail messages** section in chapter 3.)

Using HP viewer

HP viewer gives you a quick and versatile way to view the information in your Pocket Outlook Calendar, Contacts, and Tasks databases. HP viewer displays the information you choose in as much detail as you want, including detailed contact information, tasks and notes on a single screen, or all the appointments and tasks scheduled for a single day, a week, or up to 6 months at a time. HP viewer also enables you to view a single field for any record or to switch instantly to Pocket Outlook for editing.

By default, the HP viewer icon is displayed on the MS Windows for H/PC 2000 desktop.



To start HP viewer

- On the **Start** menu, point to **Programs**, point to **HP Applications**, and then tap **HP viewer**.

–or–

Press the HP viewer hot key.

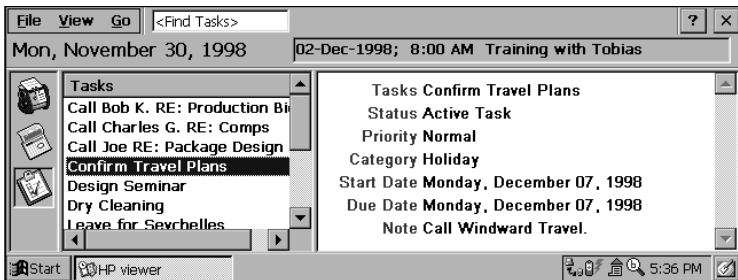

HP viewer shows your Pocket Outlook information quickly.



HP viewer uses the same font settings as Internet Explorer. Changing the font or font size in Internet Explorer will also change the way information is displayed in HP viewer.

You can quickly switch from HP viewer to Pocket Outlook to look at the selected date in all Calendar views.

To switch to Pocket Outlook

- On the **Go** menu, tap the appropriate program or view.

HP viewer displays the current date and your next scheduled appointment below the toolbar in the Today Banner of the HP viewer window. To quickly view detailed information about the appointment, tap the appointment title in the Today Banner.

To switch between Calendar, Contacts, and Task information

- Tap the appropriate icon on the left side of the HP viewer window.

Viewing Calendar information

HP viewer lets you view your calendar in Day, Week, Month, or n-Month view.

- Tap the Calendar icon on the left side of the HP viewer window to display Calendar information.
- Tap a View button on the toolbar to change views.
- Tap the Go to Date button on the toolbar to view information for a specific date.



n-month (displays up to 6 months)



Month



Week



Day



Today (GoTo Today command)







Date (GoTo Date command)

Day View offers a fast way to browse your schedule for the current day or up to 7 days that you select.

To enable Day Zoom in n-Month View, Month View, or Week View, press the spacebar to display appointments and tasks for the selected date(s). Tap an icon next to an appointment or event to expand a note or to display more information about that appointment or event.



You can set HP viewer to always display Day Zoom for the date you select by tapping  on the toolbar.

Week View enables you to display 1, 2, or 3 weeks of your calendar at a time. Press  as you tap  or  on the scroll bar to increase or decrease the number of weeks displayed. Tap an event to display detailed information about that event.

Use Month View to display 5 weeks of data on a single screen, or use n-Month View to display calendars for up to 6 months at a time. Tap a day to display detailed information about appointments or events scheduled on that day.



To show six months in n-month view, set the Task bar to **auto-hide**. Tap **Start**, **Settings**, then tap **Task Bar** to access the Task Bar settings dialog.

Viewing Contacts information

HP viewer lets you view all information for a particular contact on a single screen.

- Type in the **Find File As** box to display only contacts matching the letter(s) you type.
- Tap a tab on the left side of the contact list to jump to contacts that begin with a letter on the tab. To jump to contacts that begin with the second letter on the tab, tap the tab again.
- To change the field on which the contact list is sorted, tap the field name at the top of the list, and then choose a field from the **Select Primary Key** dialog box.

Viewing Tasks information

You can also use HP viewer to view task information for any field, including Notes.

- Type in the **Find Task** box to display only tasks that match the letter(s) you type.

Capturing data with HP quick pad

Use HP quick pad to enter all the notes and information you acquire during your day. Quickly record names, telephone numbers, and quick notes to yourself. You can save this information in HP quick pad or create appointments, tasks, e-mail messages, and even Pocket Word documents from a single application.

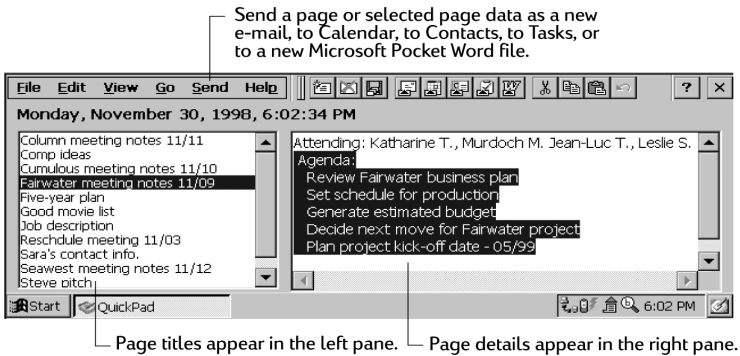

With quick pad, you can check the date and time at a glance, review your current appointments and tasks, and quickly find a telephone number or address from your contact list.

Quickly jot notes and reminders or new contact information on the notepad. Then, save your notes in quick pad or send them to the appropriate database, such as your Contacts or Tasks list.

To start HP quick pad

- On the **Start** menu, point to **Programs**, point to **HP Applications**, and tap **HP quick pad**.

–or–

Press the HP quick pad hot key.



To save information in HP quick pad

- On the **File** menu, tap **New Page** to create a blank notepad page.
- Tap once in the notepad area, and then type the information you want to save.
- On the **File** menu, tap **Rename Page**, and then type a descriptive name for the information.
- On the **File** menu, tap **Save**.

You can create as many pages as you like. Retrieve information by selecting the page title from the drop-down list, or by tapping **Find in Page** on the **Edit** menu, and then typing a word or words to search for.

To organize information for use in other programs

1. In HP quick pad, open the page containing the information, and select the text you want to export.
2. On the **Send** menu, select the program in which you want to use the information:
 - Tap **As E-mail Message** to create an e-mail message containing the selected text.
 - Tap **To Calendar**, **To Contacts**, or **To Tasks** to create an entry in one of the Pocket Outlook databases.
 - Tap **As New Pocket Word Document** to create a Pocket Word document containing the selected text.
3. In the dialog box that appears, add any necessary information (for example, the start or end date of a task or appointment, or addressees for an e-mail message), and then tap **OK**.

Infrared send/receive of PIM data

HP info exchange allows you to send and receive Contacts, Calendar and Task items between your HP Jornada and other IrDA-equipped, non-Windows powered PDA devices (i.e., Palm devices). You can also receive (but not send)

memos from some PDA devices and store them as a text file in the "My Documents" folder of your HP Jornada.

Using HP info exchange with non-Windows powered PDA devices

HP info exchange allows you to send and receive PIM data to and from non-Windows powered PDA devices from within Pocket Outlook Calendar, Contacts and Tasks. *(HP info exchange is not available in Pocket Outlook Inbox.)*

HP info exchange runs only on your HP Jornada – no additional software is required for IrDA equipped PDA devices.



Sending data to a non-Windows PDA device

To send PIM information from your HP Jornada to a non-Windows PDA device:



1. Highlight items to send in your PIM application.
 2. Make sure the PDA device is powered on. Align the IR windows of the two devices so that they are aimed directly at each other.
 3. Select **Send(non-Windows)** from the Tools menu of a PIM application on your HP Jornada. The **HP info exchange Send** window will appear indicating that it is looking for a receiving device.
 4. The PDA device will receive the transmitted items automatically.
-

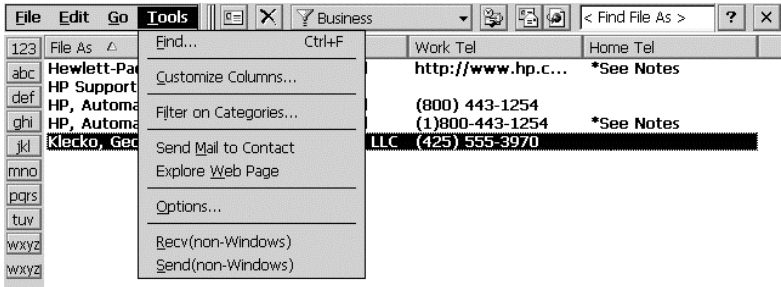

HP info exchange menu items in Pocket Outlook Contacts

Receiving data from a non-Windows PDA device



To receive PIM information on your HP Jornada from a non-Windows PDA device:

1. Set the PDA device to beam selected item(s).
2. Align the PDA device IR window so that it is aimed directly at the IR window on the rear of your HP Jornada.
3. Select **Recv(non-Windows)** from the Tools menu of a PIM application on your HP Jornada. The **HP info exchange Receive** window will appear indicating that it is looking for a sending device.

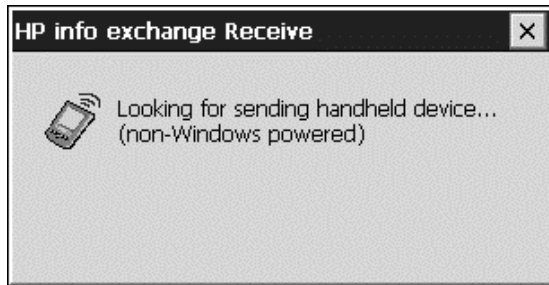

4. The PIM item(s) sent by the PDA device will be received and automatically placed in the appropriate location.
 5. Messages will be displayed confirming the number and type of items transferred.
-

About the data being transferred

HP info exchange makes it easy to send and receive essential information to or from non-Windows PDA devices. The important data fields of your HP Jornada PIM applications are mapped to the data fields on the PDA device to allow capture of important PIM information. Supported field mappings include:

- Supports sending and receiving multiple contacts, appointments and tasks.
- A number of Pocket Outlook fields are not used (e.g. Children, Spouse) since they are not used by non-Windows PDA devices, or are not supported by the VCard standard.
- Multiple entries of important field types will be placed in the Notes section.
- For standard Contact fields multi-line text is converted into a single line with spaces for line breaks
- Supports a 'Business Card' beamed over from a Palm device and treats it as another contact.

For more information about field mappings and data exchange, see HP info exchange online help.

Recording and playing voice memos

You can use Microsoft Voice Recorder to quickly capture thoughts, reminders, and ideas. Since your recordings are captured in the compatible Wave (.wav) format, you can send personalized voice messages to friends and colleagues as e-mail attachments that can be opened in most Web browsers on a desktop PC.

Voice Recorder is intended for recording personal voice memos and is not suitable for recording presentations, music, or lectures. Some static or electrical noise may be heard during playback.





To record and to play a voice memo with Voice Recorder

1. On the **Start** menu, point to **Programs**, point to **Accessories**, and then tap **Voice Recorder**.
–or–
Press the Voice Recorder hot key.
2. Tap the **Record** button on the toolbar. A beep sounds when recording begins, and the red Status LED indicates that recording is in progress.
3. Speak into the microphone to record your voice memo.
4. To stop recording, tap the **Stop** button on the toolbar. The new recording appears in the recording list.
5. To play a recording, double-tap it in the recording list. To pause playback, tap **Play/Pause**. Tap **Play/Pause** again to resume playback.



You can play all of your recordings, one after another. Select the recording you want to play first, tap **Control** and then tap **Play Sequential**. The selected recording and following recordings will be played. A short beep will sound between recordings.

Recording formats

Your HP Jornada supports several formats for voice notes. The formats vary in both the quality of the recording and the size of the sound file. When selecting a recording format, you should consider the quality you need as well as how much storage memory the recording will use on your HP Jornada.

In addition, not all recording formats are compatible with other software or computers. If you will share your recordings with others or transfer a recording to your desktop PC, be sure to choose a recording format that is supported by the software used to play recordings on the other computer.

To select a recording format

1. On the **Start** menu, point to **Programs**, then point to **Accessories** and then tap the **Microsoft Voice Recorder** icon.

—or—

Press the Voice Recorder **hot key** on the HP Jornada keyboard.

- On the **Tools** menu tap **Recording Format...**, and then select a recording format from the drop-down list.

The table below lists the compatibility of various recording formats with other computers. The list of recording formats on your HP Jornada indicates the sample rate, whether the format is stereo or mono, and how much storage memory is required per second of recording. You may need to experiment with different sample rates and formats to determine which format best suits your voice.

Format	Quality	Compatibility			
		HP Jornada 700 Series	Windows CE 2.0 device	PC with ActiveSync installed	Windows 95/98/NT
PCM	High	yes	yes	yes	yes
GSM 6.10	Medium	yes	yes	no	no

Conserving memory

Voice memos may consume large amounts of storage memory on your HP Jornada. If you record or store lots of voice memos, you may need to take steps to conserve memory.

- Delete voice memos you no longer need. Select the recording in the list, and then tap **Delete** on the **File** menu. Note that voice memos are deleted immediately; they are not moved to the Recycle Bin and cannot be recovered.
- Adjust the amount of storage memory available on your HP Jornada using the Memory tab in the System control panel.
- Add more memory to your device with a CompactFlash Card or PC Card. (For a list of recommended cards, go to the Hewlett-Packard Web site at www.hp.com/jornada.)



5 | Getting down to business

Your Hewlett-Packard Jornada 700 Series Handheld PC can help you stay productive and be efficient, even when you are away from your desktop or notebook PC. You have access to Microsoft Pocket Office and other pre-installed programs to help you calculate expenses and conduct searches. Your HP Jornada also includes the HP Jornada backup application, which keeps things running smoothly.

In this chapter, you will learn more about:

- Microsoft Pocket Office, which includes:
 - Microsoft Pocket Word
 - Microsoft Pocket Excel
 - Microsoft Pocket PowerPoint
 - Microsoft Pocket Access
 - Microsoft InkWriter
 - HP Jornada backup application
 - OmniSolve from LandWare
-

Working with Microsoft Pocket Office

Microsoft Pocket Office makes it easy to work in the familiar Office environment, even when you are away from your desktop or notebook PC. You can start any of the Pocket Office programs by double-tapping the appropriate icon on the desktop or by pressing the appropriate HP hot key. For more detailed information about these programs, see the Microsoft Pocket Office topic in online Help.

Using Microsoft Pocket Word

You can create and edit documents or templates in Pocket Word just as you do in Microsoft Word on your desktop computer. Begin by placing the cursor in the document page and start typing in either Outline or Normal view. A spelling checker is provided to verify spelling accuracy, and you can quickly format text using buttons and menu commands similar to those found in Microsoft Word on your desktop PC. You can access international characters and symbols for currencies from the **Tools** menu.

Pocket Word allows you to save documents in several file formats so that your files can be opened by other users or other programs. If you transfer documents between your HP Jornada and desktop PC, Microsoft ActiveSync automatically converts the files to the appropriate file type. If you send files by e-mail, be sure you save your document in a format that can be opened by the recipient:

file type	extension	open with
Pocket Word document	.pwd	Pocket Word
Pocket Word template	.pwt	Pocket Word
Word 6.0/95/97/2000 document	.doc	Microsoft Word 2000
Word 6.0/95/97/2000 template	.dot	Microsoft Word 2000
Rich Text Format	.rtf	most word processing programs
ASCII text	.txt	any text editor

To start Pocket Word



- On the **Start** menu, point to **Programs**, point to **Office**, and then tap **Microsoft Pocket Word**.
–or–
Press the Microsoft Pocket Word hot key.

To create a document using Pocket Word



1. On the **File** menu, point to **New**, and then tap **Document**.
2. Type the document.
3. On the **File** menu, tap **Save**.
4. Type a name for your file, and then tap **OK**.

To see more of your document, on the **View** menu, tap **Full Screen**.



Using Microsoft Pocket PowerPoint

You can deliver professional online presentations with Pocket PowerPoint. Simply create the presentation in Microsoft PowerPoint 97 on your desktop PC and transfer the presentation to your device. You cannot create slides on your HP Jornada; however, you can customize the title slide in the presentation and change the order of the subsequent slides to suit a particular client or audience.

You can show the presentation directly on your HP Jornada, or you can use an HP VGA out card to connect an external monitor or a projector and show the presentation to a large group. This option allows you to view PowerPoint speaker notes on the HP Jornada display while your presentation is showing on the external monitor. Your Pocket PowerPoint file will include the text, pictures, notes, and layout position of the original Microsoft PowerPoint presentation, but will not include animations or slide transitions. Animations are displayed as a single, still frame.



To start Pocket PowerPoint

- On the **Start** menu, point to **Programs**, point to **Office**, and tap **Microsoft Pocket PowerPoint**.
–or–
Double-tap the Microsoft Pocket PowerPoint icon on the desktop.



To show a presentation

1. Using Microsoft ActiveSync, copy the presentation from your desktop PC to your HP Jornada.
2. On the **Start** menu, point to **Programs**, point to **Office**, and tap **Microsoft Pocket PowerPoint**.
3. In the **Open Presentation** dialog box, select the presentation you want to show, and then tap **OK**.
4. To change the presentation display and slide-advance options, on the **Tools** menu, tap **Set Up Show**.
5. To show the presentation, tap **View Show** on the **View** menu. If you chose **Manual** under **Presentation Display** in step 4, use the **Previous** and **Next** buttons to control the slides.







You can tailor a presentation by adding a new title slide to your presentation. To do so, tap **Title Slide** on the **Tools** menu.



To show a slide presentation on a VGA-compatible monitor

1. Insert an HP VGA out card into your HP Jornada, and then connect the card to a monitor or projector according to the instructions that came with the card.
 2. Start PowerPoint, and open the presentation (see **To show a presentation** earlier in this chapter).
 3. On the **Tools** menu, tap **Set Up Show**.
 4. From the **View Show On** list, select one of the VGA out options.
-

5. To start the show, tap **View Show** on the **View** menu.

You can make the display fade to black during a presentation. To do so, press . To make the screen fade to white, press . Press  or  again to resume the presentation.



Using Microsoft Pocket Excel

You can use Pocket Excel to create workbooks, such as expense reports and mileage logs. Pocket Excel provides fundamental spreadsheet tools, such as formulas, functions, sorting, and filtering. You can split panes to easily view different areas of a large worksheet. You can also “freeze” the top and leftmost panes in a worksheet to keep row and column labels or other data visible as you scroll through a sheet.

Pocket Excel allows you to save workbooks in several file formats so that your files can be opened by other users or other programs. If you transfer workbooks between your HP Jornada and desktop PC, Microsoft ActiveSync automatically converts the files to the appropriate file type. If you send files by e-mail, be sure you save your workbook in a format that can be opened by the recipient.

To start Pocket Excel

- On the **Start** menu, point to **Programs**, point to **Office**, and then tap **Microsoft Pocket Excel**.
–or–
Double-tap the Microsoft Pocket Excel icon on the desktop.



To create a workbook using Pocket Excel

1. On the **File** menu, point to **New**, and then tap **Workbook**.
2. Create your worksheet.
3. On the **File** menu, tap **Save**.
4. Type a name for your file, and then tap **OK**.



If your workbook contains sensitive information, you can protect it with a password. To do so, open the workbook and

Password **File**



workbooks cannot be synchronized.

Using Microsoft Pocket Access

You can use Pocket Access to view and update data derived from Microsoft Access, Microsoft SQL Server, and other ODBC databases on your HP Jornada. You can open the database and update data in the corresponding tables or you can fill out electronic forms. Eventually, you should synchronize the new information with a larger database on your desktop PC or your corporate network. You can also use Pocket Access to create new databases, tables, and SQL procedures directly on your device.



Programmers can use Microsoft ActiveX™ Data Objects for MS Windows for H/PC 2000 (ADOCE) and Microsoft Visual Basic™ or Microsoft Visual C++™ to develop custom database solutions. For more information on creating custom database solutions, go to the Microsoft Web site at www.microsoft.com/mobile.



To create a new database and table

1. On the **Start** menu, point to **Programs**, point to **Office**, and then tap **Microsoft Pocket Access**.
–or–
Double-tap the Microsoft Pocket Access icon on the desktop.
 2. On the **View** menu, tap **Database View**, and then tap **Open/New Database** on the **File** menu.
 3. Type a name for the database and tap **OK**.
 4. Double-tap the Create a New Table icon.
 5. In the **Field Name** box, type a name.
 6. From the **Data Type** list, select a data type.
 - The data type of a field cannot be changed after the table is saved.
 - Text boxes have a size limit of 255 characters. To enter longer notes, select the Memo data type.
 - To enter numbers with decimal points, select the Float data type.
 - To enter numbers between -32,768 and +32,767, select the Integer data type.
-

- To enter smaller numbers, select the Small Integer data type.
- 7. To set the size limit of a field, enter an amount in the **Field Size** box. You cannot change field sizes after the table is saved.
- 8. To index the field, select **Yes** from the **Indexed** list. Indexing a field allows Pocket Access to find and sort information faster for that field.
- 9. Repeat these steps until you have created all the fields you want for your table.
- 10. On the **File** menu, tap **Save Table**.

If you have tables that you do not want to keep updated on the device (such as product catalogs), mark them as read-only when transferring them from the desktop to the device to save time during future synchronization sessions. Microsoft ActiveSync will not check for updates the next time you synchronize.



Printing your Pocket Office documents

You can print your Pocket Office and other documents from your HP Jornada in three different ways:

- By connecting directly to a PCL printer using the optional HP parallel printer cable (F1274A). For a list of compatible printers, refer to the HP parallel printer cable User's Guide that came with your HP Jornada.
- By connecting via infrared port (only with an infrared-equipped PCL printer).
- By transferring the file to your desktop PC and printing it from within a program on the desktop PC.

For instructions on printing directly to a printer using the HP parallel printer cable, see the HP parallel printer cable User's Guide.

To print directly to a printer via infrared

1. Open the file or document you want to print.
 2. On the **File** menu, tap **Print**. The **Print** dialog box appears.
-

3. Choose the PCL printer you will be printing to and select the IrDA port option.
4. Set other print options as necessary.
5. Tap **OK**, and then line up the infrared port on your HP Jornada with the infrared port on the printer.

Using Microsoft InkWriter

InkWriter, a text, graphics, and ink processor with Rich Ink technology, makes it easy to write and draw the way you do on paper, but with the benefit of being able to edit and format your writings and drawings. With InkWriter, you can enter information in the way that is easiest for you: type using the keyboard or write or draw on screen using the stylus.



To create an InkWriter document

1. On the **Start** menu, point to **Programs**, point to **Accessories**, and then tap **InkWriter**.
2. Create your document:
 - To type, tap **Writing** on the **View** menu, and then use the keyboard.
 - To draw, tap **Drawing** on the **View** menu, and then drag the stylus to draw on the touch screen. You can also create a drawing in Writing view by crossing three of the ruled lines on the first stroke of the drawing.
3. When you are finished, tap **Save** on the **File** menu.

Backing up and restoring data

To prevent loss of data, you should back up your HP Jornada data frequently. You can back up your HP Jornada two convenient ways:

- Use Microsoft ActiveSync to back up all data to your desktop PC.
 - Use the HP Jornada backup application to back up all data or only PIM data (Contacts, Calendar, Tasks and Inbox
-

databases) to a PC Card or CompactFlash Card or to internal memory.

Using Microsoft ActiveSync Backup

The Microsoft ActiveSync Backup feature creates a complete duplicate of all data stored on your HP Jornada. If you routinely connect to your desktop PC, this is the best method of data backup. The backup file is saved on the hard disk of your desktop PC.

Backing up data with ActiveSync on your desktop PC

If you have established a partnership between your HP Jornada and desktop PC, you can set ActiveSync to back up data automatically each time you connect. You can also back up your HP Jornada manually any time you want. ActiveSync lets you decide whether to back up all information each time, or only new and updated information.

To back up data with ActiveSync

1. Connect your HP Jornada to your desktop PC.
2. In the ActiveSync window on your desktop PC, on the **Tools** menu, tap **Backup/Restore**, and then tap the **Backup** tab.
3. Select either **Full Backup** (to back up all information every time) or **Incremental Backup** (to backup only new or updated information).
4. Click **Change** to change the name of your backup file or to specify a location for your backup file.
5. Tap **Back Up Now**.

Restoring data with ActiveSync from your desktop PC

When you restore data from a backup file created by ActiveSync, all data on your HP Jornada is replaced by the data in the backup file, including files you have created, programs you have installed, and any system settings and options you have set.

Restoring data from ActiveSync replaces all information stored on your HP Jornada. Any data added after the backup file was



created will be lost.

To restore data with ActiveSync

1. Connect your HP Jornada to your desktop PC.
2. Close all running applications on your HP Jornada.
3. In the ActiveSync window on your desktop PC, on the **Tools** menu, click **Backup/Restore**, and then click the **Restore** tab.
4. Click **Restore Now**. Do not use your device until the restore process is complete.
5. Disconnect the serial sync cable or remove your HP Jornada from the cradle (optional on the HP Jornada 710), remove the CompactFlash card (if installed), and perform a soft reset on your HP Jornada. See the **Resetting your HP Jornada** section in chapter 9.

Using the HP Jornada backup application

To ensure the complete safety of your data, use the HP Jornada backup application to back up to an optional CompactFlash Card. By backing up to a CompactFlash Card, you can safeguard your data even while you are traveling or while you are away from your desktop PC. HP backup lets you choose to back up all data or only PIM data (Calendar, Contacts, and Tasks, and Inbox). For information on using CompactFlash Card accessories with your HP Jornada, see the **Using PC Cards, CompactFlash Cards and Smart Cards** section in chapter 7.



If you have both a CompactFlash Card and a PC Card installed, two folders appear in the My Handheld PC folder. The folders appear in My Handheld PC in the order in which the storage cards are inserted.

You can also back up data to a folder on your HP Jornada; however, this will not preserve the information in case you lose power or need to perform a factory default reset. (See the **Resetting** section in chapter 8.)

Backing up data with HP backup

To back up data



1. On the **Start** menu, point to **Programs**, point to **HP Applications**, and then tap **HP backup**.
2. Tap **Backup**.
3. Choose what you want to backup:
 - Select **Full backup** to back up all information stored in RAM, including files you have created and programs you have installed. (Certain system settings and passwords are not backed up.)
 - Select **Backup only databases** to back up only your Contacts, Tasks, and Calendar databases and/or Inbox databases
4. Choose other **Backup options** to password protect or encrypt your backup file.
5. Tap **Backup Now** and choose a file name and folder location for your backup file. Then tap OK to complete the backup process.

For additional protection, you can copy the backup file (*.dbe or *.dbb) from your HP Jornada to your desktop PC.



Restoring data with HP backup

To restore from a backup file



1. First, remove the backup battery, the main battery, and the ac Power adapter. Wait for five full minutes, then reinstall ac power and the batteries in the reverse order.
 2. On the **Start** menu, point to **Programs**, point to **HP Applications**, and then tap **HP backup**.
 3. Choose what you want to restore, **Full restore** or **Restore only databases**, then tap **Restore Now**.
 4. Select the backup file you want to restore from, and then tap **OK** to complete the restore process.
-

5. After completion, perform a soft reset before using your HP Jornada (see the **Resetting** section in chapter 8).



When you restore, your HP Jornada must have the same regional settings as when you completed the backup. Otherwise, you will not be able to restore the files. To change regional settings, on the **Start** menu, point to **Settings**, tap **Control Panel**, and then double-tap the **Regional Settings** icon. Select your region from the drop-down list.

Using OmniSolve from LandWare

OmniSolve is a financial application that offers the same features as the HP business calculator. It is designed specifically for real estate, retail, and business professionals who use Handheld PCs to make financial decisions quickly and accurately. OmniSolve employs a “form filling” metaphor to provide you with a rich problem-solving environment that is unparalleled in its ease of use, power, and flexibility.



To start OmniSolve

- On the **Start** menu, point to **Programs**, point to **Accessories**, and then tap **OmniSolve**.

For detailed procedures about using OmniSolve, refer to OmniSolve online Help.

Using Yahoo! Messenger



To get started using Yahoo! Messenger

1. To activate Yahoo! Messenger you must create a free Yahoo account by visiting the Yahoo! Messenger Web site at: <http://messenger.yahoo.com/messenger/>. When you sign up for your free account you will create a login ID and password.
 2. Open Yahoo! Messenger and enter your login information at the login screen.
 3. Next, choose your connection preference (you will be prompted for this after you login). Enter the username and password for your ISP, and click "Connect".
-

That's all there is to it! Now you are ready to share instant messages with family, friends and associates. For more detailed information about using Yahoo! Messenger, go to the Yahoo! Messenger help page on the Web at:
<http://help.yahoo.com/help/us/msg/>



6 | Accessing e-mail

With your HP Jornada Handheld PC (H/PC), you can keep in touch with your office, home, and clients through e-mail and the Internet. You can connect in many ways using your HP Jornada and various accessories. This chapter will guide you through the options best suited to your needs.

This chapter provides information that allows you to:

- Decide why and how you want to connect
- Set up your HP Jornada to access personal or e-mail and the Internet
- Set up your HP Jornada to access corporate e-mail and your network or PC when you are away from the office (offsite)
- Set up your HP Jornada to access corporate e-mail and network resources when you are in the office (onsite)
- Set up additional connections with the HP Jornada dialup application or Remote Networking
- Use your connections with Inbox and Microsoft Internet Explorer 4.01 for H/PC

Deciding how and why you want to connect

The method you use for sending and receiving your e-mail, browsing the Internet, and accessing other remote resources depends on your goals and situation. Do you:

- Need access to personal (non-corporate) e-mail and the Internet?
 - Need access to corporate e-mail and network services when you are on the road or out of the office?
 - Need access to corporate e-mail and network services when you are onsite at your company?
-

- Have more than one e-mail account (for example, personal and business)?

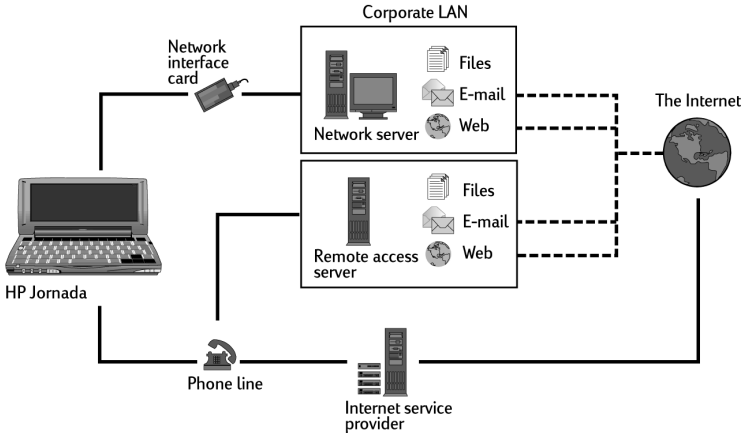

Your answers to these questions will help you determine which equipment you can use in combination with your HP Jornada to keep in touch online. The following illustration depicts the different solutions to your online needs.

Which connection options are right for you?



For explanation of some of the terms used in the descriptions that follow or in the HP dialup application, check the glossary at the end of this User's Guide.

Accessing e-mail, the Internet, and corporate intranets

Typical personal Internet connection

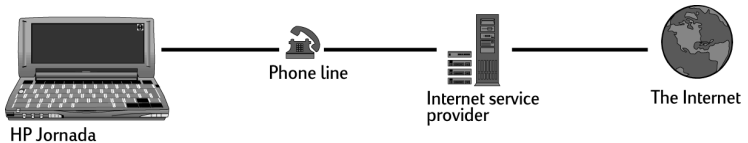

If you want e-mail and Internet service only (with no access to a company network), you will need:

- **An installed modem**—If your HP Jornada is equipped with a built-in modem, you are ready to go. If not, you can choose

from a variety of available PC Card modems*, Bluetooth devices, and LAN cards. (For more information about compatible PC Card modems and other PC Card communication devices, go to the HP Jornada Accessories page on the HP Jornada Web site at www.hp.com/jornada.)

- **A PPP (Point-to-Point Protocol) or SLIP (Serial Line Internet Protocol) account**—An Internet service provider (ISP) will provide you with important information, such as a user name, password, dial-up telephone number, server names, and so on.
- **A dial-up connection set up on your HP Jornada**—HP dialup makes this step easy.
- **Access to a telephone line**—You can connect to an analog telephone line if your HP Jornada has a built-in modem. If you use a PC card modem, check the manufacturer's instructions for telephone line compatibility.

If you use the HP Jornada internal modem, you must use an analog telephone line to connect your modem. Connecting to a digital telephone line can damage your modem.



Connecting to corporate e-mail and network from off-site

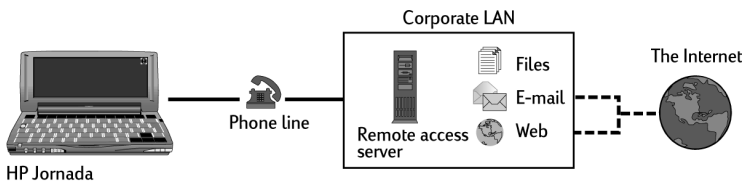

Typical corporate LAN remote (off-site) connection

If you want dial-up access to corporate e-mail and Internet services when you are offsite, then, in addition to the items necessary for a personal internet connection listed above, you will need:

* Modem purchased separately. Some Web sites/content may not be available.

- **An account with your corporate network set for dialing in to your network server**—Your network administrator can provide you with important information, such as a user name, password, dial-up telephone number(s), server names, and so on.

Connecting to corporate e-mail and network resources on-site

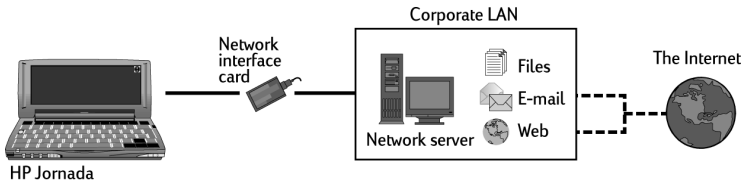

Typical corporate LAN on-site network connection

If you want corporate e-mail and Internet service only (with no access offsite), you will need:

- **An installed network interface card (NIC)**—that is properly configured with the IP address of your DNS and WINS servers (your network administrator can give you this information)
- **An account with your corporate network**—including an IP address for your HP Jornada, if it is not dynamically assigned
- **A network (LAN) connection**—a network cable with the appropriate connector for your NIC
- For detailed instructions on how to connect your HP Jornada to a network via LAN cable, see **Connecting directly to corporate e-mail and network resources through a network interface card (NIC)** later in this chapter.

Creating Connections

Once you have decided what type of connection method you need, you easily create and configure a Internet, intranet or network connection by following the instructions in the following pages.

Since personal Internet and off-site corporate dialup connections methods are quite similar they are addressed first, followed by

instructions for creating an on-site connection to a local area network (LAN).

Personal and corporate dialup connections

Installing and configuring a modem

If you purchased an HP Jornada with a built-in 56K V.90 modem, it is already setup for easy communication. No installation is required.

The 56Kbps modem complies with V90 ITU 56K specifications and has a design capability of receiving data at up to 56Kbps from a compatible service provider, and transmitting data at up to 31.2Kbps. Public networks currently limit maximum download speeds to about 53Kbps. Actual speeds depend upon many factors and are often less than the maximum possible.



Note that the UK version of HP Jornada does not support certain dialing properties. The HP Jornada built-in modem (on models equipped with a built-in modem) does not detect a dial tone before dialing. By default, the Wait for dial tone before dialing box is checked. The modem will dial even if there is no dial tone. It also does not support the pulse dial option. The modem dials using tone dial only. By default, tone dialing is selected.

The HP Jornada supports a variety of available PC Card modems*. (Check www.hp.com/jornada for more information on compatible PC card modems.) Follow the manufacturer's instructions included with the PC Card modem to install and configure it for use with your HP Jornada.

Getting an account with an Internet service provider

To access the Internet and e-mail, you will need to contact an ISP to set up a PPP account. SLIP accounts are offered by some ISPs instead of PPP accounts. Your HP Jornada supports the use of SLIP as well as PPP.

*Modem purchased separately. Some Web sites/content may not be available.

Your ISP will be able to give you all the configuration information you need to connect your HP Jornada to the Internet and e-mail service. Be sure to note the following:

- Your account user name.
- Your account password.
- Telephone number of your ISP modem.
- IP and DNS addresses, if necessary (most dial-up accounts are assigned addresses dynamically each time you connect).
- Your e-mail user name or ID. (This may be the same as the user name for your ISP account.)
- Your e-mail password. (This may be the same as the password for your ISP account.)
- The POP3 or IMAP4 host name of your ISP.
- The SMTP host name of your ISP (if required by your ISP).

Setting up a dial-up connection to your ISP

Use HP dialup to create a dial-up connection to the Internet or to a corporate network and to configure e-mail and Web services.

After you have established an account with an ISP, you can set up a connection on your HP Jornada and connect to the Internet and your e-mail whenever you want. To make this configuration process easier, use the HP Jornada dialup application. The HP dialup **Setup Wizard** leads you through the process of configuring your connections.

The first time you start HP dialup, the Setup Wizard leads you step-by-step through the processes of creating and configuring:

- a connection to your **service provider**
- a **dialing location**
- an **e-mail service**
- a **Web service**.

The settings you create in HP dialup are used by several programs, including Remote Networking, Inbox, and Internet Explorer.

Starting HP dialup

To start HP dialup



- On your Jornada desktop, double-click the **HP dialup** icon.
—or—

On the Start menu, tap **Programs**, tap **HP Applications**, and then tap **HP dialup**.

If you have already created a connection, use the Connect! screen to connect to your service provider or to add or modify a connection or location.



Running the HP dialup Setup Wizard

If this is the first time you have used HP dialup, follow the instructions on your screen to complete the Setup Wizard and create a connection to your Internet service provider or corporate network, and set up e-mail and Web services. Each tab on the HP dialup window has a corresponding section in the setup wizard

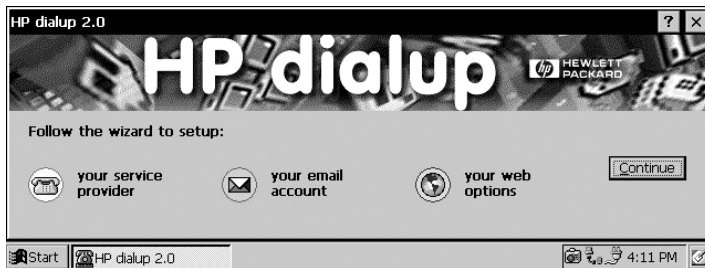

Service Provider

If you use several locations for connecting to the same service, create a unique service provider setup with settings for each location.



Domain

If your service provider requires you to specify a domain when you log on (for example, when connecting to a Windows® NT® network), select the **Network Domain** check box, and then type the domain name in the box.

Internet Service Provider (ISP)

If your ISP is listed, select it from the **Service Provider** list, and then select your country, state, and city to ensure you get the local dialup number for your ISP.

When you select an ISP from the list, the country code, area code, and telephone number fields are automatically filled in. If you need to make any changes, you can edit the numbers in the box where they appear

If you are connecting to a corporate network or if your ISP is not listed, select (**Not in the list**), and then enter the country code, area code, and telephone number for your service provider directly into the boxes provided.



If your country or city (area code) is not on the list, you can edit the database in World Clock. To do this, go to the Control Panel, and double-tap the World Clock icon. On the Options tab, tap Add. The dialog boxes will guide you through adding your customized city information to the database.

Modem Settings

On the **Port Settings** tab, enter your connection preferences. (If you are not sure about these settings, check with your service provider or network administrator.)

On the **Call Options** tab, set your preferences for canceling the call, and enter any extra modem commands to add to the dialing string.

TCP/IP

Tap **TCP/IP** to set the IP addresses for your HP Jornada and your service provider's DNS and WINS servers.

If your ISP assigns IP addresses each time you connect (dynamic connection), choose the **Server-assigned IP address** in the IP

Address section, and **Server-assigned address** under Name Server Configuration.

If you selected an ISP from the list, the IP addresses will be filled in automatically



If you are **connecting to a corporate network**, or your ISP was not in the list, **you will need to provide the IP addresses**. Contact your ISP or network administrator for more information. Tap **OK** to return to the setup wizard.

You also have the option to choose software and IP header compression options. Ask your ISP if these options are recommended for your account.

If you have created one Service Provider using HP dialup, you can create another by tapping the **New** button on the **HP dialup** Service Provider Tab. Then, follow the Setup Wizard to create a new ISP connection.



E-mail Service

Select your service provider's e-mail protocol from the drop-down list. **Inbox** supports both the POP3 and IMAP4 protocols. *POP3 OpenMail is not supported.*

The default options represent the settings used by many ISPs. If you are not sure, or you do not have guidance from your ISP, try the default settings.



If your service provider requires you to specify a domain when you log on (for example, when connecting to a Windows NT network), select the **Network Domain** check box, and then type the domain name in the box.

Depending on your service provider, you may have different addresses for your incoming mail (POP3 or IMAP4) server and your outgoing mail (SMTP) server.

Under **Connection Options** you can choose a variety of settings for connecting to your e-mail account.

By default, **Inbox** checks for new messages every 15 minutes while connected. If you want to change this setting, or if you wish

to change other connection options, click **Change** to display the Connection Options dialog box.



You can also change the connection settings and download settings later from within the **Inbox** program. For more information, see **Inbox Help**.

Under **Download Options** you can choose settings for downloading message headers, full messages, meeting requests and attachments. By default, Inbox downloads only message headers and the first 100 lines of text in a message, as well as any file attachments. If you want to use different settings, tap **Change** to display the Download Options dialog box.

Web Service

If you are required to use a proxy server, select the **Use proxy server** check box, and then type the server address and port number, then tap **Next**.



If you connect to the Internet over a corporate network, you may need to use a proxy server. Your network administrator can tell you whether you need to use a proxy server, and if so, the server address and port settings.

Your **home page** is displayed when you start Internet Explorer using this service. It can be a page on the Internet or on a corporate intranet.

Your **search page** is displayed when you click the search button on the IE toolbar.

Get Connected

After you have completed the Setup Wizards, use HP dialup to quickly select your dialing location and the connection you want to dial, then connect to your service provider. You can also use HP dialup to add or modify connections, dialing locations, and e-mail or Web services

Connecting the telephone line

After you have configured your connection to your ISP or LAN, you are ready to connect your telephone line to your built-in modem (on models equipped with a built-in modem) or PC Card modem and then dial in. Use this procedure to connect to an analog telephone line. If you are using a PC Card modem, follow the instructions provided by your modem manufacturer for connecting to a telephone line type supported by your modem.

To connect an analog telephone line to your HP Jornada

1. Connect the telephone cord to the telephone jack.
2. Connect the other end of the telephone cord to the telephone connector on the side of your HP Jornada or to your PC Card modem (following the instructions provided by your modem manufacturer).

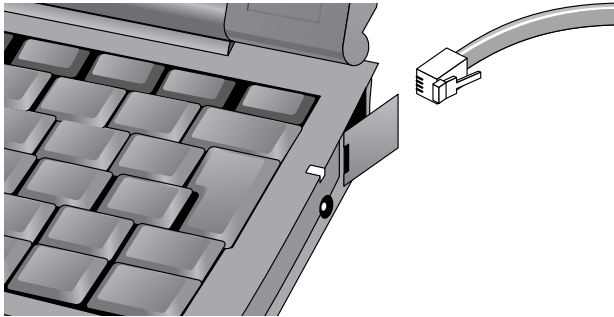

Connecting to your Service Provider

To establish a connection



1. On your Jornada desktop, double-click the HP dialup icon.
-



2. Select your service provider from the list. (A service provider may be either an Internet Service Provider (ISP) or a corporate network.)
3. Select your dialing location from the list.
4. Verify that the phone number box displays the dialing string exactly as it should be dialed, including any special dialing codes (for example, codes that are required to reach an outside line or to disable call waiting).



For more information on dialing codes, see the Dialing strings topic in HP dialup online help.

5. If you want to check your e-mail when you are connected, select the **Launch Inbox** check box, and then select your e-mail service from the list. When a dial-up connection is established, Inbox will start automatically and download any new messages.
6. If you want to browse the Web or your corporate intranet using Internet Explorer, select the **Launch Internet Explorer** check box, and then select the Web service to use. When a dial-up connection is established, Internet Explorer will automatically open the Home page associated with this Web service.
7. Click **Dial**.



When you use HP dialup to connect to your ISP, the Web options you set in HP dialup take precedence over any options you may have set in Internet Explorer.

After you are connected to your ISP, use the Inbox program to send and receive e-mail or use Internet Explorer to browse the Web. (For more information, see the **Sending, receiving, and processing your e-mail** and **Browsing the Web or your intranet with MS Internet Explorer 4.01 for H/PC** sections in this chapter.)

A dialup connection cannot be made while synchronization is in process, or after synchronizing while still connected to your desktop PC when the autodial option is selected. You must disconnect from the desktop PC in order to make a connection.



To disconnect from your ISP or dialup LAN connection

1. Double-tap the HP connection icon in the status area of the taskbar.
2. In the **HP dialup** window, tap **Disconnect**.

When the HP connection icon is displayed in the status area of the taskbar, your HP Jornada is connected to your service provider. Be sure to disconnect from your service provider and to unplug the phone line from your HP Jornada when it is not in use.

If you have already created one connection profile using HP dialup, you can add another by tapping the **New** button on the **Service Provider** tab in the **HP dialup** window. The Service Provider Setup Wizard will start.



Connecting directly to corporate e-mail and network resources through a network interface card (NIC)

You must use an NIC to connect your HP Jornada directly to a LAN. NICs are available from several manufacturers as PC Card accessories. (For a list of recommended PC Card NICs, go to the Hewlett-Packard Web site at www.hp.com/jornada.) Install the PC Card NIC in the PC Card slot on your HP Jornada, and then attach the network cable according to the instructions provided by your card manufacturer.

In addition to the PC Card NIC, you will need to install the appropriate driver software to configure the NIC. Drivers for the following LAN cards are included on the HP Jornada:

Socket LP-E LAN card

Proxim RangeLAN2 wireless LAN card

Cisco Aironet 4800 series wireless LAN cards

Drivers for other cards must be obtained from the card manufacturer. Install software drivers as you would any other third party program. (For more information, see the **Installing programs** section in chapter 7.)

Establishing an account or guest privileges on the network

Contact your network administrator to set up an account or guest privileges on the network. The network administrator will give you the information you need to log on to the network, including user name, password, domain name, and IP address (if applicable).

Use the Network control panel to configure the NIC with the information your network administrator has provided.

To configure the NIC

1. On the **Start** menu, point to **Settings**, and then tap **Control Panel**.
2. Double-tap the Network icon. The **Network Configuration** dialog box appears.
3. On the **Adapters** tab, select the driver or adapter, and then tap **Properties**. Check with your network administrator if you do not know which settings to use.
4. On the **Identification** tab, enter your user name, password, and domain name. This information will be saved, so you will not have to type it every time you connect to a network resource.

Connecting the network cable and logging on

Connect your NIC to the network cable. Follow the manufacturer's instructions included with your PC Card. Contact your network administrator for further assistance..

To log on to the network with your HP Jornada

1. Insert the NIC into the PC Card slot on your HP Jornada and connect the network cable. The network will establish a connection automatically.
2. Once you are connected a connection icon will appear in the status area of the taskbar. (For more information, see the **Inserting a PC Card** section in chapter 7.)

After you have connected your HP Jornada to the network, you can access a file on a network file server by typing the complete path to the file in the Windows Explorer address bar.

To access a file on a network

1. On the **Start** menu, point to **Programs**, and then tap **Windows Explorer**.
2. Be sure the address bar is visible—on the **View** menu, be sure a check mark appears next to **Address Bar**.
3. In the address bar, type the full network path to the file you want to open, using the format <file:///servername/share/filename>.

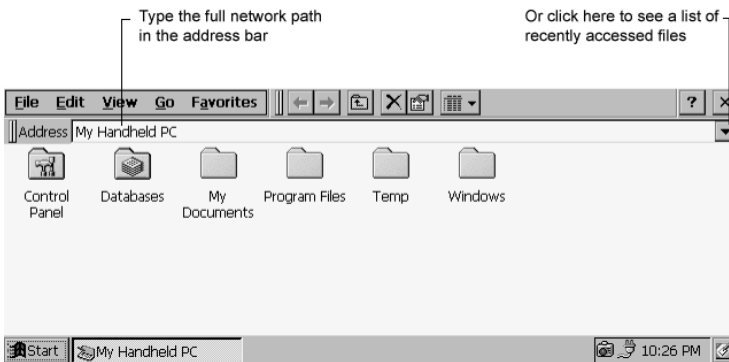

Windows Explorer keeps a list of the most recently used Internet and network resources, so you will not have to type the path each time. Select a network path or URL from the drop-down list.



Creating and modifying connections

You may set up more than one connection using HP dialup; for example, you may create separate connections for access to your personal e-mail and for network access. After you have set up the first e-mail/Internet or network connection, use HP dialup to create another connection. You can also use HP dialup to modify existing connections; for instance, you may want to change the dial-up telephone number or the dialing location.



To create an additional connection or location

1. Double-tap the HP dialup icon on your desktop. The **HP dialup** window appears. Select the tab for the type of service or location that you want to add.
2. Under the service name list box, tap **New** to start the setup wizard for that service or location type, and follow the prompts to enter information and create a new service.
3. When you are finished, tap **Done**. Your new connection or location will appear in the drop-down list on the service tab in the **HP dialup** window.



To modify an existing connection or location

1. Double-tap the **HP dialup** icon on your desktop.
 2. Select the tab of the service or location that you want to modify.
 3. Tap **Edit More** to activate the setup wizard for the service to guide you through editing the information on the setup screens
—or—
Edit the values directly in the input boxes on the selected tab.
 4. Close the **HP dialup** window and your changes will be saved automatically.
-

Tapping on New in the Dialing Location tab does not start a setup wizard. When you click on New, only the **Prefix for calling** values change.



Creating connections without the HP Jornada dialup application

You can also create connections to your ISP or network by configuring the necessary programs manually. Before you can dial up, you will need to:

- If your HP Jornada does not have a built-in modem or you do not want to use the built-in modem, install and configure a PC Card modem*. Follow the instructions provided by your modem manufacturer.
- Establish an account with an Internet Service Provider (ISP) or your corporate network administrator (for remote access to your corporate network). Note the same information that is presented in the previous sections in this chapter.
- Set up a Remote Networking connection.
- Set dialing patterns and dialing locations.
- Set up an e-mail service in Inbox and/or a Web service in Internet Explorer. For more information, see the **Using Inbox** and **Browsing the Web or your intranet with MS Internet Explorer for H/PC** sections later in this chapter.
- Connect your HP Jornada to a telephone line.

To set up a Remote Networking connection



1. Use either the HP Jornada built-in modem (on models with built-in modem), or install a PC Card modem.
2. Get the following information from your service provider (ISP or network administrator): dial-up access telephone number, user name, password, and domain name.
3. On the **Start** menu, point to **Programs**, point to **Communication**, and then tap **Remote Networking**.

* Modem purchased separately. Some Web sites/content may not be available.

4. Double-tap the Make New Connection icon. The **Make New Connection** dialog box appears.
5. Enter a name for the connection, such as "Corporate Dial-Up," tap **Dial-Up Connection**, and then tap **Next**.
6. Select your modem type from the list. You should not need to change settings in the **Configure** or **TCP/IP Settings** dialog boxes (if you are not sure, check with your network administrator). When you are finished, tap **Next**.
7. Enter the access telephone number and tap **Finish**.

Once you have created the dial-up connection, simply double-tap the connection, enter your user name, password, and domain, and tap **Connect** any time you want to connect.

Once connected, you can use Internet Explorer to visit Web pages and use Inbox to send and receive e-mail. Before you can use Inbox, you need to set up an e-mail service. See the **Using Inbox** section later in this chapter.



To set a dialing location for a Remote Networking connection, double-tap the icon for the connection in the Remote Networking folder. In the **Dial-up Connection** dialog box, tap **Dial Properties**, and then fill in the information as you would for a network or ISP connection using **HP dialup**.

Using your connections

After you have set up for the connection that best meets your needs, you are ready to use that connection for sending and receiving e-mail, or browsing the Web.

Using Inbox

You can use the Inbox program to send and receive e-mail over the Internet with your HP Jornada. You can also exchange e-mail over your company's intranet, either by remote dial-up (using your modem) or by direct connection (with an NIC).

Using Microsoft ActiveSync, you can synchronize information in Microsoft Outlook or Microsoft Exchange on your desktop computer with your HP Jornada. Each time you synchronize, Microsoft ActiveSync compares the changes you made on your HP Jornada and desktop PC and updates both computers, including changes to the messages in your Inbox. For more

information, see chapter 3, **Connecting to your desktop** or refer to online Help.

HP dialup automatically sets up an Inbox service for you. However, you can also set up Inbox services from within the Inbox program.



To set up an e-mail service

1. On the **Start** menu, point to **Programs**, point to **Pocket Outlook**, and then tap **Inbox**.
 2. In Inbox, on the **Services** menu, tap **Options**.
 3. On the **Services** tab, tap **Add**.
 4. The Mail Service Setup wizard will guide you through the steps required to create a mail service. Enter the appropriate information on each of the three setup screens. (*Refer to **Inbox** online help for more detailed information.*)
 5. Tap Finish to complete the setup of this new service. If this is the first time you have created an e-mail service, click **No** in the **Enable Address Issue** dialog box.
-

For more information about Inbox settings, see the **Inbox settings** section later in this chapter.





Sending, receiving, and processing your e-mail

You can use a dial-up connection to send messages directly from your HP Jornada, or you can use Inbox synchronization to send the messages you compose on your HP Jornada from your desktop computer (see the **Synchronizing data** section in chapter 3).

If you send messages directly from your HP Jornada, you will first need to configure a connection to your ISP or network, and then set up an e-mail service. You can use the HP dialup application to set up both the connection and the e-mail service, or you can create a connection using Remote Networking, and then set up the e-mail service in Inbox.

After you have created the connection and e-mail service, use Inbox to connect to your service provider and retrieve your mail.

To connect to your service provider from Inbox

1. On the **Services** menu, tap the connection you would like to dial, then pull the Services menu down again and tap **Connect**.
2. Type your user name, password, and domain name, if necessary.
3. Tap **Dial Properties** if you need to modify a location or choose a different one.
4. Tap **Connect**. A message will appear to show you the status of your connection. When your connection is established, you can send and receive mail.



You can connect to most e-mail accounts and download messages to your HP Jornada even if your desktop PC (partner) e-mail service uses a client other than Outlook or Exchange (for instance, if your e-mail client is Lotus Notes). However, you can only synchronize e-mail with your desktop PC inbox if your desktop PC uses either Outlook or Exchange as its mail client. Access to e-mail on a POP3 OpenMail account is not supported on your HP Jornada.

Inbox settings

When you connect to a mail server, the messages on your device and mail server are synchronized: new messages or message headers are downloaded to the HP Jornada Inbox folder, messages in the HP Jornada Outbox folder are sent, and messages that have been deleted from your Inbox are removed from the server.

You can choose settings to control what will be downloaded.

- Set Inbox to download all your messages or only new message headers to the Inbox folder.
- Downloading only message headers saves storage space and requires less connect time.
- By default, only messages from the last 3 days are downloaded.
- By default, only message headers and the first 100 lines of text are downloaded, and the original messages remain on the mail server. If you read a message header and decide that you want the full copy, tap the **Get Full Copy** button on the Inbox toolbar. The full text of the message will be retrieved the next time you connect.

To change the default settings, or to set options for retrieving file attachments and meeting requests

- 1 Tap **Options** on the **Services** menu, select the service you want to modify, and then tap **Properties**.
- 2 The E-mail Service Definition dialog displays two panels, **Required** and **Optional**. Choose the options you want for the selected service.

Attachments

When you send an attached file, such as a Pocket Word file, be sure the recipient can read the file type you are sending. Pocket Word files (.pwd) can only be read by other H/PC 2000 devices such as the HP Jornada. You can choose to save the file as .txt or .rtf if you are unsure, or you can choose to save the file as a Word file (.doc). For information about the file types associated with a particular program, refer to the **Pocket Office** section in chapter 5.

Inbox supports the use of MIME encoding for binary attachments; however, you must be sure that both the sender's and the recipient's mail servers also support MIME. If your mail server does not support MIME encoding, file attachments that you receive may be corrupted or even cause your HP Jornada to freeze .



If you experience problems sending or receiving file attachments, or if you are not sure whether your mail server supports MIME, check with your ISP or network administrator.

By default, Inbox will use MIME when sending attachments. To turn off MIME encoding, tap **Options** on the **Services** menu, select the service, tap **Properties**, tap **Next**, and then deselect the **Send using MIME format** check box

For detailed descriptions of the settings related to reading and sending e-mail attachments, see the Inbox topic in online Help.

If you choose to download attachments along with your messages, you can save them on your HP Jornada or storage device. To save memory, you can save attachments automatically to a storage card.

To save attachments automatically to a storage card

1. On the **Services** menu, tap **Options**.
2. On the **Storage** tab, select the **External Storage Card** radio button. Tap **OK**.

Message deletion

Deleting messages in Inbox also deletes them on your service provider's e-mail server. If you delete a message while off-line, the message is deleted from the server the next time you connect.

Message deletion is permanent. Deleted messages are not moved to the Recycle Bin, and they cannot be recovered.

When you delete a message, any files attached to the message are also deleted. To save a file attachment before you delete the message, open the file attachment in the program that created it (for example, Pocket Word), and then tap **Save As** on the **File** menu. See online Help for more information.

Browsing the Web or your intranet with Microsoft Internet Explorer 4.01 for H/PC

You can use MS Internet Explorer for H/PC to browse the Web or your corporate intranet with your HP Jornada. Internet Explorer allows you to view Web sites directly on your HP Jornada, download forms from your corporate intranet and save them for later use, or save your favorite online news page to read later when you are offline.

After you have set up an online connection with your ISP or your network account, you are ready to dial up and start browsing the Web or your intranet. You can set Internet Explorer to automatically dial a connection you create whenever you start it.

If you have not yet created an ISP or network connection, you must set up a service provider before you can browse the Web. Use either **HP dialup** or **Remote Networking** to set up your connection. (If you choose to use Remote Networking, see the **Creating connections without HP dialup** section in this chapter.)



If you set up the Web service using HP dialup, you can set different Web browsing options and preferences for each connection. The options you set in HP dialup determine how the connection is made and what home and search pages are displayed.

To edit or set connection information in MS Internet Explorer for H/PC



1. In Internet Explorer, on the **View** menu, tap **Internet Options**.
 2. On the **Connections** tab under Auto Dial, tap the **Use Auto Dial** checkbox.
 3. Choose the Dial-Up networking connection to be used.
 4. Select the **Auto Disconnect** checkbox if you wish to disconnect automatically from the Internet after a specified period of idle time.
 5. If you are required to use a Proxy Server on a network, tap **Use Proxy Server** and enter the server address.
-

6. Use the other **Internet Options** tabs to set information such as **Default Pages**, **Cache**, **History**, **Security** and **Advanced features**.
7. When you are finished, tap **OK** to save the changes.

If you set up AutoDial in Internet Explorer, you can connect to the Internet simply by starting the program and entering the address of a Web site. (Be sure your telephone line is connected properly first.) If you prefer to dial up independently of Internet Explorer, you may want to clear the AutoDial option. To connect using HP dialup, use the following procedure.



To browse the Web or your company intranet

1. Double-tap the HP dialup icon on your desktop. The **HP dialup** window appears.
2. Select your **network service provider** and a **dialing location** from the drop-down boxes.
3. Choose the **Launch Internet Explorer** check box option.
4. Check the telephone number, and then tap **Dial**. A progress message appears to tell you when you are connected to your ISP, and then an icon appears in the taskbar while you remain connected.
5. Internet Explorer starts up automatically and you are ready to browse the Web or your corporate intranet.

If you did not use HP dialup to create your connection, you will need to activate the connection you want in Remote Networking. On the **Start** menu, point to **Programs**, point to **Communication**, and then tap **Remote Networking**. In the Remote Networking folder, double-tap the icon of the connection you want. Tap **Connect** to begin dialing.



Although it is based upon the outstanding content delivery features of the Microsoft Internet Explorer Web browser for desktop PCs, Microsoft Internet Explorer for Handheld PC has been specially created to work efficiently on the compact HP Jornada Handheld PC.

Most Web animations and graphical elements display well on your HP Jornada, but some third party animations and graphics may appear as a single still frame, or may not appear at all. You may also have difficulty viewing Web pages that require ActiveX controls or plug-ins.

For more detailed information on MS Internet Explorer 4.01 for H/PC features, settings and customization, see the extensive, online, context-sensitive help files.



HP ChaiVM brings the Java™ virtual Machine to the Jornada H/PC

HP ChaiVM adds Java capability to Internet Explorer



For users, the ability to view Java applets in Internet Explorer.

- HP ChaiVM allows users to experience many web effects written in Java while browsing the Web with Internet Explorer. Many dynamic Java-based web page elements are automatically displayed, adding to the quality of the Web browsing experience. HP's ChaiVM software is included in ROM on your Jornada 700 Series H/PC.
-

For developers, an HP embedded Java virtual machine.

- HP ChaiVM allows development of custom Java applications for use on the HP Jornada H/PC. ChaiVM is an HP developed virtual machine, compliant with the Java™ Virtual Machine Specification, and tailored specifically for devices like the Jornada H/PC.

For more information about HP ChaiVM visit the Chai Web site at <http://www.chai.hp.com>.

Using HP ChaiVM with Internet Explorer

HP ChaiVM is enabled in Internet Explorer by default. Java applets are automatically displayed in the browser screen for you without any special action required.

With HP ChaiVM enabled, a minimum of 16MB of system program memory is required. If necessary, you can adjust memory settings using the **System** control panel.

To open the System control panel, on the Start menu, tap Settings, tap Control Panel, and then tap the System icon. Adjust the slider to change memory allocation settings. (For more detailed information about adjusting memory settings see **Managing Memory** in chapter 7.)

Disabling HP ChaiVM in Internet Explorer

Occasionally you may encounter a Web page using Java applets that does not load properly, preventing you from accessing the site or causing Internet Explorer to shut down. Disabling HP ChaiVM may make the site accessible, but you will not be able to view the Java applet.

To Disable HP ChaiVM in Internet Explorer

1. Tap **Start**, tap **Programs**, tap **HP Applications**, and then double-tap **HP ChaiVM**.
 2. Tap **Options** to open the ChaiVM Options dialog box and uncheck the **Enable HP ChaiVM plug-in in Internet Explorer** check box.
 3. Tap **OK** to save your changes and exit the ChaiVM Options dialog.
-

4. Close HP Chai VM and try Internet Explorer again.

Clearing the HP ChaiVM cache

Some Java applets cause temporary files to be saved in HP ChaiVM. These files can unnecessarily take up precious storage memory, causing programs to run slowly, or causing the Jornada to freeze. It is a good idea to periodically clear the ChaiVM cache to remove these unwanted files and free up the memory they consume.

To clear the cache in HP Chai VM

1. Tap **Start**, tap **Programs**, tap **HP Applications**, and then double-tap **HP ChaiVM**.
 2. Tap **Options** to open the ChaiVM Options dialog box.
 3. Tap **Clear Cache** to remove all ChaiVM temporary files.
 4. Tap **OK** to exit the ChaiVM Options dialog and then close HP ChaiVM.
-



7 | Optimizing your HP Jornada

This chapter details ways you can optimize your HP Jornada using Control Panel and HP Utilities, and ways you can expand the features and functionality of your HP Jornada by adding software and accessories. This chapter also offers tips on traveling with your HP Jornada and keeping your HP Jornada safe. These tips will help you become more efficient and make working with your HP Jornada more comfortable and fun.

In the following pages, you will learn about:

- Adding to your HP Jornada—Add programs, fonts, sounds, and desktop wallpaper.
 - Using accessories—Use CompactFlash cards, PC Cards, and Smart Cards to expand the storage capacity, security and power of your HP Jornada.
 - Managing memory—Learn how to allocate storage and program memory for optimal performance.
 - Managing battery power—Learn how to replace, and how to get the most from, your batteries.
 - Fine tuning performance—Use control panel to set various options, including customizing the HP hot keys and setting general system settings.
 - Traveling with your HP Jornada—Follow simple guidelines for optimizing your device for use while away from the office, including a check list of everything you need to take with you.
 - Protecting your HP Jornada—Safeguard your HP Jornada from theft and data loss.
-

Adding programs, fonts, sounds, and images

This section describes how to add functionality to your HP Jornada by installing software and how to customize the MS Windows for H/PC 2000 desktop and working environment.

Installing programs

You can add even more functionality to your HP Jornada by installing third party software. A wide variety of commercial software is available for the MS Windows for H/PC 2000 operating system, ranging from custom business applications and system utilities to games and entertainment. Some programs are available on the Microsoft ActiveSync compact disc included with your HP Jornada.



The only programs that will run on your HP Jornada are those designed specifically for MS Windows for H/PC 2000. You cannot run programs designed for Windows 95/98/NT/2000 or other Windows Mobile platforms, like Pocket PC, on your HP Jornada.



The HP Jornada Web site (www.hp.com/jornada/solutions/) includes many downloadable productivity-enhancing programs such as:

- **Inso® Quick View Plus®**—view e-mail attachments or documents in multiple text, with embedded tables and selected graphic formats.
- **MusicMatch® Jukebox**—record, organize and play digital music on your desktop PC.



Please Note: Software is available in English language versions only—please refer to the HP Jornada Web site for conditions of usage and support that apply.

At the Jornada Web site, you will also find links to extensive H/PC resources on the Web, and information on a wide variety of accessories and programs for your HP Jornada.

You can visit the HP Jornada Web site by simultaneously pressing the  key and the  hot key (the Internet Explorer  hot key).



*(Please note: When using Internet Explorer, you may encounter a splash screen or an IE favorite labeled for the **HP Jornada 720**, even if this is not the model you own. These links will connect you to the **HP Jornada Web site** where you can quickly access the online resources for your particular model.)*

Many other useful programs are available from the Hewlett-Packard Web site at www.hp.com/jornada. Hewlett-Packard does not support the use of programs that have not been certified by Microsoft.

Typically, you install software to your H/PC by first loading the installation files onto your desktop PC, as described in the following procedure.

If a program is designed for direct installation, you may be able to download or install the program from the Web to your HP Jornada. The software developer's Web site should provide instructions for installing the program.



To install software

1. Look for programs that are compatible with the HP Jornada's StrongARM SA111X processor.

Be sure to choose only programs that have been designed for your HP Jornada's StrongARM SA111X processor.



2. Download the program to your desktop computer
—or—
insert the CD or floppy disk that contains the program.
 3. Connect your device and desktop computer.
-

4. Double-click the *.exe file.

If the program includes an installer program (typically named Setup.exe or Install.exe), double-click the installer program on the desktop PC and installation wizard will begin. Follow the directions on the screen. Once the software has been installed on your desktop computer, the installer will automatically transfer the software to your device.

If the program does not have an associated installer or setup program, drag the program file (typically an *.exe file type) to the My Handheld PC icon in the Mobile Device window.

5. If prompted by the installer, perform a soft reset of your H/PC. For more information, see the **Resetting** section in chapter 8.



Install software by dragging the program file to the Mobile Device window only if no installer program is available. Software installed in this way may not appear on the **Remove Programs** list, and you may have to manually delete the program if you wish to remove it from your HP Jornada

After you have installed a program on your HP Jornada, you can use the ActiveSync **Add/Remove Programs** tool to remove the program or to reinstall the program after it has been removed. If you do not have enough storage memory on your HP Jornada, you may want to use **Add/Remove Programs** to temporarily remove programs you no longer use or programs that you use infrequently.

To add or remove programs with Add/Remove Programs

1. Connect your HP Jornada to your desktop PC, and then open the ActiveSync window.
 2. On the **Tools** menu in the ActiveSync window, click **Add/Remove Programs**.
 3. In the list of programs, activate the check box next to the program you wish to install. –or– Clear the check box of the program you want to delete.
 4. If the program you want to remove is not shown on the list, you must remove it manually.
-

Removing programs

You can use either Add/Remove Programs (on your desktop PC) or the Remove Programs control panel (on your HP Jornada) to remove programs.

To remove a program from your HP Jornada with the Remove Programs control panel

1. On the **Start** menu, point to **Settings**, and then tap **Control Panel**.
2. Double-tap the **Remove Programs** icon.
3. In the **Programs** list, select the program you want to remove.
4. Tap **Remove**.

Programs stored in ROM cannot be removed. (For a list of these programs see the **HP Jornada programs** section in chapter 1.)



Adding fonts

Your HP Jornada comes with a selection of built-in fonts. You can add Windows fonts (.fon files) or TrueType fonts (.ttf files) to your HP Jornada for use in Pocket Word documents and Pocket Excel spreadsheets. Because fonts take up a significant amount of storage memory, install only the fonts you need, and delete those you do not need. (The built-in fonts cannot be deleted.)

To add fonts

1. Connect your HP Jornada to a desktop PC, and then start Microsoft ActiveSync.
 2. In Windows Explorer on the desktop PC, select the font files you want to copy.
 3. Drag the font files to the Windows\fonts folder on your HP Jornada. If you are copying a Windows font, you will be prompted to select the point sizes and styles you want to copy.
-

Adding sounds

Your HP Jornada can play Wave sounds (.wav files). You can copy a sound file from your desktop PC to your HP Jornada without converting the file. If you want to use a sound as part of a sound scheme or to signal an alarm or a reminder, copy the sound file to the Windows folder on your HP Jornada. For more information, see the **Setting Alarms** topic in online Help.

Adding desktop wallpaper

Your HP Jornada can display 65,536-color bitmap images (.bmp files) or MS Windows for H/PC 2000 bitmaps (.2bp files). You can copy bitmap images from your desktop PC to your HP Jornada without converting the files, and you can use these images as desktop wallpaper on your MS Windows for H/PC 2000 desktop.

To add desktop wallpaper

1. Connect your HP Jornada to a desktop PC and start Microsoft ActiveSync.
2. Drag the bitmap image you want to copy from its location on your desktop PC to the My Handheld PC icon in the Mobile Device window.
3. On your HP Jornada **Start** menu, point to **Settings**, and then tap **Control Panel**.
4. Double-tap the **Display** icon.
5. On the **Background** tab, tap **Browse**, and then select the bitmap file to display as your background.

Accessories

The following optional accessories also are available from Hewlett-Packard. (HP item numbers are listed in parentheses.) Check the Hewlett-Packard Web site at www.hp.com/jornada for updates to this list.

- Serial sync cable (HP F1258A)— Connect your HP Jornada to a serial communications port on a desktop PC running Windows NT, Windows 95/98, or Windows 2000.
 - Docking Cradle (HP F1822A)—Instantly connect to your PC partner via serial port (running Windows NT, Windows 95/98,
-

or Windows 2000) or USB port (Windows 98 and Windows 2000 only). Includes serial sync cable and USB cable.

- ac Adapter (HP F1279B)— Connect to ac power anywhere in the world with this World Wide Voltage adapter
- Standard Battery (HP F1281A)—Rechargeable Li-ion battery pack provides up to 9 hours of battery life (depending on usage)
- Extended Battery (HP F1840A)— Rechargeable, extra capacity Li-ion battery pack provides up to 24 hours of battery life (depending on usage)
- External Charger (HP F1841A)— Allows simultaneous charging of your HP Jornada and an additional battery (additional battery available separately).
- Leather case (HP F1227A)—Protects your HP Jornada in style
- Parallel printer cable (HP F1274A)—Allows connection to PCL3 printers. (For a list of recommended printers, see the HP Web site www.hp.com.)
- HP VGA out card (HP F1252A)—Enables you to connect your HP Jornada to an external monitor or projector for presentation
- Serial adapter (HP F1295A)—Provides a standard 9-pin mechanical interface
- Stylus Pen (HP F1842A)—Replacement for lost or damaged stylus

Using PC Cards, CompactFlash Cards, and Smart Cards

PC Cards, CompactFlash Cards and Smart Cards provide a wide range of additional functionality, such as additional memory, removable storage, connection to an external monitor, connection to a network, or data security and user authentication. For a list of recommended compatible cards, go to the HP Jornada Web site at www.hp.com/jornada.

Before you can use a particular card, you may need to install the software driver for that card. Drivers for the MS Windows for H/PC 2000 operating system should be included with the card or available from the card's manufacturer. Install software drivers as you would any other software. For more information, see the **Installing programs** section in this chapter.



Non-memory CompactFlash Cards that require a cable connection (i.e. network interface cards, pagers, or modem cards), must be inserted in the PC Card slot rather than the CompactFlash Card slot. To do this, you will need a PC Card adapter. For a list of recommended PC Card adapters, go to the HP Jornada Web site at www.hp.com/jornada.

Installing a PC Card, CompactFlash Card or Smart Card

The HP Jornada accommodates PC Cards, CompactFlash Cards and Smart Cards separately or in combination.



Many PC Cards use considerable power, and can quickly drain your battery. Connect to ac power while using PC Cards.

PC Card and CompactFlash memory modules appear as folders in the My Handheld PC folder. If you have two cards installed, the folders are displayed in the order they were inserted. In some cases, additional folders may appear. You can eliminate unused folders by performing a soft reset. (For more information, see the **Resetting** section in chapter 8.)

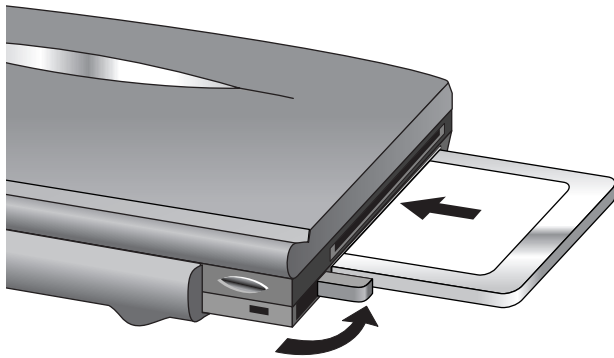

PC Card insertion on the HP Jornada, with extended release tab indicated by curved arrow

Using PC Cards, CompactFlash Cards, and Smart Cards

The HP Jornada is equipped with a PC card slot, a CompactFlash Card compartment, and a Smart Card reader slot that make it incredibly expandable and versatile. You can install either a PC Card, CompactFlash Card, or Smart Card, or install all of them at the same time.

PC Card

The PC Card fits in the slot on the left side of the HP Jornada.

To install a PC Card

- Carefully slide the card into the PC Card slot face up.

To remove a PC Card

1. Press the PC Card release tab. Do not obstruct the slot opening. The PC Card will be pushed out of the slot slightly.
2. Grasp the PC Card and pull it completely out of the slot. When using thicker PC Cards (for instance PCMCIA I/O Cards), you may initially feel some slight resistance when pulling out the card.
3. Fold the PC Card release tab back into the side of the device.

Smart Card

The Smart Card fits in the slot on the left side of the HP Jornada just above the PC Card slot.

For the information about Smart Card applications for your HP Jornada, go to the HP Jornada Web site at:
www.hp.com/jornada



To install a Smart Card

- Carefully slide the card face down into the Smart Card reader slot.
-

To remove a Smart Card

- Grasp the Smart Card firmly and pull it gently out of the Smart Card reader slot.

CompactFlash Card

The CompactFlash Card slot door is located on the bottom of the unit, near the stylus slot. Slide the latch in the direction of the arrow printed on its face to open the door.

To install a CompactFlash Card

1. Slide the CompactFlash Card slot door latch in the direction of the arrow with your finger. The door will spring open.

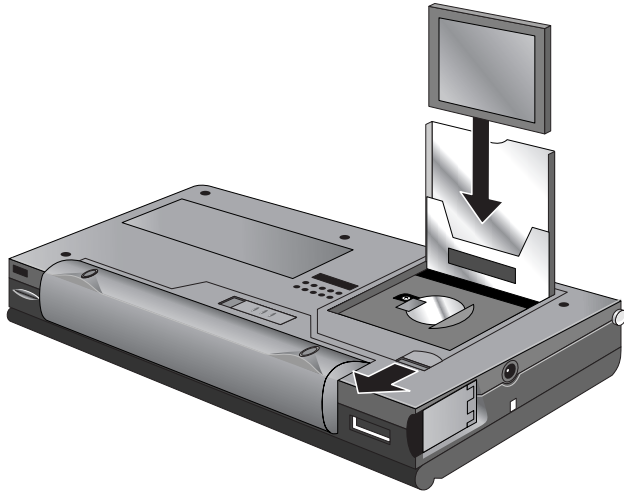

2. Slide the CompactFlash Card into the slot, pressing the card gently but firmly until it snaps into place in the slot.



The CompactFlash card can only be inserted in the slot one way, connector edge inserted first, with the finger pull (raised edge) of the card exposed on the closing side of the door.

3. Close the CompactFlash Card slot door by pressing it down until it clicks into place.
-

To remove a CompactFlash Card

1. Slide the CompactFlash door latch in the direction of the arrow with your finger. The door will spring open.
2. Grasp top edge of the card, holding the finger pull (raised edge) firmly between your fingers, and gently pull the card from the slot.
3. Close the CompactFlash Card slot door by pressing it down until it clicks into place.

Do not use excessive force installing or removing a PC Card, Smart Card or CompactFlash Card.



Managing memory

The memory on your HP Jornada is allocated between storage memory and program memory. You can specify how much of the total memory is used for storage and how much is used for running programs. If you notice that your HP Jornada is running slowly or that your programs do not run consistently, try increasing program memory. If you need more memory for files and documents, increase storage memory.

To adjust memory allocation

1. Exit any applications that are running.
2. On the **Start** menu, point to **Settings**, and then tap **Control Panel**.
3. Double-tap the System icon.
4. On the **Memory** tab, move the slider to the left to increase program memory, or move the slider to the right to increase storage memory.

You may be able to make more memory available by refreshing your system memory.

To refresh your system memory

1. Close all open documents and exit any applications that are running.
-

2. Use the stylus to press the reset button on the left side of the keyboard, performing a soft reset. (For more information, see the **Resetting** section in chapter 8.)

The Recycle Bin on your HP Jornada desktop works in the same way as the Recycle Bin on your desktop PC. When you delete a file on your HP Jornada, the file is moved to the Recycle Bin. It is not actually removed from memory until you empty the Recycle Bin.

You can set options that limit the amount of memory reserved for the Recycle Bin or to bypass the Recycle Bin and delete files immediately.

To set Recycle Bin options

1. Press the  key as you tap the **Recycle Bin** icon.
2. On the pop-up menu, tap **Properties**.

Tips for conserving memory

- Synchronize only one or two weeks of Calendar data and only selected Contacts or Tasks. (For more information, see the **Synchronizing selected data** section in chapter 3.)
- Set options in Inbox to download only message headers and not to download attachments. (For more information, see the **Using Inbox** section in chapter 6.)
- Use Application Manager to remove programs you do not need (see the **Installing programs** section in this chapter).
- Remove fonts, sounds, and wallpaper you do not need.
- Delete files and voice memos you do not need, or transfer them to your desktop PC for storage and delete them from your HP Jornada.
- Clear the cache in HP Chai VM, removing unneeded temporary files to free up storage memory. (See **Clearing the HP ChaiVM cache** in chapter 6 for detailed instructions.)



You can increase the storage memory by adding a memory module on a CompactFlash or PC card. For more information, see the Accessories section in this chapter.

Managing battery power

Because the data you save on your HP Jornada is stored in RAM, it is extremely important that you maintain a continuous power supply to your HP Jornada at all times. If your HP Jornada loses power, all information you have entered will be lost. The MS Windows for H/PC 2000 operating system and programs are stored in ROM, and cannot be erased; however, any programs you have added and custom settings in existing programs will be lost.

Data stored on a PC Card or CompactFlash Card will be saved, even if your H/PC loses power. To protect your data, back up regularly to a PC Card or CompactFlash Card with HP backup..



HP Jornada uses two types of batteries. The main battery supplies power whenever your HP Jornada is not connected to ac power. The backup battery protects your data when the main battery is not installed (for instance, while you exchange the main battery).

Main battery

The main battery is the HP Jornada Standard Battery, a rechargeable lithium-ion battery pack. Use only the HP Jornada Standard Battery (HP F1281A) or the HP Jornada Extended Battery (HP F1840A) with your HP Jornada. These batteries are designed only for use with the HP Jornada and should not be used to power other devices.

Under normal circumstances, the main battery will provide up to 9 hours of continuous use without recharging. Actual battery life will vary depending on screen brightness, what applications you use, and operating conditions. When the main battery runs very low, your HP Jornada will shut down, and you will be unable to restart it until you replace the main battery, recharge the battery, or connect to ac power.

When you replace the main battery, your new battery must be charged before your HP Jornada will turn on. For information on charging the main battery, refer to the **Connecting the ac adapter** section in chapter 2.



Ensure that the backup battery is in good condition before you remove the main battery. If the backup battery is low or you are not sure, connect to ac power before you remove the main battery.

To replace the main battery

1. Turn off your HP Jornada and disconnect the serial sync cable if it is attached, or remove it from the docking cradle (optional on the HP Jornada 710).
2. Slide the battery release tab on the bottom of the HP Jornada and hold it in the open position while pulling the battery pack away from the device.
3. Insert the replacement battery pack and push firmly until it clicks into place.

Backup battery

The coin-sized, lithium ion backup battery does not provide enough power to operate your HP Jornada. It is intended only to protect your data until the main battery is recharged (up to a week if the coin-cell battery is in good condition). When a low battery warning message is displayed, immediately charge the main battery to avoid data loss.



Ensure that the main battery is charged before you remove the backup battery. If the main battery is low or you are not sure, connect to ac power before you remove the backup battery.

To replace the backup battery

1. Turn the Jornada upside-down and open the CompactFlash door.
2. Pivot the backup battery cover out of the way to completely expose the backup battery.

The backup battery is under some spring tension. As you attempt to remove it, cover the battery with your fingers to prevent it from flying out of the compartment.

3. With the stylus or some other small, blunt tipped instrument, gently pry the backup battery out of the
-

compartment. (Be careful not to damage the stylus or the battery compartment.)

- 4 Make sure that the backup battery cover is open and insert the replacement battery **printed side up** into the battery compartment.
- 5 Close the backup battery cover to secure the battery, then close the CompactFlash door.

The backup battery cover is designed to be easily opened and closed with the tip of the stylus. Just insert the tip in the small hole to quickly pivot the cover open or closed.



Be sure to **close the backup battery cover before closing the CompactFlash door** in order to avoid damaging these components.

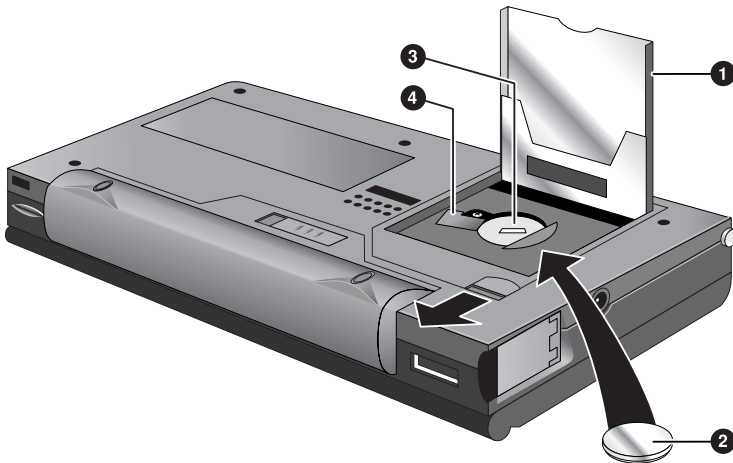

Installing the backup battery

- 1 CompactFlash door shown open
- 2 Coin-cell 3V CR2032 backup battery
- 3 Backup battery compartment
- 4 Backup battery cover in open position



Do not mutilate, puncture, or dispose of batteries in fire. The batteries can burst or explode, releasing hazardous chemicals. Replace batteries with only the types recommended in this User's Guide. Discard used batteries according to the manufacturer's instructions.

Using the Power control panel

Use the Power control panel to check the status of your main and backup batteries and to set options that can increase battery life. These include setting options for auto-suspend, power on, and setting controls to automatically dim or turn off the display.

To open the Power control panel



- On the **Start** menu, point to **Settings**, tap **Control Panel**, and then double-tap the **Power** icon.
–or–
Double-tap the power status icon in the status area of the taskbar.



The power status icon appears in the taskbar only under certain conditions, such as when battery power is low or when your HP Jornada is connected to external power and charging the main battery.

Checking battery status

The power area in the Power control panel indicates whether your HP Jornada is running on battery power or connected to ac power, and displays the status of both the main and backup batteries. In addition, the battery icon in the status area of the taskbar indicates whether the HP Jornada is operating on ac or battery power and displays the status of the main battery:

Icon	Indicates
	Running on ac power
	Main battery charging



Running on battery power, main battery low



Backup battery low



Backup battery very low

It is important that you respond immediately when a low battery power warning is displayed. When the main battery is low, simply connect the HP Jornada to ac power to recharge. (You can use your HP Jornada while the battery is charging.) When the backup battery is low, replace it as soon as possible. It is recommended that you back up your data and run the HP Jornada only on ac power until you have replaced the backup battery.



Conserving battery power

Under normal circumstances, the HP Jornada Standard Battery should provide up to 9 hours of continuous use; however, certain tasks require more battery power and deplete the main battery faster. Follow these tips to maximize battery life.

Setting auto-suspend

To conserve battery power, MS Windows for H/PC 2000 will automatically turn off or suspend your HP Jornada after a period of continuous idle time.

To set or shorten auto-suspend time

1. On the **Start** menu, point to **Settings**, tap **Control Panel**, and then double-tap the **Power** icon.
–or–
Tap the HP settings hard icon, and then tap the battery icon.
 2. On the **Power Saving** tab, under **While on battery power and no user input**, next to **Auto-suspend after**, adjust the number of minutes before auto-suspend occurs.
-

The default idle time is 3 minutes. To change the idle time, select a number from the list. Increasing the idle time may decrease your battery life.



The HP Jornada uses Intelligent Power Management to automatically power off after an extended period of inactivity, and to detect and warn you about active connections when powering off

Setting power on option

You can also set your HP Jornada to automatically turn on when you touch the screen.

To set the power on option

1. On the **Start** menu, point to **Settings**, tap **Control Panel**, and then double-tap the **Power** icon.
–or–
Tap the HP settings hard icon, and then tap the **battery** icon on the **HP settings** window.
2. On the **Power On** tab, select **Touch screen to Power On**.

Setting the Jornada display to automatically dim or turn off

Dimming or shutting off the display on your HP Jornada will help conserve battery power. Use the **Power Saving** tab of the Power Properties dialog to set options for automatically dimming while on battery power, or shutting off the display when system processes that are running (e.g. playing music or an Internet Connection) will not allow your Jornada to auto-suspend.



The option to turn off the display when the Jornada cannot auto-suspend is selected by default.

To set automatic dimming

1. On the **Start** menu, point to **Settings**, tap **Control Panel**, and then double-tap the **Power** icon. The Power Properties dialog will appear.
-

2. On the **Power Saving** tab, under **While on battery power and no user input**, select the **Dim display after** check box.
3. Select a time interval from the list box at the right to set how long your HP Jornada must be idle before the display is dimmed.
4. Click OK to save your settings and exit.

To set or disable the display off option

1. In the Power Properties dialog, on the Power Saving tab, select the **Turn off the display when system cannot auto-suspend due to active system processes** check box. (To disable the display off option, uncheck the box.)
2. Click OK to save your settings and exit.

Other tips for conserving battery power

- **Reduce the brightness of the display**—Compensate for low light by increasing the contrast. (See the **Using the HP settings application** section in this chapter.) Use the Power control panel to set the auto-dimming feature.
 - **Turn off the display manually**—To save battery power when connected to your desktop PC, use the alt +  hot key combination to manually turn off the display without waiting for the automatic display-off feature.
 - **Suspend frequently**—Use the Power control panel to shorten the length of continuous idle time before your HP Jornada auto-suspends. Press the On/Off key or tap **Suspend** on the **Start** menu to turn off your HP Jornada when it is not in use, even for a short time.
 - **Always use ac power when connecting your HP Jornada to your desktop PC**—Note that your HP Jornada will not auto-suspend while it is connected.
 - **Turn off sounds**—Use the HP settings application to mute the HP Jornada speaker, or use the Sound & Volume control panel to turn on only the most necessary system sounds.
 - **Avoid using PC Cards while on battery power**—Some PC Cards (especially PC Card modems) use considerable power and will quickly drain your battery.
-



Use the ac adapter to plug your HP Jornada into external power whenever possible, especially when connecting to a desktop PC, when using a PC Card modem, network interface card (NIC), or other peripheral. Do not let the alarm notification LED flash for a long time.

Fine-tuning performance

This section offers information that will help you customize your HP Jornada to match your working style.

Setting general options

As on your desktop PC, use Control Panel to change most of your HP Jornada options.

To open Control Panel

- On the **Start** menu, point to **Settings**, and then tap **Control Panel**.

Double-tap any of the icons in Control Panel to explore the options for that feature. Specific Control Panel options are described below. For more information about a particular control panel, see the **Settings** topic in online Help.

- **Communications**—Use the Communications control panel to set options for establishing a connection between your HP Jornada and desktop PC.
 - **Dialing**—Use the Dialing control panel to manually create dialing locations and set dialing options for connecting to a service provider or remote computer.
 - **Display**—The Display control panel allows you to set the background image and the appearance of your MS Windows for H/PC 2000 desktop.
 - **HP hot keys**—Use the HP hot keys control panel to customize your HP Jornada hot keys and hard icons. For more information, see **the Customizing the HP hot keys and hard icons** section in this chapter.
 - **HP security**—Set primary and reminder password protection to control access to your HP Jornada, and use the security log to record access attempts.
-

- **Internet Options**—Contains controls for browser settings including connection and auto-dialing, Internet security levels, default home and search pages, cache settings and history settings.
 - **Keyboard**—The Keyboard control panel allows you to set options for how quickly characters repeat when you hold down a key on your HP Jornada keyboard.
 - **Network**—Use the Network control panel to configure your network interface cards and drivers, and to type your user name and password for connecting to a network.
 - **Owner**—The Owner control panel allows you to store personal information, such as your name and address, and to choose whether to display this information each time you turn on your HP Jornada.
 - **Power**—The Power control panel is the place to check the condition of your batteries and set options that can conserve battery power. For more information, see the Managing battery power section in this chapter.
 - **Regional Settings**—The Regional Settings control panel allows you to set the format for time, date, numbers, and currency based on your geographic region. Choose from preset schemes or set individual options.
 - **Remove Programs**—The Remove Programs control panel is the best way to delete or uninstall programs you no longer use.
 - **Socket LP-E/EIO**—Control panel allows you to check network IP information and control status icons, program launching and ethernet driver delay settings for use with Socket LP-E/EIO LAN PC cards.
 - **Stylus**—The Stylus control panel enables you recalibrate the stylus or to set options for double-tap speed and area.
 - **System**—The System control panel displays information about the hardware and software configuration and enables you to adjust the allotment of program memory and storage memory.
 - **Volume & Sounds**—The Volume & Sounds control panel allows you to set the speaker volume and turn on and off the sounds associated with different system events. You can save your options as a sound scheme, just as you do with Windows 95/98.
-

- **World Clock**—The World Clock control panel allows you to set the system time, set alarms and reminders, and select your Home and Visiting cities. World Clock also displays almanac information, such as the nearest airport, sunrise and sunset times, and travel distance between selected cities.







To open the World Clock control panel, double-tap the clock in the status area of the taskbar.

Customizing the HP hot keys and hard icons

The HP hot keys (on the top row of the keyboard) and the HP hard icons (along the right edge of the screen) give you one-touch access to your favorite programs. Simply press a hot key or tap a hard icon to open the corresponding program.

Use the HP hot key application to assign any program or file on your HP Jornada to one of the hot keys or hard icons.

Icon	Indicates
	Open HP settings
	Open HP backup
	Open HP dialup
	Open Windows Media Player

HP hard icon default program assignments



To start the HP hot keys application

- On the **Start** menu, point to **Programs**, point to **HP Utilities**, and then tap **HP hot keys**.

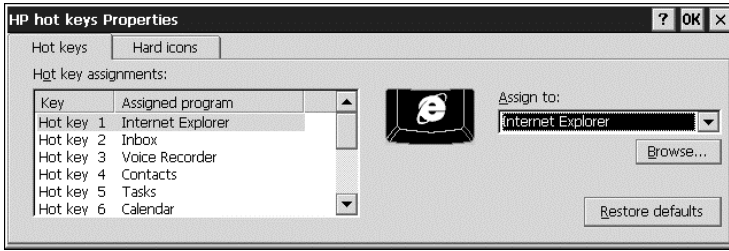

When you start the HP hot keys application, the current hot key assignments are displayed in a list on the **Hot keys** tab. The default key assignments correspond to the program icons printed on the HP hot keys.

You can also customize the hot keys to fit your personal preferences by assigning different programs or files to each hot key or hard icon

To assign a program or file to a hot key or hard icon



1. Start the HP hot keys application.
2. On the **Hot keys** tab or the **Hard icons** tab, select the key or icon you want to change.
3. Under **Assign to**, select a program from the drop-down list.
–or–
Tap **Browse** to select a program or file that is not displayed. (Certain files or programs will not run when invoked by a hot key or hard icon.)
4. Tap **OK** to save you new settings and close the HP hot keys application.

To see which programs are currently assigned to the HP hard icons, tap and hold any hard icon. A pop-up window shows the current hard icon assignments.



To restore the default hot keys or hard icons, which correspond to the icons printed on the keys or the screen, tap **Restore defaults** on the **Hot keys** tab or the **Hard icons** tab.

Using the HP settings application

The HP settings application allows you to change or adjust display and sound settings and allows you to check the status of constantly changing information about your HP Jornada at a glance, such as available memory and battery power.

To open HP settings

- On the **Start** menu, point to **Programs**, point to **HP Utilities**, and then tap **Settings**.
–or–
Press the **HP settings**  hard icon.

Setting brightness and contrast.

The **Display Profiles** tab includes slider controls for brightness and contrast, and buttons to select saved settings profiles. Move the sliders to adjust the display settings to a comfortable level.

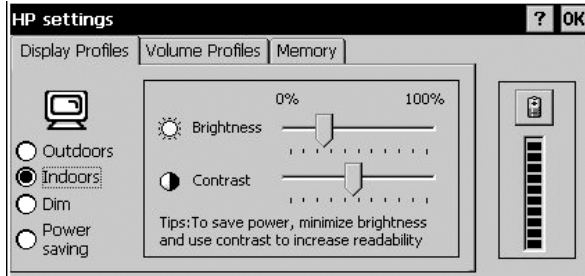

Setting volume levels.

The **Volume Profiles** tab includes slider controls for audio volume and modem volume, and buttons to select saved volume settings profiles. Move the sliders to adjust the volume settings to a comfortable level.

The modem slider is available only on HP Jornada models with built-in modem; the modem volume slider is not functional on



non-modem versions of the HP Jornada.

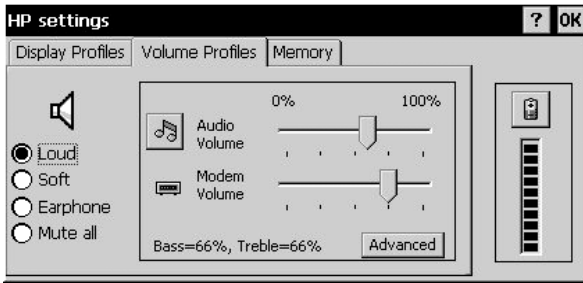

On the Volume Profiles tab, tap  to open the Volume & Sounds Properties dialog box.



Setting bass and treble levels

On the Volume Profiles tab, the current bass and treble levels are shown as percentages. To adjust the bass and treble settings, press the Advanced button. In the Bass/Treble Settings dialog, use the slider controls to adjust the bass and treble settings to the desired level.

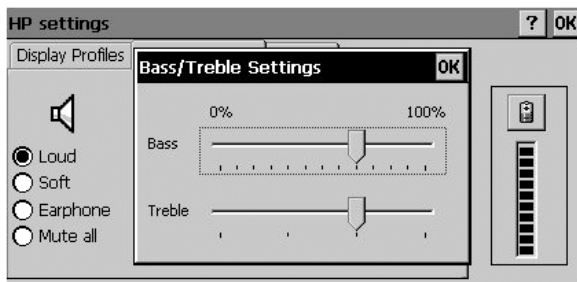

Customizing HP settings profiles





Your HP Jornada has four preset HP settings profiles on both the **Display Profiles** and **Volume Profiles** tabs. You can launch any profile on either tab by selecting it. You can also adjust any of the settings in any profile to suit your preference.

To change HP settings profiles

1. On the **Start** menu, point to **Programs**, point to **HP Utilities**, and then tap **Settings**.
—or—
Press the **HP settings**  hard icon.
2. On the either the **Display Profiles** or the **Volume Profiles** tab, select the profile you want to change.
3. Adjust the **brightness** and **contrast** sliders to your preference,
—or—
adjust the **audio volume** and **modem** volume (only on HP Jornada models with built-in modem) sliders to your preference.
4. Tap **OK** to exit and save your settings.



Changing HP settings profiles

To quickly change the current display or volume profile:

- Press the  +  hot key combination to choose a different display profile.
—or—
- Press the  +  hot key combination to choose a different volume profile.



Alt hot keys are indicated by blue icons stenciled above the three left-hand hot keys on the HP Jornada keyboard, immediately below the display panel. To activate them, hold down the  key and press any of the hot keys listed in the table below.

Icon	Indicates
	Open HP Jornada Home Page
	Open Display profile selection menu
	Open Volume profile selection menu

HP Jornada Alt hot key icons

Displaying power and memory information

The **HP Settings** window also displays the power status of your main battery. The **Memory** tab shows the available Program memory, Storage memory, and Storage Card memory.

On the **Memory** tab, tap  to start the **System Properties** dialog,
—or—



at any time in the **HP settings** window, tap  to display the **Power Properties** dialog.

Security

This section provides some tips to safeguard your HP Jornada—and the data it holds—from theft or loss.

Adding owner information

If you lose your HP Jornada, owner properties can provide an easy way for someone to identify you as the rightful owner and return your HP Jornada. You may have entered your name and address as part of the MS Windows for H/PC 2000 Welcome Wizard. If you did not, or if you want to update your information (for example, to include the address of the hotel or office you are visiting), use the Owner control panel.

To add or change Owner properties

1. On the **Start** menu, point to **Settings**, and tap **Control Panel**.
 2. Double-tap the Owner icon.
 3. On the **Identification** tab, type your name, address, and/or phone number.
 4. On the **Notes** tab, type any other information you want displayed (for example a temporary
-

address or to offer a reward for the safe return of your HP Jornada).



To display your owner properties information each time you turn on your HP Jornada, on the Identification tab under At Power On, select the **Display Owner Identification** check box.

HP security control panel

Use the **HP security** application to prevent unauthorized access to your HP Jornada and to protected the confidentiality and integrity of your important data.



Using **HP security** you can:

- Set a password to control access to your HP Jornada and protect your data.
- Set a reminder password to gain access to your HP Jornada if you forget your primary password.
- Use the security log to record any attempts to access data on your HP Jornada.



Caution: If you forget both your primary and reminder passwords, you may be unable to access your HP Jornada until you perform a factory default reset, erasing all information you have saved. For more information, see the **Resetting** section in chapter 8.

To start HP security

- On the Start menu, tap Settings, tap Control Panel, then double-tap the HP security icon.

—or—







On the Start Menu, tap Programs, tap HP Applications, then tap HP security.

Setting a Primary Password

Use the Primary tab to set your primary password, and enable primary password protection. With primary password protection enabled, you must enter your password each time you start your HP Jornada or open the HP security application.

To set a primary password and enable primary password protection:

1. On the **Primary** tab, tap the **Primary Password** text input box and type the password of your choice. (A password may contain up to 40 case-sensitive, alpha-numeric characters.)
2. Tap the **Confirm** text input box and type the password you have chosen again.
3. Select the **Enable Primary Password Protection** check box to activate password protection.
4. Click OK to exit and save your settings.

Passwords are alpha-numeric and case-sensitive. Be sure to deactivate the **numeric keyboard** ( + ) and/or **capslock** ( + ) before setting or entering your password. Keystrokes may not be recognized as you intended if either of these   icons appear in the status area of the task bar. Use the key combinations shown above to deactivate these keyboard features before setting or entering your passwords. (See *Using the HP Jornada keyboard* in Chapter 2 for information about using the numlock and capslock keys.)



To disable primary password protection:

- On the Primary tab, tap the Enable Primary Password Protection check box to remove the check mark and disable password protection.



NOTE: Even with primary password protection disabled, you will be prompted for your password each time you open HP security unless you delete your password as described below.

To remove your primary password:

1. On the Primary tab, highlight the text (double tap) in the Password text input box, then press the delete key.
2. Double-tap the Confirm text input box and press the delete key again.
3. This will remove your password and you will no longer be prompted for your password when you open the HP security control panel.
4. Click OK to exit and save your settings.

Password Activation Delay

If you frequently turn your HP Jornada off for short periods of time to conserve power, set a password activation delay. When you turn your HP Jornada on again within the delay period, you will not be prompted for your password.



With a password delay set, you can use the  + "on/off" keys to shut down the system and enable password protection immediately, bypassing the delay.

To set a password delay:

1. Set your primary password.
2. On the **Primary** tab under **Activation**, select the **Delay password activation after suspend for** check box.
3. In the **minutes** input box, type the number of minutes you want password prompting to be delayed.
4. Click OK to exit and save your settings.

Setting a Reminder Password

Use the Reminder tab to set a reminder password, and enable reminder password protection. With reminder password protection enabled, you will be prompted to enter

your reminder password after a set number of failed primary password logon attempts.

To set and activate a reminder password:

1. On the **Reminder** tab, under **Reminder Password**, tap the **Question** text input box and type a question of your choice. (A password may contain up to 40 case-sensitive, alpha-numeric characters.)
2. Tap the **Answer** text input box and type the answer to the question in step one
3. Select the **Enable Reminder Password** check box.
4. In the **Prompt for Reminder Password after** box, enter the permitted number of primary password entry errors before you are prompted with the question for your reminder password.
5. Click OK to exit and save your settings.

Using the Security Log

Use the Log tab to record all attempts to access your HP Jornada, and any attempts to modify the password settings.

You can view the log on your HP Jornada or export it as a file to save, view or edit on your desktop PC.



To enable security logging:

1. On the **Log** tab, select the Enable logging check box.
 2. Entries appear in the table on the **Log** tab.
 3. To clear all entries, tap **Clear Log**.
 4. To export the log to a file, tap **Export Log**.
 5. Click OK to exit and save your settings.
-

Traveling with your HP Jornada

The compact size and portability of the HP Jornada make it the perfect traveling companion. With the synchronization and connectivity solutions of the HP Jornada, the power of your desktop computer is always at your fingertips, whether you are working from across town or from across the country.

Follow the tips in the sections below to make sure your trip goes smoothly.

What to take with you

Be sure to pack everything you need to use your HP Jornada:

- **ac adapter and power cable**—If you are traveling to a foreign country, be sure you also obtain an adapter for the plug on your power cable. Or, you may be able to buy a power cable for the country you are visiting in a local store or HP distributor.
- **Modem card and cable**—If you do not have an HP Jornada with internal modem, you'll need your PC Card modem* to connect to the Internet or dial in to your office.
- **Access numbers**—Check with your service provider or network administrator to find out if they provide local dial-up access. A local number can save plenty in long-distance charges.
- **Serial sync cable**—If you will connect to a desktop PC at your destination, pack the sync cable. You do not need to take a docking cradle.
- **Extra main battery (F1281A)**—Carry a spare in case you are stranded or unable to connect to ac power for a long period of time.
- **CompactFlash Card**—Protect your data while you travel by backing up to a CompactFlash Card.

* Modem purchased separately. Some Web sites/content may not be available.

Before you leave

Before you put your HP Jornada in your briefcase, take a few minutes to prepare, and your trip will run smoothly.

- **Identify your HP Jornada**—If you will be traveling for an extended period, update the owner properties to include your address or contact information at your destination.
 - **Synchronize**—Make sure your calendar, contacts, and tasks databases are up-to-date before you leave. Synchronize all items just before you back up and disconnect.
 - **Back up your data**—Perform a full backup to your desktop computer and to a PC Card or CompactFlash Card. Carry the storage card with you—if your HP Jornada loses power during the trip, you will be back up and running in no time. For more info, see the **Backing up** section in chapter 5.
 - **Charge batteries**—Make sure that your main battery is fully charged and that your backup battery is good. Use the Power control panel to check battery status, and connect to ac power if the main battery is low or replace the backup battery if it is low. For more information, see the **Managing battery power** section in this chapter.
 - **Lock the audio buttons to prevent inadvertent activation of Windows Media Player**—Slide the audio lock to the left, so the playback functions will not be activated by accident.
 - **Set your desktop computer to allow dial-in**—If you plan to dial in to your desktop computer or synchronize from your destination, make sure you prepare your desktop computer accordingly, and that no one will turn it off while you're away. For details on setting up your desktop computer for remote synchronization, see the **Synchronizing from a remote location** section in chapter 3.
-



8 | Troubleshooting

If you encounter difficulties while using your HP Jornada Handheld PC, this chapter will help you find answers. If you need information about troubleshooting Microsoft ActiveSync, click **Connection Settings** on the **File** menu, then click the help button.

The information in this chapter will help you:

- Maintain your HP Jornada in its best working order
- Troubleshoot basic problems
- Troubleshoot problems with remote connections
- Troubleshoot problems with the display
- Troubleshoot problems connecting by infrared
- Reset your HP Jornada

Maintaining your HP Jornada

When treated properly, your HP Jornada will be a reliable desktop PC companion. Follow these tips to ensure long and trouble-free use:

Keep the unit clean

Touching the HP Jornada screen with your hand will leave a trace of natural oil that may make it difficult to read the screen. To clean the screen, use a commercial glass cleaner sprayed on a soft cloth. Avoid spraying the screen directly.

Be sure to turn off your HP Jornada before cleaning the touch screen



Be careful not to get sand and dirt inside the unit. If you think your HP Jornada has sand or dirt inside the unit case, contact your authorized Hewlett-Packard dealer.

Follow general safety precautions

To keep your HP Jornada in good operating condition, follow these guidelines:

- Only open your HP Jornada case as far as the hinges allow.
- Do not use excessive force when inserting or removing CompactFlash Cards or PC Cards or when opening or closing the CompactFlash Card door.
- Always keep the cable attached while synchronizing with your partner PC until synchronization is complete.

Avoid damage

Be careful to keep your HP Jornada from being dropped, bumped, or crushed. Dropping or placing something heavy on top of your HP Jornada can cause damage to delicate components such as the display. Accidental damage is not covered under the Hewlett-Packard express warranty.

Avoid radiated interference

Radiated interference from other electronic equipment may affect the appearance of the display and the modem function of the HP Jornada. Removing the HP Jornada from the source of the interference will return the display and the modem function to normal.

Avoid high temperatures

Your HP Jornada is designed to operate at temperatures between 0 to 40 °C (32 to 104 °F) and to maintain data at temperatures between 0 to 55 °C (32 to 131 °F). Subjecting the device to temperatures outside this range may damage the unit or result in loss of data. Be especially careful not to leave your HP Jornada in direct sunlight or in a car where temperatures can rise to harmful levels.

Troubleshooting basic problems

If you have a specific problem, review the information below to see if you can quickly find the answer. Or, visit the HP Jornada Web site at www.hp.com/jornada for current information about common difficulties.

Problem	Diagnosis/Remedy
HP Jornada does not turn on when connected to ac power	<i>HP Jornada is locked up.</i> Connect the HP Jornada to external power, and perform soft reset . (See the Resetting section in this chapter. Caution: You will lose any unsaved data when performing a soft reset.)
HP Jornada does not turn on when not connected to ac power	<i>Battery power is too low to run device.</i> Connect to ac power, and then turn on your HP Jornada. (Charge the battery regularly to avoid running out of battery power.) For information on charging the main battery and checking battery status, refer to the Installing the main battery section in chapter 2.
Battery runs out of power very quickly.	You may be using your HP Jornada in ways that drain the batteries quickly. See the Managing battery power section in chapter 7.
HP Jornada does not auto-suspend when connected to a desktop PC or when using the modem.	The HP Jornada is designed to stay on while connected to a computer. This is the correct behavior. No action is needed. However, the device will go into display off mode to conserve battery power if there is no keyboard or touch screen input.

Problem

HP Jornada automatically shuts down/suspends.

Diagnosis/Remedy

Main battery is too low to run device. When a critically low-battery condition is encountered, the HP Jornada initiates a safety shutdown. Connect to ac power and charge the main battery. Do not remove the backup battery.

—or—

Auto-suspend activated. To conserve power, the HP Jornada auto-suspends if it is idle for 1 minute immediately after power is turned on. It also auto-suspends if it is continuously idle for 3 minutes.

—or—

HP Jornada is locked up. Connect the HP Jornada to external power, and perform **soft reset**. (See the **Resetting** section in this chapter. Caution: You will lose any unsaved data when performing a soft reset.)

HP Jornada locks up when running applications.

Program memory is low. For detailed instructions on making more program memory available, see the **Memory management** section in chapter 7.

—or—



HP Jornada is locked up. Connect to ac power and perform a soft reset. (See the **Resetting** section in this chapter.)

Note: Check battery power level regularly to ensure that the main battery is not running low on power.

Problem

HP Jornada does not turn on or display appears to be off, even though power is on.

Diagnosis/Remedy

The display contrast is too light.
Press   to increase contrast.
(For more information, see the **Using HP Settings** section in chapter 2.)

—or—

Your HP Jornada main battery is discharged. Connect to ac power and charge the main battery.

HP Jornada runs very slowly.

There is insufficient program memory or the memory needs to be refreshed. For detailed instructions on making more memory available, see the **Memory management** section in chapter 7.

You can add additional memory to your HP Jornada. See the **Accessories** section in chapter 7 for a list of accessories that will increase your HP Jornada memory.

—or—

Temporary files may have accumulated in HP ChaiVM, and you need to clear the ChaiVM cache.

To clear the cache in HP ChaiVM, on the Start menu, tap Programs, then tap HP Applications. Open **HP ChaiVM** and tap Options, then tap **Clear Cache**.

Problem

Insufficient memory error occurs when running an application.

Diagnosis/Remedy

HP Jornada has run out of program memory for the application.

For detailed instructions on making more program memory available, see the **Memory management** section in chapter 7.

—or—

HP ChaiVM is enabled in Internet Explorer, consuming a minimum of 16MB of program memory.

Using the **System** control panel, adjust the memory settings to increase available program memory (see Memory Management in chapter 7).

If you cannot sufficiently increase available program memory, disable the HP ChaiVM Internet Explorer plug-in. To do this, on the Start menu, tap Programs, then tap HP Applications. Open **HP ChaiVM** and tap Options, then remove the check mark to disable the ChaiVM IE plug-in. (See **Disabling HP ChaiVM in Internet Explorer** section in chapter 6.)

HP Jornada does not detect a PC Card.

PC Card is not inserted properly or drivers are not installed on your HP Jornada. Remove and re-insert the PC Card correctly. If this does not fix the problem, check the documentation for the PC Card for information on installing drivers. (For more information about compatible PC Card modems, see the HP Jornada Web page at www.hp.com/jornada.)

Problem

HP Jornada will not establish a connection with a desktop PC.

Diagnosis/Remedy

The HP Jornada is not properly seated in the docking cradle (optional on the HP Jornada 710), the serial sync cable is not connected properly to the PC or the HP Jornada, or communications are not configured correctly. Reconnect the cable correctly or see Microsoft ActiveSync Help for more information.

Backup file created with the HP backup application on another HP handheld device cannot be restored to the HP Jornada.

Only PIM data can be migrated to HP Jornada 700 Series. Because the HP Jornada 700 Series uses a newer operating system, it is recommended that you restore PIM data from an older device by using Microsoft ActiveSync or Microsoft Outlook rather than HP backup. Synchronize your older HP handheld device with Microsoft Outlook on your desktop PC, and then establish a new partnership to transfer data to your new HP Jornada.

While performing full restore from ActiveSync, a warning message appears stating that "Restore could not copy the file mdmlog6.txt to the device"

Select "Skip All". You should see a message that reads "Restore Complete".

Disconnect and then reset your device for the restore changes to take effect.

Problem

Unable to synchronize through USB port.

Diagnosis/Remedy

The wrong version of Microsoft ActiveSync is installed on your desktop PC. Ensure that you have installed the version of Microsoft ActiveSync included with your HP Jornada 700 Series.

–or–

*The USB connection is not enabled on your HP Jornada. On the **Start** menu, tap **Settings**, tap Control Panel, then double-tap the Communication icon. On the **PC Connections** tab, tap the **Change** button, and then select **USB connection** from the drop-down list.*

–or–

*The USB connection is not enabled in ActiveSync on your desktop PC. In ActiveSync, on the **File** menu, click **Connection Settings**, and then select the **Allow USB connection with this desktop computer** check box.*

The HP viewer seems to launch slowly.

*Contacts, Calendar, and Tasks databases are very big. Limit the size of your databases by synchronizing only selected contacts, appointments, and tasks. For more information, see the **Synchronizing data** section in Chapter 3.*

This only occurs the first time HP viewer is launched, or when HP viewer is launched after a soft reset.

Problem*Diagnosis/Remedy*

Sometimes appointments entries are not shown in HP viewer but can be viewed in Calendar

The appointment may not be updated real time in HP viewer after synchronization . Perform a soft reset to clear the cache and re-start the HP viewer.

HP Jornada will not send e-mail messages from Inbox.

Message header is too big. If your address list exceeds 32 KB, Inbox cannot send the message.

Data has been lost.

Your HP Jornada has lost power. Restore data from a backup file on your desktop PC or a CompactFlash card.

–or–

Factory default settings have been restored. Restore data from a backup file on your desktop PC or a CompactFlash card.

File attachments to e-mail messages are corrupted.

*Sender's or recipients' mail server does not support MIME encoding. Turn off MIME encoding. If you created your e-mail service using HP dialup, see **Creating and modifying connections** in chapter 6 for instructions on changing settings for the e-mail service. If you created your e-mail service in Inbox, tap Options on the Services menu to modify properties for the e-mail service.*

Problem

While printing multiple files, printing message box does not disappear after finished printing the first file.

Diagnosis/Remedy

There is insufficient program memory or the memory needs to be refreshed. For detailed instructions on making more memory available, see the **Memory management** section in chapter 7.

You can add additional memory to your HP Jornada. See the **Accessories** section in chapter 7 for a list of accessories that will increase your HP Jornada memory.

Some of the icons from the desktop disappear.

There is insufficient program memory or the memory needs to be refreshed. For detailed Instructions on making more memory available, see the **Memory management** section in chapter 7. You can add additional memory to your HP Jornada. See the **Accessories** section in chapter 7 for a list of accessories that will increase your HP Jornada memory.

It is difficult to install or run software from previous HP handheld devices on HP Jornada 700 Series.

Install software for StrongARM SA1100 or SA1110 SW processors only. Earlier versions of HP handheld devices (except for Jornada 820 series) use a different processor type. Software designed for other processor types is not compatible with the StrongARM SA111X family of processors.

Internet Explorer will not display a page with Java applets, or unexpectedly quits when trying to display them.

The Java applet may be consuming too much memory, causing Internet Explorer to behave erratically. Turn off the HP **ChaiVM** plug-in. On the Start menu, navigate to Programs / HP Applications / and open **HP ChaiVM**. Tap **Options** and uncheck the check box to disable the Internet Explorer ChaiVM

Inaccurate response to stylus tap.

plug-in. This will prevent the offending Java applet from trying to run.

The touch screen may need recalibration. To recalibrate the touch screen tap the **Start menu**, then **Settings**, then tap **Control Panel**, and then double-tap the **Stylus** icon. On the **Calibration** tab, tap the **Recalibrate** button and follow the prompts on the screen.

Troubleshooting remote connections

This section offers troubleshooting help for trying to connect your HP Jornada to other computers. For problems communicating with your desktop, see Microsoft ActiveSync Help.

Unable to dial out using the modem

- If you are using a PC card modem, verify that the modem is installed correctly and connected to a telephone line.
 - If you are using the internal modem (on models equipped with a built-in modem), verify that you are using an analog telephone line. (Most home telephone lines are analog, while most office telephone lines are digital.)
 - Verify you have set dialing properties for this connection correctly.
 - Check to see if the modem is waiting for a dial tone. To do this, on the **Start** menu, point to **Programs**, point to **Communication**, and then tap **Remote Networking**. Select your connection, and then tap **Properties** on the **File** menu. In the **Dial-Up Connection** dialog box, tap **Configure** and then tap the **Call Options** tab. Verify that **Wait for dial tone before dialing** is selected.
 - In certain countries you may have to clear the **Wait for dial tone before dialing** check box.
 - Allow more time for the call to go through if you are attempting to make an international call. On the **Call**
-

Options tab described in the previous step, clear the **Cancel the call if not connected within** option or increase the number of seconds allowed.

Able to dial out, but unable to make a proper connection

- Verify that the network you are attempting to connect with supports PPP (Point-to-Point protocol) or SLIP (Serial Line Internet Protocol).
- Verify that you have the correct dialing location selected. On the **Start** menu, point to **Settings**, tap **Control Panel**, and then double-tap the **Dialing** icon. Make sure that the location settings reflect your current location, that the dialing pattern for the location is appropriate, and that the local country and area code are correct.

Connection is unreliable

- Make sure the modem is firmly seated and connected to both your HP Jornada and the telephone jack.
- Disable call waiting. On the **Start** menu, point to **Settings**, tap **Control Panel**, and then double-tap the **Dialing** icon. Select **Disable call waiting by dialing** and enter the disable code specified by your telephone company.

Network connection is not listed in the ActiveSync dialog box

- Close the dialog box, wait a few minutes, and try again.
- Reset your HP Jornada. (See the **Resetting** section in this chapter.)

Infrared transfer between MS Windows for H/PC 2000–based devices

If you are unable to transfer information between H/PC 2000 devices by infrared, try the following.

- Transfer only one file, or no more than 25 contact cards, at a time.
-

- Position the infrared ports so that they line up and are less than 1 meter (3 feet) but more than 5 centimeters (2 inches) apart.
- Make sure nothing is blocking the path between the two infrared ports.
- Adjust the room lighting. Some types of lighting interfere with infrared communication. Try moving to a different location or turning off some lights.

Display

If you are having trouble viewing your data, here are some suggestions.

Screen is blank

If your HP Jornada fails to respond when you briefly press the On/Off button, be sure you have pressed the button firmly. If that does not work:

- Make sure the main battery is installed properly.
- Adjust the display contrast. On some devices, the screen can darken or lighten to the point that it appears to be turned off.
- Reset your HP Jornada. (See the **Resetting** section in this chapter.)
- Recharge the main battery.

Screen is dark

Prolonged exposure to direct sunlight may cause your HP Jornada screen to temporarily darken. This is a normal occurrence with LCD screens and is not permanent.

Resetting

Occasionally, you will need to reset your HP Jornada, for example, after you restore data from your desktop PC or when the operating system stops responding. There are two methods of resetting:

- **Soft reset**—A soft reset (also called “warm boot”) is similar to restarting your desktop PC. It restarts the operating system and preserves any saved data.
- **Factory default reset**—A factory default reset (also called “hard reset”) restores your HP Jornada to its original state, erasing all information you have entered.

To ensure the safety of your information in case a factory default reset is necessary, you should regularly back up your data to your desktop PC (using Microsoft ActiveSync) or to a CompactFlash or PC Card (using the HP Jornada backup application). For more information on backing up data, see the **Backing up and restoring data** section in chapter 5.



Soft reset

Perform a soft reset after restoring data from a backup file or when your HP Jornada appears to be frozen or locked up.

To perform a soft reset

1. Disconnect the sync cable and/or the telephone line from your HP Jornada, or remove it from the docking cradle (optional on the HP Jornada 710).
 2. Use the stylus to press the Reset button.
-

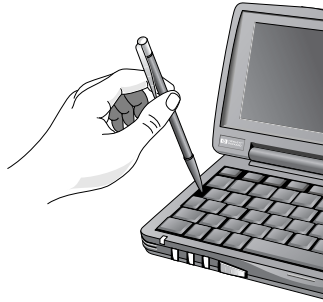

Using the stylus to perform a soft reset

When you perform a soft reset you will lose unsaved data in all open documents or programs.



Factory default reset

Perform a factory default reset only when your HP Jornada does not respond to a soft reset. A factory default reset will erase all data you have entered, including all files, system settings, and programs you have installed. If you have forgotten your primary and reminder passwords, you will also need to perform a factory default reset.

Performing a factory default reset erases all files, programs, and appointments you have entered. You can restore only data that has been backed up to your desktop PC or to a PC Card or CompactFlash Card. (For more information, see the **Backing up and Restoring data** section in chapter 5.)



To perform a factory default reset

1. Disconnect all cables, including the ac adapter from your HP Jornada.
 2. Remove the backup battery. For more information, see the **Replacing the backup battery** section in chapter 7.)
 3. Remove the main battery.
-

4. Wait at least 5 minutes, then reconnect the ac adapter, reinstall the main battery, and then reinstall the backup battery. (For more information, see the **Setting up your HP Jornada** section in chapter 2.) Your HP Jornada should turn on automatically and display the MS Windows for H/PC 2000 Welcome Wizard. For more information about this wizard, see the **Completing the Welcome Wizard** section in chapter 2.
 5. Restore data to your HP Jornada from your most recent backup file. For more information, see the **Backing up and Restoring data** section in chapter 5.
-

9 | Support and service

Web site

You can obtain product information as well as tips and hints on how to get more from the HP Jornada product at our worldwide Web site. This computer service is provided free of charge; you pay only for telephone charges and Internet service fees. To connect to this Web site from a computer via the Internet, go to www.hp.com/jornada.

Customer support

If you have questions that this User's Guide or the Web site does not answer (after checking the contents and index), you can contact Hewlett-Packard Worldwide Support and Services for Handheld Products at the telephone numbers listed in the following table.

If the device requires service, contact Hewlett-Packard for service information, shipping instructions, and out-of-warranty service charges before you send your device to HP for repair.

In countries not listed in the table, contact the Hewlett-Packard authorized dealer or sales office.

Service

For diagnostic instructions and other service information, contact one of the technical support numbers listed. Please do not ship your device for service without first contacting a Hewlett-Packard office. If your device qualifies for in-warranty service, be ready to supply a dated proof of purchase. In countries not listed in the following table, contact the Hewlett-Packard authorized dealer or sales office.

Before you contact us for help, be sure to:

1. Review the manuals whenever possible.
2. Have the following information about the product:
 - Model number
 - Serial number
 - Purchase date
3. Have your product ready to use. The support personnel may ask you to run tests and other operations.
4. Organize your question or problem. The more detailed information you can provide, the quicker the support personnel can help you.

Contacting Hewlett-Packard worldwide

You will be pleased to know that our commitment to quality does not stop at the sale. Our worldwide customer support network is available to give you personal telephone service should you need it.

Country/Region	Telephone
Argentina (Buenos Aires)	(5411)-4778-8380
Argentina (outside Buenos Aires)	0810-555-5520 Ext. 4778 / 8380
Australia	61-3-88778000
Austria	43-711-4201080
Belgium (Dutch)	32-2-6268806
Belgium (French)	32-2-6268807
Brazil (São Paulo)	11-3747-7799
Brazil (outside São Paulo)	0800-157751
Canada	1-905-2064663
Chile	56-800-360999
China	86-10-65645959
Czech Republic	420-2-61307310

Denmark	45-39-294099
Finland	358-20347288
France	33-1-43623434
Germany	49-1-805258143
Greece	30-1-6896411
Hong Kong	800-967729
Hungary	36-1-3430310
India	91-11-6826035
Indonesia	62-21-3503408
Ireland	353-1-6625525
Israel	972-9-9524848
Italy	39-2-26410350
Japan	81-3-33358333
Korea	82-2-32700700
Malaysia	60-03-2952566
Mexico (Mexico City)	52-58-9922
Mexico (outside Mexico City)	01-800-4720684
Netherlands	31-20-6068751
New Zealand	64-9-3566640
Norway	47-22-116299
Philippines	63-2-8673551
Poland	48-22-8659999
Portugal	351-13180065
Russia	7-095-9169821
Singapore	65-2725300
South Africa	27-11-8061030
Spain	34-91-7820109

Sweden	46-8-6192170
Switzerland (German)	41-1-4332728
Switzerland (French)	41-1-4332729
Taiwan	886-2-27170055
Thailand	66-2-6614000
Turkey	90-212-2245925
UK	44-870-6083003
USA	
Pre-sales Information	1-800-4431254 (toll-free, no operator is available)
Support & Service	1-970-635-1000 Palmtops & Organizers (toll call)
Venezuela (in Caracas)	58-2-207-8488
Venezuela (outside Caracas)	58-800-47-777
Vietnam	84-0-88234530

All Customer Care Centers are available during office hours. Pre-sales Information in the USA is available 24 hours per day, 7 days per week. Support & Service in the USA can be contacted from 5 AM to 5 PM Pacific Time, Monday through Friday.

Appendix A | Ergonomics

This chapter provides guidance and hints to help you work in a comfortable and ergonomically low-risk environment. If you experience pain or discomfort while using this or any other equipment, you should stop working and review this chapter. If the discomfort continues, stop using the equipment and consult a doctor as soon as possible.

Setting up and using equipment

Some people experience physical discomfort while using computers. Sometimes this discomfort leads to Repetitive Strain Injury (RSI), also known as cumulative trauma disorder or repetitive motion injury. Setting up and using equipment properly can help minimize this discomfort. Well-designed and properly adjusted equipment may not be sufficient to eliminate all potential problems. How you perform your computer activities is also important.

What is RSI?

RSI is a type of injury caused by the irritation or inflammation of soft tissues such as muscles, nerves, or tendons. In extreme cases, this irritation can lead to permanent tissue damage. RSI has been a documented problem for workers performing specific tasks such as assembly line work, meatpacking, sewing, playing musical instruments, and working with a computer. It may also result from other activities, such as tennis.

What causes RSI?

RSI is caused by certain demanding activities that exceed the body's ability. Common factors associated with RSI include too

many uninterrupted repetitions of an activity or motion, performing an activity in an awkward or unnatural posture, maintaining static posture for prolonged periods, failing to take frequent short breaks, and stress. Certain medical conditions, such as rheumatoid arthritis and diabetes, may contribute to RSI.

RSI symptoms

By following the guidelines on proper setup and use of equipment and work environment, the risk of developing RSI can be minimized. However, if you experience any discomfort, seek professional advice immediately. Typically, the earlier a problem is diagnosed and treated, the easier it may be to resolve.

Avoiding RSI

Recent literature suggests that there may be a relationship between injury to soft tissues, especially in the hands and arms, and the prolonged use of keyboards or other equipment requiring repeated motion of the hands and forearms. Literature also suggests that there are many other risk factors that may increase the chances of such soft-tissue injury. You can minimize the risk of suffering from RSI by following the guidelines detailed in this chapter.

Setting up your working environment

You must have enough space to move around and vary your position. To avoid eyestrain, the ceiling, walls, and floors should have a medium level of reflectance (approximately 75 percent of ceiling reflectance, 40 percent of wall reflectance, and 30 percent of floor reflectance). Try to avoid excessive contrast between the screen and its surroundings. The work environment should be as quiet and distraction-free as possible, with background noise below 58 dBA. Where possible, relative air humidity should be in the range of 40 to 60 percent. Recommended room temperature is 19 to 23 °C (66 to 73 °F). If possible, adjust the temperature to a comfortable level. The workplace should be well ventilated.

Pay attention to your posture; relax your shoulders and keep your wrists straight. This is easier when your keyboard can be positioned right under your hands while bending your elbows at

90°. Pull your chin in to look down, and try to lean back in the chair. The backrest should support you in the hollow of your back.

Reducing eye strain

Have your eyes checked on a regular basis and ensure your eyeglass prescription is suitable for working on a computer screen. Look away from the screen from time to time. Focus on distant objects briefly. Blinking periodically helps to lubricate the eyes.

Preventing muscle stiffness

Avoid holding your muscles tense for long periods of time. Keep your fingers and body relaxed. Changing tasks frequently helps prevent muscle stiffness. Alternating between typing, writing, filing, and moving around in your work environment helps to keep muscles loose.

Taking frequent short breaks

When you are required to work on your computer for prolonged periods of time, take short breaks frequently. As a general rule, a 5- and 10-minute break every hour is a good idea. It is better to take short breaks frequently than longer breaks less frequently. Data shows that people who work for long periods of time without a break are more prone to injury. Occasionally stretch the muscles in your hands, arms, shoulders, neck, and back. You should stretch at least once an hour.



Appendix B | Migrating data from other devices

Transferring data from a palm-sized, pocket or handheld PC

If you are currently using a Windows-powered palm-size or handheld PC, you can transfer data to your HP Jornada. If you have offline folders in Inbox on your palm-size or handheld PC that contain e-mail messages you want to transfer to your Pocket PC, you will have to follow a separate procedure, included below.

Transferring PIM data from an IrDA equipped palm-sized PDA device is easy with **HP info exchange**. See **Using HP info exchange** in chapter 4 of this guide.



To transfer data from another Windows-powered device

1. Install Microsoft ActiveSync 3.1 on your desktop PC. For information on installing ActiveSync, see the *Getting Started with Microsoft ActiveSync* booklet.
 2. Synchronize your device with your desktop PC, so that the information on your desktop PC is current.
 3. If you have files on your device that you want to transfer, such as Note Taker notes and recordings, turn file conversion off in ActiveSync options so that the files stay in device
-

format, and use ActiveSync Explorer to copy the files to your desktop PC. For specific instructions, see ActiveSync Help on the desktop PC.

4. Synchronize your HP Jornada with your desktop PC. This will update your HP Jornada with the current data from your desktop PC.
5. Reinstall programs. Check with the program vendors to find out if new versions that have been optimized for the HP Jornada are available.
6. Using ActiveSync Explorer, copy the files you transferred to your desktop PC in step 3 to your HP Jornada.
7. In ActiveSync, turn file conversion on again.
8. Enter settings and connection information on the Pocket PC.

To transfer offline folders

1. Connect your palm-size or handheld PC to your desktop PC, and then click **Windows CE Inbox Transfer** on the Microsoft Outlook **Tools** menu.
 2. Select **Copy or move selected messages to your desktop computer**, and then click the Browse button.
 3. Select the offline folder that contains the messages you want to transfer to your desktop PC, and then click **OK**.
 4. Click the Transfer button and select the folder you want to transfer the messages to or click **New Folder** to create a new folder. Click **OK** to transfer the messages. Now you must transfer the messages from your desktop PC to your HP Jornada.
 5. In Inbox on your HP Jornada, tap **Tools** and then tap **New Folder** to create a folder for the messages you are going to transfer.
 6. In Outlook on your desktop PC, select the messages you want to transfer.
-

7. Connect your HP Jornada to your desktop PC, and then click **Windows CE Inbox Transfer** on the Outlook **Tools** menu.
8. Select **Copy selected messages to your mobile device**, and then click the Browse button.
9. Select the offline folder on your device that you want to transfer the messages to, and then click **OK**.
10. Click the Transfer button. The selected messages are moved to your HP Jornada.

Migrating data from Palm devices

Migrating from Palm III and newer products

Palm V™ and Palm III™ series connected organizers can synchronize data with Microsoft Outlook. From MS Outlook you can synchronize the data to your HP Jornada using ActiveSync. Use PocketMirror® from Chapura™ (included with the Palm™ Desktop organizer software) to synchronize data between your Palm Computing handheld and Microsoft Outlook.

To use Chapura's PocketMirror conduit, first install the Palm™ desktop software that is included with your Palm IIIx™ or Palm V™ organizer. If you choose to synchronize with Microsoft Outlook, the PocketMirror conduit will be installed with the Palm desktop software. For more information, go to the Palm Web site at www.palm.com.

Migrating from older Palm organizers

If you would like to use PocketMirror to synchronize your Palm Pilot or Pilot organizer with Microsoft Outlook, you will need to purchase the commercial version of the software from Chapura, the maker of PocketMirror. Check the Chapura Web site at www.chapura.com.



Appendix C | Using the Keyboard in Terminal Server Client

Creating extended keyboard characters in the Terminal Server Client window (TSC)

The  key combinations that normally create extended and international characters on the HP Jornada keyboard (color-coded yellow symbols on selected keys) are not available when typing in the TSC application. However, you can still create these characters using special, alternative keystroke combinations when you are typing in a TSC session.

Using the alt key in conjunction with specific numeric key combinations will produce these extended and international text characters in a TSC session window.

The keyboard must be in NUMLOCK mode when pressing the numeric keys indicated in these keyboard alternatives, and the **alt** key and **all** of the indicated **numeric keys** must be pressed to create the desired character.





Table of extended and international characters for TSC

The table below illustrates the characters available and the corresponding keystrokes that create them in a Terminal Server Client window.

To create this character:	Type these keystrokes:
{	Alt+1,2,3
}	Alt+1,2,5
[Alt+9,1
]	Alt+9,3
~	Alt+1,2,6
'	Alt+9,6
€	Alt+0,1,2,8
£	Alt+0,1,6,3



Terminal Server Client is available in U.K. and U.S. English versions of the HP Jornada 700 Series only.

Glossary

ac adapter A connector that provides external power (not battery power) to your HP Jornada. For information about installing and using the ac adapter, see the **Setting up your HP Jornada** section in chapter 2.

ActiveSync Software from Microsoft that manages data synchronization between your HP Jornada and desktop PC. You can specify the type of data you want to synchronize.

backup file A duplicate copy of your HP Jornada files and data that is stored on your desktop PC or on a PC Card. This file does not include your HP Jornada settings and information stored in ROM, such as factory-installed software. Use your backup file to restore your HP Jornada to its previous state if your device data is damaged or destroyed or if you have performed a factory default reset.

cache A special high-speed storage mechanism that saves temporary copies of Web pages and other file types as you view them. Your computer can quickly display Web pages you have recently visited, because Internet Explorer can open them from cache instead of having to load them again from the Web. Increasing the space designated for your cache folder increases how quickly recently visited files are displayed, but decreases the amount of space available for other files on your HP Jornada. You can choose to empty your cache upon exiting Internet Explorer. This saves space on your device.

cookies A packet of messages a Web server passes to your Web browser. When you enter a Web site that uses

cookies, you may be asked to fill out a form with information such as your name and interests. This information is passed to your Internet Explorer browser as a cookie (in the form of a text file called cookie.txt). The next time you visit that Web site, Internet Explorer will pass the cookie back to the Web server, and the server will use this information to present you, for instance, with custom Web pages filled with information of interest to you. For example, instead of being presented with a generic welcome page, you might receive a welcome page with your name on it.

dial-up connection A connection between your HP Jornada and another computer by modem. You can have a dial-up connection with an ISP, a network, or with a modem attached to a PC.

direct connection A connection between your HP Jornada and another computer by means of the serial sync cable, USB cable or IR port.

docking cradle (optional on the HP Jornada 710) Place your HP Jornada in the docking cradle for instant connectivity with your PC partner. Once you have seated your HP Jornada into the docking cradle you can sync with your PC partner, transfer documents, send e-mail and charge your main battery.

DNS (Domain Name System) An Internet service that translates domain names into IP addresses. For example, the domain name www.jornada.com might translate as 198.125.247.4.

factory default reset A process that returns your HP Jornada to its original state by removing all power, thereby erasing all files and data you have saved. For more information, see the **Resetting** section in chapter 8. (Also called “hard reset.”)

hard icons The icons located along the right side of your touch screen are hard icons. Tap these icons to open the

HP settings, HP backup, HP dialup and Windows Media Player applications.

hot keys The keys in the top row of the Jornada keyboard, just below the display screen. Hot keys provide one-touch access to the most frequently used programs on your HP Jornada

Internet Service Provider (ISP) A company that provides access to the Internet.

IP (Internet Protocol) Specifies the format of packets, also called datagrams, and the addressing scheme of the Web. Much like a postal system, IP allows you to address a package and drop it into the system, but your package is not delivered instantly to your recipient. The packets are simply delivered to a server until the recipient downloads them by logging onto the ISP server.

IrDA (Infrared Data Association) An international standard for the hardware and software used in infrared communication links.

Java An object-oriented programming language used to create applications that run on client or server computers, and "applets" for use as part of a Web page.

LAN (Local area network) A group of computers, usually in close proximity (either in the same building or in buildings in close proximity), that are linked together to share files and exchange data.

MIME (Multipurpose Internet Mail Extensions) A standard that allows binary data (such as graphics or documents) to be transmitted over the Internet without first being translated into ASCII text. Many e-mail programs use MIME to allow files to be sent or received as attachments to e-mail messages.

NIC (Network interface card) A card that is installed in a computer so that it can be connected to a network.

Network interface cards can provide a dedicated, full-time connection to a network.

ODBC (Open DataBase Connectivity) A standard database access method. The goal of ODBC is to make it possible to access any data from any application, regardless of which database management system is handling the data.

partnership An established relationship between your HP Jornada and your PC for the purpose of synchronizing and transferring data. Your HP Jornada can have partnerships with up to two desktop computers.

PCT (Private Communication Technology) A protocol that maintains the security and integrity of Internet communications by using encryption, authentication, and message-authentication codes. The protocol is application independent, and is used by Web browsers and e-mail clients to send data via the Internet. PCT is able to negotiate encryption keys as well as authenticate a server before data is exchanged by the higher level application.

POP (Post Office Protocol) The first protocol used to retrieve e-mail from a mail server. Most e-mail applications (sometimes called e-mail clients) use the POP protocol, although some may use the newer IMAP (Internet Message Access Protocol).

PPP (Point-to-Point Protocol) The default method your HP Jornada uses to communicate with the ISP network server.

ROM (Read Only Memory) Computer memory containing data that normally can only be read, not written to, containing the programming that allows your computer to start up each time you turn it on. Unlike random access memory (RAM), the data in ROM is not lost when power is turned off.

RAM (Random Access Memory) Memory that holds data and programs while a device is powered on, often referred to as "volatile" memory because all information is erased when power is off.

RAS (Remote Access Service) account A network account that enables your HP Jornada to access your Windows NT network remotely.

remote connection A connection between your HP Jornada and a remote computer or server.

reset A process that either causes your HP Jornada to restart (**soft reset**) or causes all data stored in RAM to be erased (**factory default reset**). For more information, see the **Resetting** section in chapter 8.

restore A process that returns your device to the state it was in when last backed up. This involves copying your backup data to your HP Jornada.

SLIP (Serial Line Internet Protocol) An older and simpler protocol than PPP. Connecting to the Internet via SLIP is very similar to connecting via PPP.

soft reset The process of restarting your HP Jornada and reinitializing the MS Windows for H/PC 2000 operating system. Performing a soft reset will erase any unsaved data in open documents, but will preserve data that has been saved. (Also called "warm boot.")

stylus A pen-like utensil designed for navigating on a touch screen.

touch screen A touch-sensitive screen that allows you to open files, launch programs, and select text by touching or tapping the screen with the stylus.

USB (Universal serial bus) A standardized connection method and cabling protocol for connecting peripherals and other devices to standalone computers.



Index

HP Jornada 720 Web site
hot key , 115, 138

.

.2bp files, 118
.bmp files, 118
.doc file, 105
.pwd file, 105
.rtf file, 105
.ttf files, 117
.txt file, 105
.wav files, 118

5

56K V.90 modem, 89

9

9-pin serial port, 36

A

AC adapter, 36, 37, 38, 177
traveling with, 144
Access numbers, 144
Accessing
computer not on network,
51
corporate networks, 51
Accessories, 118
ActiveSync, 153, 154, 171
about, 33
backing up and restoring
on PC, 79

Connection Settings

dialog box, 51

defined, 177

installing, 34

setting up, 32

Setup Wizard

about, 32

Inbox extensions,

adding, 32

requirements, 34

transferring messages,
32

Troubleshooter, 43

ActiveSync CD-ROM, 33, 35

ActiveSync options, 48, 49

Add/Remove programs, 116

Adding or removing

programs, 116

Alarms, setting, 118

Alt + hot keys

defined, 138

Attachments

MIME encoding, 106

saving on storage cards,
106

Audio buttons

locking, 145

using, 28

Auto Connect option, 52

Auto suspend failure, 149

Auto-suspend, setting, 129

B

- Background tab, 118
- Backing up
 - to a CompactFlash Card, 80
- Backing up and restoring data, 78, 81, 91, 181
- Backup file, 177
- Bass and treble setting, 137
- Battery
 - backup, 126
 - backup, replacing, 126
 - main, 125
- Battery drain, troubleshooting, 149
- Battery main, replacing, 126
- Battery power
 - auto-suspend, 129
 - conserving, 129
 - managing, 125
 - status, 128
- Benefits, overview, 4
- Bitmap images (.bmp files), 118
- bmp files, 118
- Breakage, 148
- Browsing
 - on HP Jornada desktop, 46
 - the Web, 107
- Browsing the Web, 108

C

- Cables
 - HP parallel printer, 77
 - serial sync, 36
 - sync, 36
 - telephone, 36
 - USB, 119
 - Caching, 177
 - Calculator, described, 9
 - Calendar, 56
 - overview, 6
 - Communications control panel, 132
 - CompactFlash Card
 - installing, 120, 122
 - overview, 119
 - removing, 123
 - when traveling, 144
 - Configuring
 - ActiveSync for infrared connection, 45
 - HP Jornada for infrared connection, 45
 - Conflict resolution, default settings, 49
 - Connecting
 - by serial port, 36
 - by USB, 38
 - HP Jornada to a PC, 31
 - HP Jornada to alternate PC, 45
 - Connecting to Internet, personal accounts modems, 86
 - PPP (Point-to-Point Protocol) Account, 87
 - Connecting to PC
 - 9-pin serial port, 36
 - with docking cradle, 37, 38
 - without docking cradle, 36
 - Connection Status dialog box, 40, 44
 - Connections
 - dialup, 87, 89
 - direct, 178
 - network
 - creating without HP dialup, 101
 - partnership
 - automatic, 43
 - infrared, 44
-

- Contacting HP, 164
- Contacts, 58
 - overview, 6
- Control panel
 - opening, 132
 - types of, 132
- Cookies, 177
- Corporate networks
 - remote access, 51
- Customer service, 163
- Customizing
 - general options, 132
 - HP hard icons, 134
 - HP hot keys, 134

D

- Data
 - synchronizing general, 47
 - synchronizing selected, 48
- Data loss, 155
- Databases, creating, 76
- DC jack, 36, 37, 38
- Default conflict resolution, 49
- Desktop Wallpaper, 118
- Desktop, HP Jornada
 - browsing, 46
 - files, working with, 46
 - opening files, 46
- Device connection via
 - network option, 52
- Dialing control panel, 132
- Dialing locations, setting, 53
- Dialup connection, 87, 178
- Dialup Connection dialog
 - box, 53
- Dialup connections
 - multiple, 100
- Dimming, automatic,
 - setting, 130
- Display
 - dimming, setting, 130
 - shutting off, 131

- Display Control Panel, 132
- Display difficulties, 159
- Display profile hot key, 138
- Display Profiles tab, 136
- DNS
 - address, 90
 - server address, 97
- DNS address, 178
- doc file, 105
- Docking cradle, 36
 - defined, 178
- Domain
 - network, 92
- Drivers
 - installing, 119
 - NICs, 98

E

- Electrical interference, 148
- E-mail
 - connecting to service
 - provider from Inbox, 104
 - corrupted file
 - attachments, 155
- E-mail accounts, corporate
 - no offsite access, 88
 - offsite access, 87
 - setting up, 103
- E-mail accounts, personal
 - setting up, 86
- E-mail attachments, 105
- E-mail connections, options, 85
- E-mail messages
 - deleting, 106
 - sending difficulties, 155
 - synchronizing, 49
- E-mail Service
 - setting up, 93
- Enable Address Issue dialog
 - box, 103
- Ergonomics, 167

F

- Fields, mapping, 67
- File attachments
 - MIME encoding, 106
 - saving on storage cards, 106
- File Conversion Properties dialog box, 54
- File formats
 - GSM, 69
 - Microsoft Pocket Word, 72
 - PCM, 69
 - recording, 68
- File types
 - .rtf file, 105
 - .txt file, 105
 - Pocket Word files (.pwd), 105
 - Word file (.doc), 105
- Files
 - accessing on a network, 99
 - arranging on desktop, 46
 - attachments, 105
 - conversion options, 54
 - corrupted attachments, 155
 - opening from desktop, 46
 - transferring, 54
- fon files, 117
- Fonts, adding, 117
 - TrueType (.ttf files), 117
 - Windows (.fon files), 117

G

- Guest privileges, network, 98

H

- Hard icons
 - customizing, 134
 - defined, 178
 - Hard icons tab, 135
 - Hot keys
 - customizing, 134
 - defined, 179
 - display profiles, 138
 - volume profiles, 138
 - Hot keys tab, 135
 - HP backup, 80, 81, 153
 - overview, 8
 - HP ChaiVM, 109
 - cache, clearing, 111
 - disabling, 110
 - Internet Explorer, using with, 110
 - overview, 8
 - HP dialup
 - Setup Wizard, 91
 - HP dialup, overview, 8
 - HP F1227A, 119
 - HP F1252A, 119
 - HP F1258A, 118
 - HP F1274A, 119
 - HP F1279B, 119
 - HP F1281A, 125
 - HP F1281A, 119
 - HP F1295A, 119
 - HP F1822A, 118
 - HP F1840A, 119, 125
 - HP F1841A, 119
 - HP F1842A, 119
 - HP hard icons
 - customizing, 134
 - restoring default assignment, 135
 - HP hot keys
 - customizing, 134
 - overview, 9
 - restoring default assignment, 135
 - HP hot keys control panel, 132
 - HP info exchange, 65
 - overview, 8
 - HP Jornada 700 Series Web site, 138
-

- HP Jornada backup
 - application, 79, 80
- HP Jornada, infrared
 - connection, setting up, 45
- HP parallel printer cable (F1274A), 77
- HP quick pad, 63
 - overview, 8
 - using, 64
- HP security, 140
 - overview, 8
- HP security control panel, 132, 140
- HP settings
 - opening, 136
 - overview, 8, 136
 - profiles, 137
 - profiles, changing, 138
 - profiles, hot keys, 138
 - profiles, setting, 137
- HP viewer, 60
 - launching difficulties, 154
 - overview, 8

I

- Identification tab, 140
- IMAP4 host, 90
- Inbox, 59, 93, 171, 172
 - connecting to ISP (Internet Service Provider) from, 104
 - sending failure, 155
 - settings, 105
 - using, 102
- Information, sources, 2
- Infrared connection, establishing, 45
- Infrared port, 44, 77
- Infrared transfer
 - difficulties, 158
- Infrared-equipped PCL printer, 77
- Inso® Quick View Plus, 114
- Installing

- applications, 114, 115
 - Microsoft ActiveSync, 35
 - Microsoft Pocket Outlook, 32
- Intelligent Power Management, 130
- Interference, electrical, 148
- Internet connections
 - corporate account with no offsite access, 88
 - corporate account with offsite access, 87
 - options, general, 85
 - personal account, 86
- Internet Explorer, 107, 109
 - browsing the Web, 107
 - launching, 108
 - options dialog box, 107
 - setting up AutoDial, 108
- Internet Options control panel, 133
- Internet service provider (ISP), 89
- Intranet connections, 107, 108
- IP (Internet Protocol)
 - address, 90, 179
- IrDA port option, printing, 78
- ISP (Internet Service Provider), 89
- ISP (Internet Service Provider), 92, 179
 - connection, setting up, 90

J

- Java
 - applets, 109
 - applications, 110
 - defined, 179
 - script, 109

K

Keyboard control panel, 133

L

LAN (Local Area Network),
35, 88, 179

Locking up, troubleshooting,
150

M

Main battery, 125
when traveling, 144

Maintenance and cleaning,
147

Make New Connection
dialog box, 52

Memory
allocations, adjusting, 123
conserving, 124
displaying information,
139

managing, 123
refreshing, 123

Memory tab, 123, 139

Microsoft ActiveSync
Help, 147
overview, 32
setting up for infrared
connections, 45

troubleshooter, 43
Microsoft Ink Writer
overview, 78

Microsoft Internet Explorer,
33, 109

Microsoft Money 2000, 33

Microsoft Outlook 2000, 33,
35, 40, 153, 172, 173

Microsoft Pocket Access
creating a database in, 76
creating a table in, 76
overview, 76

Microsoft Pocket Excel

overview, 75
Microsoft Pocket Office, 6
overview, 72
Microsoft Pocket Outlook, 6,
55
installing, 32
Microsoft Pocket
PowerPoint
overview, 73
Microsoft Pocket Word
overview, 72
Microsoft Voice Recorder, 68
Migrating data from other
devices, 171

MIME
defined, 179
encoding, 106

Mobile Channels, 35
Mobile Device window, 47,
116

Mobile Favorites, 35
Modem card and cable, 144
Modem list options, 52

Modems
connection difficulties,
158
dialing difficulties, 157
installing and
configuring, 89

Monitor, viewing
difficulties, 159

MS Internet Explorer for
H/PC, 107

MS Windows for H/PC 2000
Add/Remove Programs,
116
address bar, 99
bitmaps (.2bp files), 118

MS Windows for H/PC
2000-based devices
infrared transferring
difficulties, 158

MusicMatch Jukebox, 114
My Handheld PC folder, 120

N

- Network
 - accessing computer not on network, 51
 - guest privileges, 98
- Network (LAN) connection, 88
- Network Configuration dialog box, 98
- Network connections
 - accessing corporate accounts, 51
 - creating without HP Dialup, 101
 - onsite logon, 99
- Network control panel, 133
- Network Domain, 93
- Network interface card (NIC), 88
- New Partnership Wizard, 39
- NIC (Network interface card), 179
 - configuring, 98
- No converter selected dialog box, 116
- Notes tab, 140

O

- ODBC
 - defined, 180
- Office documents, printing, 77
- OmniSolve from Landwear
 - overview, 82
- Open Presentation dialog box, 74
- Owner control panel, 133
- Owner properties, altering, 139

P

- Palm devices
 - migrating data, 173
 - Part numbers
 - HP F1252A, 119
 - HP F1258A, 118
 - HP F1274A, 119
 - HP F1279B, 119
 - HP F1281A, 125
 - HP F1281A, 119
 - HP F1295A, 119
 - HP F1822A, 118
 - HP F1840A, 119, 125
 - HP F1841A, 119
 - HP F1842A, 119
 - HPF1227A, 119
 - Partnership
 - establishing, 39
 - New Partnership Wizard, 39
 - Partnership between PC and HP Jornada, 180
 - automatic connections, 43
 - future connections, 43
 - overview, 38
 - troubleshooting, 40
 - Password Activation Delay, 142
 - Passwords
 - limitations, 141
 - PC card
 - installing, 120, 121
 - overview, 119
 - removing, 121
 - PC card adapters, recommended, 120
 - PC card detection
 - difficulties with, 152
 - PC Card NIC
 - drivers, 98
 - PC Connection
 - difficulties with, 153
 - PC Link, 44
 - PCM, 69
-

- PCT (Private Communication Technology), 180
- Performance, fine-tuning, 132
- PIM (personal information manager), 40, 153
- Pocket Access, overview, 6
- Pocket Excel, overview, 6
- Pocket Outlook, 55
 - Calendar, 56
 - Contacts, 58
 - Inbox, 59
 - Tasks, 58
- Pocket PowerPoint, overview, 6
- Pocket Word, overview, 6
- POP3, 180
- Ports
 - 9-pin serial, 36
 - infrared, 44
- Power
 - displaying information about, 139
 - Intelligent Power Management, 130
 - troubleshooting, 149
- Power control panel, 133
 - description, 133
 - opening, 128
 - overview, 128
- Power on option, setting, 130
- Power Saving tab, 129
- PPP (Point-to-Point protocol), 158
- PPP (Point-to-Point Protocol), 87, 180
- Primary password
 - removing, 142
 - setting, 141
- Primary password protection
 - disabling, 141
- Printing

- IrDA port option, 78
- Microsoft Pocket Office documents, 77
- office documents, 77
- via infrared, 78
- Program memory, 110, 123, 139, 150, 151, 156
- Programs
 - available from HP Web site, 114
 - installing, 114
 - removing, 117
- Proxy server, 94
- pwd.file, 105

Q

- Quick pad, 63

R

- Radiation, 148
- Recording, 68
 - formats, 68
- Recycle Bin, options, 124
- Regional settings control panel, 133
- Reinstating or removing applications, 116
- Reminder Password
 - setting, 143
- Remote Access Services (RAS), 181
- Remote connections, 181
 - dialing location set up, 53
- Remote locations
 - synchronizing from, 50
- Remote Networking
 - setting up, 101
- Remote Networking folder, 52
- Remove Programs control panel, 133
- Resetting, 159
 - defined, 181

- factory default, 160, 161, 178
- soft, 160, 181
- Resolve Conflicts dialog box, 49
- Restore
 - full, 82
 - PIM databases, 81
 - using ActiveSync, 79
 - warning message, 153
- Restoring
 - using ActiveSync, 81
- Restoring data, 78, 181
- Rich Ink technology, 78
- rtf file, 105

S

- Safety precautions, 148
- Screen, viewing difficulties, 159
- Security, 139
- Security Log
 - using, 143
- Send using MIME format
 - check box, 106
- Serial connection, 40
- Serial Port
 - making connections, 36
- Serial sync cable, 31, 36, 118, 144
- Server-assigned address, 93
- Server-assigned IP address, 92
- Service Provider
 - connecting to, 95
- Setting Alarms, 118
- Settings profiles, 137
- SLIP (Serial Line Internet Protocol), 87, 158
- Smart Card
 - installing, 120, 121
 - removing, 122
- SMTP host, 90

- Socket LP-E/EIO control panel, **133**
- Software drivers, installing, 119
- Software Product License Agreement, 196
- Sound
 - adding, 118
 - adjusting, 131
- Storage memory, 68, 69, 111, 116, 123
- Stylus control panel, 133
 - described, 133
- Support**, 163
- Suspend, 13, 26, 131
 - auto, 128
 - delay, 129
- SVGA 256-color, 34
- Synchronization, 32, 39
 - Resolve Conflicts dialog box, 49
 - resolving conflicts, 49
 - with Active Sync, 32
- Synchronizing
 - data, 47
 - e-mail messages, 48, 49
 - files, 48
 - from a remote location, 50
 - Microsoft Pocket Outlook data, 48
 - remotely, 50
 - selected data, 48
- System control panel, 133

T

- Tables, creating, 76
- TCP/IP, 92
- Telephone cable, 36
- Telephone lines
 - access, 87
 - connecting to modems, 95
- Temperature moderation, 148

- Terminal Server Client (TSC)
 - keyboard use, 175
- Transferring data
 - difficulties, 158
- Transferring files, 54
- Traveling with HP Jornada, 144
- Troubleshooting
 - display, 151
 - HP backup, 153
 - installing software, 156
 - insufficient memory, 152
 - locking up, 150
 - printing, 156
 - shutdown/suspend, 150
 - stylus response, 157
- txt file, 105

U

- USB, 40, 41, 154
 - defined, 181
 - making a connection, 38
- Use Server-assigned IP
 - Address check box, 53

V

- Viewer, 60
- Viewing
 - difficulties, 159
- Voice Recorder, 68
- Volume & Sound control panel, 133
- Volume profile hot key, 138
- Volume Profiles tab, 136

W

- Waiting for mobile device to disconnect message, 51
- Warranty
 - hardware, 193
 - software, 196
- wav files, 118
- Wave sounds (.wav files), 118
- Web Service, 94
- Web, browsing, 107
- Windows folder, 117
- WINS server address, 97
- World Clock
 - control panel, 134



Warranty

Important: This is your hardware product warranty statement. Read it carefully.

Warranty terms may be different in your country. If so, your Authorized HP Dealer or Hewlett-Packard Sales and Service office can give you details.

One year limited hardware warranty

Hewlett-Packard (HP) warrants this hardware product, against defects in material and workmanship for a period of one year from receipt by the original end-user purchaser.

If HP receives notice of the above defined defects during the warranty period, HP will either, at its option, repair or replace products that prove to be defective.

Should HP be unable to repair or replace the product within a reasonable amount of time, the customer's alternate exclusive remedy shall be a refund of the purchase price upon return of the product.

Limitation of warranty

The above warranty shall not apply to defects resulting from: misuse; unauthorized modification; opening for any reason except to perform an official upgrade using an HP Upgrade Kit; operation or storage outside the environmental specifications for the product; the coin-cell backup battery, or damage caused by this battery; in-transit damage; improper maintenance; physical damage to the unit, such as a cracked or broken screen or defect resulting from use of non-HP software, accessories, media, supplies, consumables, or such items not designed for use with the product.

HP makes no other express warranty, whether written or oral, with respect to this product.

Any implied warranty of merchantability or fitness for a particular purpose is limited to the one-year duration of this written warranty.

Some states, provinces, or countries do not allow limitations on how long an implied warranty lasts, so the above limitation or exclusion may not apply to you.

This warranty gives your specific legal rights, and you may also have other rights that vary from state to state, province to province, or country to country.

Limitation of liability and remedies

The remedies provided above are the customer's sole and exclusive remedies.

In no event shall HP be liable for any direct, indirect, special, incidental, or consequential damages (including lost profit), whether based on warranty, contract, tort, or any other legal theory.

Some states, provinces, or countries do not allow the exclusion or limitation of incidental or consequential damages - including lost profit-, so the above limitation or exclusion may not apply to you.

Consumer transactions in Australia, New Zealand and the United Kingdom

The preceding disclaimers and limitations shall not apply to consumer transactions in Australia, New Zealand and the United Kingdom, and shall not affect the statutory rights of consumers.

For consumers in Australia

The above warranty terms and any other warranty statement enclosed with this product, except to the extent lawfully permitted, do not exclude, restrict, or modify and are in addition to the statutory rights implied by the Trade Practices Act 1974 or any corresponding State or territory legislation applicable to the sale of this product to you. If you have any queries about your rights, contact the Hewlett-Packard Customer Care Center at 61-3- 88778000.

For consumers in New Zealand

The above warranty terms or any other warranty statement enclosed with this product, except to the extent lawfully permitted, do not exclude, restrict or modify and are in addition to the statutory rights implied by the Consumer Guarantees Act 1993 applicable to the sale of this product to you. If you have any queries about your rights contact the Hewlett-Packard End User Support line at 0800-733547.

HP software product license agreement and HP software product limited warranty

This HP product contains preinstalled software programs. Please read the HP Software Product License Agreement before proceeding.

Important: Carefully read this License Agreement and the Limited Warranty statement before operating the equipment. The rights to the software are licensed, not sold. HP or its licensors continue to own all intellectual property rights to the software, and you will be granted certain rights to use the software upon your acceptance of this license. Rights in the software are offered only on the condition that you agree to all terms and conditions of the License Agreement. Operating the equipment indicates your acceptance of these terms and conditions. If you do not agree to the terms and conditions of the License Agreement, return the complete package for a full refund now.

HP Software Product License Agreement

The HP Software Product License Agreement shall govern the use of all software that is provided to you, the customer, as part of this HP product with the exception of Microsoft Software. Microsoft Products are licensed to you under the Microsoft End User License Agreement (EULA) contained in the Microsoft documentation. Any third party software supplier's warranty terms that may be found on-line, or in any documentation or other materials contained in the product packaging, shall govern the use of that third party software.

The following License Terms govern the use of the software:

Use

You may only use the software on a single computer. You may not reverse, assemble, or decompile the software.

Transaction in European Union member states: The prohibition against decompilation shall be subject to Directive 91/250/EEC.

Copies and adaptations

You may make copies or adaptations of the software (a) for archival purposes, or (b) when copying or adaptation is an essential step in the use of the software with a computer so long as the copies and adaptations are used in no other manner.

You have no other rights to copy unless you acquire an appropriate license to reproduce which is available from HP for some software.

You agree that no warranty, free installation, or free training is provided by HP for any copies or adaptations made by you.

All copies and adaptations of the software must bear the copyright notice(s) contained in or on the original.

Ownership

You agree that you do not have any title to or ownership of the software, other than ownership of the physical media. You acknowledge and agree that the software is copyrighted and protected under the copyright laws. You acknowledge and agree that the software or part thereof may have been developed by a third party software supplier named in the copyright notice(s) included with the software, who shall be authorized to hold you responsible for any copyright infringement or violation of this or their own License Agreement.

Transfer of rights in software

You may transfer rights to the software to a third party only as part of the transfer of all your rights and only if you obtain the prior agreement of the third party to be bound by the terms of this License Agreement. Upon such a transfer, you agree that your rights to the software are terminated and that you will either destroy all your copies and adaptations or deliver them to the third party. Transfer to a U.S. government department or agency or to a prime or lower tier contractor in connection with a U.S. government contract shall be made only upon prior written agreement to terms required by HP.

Sublicensing and distribution

You may not lease, sublicense the software or distribute copies or adaptations of the software to the public in physical media, by telecommunication or at all without the prior written consent of HP.

Termination

HP may terminate this software license for failure to comply with any of these terms, provided HP has requested you to cure the failure and you have failed to do so within thirty (30) days of such notice.

Updates and upgrades

You agree that the software does not include updates and upgrades that may be available from HP under a separate support agreement.

Export clause

You agree not to export or re-export the software or any copy or adaptation in violation of the U.S. Export Administration regulations or other applicable regulations.

U.S. government restricted rights

The Software and Documentation have been developed entirely at private expense. They are delivered and licensed as “commercial computer software” as defined in DFARS 252.227-7013 (Oct 1988), DFARS 252.211-7015 (May 1991) or DFARS 252.227- 7014 (Jun 1995), as “commercial item” as defined in FAR 2.101 (a), or as “Restricted computer software” as defined in FAR 52.227-19 (Jun 1987) (or any equivalent agency regulation or contract clause), whichever is applicable. You have only those rights provided for such Software and Documentation by the applicable FAR or DFARS clause or the HP standard software agreement for the product involved.

HP Software Product Limited Warranty

Important: This HP Software Product Limited Warranty shall cover all software that is provided to you, the customer, as part of the HP product, including any operation system software. Any third party software supplier's warranty terms that may be found on-line, or in any documentation or other materials contained in the product packaging shall supersede the HP Software Product Limited Warranty with regard to that third party software.

Ninety-Day Limited Software Warranty

HP warrants for a period of NINETY (90) DAYS from the date of purchase that the software product will execute its programming instructions when all files are properly installed. HP does not warrant that the software will be uninterrupted or error free. In the event that this software product fails to execute its programming instructions during the warranty period, your remedy shall be replacement or refund only. Return the media to HP for replacement. Should HP be unable to replace the media within a reasonable amount of time, HP shall refund the purchase price upon return of the product and all copies.

Removable media (if supplied)

HP warrants the removable media, if supplied, upon which this product is recorded to be free from defects in material and workmanship under normal use for a period of NINETY (90) DAYS from the date of purchase. In the event the media proves to be defective during the warranty period, your remedy shall be replacement or refund only. Return the media to HP for replacement. Should HP be unable to replace the media within a reasonable amount of time, HP shall refund the purchase price upon return of the product and destruction of all other non-removable media copies of the software product.

Notice of warranty claims

You must notify HP in writing of any warranty claim not later than thirty (30) days after the expiration of the warranty period.

Limitation of warranty

HP makes no other express warranty, whether written or oral, with respect to this product.

Any implied warranty of merchantability or fitness for a particular purpose is limited to the 90-day duration of this written warranty. Some states, provinces, or countries do not allow limitations on how long an implied warranty lasts, so the above limitation or exclusion may not apply to you. This warranty gives specific legal rights, and you may also have other rights which vary from state to state, province to province, or country to country.

Limitation of liability and remedies

THE REMEDIES PROVIDED ABOVE ARE YOUR SOLE AND EXCLUSIVE REMEDIES. IN NO EVENT SHALL HP BE LIABLE FOR ANY DIRECT, INDIRECT, SPECIAL, INCIDENTAL, OR CONSEQUENTIAL DAMAGES (INCLUDING LOST PROFIT), WHETHER BASED ON WARRANTY, CONTRACT, TORT, OR ANY OTHER LEGAL THEORY. Some states, provinces, or countries do not allow the exclusion or limitation of incidental or consequential damages - including lost profit-, so the above limitation or exclusion may not apply to you.

In no case shall HP's liability exceed the purchase price for the software and/or product. The limitations set forth above will apply regardless of whether you accept the software.

Consumer transactions in Australia and the United Kingdom: The disclaimers and limitations above shall not apply and shall not affect the statutory rights of a Consumer.
