

STOP!!!
READ THIS FIRST

Before upgrading the KX-T336 to the 12.00 revision that is included with this kit be sure to read and understand the WP (version up) command that is detailed on additional page 15-G-3.

This command is used to initialize the **RAM** area of the newly added system memory while keeping the current settings intact.

INSTALLATION INSTRUCTIONS FOR KX-T336 EPROMS

WARNING: The following procedures should be followed in the exact order in which they are written. If these instructions are not followed, permanent damage to the **EMSS** could result.

NOTE: It is recommended that before upgrading the **EMSS** that all programming be saved (section 16) since the system may return to the default program during this procedure.

Materials needed to complete this software change:

- 4 • **Eprom(s)**
- 1 • IC extraction tool

- 1) Turn the power switch on all **KX-T336** cabinets to the **OFF** position and disconnect all power cords from the **AC** outlets.
- 2) If any optional system battery adapters (**KX-A26**) are installed, set their power switches to the off position.
- 3) **Remove the front cover by turning** the key counterclockwise and **then** pulling the cover forward.
- 4) Locate the **"CPU"** card installed in slot BS 1 and remove the guide plate from the upper front side (if installed) to allow access to the **"CPU"** card.
- 5) Set the **"mode"** switch on the "CPU" card to position **0** and set the **"system"** switch to 0.
- 6) **Before** removing the-"CPU", be sure to be wearing an anti-static wristband or to ground yourself.
- 7) Remove the **"CPU"** card which is inserted into the slot marked **"CPU"** by lifting both latches on the **"CPU"** card **and then** pulling the card out.
- 8) Place the **"CPU"** card on a flat work surface and locate IC 11, **12, 13** and '14 (see **figure 1**).
- 9) Gently remove the chips **from** the sockets using a IC extraction tool.
- 10) Install **each** new IC in the proper socket on the **"CPU"** card making sure that they are in the correct position and that all the pins remain straight.
- 11) Install the **"CPU"** card.
- 12) Install the PCB guide plate.
- 13) Connect all power cords to the **AC outlets**.
- 14) Turn the power switches to the ON positions and push the reset button.
- 15) Wait until system returns to the on-line mode.
- 16) Turn the power switches on all optional system battery adapters (**KX-A26**) to the ON position.
- 17) Verify that all programming is retained or Load system **parameters as** instructed in section 16.

Supplement Manual for KX-A220 ⑤ manual

This Supplement Manual is issued to provide information on new features (described on the following pages) which have been added to the KX-T336 System after the KX-A220 ⑤ manual was printed.

KX-A220 ⑤ manual consists of:

Vol. 1 (PQQX6483XA)

Vol. 2 (PQQX6485XA)

Notice

The KX-T336100 with the mark (F) provides new features as described below.

Location of the mark (F)

The mark (F) is attached to the back of the unit as shown below.

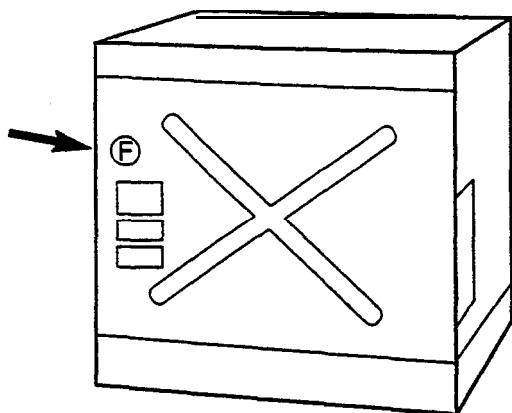

New Features

The KX-T336 System provides the following new features that enhance system operation.

Available from software Version 12.00 (CPU card ROM: Y251L - Y254L) and above.

- Call Forwarding • Follow Me (CFM command)
- **DISA/AGC** Tone Detection **Mode** (TDM command)
- Limited Call Duration (LCD command)
- **Ringback** Tone while Transfer (**WS3** command)
- Screened **Call** Transfer to Trunk by SLT (WS3 command)
- Tie Lines
- T-I Interface (KX-T96187)

Please replace the following pages in the old version with newly issued revised version attached.

Newly issued pages are marked as “(70695)“.

Vol.1

Old Version	New Version
Cover Page (Section 1) I-1 (60395)	Cover Page (Section 1) I-I (70695)M
1-2 1 -A-I	I-2 (70695)M I-A-1
1 -A-4 1 -A-5 (60395)	I - A - 4 1 -A-5 (70695)M
1 -A-6 1 -B-I (60395)	1 -A-6 (70695)M 1 -EI (70695)M I-B-I-1 (70695)M blank
I-D-3 1 -E-I (30393)	1 -D-3 1 -E-I (70695)M
1 -E-2 (30393) I - E - 3	1 -E-2 (70695)M 1 -E-3
1 -E-4 (E) 1 -E-5 (60395)	1 -E-4 (E) 1 -E-5 (70695)M
I-E-6 (50195) (E) 1 -E-7	I-E-6 (70695)(E)M 1 -E-7 (70695)M
1 -E-8 (50195) 1 -E-9	1 -E-8 (70695)M 1 -E-9 (70695)M
1-E-10 (E) I-E-11 (E)	1 -E-I 0 (70695)(E)M I-E-11 (70695)(E)M 1 -E-I 2 (70695)M blank
2-2 (60395) 2-A-I	2-2 (70695)M 2-A-I

Old Version	New Version
—	2-C-28-1 (70695)M 2-C-28-2 (70695)M 2-C-28-3 (70695)M 2-C-28-4 (70695)M 2-C-28-5 (70695)M blank Insert these sheets after page 2-C-28.
3-2 (60395) 3-3 (60395)	3-2 (70695)M 3-3 (70695)M
3-B-2 3-B-3 (60395)	3-B-2 3-B-3 (70695)M
3-B-4 (30393) 3-B-5	3-B-4 (70695) 3-B-4-1 (70695) blank 3-B-5 (70695)
3-B-7 2 3-B-I 3	3-B-12 3-B-I 3 (70695)
3-B-19 3-B-20	3-B-I 9 3-B-20 (70695)M

Old Version	New Version
3-F-66 (40993) blank	3-F-66 (40993) 3-F-67 (70695)M 3-F-68 (70695) 3-F-69 (70695) 3-F-70 (70695) 3-F-71 (70695)M 3-F-72 (70695) 3-F-73 (70695) 3-F-74 (70695) 3-F-75 (70695) 3-F-76 (70695) 3-F-77 (70695) 3-F-78 (70695) 3-F-79 (70695) 3-F-80 (70695) 3-F-81 (70695) 3-F-82 (70695) 3-F-83 (70695) 3-F-84 (70695)M 3-F-85 (70695)M 3-F-86 (70695)M blank
4-2	4-2
4-3 (30393)	4-3 (70695)
4-F-18	4-F- 18 (70695)
4-F-I 9	4-F-I 9
4-F-20 4-G-I	4-F-20 4-F-21 (70695) blank 4-G-I
5-2 (30393)	5-2 (70695)
5-A-I (60395)	5-A-I (70695)

Old Version	New Version
5-D-1 5-D-2 5-D-3 (50195) 5-D-3-I (21292) 5-D-3-Z (40993) 5-D-4 (21292)	5-D-1 (70695) 5-D-1 -1 (70695) 5-D-2 (70695) 5-D-3 (70695) 5-D-3-I (70695) 5-D-3-2 (70695) 5-D-3-3 (70695) 5-D-4 (70695)
5-D-I 5 (21292) 5-D-I 6	5-D-I 5 (21292) 5-D-I 6 (70695)
	5-D-I 9 (70695) blank insert this sheet after page 5-D-I 8.
5-E-1 5-E-2	5-E-1 (70695) 5-E-1-1 (70695) . blank 5-E-2 (70695)

Vol.2

Old Version	New Version
7-c-3 7-C-4 (60395)	7-c-3 7-C-4 (70695)M
7-C-5 (60395) 7-C-6	7-C-5 (70695)M 7-C-6
8-D-1 (50195) 8-D-2	8-D-1 (70695)M 8-D-2
8-G-1 (60395) blank	8-G-1 (70695)M blank
Cover page (Section 9) 9-1	Cover page (Section 9) 9-1 (70695)M
9-2 (60395) 9-3 (60395)	9-2 (70695)M 9-3 (70695)M
9-A-1 9-B-1 (60395)	9-A-1 9-B-1 (70695)M
9-c-2 9 - C - 3 (6 0 3 9 5)	9-c-2 9-C-3 (70695)M
9-c-4 9-c-5 (30393)	9-C-4 (70695)M 9-C-5 (70695)
—	9-C-8 (70695) blank Insert this sheet after page 9-C-7.
9-D-1 (60395) 9-D-2 (60395)	9-D-1 (70695)M 9-D-2 (60395)M
9-D-3 (60395) 9-D-4 (60395)	9-D-3 (70695)M 9 - D - 4 (7 0 6 9 5) M
9-D-7 9-D-8 (60395)	9-D-7 9-D-8 (70695)M
9-D-1 7 9-D-1 8 (21292)	9-D-1 7 9-D-1 8 (70695)M
9-D-1 9 (30393) 9-D-20	9-D-19 (70695)M 9-D-20 (70695)M
9-D-33 9 - D - 3 4	9-D-33 (70695) 9-D-34 (70695)

Old Version	New Version
9-D-35	9-D-35 (70695)
9-D-36 (30393)	9-D-36 (70695)
9-D-37 (60395)	9-D-37 (70695)M
9-D-38	9-D-38 (70695)
9-D-39	9-D-39 (70695)
9-D-40	9-D-40 (70695)
9-D-41	9-D-4 1 (70695)
9-D-42	9-D-42 (70695)
9-D-43	9-D-43 (70695)
9-D-44	9-D-44 (70695)
9-D-45	9-D-45 (70695)
9-D-46	9-D-46 (70695)
9-D-47	9-D-47 (70695)
9-D-48 (E)	9-D-48 (70695)(E)
9-D-49	9-D-49 (70695)
9-D-50	9-D-50 (70695)
9-D-51	9-D-51 (70695)
9-D-52	9-D-52 (70695)
9-D-53	9-D-53 (70695)
9-D-54	9-D-54 (70695)
9-D-55	9-D-55 (70695)
9-D-56 (30393)	9-D-56 (70695)
9-D-57 (30393)	9-D-57 (70695)
9-D-58 (30393)	9-D-58 (70695)
9-D-59	9-D-59 (70695)
9-D-60	9-D-60 (70695)
9-D-61	9-D-61 (70695)
9-D-62	9-D-62 (70695)
9-D-63 (30393)	9-D-63 (70695)
9-D-64 (30393)	9-D-64 (70695)

Old Version	New Version
	9-D-64-1 (70695) 9-D-64-2 (70695) 9-D-64-3 (70695) 9-D-644 (70695) Insert these sheets after page 9-D-64.
9-D-71 (30393) 9-E-1	9-D-71 (30393) 9-E-1 (70695)
9-E-6 (30393) 9-E-7 (60395)	9-E-6 (70695) 9-E-7 (70695)M
9-E-8 9-E-9 (21292)	9-E-8 (70695) 9-E-8-1 (70695) blank 9-E-9 (70695)
9-E-1 0 (30393) 9-E-11 (30393)	9-E-1 0 (70695) 9-E-11 (70695) 9-E-1 1-1 (70695) blank
9-E-16 9-F-1 (50195)	9-E-1 6 9-F-1 (70695)
9-F-2 (60395) 9-F-3 (50195)	9-F-2 (70695)(F) 9-F-3 (70695)
9-F-4 (50195) 9-F-5	9-F-4 (70695) 9-F-5
9-K-1 0 9-L-1	9-K-1 0 9-K-1 1 (70695) 9-K-1 2 (70695) 9-L-1
9-M-6 9-M-7	9-M-6 (70695) 9-M-7
9-M-8 blank	9-M-8 (70695) blank
Cover page (Section 10) 10-1 (60395)	Cover page (Section 10) 1 0-1 (70695)M

Old Version	New Version
10-2 (60395) 10-3 (60395)	10-2 (70695)M 10-3 (70695)M
10-A-1 (30393) 10-B-1 (60395)	10-A-1 (70695) 10-B-1 (70695)M
10-B-2 (60395) 10-C-1	10-B-2 (70695)M 10-C-1
10-c-2 (30393) 10-C-3 (60395)	10-C-2 (70695)M 10-C-3 (70695)M
10-c-4 (30393) 10-c-5	10-C-4 (70695) 10-C-5
10-C-6 (60395) 10-C-7 (60395)	10-C-6 (70695)M 10-C-7 (70695)M
10-C-14 (21292) 10-c-15	10-C-14 (70695)M 10-C-15
10-C-22 (30393) 10-C-23 (30393)	10-C-22 (30393) 10-C-23 (70695) 10-C-23-1 (70695) blank
10-C-24 10-C-25	10-C-24 (70695) 10-c-25
10-C-28 (50195) 10-C-29 (60395)	10-C-28 (70695) 10-C-29 (60395)
10-C-30 (50195) 10-C-31 (30393)	10-C-30 (70895) (F) 10-C-31 (70695) 10-C-31-1 (70695) blank
10-C-34 (50195) 10-C-35 (50195)	10-C-34 (70695) 10-C-35 (70695)
10-C-76 10-C-77 (60395)	10-C-76 10-C-77 (70695)
10-C-78 (60395) 10-C-79 (60395)	10-C-78 (70695)M 10-C-79 (70695)M
10-C-80 (60395) 10-C-81 (50195)	10-C-80 (70695)M 10-C-81 (70695)

Old Version	New Version
I0-C-82 (30393) 10-C-82-1 (50195)(E)	10-C-82 (30393) 10-C-82-1(70695)(E)M
10-C-82-2 (50195)(E) 10-C-82-3 (50195)	10-C-82-2 (70695)(E)M 10-C-82-3 (70695)(E)M
10-C-82-4 (50195)(E) 10-C-83 (21292)	10-C-82-4(70695)(E)M 10-C-83(21292)
10-C-108 (60395) 10-D-1 (21292)	10-C-108 (60395) 10-C-109 (70695)M 10-C-110 (70695)M 10-C-111 (70695)M 10-C-112 (70695)M 10-C-113 (70695)M 10-C-120 (70695) 10-C-121 (70695) 10-C-122 (70695) 10-C-123 (70695) 10-C-130 (70695) 10-C-131 (70695) 10-C-132 (70695) 10-D-1(21292)
10-D-4 (21292) 10-D-5 (30393)	10-D-4 (21292) 10-D-5 (70695) 10-D-5-1 (70695) blank
10-D-6 (21292) 10-D-7 (21292)	10-D-6 (21292) 10-D-7 (70695)
Coverpage(Secti on14) 14-1	Coverpage(Secti on14) 14-1 (70695)
14-2 14-3	14-2 (70695)M 14-3(70695)M
14-E-4 14-E-5	14-E-4 (70695)M 14-E-4-1 (70695) blank 14-E-5

Old Version	New Version
14-E-6 14-E-7	14-E-6 (70695) 14-E-6-1 (70695)M blank 14-E-7
	14-E-37-1 (70695)M 14-E-37-2 (70695)M 14-E-37-3 (70695)M 14-E-37-4 (70695)M Insert these sheets after page 14-E-37.
14-G-3 14-G-4	14-G-3 (70695)M 14-G-4
Cover page (Section 15) 15-1	Cover page (Section 15) 15-1 (70695)M
15-2 15-A-1	15-2 (70695) 15-A-1
—	15-E-5-1 (70695)M 15-E-5-2 (70695)M insert this sheet after page 15-E-5.
15-F-2 15-F-3	15-F-2 (70695)M 15-F-3
	15-G-3 (70695) blank Insert this sheet after page 15-G-2.

Section 1

System Outline

(Section 1)

System Outline

Contents

	Page
A Overview	1 -A-1
1.00 The Structure of This Manual	1 -A-1
2.00 Some Conventions Used in This Manual	I-A-2
3.00 System Description	1 -A-3
4.00 Communication Needs	1 -A-3
5.00 Service Cards Description	1-A-5
B System Components	1-B-1
1 .00 Components List	1-B-1
2.00 System Connections	1 -B-2
C Features	I-C-1
D Administration	1-D-1
1.00 Introduction	I-D-1
2.00 System interface	I-D-1
3.00 Programming	I-D-2
4.00 Test	I-D-2
5.00 Monitor	I - D - 3
6.00 Backup Utility	I-D-3
E System Configuration	I-E-1
1.00 Basic Shelf	1-E-1
2.00 Expansion Shelf	I-E-2
3.00 Attendant Console	I-E-3
4.00 CPU Card	I-E-3
5.00 TSW Card	I-E-4
6.00 Power Unit	1 -E-4
7.00 LCOT Card	I-E-5
8.00 GCOT Card	I-E-5
9.00 PLC Card	I-E-6
10.00 SLC Card	1 -E-6
10.01 SLC Card..	I-E-6
10.02 SLC-M Card	I-E-6
11.00 HLC Card	I-E-7
12.00 ATLC Card	I-E-7
13.00 DISA Card	I-E-8
14.00 DID Card	I-E-8
15.00 OPX Card	I-E-9
16.00 DPH Card	I-E-9
17.00 AGC Card	I-E-10

	Page
18.00 RMT Card.....	I-E-10
19.00 T-SW Conference Expansion Card.....	I-E-11
20.00 OHCA Card.....	I-E-11
21.00 T-SW OHCA Expansion Card..... ** *	I-E-11
22.00 OPX Power Unit.....	I-E-11
23.00 T-I Digital Trunk Card.....	I-E-12

A. Overview

1 .00 The Structure of This Manual

Introduction

This system reference manual provides general technical information on Panasonic KX-1336 system.

This includes a description of the system, its hardware and software, features and service, environmental requirements.

This manual is intended to serve as an overall technical reference for the system.

Organization

This manual is comprised of the following 19 sections.

Section 1 System Outline

This section describes the overall information of the system and the construction of this Service Reference Manual.

Section 2 Installation

This section describes how to install and start up the system.

Section 3 System Features and Operation

This section describes the basic system features:

Section 4 Station Features and Operation (PITS)

This section describes the basic features and operations from the viewpoint of Proprietary Integrated Telephone System (PITS) users. The basic features and required operations for DSS console are also described.

Section 5 Station Feature and Operation (SLT)

This section describes the basic features and operations from the viewpoint of Single Line Telephone (SLT) users.

Section 6 Station Feature and Operation (ATT)

This section describes the basic features and operations from the viewpoint of the Attendant Console (ATT) Operator.

Section 7 Preparation for Programming and Operation (VT220 and Compatibles)

This section describes the basic usage and available functions of VT220 and Compatibles.

Section 6 Preparation for Programming and Operation (Dumb)

This section describes the basic usage and command reference of Dumb terminal.

Section 9 System Programming (VT220 and Compatibles)

This section provides information for the programming of the system database using VT220 and Compatibles.

Section 10 System Programming (Dumb)

This section provides information for the programming of the system database using Dumb terminal.

Section 11 System Programming (PITS)

This section provides information for a certain programming of the system database using PITS telephone.

Section 12 Station Programming (PITS)

This section provides information for the programming of various features specific to each PITS telephone and DSS console using PITS telephone.

Section 13 Station Programming (ATT)

This section provides information for the programming and the back-up of the attendant console database using the attendant console.

Section 14 Maintenance (VT220 and Compatibles)

This section describes the information necessary for monitoring, testing, and maintaining the system using VT220 and Compatibles.

Section 15 Maintenance (Dumb)

This section describes the information necessary for monitoring, testing, and maintaining the system using Dumb terminal.

Section 16 Backup Utility-On-Site

This section provides the information for saving and loading of the system programming data (including attendant console database) at on-site.

Section 17 Backup Utility-Remote Location

This section provides the information for saving and loading the system programming data (including attendant console database) from a remote location.

Section 18 Abbreviations

This section provides a list of abbreviations used in this manual.

Section 19 Index

Holding Features

Hold allows an extension user to suspend a call. This feature allows users to temporarily disconnect from one conversation and either make or answer another call. Music on-hold or message may be provided to the held party if available.

Call Park allows a user to place a call on hold, then pick up the call at any station in the system. The user can page another party to pick up the parked call or may move to another location and then re-access the call.

Transferring Features

Transfer allows a user to transfer any call to another party. This feature supports transfer of calls from the called party to another party for completion of a transaction.

Call Forwarding allows users who are away from their phones to receive calls at another phone. This feature supports roving personnel and shared office space or company staff.

Conversation Features

Conference allows up to 3 parties (maximum two outside parties), including the originator, to join a call.

Paging Features

Paging allows extension users to make announcement through built-in speaker of Proprietary Integrated Telephone (PITS) and/or external Pager Equipments.

Other Features

Station Message Detail Recording (SMDR) generates detailed call information on all CO calls and sends this information to the printer. SMDR also generates detailed data on Error Log Records, System Programming Data and Traffic Information.

Off Premise Extension (OPX) allows Single Line Telephones (SLT) installed off the premises can be operated via a public or private network in exactly the same way as extension on the premise.

Account Code Entry allows a user to associate calls with an account code for charge-back purposes.

No.	Item	Maximum number	per system/ station
1	Tenant	2	system
2	Operator	2	tenant
3	Speed Dialing-System.	200	system
4	Speed Dialing-Station/SLT	10	station
5	One Touch Dialing-Station/PITS	23	station
6	Call Park Area	20	system
7	Programmable Absent Message	10	system
a	Trunk Group	16	system
9	Equal Access Group	4	system
10	OCC Access Group	4	system
11	Toll Restriction Level	16	system
12	Paging Group	a	system
13	ICM Group	a	system
14	Pickup Group	32	system
15	UCD Group	32	system
16	Class of Service	32	system
17	Primary DN (PDN)	3	station
18	Message Waiting	500	system

5.00 Service Cards Description

Extension cards

Proprietary Integrated Line Circuit (PLC) Card:

This card interfaces 8 PITS telephones/DSS consoles and the TDM bus.

It is available to connect 8 PITS telephones, DSS consoles to the system per PLC card.

Single Line Telephone Line Circuit (SLC) Card:

This card interfaces 8 SLT type telephones and the TDM bus.

It is available to connect 8 SLT telephones to the system per SLC card.

SLC Card with Message Waiting (SLC-M):

This card is the same as the standard SLC card except that it has the capability to turn on and off the message waiting lamp of a Single Line Telephone.

Hybrid Line Circuit (HLC) Card:

This card interfaces PITS/SLT type telephones, DSS consoles and the TDM bus.

It is available to connect 8 PITS/SLT telephones/DSS consoles to the system per HLC card.

Off Premise Extension Trunk (OPX) Card:

This card interfaces 4 off premise extensions through off premise extension power unit.

Attendant Console Line Circuit (ATLC) Card:

This card interfaces 2 Attendant Consoles and the TDM bus.

It is available to connect 2 attendant consoles to the system if this card is installed.

CO trunk cards

Loop Start Central Office Trunk (LCOT) Card: *

This card interfaces 8 central office loop start trunks and the TDM bus.

It is available to connect 8 CO lines to the system per LCOT card.

With loop start, you seize a line by bridging through a resistance the tip and ring (both wires) of your telephone line.

Ground Start Central Office Trunk (GCOT) Card: *

This card interfaces 8 central office trunks and the TDM bus. It is available to connect 8 CO lines to the system per GCOT card.

A way of signaling on subscriber trunks in which one side of the two wire trunk (typically the "Ring" conductor of the Tip and Ring) is momentarily grounded to get dial tone.

- There are two types of switched trunks one can typically lease from a local phone company- Loop Start and Ground Start.

You must be careful to order the correct type of trunk from your local phone company and correctly install your telephone system at your end — so that they both match.

Direct Inward Dialing Trunk (DID) Card:

This card interfaces 4 central office trunks arranged for Direct Inward Dialing (DID) and the TDM bus.

T-1 Digital Trunk Card:

This card interfaces 1 T-1 line and TDM bus. It is available to connect a T-1 line to the system per T-1 digital trunk card. A T-1 line has capacity of 24 voice conversations.

Resource cards

Direct inward System Access (DISA) Card:
 This card interfaces 4 central office trunks arranged for Direct Inward System Access (DISA) and the TDM bus.

Automatic Gain Control (AGC) Card:
 This card is used to maintain volume of CO-CO communication.
 An electronic circuit which compares the level of an incoming signal with a previously defined **standard** and automatically amplifies or attenuates that signal so it arrives at its destination at the correct level.

Remote Circuit (RMT) Card:
 This card is necessary for accessing the system from a remote location.

Other cards

Doorphone Circuit (DPH) Card:
 This card interfaces 4 doorphones and the TDM bus. Up to 4 doorphones can be connected to the system.

Time Switch Conference Expansion Card (T-SW Conference1 Card):
 This card provides 64 additional conference trunks, and is installed on the T-SW card.

Off Hook Call Announcement (OHCA) Card:
 This card is for Off Hook Call Announcement features, and is installed on the HLC card or PLC card.

Time Switch Off Hook Call Announcement Expansion (T-SW OHCA) Card:
 This card is for Off Hook Call Announcement features, and is installed in the Basic Slot 2.

System Configuration

No.	Item	Maximum number s y s t e m / - station
1	HLC+PLC+SLC+OPX+DID+LCOT/GCOT+T-1	42 cards (336 ports)** system*
2	DID+LCOT/GCOT+T-1	18 cards (144 ports)** system*
3	DPH	1 card (4 doorphones) system*
		4 cards (16 resources) system*
		4 cards (16 resources) system*
	AT.	1 card (1 resource) system*
	SLOT 1 A	ports) / shelf
	le	16 con
13	External Music Source	2 system*

- System = **fully** expanded system = basic shelf + expansion shelf 1 + expansion shelf 2
- * T-1 is counted as 3 cards.

B. System Components

1 .00 Components List

Model No.	Name
KX-T336100	Basic Shelf
KX-1336101	CPU card
KX-T336102	T-SW card
KX-T336200	Expansion Shelf
KX-T96300	Attendant Console
KX-T96145	Attendant Console Keyboard
KX-T96136	Off Hook Call Announcement (OHCA) Card
KX-T96141	Attendant Console Line Circuit (ATLC) Card
KX-T96161	Doorphone Circuit (DPH) Card
KX-T96170	Hybrid Line Circuit (HLC) Card
KX-T96172	Proprietary ITS Line Circuit (PLC) Card
KX-T96174	Single Line Telephone Line Circuit (SLC) Card
KX-T96175	Single Line Telephone Circuit (SLC) Card with Message Waiting
KX-T96180	Loop Start Central Office Trunk (LCOT) card
KX-T96181	Ground Start Central Office Trunk (GCOT) Card
KX-T96 182	Direct Inward Dialing Trunk (DID) Card
KX-T96185	Off Premise Extension Trunk (OPX) Card
KX-T96186	Off Premise Extension (OPX) Power Unit
KX-T96187	T-I Digital Trunk Card
KX-T96191	Direct Inward System Access (DISA) Card
KX-T96193	Automatic Gain Control(AGC) Card
KX-T96196	Remote Circuit (RMT) Card
KX-T336 104	Time Switch Conference (T-SW Conference) Expansion Card
KX-T336105	Time Switch Off Hook Call Announcement (T-SW OHCA) Card

Model No.	Name
KX-T30820	Proprietary Telephone (3 Co's)
KX-T30830	Proprietary Telephone with LCD (3 CO's, 8 DSS's)
KX-T30850	Proprietary Telephone (3 CC's)
KX-T61620	Proprietary Telephone (6 Co's)
KX-T61630	Proprietary Telephone with LCD (6 CO's)
KX-T61650	Proprietary Telephone (6 Co's)
KX-T123220	Proprietary Telephone (12 CO's)
KX-T123230	Proprietary Telephone with LCD (12 CO's)
KX-T123230D	Proprietary Telephone with LCD (12 CO's)
KX-T123235	Proprietary Telephone with LCD (12 Co's)
KX-T123250	Proprietary Telephone (12 CO's)
KX-T7020	Proprietary Telephone (12 CC's)
KX-T7030	Proprietary Telephone with LCD (12 Co's)
KX-T7050	Proprietary Telephone (12 CO's)
KX-T7052	Single Line Telephone with FLASH button
KX-T7130	Proprietary Telephone with LCD (12 CO's)
KX-T61640	DSS Console (16 DSS's, 16 PF buttons)
KX-T123240	DSS Console (32 DSS's , 16 PF buttons)
KX-T7040	DSS Console (32 DSS's , 16 PF buttons)
KX-T30865	Doorphone
KX-A26D	Battery Adapter

5.00 Monitor

Monitor function provides displaying current status of "Error Log," "Device Status" and "Traffic information" individually on the screen.

Error Log

When a system maintenance object begins to fail periodic testing, the system automatically generates an error record which is stored in the Error Log.

Consulting the error log should be the first step in diagnosing system related troubles.

For further information, refer to Section 14-D-2.02 'Consulting the Error Log.'

Device Status

Provides information about current operation status of the following items individually on the screen.

- System
- Card
- Port
- Conference Trunk

Traffic

Provides current traffic information about following items individually.

- Station
- Trunk Group
- Attendant Console
- DISA
- OGM1
- OGM2
- AGC

Refer to **Section 14-G "Monitor"** for further information about monitor.

6.00 Backup Utility

Making backups of the system programming data and keeping it is extremely important in the unlikely event that system programming data are lost in a system failure.

Backup Utility consists of "save" and "load."

Save is to transmit a file of data from your system to backup device.

Load is to send a file of data on your system from backup device.

Before beginning saving or loading, check carefully that you are going to the direction you want.

It's very easy to erase files if you make a mistake and confuse saving and loading.

Starting up the backup operation can be done both at on-site and from a remote location.

Refer to Section 16 'Backup-Utility on-site' and Section 17 'Backup Utility-Remote Location' for further information.

E. System Configuration

1 .00 Basic Shelf

Basic Shelf is always required.

Basic Shelf contains its own power supply and 15 mounting spaces called "Slot." CPU card and T-SW card are installed at factory.

Basic Slot 2 is provided for installing the optional T-SW OHCA card.

The remaining 12 slots provide mounting space for the various cards that can be used. Any optional service card can be mounted in any of these 12 slots.

So these slots are called "Free Slot."

Basic Shelf consists of the followings.

No.	Name	Number
1	POWER-for Power Unit	1
2	BS1 (Basic Slot 1) • for CPU card	1
3	BS2 (Basic Slot 2) • for optional T-SW OHCA card	1
4	BS3 (Basic Slot 3) • for T-SW card	1
5	FS1 to 12 (Free Slot 1 to 12) • for optional service card	12

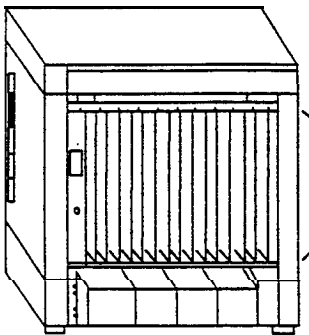

Construction of Basic Shelf

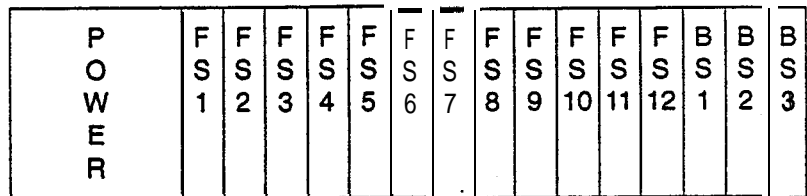

Free Slot can be equipped with the following optional service cards.

- a. Loop start central office trunk (**LCOT**) Card
- b. Ground start central office trunk (**GCOT**) Card
- c. Hybrid line circuit (**HLC**) Card
- d. Proprietary ITS Line circuit (**PLC**) Card
- e. Single line telephone line circuit (**SLC**) Card
- f. Single line telephone line circuit with Message Waiting (**SLC-M**) Card
- g. Direct inward dialing trunk (**DID**) Card
- h. Off premise extension trunk (**OPX**) Card
- i. Doorphone circuit (**DPH**) Card
- j. Automatic Gain control (**AGC**) Card
- k. Direct inward system access (**DISA**) Card
- l. Remote circuit (**RMT**) Card
- m. Attendant console Line circuit (**ATLC**) Card
- n. T-I Digital Trunk Card

2.00 Expansion Shelf

Expansion Shelf is provided optionally. Up to two Expansion Shelves (1 and 2) can be installed on the Basic Shelf to enlarge the ability of the system. Each Expansion Shelf contains its own power supply and 15 mounting spaces for any optional card required for system expansion. Expansion Shelf is installed on top of the basic shelf.

Expansion Shelf consists of the following.

No.	Name	Number
1	POWER-for Power Unit	1
2	FS1 to 15 (Free Slot) - for optional service card	15

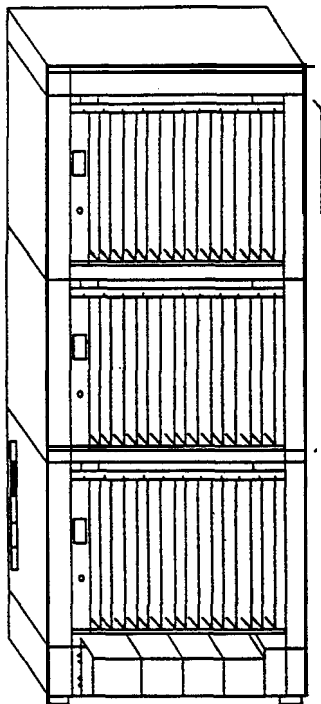

Construction of Expansion Shelf (1 and 2).

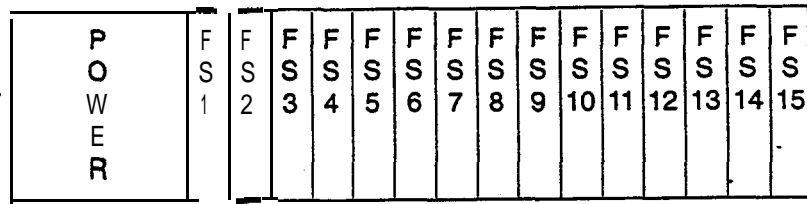

Free Slot can be equipped with the following optional service cards.

- a. Loop start central office trunk (**LCOT**) Card
- b. Ground start central office trunk (**GCOT**) Card
- c. Hybrid line circuit (HLC) Card
- d. Proprietary ITS Line circuit (PLC) Card
- e. Single line telephone line circuit (SLC) Card
- f. Single line telephone line circuit with Message Waiting (SLC-M) Card
- g. Direct inward dialing trunk (DID) Card
- h. Off premise extension trunk (OPX) Card
- i. Doorphone circuit (DPH) Card
- j. Automatic Gain control (AGC) Card
- k. Direct inward system **access** (DISA) Card
- l. Remote circuit (RMT) Card
- m. Attendant console Line circuit (ATLC) Card
- n. T-1 Digital Trunk Card

3.00 Attendant Console

Functions

Up to two Attendant Consoles (optional-with CRT display) can be equipped with the system..

The attendant console allows one or two attendants to answer, screen, and control incoming calls using Switched Loop Operation. With attendant operation, incoming calls can be screened and forwarded to the proper party for resolution, messages taken for absent users, or forwarded to alternate locations.

The attendant console is not dedicated to call processing and feature accessing, and can be used for system data programming and diagnostics.

Refer to Section 6 "Station **Features** and Operation-Attendant Console" for further information about attendant console call processing features, and Section 13 "Station Programming-Attendant Console" for further information about attendant console local programming mode.

Operation

Attendant console is operable for the following.

- . Call Processing mode
- . System programming
- . Diagnostics
- . Editing local data

4.00 CPU Card

Functions

- (1) Call process and basic shelf main protocol. (Microprocessor **80C286**).
Time switch (**TSW**) control, detection of system clock alarm, basic shelf power down and expansion shelf power down alarm, watch dog.
- (2) System switch interface.
There are Operation Switch (MODE) (10 modes, 0 to 9) and System Administration Device Selection Switch (SYSTEM) (10 modes, 0 to 9) on the CPU rotary switch. When the system lost the programming data because of system resetting, set system operation mode using these switches when starting up the system again.
- (3) Terminal interface.
CPU card has two RS-232C terminal interfaces.

Operation

- (1) Operation Switch (MODE) and System Administration Device Selection Switch (SYSTEM) are set by turning with screw driver.
- (2) Reset switch is non-lock push switch.
- (3) LED for battery alarm lights when voltage of Lithium-battery becomes too low (less than **2.5V**).
- (4) LED for watch dog lights when CPU's software is running away.
- (5) Watch dog is detecting CPU's running away.

5.00 TSW Card

Functions

- (1) Time switch.
Capability of switching voice is **512ch** x 512ch.
- (2) Generation of system clocks.
System clocks are **2,048MHz** (PCM clock), 8kHz (PCM frame clock).
- (3) Generation of call progress tone.
Call progress tones are **350+440Hz**, **620Hz**, **480+620Hz** and **440+480Hz**.
- (4) Conference circuit.
T-SW card has 3 party x 8 conference's circuits.
For CO-CO speech amp., AGC card can be inserted to a free slot of basic or expansion shelf.
- (5) **Paging** interface.
T-SW card has 2 pm-amp. circuits for paging. In order to adjust volume, each amp circuit is equipped with a knob.
- (6) Music-in interface.
T-SW card has 2 interface circuits for music on hold or BGM.

Operation

- (1) A knob for adjusting volume of external paging is turned with a screw driver from front of T-SW card.
- (2) LED indicator on the T-SW card lights when system reset or T-SW local reset occurs.

6.00 Power Unit

Functions

- (1) Power supply (**+5**, **±15**, GND) for a shelf.
- (2) External battery interface. (**+24**)
Battery power (**+24**) is input from a battery interface unit in basic shelf with a 2 wire cable.
- (3) Power failure detection.
A circuit in POW detects power failures of **+5VDC**, **±15VDC**, AC power supply, and 2 power alarm signals are sent to CPU card as DC alarm and AC alarm.
- (4) Generation of bell signal. (**20Hz**, 1 00V0p)

7.00 LCOT Card

Functions

LCOT (KX-T96180) ---Loop Start Central Office
Trunk card (8 CO Lines/
card)

- (1) Loop start CO interface.
CPC detection, 1 DTMF driver.
With loop start, you seize a line by bridging through a resistance the tip and ring (both wires) of your telephone line.
- (2) Power failure transfer (**PFT**) by each port.
Tip/Ring of CO are connected to a CO interface circuit, and directly to LCOT **PFT** modular. When power failure occurs, CO Tip/Ring leads are directly connected to SLT Tip/Ring leads, but LCOT PFT modular and SLT **PFT** modular should be connected each other with connection cord in advance.
- (3) Diagnostic transfer (DT) by each port.
A diagnostic relay is placed in Tip/Ring of each port.
During diagnostic test, only one diagnostic relay in an LCOT of a system is activated.

Operation

LED indicator on the LCOT card lights when the system reset or LCOT local reset occurs.

8.00 GCOT Card

Functions

GCOT (KX-T96181) ----Ground Start Central Office
Trunk card (8 CO Lines/
card)

- (1) Ground start CO interface.
CPC detection, 1 DTMF driver.
A way of signaling on subscriber trunks in which one side of the two wire trunk (typically the "Ring" conductor of the Tip and Ring) is momentarily grounded to get dial tone.
- (2) Power failure transfer (PFT) by each port.
Tip/Ring of CO are connected to a CO interface circuit, and directly to GCOT **PFT** modular. When power failure occurs, CO Tip/Ring leads are directly connected to SLT Tip/Ring leads, but GCOT PFT modular and SLT **PFT** modular should be connected each other with connection cords in advance.
- (3) Diagnostic transfer (DT) by each port.
A diagnostic relay is placed in Tip/Ring of each port.
During diagnostic test, only one diagnostic relay in a GCOT of a system is activated.

Operation

LED indicator on the GCOT card lights when the system reset or GCOT local reset occurs.

9.00 PLC Card

Functions

PLC card (KX-T96172)

- (1) PITS and DSS console interface. (8 circuits/
card)
Maximum loop resistance : 40 ohms
Power supply 1 : **+30V** (supplied through
speech path, and with
current limitation circuit).
Power supply 2 : **+15V** (supplied through
data line).
- (2) PITS (KX-T123230D, KX-T123235, KX-
T7130) interface with OHCA feature.
When a PITS *with* OHCA feature is connected
to a port, an OHCA piggy back card (KX-
T96136) should be mounted to its interface
circuit

Operation

LED indicator on the PLC card lights when the
system reset or PLC local reset occurs.

10.00 SLC Cards

10.01 SLC Card

Functions

SLC card (KX-T96174)

- (1) Standard SLT interface.
Maximum loop resistance : 600 ohms.
(including SLT)
Power supply : **+30V** (with current limitation
circuit.)
2 DTMF receivers, dial pulse detector.
- (2) Power Failure Transfer (**PFT**) by ports 1
through 8.
When power failure occurs, SLT Tip / Ring are
led by a **PFT** relay, but SLT PFT modular and
LCOT / GCOT modular should be connected
each other by connection cords in advance.
- (3) Diagnostic transfer (DT) by each port.
Diagnostic relay is placed in Tip / **Ring** of each
port.
During diagnostic test, only one diagnostic
relay in the SLT of a system is activated.

Operation

LED indicator on the SLC card lights when
system reset or SLC local reset occurs.

10.02 SLC-M Card

Functions

SLC-M Card (KX-T96175)

- (1)
- (2) **1** Same as 10.01 SLC Card
- (3)
- (4) SLT with Message Waiting Lamp interface
Power supply to Message Waiting
Lamp: **+80VDC** (when 1 **mA**)

Operation

Same as 10.01 SLC Card

11 .OO HLC Card

Functions

HLC card (KX-T96170) is for PITS, DSS console and SLT.

(8 extensions / card)

- (1) Standard SLT interface. SLT interface is quite same as that of SLT card.
- (2) PITS and DSS console interface. PITS and DSS console interface is quite same as that of PLC card.
- (3) Interface for PITS (**KX-T123230D**, **KX-T123235**, KX-T7130) with OHCA feature. Interface for PITS (**KX-T123230D**, **KX-T123235**, **KX-T7130**) with OHCA feature is quite same as that of PLC.
- (4) Power failure transfer by each port. (when using SLT)
Power failure transfer is quite same as that of SLC card.
- (5) Diagnostic transfer by each port. Diagnostic transfer is quite same as that of SLC card.

Operation

LED indicator on the HLC card lights when the system reset or HLC local reset occurs.

12.00 ATLC Card

Functions

(I)ATLC card. (KX-T96141)

Attendant console interface. (2 circuits / card)

(Attendant console : KX-T96300)

Operation

LED indicator on the ATLC card lights when the system reset or attendant console local reset occurs.

13.00 DISA Card

Functions

DISA (Direct Inward System Access) card.
(KX-T96191)

- (1) 4 OGM trunks.
OGM duration : 30 seconds,
OGM Battery Backup : 5 days.
The number of OGM : 1,
Recording Algorithm : ADPCM.
- (2) 4 CO-CO speech paths without amp.
A CO-CO speech path consists of up-path
and down-path.
Up-path is from call-originate CO to **call-**
answer CO, and 1 DTMF receiver and one
speech end detector is connected to it.
Down-path is from call-answer CO to call-
originate CO and one speech end detector is
connected to it.
- (3) Speech end detector.
Speech end detector detects **call** progress
tones.

Operation

LED indicator on the **DISA** card lights when the
system reset or **DISA** local reset occurs.

14.00 DID Card

Functions

DID (Direct Inward Dialing) card (KX-T96182)

Wink start/immediate start DID interface.
(4 circuits/card)
45V used in circuits is originated from DC-DC
converter in DID card.
DID card will receive pulse signal only.

Operation

LED indicator on the DID card lights when the
system reset or DID local reset occurs.

15.00 OPX Card

Functions

OPX (KX-T96185) ---Off Premise Extension.
(4 OPX Lines / card)
OPX Power Unit is
necessary.

OPX Power Unit should be connected with OPX
card, and Single Line Telephones for OPX should
be connected with OPX card.

16.00 DPH Card

Functions

Doorphone card (KX-T96161)

(1) Doorphone interface (4 circuits / card)
4 doorphones can be connected using a
modular connector.
Doorphone chime is sent to both extension
and doorphone at a time when a doorphone
button is pressed.

(2) Door opener interface (4 circuits / card)
DPH card has 4 relays for door opener.
(120VAC, 1A)
The relay opens for doorlock, closes for door
release. It also opens in the case of power
failure.

Operation

Terminal plate on the DPH card has 8 terminals,
2 leads from door opener are directly connected
to two of 8 terminals.
Operation interval of door opener is 3 seconds.

17.00 AGC Card

Functions

AGC (Automatic Gain Control) card
(KX-T96193)

- (1) 4 CO-CO speech paths with AGC Amp. and Echo-Suppressor.
A CO-CO speech path consists of up-path and down-path, up-path is from call-originate CO to call-answer CO, and AGC amp is inserted and speech end detector is connected.
Maximum amplitude rate of **AGC is 14 dB**.
Echo-Suppressor is inserted in a CO-CO speech path.
- (2) 4 DTMF transceivers.
DTMF transceiver is used as DTMF repeater.
So, **AGC** card microprocessor controls DTMF repeater.
- (3) 8 Speech End Detectors.
Speech end detector of AGC is quite same as that of **DISA** card.

Operation

LED indicator on the AGC card lights when the system reset or AGC local reset occurs.

18.00 RMT Card

Functions

RMT (Remote Circuit) card (KX-T96196)

Modem (**300/1200** bps) for remote administration.
Modem protocol (1) free wheeling (TTY)..

Operation

LED indicator on the RMT card lights when the system reset or RMT local reset occurs.

19.00 T-SW Conference Expansion Card

Functions

T-SW Conference Expansion card (KX-T336104)

Mounted on T-SW card.
3 party x 64 conference circuits.

20.00 OHCA Card

Functions

OHCA (Off Hook Call Announcement) card (KX-196136)

This card is mounted on HLC card (**KX-T96170**) or PLC card (KX-T96172).

This card includes 2 OHCA circuits.
Allows an extension user to intrude through the speaker into another extension that is in conversation using the handset.
This feature is available only against the following PITS telephones: **KX-T123230D**, KX-T123235, KX-T7130.

21 .00 T-SW OHCA Expansion Card

Functions

T-SW OHCA Expansion card (**KX-T3361 05**)

This card is mounted on Basic Slot 2 for OHCA feature.
OHCA card (KX-T96136) for extension port must be installed on the HLC card or PLC card in advance.

22.00 OPX Power Unit

Functions

OPX (Off Premise Extension) Power Unit (KX-T96186).

Output is Ringing Signal (1 OOVAC, **20Hz**) and 48V DC for OPX Card.

23.00 T-I Digital Trunk Card

Functions

T-I **interface**. (1 circuit / card)

T-I is a digital transmission link with a capacity of 1.544 Mbps.

A T-I card carries 24 voice conversations.

Frame Format : D4 / ESF

Line Coding : **AMI / B8ZS**

Channel Type : LCO / GCO / DID / OPX / TIE

Signaling : DP / DTMF

(**DTMF:24** receivers and 6 generators)

Operation

RED LED indicator on T-I card lights when the system reset or T-I card local reset, T-I line fault occurs.

	Page
3.10 GCOT Card (KX-T96181).....	2-c-22
3.11 DID Card (KX-T96182)	2-c-25
3.12 OPX Card (KX-T96185).....	2-C-26
3.13 DISA Card (KX-T96191)	2-C-28
3.14 AGC Card (KX-T96193)	2-C-28
3.15 RMT Card (KX-T96196)	2-C-28
3.16 T-I Digital Trunk Card (KX-T96187)	2-C-28-l
4.00 Parallel Connection of the Extensions	2-c-29
5.00 Auxiliary Connection for Power Failure Transfer	2-C-30
6.00 Connection of the Battery Adaptor (KX-A26D)	2-C-32
 D Connection of Optional Peripheral Equipments	 2-D-l
1 .00 Paging Equipment	2-D-l
2.00 External Music Source..	2-D-2
3.00 RS-232C Interface	2-D-3
3.01 Connection to the Printer..	2-D-5
3.02 Connection to the Data Terminal	2-D-6
 E Installation of Attendant Console	 2-E-i
1.00 Configuration	2-E-l
2.00 Attendant Console Assembly	2-E-3
3.00 Handset Connection	2-E-4
4.00 Installation and Removal of CRT Unit..	2-E-5
4.01 CRT Unit Installation	2-E-5
4.02 CRT Unit Removal	2-E-7
5.00 Keyboard Connection	2-E-8
6.00 Connection with KX-T336 System	2-E-9
7.00 AC Power Cord Connection..	2-E-l 0
8.00 Various Adjustments	2-E-l 1
 F Starting Up the KX-T336 System	 2-F-l
1.00 System Power-Up Procedure	2-F-l
2.00 CPU Rotary-Switch Features.....	2-F-2
2.01 Operation Switch (MODE).	2-F-2
2.02 System Administration Device Selection Switch (SYSTEM).	2-F-5
2.03 Operation Sequence for System Starting Up	2-F-6

A. Preparation

1 .00 Introduction

This section describes the procedures required to install the KX-T336 System. Detailed instructions for planning the installation site, installing the shelves and optional cards, and cabling of peripheral equipments are provided. Further information on system expansion and peripheral equipment installation is included.

3.16 T-1 Digital Trunk Card (KX-T96187)

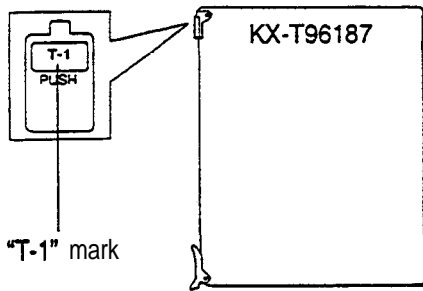

- Insert the card into Free Slot 1, 5 or 9 of any shelf.
- A maximum of six KX-T96187 can be installed in the system.

Connecting the Central Office Line

Insert the **RJ-48C** plug of the telephone line cord (**4-conductor** wiring) into the RJ-48C jack (T-1 port on the KX-T96187).

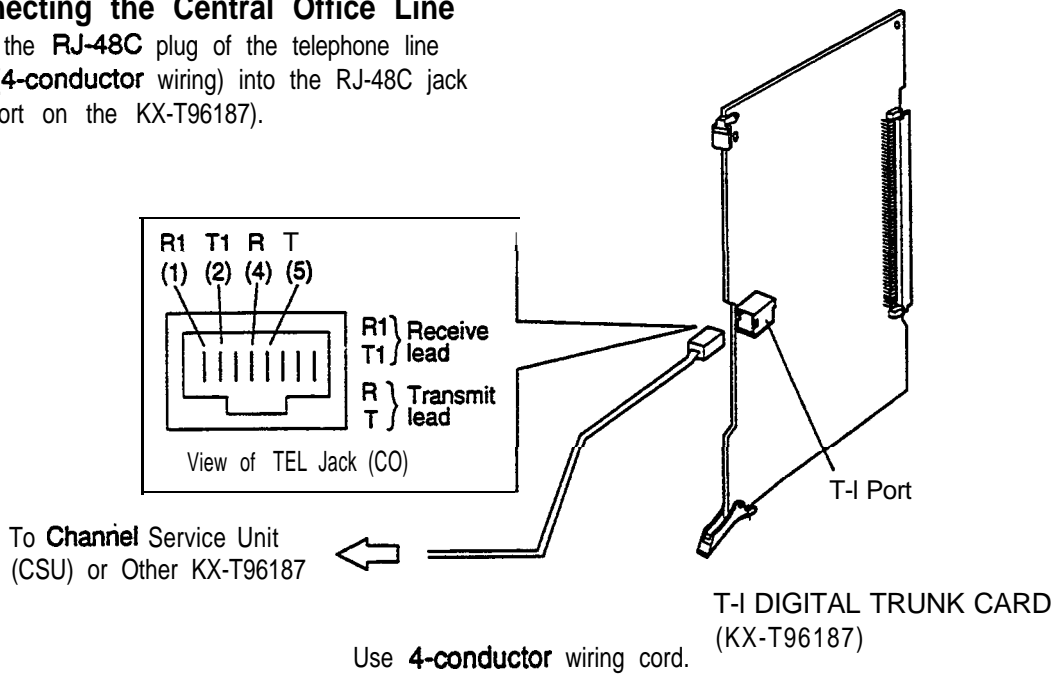

Transmit Equalizer Setting

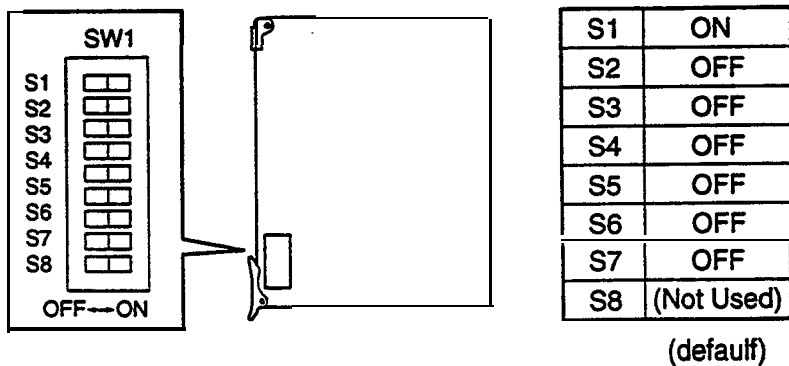

Note:

The User cannot change this setting.

Maximum Cabling Distance of the T-1 Line

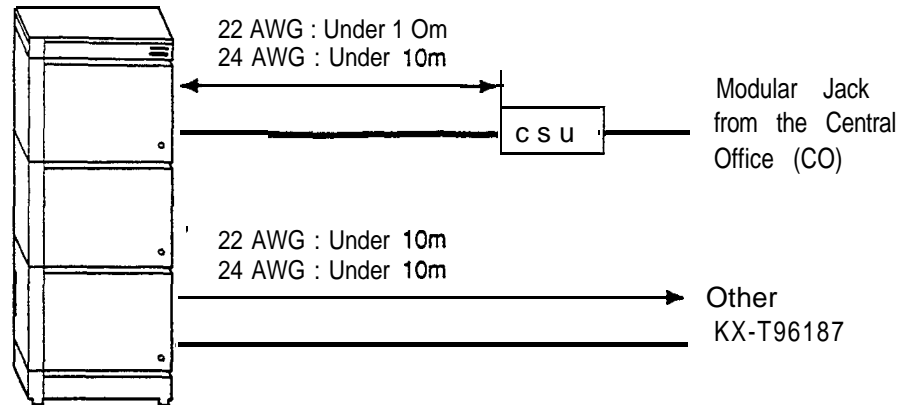

Note :

The T-1 line cable must be 22 AWG shielded twisted pair cable or 24 AWG UTP (unshielded twisted pair) cable supported Category 5.

Cable Pin Numbers to be connected for KX-T96187

KX-T96187 ↔ Channel Service Unit (CSU)

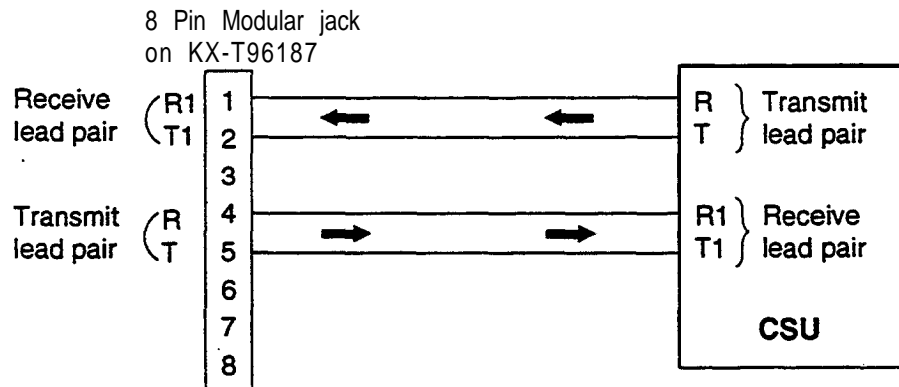

KX-T96187 ↔ KX-T96187

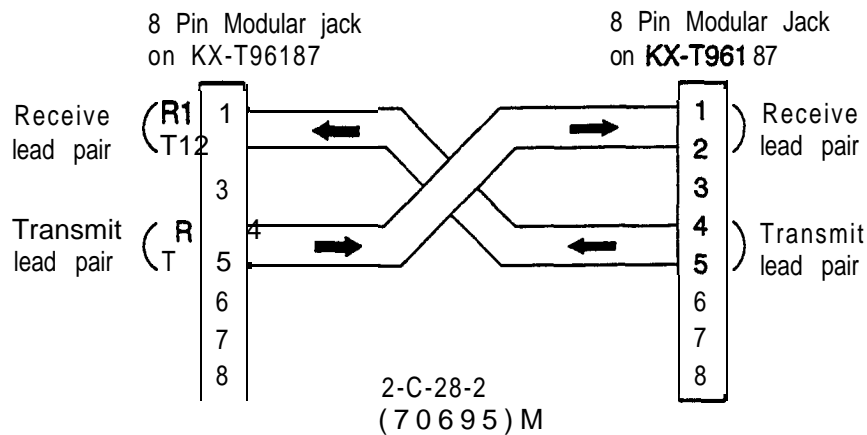

System Clock Mode for KX-T96187

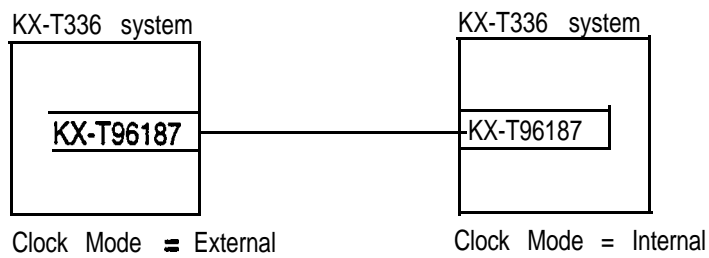
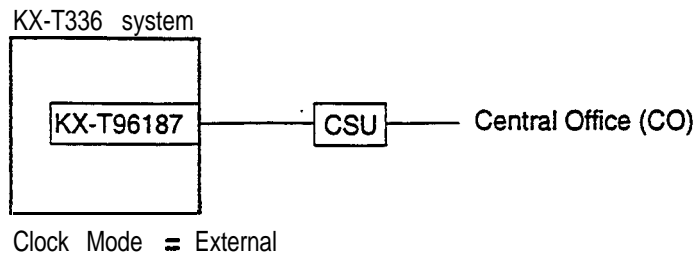

Note:

System Clock mode is programmed by CLK command.(see 10-C-64.02)

Short Jumper Setting for KX-T96187

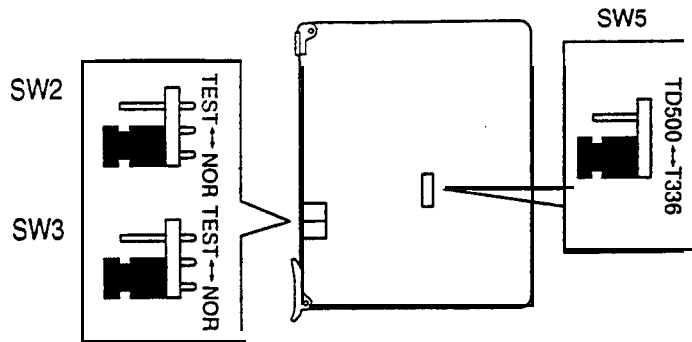

sw2, **SW3**

IT336	Mode for KX-T336 (
TD500	(Reserved)

SW5

d	e	f	a	u	l	t)

Note:

Loop Back Test

The user can check KX-T96187 by the following procedure.

1. Remove T-I cable from KX-196187.
2. Set SW2 and SW3 to TEST position.
3. Check SYNC LED (green).
 - If SYNC LED does not light or flash, KX-T96187 does not work.
4. Set SW2 and SW3 to NOR position.

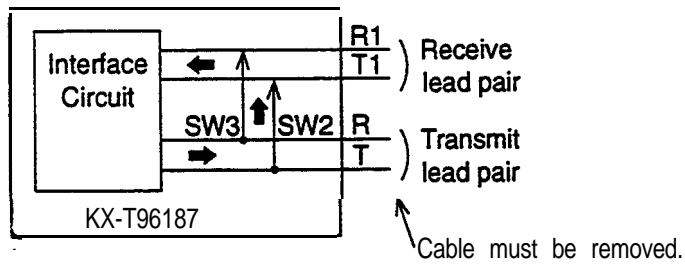

LED indication for KX-T96187

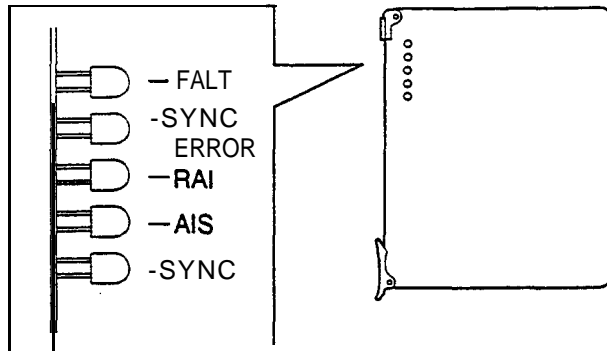

Item	Status	Contents
FAULT	ON	Card Fault
	OFF	Normal
SYNC ERROR	ON	Clock Synchronization Error or Loss of Signal
	OFF	Normal
RAI	ON	Receive Remote Alarm Indication signal (Yellow Alarm)
	OFF	Normal
AIS	ON	Send Alarm Indication Signal (Yellow Alarm)
	OFF	Normal
SYNC	FLASH	Clock Master at External Clock Mode
	ON	Detection of Signal
	OFF	No Detection of Signal

	P a g e
2.00 Automatic Route Selection (ARS)	3-c-21
3.00 Tone/Pulse Conversion	3-C-36
4.00 Automatic Pause Insertion	3-c-37
D Receiving Features..	3-D-1
1.00 Attendant Console (ATT) Operation	3-D-1
1 .01 Load Sharing	3-D-2-1
1.02 Simultaneous Ringing..	3-D-2-2
1.03 Interconsole IRNA	3-D-2-3
2.00 Attendant Console-less Operation	3-D-3
2.01 Direct In Line (DIL)	3-D-3
2.02 Direct Inward System Access (DISA)	3-D-4
2.03 Direct Inward Dialing (DID).....	3-D-7
2.04 Trunk Answer From Any Station (TAFAS)-Day Service..	3-D-8
2.05 Uniform Call Distribution (UCD)-General.....	3-D-9
2.06 Uniform Call Distrfbution (UCD)-with/without OGM..	3-D-11
2.07 Private CO (PCO)	3-D-15
2.08 Single CO (SCO).....	3-D-16
2.09 Group CO (GCO)	3-D-17
2.10 Flexible SCO/GCO Assignment	3-D-17-1
2.11 Multiple GCO Assignment	3-D-1 7-3
3.00 Flexible Ringing Assignment	3-D-1 8
3.01 Flexible Ringing Assignment-No Ringing	3-D-18
3.02 Flexible Ringing Assignment-Delayed Ringing	3-D-18
4.00 Discriminating Ringing	3-D-19
5.00 Station Hunting	3-D-20
5.01 Station Hunting-Circular	3-D-20
5.02 Station Hunting-Terminal	3-D-21
E Holding Features.....	3-E-1
1.00 Music on Hold	3-E-1
2.00 Held Call Reminder	3-E-2
3.00 Transfer Recall	3-E-3
F Other Features	3-F-1
1 .00 Station Message Detail Recording (SMDR)	3-F-1
2.00 Off Premise Extension (OPX)	3-F-3
3.00 Walking Station	3-F-3
4.00 Outgoing Message (OGM) Recording and Playing Back..	3-F-5
5.00 Intercept Routing-No Answer (IRNA)	3-F-8
6.00 Rerouting	3-F-9
7.00 Calling Party Control (CPC) Signal Detection	3-F-10
8.00 CO Busy Out.	3-F-11
9.00 Parallel Connection of Extensions	3-F-12
10.00 Voice Processing System (VPS).....	3-F-13
10.01 Voice Mail Integration	3-F-15

	Page
10.02 DTMF-Tone Integration	3-F-21
11.00 Call Accounting Summary	3-F-52
12.00 Waiting for Second Dial tone	3-F-62
13.00 Timed Reminder with OGM (Wake-up Call)	3-F-64
14.00 TIE Lines.....	3-F-67
14.01 Calling from TIE to TIE	3-F-72
14.02 Calling from TIE to CO	3-F-76
14.03 Calling from CO to TIE	3-F-79
14.04 Alternate Routing	3-F-81
15.00 T-I Carrier.....	3-F-84
16.00 Limited Call Duration	3-F-86

In addition to the feature numbers which can be set in 'System-Numbering Plan,' fixed feature numbers are provided and these are shown in the following table.

Fixed Feature Numbers

Function	Number
While busy tone is heard Call-back (for extensions only) Busy Override	6 1
While Do Not Disturb tone is heard DND Override	1
When handset is on-hook (PITS only) Time display/date display switching Background music on/off Day/Night mode display	* 1 #
While talking to doorphone Open the door	5
Others Extension time and data display mode switching Account code delimiter Account code delimiter (for dial pulse type 99 SLT only) Account code m-input	* # , *

- The feature numbers which are set in the "System-Numbering Plan" are listed on the following pages.

Flexible Feature Numbers

Function	Default	
	Fixed 1	Fixed 2
1st Hundred Block Extension	1	1
2nd Hundred Block Extension	2	2
3rd Hundred Block Extension	3	3
4th Hundred Block Extension	—	—
5th Hundred Block Extension	—	—
6th Hundred Block Extension	—	—
7th Hundred Block Extension	—	—
8th Hundred Block Extension	—	—
9th Hundred Block Extension	—	—
10th Hundred Block Extension	—	—
11th Hundred Block Extension	—	—
12th Hundred Block Extension	—	—
13th Hundred Block Extension	—	—
14th Hundred Block Extension	—	—
15th Hundred Block Extension	—	—
16th Hundred Block Extension	—	—
Operator Call (General)	0	0
Operator Call (Specific)	—	—
ARS/Local CO Line Access	9	9
Trunk Group 01-08 Access	81	81
Trunk Group 09-16 Access	82	82
Trunk Group 17-24 Access	83	83
Speed Dialing - System	* 1	6 * 1
Speed Dialing - Station	* 2	6 * 2
Doorphone Call (1-4)	40	640
External Paging	41	641
Station Paging	42	642
External Paging Answer	43	643
Station Paging Answer	44	644
Night Answer 1	45	645
Night Answer 2	46	646
Dial Call Pickup	47	647
Directed Call Pickup	48	648
Hold Extension Retrieve	49	649
Redial	* 3	6 * 3
External Feature Access	50	650
Account Code	* #	* #
Hold	51	651
Hold Retrieve	52	652
Call Park-System	53	653
Call Park Retrieve - System	54	654
Call Park - Station	55	655
Call Park Retrieve - Station	56	656
Call Forwarding - All Call Set	* * 2	* * 2
Call Forwarding - Busy Set	* * 3	* * 3
Call Forwarding - No Answer Set	* * 4	* * 4
Call Forwarding - to Trunk	* * 5	* * 5
Call Forwarding - Busy/No Answer	* * 6	* * 6
Do Not Disturb Set	* * 1	* * 1
Call Forwarding/Do Not Disturb Cancel	##0	##0
Dial Call Pickup Deny Set	61 *	61 *
Dial Call Pickup Deny Cancel	61#	61#

Flexible Feature Numbers

Function	Default	
	Fixed 1	Fixed 2
Call Waiting Set	62 *	62 *
Call Waiting Cancel	62#	62#
BSS/OHCA Deny Set	63 *	63 *
BSS/OHCA Deny Cancel	63#	63#
Busy Override Deny Set	64 *	64 *
Busy Override Deny Cancel	64#	64#
Data Line Security Set	65 *	65 *
Data Line Security Cancel	65#	65#
Pickup Dialing Programming	660	660
Pickup Dialing Set	66 *	66 *
Pickup Dialing Cancel	66#	66#
Absent Message Set	* 4	6 * 4
Absent Message Cancel	#4	6#4
Timed Reminder Confirm	* 50	* 50
Timed Reminder Set	* 51	* 51
Timed Reminder Cancel	#5	#50
Voice Calling Mode Set	67 *	67 *
Voice Calling Mode Cancel	67#	67#
Voice Calling Deny Set	68 *	68 *
Voice Calling Deny Cancel	68#	68#
Speed Dialing - Station Programming	6 *	6 * 5
Station Lock Set	* 6	6 * 6
Station Lock Cancel	#6	6#6
Walking COS Set	* 7	6 * 7
Walking COS Cancel	#7	6#7
Walking Station Set	* 8	6 * 8
Walking Station Cancel	#8	6#8
Message Set	* 9	6 * 9
Message Cancel	#9	6#9
Station Program Clear	###	###
Message Waiting Reply	57	657
TIE Trunk Access	84	7
Night Mode Set	70 *	69 *
Night Mode Cancel	70#	69#
Night Service Manual Mode Set	71 *	51 *
Night Service Manual Mode Cancel	71#	51#
Flexible Night Service	72	520
Remote Station Lock Set	73 *	53 *
Remote Station Lock Cancel	73#	53#
Remote DND Set	74 *	54 *
Remote DND Cancel	74#	54#
Remote FWD Cancel	75	675
Remote FWD Cancel - One Time	76	676
BGM Through External Pager	77	677
Busy Out Trunk	78 *	57 *
Unbusy Trunk	78#	57#
OGM Record	791	691
OGM Playback	792	692
UCD Log In	* 0	6 * 0
UCD Log Out	#0	6#0
Remote Timed Reminder Confirm	7 * 0	5 * 0
Remote Timed Reminder Set	7 * 1	5 * 1
Remote Timed Reminder Cancel	7#	50#

Flexible Feature Numbers

Funktion	Default	
	Fixed 1	Fixed 2
Call Forwarding - Follow Me Set	* * 7	* * 7
Call Forwarding - Follow Me Cancel	* * 8	* * 8
Other PBX Extension 01	—	—
Other PBX Extension 02	—	—
Other PBX Extension 03	—	—
Other PBX Extension 04	—	—
Other PBX Extension 05	—	—
Other PBX Extension 06	—	—
Other PBX Extension 07	—	—
Other PBX Extension 08	—	—
Other PBX Extension 09	—	—
Other PBX Extension 10	—	—
Other PBX Extension 11	—	—
Other PBX Extension 12	—	—
Other PBX Extension 13	—	—
Other PBX Extension 14	—	—
Other PBX Extension 15	—	—
Other PBX Extension 16	—	—
Transfer	58	58
Conference	59	59

2.00 Directory Number (DN)

Description

Directory numbers are the software type logical numbers which are programmed to match the hardware type physical numbers (port numbers) attached to ports of extensions. Accordingly, directory numbers are extension numbers.

Directory numbers are assigned in “**Configuration-DN Assignment**” to be three or four digits. Only numeric characters “0 to 9” can be used as a Directory Number.

Directory number setting follows the setting in “System-Numbering Plan”, 1 st Hundred Block Extension through 16th Hundred Block Extension.

Programming

System Programming	Reference	
	VT	Dumb
“Configuration-ON Assignment”	9-c-3.00	10-c-3.00
“System-Numbering Plan”, 1st Hundred Block Extension	9-D-6.01 9-D-6.02	16-C-1 0.00
⋮		
⋮		
16th Hundred Block Extension		

Conditions

There are two types of directory numbers: the Primary Directory Number (PDN) and the Secondary Directory Number (SDN). For further details of PDN, refer to Section 4-B-3.01 “PDN Button.” For SDN, refer to Section 4-B-3.02 “SDN Button.”

If you assign **only** one digit in “System-Numbering Plan”, 1 st Hundred Block Extension through 16th Hundred Block Extension, you can assign **three-digit DNs** which start with the preassigned digit in “Configuration-DN Assignment.”

if you assign leading two digits in “**System-Numbering Plan**,” you can assign four-digit **DNs** which start with the pre-assigned two digits in “Configuration-DN Assignment.”

<Example>

System-Numbering Plan					
Numbering Plan (01/11)					
No.	Feature	DG1	DG2	DG3	DG4
1	1st Hundred Block Extension	5	-	-	-
2	2nd Hundred Block Extension	6	.	.	.
3	3rd Hundred Block Extension	7	0	.	.
4	4th Hundred Block Extension	8	0	.	.

DNs from 8000 to 8099 are assignable.

DNs from 7000 to 7099 are assignable.

DNs from 800 to 699 are assignable.

DNs from **500** to 599 are assignable.

7.02 Call Pickup Group

Description

Extensions belonging to a particular intercom group can be divided into call pickup groups which can execute the Dial Call Pickup feature. The call pickup group belonging to an intercom group is set by programming in the "Group-Call Pickup Group", ICM.

Up to 32 call pickup groups can be assigned in the system.

Extensions programmed into call pickup groups are set in the "Extension-Station", Pickup Group. It is not necessary for all extensions to be in a pickup group.

See Section 4-D-3.01 "Dial Call Pickup" for further information about the Dial Call Pickup feature.

Programming

System Programming	Reference	
	VT	Dumb
"Group-Call Pickup Group", ICM	9-E-3.00	10-C-17.00
"Extension-Station (1/3)", Pickup Group	9-G-1.01	10-C-22.00

Conditions

Different call pickup groups can have the same UCD and/or paging groups.

See Section 3-B-7.04 "Paging Group" for details on Paging Groups.

See the following Section 3-B-7.03 "Uniform Call Distribution (UCD) Group" for details on UCD Groups.

7.03 Uniform Call Distribution (UCD) Group

Description

It is possible to execute UCD functions in a group composed of one or more Call Pickup Groups. Such a group is called a UCD group.

The "Group-Call Pickup Group" screen determines which pickup group(s) will be in the UCD group.

Up to 32 UCD groups can be assigned in the system.

The UCD group and the call pickup group configuring the UCD group must belong to the same intercom group.

See Section 3-D-2.06 "Uniform Call Distribution (UCD)-without OGM" and Section 3-D-2.06 "Uniform Call Distribution (UCD)-with OGM" for further information about the UCD functions.

See the previous Section 3-B-7.02 "Call Pickup Group" for details on Call Pickup Groups.

See Section 3-B-7.01 "Intercom Group" for further information about ICM Groups.

Programming

System Programming	Reference	
	VT	Dumb
"Group-Call Pickup Group", UCD	19-E-3.00	10-C-17.00

Conditions

None

7.04 Paging Group

Description

It is possible to execute paging functions in a group composed of one or more pickup groups. Such a group is called a "Paging Group."

Up to eight paging groups can be assigned in the system.

When Tenant Service is employed, the 'Group-ICM/Paging Group' screen sets which tenant the paging group belongs to.

The "Group-Call Pickup Group" screen sets which pickup group(s) make up a paging group.

Programming

System Programming	Reference	
	VT	Dumb
"Group-ICM/Paging Group", Paging Group-Tenant	9-E-2.00	10-C-16.00
'Group-Call Pickup Group', PAG	9-E-3.00	10-G17.00

Conditions

If tenant service is employed, pickup groups which can be used to configure a paging group are limited within the same tenant.

See Section 4-H-I .OO "Paging" for further information about paging features.

7.05 Trunk Group

Description

To support efficient utilization of trunks, they can be grouped together (up to 16 groups) if all trunks in the group perform the same function. The following six kinds of trunk groups can be assigned in the system.

The items listed below are set in the "Group-Trunk Group" screen.

- (a) Trunk group type
- (b) Trunk group name
- (c) Tenant selection
- (d) Trunk group direction
- (e) Incoming destination (Day)
- (f) Incoming destination (Night)
- (g) Intercept Routing (Day)
- (h) Intercept Routing (Night)
- (i) Toll restriction level
- (j) Toll restriction table
- (k) Dialing plan selection
- (l) Disconnect time selection
- (m) Pause time selection
- (n) Hookswitch flash time selection
- (o) DID digit modification table selection
- (p) Entry of PBX access code (No restriction)
- (q) Entry of PBX access code (Restriction)
- (r) Restriction time on CO-CO calls
- (s) DIL (I:N) destination
- (t) Maximum number of digits after External Feature **Access**
- (u) CO-TIE Restriction
- (v) TIE-CO Restriction
- (w) TIE Forced Account Mode
- (x) TIE Incoming Delete Digit
- (y) TIE Incoming Insert Dial

The "Trunk-CO Line", Trunk Group determines which trunk group the CO line belongs to.

Programming

System Programming	Reference	
	VT	Dumb
"Group-Trunk Group"	9-E-1.01	10-C-14.00
	9-E-1.02	10-C-15.00
"Trunk-CO Line", Trunk Group	9-F-1.00	10-C-18.00

Conditions

A single CO line cannot belong to more than one trunk group.

9.00 Mixed Station Capacities

Description

The KX-T336 System supports a wide **range** of telephone sets, not only PITS (Proprietary integrated Telephone System) telephones but also Standard Rotary telephones (10 **pps/20** pps) and Standard Push-button telephones.

The PITS telephones can be categorized as follows:

KX-T308 system : KX-T30820
KX-T30830
KX-T30850

KX-T616 system : KX-I61620
KX-T6 1630
KX-T61650

KX-T1232 system: KX-T123220
KX-T123230
KX-T123230D
KX-T123235
KX-T123250

KX-T7000 series : **KX-T7020**
KX-T7030
KX-T7050
KX-T7130

Hybrid Line Circuits (HLC) card or Proprietary ITS Line Circuits (PLC) card are required for PITS telephones. Hybrid **Line Circuits (HLC) card** or Single Line Circuits (SLC) **card are required** for single line telephones.

The 'Configuration-Slot Assignment' screen defines which card is installed **in which slot**.

Programming

System Programming	Reference	
	VT	Dumb
"Configuration-Slot Assignment "	S-C-2.00	10-C-2.00

Conditions

None

10.00 Variable Time-Out

Description

The timer values listed below can be set and changed in system programming.

Common system timer values are set by the "System-System Timer" screen and "Special Attendant-DISA" screen. The timer values used with each trunk group are set by the "Group-Trunk Group" screen and the timer values used by the CO lines are set by the "Trunk-CO Line" screen. The timer values used with each extension are set by the "Extension-Station" screen.

System timer values:

- <1> Held Call Reminder
- <2> Held Call Reminder (Attendant)
- <3> Transfer Recall
- <4> Pickup Dial Waiting
- <5> External First Digit Time-Out
- <6> External Interdigit Time-Out
- <7> External Interdigit Time-Out (PBX)
- <8> Toll Restriction Guard **Time-Out**
- <9> Call Forwarding-No Answer Time-Out
- <1 Q> Intercept Routing-No Answer Time-Out (System)
- <11> Intercept Routing-No **Answer time-out** (DISA)
- cl 2> Attendant Overflow Time
- <1 3> SMDR Duration Time
- cl 4> TIE Interdigit Time-Out
- <15> Delayed Answer (DISA)
- <16> Prolonged Time (DISA)
- <17> Automatic Redial Retry Interval **(WS1)**
- <18> First Dial Timer **(WS2)**
- <19> First Dial Timer (DID) **(WS2)**

Trunk group timer values:

- <1> CO-CO **Duration Limit**
- <2> Disconnect Time
- <3> Pause Time
- <4> Hook Switch Flash Time

CO Line timer values:

- <1> DTMF Duration Time
- <2> CPC Detection Time (Incoming)
- <3> Wink Signal Time-Out

Station timer values:

- <1> Delayed Ringing (Day/Night)

Programming

System Programming	Reference	
		Dumb
"System-System Timer"	9-D-3.00	0-C-6.00
'Special Attended-DISA', Delayed Answer Prolong Time	9-K-1 .00	10-C-40.00
"Group-Trunk Group", CO-CO Duration Limit Disconnect Time Pause Time Hook Switch Flash time	9-E-1 .01	1 0-c-1 4.00
"Trunk-CO line", DTMF Duration Time CPC Detection Wink Signal Time-Out	9-F-1 .00	1 0-C-1 8.00
'Extension-Station', Day Ring Night Ring	9-G-1 .02	10-C-22.00
"World Select 1 (WS1)" Automatic Redial Retry Interval	—	1 0-c-51 .00
'World Select 2 (WS2)" First Dial Timer First Dial Timer (DID)	—	10-C-52.00

Conditions

None

Note:

- *1 This feature works if the extension user goes off-hook while the alarm tone is ringing for 2 minutes.
- *2 Tenant Service
 - If the tenant service is employed, each tenant (1 and 2) can have its unique wake-up message respectively.
 - In this case, **affiliations** of the wake-up message and the extension should be the same tenant.
- 3 Operating Status
 - Refer to Section 14-C-2.00 "Definition of Operating Status."
- ' OGM busy
 - Up to four extensions per **DISA** card can initially receive a wake-up message at a time.
- *5 BGM
 - To utilize BGM, set the usage of music source to "BGM" or "Hold & BGM."
(Refer to Section 9-F-2.00 "Pager and Music Source.")
- *6 From BGM to a wake-up message
 - The extension who currently hears BGM will hear the wake-up message instead of BGM when:
 - Next playback of the message begins.
 - A **DISA** resource is released, that is, the extension user goes on-hook after hearing the message.

14.00 TIE Lines

Description

A TIE line is a privately leased communication line between two or more PBXs, which provides cost effective communications between company members at different locations.

TIE lines can be used to call through KX-T336 to reach another switching system (PBX or CO). By utilizing the TIE lines, the **KX-T336** can support not only communications with the public network but with other locations of the company in the private network which your KX-T336 can be a part of.

To make a call to a person in a distant company location, an extension user must first obtain the appropriate TIE line to that person's PBX, and then dial the extension number only or a location number plus extension number.

A Network of TIE Lines

1. **Interfaced** by a TIE (E&M) channel of T-1 DIGITAL TRUNK card (Digital)

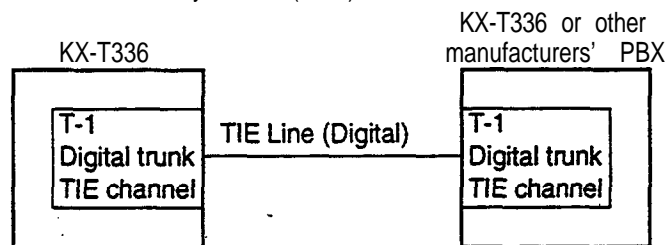

Hardware Requirements: T-1 DIGITAL TRUNK card (KX-T96187)

Numbering Plan: Extension users can make a call over the TIE Line Network to other extension users in a distant location by one of the following procedures.

1. Extension Number only (See Section 3-F-14.01 .)

- Extension Number
- CO (TIE) button + Extension Number
- Trunk Group Access Number + Extension Number

2. Location Number (PBX Code) + Extension Number (See Section 3-F-14101.)

- TIE Trunk Access Code + PBX Code + Extension Number
- CO (TIE) button + [Code] + Extension Number
- Trunk Group Access Number + PBX Code + Extension Number

Routing Procedure 1: Routing Table

Provides for the routing of calls over the TIE Line Network.

Up to 36 routing patterns can be programmed in this table.

This table is referenced by the system to identify the trunk route, when an extension user made a TIE call by dialing the feature number for "TIE Trunk Access," or Other PBX extension number. A routing pattern appropriate for each call is decided by the first one, two or three digits (except TIE trunk access code) of the dialed number.

. Routing Table Override

If a TIE call is made by pressing a CO key or dialing Trunk Group Access

Number, this table is not referenced by the system and the call is routed over the specified TIE trunk directly.

{Programming Example}

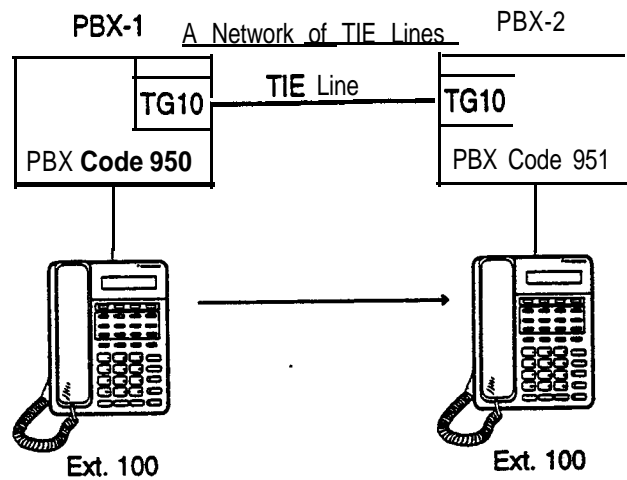

TIE Line Routing Table in PBX-1

No.	Code	Delete Digit	Insert Dial	Trunk Group Hunt Sequence		
				01	02	
01	951	0		10		
02						
:						

When **"84* (TIE Trunk Access Code)+951+100"** is dialed by an extension user, the routing pattern for this call is decided by **"951."**

Then the call is routed over **TG10** (Trunk Group 10 whose type is "TIE").

* Default for Fixed 1.

Routing Procedure 2: Routing Flow Chart

(1) When a TIE call is made by an extension user in your PBX

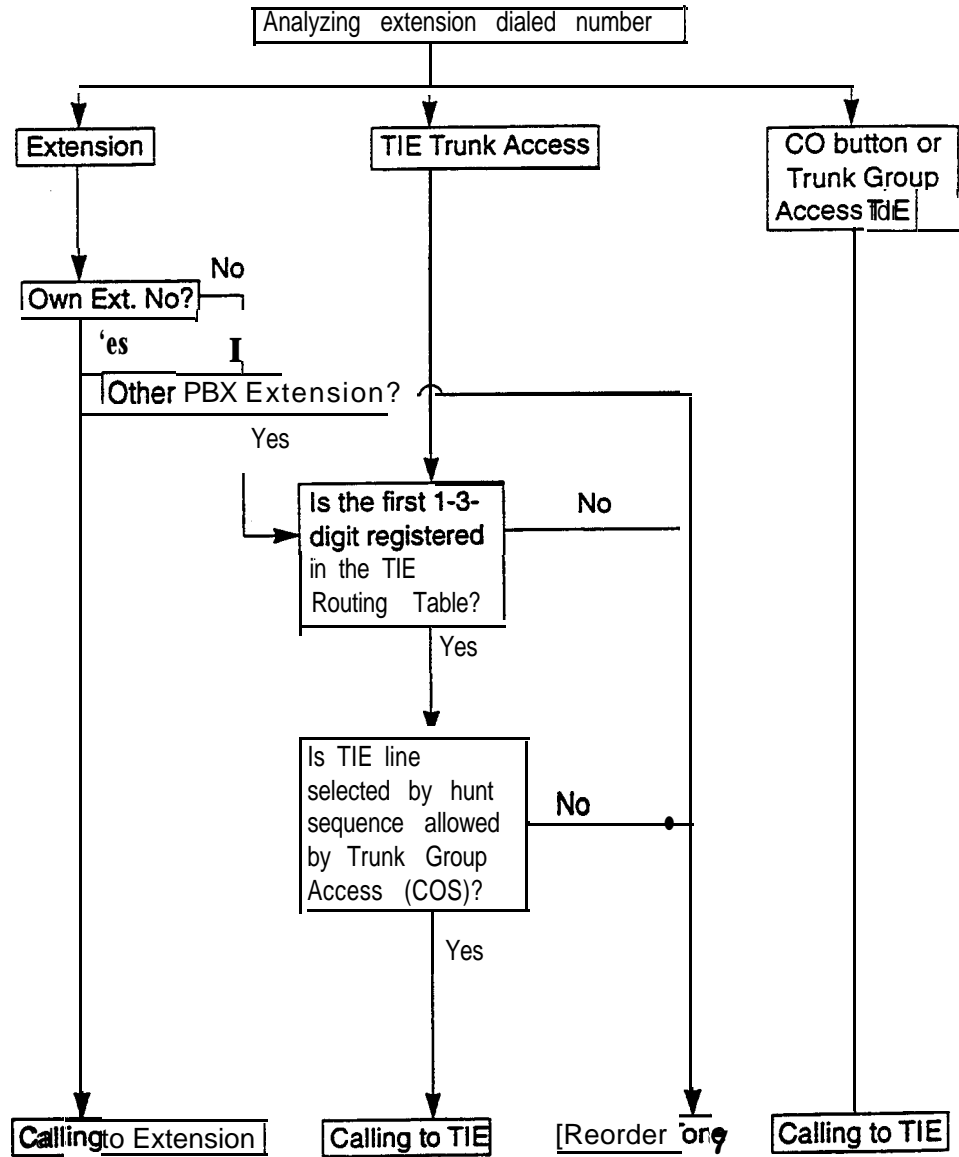

(Note)

TRLE = Toll Restriction Level of Extension
 TRLT = Toll Restriction Level of Trunk Group

Routing Procedure 2: (2) When a TIE call comes in on your PBX from other PBXs.

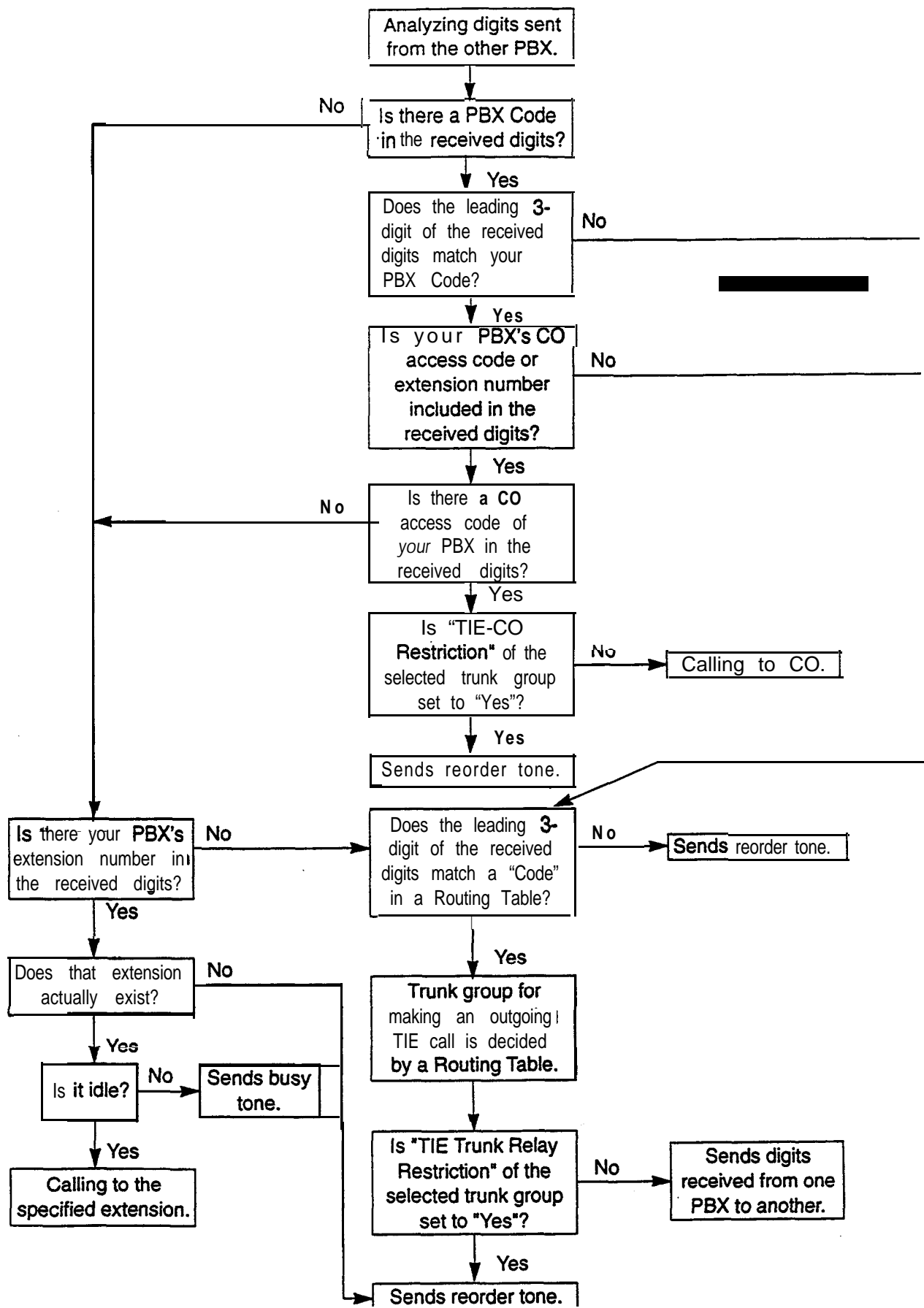

Programming

(1) Basic Programming

Always required to make use of TIE lines regardless of the type of applications.

System Programming	Reference	
	VT	Dumb
"Configuration — Slot Assignment"	9-c-2.00	10-C-2.00
"Configuration — Channel Assignment"	9-c-4.00	10-C-64.01
"Group -Trunk Group (1/2)", Type	9-E-1 .01	10-C-14.00
"Trunk- CO Line", Trunk Group	9-F-1 .00	10-C-18.00
"World Select 1 (WS1)", Flash Detect (TIE) Answer Decision Timer	—	10-C-51.00

(2) Timer programming

System Programming	Reference	
	VT	Dumb
"System-System Timer", TIE Interdigit Time-Out	9-D-3.00	10-C-6.00

(3) Application programming

Programming items required vary depending on the type of application. Refer to Section S-F-1 4.01 through 14.05 for further information about each application programming.

Conditions

- The treatment of the TIE calls is the same as that of extension and CO calls. TIE calls can be put on hold, be transferred to/forwarded to other extensions or trunks (CO, TIE).

14.01 Calling from TIE to TIE

Description TIE calls among several different company locations can be done by dialing a 3 or 4-digit extension number only, or by dialing a location number (PBX Code) and an extension number.

(1) By dialing Extension Number only

Description Extension users *can* make a call via TIE line to *other* extension users in other PBXs within a private network by simply dialing a 3 or 4-digit extension number.

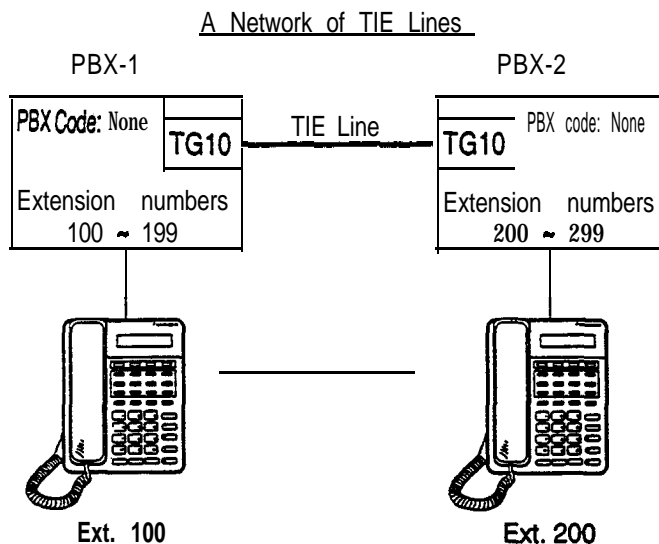

Call Flow

1. Ext.1 00 dials 200.
2. Ext.100 is connected to Ext.200 of PBX-2.

Programming example: To make up the TIE Line Network above, the following system programming is required at PBX-1 and -2 respectively.

PBX-1

- **System • Operation (1/3)-PBX** Code: (Blank)
- **System • Numbering Plan (9-D-6.00, 1 O-C-I 0.00)**
 - 1 st Hundred Extension 1
 - Other PBX Extension 01 2**
- **Special Attended • TIE Line Routing Table (9-K-4.00,10-C-65.01)**

No.	Code	Delete Digit	Insert Dial	Trunk Group Hunt Sequence		
				01	02	
01	2XX	0		10		

PBXQ

- **System • Operation (1/3)-PBX** Code: (Blank)
- **System • Numbering Plan**
 - 1st Hundred Extension 2
 - Other PBX Extension 01 1**
- **Special Attended • TIE Line Routing Table**

No.	Code	Delete Digit	Insert Dial	Trunk Group Hunt Sequence		
				01	02	
01	1XX	0		10		

Programming

System Programming	Reference	
	VT	Dumb
"System-Operation(1/3)", Numbering Plan	9-D-I .01	10-c-4.00
"System-Numbering Plan", TIE Trunk Access	9-D-6.00 9-D-6.10	10-C-I 0.00
Other PBX Extension 01-16	9-D-6.11	
"Special Attended-TIE Line Routing Table", Code	9-K-4.00	1 O-C-65.01
Delete Digit		
Insert Dial		
Trunk Group Hunt Sequence 01-05		

(2) By dialing Location Number (PBX code) and Extension Number

Description

Extension users can make a call to other extension users in other **PBXs** within a TIE line network by dialing a location number (PBX Code) and an extension number. Each PBX in the same TIE Line Network can have its own flexible extension numbering plan.

A Network of TIE Lines

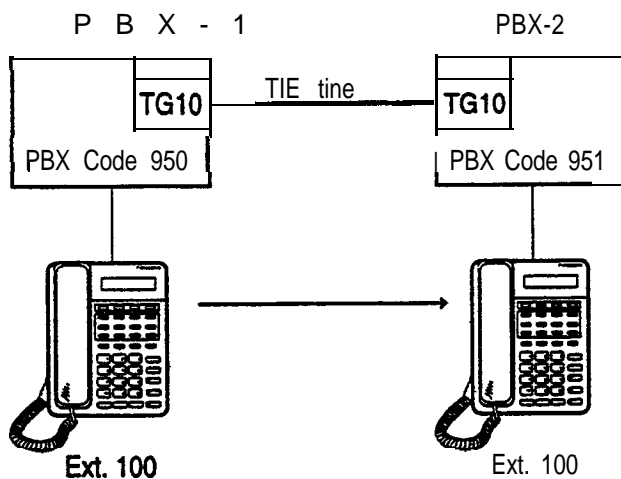

Call Flow

1. Ext.100 of **PBX-1** dials **84-951-100**.
2. Ext.100 of PBX-1 is connected to Ext.100 of PBX-2.

Programming example To make up the TIE Line Network above, the following system programming **is** required at PBX-1 and -2 respectively.

PBX-1

- System -Operation **(1/3)** (9-D-I .01, **10-C-4.00**)
PBX Code: 950
- System - Numbering Plan **(07/11)-TIE** Trunk Access: 34 (default)
- Special Attended - TIE Line Routing Table (9-K-4.00,1 O-C-65.01)

No.	Code	Delete Digit	insert Dial	Trunk Group Hunt Sequence		
				01	02	
01 02	951	0		10		

PBXB

- System • Operation (1/3)
PBX Code: 951
- System • Numbering Plan (07/11)-TIE Trunk Access: 84 (default)
- Special Attended • TIE Line Routing Table

No.	Code	Delete Digit	Insert Dial	Trunk Group Hunt Sequence		
				01	02	
01 02 :	950	0		10		

Programming

System Programming	Reference	
	VT	Dumb
" System-Operation(1/ 3)", PBX Code	9-D-1.01	10-C-4.00
"System-Numbering Plan", TIE Trunk Access	9-D-6.00 9-D-6.10	10-C-10.00
"Group-Trunk Group (2/2)", TIE Incoming Delete Digit TIE Incoming Insert Dial	9-E-1 .02	10-c-15.00
"Special Attended-TIE Line Routing Table", Code Delete Digit Insert Dial Trunk Group Hunt Sequence 01-05	9-K-4.00	10-c-65.01
"TIE Trunk Relay Restriction (TRR)		10-c-65.03

Operation

Making a TIE call

(A) By dialing an extension number



1. **Lift** the handset or press the SP-PHONE button.
 - You hear dial tone 1 or 3 or 4,

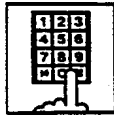

2. **Dial** the other **PBX's** extension number.
 - You hear **ringback** tone.

(B) By dialing a PBX code and an extension number



1. **Lift** the handset or press the SP-PHONE button.
 - You hear dial tone 1 or 3 or 4.

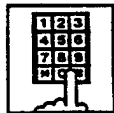

2. **Dial** the feature number for TIE Trunk Access **"84"** (default).
 - You hear dial tone 1.

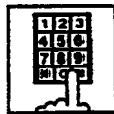

3. **Dial** the PBX code of the destination PBX and then the extension number of your destination party.
 - You hear **ringback** tone.

14.02 Calling from TIE to CO

Description

TIE Lines can be used to minimize the cost of calls to a distant location outside of the TIE Line Network. A long distance call from one location may be a local call from another location. This fact must be taken into consideration before making a long distance call.

If the destination of the long distance call is outside of the TIE Line Network, extension users first call to a distant PBX via TIE Line and then can make a local CO call to the final destination through that PBX.

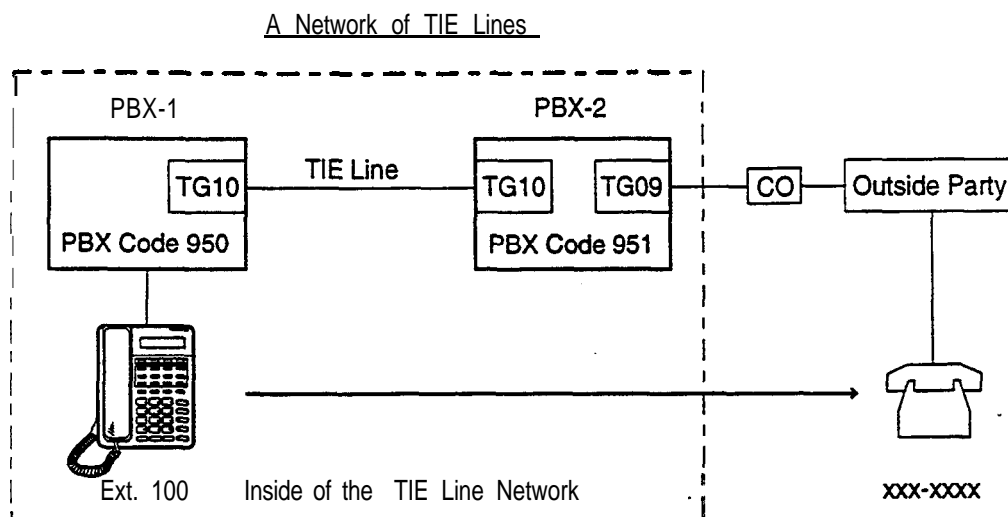

Call Flow

1. Ext.100 dials **84-951-9** (TIE Trunk Access Code + PBX Code + CO Access Code).
2. Ext.1 00 is required to enter a TIE account code*.
3. Ext.100 hears dial tone from an idle CO line of PBX-2.
4. Ext.100 dials xxx-xxxx (phone number of the outside party).

*Step 2 is required when "TIE Forced Account Code" Mode is set to "Yes" at PBX-2:

Programming example: To make up the TIE Line Network above, the following system programming is required at PBX-1 and -2 respectively.

PBX-1

- System • Operation (1/3) (9-D-1 .01 , 1 O-C-4.00)
PBX Code: 950
- Special Attended • TIE Line Routing Table (9-K-4.00, 10-C-65.01)

No.	Code	Delete Digit	Insert Dial	Trunk Group Hunt Sequence		
				01	02	
01	951	0		10		
02						

PBX-2

- System • Operation **(1/3)**
PBX Code: 951
- Group • Trunk Group **(2/2)** (9-E-I .02, 1 O-C-I 5.00)
Type: TIE
TIE - CO Restriction: No
TIE-Forced Account Code Mode: Yes
- Special Attended • TIE Line Routing Table

No.	Code	Delete Digit	Insert Dial	Trunk Group Hunt Sequence		
				01	02	
01	950	0		10		
02						

Programming

System Programming	Reference	
	VT	Dumb
“Group-Trunk Group (2/2) ”, TIE-CO Restriction TIE-Forced Account Code Mode TIE Incoming Delete Digit TIE Incoming insert Dial	9-E-1.02	10-c-15.00
“Special Attended-TIE Line Routing Table”, Code Delete Digit Insert Dial Trunk Group Hunt Sequence 01-05	9-K-4.00	10-c-65.01
“TIE Account Code (TAC) ”		1 O-C-65.02
“TIE Trunk Relay Restriction (TRR) ”		1 o-c-65.06

Conditions

1 .TIE-CO Restriction

Used to restrict or not extension users from ‘Calling from TIE to **CO.**’
To restrict, set to “Yes.” To allow, set to ‘No.’

2.TIE Account Code

Used to allow certain extension users “Calling from TIE **to CO.**”
If “Forced Account Mode” of the trunk group is set to “Yes”, an extension user must enter a valid TIE account code before ‘Calling from TIE to COP TIE Account Codes can be registered by using TAC command in the Dumb Programming **mode.** (Refer to Section 1 O-C-65.02 “TIE Account Code.”)

3.“Calling from TIE to CO” is available only when your system employs **PBX** Code (Location number) method for making/receiving TIE calls.

Operation



1. Lift the handset or press the SP-PHONE button.
 - You hear dial tone 1 or 3 or 4.

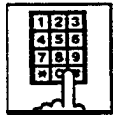

2. Dial the feature number for TIE Trunk Access "84" (default).
 - You hear dial tone 1,

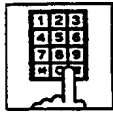

3. Dial the PBX code and a CO access code of the destination PBX.

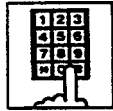

4. Dial a TIE Account Code (if required).

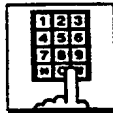

5. Dial the telephone number of the outside party.

14.03 Calling from CO to TIE

Description

TIE lines are usually used to link two or more distant locations where high volume calling traffic exists. However, a person at a location outside of the Tie Line Network can also use it by first making a CO call via public network to the nearest point of TIE Line Network for the purpose of saving the toll call charge.

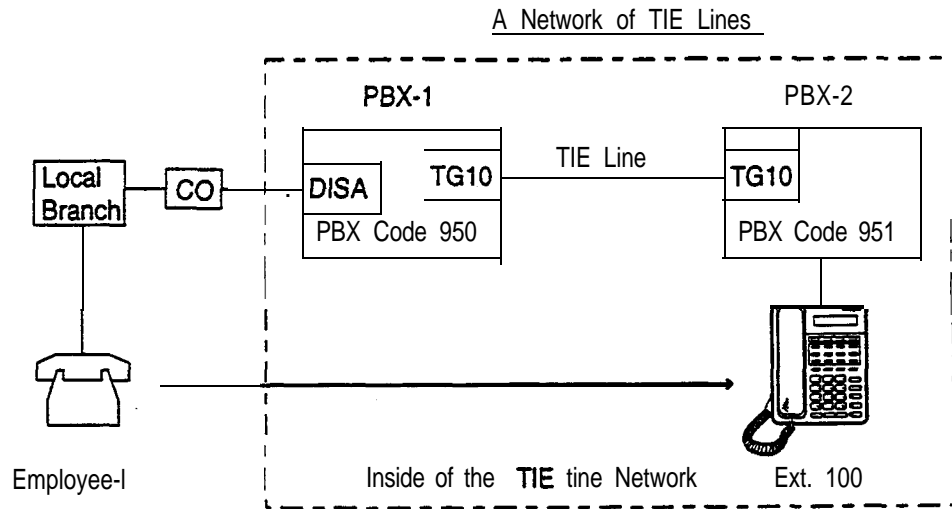

Call Flow

1. Employee-I at a local branch makes a CO call to PBX-1 via DISA.
2. Employee-I dials "84" (TIE trunk access code).
3. After hearing dial tone, Employee-I dials 951-100.
4. Employee-I at a local branch will be connected to Ext.1 00 of PBX-2.

Programming example: To make up the TIE Line Network above, the following system programming is required at PBX-1 and -2 respectively.

- PBX-1
- System -Operation (1/3) (9-D-1 .01 , 10-C-4.00)
PBX Code: 950
 - Group - Trunk Group (2/2) (9E-1.02, 1 O-C-1 5.00)
CO-TIE Restriction: **No***
 - This assignment is required at the trunk group whose 'Incoming Mode' is set to **"DISA"**.
 - Special Attended - TIE Line Routing Table

No.	Code	Delete Digit	Insert Dial	Trunk Group Hunt Sequence	
				01	02
01	951	0		10	
02					
:					

• System • Operation (1/3)
PBX Code: 951

• Special Attended • TIE Line Routing Table

No.	Code	Delete Digit	insert Dial	Trunk Group Hunt Sequence		
				01	02	
01 02	950	0		10		

Programming

System Programming	Reference	
	VT	Dumb
“Group-Trunk Group (2/ 2)”, CO-TIE Restriction TIE Incoming Delete Digit TIE Incoming Insert Dial	9-E-1.02	10-c-15.00
“Special Attended-TIE Line Routing Table”, Code Delete Digit Insert Dial Trunk Group Hunt Sequence 01-05	9-K-4.00	10-C-65.01
“TIE Trunk Relay Restriction (TRR)”		10-C-65.03

Operation

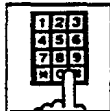

1 .Dial the **DISA** phone number.
• You hear **ringback** tone.



2.You hear the **DISA** outgoing message.

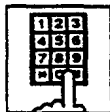

3.Dial the feature number for TIE Trunk Access ‘84’ (default).

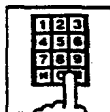

4.Dial the PBX code of other PBX and then the extension number of your party.
• You hear **ringback** tone.

14.04 Alternate Routing

Description

When more than two **PBXs** at different locations are interconnected with a network of TIE Lines, your KX-T336 works as an intermediate switching office to other **PBXs** in the network by relaying tie calls from one **PBX** to another.

A problem of telephone switching is that blocking sometimes occurs on the network, and a call cannot be switched as required because all the lines on a given route are occupied or unavailable.

By utilizing this relay function, several alternative routes can be set up beforehand in addition to the primary-route. This permits TIE calls to be routed from "A to B" or "A through C to B" and so on.

If the primary-route is poor because of equipment failure or congestion, **KX-T336** bypasses it and selects the secondary-route.

On receipt of a TIE call, **KX-T336** analyzes it to determine the destination to which the call must be sent or the route by which the calls will be sent, and then transmit it.

Alternate Routing makes a TIE Line Network more flexible in adapting to peaks of traffic and it provides a variety of different routing plans.

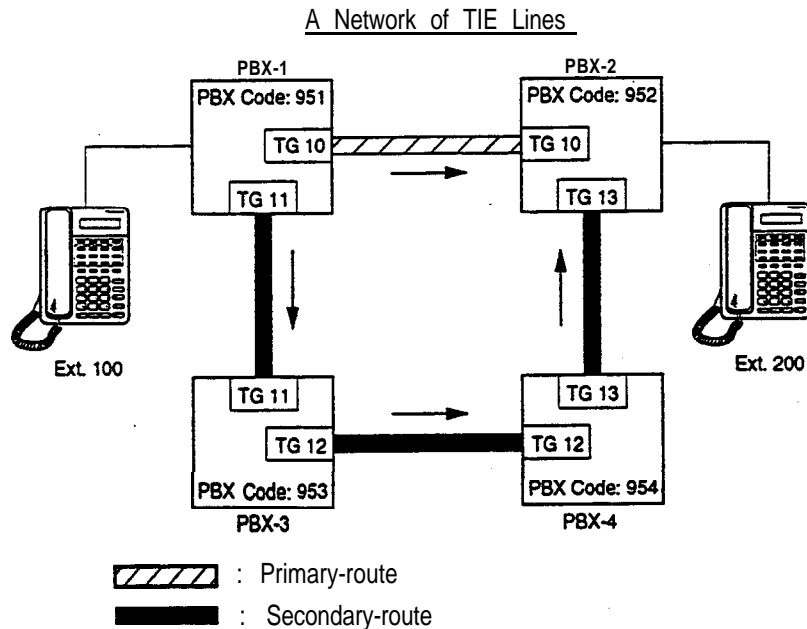

Call Flow

1 Ext.1 00 dials "84+952+200."

2. When "952" is found in the table, TG10 (Hunt Sequence 01 for "952") is selected automatically.

- If **TG10** is not available, **TG11** (Hunt Sequence 02) will be selected.

In this case, the call is sent to PBX-2 via **PBX-3** and -4.

The treatment of the call is decided by Routing Table of PBX-3 and then PBX-4.

3. The call is sent to PBX-2.

Programming example: To realize the call flow mentioned in the previous page, the following system programming is required at PBX-1, -3, and -4 respectively.

PBX-1

- System -Operation **(1/3)** (9-D-I .01 , 1 O-C-4.00)
PBX Code: 951
- Special Attended • TIE Line Routing Table (9-K-4.00, 10-C-65.01)

No.	Code	Delete Digit	insert Dial	Trunk Group Hunt Sequence	
				01	02
01	952	0		10	11
02	953			11	10

- TIE Trunk Relay Restriction (TRR) (10-C-65.03)

PBX-3

- System -Operation **(1/3)**
PBX Code: 953
- Special Attended • TIE Line Routing Table

No.	Code	Delete Digit	Insert Dial	Trunk Group Hunt Sequence	
				01	02
01	952	0		12	
02					

- TIE Trunk Relay Restriction (TRR)

PBX-4

- System -Operation **(1/3)**
PBX Code: 954
- Special Attended • TIE Line Routing Table

No.	Code	Delete Digit	Insert Dial	Trunk Group Hunt Sequence	
				01	02
01	952	0		13	
02					
:					

- TIE Trunk Relay Restriction (TRR)

Note:

If you want to restrict **"call** relay from PBX-1 to PBX-2 via **PBX-3**", set **"TG11"** to 'Yes' at PBX-3 using TRR command.

Programming

System Programming	Reference	
	VT	Dumb
"Group-Trunk Group (2/ 2)", CO-TIE Restriction TIE-CO Restriction TIE incoming Delete Digit TIE incoming Insert Dial	9-E-1.02	10-C-15.00
"Special Attended-TIE Line Routing Table", Code Delete Digit Insert Dial Trunk Group Hunt Sequence 01-05	9-K-4.00	1 O-C-65.01
"TIE Trunk Relay Restriction (TRR)"		1 O-C-65.03

15.00 T-I Carrier

Description

The T-I carrier is a hierarchy of digital systems designed to carry **approx. 1.544** Mbps. speech and other signals in digital form. The T-I carrier has 24 PCM (Pulse Code Modulation) voice channels.

T-I DIGITAL TRUNK Card (KX-T96187) and CSU (Channel Service Unit) are required to utilize T-I carrier with KX-T336 System. This card supports five different trunk interfaces to provide desired connection at minimum expense. One of the following five trunk types can be assigned to one of 24 voice channels of T-I DIGITAL TRUNK card individually according to tariffs and customer need.

type of interface : **LCO/GCO/DID/OPX/TIE**

T-I line

The installer must arrange for the following parameters with the Central Office or T-I provider:

**Type of Interface: LCO/GCO/DID/OPX/TIE, Frame format: D4 (SF)/ESF
Line coding: AMI/B8ZS, Signaling: DP/DTMF**

CSU (Channel Service Unit)

The installer must provide a CSU to connect the T-I line to the KX-T96187. The CSU must support the following functions:

- : Protection for the Central Office line
- : Loop Back
- : Performance Monitoring

Programming

System Programming	Reference	
	VT	Dumb
"Configuration — Slot Assignment"	9-c-2.00	1 o-C-2.00
"Configuration — DN Assignment"	9-c-3.00	1 O-c-3.01
"Configuration — Channel Assignment" T-I card	9-c-4.01	1 O-C-64.01
"System Clock Mode (CLK)"	—	1 O-C-64.02
"Master Clock Priority (CLP)"	—	1 O-C-64.03
"ESF Frame Option (EFO)"	—	1 o-c-64.04

Description

(1) Up to six T-I DIGITAL TRUNK cards (144 ports) can be installed to the system under the following conditions.

System Configuration

Basic shelf	HLC+PLC+SLC+OPX+DID+LCOT+ GCOT+T-1	12 cards (96 ports)*
Expansion shelf	HLC+PLC+SLC+OPX+DID+LCOT+ GCOT+T-1	15 cards (120 ports)'
Fully Expanded system	HLC+PLC+SLC+OPX+DID+LCOT+ GCOT+T-1	42 cards (336 ports)'

*T-I is counted as 3 cards.

(2) Physical port number for each T-I trunk channel is as follows:

Slot No.	T-I Channel	Port No.
Slot 01	ch 01-08	X011-X018
	ch 09-16	X021-X028
	ch 17-24	X031-X038
Slot 05	ch 01-08	X051-X058
	ch 09-16	X061-X068
	ch 17-24	X071-X078
Slot 09	ch 01-08	X091-X098
	ch 09 -16	X101-X108
	ch 17-24	X111-X118

X: Shelf No. (1 =Basic, 2=Expansion 1, 3=Expansion 2)

(3) DN Assignment is required when a channel of T-I card is **assigned** as 'OPX.

(4) Select the external clock mode, if your system is interfaced by T-I interface with another exchange. Refer to Section 1 O-C-64.02 'System Clock Mode **(CLK)**' and Section 1 O-C-64.03 "Master Clock Priority (CLP)."

Maintenance

The following two test commands are provided for T-I DIGITAL TRUNK Card.

- Loop Back Test (LBT) - Section 15-E-3.01
- DTMF-Generator/Receiver Test (DTM) - Section 15-E-3.02

16.00 Limited Call Duration

Description

Limited Call Duration is a system programmable feature that disconnects a CO call when a pre-specified time expires. A warning tone is sent to the extension user 15 seconds before the time limit. Limiting the call duration can be enabled or disabled on a COS (Class of Service) basis for each extension.

Programming

System Programming	Reference	
	VT	Dumb
"Limited Call Duration (LCD)"	—	10-C-69.00

Conditions

- This feature applies to incoming CO calls only, outgoing CO calls only or both incoming and outgoing CO calls depending on the system programming.
- Call duration time limit is ranging from 01 to 60 minutes depending on the system programming.
- Call duration time of any CO call (except a CO-to-CO call) can be limited by this feature. CO-to-CO Call Duration timer applies to a CO-to-CO call.
- This feature does not apply to CO calls to/from an Attendant Console.
- This feature is available with the following version of the software.

V.12.XX or higher version

	Page
4.00 Automatic Dialing	4-c-1 0
4.01 One Touch Dialing	4-c-1 0
4.02 Speed Dialing-System	4-c-1 1
4.03 Last Number Redial (LNR)	4-c-1 4
4.04 Automatic Redial	4-c-1 5
4.05 Saved Number Redial (SNR)	4-C-1 6
5.00 Making Internal Calls	4-c-1 7
5.01 Inter Office Calling	4-c-1 7
5.02 Intercom Calling	4-C-1 8
5.03 Intercom-Voice Calling	4-c-1 9
5.04 Intercom-Busy Station Signaling (BSS)	4-C-20
5.05 Intercom Off-Hook Call Announcement (OHCA)	4-C-21
6.00 Automatic Callback	4-c-22
6.01 Automatic Callback-Trunk	4-C-22
6.02 Automatic Callback-Station	4-C-24
7.00 Executive Busy Override	4-C-25
8.00 Do Not Disturb (DND) Override	4-C-26
9.00 Walking COS (Class of Service)	4-C-27
10.00 Operator Call	4-C-28
D Receiving Features	4-D-1
1.00 Line Selection-Answering	4-D-1
1.01 Ringing Line Preference-Answering..	4-D-1
1.02 Prime Line Preference-Answering	4-D-2
1.03 No Line Preference-Answering	4-D-3
1.04 Direct Answering (Pre-selection)	4-D-3
2.00 Intercom Answer	4-D-4
2.01 Intercom Hands-Free Answerback	4-D-4
2.02 Intercom Answer Voice Calling Deny	4-D-5
2.03 Intercom Answer BSS/OHCA Deny	4-D-6
3.00 Call Pickup	4-D-7
3.01 Dial Call Pickup	4-D-7
3.02 Directed Call Pickup	4-D-8
3.03 Call Pickup Deny	4-D-9
4.00 Trunk Answer From Any Station (TAFAS)-Day Service..	4-D-10
5.00 Executive Busy Override Deny..	4-D-11
6.00 Do Not Disturb (DND)	4-D-1 2
7.00 Call Waiting	4-D-15
8.00 Uniform Call Distribution (UCD)-Log Out	4-D-1 7

	Page
E Holding Features	4-E-1
1.00 Hold	4-E-1
2.00 Exclusive Hold	4-E-2
3.00 Consultation Hold	4-E-3
4.00 Call Hold Retrieve-Station	4-E-5
5.00 Call Park	4-E-6
5.01 Call Park-System	4-E-6
5.02 Call Park-Station	4-E-8
6.00 Call Splicing	4-E-1 0
F Transferring Features	4-F-1
1.00 Call Transfer	4-F-1
1.01 Unscreened Call Transfer to Station	4-F-1
1.02 Screened Call Transfer to Station..	4-F-2
1.03 Screened Call Transfer to Trunk	4-F-3
1.04 Ringing Transfer..	4-F-4
1.05 Unscreened Call Transfer to Remote	4-F-5
1.06 Unscreened Call Transfer to Attendant Console..	4-F-5-1
1.07 Unscreened Call Transfer to a UCD Group (with OGM)	4-F-5-2
2.00 Call Forwarding (FWD)	4-F-6
2.01 Call Forwarding-All Calls	4-F-6
2.02 Call Forwarding-Busy/Off-Hook	4-F-9
2.03 Call Forwarding-No Answer	4-F-1 2
2.04 Call Forwarding-Busy/Off-Hook/No Answer..	4-F-1 5
2.05 Call Forwarding to Trunk	4-F-18
2.06 Call Forwarding-Follow Me..	4-F-21
G Conversation Features	4-G-1
1 .00 Programmable Privacy	4-G-1
2.00 Privacy Release	4-G-2
3.00 Privacy Attach..	4-G-3
4.00 Hands-Free Conversation	4-G-4
5.00 Conference	4-G-5
5.01 Conference-One Appearance	4-G-5
5.02 Conference-Two Appearances	4-G-7
6.09 Unattended Conference..	4-G-9
6.01 Unattended Conference-One Appearance	4-G-9
6.02 Unattended Conference-Two Appearances	4-G-1 1
7.00 Doorphone	4-G-13
8.00 Flash	4-G-14
9.00 External Feature Access	4-G-1 5
10.00 Microphone Mute..	4-G-16
11.00 intercom Off-Hook Call Announcement (OHCA)	4-G-1 7
12.00 Tone Through (End to End DTMF Signaling)	4-G-1 8

2.05 Call Forwarding to Trunk

Description

Call Forwarding to Trunk allows extension users who are away from their phones to receive incoming calls (both CO and extension) at outside place.

The following incoming calls do not receive Call Forwarding treatment.

- A call appearing on ICM button
- A call from doorphone
- A call appearing on PCO button
- A call routed via DIL 1: N feature
- A call directed to a UCD group

When an incoming CO call is forwarded to the pre-assigned outside party by this feature, CO to CO call via this system is established. Duration time of CO to CO call is restricted by "Group-Trunk Group," CO-CO Duration Limit of receiving CO line. The system sends alarm tone to both parties 15 seconds before the Duration Limit time is expired, and when expired the system disconnects both parties compulsively.

To set Call Forwarding to Trunk, assign both "System-Class of Service", Call Forwarding/Do Not Disturb and CO forward Mode to "Yes."

For setting and canceling this function, two methods are available:

- <1 > By pressing the **FWD/DND** button.
- <2> By dialing the feature number for "Call Forwarding-to Trunk" and "Call Forwarding/Do Not Disturb Cancel."

Programming

System Programming	Reference	
	VT	Dumb
'System-Class of Service (1/2) Call Forwarding/Do Not Disturb CO Forward Mode	9-D-4.0'	10-C-7.00
"System-Numbering Plan (04/11)", Call Forwarding-to Trunk	9-D-6.0'	10-C-10.00
'System-Numbering Plan (05/11)", Call Forwarding/Do Not Disturb Cancel	9-D-6.0'	10-C-10.00
"Group-Trunk Group (1/2)", CO-CO Duration Limit	S-E-1 .01	10-C-14.00

Conditions

To set or cancel this function, use the PDN button.

An extension user may have only one type of Call Forwarding/Do Not **Disturb** feature in effect at any time. If a second type is assigned, the previously assigned type is canceled.

The Operators (Attendant Console or Extension) can cancel the Call Forwarding/Do Not Disturb feature assigned to the extension users. Refer to Section 4-I-11 .00 'Remote Station Feature Control.'

Up to 32 digits composed of "0 through 9" and "*" can be entered as the telephone number of the destination. CO line access code must be entered as the leading digit of each entry.

Note:

- If CPC signal is not supplied by the Central Office in your area, KX-T336 cannot detect the end of CO-CO call after one party disconnects the call.
In this case, we recommend to use tone detection feature of AGC Card (See Section 1 0-C-67.00 "DISA/AGC Tone Detection Mode (TDM)").

The following table shows the results of the calls arriving at an extension setting this function depending on the conditions of the preset destination.

Type of Call Arriving at Setting Extension	Condition of Destination	Forwarding Execution	Result
Extension call	Idle status	○	Call is forwarded to external destination.
	Busy status	✕	Call is placed on setting extension.
	Conditions except In Service 🖱		
DIL (1 :1) or DISA call	Idle status	○	Call is forwarded to external destination.
	Busy status	✕	Call is placed on setting extension.
	Conditions except In Service 🖱		
DID call	Idle status	✕	Call is placed on setting extension.
	Busy status		
	Conditions except In Service 🖱		

- : Forwarding possible
- ✕ : **Forwarding** impossible
- 🖱 Conditions are 'Out of Service? "Fault" and 'Pm-Installed." See Section **14-C-2,02** 'Port" for details.

Operation

Setting Call Forwarding to Trunk



1. Lift the handset or press the SP-PHONE button.

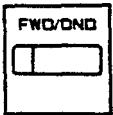

2. Press the **FWD/DND** button, then dial "5."

Or, dial the feature number for "Call Forwarding to Trunk."

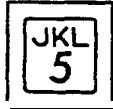

3. Dial the feature number for selecting the CO line and the telephone number of the destination and "#" in succession.

- You hear confirmation tone 1 or 2 and then dial tone 1 or 3 or 4.
- If your PITS has a display, it shows:

<Example>

FWD (CO) 92011234

If the assigned number exceeds the display capacity:

FWD (CO) 9201123 &



4. Replace the handset or press the SP-PHONE button.,

- The indicator on the **FWD/DND** button starts flashing.

(Supplement)

The system does not check the dialed number, toll restriction level, and the feature number for selecting a CO line when the extension user is setting this function.

Canceling Call Forwarding to Trunk



1. Lift the handset or press the SP-PHONE button.

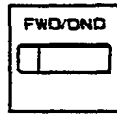

2. Press the **FWD/DND** button, then dial "0."

Or, dial the feature number for "Call Forwarding/Do Not Disturb Cancel."



- You hear confirmation tone 1 or 2 and then dial tone 1 or 3 or 4.
- If your PITS has a display, it shows:

FWD/DND Cancel



3. Replace the handset or press the SP-PHONE button.

(Supplement)

Type **50** and KX-17050 PITS telephones are not provided with the **FWD/DND** button. Only the PF3 button on them can be programmed to be the **FWD/DND** button.

Refer to Section 9-G-1 .03 "Station (3/3)" and Section 12-C-2.00 "PF Button Assignment" for further information.

2.06 Call Forwarding-Follow Me

Description

You can set the "Call Forwarding-All calls" feature from the destination extension. This is useful if you forget to set "Call Forwarding -All Calls" feature before you leave your desk or when you move from **pre-set** place to another. This feature can be enabled or disabled on a **COS (Class of Service) basis**. If enabled, an extension user can set this feature.

Programming

System Programming	Reference	
	VT	Dumb
'System-Numbering plan (09/11)', Call Forwarding-Follow Me Set	9-D-6.09	10-C-10.00
Call Forwarding-Follow Me Cancel "Call Forwarding-Follow Me (CFM)"	-	10-C-68.00

Conditions

Same as 'Call Forwarding-All Calls' (Section 4-F-2.01).

Operation

Setting 'Call Forwarding-Follow Me' at the destination extension



1. Lift the handset or press the SP-PHONE button.



2. Press the **FWD/DND** button, then dial '7'.
Or, dial the feature number for Call Forwarding-Follow Me Set " * * 7 " (default).



3. Dial the directory number of your extension.

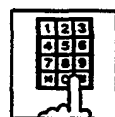

- You hear confirmation tone 1 or 2 and then dial tone 1 or 3 or 4.
- If your PITS has a display, it shows:

FWD (From) Ext xxxx



Directory number: three or four digits



4. Replace the handset or press the SP-PHONE button.

- The indicator on the **FWD/DND** button starts flashing at your own extension.

Canceling "Call Forwarding-Follow Me" at the destination extension



1. Lift the handset or press the SP-PHONE button.

- The indicator light flashing on the **FWD/DND** button goes out.



2. Press the **FWD/DND** button, then dial "8."

Or, dial the feature number for Call Forwarding-Follow Me Cancel " * * 8 " (default).



3. Dial the directory number of your extension.

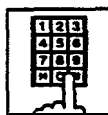

- You hear confirmation tone 1 or 2 and then dial tone 1 or 3 or 4.
- If your PITS has a display, it shows:

FWD Cancel Exxx

4. Replace the handset or press the SP-PHONE button.



Note:

You can cancel this feature at your own extension by following the same procedure as canceling other call forwarding features.

G. Conversation Features

1 .00 Programmable Privacy

Description

The extension user can intrude on a busy line by pressing the red lit PDN, SDN or **SCO** button, if the system is set to non-privacy.

In default mode, the system is set to privacy.

This means that a third party cannot intrude on a busy line.

It is administrable to make system privacy or **non-privacy** by "System-Operation", Privacy on DN Key.

Programming

System Programming	Reference	
	VT	Dumb
"System-Operation (1/3)", Privacy on DN Key	9-D-1 .01	10-C-4.00

Conditions

The table shows the other party to **be** barged in by pressing the red lit PDN, SDN and Single CO buttons in the non-privacy system.

Button Pressed	A call to be barged in
PDN	A call on the SDN button owned by this PDN.
SDN	A call on PDN button which is owner (including SLT) of this SDN.
SCO	A call on the pressed Single CO button.

Privacy and non-privacy can be temporarily changed.

For further details, refer to Section 4-G-2.00 "Privacy Release" and Section 4-G-3.00 "Privacy Attach.*"

In privacy and non-privacy system, pressing a button which is lit in red results in the following:

1. In privacy system:

Pressing PDN or SDN	Pressing SCO, GCO, or PCO
Ignored	Cause Automatic Callback-Trunk *

2. In non-privacy system:

Pressing PDN or SDN	Pressing SCO	Pressing GCO or PCO
Allows a three party conver-sation (ignored if conference trunk is unavailable ¹)	Allows a three party conversatia (reorder tone sounds if confer-ence trunk is unavailable)	Cause Automatic Callback-Trunk *

* Refer to Section 4-C-5.01 "Automatic **Callback-Trunk.**"

Operation

Intruding on a busy line in non-privacy system

The following example shows the procedure to be used by extension B whose SDN is owned by the PDN of extension A, who is talking with party C on the PDN button.

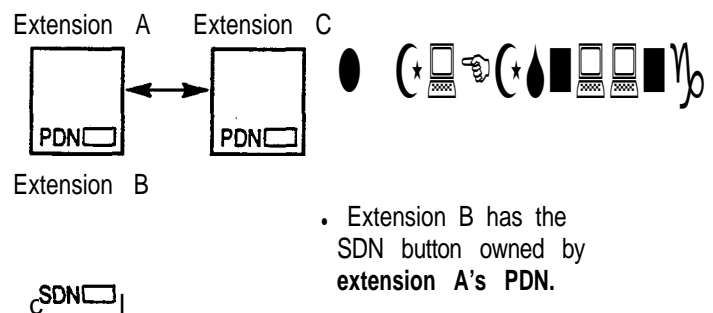

The indicator on the SDN button of extension B is lit in **red**.

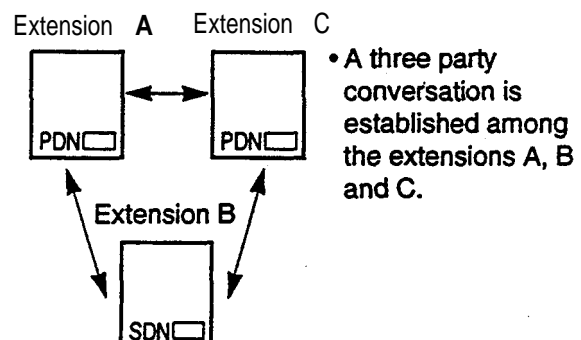
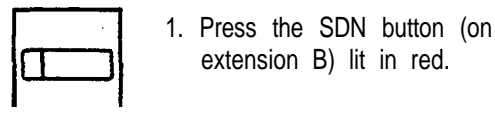

	Page
D Transferring Features	5-D-1
1 .00 Call Transfer	5-D-1
1.01 Unscreened Call Transfer to Station..	5-D-1
1.02 Screened Call Transfer to Station..	5-D-2
1.03 Unscreened Call Transfer to Remote..	5-D-3
1.04 Unscreened Call Transfer to Attendant Console..	5-D-3-1
1.05 Unscreened Call Transfer to a UCD Group (with OGM)	5-D-3-2
1.06 Screened Call Transfer to Trunk	5-D-3-3
2.00 Call Forwarding (FWD)	5-D-4
2.01 Call Forwarding-All Calls	5-D-4
2.02 Call Forwarding-Busy/Off-Hook	5-D-7
2.03 Call Forwarding-No Answer	5-D-1 0
2.04 Call Forwarding-Busy/Off-Hook/No Answer	5-D-1 3
2.05 Call Forwarding to Trunk	5-D-i 6
2.06 Call Forwarding-Follow Me	5-D-19
E Conversation Features	5-E-1
1 .00 Conference	5-E-1
2.00 Doorphone	5-E-2
3.00 External Feature Access	5-E-3
F Paging Features	5-F-1
1.00 Paging	5-F-1
1.01 Paging All Extensions	5-F-1
1.02 Group Paging	5-F-3
1.03 Paging External Pagers	5-F-5
1.04 Paging All Extensions and External Pagers	5-F-7
2.00 Background Music (BGM) through External Pager	5-F-8
G Other Features	5-G-1
1 .00 Night Service	5-G-1
1 .01 Universal Night Answer (UNA)	5-G-1
1.02 Flexible Night Service	5-G-2
1.03 Switching of Day/Night Mode	5-G-3
2.00 Account Code Entry	5-G-5
3.00 Timed Reminder	5-G-7
4.00 Data Line Security	5-G-9
5.00 Absent Message Capability	5-G-1 0
6.00 Message Waiting	5 - G - 1 2
7.00 Electronic Station Lock Out	5-G-14
8.00 Assigned Feature Clear	5-G-15
9.00 Remote Station Feature Control	5-G-16

A. Outgoing Call Features

1 .00 Making Outside Calls

1.01 Local Trunk Dial Access

Description

Allows extension users to make outgoing CO calls by automatic selection of an idle CO line. Dialing the feature number for **ARS/Local CO Line Access** enables you to execute this function.

To activate this feature, set 'System-**Operation**', **Automatic** Route Selection to 'No.' If set to "Yes," ARS feature is activated instead of this feature.

Refer to Section 3-C-2.00 "Automatic Route Selection (**ARS**)" for further information.

Programming

System Programming	Reference	
	VT	Dumb
'System-Operation (1/3)', Automatic Route Selection	9-D-1.01	10-C-4.00
"System-Local Access Group", Hunt Sequence	9-D-5.00	10-C-9.00
'System-Numbering Plan (02/11)', ARS/Local CO Line Access	9-D-6.02	10-C-10.00

Conditions

An idle CO line available and hunting sequence is determined by the system programming "System-Local Access Group", Hunt Sequence.

If an extension user hears busy tone, there is no idle CO line available.

If an extension user hears reorder tone, the user is restricted from accessing this feature.

Refer to Section 3-C-I .01 **Toll** Restriction for Local Trunk Dial Access," for **further** information.

If tenant service is activated, accessible trunk group is limited to the trunk groups within the same tenant.

(◆ for U.S.A. and Canada only)

The dialing plan followed is that of the trunk group in hunt sequence 01 in "System-Local **Access** Group."

Operation



1. Lift the handset .
 - You hear dial tone 1 or 3 or 4.



2. Dial the feature number for **ARS/Local** CO Line Access "9" (default).
 - You hear dial tone 1."

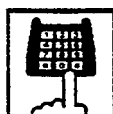

3. Dial the telephone number of the outside party.

D. Transferring Features

1 .00 Call Transfer

Description

Transfer is convenient to redirect a call to another place. Attendant assistance is not required and the caller does not have to redial.

SLT Transfer Operation

When SLT Transfer Operation mode is set to "Mode **2**", an SLT user can transfer a call to an outside party.

Reference

- Section 5-D-I .06 "Screened call Transfer to Trunk"
- Section 1 O-C-53.00 "World Select **3**"

1 .01 Unscreened Call Transfer to Station

Description

Allows an extension user to transfer calls (both extension and outside calls) to another extension without announcement.

Programming

System Programming	Reference	
	VT	Dumb
"World Select 3 (WS3)" SLT Transfer Operation	—	10-C-53.00

Conditions

If transferred call is not answered by the destination party, it will receive one of the following treatments.

Status of Destination	Operation Resulted
Able to receive the call (sending ringback tone)	Performs the call to the destination for a specific period. In case of no answer, interrupts ringing and starts ringing to the originator of transfer. 1 For detail, refer to Section 3-E-3.00 "Transfer Recall."
Busy (sending busy tone)	As soon as the destination goes on-hook , starts calling the destination (Camp-on Transfer). If the destination party remains busy or does not answer the call within a specified period, starts calling back the originator of transfer. 1 For detail, refer to Section 3-E-3.00 "Transfer Recall. "
Setting Do Not Disturb (sending DND tone)	Unscreened Call Transfer to extension is ineffective. Transferred party is treated simply as a party placed on Consultation Hold. Hanging up causes the Consultation Hold Recall to the originator of transfer

- 1** When the originator of transfer answers the call, conversation **between** the originator and the transferred party starts.

The extension users can not transfer the following calls.

- A call with Attendant Console
- A call with Doorphone

If Music on Hold is available, from the start of the transferring operation until the destination party answers, the system sends Music on Hold (See Section 3-E-I .00 "Music on Hold,") to the party while he or she is being transferred.

Instead of Music on Hold, **Ringback** Tone can be sent to the caller while he or she is being transferred (See Section 1 O-C-53.00 "World Select 3 (WS3)").

Operation -1 (Mode 1)

While having a conversation;

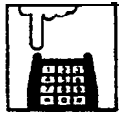

1. Press the switchhook for approximately one half second and release it.

- The other party is placed on Consultation Hold.
- You hear confirmation tone 2 and then dial tone 1 or 3 or 4.



2. Dial the directory number of the destination: three or four digits.

- You hear **ringback** tone.
- **Ringback** starts at the destination extension.



3. Replace the handset.

Note:

- If you want to return to the held party, press the switchhook for approximately **one half** second and release it before the destination extension answers.

Operation -2 (Mode 2)

While having a conversation;

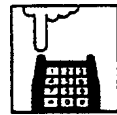

1. Press the switchhook for approximately one half second and release it.

- The other party is placed on Consultation Hold.
- You hear confirmation tone 2 and then dial tone 1 or 3 or 4.

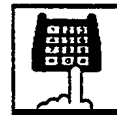

2. Dial the feature number for Transfer "58" (default).

- You hear confirmation tone 2 and then dial tone.

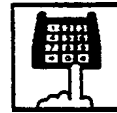

3. Dial the directory number of the destination: three or four digits.

- You hear **ringback** tone.
- Ringing starts at the destination extension.



4. Replace the handset.

Note:

- If the feature number for "Transfer" is not dialed at step 2, the call **will** be disconnected after replacing the handset.
- If you want to return to the held party at step 3 above, press the **switchhook** for approximately one half second and release it before the destination extension answers.

1.02 Screened Call Transfer to Station

Description

Allows an extension user to transfer the calls (both extension and outside calls) to another extension with announcement.

Programming

System Programming	Reference	
	VT	Dumb
"World Select 3(WS3)" SLT Transfer Operation	—	10-C-53.00

Conditions

The extension user cannot transfer the following calls.

- A call with Attendant Console
- A call with Doorphone

If Music on Hold is assigned, Music on Hold is sent to the transferred party since the party starts being transferred until he starts conversation with the destination party.

For further detail, refer to Section 3-E-I .00 "Music on Hold."

The user can execute this function even after holding another party.

Operation • 1 (Mode 1)

While having a conversation;



1. Press the switchhook for approximately one half second and release it.

- The other party is placed on Consultation Hold.
- You hear confirmation tone 2 and then dial tone 1 or 3 or 4.

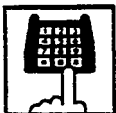

2. Dial the directory number of the destination: three or four digits.

- You hear **ringback** tone.



3. Wait for the answer and announce.



4. Replace the handset.

- The call is transferred to the destination.

Note:

If you want to return to the held party, press the switchhook for approximately one half second and release before the destination extension answers.

Operation • 2 (Mode 2)

While having a conversation:

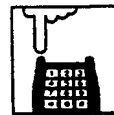

1. Press the switchhook for approximately one half second and release it.

- The other party is placed on Consultation Hold.
- You hear confirmation tone 2 and then dial tone 1 or 3 or 4.

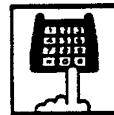

2. Dial the feature number for Transfer "58" (Default).
- You hear confirmation tone 2 and then dial tone.



3. Dial the directory number of the destination: three or four digits.
- You hear **ringback** tone.



4. Wait for the answer and announce.



5. Replace the handset.
- The call is transferred to the destination.

Note:

*If you want to return to the held party, press the switchhook for approximately one half second and release it before the destination extension answers.

- If the feature number for "Transfer" is not dialed at step 2, the call will be disconnected after replacing the handset.

1.03 Unscreened Call Transfer to Remote

Description

Allows an extension user to transfer-a call to the remote maintenance resource. (Available with Software Version 9.5X and above). Modem answer tone is returned instantly, if it is not in use. This operation allows System Administrator to perform System Administration from Remote Location.

Refer to Section 14-B-2.00 "System Administration from a Remote Location" for further information.

To transfer a call to remote maintenance resource, 'FDN for Remote' is used, which is assigned in 'System-Operation', Remote Directory Number.

See Section 3-B-3.00 'Floating Directory Number (FDN)' for details of FDN.

Programming

System Programming	Reference	
	VT	Dumb
"System-Operation (2/3)", Remote Directory Number	9-D-1.02	10-C-4.00
"World Select 3 (WS3)" SLT Transfer Operation	—	10-C-53.00

Conditions

If Music on Hold is assigned, the system sends Music on Hold to the transferred party during the transferring operation. For details, refer to Section 3-E-1 .00 "Music on Hold."

If the remote maintenance port is in use, busy tone is returned to the held party. Automatic Callback does not function in this case, so the caller should call again when it becomes idle.

Operation -1 (Mode 1)

While having a conversation;



1. Press the switchhook for approximately one half second and release it.
 - The other party is placed on Consultation Hold.
 - You hear confirmation tone 2, then dial tone 1 or 3 or 4.

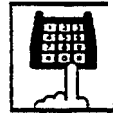

2. Dial the "FDN for Remote": three or four digits.

- You hear confirmation tone 3, then dial tone 1 or 3 or 4.
- If the remote maintenance port is not in use, the held party hears answer tone and can start communication instantly.



3. Replace the handset.

Operation -2 (Mode 2)

While having a conversation;



1. Press the switchhook for approximately one half second and release it.

- The other party is placed on Consultation Hold.
- You hear confirmation tone 3, then dial tone 1 or 3 or 4.

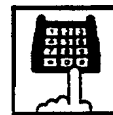

2. Dial the feature number for Transfer "58" (Default).

- You hear confirmation tone 2 and then dial tone.



3. Dial the 'FDN for Remote': three or four digits.

- You hear confirmation tone 3, then dial tone 1 or 3 or 4.
- If the remote maintenance port is not in use, the held party hears answer tone and can start communication instantly.



4. Replace the handset.

1.04 Unscreened Call Transfer -to Attendant Console

Description

Allows an extension user to transfer calls (both extension and outside) to an Attendant Console without announcement.

Programming

System Programming	Reference	
	VT	Dumb
'World Select 3(WS3)* SLT Transfer Operation	—	10-c-53.00

Conditions

1) Transfer Recall

A call transferred by this feature will **not** ring back at the extension who transferred the call even if the Attendant Console does not answer the call after the transfer recall timer has been elapsed.

2) Intercept Routing No Answer (IRNA)

A call transferred to an Attendant Console will not be transferred to another extension by **IRNA** feature even if the Attendant Console does not answer the call after the **IRNA** timer has been **elapsed**.

3) What if all six Loop keys on the Attendant Console are not idle?

A call is put in the call waiting queue of the Attendant Console.

4) What if the Attendant Console is in ATT-FWD mode?

This feature does not function.
A call is simply put on Consultation Hold, that is, a call will ring back at the extension who tries to transfer the call as soon as he or she goes on-hook.

5) Music on Hold

If Music on Hold is available, the system sends Music on Hold to the transferred party, from the start of the transferring operation till the destination party answers.

Instead of Music on Hold, **Ringback** Tone can be **sent** to the caller while he or she is being transferred (See Section 10-C-53.00 "World Select 3 (WS3)").

Operation -1 (Mode 1)

While having a conversation;

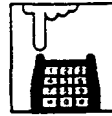

1. Press the switchhook for approximately one half second and release it.

- The other party is put on **Consultation Hold**.
- You hear confirmation tone 2 and then dial tone 1 or 3 or 4.



2. Make a call to an Attendant Console.

- You hear **ringback** tone.
- Calling an Attendant Console starts.



3. Replace the handset.

- At an Attendant Console:
The call is displayed as a transfer recall.

Operation -2 (Mode 2)

While having a conversation;



1. Press the switchhook for **approximately one half second** and release it.

- The other party is put on **Consultation Hold**.
- You hear confirmation tone 2 and then dial tone 1 or 3 or 4.

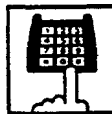

2. Dial the feature number for Transfer "**58**"(Default).



3. Make a call to an Attendant Console.

- You hear **ringback** tone.
- Calling an Attendant Console **starts**.

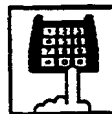

4. Replace the handset.
 - At an Attendant Console:
The call is displayed as a transfer recall.

Note:

The feature numbers and **DN's** for making a call to an Attendant Console are:

- Operator Call (General)
- Operator Call (Specific)
- FDN for General Operator Call
- DN for ATT1 and **ATT2**

1.05 Unscreened Call Transfer -to a UCD Group (with OGM)

Description

Allows an extension user to transfer an outside call to a UCD Group from 01 to 04 (with OGM type).

From version 8.XX, not only the operators but any extension user can transfer an outside call to a UCD group (with OGM).

Programming

System Programming	Reference	
	VT	Dumb
"Special Attended-UCD (1/2)"	9-K-3.01	10-C-44.00
"World Select 3 (WS3)" SLT Transfer Operation	—	10-C-53.00

Conditions

If all group members are not available to answer the call, it will be redirected to the Overflow destination. In this case, the call will be disconnected if not answered by the Overflow destination within 60 seconds.
See page 3-D-I 3 for further information.

Operation -1 (Mode 1)

While having a conversation:

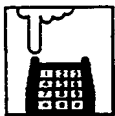

- 1 Press the switchhook for approximately one half second and release it.
 - The other party is put on Consultation Hold.
 - You hear confirmation tone 2 and then dial tone 1 or 3 or 4.

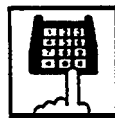

- 2 Dial the FDN for UCD group (01 to 04).
 - You hear confirmation tone 3 and then dial tone 1 or 3 or 4.



- 3 Replace the handset.

Operation -2 (Mode 2)

While having a conversation;

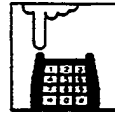

1. Press the switchhook for approximately one half second and release it.
 - The other party is put on Consultation Hold.
 - You hear confirmation tone 2 and then dial tone 1 or 3 or 4.

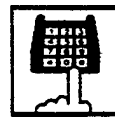

2. Dial the feature number for Transfer **"58"(Default)**.
 - You hear confirmation tone 2 and then dial tone.

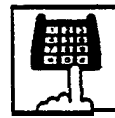

3. Dial the FDN for UCD group (01 to 04).
 - You hear confirmation tone 3 and then dial tone 1 or 3 or 4.



4. Replace the handset.

Feature References

Uniform Call Distribution (UCD)-with/without OGM (Section 3-D-2.06)

1.06 Screened Call Transfer to Trunk

Description

Allows an extension user to transfer calls (both extension and outside) to an outside party with announcement.

Available when "SLT Transfer Operation" is set to "Mode 2".

To execute this function, assign 'System-Class of Service', CO Transfer mode to "Yes."

If outside call is transferred to another outside party, CO-CO conversation mode is established and the duration of the conversation is restricted by "Group-Trunk Group", CO-CO Duration Limit.

Programming

System Programming	Reference	
	VT	Dumb
"System-Class of Service (1/2)", CO Transfer Mode	9-D-4.01	10-C-7.00
"System-Numbering Plan (1 1/11)", Transfer	9-D-6.11	10-C-10.00
"Group-Trunk Group (1/2)", CO-CO Duration Limit	9-E-1.01	10-C-14.00
"World Select 3 (WS3)" SLT Transfer Operation	—	10-C-53.00

Conditions

If a call from outside party is transferred to another outside party, CO-CO conversation mode is established. In this case, the system uses the preset time limit for the trunk group that the transferred party is placed **on, not** using the time limit for the trunk group used to call the destination and alarm tone is sent to parties 15 seconds before the assigned time limit, and when time is out, both CO lines are disconnected.

The extension users can not transfer the following calls.

- A call with Attendant Console
- A call with Doorphone

If Music on Hold is available, from the start of the transferring operation until the destination party answers, the system sends Music on Hold to the transferred party.

For further detail, refer to Section 3-E-1 .00 "Music on Hold."

Operation (Mode 2)

While having a conversation;



1. Press the switchhook for approximately one half second and release it.

- The other party is placed on Consultation Hold.
- You hear confirmation tone 2 and then dial tone 1 or 3 or 4.



2. Dial the feature number for Transfer "58" (Default).

- You hear confirmation tone 2 and then dial tone.

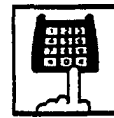

3. Call another outside party

- You hear **ringback** tone from the CO line.



4. When the destination answers, make the announcement.



5. Replace the handset.

- The call is transferred to the destination.

Note:

*If an extension that cannot execute this function (by COS restriction) attempts to do this procedure, the system sends a consultation hold recall to the extension after step 5 and the transfer is rejected.

•If you want to return to the held party, press the switchhook for approximately one half second and release it before the destination answers.

• If CPC signal is not supplied by the Central Office in your area, KX-T336 cannot detect the end of CO-CO call after one party disconnects the call. In this case, we recommend to use tone detection feature of AGC Card (See Section 1 O-C-67.00 "DISA/AGC Tone Detection Mode (TOM)").

2.00 Call Forwarding (FWD)

2.01 Call Forwarding-All Calls

Description

Call Forwarding-All Calls allows extension users who are away from their phones to receive incoming calls (both extension and CO) to them at another extension.

Incoming calls can be forwarded either to extension users, Voice Mail port, or operators (Attendant Console or Extension).

"FDN for General Operator Call" can be used to assign operators as the destination of Call Forwarding.

Refer to Section 9-D-I .01 "Operation (1/3)" for further information.

The following incoming calls do not receive Call Forwarding treatment.

- A call from doorphone
- A call routed via DIL 1: N feature
- A call directed to a UCD group

To execute Call Forwarding-All Calls, assign "System-Class of Service", **Call Forwarding/Do Not Disturb** to "Yes."

To set and cancel this function, dial the feature number for "Call Forwarding-All Calls **Set**" and "Call Forwarding-Do Not Disturb Cancel."

Programming

System Programming	Reference	
	VT	Dumb
'System-Class of Service (1/2)", Call Forwarding/Do Not Disturb	9-D-4.01	10-C-7.00
"System-Numbering Plan (04/11)", Call Forwarding-All Call Set	Q-D-6.04	10-C-10.00
"System-Numbering Plan (05/11)", Call Forwarding/Do Not Disturb Cancel	9-D-6.05	10-C-10.00

Conditions

An extension user may have only one type of Call Forwarding/Do Not Disturb feature in effect at any time. If a second type is assigned, the previously assigned type is canceled.

If the extension to which calls are to be forwarded itself is in a call forward mode, a call is not forwarded furthermore. The call rings at the first forwarded extension. In case of an outside call, if not answered in a specified time period, the call will be routed to another destination, if available, based on the "Intercept Routing-No Answer" feature.

If Tenant Service is employed and "Inter Tenant Calling" is assigned to "Yes" by programming, this function is ineffective for the calls from another tenant if the destination of Call Forwarding-All Calls is set to an Attendant Console.

Calls from any VM extension will not be forwarded, if forwarding destination is another VM extension.

The following attempt will be rejected with reorder tone.

- If Tenant Service is employed, the user cannot set the destination to an extension in the other tenant.
- To call the other extension whose call forwarding destination is set to his or her own extension.

The Operators (Attendant Console or Extension) can cancel the Call Forwarding/Do Not Disturb feature assigned to the extension users. Refer to Section 5-G-9.00 "Remote Station Feature Control."

Operation

Setting Call Forwarding-Busy/Off-Hook/No Answer



1. Lift the handset.



2. Dial the feature number for "Call Forwarding-Busy/No Answer."



3. Dial the directory number of the extension or the Voice Mail port, or the 'FDN for General Operator Call' to be set as the destination.

- You hear confirmation tone 1 or 2 and then dial tone 1 or 3 or 4.



4. Replace the handset.

Canceling Call Forwarding-Busy/Off-HooWNo Answer



1. Lift the handset.

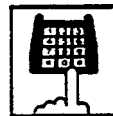

2. Dial the feature number for "Call Forwarding/Do Not Disturb Cancel."

- You hear confirmation tone 1 or 2 and then dial tone 1 or 3 or 4.



3. Replace the handset.

2.05 Call Forwarding to Trunk

Description

Call Forwarding to Trunk allows extension users who are away from their phones to receive incoming calls (both CO and extension) at outside place.

When an incoming CO call is forwarded to the pre-assigned outside party by this feature, CO to CO call via this system is established. Duration **time of** CO to CO call is restricted by “Group-Trunk Group,” CO-CO Duration Limit of receiving CO line. The system sends alarm tone to both parties 15 seconds before the Duration Limit time is expired, and when expired the system disconnects both parties compulsively.

The following incoming calls do not receive Call Forwarding treatment.

- A call from doorphone
- A call routed via **DIL** 1: N feature
- A call directed to a UCD group

To set Call Forwarding to Trunk, assign **both** “System-Class of **Service**”, Call Forwarding/Do Not Disturb and CO Forward Mode to “**Yes**.”

To set and cancel this function, dial the feature number for “Call Forwarding-To Trunk’ and “Call Forwarding/Do Not Disturb Cancel.”

Programming

System Programming	Reference	
	VT	I Dumb
“System-Class of Service (1/2)”, Call Forwarding/Do Not Disturb CO Forward Mode	Q-D-4.01	10-c-7.00
“System-Numbering Plan (04/11)”, Call Forwarding-to Trunk	9-D-6.04	10-c-10.00
“System-Numbering Plan (05/11)”, Call Forwarding/Do Not Disturb Cancel	Q-D-6.05	10-c-10.00
“Group-Trunk Group (1/2)”, CO-CO Duration Limit	9-E-1.01	10-c-14.00

Conditions

An extension user may have only one type of Call Forwarding/Do Not Disturb feature in effect at any time. If a second type is assigned, the previously assigned type is canceled.

The Operators (Attendant Console or Extension) can cancel the Call Forwarding/Do Not Disturb feature assigned to the extension users. Refer to Section 5-G-9.00 “Remote Station Feature Control.”

Up to 32 digits composed of “0 through **9**” and “*****” can be entered as the telephone number of the destination. CO line access code must be entered as the leading digit of each entry.

Note:

- If CPC signal is not **supplied** by the Central Office in your area, KX-T336 cannot detect the end of CO-CO call after one party **disconnects** the call.

In this case, we recommend to use tone detection feature of **AGC** Card (See **Section 1 0-C-67.00 “DISA/AGC Tone** Detection Mode (TDM”).

2.05 Call Forwarding-Follow Me

Description

You can set a 'Call Forwarding' feature from the destination extension. This is useful if you forget to set "Call Forwarding -All Calls" before you leave your desk or when you move from pre-set place to another.

This feature can be enabled or disabled on a COS (Class of Service) basis. If enabled, an extension user can set this feature.

Programming

System Programming	Reference	
	VT	Dumb
"System-Numbering plan (09/11)". Call Forwarding-Follow Me Set	9-D-6.09	10-C-10.00
Call Forwarding-Follow Me Cancel		
"Call Forwarding-Follow Me (CFM)	—	10-C-68.00

Conditions

Same as 'Call Forwarding-All Calls' (Section 5-D-2.01).

Operation

Setting "Call Forwarding-Follow Me" at the destination extension



1. Lift the handset.

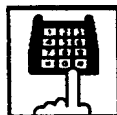

2. Dial the feature number for Call Forwarding-Follow Me Set **"* * 7"** (default).

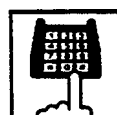

3. Dial the directory number of your extension.
 - You hear confirmation tone 1 or 2 and then dial tone 1 or 3 or 4.



4. Replace **the** handset.

Canceling "Call Forwarding-Follow Me" at the destination extension.



1. Lift the handset.

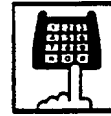

2. Dial the feature number for Call Forwarding-Follow Me Cancel **"* * 8"** (default).

- You hear confirmation tone 1 or 2 and then dial tone 1 or 3 or 4.



3. Dial the directory number of your extension.

- You hear confirmation tone 1 or 2 and then dial tone 1 or 3 or 4.



4. Replace the handset.

Note:

You can cancel this feature at your own extension by following the same procedure as canceling other forwarding features.

E. Conversation Features

1 .00 Conference

Description

Allows an extension user to add a third-party to a two-party conversation and make a three-party conference.

An extension user can have the following combination of calls on the line:

- three extensions
- one extension and two outside parties
- two extensions and one outside party

On the TSW card, there are eight standard conference trunks provided for this purpose. By equipping the optional conference expansion card (**KX-T336104**), the number of conference trunks increases to 64. To utilize optional conference expansion card, assign 'Configuration-System Assignment', TSW Additional CONF to 'Yes.'

When two members in the conference are both outside parties, two conference trunks are necessary. In all other cases, one conference trunk is enough.

Programming

System Programming	Reference	
	VT	Dumb
"Configuration-System Assignment", TSW Additional CONF	9-C-1 .00	1 o-c-1 .00
"System-Numbering Plan (1 1/1 1)" Conference	9-D-6.1 1	1 o-c-1 0.00
World Select 3 (WS) SLT Transfer Operation	-	10-c-53.00

Conditions

Pressing the switchhook by the conference originator during the conference restores a conversation with the first party. This places the second party on Consultation Hold.

Pressing the switchhook again establishes the conference again if the conference trunk is available. If the conference trunk is not available, conversation with the held (second) party starts, placing the first party on Consultation Hold.

Operation

Establishing a conference - 1 (Default mode) (SLT Transfer Operation is in Mode 1)

While having a two-party conversation;

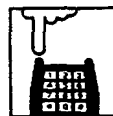

1. Press the switchhook for approximately one half second and release it.

- The other party is placed on Consultation Hold.
- You hear confirmation tone 2 and then dial tone 1 or 3 or 4.



2. Dial the phone number of the third party.



3. Press the switchhook for approximately one half second and release after the third party answers.

- You hear confirmation tone 3.
- A three-party conference is now established.

Establishing a conference - 2 (SLT Transfer Operation is in Mode 2)

While having a two-party conversation;

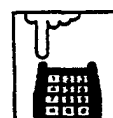

1. Press the switchhook for approximately one half second and release it.

- The other party is placed on Consultation Hold.
- **You hear confirmation tone 2** and then a dial tone 1 or 3 or 4.



2. Dial the feature number for conference "58" (default).

- **You hear** confirmation tone 1 and then a dial tone.



3. Dial the phone number of the third party.

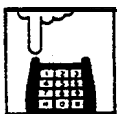

4. Press the switchhook for approximately one half second and release it after the third party answers.

- You hear confirmation tone 3.
- A three-party conference is now established.

Note:

If the conference trunk is not available in step 3, you cannot establish conference by pressing the switchhook, which puts the third party on Consultation Hold, and conversation with the held party starts.

Concluding a conference



1. Replace the handset.
 - The other two parties may continue their conversation.
 - If the other two parties are both outside parties, they will be disconnected.

Talking to the original party while holding the third party

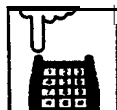

1. Press the switchhook for approximately one half second and release it.
 - You hear confirmation tone.
 - You can talk to the original **party.**

2.00 Doorphone

Description

Up to four doorphones can be connected to the system. This provides conversations between extensions and **doorphones**.

Any extension user can call the doorphones within the same tenant by dialing the feature number for 'Door-phone Call (1 to 4).’ It is possible to direct calls from doorphones to specified extensions, intercom groups, pickup groups or Attendant Consoles in "Extension-Doorphone", Doorphone Call Assignment.

If Tenant Service is employed, the affiliation of each doorphone can be determined by the system programming in "Extension- Doorphone", Tenant.

Set the duration of the door opener in "Extension-Doorphone", Open Duration. When Open Duration is set to "0," the door opener is unavailable.

Programming

System Programming	Reference	
	VT	Dumb
"System-Numbering Plan (03/11)", Doorphone Call (1 to 4) "Extension-Doorphone"	9-D-6.03	10-C-10.00 10-C-27.00
	9-G-3.00	

Conditions

Only conversations are available for the door-phone. The other functions such as Hold, Transfer are all ineffective.

When a visitor presses the **button on the doorphone**, he hears **ping-pong tone twice**, then doorphone call ringing starts at the designated extension.

No answer of the call in 15 seconds cancels the doorphone call.

Operation

Calling from a doorphone



1. Press the button on the doorphone.
 - You hear ping-pong tone.
 - When the other party answers, start conversation.

Answering a doorphone call

When your telephone set receives a doorphone call and rings,



1. Lift the handset.
 - Start conversation with the caller from the doorphone.

Calling a doorphone



1. Lift the handset.

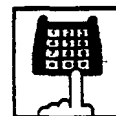

2. After dialing the feature number for Doorphone Call (1 to 4) "40" (default), dial the **doorphone** number : 1 to 4.
 - After hearing confirmation tone 3, start conversation over the specified doorphone.



3. After concluding conversation, replace the handset.

Opening the door

During a conversation over the doorphone



1. Press the switchhook for approximately one half second and release it.

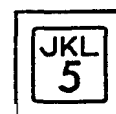

2. Dial "5."
 - The door opens for the specified duration.

3.00 Returning to Previous Screen

To return to the previous screen, press the PF2 key.
The illustration below shows the operation, starting from the Setting Screen and returning to the Main Menu screen.

<Example>

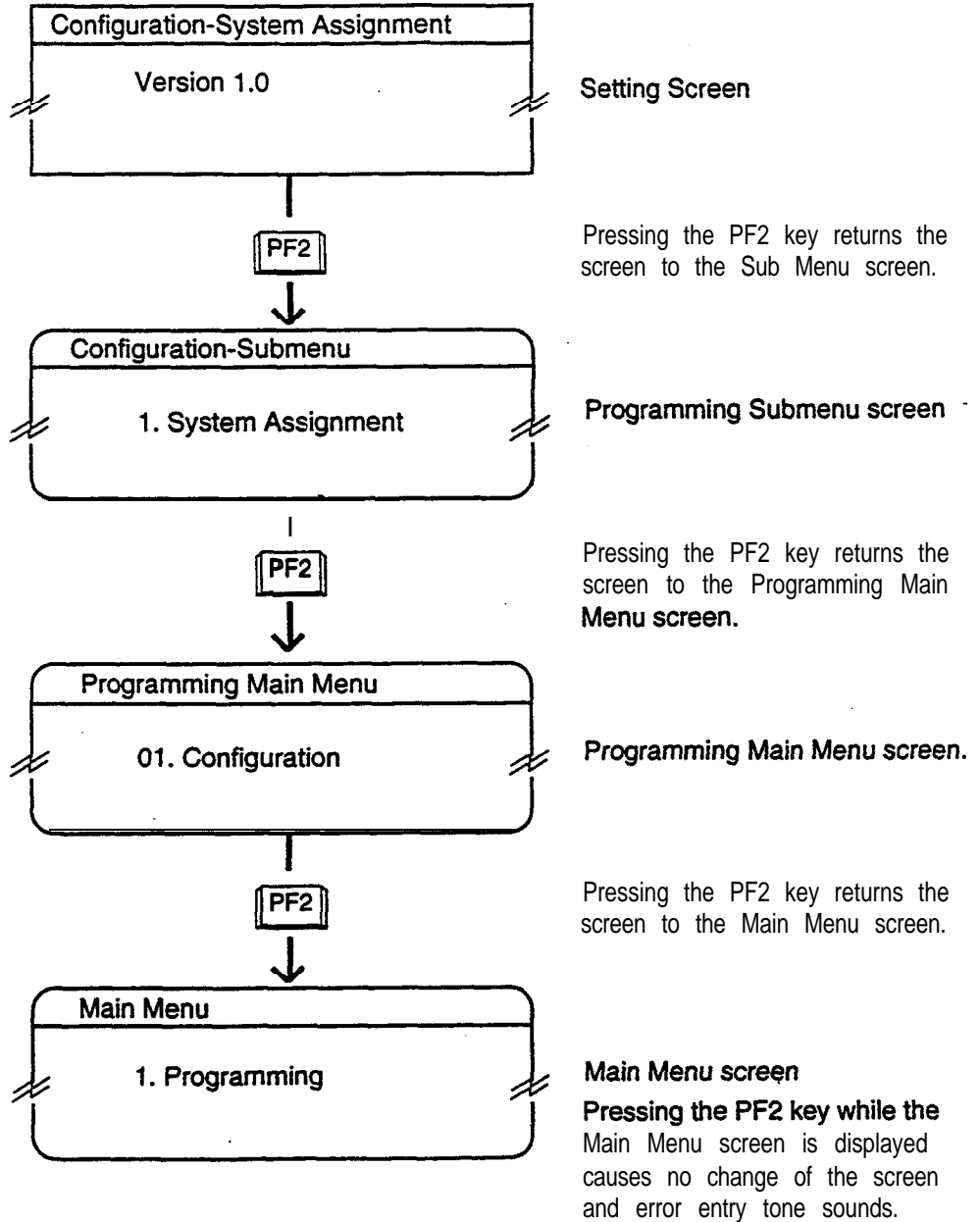

4.00 Programming Main Menu

Type "1" and press the RETURN key in the Main Menu screen then the Programming Main Menu is displayed on the screen,

The illustration below shows the submenu screens and the setting screens of Programming Mainmenu.

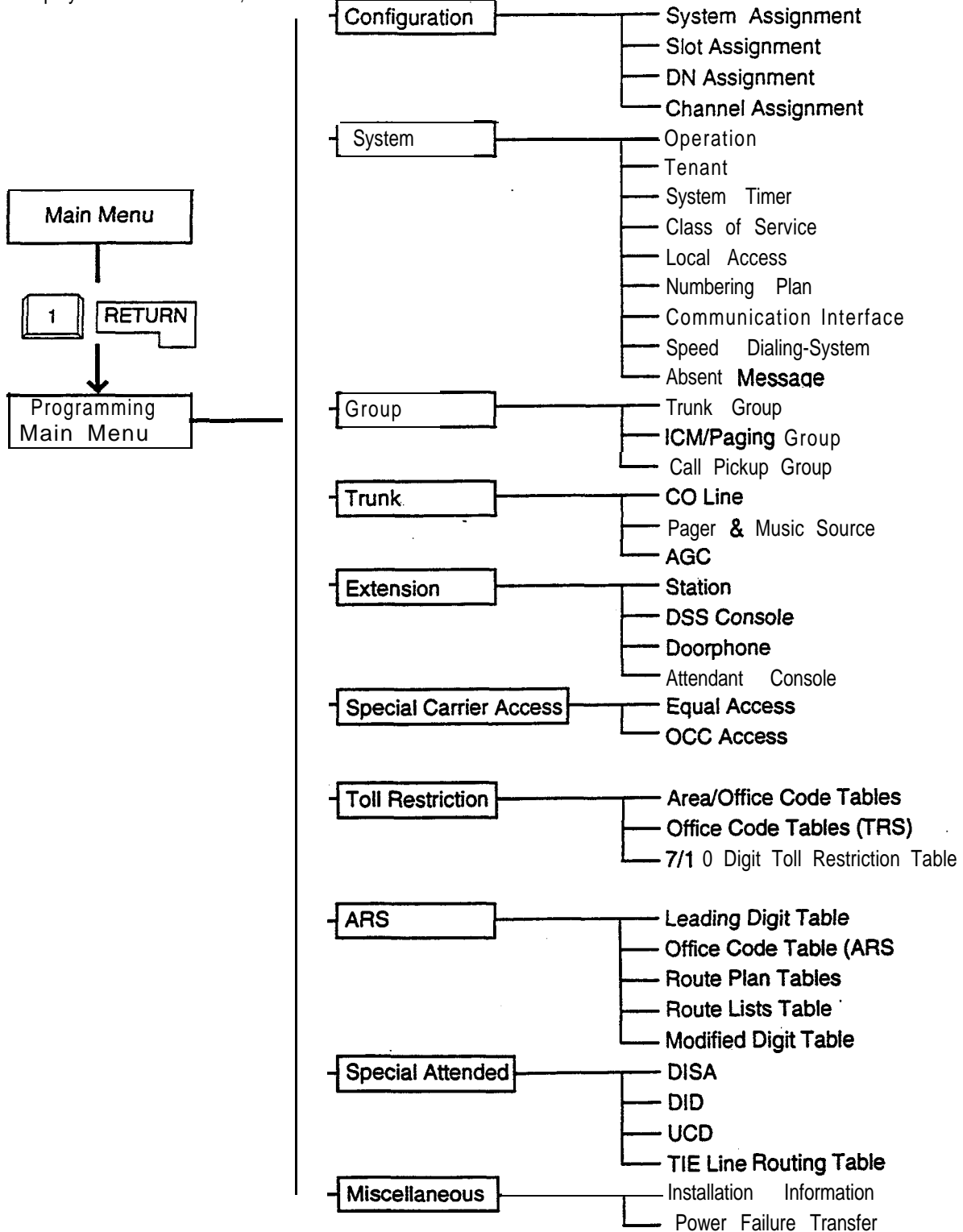

Configuration

Assigns the data concerning cards, slots, T-I channels and **DNs** (directory numbers).
For further details, refer to Section 9-C "Configuration Screen."

System

Assigns the elemental data common to the whole system.
For further details, refer to Section 9-O "System Screen."

Group

Assigns the data for trunk groups, ICM paging groups and pickup groups.
For further details, refer to Section 9-E "Group Screen."

Trunk

Assigns various parameters for CO lines, external pagers and music sources or tenant number for AGC (Automatic Gain Control).
Refer to Section 9-F "**Trunk** Screen."

Extension

Assigns the parameters for each extension, DSS consoles, Doorphones and Attendant consoles.
Refer to Section 9-G "Extension Screen."

Special Carrier Access

Assigns available trunk groups and parameters necessary for making Equal Access or OCC (Other Common Carrier) **Access** calls.
Refer to Section 9-H Special Carrier Access Screen."

Toll Restriction

Assigns parameters for Toll **Restriction**.
Refer to Section **9-I** "**Toll** Restriction Screen."

Automatic Route Selection

Assigns the parameters for Automatic Route Selection.
Refer to Section 9-J "Automatic Route Selection Screen."

Special Attended

Assigns parameters for **DISA** (Direct Inward System Access), DID (Direct Inward Dialing), UCD (Uniform Call Distribution) and TIE Line Routing Table.
Refer to Section 9-K "Special Attended Screen."

Miscellaneous

Assigns the installation information and cards for effectuating Power Failure Transfer.
Refer to Section 9-L "Miscellaneous Screen."

5.00 Test Main Menu

Type "2" and press the RETURN key in the Main Menu screen, then the Test Main Menu is displayed on the screen.

This menu consists of three **submenus** as illustrated below.

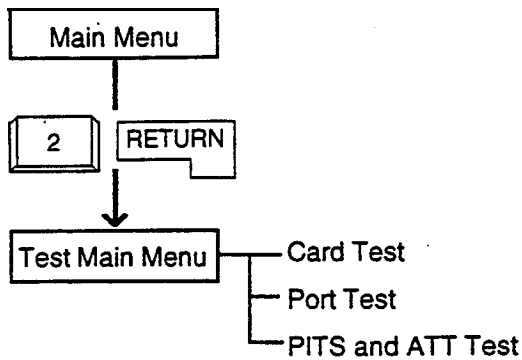

Card Test

Verifies the card conditions and enables you to detect whether troubles are caused by a card or telephone instruments.

Port Test

Verifies the port conditions and enables you to detect troubles when telephone instruments don't function well while card condition is **good**.

PITS and **ATT** Test

Verifies the conditions of PITS and the Attendant Console (ATT) and enables you to detect troubles when telephone instruments **don't** function well while card condition is good.

For further details of testing, refer to Section 14-F "Functional Test by Entering Commands."

6.00 Monitor Main Menu

Type "3" and press the RETURN key in the Main Menu screen, then the Monitor Main Menu is displayed on the screen.

The illustration below shows the submenu screen and the setting screens.

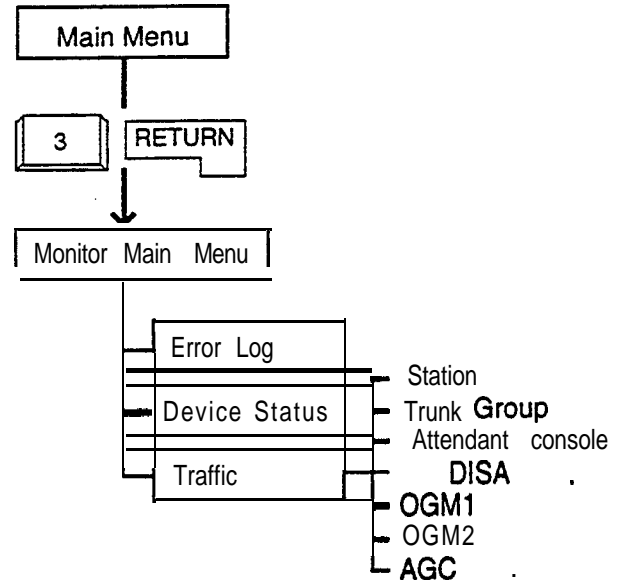

Error Log

Displays up to 15 major and minor alarms and up to 15 light alarms.

For further details, refer to Section 14-G-2.00 "Error Log screen."

Device Status

Displays the status of the system, cards, ports and the conference trunk.

For further details, refer to Section 14-G-3.00 "Device Status screen."

Traffic

Displays traffic measurements of extensions, trunk groups, attendant consoles and resources (DISA, **OGM1**, OGM2, AGC).

For further details, refer to Section 14-G-4.00 "Traffic Submenu screen."

D. Input Format-General

1 .00 Programming Mode

Input Format-General

In the programming mode (when PRG> is displayed on the screen), enter as follows:

```

: PRG> 1Command | 2Type of Model | 3Index Number
         4
         Item Number | Carriage Return (CR) ←
    
```

Note: Be sure to enter one space between the items. The (↵) in the followings indicates pressing the RETURN key.

<Example>

Displaying "Operation (OPR)" command, SMDR (Index number 2, Item number 02)

Enter as follows:

```
; PRG>OPR SH 2 02 ( ↵ )
```



Displays the following:

```

; INDEX=2
; 02 : SMDR      →      Y
; PRG>
    
```

1. Commands

The following programming **commands are** available in the programming mode.

For further information about programming, refer to Section 10 "System Programming-Dumb Type Terminal."

Programming	Command
System Assignment	SYA
Slot Assignment	SLA
DN Assignment	DNA
Channel Assqnmnt	CHA
Operation	OPR
Tenant	TNN
System Timer	TIM
Class of Service 1	CS1
Class of Service 2	CS2
Local Access Group	LAG
Numbering Plan	NBP
Communication Interface	COM
Speed Dialing-System	SPD
Absent Message	ABS
Trunk Group (112)	TG1
Trunk Group (2/2)	TG2
ICM/Paging Group	IPG
Call Pickup Group	CPG
CO Line	COL
External Paging	PAG
Music Source	MUS

Auto Gain Control	AGC
Extension	EXT
DSS Console	DSS
DN Button Assignment	DNK
PF Button Assignment	PFK
DSS Button Assignment	DSK
Dootphone	DPH
Attendant Console	AI-r
Attendant Queue Priority	AQP
Equal Access	EQU
OCC Access	occ
TRS Area/Office Code Tables	TR1
TRS Office Code Tables	TR2
TRS 7/10 • Digit Table	TR3
ARS Leading Digit Table	AR1
ARS Office Code Tables	AR2
ARS Route Plan Tables	AR3
ARS Route Lists Table	AR4
ARS Modified Digit Table	AR5
DISA	DIS
DISA Code	DIC
DISA Password	DIP
DID	DID
UCD (1/2)	UC1
UCD (2/2)	UC2
TIE Line Routing Table	TIE
Installation Information	INF
Power Failure Transfer	PFT
Change Password	CHG
CPC Detect Time-Outgoing	CPC
World Select 1	WS1
World Select 2	ws2
Automatic Busy-out Count	ABC
World Select 3	ws3
CO Access Instantly	CAI
Account Code Verified	ACV
Account Code Entry on Long	ACL
Distance Calls	
Speed Dialing Boundary	SPB
Night Answer Group	NAG
Polarity Reversal Detection	PRD
Voice Mail Directory Number	VMD
Mail Box Number	MBN
Waiting for Second Dial Tone	WSD
Equal Access Code	EQC
World Select 4	WS4
TIE Account Code	TAC
Clock Mode	CLK
ClockPriority	CLP
TIE Trunk Relay Restriction	TRR
Tone Detection Mode	TDM
tine Hunting Sequence	LHS
ESF Frame Option	EFO
Limited Call Duration	LCD
Call Forwarding-Follow Me	CFM

2.Type of Mode

Three types of Show type, Auto type and Batch type are available.

1) Show Type-SH

Enables you only to read the preset data. The preset data cannot be changed by this type.

<Example>

Displaying the data in System Assignment

Enter:

; PRG>SYA SH (←↓)



Displays the follows:

```
; 1 Expansion Shelf →      N
; 2 Additional CONF →     N
; PRG> [ ]
```

2) Auto Type-AT

Enables you to show or edit the data in an interactive format.

Showing the data

Each item appears one by one by every pressing of the RETURN key.

Editing the data

If you do not want to change the data, press the RETURN key when ; INPUT>> [] is displayed.

If you want to change the data, enter the appropriate values after ; INPUT>> [], then press the RETURN key.

To save the data after changing it, be sure to enter \$EOD after ; INPUT>> [], then press the RETURN key.

<Example>

Changing the data in System Assignment

Enter:

; PRG>SYA AT (←↓)



Displays:

```
; 1 : Expansion shelf →      N
; INPUT>> [ ]
```

To change N to Y, enter Y (←↓).



Next item appears:

```
; 2 : Additional CONF →     Y
; INPUT>> [ ]
```

To save the data of item 1, enter \$EOD (←↓):

Concludes AT mode

a

```
; PRG> [ ]
```

G. Help Function

1 .00 Programming Mode

Description

Used to display brief instructions and a list of commands available in the Programming Mode.

Input Format

```
; PRG> [HLP] [↵]
```

Display (Version 12.XX)

```
; PRG>hlp
;<< Command + Type + ( Index ) + ( Item No.) >>
; Command are..
; SYA .. System Assignment          SLA .. Slot Assignment
; DNA .. DN Assignment              CHA .. Channel Assignment
; CPR .. Operation                  TNN .. Tenant
; TIM .. System Timer              CS1 .. Class of Service (1/2)
; CS2 .. Class of Service (2/2)    LAG .. Local Access Group
; NBP .. Numbering Plan            COM .. Communication Interface
; SPD .. Speed Dialing - System    ABS .. Absent Message
; TG1 .. Trunk Group (1/2)         TG2 .. Trunk Group (2/2)
; IPG .. ICM/Paging Group          CPG .. Call Pickup Group
; COL .. CO Line                   PAG .. External Paging
; MUS .. Music Source              AGC .. AGC
; EXT .. Station                   DSS .. DSS Console
; DNK .. Station DN-Key Assignment PFK .. Station/DSS PF-Key Assignment
; DSK .. Station/DSS DSS-Key Assignment
; DPH .. Doorphone
; ATT .. Attendant Console         ACP .. Attendant Que Priority
; EQU .. Equal Access              CCC .. OCC Access
; TR1 .. TRS Area/Office Code Table TR2 .. TRS Office Code Tables
; TR3 .. TRS 7/10 Digit Table      AR1 .. ARS Leading Digit Table
; AR2 .. ARS Office Code Tables    AR3 .. ARS Route Plan Tables
; AR4 .. ARS Route Lists Table     ARS .. ARS Modified Digit Table
; DIS .. DISA                      DIC .. DISA Code
; DIP .. DISA Password            DID .. DID
; UC1 .. UCO (1/2)                UC2 .. UCO (2/2)
; TIE .. TIE Line Routing Table    INF .. Installation Information
; PET .. Power Failure Transfer    CHG .. Change Password
; CPC .. CPC Detect Time - Outgoing WS1 .. World Select 1
; WS2 .. World Select 2            ABC .. Automatic Busy-Out Count
; WS3 .. World Select 3            CAI .. CO Access Instantly
; ACV .. Account Code Verified     ACL .. Account Code Longdistance
; SPB .. Speed Dial Boundary       NAG .. Night Answer Group
; PRD .. Polarity Reverence Detection VMO .. Voice Mail DN
; MBN .. Mail Box Number           WSD .. Waiting Second Dial Tone
; EOC .. Equal Access Code         WS4 .. World Select 4
; TAC .. TIE Account Code          CLK .. Clock Mode
; CLP .. Clock Priority             TRR .. TIE Trunk Relay Restriction
; TOY .. Tone Detect Mode (DISA/AGC) LHS .. Line Hunting Sequence
; EFO .. ESF Frame Option          LCO .. Limited Call Duration
; CFM .. Call Follow Me
; Type are..
; SH... Show Type  AT... Auto Advance Set Type  BT... Batch Set Type
; PRG>
```

2.00 Operation Mode

Description

Used to display brief instructions and a list of commands available in the Operation Mode.

Input Format

```
; OPE> [HLP] [↵]
```

Display

```
; OPE>HLP<CR>
;<< Command + (Index) + (Item No.1) + (Item No.2) + .... + (Item Non) >>
; Command are..
; TST ..Test                        SYM ..System Maintenance Monitor
; INS ..In Service                 OUS ...Out of Service
; REM ...Remove                     ERR ...Display Error Log
; TFD ...Traffic Display            PRT ...Print Cut
; SDT ...Set Date and Time         LOD ...Program Data Load
; SAV ...Program Data Save         CHL ...Change Level
; SHL ...Show Level                RST ...Restart
; DTM ...DTMF-G/R Diagnosis        LBT ...Loop Back Test
; VUP ...ROM version up            ERT ...Error Rate
; OPE>
```

Section 9

System Programming

VT220 and Compatibles

System Programming

VT220 and Compatibles

Contents

	Page
A Introduction	9-A-1
B Construction of Programming Mode	9-B-1
C Configuration Screen	9-C-1
1.00 System Assignment	9-C-1
2.00 Slot Assignment	9-C-3
3.00 DN Assignment	9-C-6
4.00 Channel Assignment	9-C-8
4.01 T-I card	9-C-8
D System Screen	9-D-1
1.00 Operation	9-D-1
1.01 Operation (1/3)	9-D-1
1.02 Operation (2/3)	9-D-7
1.03 Operation (3/3)	9-D-1 1
2.00 Tenant..	9-D-14
3.00 System Timer	9-D-18
4.00 Class of Service	9-D-22
4.01 Class of Service (1/2)	9-D-22
4.02 Class of Service (2/2)	9-D-27
5.00 Local Access Group	9-D-31
6.00 Numbering Plan	9-D-33
6.01 Numbering Plan (01/11)	9-D-33
6.02 Numbering Plan (02/1 1)	9-D-36
6.03 Numbering Plan (03/1 1)	9-D-40
6.64 Numbering Plan (04/11)	9-D-44
6.05 Numbering Plan (05/11)	9-D-48
6.06 Numbering Plan (06/1 1)	9-D-52
6.07 Numbering Plan (07/11)	9-D-56
6.08 Numbering Plan (08/1 1)	9-D-59
6.09 Numbering Plan (09/1 1)	9-D-63
6.10 Numbering Plan (1 0/1 1)	9-D-64-2
6.11 Numbering Plan (1 1/1 1)	9-D-64-3
7.00 Communication Interface	9-D-65
8.00 Speed Dialing-System	9-D-68
9.00 Absent Message	9-D-70
E Group Screen	9-E-1
1 .00 Trunk Group	9-E-1
1 .01 Trunk Group (1/2)	9-E-1

	Page
1.02 Trunk Group (2/2)	9-E-9
2.00 ICM/Paging Group	9-E-I 2
3.00 Call Pickup Group	9-E-I 4
F Trunk Screen	9-F-I
1.00 CO Line..	9-F-i
2.00 Pager and Music Source	9-F-5
3.00 AGC	9-F-8
G Extension Screen	9-G-I
1.00 Station	9-G-I
1.01 Station (1/3)	9-G-I
1.02 Station (2/3)	9-G-7
1.03 Station (3/3)	9-G-I 2
2.00 DSS Console	9-G-I 5
2.01 'DSS Console (1/3)	9-G-I 5
2.02 DSS Console (2/3)	9-G-I 8
2.03 DSS Console (3/3)	9-G-21
3.00 Doorphone	9-G-24
4.00 Attendant Console	9-G-27
4.01 Attendant Console (1/2)	9-G-27
4.92 Attendant Console (2/2)	9-G-30
H Special Carrier Access Screen	9-H-I
1.00 Equal Access	9-H-I
2.00 OCC Access	9-H-5
I Toll Restriction Screen	9-I-I
1.00 Area/Office Code Tables	9-I-I
2.00 Office Code Tables	9-I-4
3.00 7/1 0 Digit Toll Restriction Table	9-I-6
J Automatic Route Selection Screen	9-J-I
1.00 Leading Digit Table	9-J-i
2.00 Office Code Tables	9-J-3
3.00 Route Plan Tables	9-J-6
4.00 Route Lists Table	9-J-9
5.00 Modified Digit Table	9-J-13

	Page
K Special Attended Screen	9-K-1
1.00 DISA	9-K-1
2.00 DID	9-K-5
3.00 UCD	9-K-7
3.01 UCD (1/2)	9-K-7
3.02 UCD (2/2)	9-K-9
4.00 TIE Line Routing Table	9-K-1 1
L Miscellaneous Screen	9-L-1
1.00 Installation Information	9-L-1
2.00 Power Failure Transfer Assignment	9-L-3
M Error Message Tables	9-M-1
1.00 Error Messages Related to the Assigning Items in the Same Screen	9-M-1
2.00 Error Messages Related to the Assigning Items in the Other Screens	9-M-2
3.00 Other Error Messages	9-M-7

A. Introduction

This section provides system programming using VT compatible terminals. Before starting system programming, Section 7 "Preparation for Programming and Maintenance (VT220 and Compatibles)" must be read. This section provides the basic operations required for system programming.

Programming consists of 10 submenu screens and each submenu consists of various setting screens.

The setting screens are used to assign or change various parameters concerning the system administration such as Tenant, Class of Service, Numbering Plan and so on.

The setting screens should be programmed in order of "First Set," "Second **Set**" and "Third Set" which is illustrated in "Construction of Programming Mode" on the following page. If you program a screen in the second set before setting the first-set screens, an error message will appear. For example, if you program "Extension" before programming "**Configuration-DN Assignment**," an error message is displayed.

In this section, each setting screen is explained using a screen and an explanation table.

B. Construction of Programming Mode

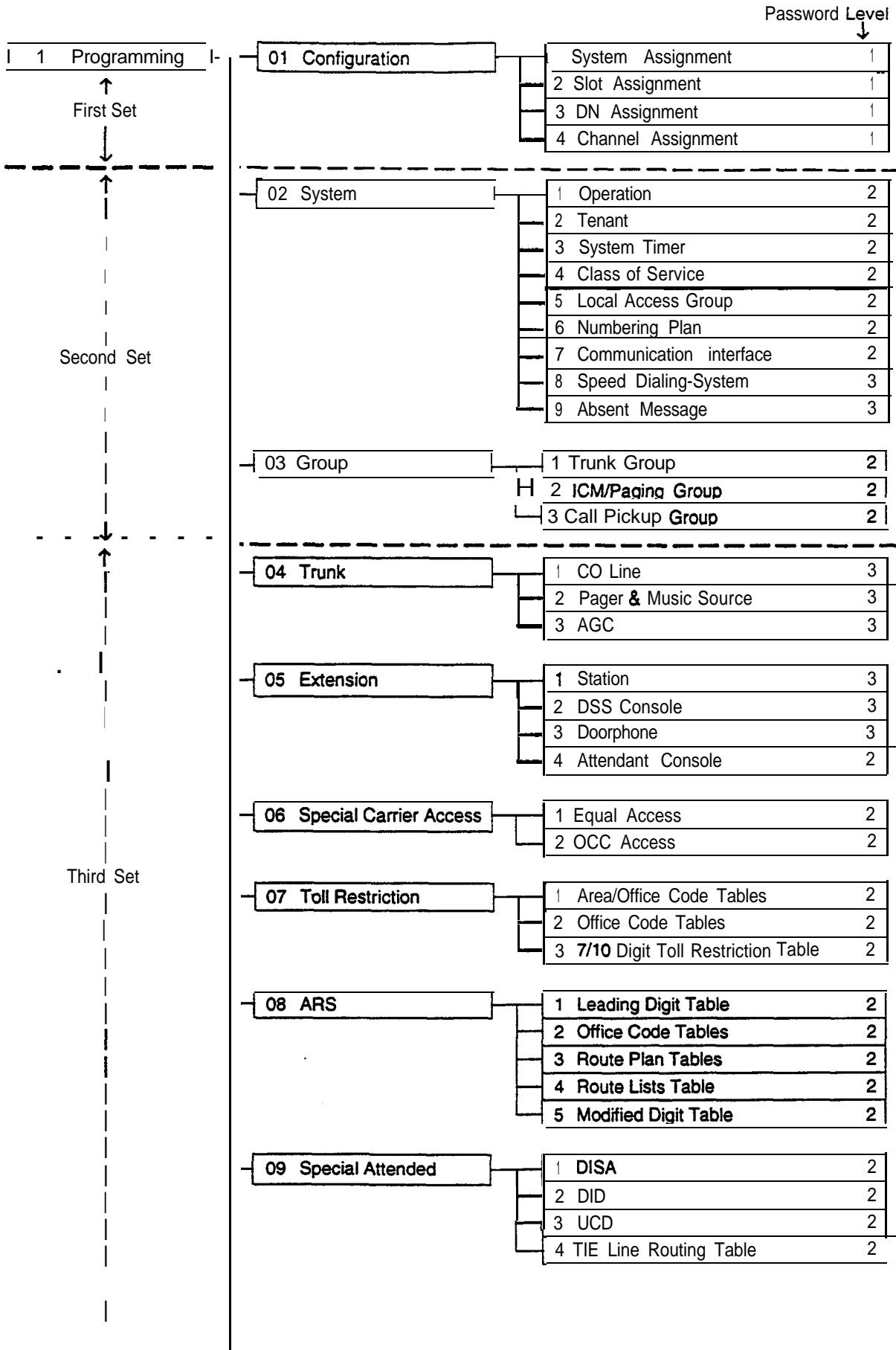

Description of Assigning Items

Expansion Shelf	Enables the expansion shelf 1 when set to "1 Shelf and both expansion shelves 1 and '2 when set to "2 Shelves."
TSW Additional CONF	Enables the expansion of conference trunks when set to Yes."

Conditions

None

Function

The following functions appear on the function line of this setting screen.



COMMON (SHOW LV, CHG LV, INS, OUS, REMOVE, EXIT) and HRD CPY keys are available in this setting screen.
For operation, refer to Section 7-l "Operation of Function Keys."

2.00 Slot Assignment

Configuration • Slot Assignment				I OFL	I PRG	I SCR	I SEL
Basic	I FS01	T-1	Expansion	FS01	PLC	Expansion	I FS01 HLC
Shelf	FS02	I • I	Shelf 1	I FS02	I PLC	I Shelf 2	I FS02 HLC
	I FS03	I • I		I FS03	I PLC		I FS03 HLC
	FSo4	PLC		FS04	PLC		FS04 HLC
	FS05	T-1		FS05	PLC		I FS05 HLC
	I FS06	I • I		FS06	PLC		FS06 HLC
	I FS07	I • I		I FS07	PLC		I FS07 HLC
	FS08	I PLC		I FS08	I PLC		I FS08 HLC
	FS09	T-1		FS09	I PLC		I FS09 DISA
	FS10	• I		I FS10	PLC		I FS10 DISA
	FS11	• I		I FS11	I PLC		FS11 DISA
	I FS12	PLC		FS12	SLC		I FS12 DISA
	I BS01	I CPU		I FS13	LCOT		I FS13 ATLC
	I BS02	I OHCA		FS14	I LCOT		FS14 DPH
	BSo3	I TSV		I FS15	LCOT		I FS15 RMT

FS: Free Slot, BS: Basic Slot

Summary

Assigns the type of servicecards, inserted in the free slots in the basic and expansion shelves.

(Password level : One)

Assigning Items	Default	Selection of Value	Reference
Basic Shelf FS (Free Slot) (01 to 12)	Automatic set	Blank : Not assigned PLC : Proprietary Integrated Telephone System Line Circuit card HLC : Hybrid Line Circuit card SLC : Single Line Telephone Circuit card MSLC : SLC card with Message Waiting LCOT : Loop Start Central Office Trunk card GCOT : Ground Start Central Office Trunk card DID : Direct Inward Dialing card T-1 : T-1 DIGITAL TRUNK CARD AGC : Automatic Gain Control card DISA : Direct Inward System Access card OPX : Off Premise Extension card ATLC : Attendant Console Line Circuit card DPH : Door Phone Circuit card RMT : Remote Circuit card	1 -A-5.00 1 -E-1.00 to 2.00 1-E-7.00 to 23.00

Continued

Assigning Items	Default	Selection of Value	Reference
Basic Shelf BS (Basic Slot) (02)	Automatic set	Blank : Not assigned OHCA : T-SW Off-Hook Call Announcement card	1 -A-5.00 1-E-1.00 to 2.00 1 -E-7.00 to 23.00
Expansion Shelf 1 FS (01 to 15)	Automatic set	Same as Basic Shelf FS	
Expansion Shelf 2 FS (01 to 15)	Automatic set	Same as Basic Shelf FS	

Description of Assigning items

Basic Shelf FS (01 to 12)	Defines the type of card installed in the free slots (01 to 12) of the basic shelf.
Basic Shelf BS (02)	Used to utilize the T-SW OHCA card or not.
Expansion Shelf 1 FS (01 to 15)	Defines the type of card installed in the free slots (01 to 15) of the expansion shelf 1.
Expansion Shelf 2 FS (01 to 15)	Defines the type of card installed in the free slots (01 to 15) of the expansion shelf 2.

Conditions

The cursor does not move to **BS01** and BS03. In BS02, assignable value is OHCA or Blank.

T-I card should be assigned to **FS01 , 05 or 09** of any shelf.

One T-I card occupies three slots. If you assign a T-I card to **FS01** , FS02 and FS03 are not available for other cards. A '-' (hyphen) is displayed in these two slots and the cursor skips them.

If no CO trunk card is assigned, "Trunk-CO Line" screen cannot be selected.

If no Extension card is assigned, "Extension-Station" screen cannot be selected.

If AGC card is not assigned, **"Trunk-AGC"** screen cannot be selected.

If DPH card is not assigned, 'Extension-Doorphone' screen cannot be selected.

If ATLC card is not assigned, 'Extension-Attendant Console' screen cannot be selected.

If **DISA** card is not assigned, 'Special Attended-DISA' screen cannot be selected.

If DID card is not assigned, 'Special Attended-DID' screen cannot be selected.

When assigning a card, the card status is Out of Service (OUS). When utilizing the card, the card status should be set to In Service (INS).

For In Service (INS) and Out of Service (OUS), refer to Section 7-J-4.00 "INS (In Service)" and Section 7-J-5.00 "OUS (Out of Service)."

For confirming whether the card status is INS or OUS, refer to Section 14-G-3.02 **"Card Status screen."**

When deleting (selecting blank) or changing the pre-assigned card type, the conditions should be the followings:

- The card status is OUS or Fault.
- All of the port data has been deleted.

However, if there exist port data, it is possible to change the cards as follows:

- PLC card ↔ HLC card
- SLC card ↔ HLC card

Deleting the ATLC card will be an error if there is one of the following assignments:

- “Group-Trunk Group”,
Incoming Mode (Day) is set to “ATT.”
Intercept Routing (Day) is set to “ATT.”
- “Extension-Doorphone”,
Doorphone Call Assignment is set to “ATT.”

Deleting the **DISA** card will be an error if there is one of the following assignments:

- “Group-Trunk Group”,
Incoming Mode (Day) is set to “**DISA.**”
Incoming Mode (Night) is set to “DISA.”

Deleting the HLC, SLC, LCOT or GCOT card will be an error if there is the following assignment to the slot to be deleted:

- Miscellaneous-Power Failure Transfer Assignment.

See Section 1 -A-5.00 “Service Cards Description” for installing the cards in combination.

Function

The following functions appear on the function line of this setting screen.



COMMON (SHOW LV, CHG LV, INS, OUS, REMOVE, EXIT) and HRD CPY keys are available in this setting screen.

For operation, refer to **Section 7-1** “Operation of Function Keys.”

4.00 Channel Assignment

4.01 T-I card

Configuration - Channe Assignment												I	OFL	I	PRG	I	SEL				
Channel Assignmetn(1/2)																					
I Slot 101 Option I 1:DTMF 2:DTMF						I Slot 105 Option 1: DTMF 2:DTMF I															
I Frame Sequence I D4						I Frame Sequence I ESF															
I Line Coding I AMI						I Line Coding						B8ZS									
101	LCO	109	LCO	117	LCO	125	.	101	LCO	109	DID	117	LCO	125	-	I					
102	GCOT	110	GCO	118	GCO	126	.	102	GCO	110	TIE	118	OPX	126	-	I					
103	DID	111	DID	119	DID	127	.	103	LCO	111	TIE	119	LCO	127	.	I					
104	DID	112	DID	120	DID	128	.	104	GCO	112	TIE	120	GCO	128	-	I					
105	TIE	113	TIE	121	TIE	129	.	105	GCO	113	TIE	121	OPX	129	.	I					
106	TIE	114	TIE	122	TIE	130	.	106	DID	114	OPX	122	OPX	130	-	I					
107	OPX	115	OPX	123	OPX	131	.	107	DID	115	OPX	123	LCO	131	-	I					
108	OPX	116	OPX	124	OPX	132	.	108	DID	116	OPX	124	GCO	132	-	I					
01-32 : Channel No.																					
1 COMMON 2 3 4 5 6 HRDCPY 7 8																					

S u m m a r y

Assigns the type of T-I interface to each channel.

(Password level : One)

Assigning Items	Default	Selection of Value	Reference
Slot No.	Automatic set	Physical slot no. (101,105,109,201,205,209,301,305,309)	3-F-15.00
Frame Sequence	ESF	D4 / ESF	10-C-64.04
Line Coding	B8ZS	AMI / B8ZS	3-F-I 5.00
Channel (01 to 24)	Blank: Not assigned	LCO / GCO / DID / OPX / TIE	

Description of Assigning item

Frame Sequence Assigns the type of Frame Sequence for each T-I card.

Line Coding Assigns the type of Line Coding for each T-I card.

Channel (01 to 24) Assigns the type of T-I interface to each channel.

Conditions

The number of "Channel Assignment screens" may vary depending on the number of **T1 DIGITAL TRUNK** cards installed to the system. Up to six **T1 DIGITAL TRUNK** cards can be installed to the system. Channel numbers 25 through 32 are not available. A "-" (hyphen) is displayed in these columns and the cursor skips them.

If you assign "**OPX**" to a channel, "DN Assignment" is also required. Refer to Section 9-C-3.00 "DN Assignment".

D. System Screen

1.00 Operation

1.01 Operation (1/3)

```

system • Operation                                | OFL | PRG | L IN | SEL
-----+-----+-----+-----+-----+
                                Operation (1/3)
-----+-----+-----+-----+-----+
| Tenant Service -----| Yes  | |
| Automatic Route Selection -----| No   |
| Numbering Plan -----| Fixed |
| Privacy on DN Key -----| Yes  |
| Restriction Level • Operator -----| 01  |
| Restriction level • International -| 01  |
| Hose Dialing Plan -----| Type-A|
| DSS Operat ion Node -----| With Transfer|
| Busy Tone -----| Tone-2|
| Held Cat |Reminder -----| Yes  |
| Beep Tone for Bsy-ovr/Brg-in -----| Yea  |
| External Paging 1 , 2 -----| Yes . Yes|
| External Music Source 1 , 2 -----| Yes , Yes.|
| Idle Line Preference -----| DN   |
| FDN for General Operator Cal | -----|
| PBX Code -----| 951 .|
-----+-----+-----+-----+-----+
COMMON 2  3  4  5  6 HRD CPY 7  8

```

Summary

Assigns elemental data common to the whole system, such as Tenant Service, Automatic Route Selection, etc., through the first **System-**

Operation screen. This is the first of three screens.

(Password level : Two or higher)

Assigning items	Default	Selection of Value	Reference
Tenant Service	No	No : Tenant Service is unavailable Yes : Tenant Service enabled	3-B-4.00
Automatic Route Selection	No	Yes : Automatic Route Selection enabled No : Automatic Route Selection is unavailable	3-C-2.00 4-C-3.01 5-A-1.01 6-D-1.01
Numbering Plan	Fixed 1	Flex : feature numbers can be changed Fixed 1: feature numbers are set to Default 1 Fixed 2: feature numbers are set to Default 2	3-B-1.00
Privacy on DN Key	Yes	No : barge in allowed (privacy disabled) Yes : barge in disallowed (privacy enabled)	4-G-1.00 4-G-2.00 4-G-3.00
Restriction Level-Operator	01	01 to 16 : the restriction level for a telephone company operator call	3-c-1.05

Continued

Continued

Assigning items	Default	Selection of Value	Reference
Restriction Level-International	01	01 to 16 : the restriction level for an international call	3-c-1.05
Home Dialing Plan	Type-A	Type-A : 1+NXX+NXX+XXXX NXX+XXXX Type-B : NPX+NXX+XXXX NNX+XXXX Type-C : 1 +NPX+NXX+XXXX 1+ NNX+XXXX NXX+XXXX Type-D : 1 +NXX+NXX+XXXX NXX+NXX+XXXX NXX+XXXX Area Code Office Code Subscriber Number [N : 2 to 9, P : 0,1, X : 0 to 9]	3-c-1.02 3-C-1.04 3-C-1.06 3-c-1.07 3-C-2.00
WSS Operation Mode	With Transfer	With Transfer : hold and transfer Without Transfer : disconnect and call	4-I-12.01
Busy Tone	Tone-2	Tone-1 : busy tone 1 Tone-2 : busy tone 2	3-B-I 4.00
Held Call Reminder	Y e s	Yes : Held Call Reminder is enabled. No : Held Call Reminder is not enabled.	3-E-2.00
Beep Tone for Bsy-ovr / Brg-in	Yes	Yes : overriding with beep tone No : overriding without beep tone	3-B-I 5.00 4-c-7.00 5-A-5.00 6-D-4.00
External Paging 1, 2	Yes, Yes	Yes : using external pager 1, 2 No : not using external pager 1, 2	2-D-I .00 3-B-8.02 3-D-2.04 4-D-4.00 4-H-I .03 4-H-I .04 4-H-2.00 5-B-2.00 5-F-1.03 5-F-I .04 5-F-2.08 8-I-I .03 8-I-I .04 6-I-2.00

Continued

Continued

Assigning Items	Default	Selection of Value	Reference
External Music Source 1, 2	Yes, Yes	Yes : using external music source 1, 2 No : not using external music source 1, 2	2-D-2.00 3-E-1.00 4-H-2.00 4-I-4.00 5-F-2.00 6-I-2.00
Idle Line Preference	DN	DN : Off-hook selects an idle line by DN c o : Off-hook selects an idle line by CO	4-c-1.02 12-C-4.00
FDN for General Operator Call	blank	Three or four numeric digits : floating directory number for general operator call 1, 2	3-B-3.00 3-D-2.02 3-D-2.03 3-D-2.05 3-D-2.06 4-F-2.00 5-D-2.00
PBX Code	blank	Up to three numeric digits (0-9)	3-F-14.01

Description of Assigning **Items**

Tenant Service	Enables or disables the Tenant Service feature.
Automatic Route Selection	Enables or disables the ARS (Automatic Route Selection) feature.
Numbering Plan	Selects the type of numbering plan; The user can assign the desired feature numbers or use the default setting 1 or 2.
Privacy on DN Key	Determines whether or not a PITS telephone user is allowed to barge in on an existing conversation on a PDN, SDN or SCO button.
Restriction Level-Operator	Assigns the restriction level for calls to the telephone company operator from an extension.
Restriction Level-International	Assigns the restriction level for international calls from an extension.
Home Dialing Plan	Selects the home dialing plan. This setting applies to ARS, EQA and occ calls.
DSS Operation Mode	When "With Transfer" is selected, allows the DSS console operator to transfer the CO call to an extension user by simply pressing the associated DN•DSS button on the DSS console. When "Without Transfer" is selected the CO call is disconnected when the DN•DSS button is pressed.
Busy Tone	Selects busy tone 1 or 2. Busy tone 2 has a unique pattern allowing users with automatic release SLT's an extended amount of time to enter codes when encountering a busy party.
Held Call Reminder	When assigned to Yes, the system reminds the user that there is a call on hold. When disabled there is no reminder tone given to the user. In either case the call will be disconnected after 30 minutes if it is not retrieved.
Beep Tone for Bsy-ovr/ Brg-in	If "Yes" is selected, a beep tone will be heard when executing Busy Override or Barge-in. If "No" is selected, there will not be any tone heard when Busy Override or Barge-in is executed.
External Paging 1, 2	Assigns external pagers 1 and 2 .
Idle Line Preference	This assignment applies to a PITS telephone when 'Idle Line Preference-Calling ' is assigned on it. If " DN " is selected, an idle DN button is automatically seized by simply going off-hook, and an idle CO button is seized automatically if " CO " is selected.
FDN for General Operator Call	Assigns the FDN (Floating Directory Number) for General Operator Call. This is used for the following attendant-seeking calls: DID, DISA, Call Forwarding and Overflowed UCD calls. There are two entries to allow for two tenants.
PBX Code	Required when your KX-T336 is a part of a TIE Line Network.

1.02 Operation (2/3)

```

System  ▣ Owration                                I OFL I PRG I SCR I SEL
-----+-----+-----+-----+-----+-----+
                                     Operation (2/3)
-----+-----+-----+-----+-----+
| System Administration Device ----I VT220          |
| SHDR -----| Yes                               |
| Page Length (4-99) -----| 60                  |
| Skip Perf (0-95) -----| 0                    |
| Outgoing Duration Log -----I All Cal 1         |
| Incoming Duration Los -----| Yes              |
| Attendant Duration -----| Separate          |
| Special Carrier Name -----I Default            |
| Print Secret Dial -----I Yes                   |
| Error Log/Programming/Traffic ----| Yes, Yes, Yes |
| Start Time of Traffic Measurement -I 12:00 AH     |
| Start Time of Test -----| 12:00 AM      |
| Remote Directory Number -----| 1234          |
| Remote Alarm -----| Yes              |
| Destination Address -----| 12346678901234667890123466 I
-----+-----+-----+-----+-----+
COMMON HRD CPY
  
```

Summary

Assigns elemental data common to the whole system, such as System Administration Device, SMDR (Station Message Detail Recording),

parameters for SMDR, etc., through the second System-Operation screen.
(Password level : Two or higher)

Assigning Items	Default	Selection of Value	Reference
System Administration Device	Automatic set	VT220 : VT1 00/VT220 Terminal Dumb : Dumb Terminal ATT 1 : Attendant Console 1 ATT 2 : Attendant Console '2	1 -A-3.00
SMDR	No	No : not using SMDR (Station Message Detail Recording) Yes : using SMDR	3-F-1.00 9-O-7.00
Page Length (4 to 99)	blank	4 to 99 : page length (number of lines)	3-F-1.00

Continued

Assigning Items	Default	Selection of Value	Reference
SMDR (cont.) Skip Perf (0 to 95)	blank	0 to 95: how many lines to skip . Note : in case of printing out system data : (page length)- (skip perforation) ≥ 23 in case of printing out call processing information : (page length)- (skip perforation) ≥ 6 in case of printing out error log (page length)- (skip perforation) ≥ 4	3-F-1.00
Outgoing Duration Log	blank	No : outgoing calls not printed All Call : print all outgoing calls Toll Only : print outgoing toll calls only ("Toll Only" is not available from software version 9.5X or higher.)	3-F-I .00
Incoming Duration Log	blank	No : incoming calls not printed Yes : print all incoming calls	3-F-I .00
Attendant Duration	blank	Separate : charge call duration to Attendant Console Summary : charge call duration to destination	3-F-I .00
Special Carrier Name	blank	Default : print default name; OC 1- 4, EQ1- 4 User Name: print user's name Dial No. : print dialed number	3-F- 1.00
Print Secret Dial	blank	No : not printed Yes : print the secret dial numbers	3-F-I .00. 4-I-5.00 6-J-3.00
Error Log /Programming/ Traffic	blank	No : do not print out these items Yes : print each item	3-F-I .00 7-D 14-D-I .02 14-G 15-D-I .02
Start Time of Traffic Measurement	blank	1 to12 : hour 00 to 59 : minute AM/PM : a.m. / p.m.	14-G-4.00 15-F-2.00
Start Time of Test	blank	1 to12 : hour 00 to 59 : minute AM/PM : a.m. / p.m.	14-D-I .01 15-D-1.01
Remote Directory Number	399 :for "with RMT" blank : for "without RMT"	Three or four numeric digits: Floating Directory Number for the remote mainte- nance port	3-B-3.00 4-F-I .05 5-D-I .03 6-G-I .05 14-B-2.00 15-B-2.00
Remote Alarm	No	No : not providing Remote Alarm Yes : providing Remote Alarm	14-D-1.05 15-D- 1.05
Destination Address	blank	Maximum 26 numeric digits : telephone (modem). number of the destination for Remote Alarm	

Conditions

This screen does not appear if 'System-Operation", Tenant Service is assigned to "No."

Operator 1 (Tenant 2)
Operator 2 (Tenant 2)

This system can accommodate up to two Attendant consoles. If two Attendant Consoles are assigned to tenant 1, no Attendant consoles can be assigned to tenant 2.

Speed Dialing-System
Boundary/Call Park
Boundary/Message
Waiting Boundary/Absent
Message Boundary

If Tenant Service is available, the following items can be split between tenant 1 and tenant 2. The boundaries are to set tenant-boundary numbers. The last number that tenant 1 can use must be assigned in each boundary for the functions below:

Speed Dialing-System
Call Park-System
Message Waiting
Absent Message

<Example>

Up to 200 speed dialing codes can be programmed for the system. If you wish to assign 150 codes to tenant 1 and 50 codes to tenant 2, enter "150" in Speed Dialing-System Boundary.

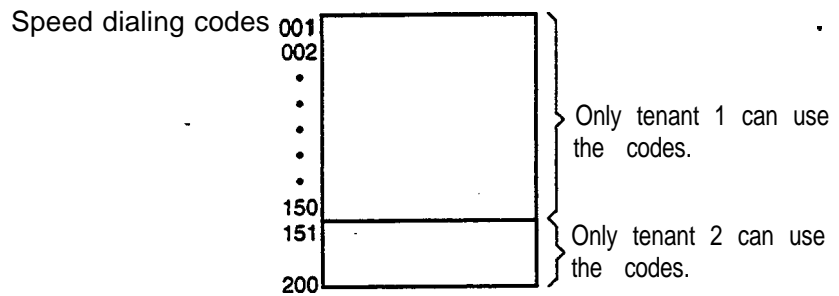

If tenant 1 uses no code and tenant 2 uses 200 codes, enter '000."

Function

The following functions appear on the function line of this setting screen.



COMMON (SHOW LV, CHG LV, INS, OUS, REMOVE, EXIT) and HRD CPY keys are available in this setting screen.

For operation, refer to Section 7-1 'Operation of Function Keys."

3.00 System Timer

```

system - System Timer                                I OFL I PRG I SCR | DIR
-----+-----+-----+-----+-----+-----+-----+-----+
I Held Call Reminder -----I 30 second(s) (15-240) I
I Held Call Reminder (ATT) -----I 60 second(s) (15-240) I
| Transfer Recall -----| 30 second(s) (15-240) |
| Pickup Dial Waiting -----I 1 second(s) ( 1 - 5) |
| External First Digit Time-W -----I 1 0 second(s) ( 5-120) |
| External Interdigit Time-Out -----| 5 second(s) ( 3- 15) |
| External Interdigit Time-Out (PBX) --| 5 second(s) ( 3- 10) |
| Toll Restriction Guard Time-Out ----| 10 second(s) ( C- 25) |
| Call Forwarding - Ho Answer Time-Out | 15 second(s) ( 5- 60) I
| Intercept Routing Time-Out (System) -| 60 second(s) ( 5-240) |
| Intercept Routing Time-Out (DISA) ---| 30 second(s) ( 5-240) |
| Attendant Overflow Time -----| 60 second(s) ( 5-240) |
I SHDR Duration Time -----| 10 second(s) ( 0- 15) |
| TIE Interdigit Time-Out -----| 5 second(s) ( 3- 30) |
-----+-----+-----+-----+-----+-----+
COMMON      HRD CPY
  
```

Summary

Executes time-setting on various system timers.
 (Password level : Two or higher)

Assigning items	Default	Selection of Value	Reference
Held Call Reminder	60	15 to 240 : s	3-B-1 0.00 3-E-2.00
Held Call Reminder (ATT)	60	15 to 240 : s	3-B-10.00 3-E-2.00
Transfer Recall	30	15 to 240 : s	3-B-1 0.00 3-E-3.00 4-F-1 .01 5-D-1 .01 6-G-1 .01 6-G-1 .02
Pickup Dial Waiting	1	1 to 5 : s	3-B-1 0.00 5-A-2.04

Continued

Continued

Assigning Items	Default	Selection of Value	Reference
External First Digit Time-Out	10	5 to 120 : s	3-B-1 0.00 3-B-12.00 3-F-12.00 10-C-58.00 10-C-61 .00
External Interdigit Time-Out	5	3 to 15 : s	3-B-10.00 3-B-1 2.00
External interdigit Time-Out (PBX)	5	3 to 10 : s	3-B-1 0.00 3-B-1 2.00
Toll Restriction Guard Time-out	10	0 to 25 : s	3-B-1 0.00
Call Forwarding-No Answer Timeout	15	5 to 60 : s	3-B-10.00 3-D-2.05 3-D-2.06 4-F-2.03 4-F-2.04 5-D-2.03 5-D-2.04
Intercept Routing Time-Out (System)	60	5 to 240 : s	3-B-1 0.00 3-F-5.00 6-J-1 2.00
Intercept Routing Time-Out (DISA)	30	5 to 240 : s	3-B-1 0.00 3-D-2.02 3-F-5.00
Attendant Overflow Time	60	5 to 240 : s	3-B-1 0.00 3-D-1 .03 6-G-2.00 6-G-7.00 10-C-53.00
SMDR Duration Time	5	0 to 15 : s	3-B-10.00 3-F-1 .00 4-A-4.03
TIE Interdigit Time-Out	5	3 to 30 : s	3-F-14.00

Description of Assigning Items

Held Call Reminder	Sets the time for Held Call Reminder for extensions. When this timer expires, the extension is alerted that there is a call held for an extended period of time
Held Call Reminder (ATT)	Sets the time for Held Call Reminder for the Attendant Console. When this timer expires, the Attendant is alerted that there is a call held for an extended period of time.
Transfer Recall	Sets the time for Transfer Recall on both extensions and Attendant consoles.
Pickup Dial Waiting	Sets the waiting time for Pickup Dialing. The waiting time gives the user an opportunity to dial digits prior to the automatic dialing taking place.
External First Digit Time-Out	Sets the maximum time allowed between CO dial tone or pseudo dial tone and the Time-Out first digit dialed.
External Interdigit Time-Out	Sets the maximum time allowed between digits on a CO call. This timer does not apply for CO operator calls.
External Interdigit Time-Out (PBX)	Sets the maximum time between dialed digits (Behind PBX).
Toll Restriction Guard Time-Out	Sets the time limit between dialing digits for CO operator calls. This prevents a user from attempting to defeat toll restriction.
Call Forwarding-No Answer Time	Sets the Call Forwarding-No Answer timer. This also functions as UCD-No Answer timer.
Intercept Routing Time-out (System)	Sets the time limit for Intercept Routing (System). This timer is used when an incoming CO call (DIL 1:1 , DID, TAFAS or night answer and so on) is not answered. Call forward no answer will override this timer if an extension has enabled Call Forwarding-No Answer Time-Out.
Intercept Routing Time-Out (DISA)	Sets the time limit for Intercept Routing (DISA). This is used when a DISA destination does not answer.
Attendant Overflow Time	Sets the overflow time for the Attendant Console. When this timer expires, a call will be routed to the overflow destination.
SMDR Duration Time	Determines the length of the SMDR duration timer. This timer starts when the system has sent all the digits to the Central Office .
TIE Interdigit Time-Out	Sets the maximum time allowed between digits on a TIE call after it was received by the system.

6.00 Numbering Plan

6.01 Numbering Plan (01/11)

System - Numbering Plan		I OFL	I PRG	SCR	DIR
Numbering Plan (01/11)					
I No.	I Feature	I DG1	I DG2	I DG3	I DG4
1	1st Hundred Block Extension-----	1		-	-
2	2nd Hundred Block Extension-----	2		-	-
3	3rd Hundred Block Extension-----	3		-	-
4	4th Hundred Block Extension -----			-	-
5	5th Hundred Block Extension -----			-	-
6	6th Hundred Block Extension -----			-	-
7	7th Hundred Block Extension -----		1	-	1
8	8th Hundred Block Extension -----			-	-
9	9th Hundred Block Extension -----			-	-
10	10th Hundred Block Extension -----			-	-
11	11th Hundred Block Extension -----			-	-
12	12th Hundred Block Extension -----			-	-
1 COMMON 2 IHDEX 3 4 5 6 HRD CPY 7 8					

Summary

The first screen of the System-Numbering Plan screen sets the extension numbers for the 1 st through 12th Hundred Block Extension groups.

(Password level : Two or higher)

Assigning Items	Default		Selection of Value	Reference
	Fixed 1	Fixed 2		
1 st Hundred Block Extension	1		0 to 9: set "DG1" and leave "DG2" blank when the extension numbers are to be composed of three digits, and set both "DG1" and "DG2" when the extension numbers are to be composed of four digits.	3-B-1.00 3-B-2.00
2nd Hundred Block Extension	2			
3rd Hundred Block Extension	3			
4th through 12th Hundred Block Extension	blank			

Description of Assigning items

1st through 12th Hundred Block Extension	Assigns the leading one or two digits for extension DN (Directory Number). If the leading digit is not programmed, the DN assignment is not possible.
--	---

Conditions

"System-Numbering Plan" setting cannot be changed if "System-Operation", Numbering Plan is set to "Fixed 1" or "Fixed 2." If "Flex" is selected, this setting is changeable.

When entering "DG 1" to "DG 2," the cursor does not advance nor return automatically. Use the → and ← keys to move the cursor.

"Parameter Save OK?" will be displayed on this screen, if you attempt to exit this screen without saving the data change you've made. Different from other screens, "Parameter Save OK?" is not displayed on this screen when you press the **NEXT/PREV** key.

Data storage is executed by the PF 4 (Memory) key or the PF 2 (End) key for all screens at the same time. Logical check is also performed according to the following logic:

Extension numbers and other PBX extension numbers are three or four digits and the leading one or two digits are assigned in "Numbering Plan" screens.

Feature numbers may be one, two, three or four digits.

Those numbers assigned in Numbering Plan screens cannot include the same number assigned to other feature number as the part or whole of it.

For example, if the digit "2" is assigned to the feature number for "Trunk Group 01-08 Access" and another digit "21" is assigned for "Trunk Group 09-16 Access," it is checked at the time of data storage. Similarly, "35" and "351" cannot be present at the same time.

It is possible to store "0" through "9," "*", "#," as the feature numbers.

However, if "*" or "#" is included in the feature numbers, those features are not accessed by the rotary telephone extensions.

1st to 12th Hundred Block Extension	Extension numbers cannot include "*" and "#."
-------------------------------------	---

Function

The following functions appear on the function line of this setting screen.

1	COMMON	2	INDEX	3		4		5		6	HRD CPY	7		8
---	--------	---	-------	---	--	---	--	---	--	---	---------	---	--	---

COMMON (SHOW LV, CHG LV, INS, OUS, REMOVE, EXIT) and HRD CPY keys are **available** in all setting screens. INDEX key is also available *in this screen*. The operation of function keys are described in Section 7-1 'Operation of Function Keys.' Only a message is provided here.

F2	:	INDEX>Numbering Plan (01-1 1)=														
		1		2		3		4		5		6		7	EXIT	8

6.02 Numbering Plan (02/11)

System - Numbering Plan		I OFL	I PRG	I SCR	I DIR
Numbering Plan (02/11)					
I Ho.	Feature	I DG1	I DG2	I DG3	I DG4
13	13th Hundred Block Extension-----			-	-
14	14th Hundred Block Extension-----			-	-
15	15th Hundred Block Extension-----			-	-
16	16th Hundred Block Extension-----			-	-
17	Operator Call (General) -----	0			
18	Operator Call (Specific) -----				
19	ARS/Local CO Line Access -----	9			
20	Trunk Group 01-08 Access -----	8	1		
21	Trunk Group 09-16 Access -----	8	2		
22	Trunk Group 17-24 Access -----	8	3		
23	Speed Dialing - System -----	*	1		
24	Speed Dialing - Station -----	*	2		
COMMON INDEX HRD CPY					

Summary

The second screen of the System-Numbering Plan screen sets the numbers for 13th through 16th Hundred Block Extension groups and functions 17 to 24.

(Password level : Two or higher)

Assigning Items	Default		Selection of Value	Reference
	Fixed 1	Fixed 2		
13th Hundred Block Extension	blank		0 to 9: set "DG1" and leave "DG2" blank when the extension numbers are to be composed of three digits, and set both "DG1" and "DG2" when the extension numbers are to be composed of four digits..	3-B-1.00
14th Hundred Block Extension				3-B-2.00
15th Hundred Block Extension				
16th Hundred Block Extension				
Operator Call (General)	0		Enter one through four digits number consisting of 0 through 9, * and # .	3-B-1.00
Operator Call (Specific)	blank			3-B-5.00
ARS/Local CO Line Access	9			4-C-10.00
				5-A-8.00
				3-B-1.00
				3-C-2.00
				4-C-3.01
				5-A-1.01
				6-D-1.01

Continue

Continued

Assigning Items	Default		Selection of Value	Reference
	Fixed 1	Fixed 2		
Trunk Group 01-08 Access	81		Enter one through four digits number consisting of 0 through 9, *, and #.	3-B-1.00
Trunk Group 09-16 Access	82			4-C-3.02
Trunk Group 17-24 Access	83			5-A-1.02
				6-0-1.02
Speed Dialing-System	*1	6*1		3-B-1.00
				5-A-2.02
Speed Dialing-Station	*2	6*2	3-B-1.00	
			5-A-2.01	

Description of Assigning Items

13th through 16th Hundred Block Extension	Assigns the leading one or two digits for extension DN (Directory Number). If the leading digit is not programmed the DN assignment is not possible.
Operator Call (General)	Assigns the feature number for general operator calling. Calls will always arrive at an Attendant Console if it is connected to the system.
Operator Call (Specific)	Assigns the feature number for specific operator calling. The required operator is specified by dialing the feature number and "1" for operator 1 and "2" for operator 2.
ARS/Local CO Line Access	Assigns the feature number for Automatic Route Selection or local access.
Trunk Group 01-08 Access	Assigns the feature number for Individual Trunk Group Dial Access (01 to 08).
Trunk Group 09-1 6 Access	Assigns the feature number for Individual Trunk Group Dial Access (09 to 16).
Trunk Group 17-24 Access	Assigns the feature number for the specified EQA or OCC Trunk Group Access.
Speed Dialing-System	Assigns the feature number for Speed Dialing-System.
Speed Dialing-Station	Assigns the feature number for Speed Dialing-Station.

Conditions

Refer to "Numbering Plan (01/1 1)."

13th to 16th Hundred Block Extension Extension numbers cannot include "*" and "#."

Function

The following functions appear on the function line of this setting screen.



COMMON (SHOW LV, CHG LV, INS, OUS, REMOVE, EXIT) and HRD CPY keys are available in all setting screens. INDEX key is also available in this screen. The operation of function keys are described in Section 7-1 "Operation of Function Keys." Only a message is provided here.

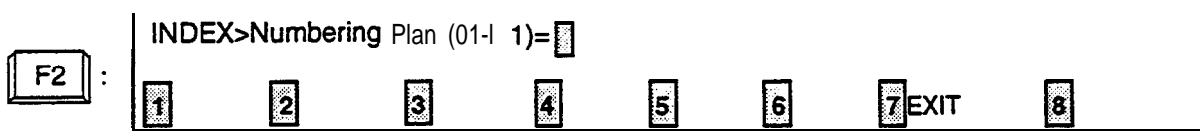

6.03 Numbering Plan (03/11)

system - Numbering Plan		OFL	PRG	SCR	DIR
Numbering Plan (03/11)					
No.	Feature	DG1	DG2	DG3	DG4
25	Doorphone Call (1-4)	4	0		
26	External Paging	4	1		
27	Station Paging	4	2		
28	Station Paging Answer	4	4		
29	External Paging Answer	4	4		
30	Night Answer 1	4	6		
32	Dial Call Pickup	4	7		
33	Directed Call Pickup	4	8		
34	Hold Extension Retrieve	4	9		
35	Redial	4	3		
36	External Feature Access	5	0		

COMMON INDEX HRD CPY

Summary

The third screen of the System-Numbering Plan screen sets the feature numbers for functions 25 to 36.

(Password level : Two or higher)

Assigning Items	Default		Selection of Value	Reference
	Fixed 1	Fixed 2		
Doorphone Call (1-4)	40	640	Enter one through four digits number consisting of 0 through 9, *, and #.	3-B-1 .00 4-G-7.00 5-E-2.00 6-H-4.00
External Paging	41	641		3-B-1 .00 4-H-1 .03 4-H-1 .04 5-F-1 .03 5-F-1.04 6-I-1 .03 6-I-1 .04

Continued

Continued

Assigning Items	Default		Selection of Value	Reference
	Fixed 1	Fixed 2		
Station Paging	42	642	Enter one through four digits number consisting of 0 through 9, *, and #.	3-B-1.00 4-H-1.01 4-H-1.02 4-H-1.04 5-F-1.01 5-F-1.02 5-F-1.04 6-t-1.01 6-I-1.02 6-t-1.04
External Paging Answer	43	643		3-B-1.00 4-H-1.03 4-H-1.04 5-F-1.03 5-F-1.04
Station Paging Answer	44	644		3-B-1.00 4-H-1.01 4-H-1.02 4-H-1.04 5-F-1.01 5-F-1.02 5-F-1.04
Night Answer 1	45	645		3-B-1.00 3-B-8.02 3-D-2.04 4-D-4.00
Night Answer 2	46	646		4-I-1.01 5-B-2.00 5-G-1.01
Dial Call Pickup	47	647		3-B-1.00 4-D-3.01 5-B-1.01
Directed Call Pickup	46	646		3-B-1.00 4-D-3.02 5-B-1.02
Hold Extension Retrieve	49	649		3-B-1.00 4-E-4.00 5-C-3.00
Redial	*3	6*3		3-B-1.00 5-A-2.03
External Feature Access	50	650		3-B-1.00 4-G-9.00 5-E-3.00

Description of Assigning Items

Doorphone Call (I-4)	Assigns the feature number for Doorphone calling. After dialing the feature number, dial 1 to 4 to specify the required doorphone.
External Paging	Assigns the feature number for External Paging. After dialing the feature number, dial 0 (external pagers 1 and 2), 1 (external pager 1), 2 (external pager 2), or * (all extensions and external pagers)
Station Paging	Assigns the feature number for Internal Paging. After dialing the feature number, dial the paging group number (1 to 8), 0 (to page all internal zones) or * (to page all internal and external zones).
External Paging Answer	Assigns the feature number for External Paging Answer. After dialing the feature number, dial 1 (for pager 1) or 2 (for pager 2)
Station Paging Answer	Assigns the feature number for Station Paging Answer.
Night Answer 1	Assigns the feature number for Night Answer 1. This feature number is used to answer calls assigned to UNA 1 in night service or TAFAS 1 in day service.
Night Answer 2	Assigns the feature number for Night Answer 2. This feature number is used to answer calls assigned to UNA 2 in night service or TAFAS 2 in day service
Dial Call Pickup	Assigns the feature number for Dial Call Pickup. This allows a user to pickup a call arriving at an extension in the same pickup group.
Directed Call Pickup	Assigns the feature number for Directed Call Pickup (General). This allows an extension user to pickup a call ringing at any extension in the same tenant.
Hold Extension Retrieve	Assigns the feature number for Hold Retrieving. This allows an extension user to retrieve a call held at another extension in the same tenant.
Redial	Assigns the feature number for Redial. This is used by an SLT to redial the last CO number.
External Feature Access	Assigns the feature number for sending a switchhook flash to a host PBX or Centrex service.

Conditions

Refer to 'Numbering Plan (01/1 1).'

Function

The following functions appear on the function line of this setting screen.



COMMON (SHOW LV, CHG LV, INS, OUS, REMOVE, EXIT) and HRD CPY keys are available in all setting screens. INDEX key is also available in this screen. The operation of function keys are described in Section 7-1 'Operation of Function Keys.' Only a message is provided here.

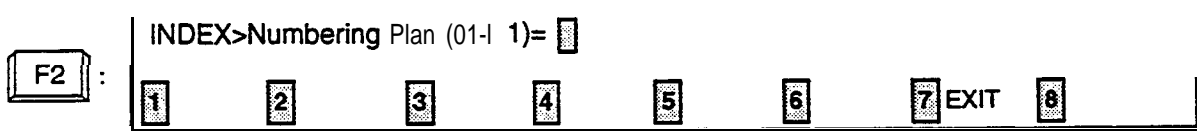

6.04 Numbering Plan (04/11)

System - Numbering Plan		OFL	PRG	SCR	DIR
Numbering Plan (04/11)					
No.	Feature	DG1	DG2	DG3	DG4
37	Account Code	*	#		
38	Hold	5	1		
39	Hold Retrieve	5	2		
40	Call Park - System	5	3		
41	Call Park Retrieve - System	5	4		
42	Call Park - Station	5	5		
43	Call Park Retrieve - Station	5	6		
44	Call Forwarding - All Call Set	*	*	2	
45	Call Forwarding - Busy Set	*	*	3	
46	Call Forwarding - No Answer Set	*	*	4	
47	Call Forwarding - to Trunk	*	*	5	
48	Call Forwarding - Busy/No Answer	*	*	6	

COMMON INDEX HRD CPY

Summary

The fourth screen of the System-Numbering Plan sets the feature numbers for function 37 to 48.

(Password : Two or higher)

Assigning Items	Default		Selection of Value	Reference
	Fixed 1	Fixed 2		
Account Code	*#	*#	Enter one through four digits number consisting of 0 through 9, *, and #.	3-B-1.00 4-I-2.00 5-G-2.00
Hold	51	651		3-B-1.00 5-C-1.00
Hold Retrieve	52	652		
Call Park-System	53	653		3-B-1.00 4-E-5.01 5-C-4.01
Call Park Retrieve-System	54	654		
Call Park-Station	55	655		3-B-1.00 4-E-5.02 5-C-4.02
Call Park Retrieve-Station	56	656		

Continued

Continued

Assigning items	Default		Selection of Value	Reference
	Fixed 1	Fixed 2		
Call Forwarding-All Call Set	* * 2		Enter one through four digits number consisting of 0 through 9, *, and #.	3-B-1 .00 4-F-2.01 5-D-2.01
Call Forwarding-Busy Set	* * 3			3-B-1 .00 4-F-2.02 5-D-2.02
Call Forwarding-No Answer Set	* * 4			3-B-1 .00 4-F-2.03 5-D-2.03
Call Forwarding-to Trunk	* * 5			3-B-1 .00 4-F-2.05 5-D-2.05
Call Forwarding-Busy/No Answer	* * 6			3-B-1 .00 4-F-2.04 5-D-2.04

Description of Assigning Items

Account Code	Assigns the feature number for entering account codes which may be forced or optional depending on system programming (Class of Service).
Hold	Assigns the feature number for Hold. This is used by an SLT to place the other party on hold.
Hold Retrieve	Assigns the feature number for retrieving Hold. This is used by an SLT to retrieve a held call.
Call Park-System	Assigns the feature number for Call Park-System. This is used by any extension user to park a call in one of twenty system call park zones.
Call Park Retrieve-System	Assigns the feature number for retrieving a call parked by Call Park-System .
Call Park-Station	Assigns the feature number for Call Park-Station. This is used by any extension user to park a call in that extension's call park zone.
Call Park Retrieve-Station	Assigns the feature number for retrieving a call parked by Call Park-Station .
Call Forwarding-All Call Set	Assigns the feature number for Call Forwarding of all calls.
Call Forwarding-Busy Set	Assigns the feature number for Call Forwarding of calls to busy extensions.
Call Forwarding-No Answer Set	Assigns the feature number for Call Forwarding of calls to no answer extensions.
Call Forwarding-to Trunk	Assigns the feature number for Call Forward to an outside party.
Call Forwarding-Busy/No Answer	Assigns the feature number for Call Forwarding of calls to extensions which are in busy or no answer status.

Conditions

Refer to 'Numbering Plan (01/1 1).'

Function

The following functions appear on the function line of this setting screen.

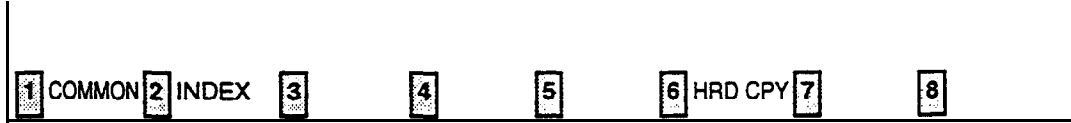

COMMON (SHOW LV, CHG LV, INS, OUS, REMOVE, EXIT) and HRD CPY keys are available in all setting screens. INDEX key is also available in this screen. The operation of function keys are described in Section 7-1 "Operation of Function Keys." Only a message is provided here.

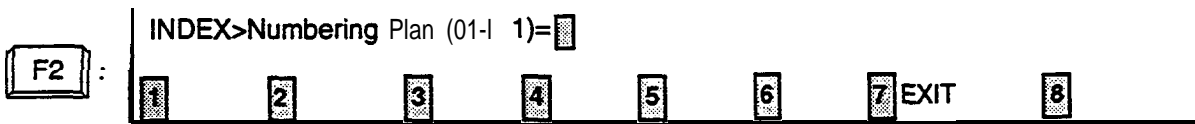

6.05 Numbering Plan (05/11)

System - Numbering Plan		I OFL	I PRG	I SCR	DIR
Numbering Plan (05/11)					
I No.	I Feature	I DG1	I DG2	I DG3	I DG4
49	Do Not Disturb Set	*	*	1	
50	Call Forwarding/Do Not Disturb Cancel	-I #	#	0	
51	Dial Call Pickup Deny Set	6	1	*	
52	Dial Call Pickup Deny Cancel	6	1	#	
53	Call Waiting Set	6	2	*	
55	BSS/OHCA Add Deny Cancel	6	2	*	
55 6	BSS/OHCA Add Deny Set	6	6 4 3	#	
58	BUSY Override Deny Cancel	6	4	*	
59	Data Line Security Set	6	5	*	
60	Data Line Security Cancel	6	5	*	

COMMON INDEX HRD CPY

Summary

The fifth screen of the System-Numbering Plan screen, constructed with nine screens, sets feature numbers for executing or canceling

various functions.
(Password level : Two or higher)

Assigning Items	Default		Selection of Value	Reference
	Fixed 1	Fixed 2		
Do Not Disturb Set		**1	Enter one through four digits number consisting of 0 through 9, *, and #.	3-B-1.00 4-D-6.00 5-B-4.00
Call Forwarding/Do Not Disturb Cancel		##0		3-B-1.00 4-O-6.00 4-F-2.0 1 to 2.05 3-B-4.00 5-D-2.01 to 2.05
Dial Call Pickup Deny Set		61*		3-B-1.00 4-D-3.03 6-B-1.03
Dial Call Pickup Deny Cancel		61#		

Continued

Continued

Assigning Items	Default		Selection of Value	Reference
	Fixed 1	Fixed 2		
Call Waiting Set	62 *		Enter one through four digits number consisting of 0 through 9 , *, and #.	3-B-1 .00 4-D-7.00 5-B-5.00
Call Waiting Cancel	62#			
BSS/OHCA Deny Set	63 *			3-B-1 .00 4-D-2.03
BSS/OHCA Deny Cancel	63#			
Busy Override Deny Set	64 *			3-B-1 .00 4-D-5.00 5-B-3.00
Busy Override Deny Cancel	64#			
Data Line Security Set	65 *			3-B-1 .00 4-1-6.00 5-G-4.00
Data Line Security Cancel	65#			

Description of Assigning Items

Do Not Disturb Set	Assigns the feature number for Do Not Disturb Set.
Call Forwarding/Do Not Disturb Cancel	Assigns the feature number for Call Forwarding /Do Not Disturb Cancel.
Dial Call Pickup Deny Set	Assigns the feature number for Dial Call Pickup Deny Set. This allows an extension user to prohibit other extensions from answering calls arriving at his extension.
Dial Call Pickup Deny Cancel	Assigns the feature number for Dial Call Pickup Deny Cancel.
Call Waiting Set	Assigns the feature number for Call Waiting Set. This allows an extension user to hear a call waiting tone when another call arrives during a conversation.
Call Waiting Cancel	Assigns the feature number for Call Waiting Cancel.
BSS / OHCA Deny Set	Assigns the feature number for BSS/OHCA Deny Set.
BSS / OHCA Deny Cancel	Assigns the feature number for BSS/OHCA Deny Cancel. BSS/OHCA Deny Cancel is used when the called extension is off-hook. BSS and OHCA allows a call to be made using the ICM button. BSS sets green 240 wink on the called party's ICM button while OHCA allows Hands-free Answerback to PITS KX-T7130 , KX-T12323OD or KX-T123235.
Busy Override Deny Set	Assigns the feature number for Busy Override Deny Set. Enabling this feature prevents other extensions from using Executive Busy Override on this extension.
Busy Override Deny Cancel	Assigns the feature number for canceling Busy Override Deny.
Data Line Security Set	Assigns the feature number for setting data communication mode. When set this feature prevents any call progress tones from being sent to the extension .
Data Line Security Cancel	Assigns the feature number for canceling data communication mode.

Conditions

Refer to 'Numbering Plan **(01/1 1).**'

Function

The following functions appear on the function line of this setting screen.



COMMON (SHOW LV, CHG LV, INS, OUS, REMOVE, EXIT) and HRD CPY keys are available in all setting screens. INDEX key is also available in this screen. The operation of function keys are described in Section 7-1 'Operation of Function Keys.' Only a message is provided here.

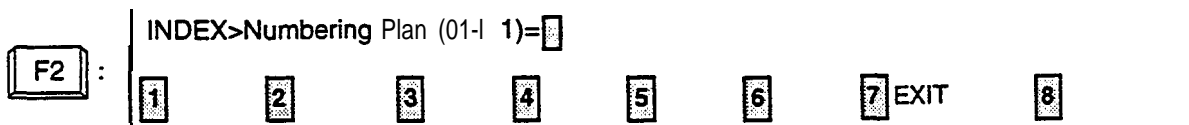

6.06 Numbering Plan (06/11)

System - Numbering Plan		OFL	PRG	SCR	DIR
Numbering Plan (06/11)					
I No.	I Feature	I DG1	DG2	DG3	DG4
61	Pickup Dialing Programming	6	6	0	
62	Pickup Dialing Set	6	6	*	
63	Pickup Dialing Cancel	6	6	#	
64	Absent Message Set	*	4		
65	Absent Message Cancel	#	4		
66	Timed Reminder Confirm	*	5	0	
67	Timed Reminder Set	*	5	1	
68	Timed Reminder Cancel	#	5		
69	Voice Calling Mode Set	6	7		*
70	Voice Calling Mode Cancel	6	7	#	
71	Voice Calling Deny Set	6	8	*	
72	Voice Calling Deny Cancel	6	8	#	

COMMON INDEX HRD CPY

Summary

The sixth screen of the System-Numbering Plan sets the feature numbers for executing or canceling various functions.

(Password level : Two or higher)

Assigning Items	Default		Selection of Value	Reference
	Fixed 1	Fixed 2		
Pickup Dialing Programming	660			3-B-1 .00 3-A-2. 04
Pickup Dialing Set	66*			
Pickup Dialing Cancel	66#			
Absent Message Set	*4	6*4	Enter one through four digits number consisting of 0 through 9, *, and #.	3-B-1. 00 4-I-7. 00 5-G-5. 00
Absent Message Cancel	#4	6#4		
Timed Reminder Confirm	*50			3-B-I .00 4-I-3.00
Timed Reminder Set	*51			3-B-I .00 4-I-3.00 5-G-3. 00

Continues

Continued

Assigning Items	Default		Selection of Value	Reference
	Fixed 1	Fixed 2		
Timed Reminder Cancel	#5	#50	Enter one through four digits number consisting of 0 through 9, *, and #.	3-6-I .00 4-I-3.00 5-G-3.00
Voice Calling Mode Set	67*			3-B-I .00 4-c-5.03
Voice Calling Mode Cancel	67#			
Voice Calling Deny Set	68*			3-B-1 .00 4-D-2.02
Voice Calling Deny Cancel	68#			

Description of Assigning Items

Pickup Dialing Programming	Pickup Dialing is a feature of SLT telephones which allows automatic calling when going off-hook. This feature allows the extension user to program the number to be called.
Pickup Dialing Set	This feature number enables Pickup Dialing.
Pickup Dialing Cancel	This feature number cancels Pickup Dialing.
Absent Message Set	Assigns the feature number for setting Absent Message. This is used by a user when he wants to inform callers of the reason he is away from his desk. The message will only appear on PITS equipped with display or Attendant Consoles.
Absent Message Cancel	Assigns the feature number for canceling Absent Message.
Timed Reminder Confirm	Assigns the feature number for confirming the time set by Timed Reminder. This feature is available only for PITS equipped with display.
Timed Reminder Set	Assigns the feature number for setting Timed Reminder.
Timed Reminder Cancel	Assigns the feature number for canceling Timed Reminder.
Voice Calling Mode Set	Assigns the feature number for setting Voice Calling Mode. This is set at the calling extension. Voice calling uses the ICM button to make an announcement through the speaker of the called extension when the called extension is idle.
Voice Calling Mode Cancel	Assigns the feature number for canceling Voice Calling Mode. This sets signal alerting.
Voice Calling Deny Set	Assigns the feature number for setting Voice Calling Deny. This is set by the called extension to deny voice calling. If "Voice Calling Deny" is set, the extension rings as usual (not voice alerted) when it receives a call.
Voice Calling Deny Cancel	Assigns the feature number for canceling Voice Calling Deny.

Conditions

Refer to 'Numbering Plan (01/1 1).'

Function

The following functions appear on the function line of this setting screen.



COMMON (SHOW LV, CHG LV, INS, OUS, REMOVE, EXIT) and HRD CPY keys are available in all setting screens. INDEX key is also available in this screen. The operation of function keys are described in Section 7-1 'Operation of Function Keys.' Only a message is provided here.

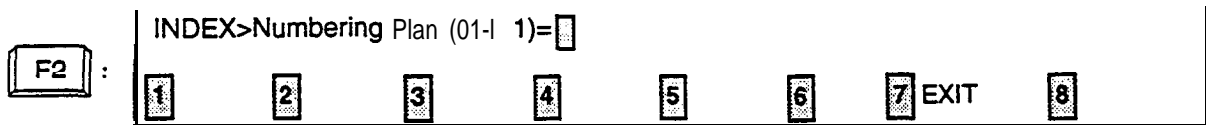

6.07 Numbering Plan (07/1 1)

system - Numbering Plan		I OFL	I PRG	SCR	DIR
Numbering Plan (07/11)					
I No.	I Feature	DG1	DG2	DG3	DG4
I 73	I Speed Dialing • Station Programing	--I 6	#		
I 74	Station Lock Set	-----I #	6	I	
75	Station Lock Cancel	----- #	6		
76	Walking COS Set	----- #	7		
77	Walking COS Cancel	----- #	7		
78	Walking Station Set	----- #	8		
I 79	Walking Station Cancel	-----I #	8		
80	Message Set	----- #	9		
81	Message Cancel	-----I #	9	I	I
82	Station Program Clear	----- #	#	#	
83	Message Waiting Reply	----- 5	7		
84	TIE Trunk Access	----- 8	4		
+ - B - B - - - - - B - - - - -					
COMMON INDEX				HRD CPY	

Summary

The seventh screen of the System-Numbering Plan sets feature numbers for executing or canceling various functions.

(Password level : Two or higher)

Assigning Items	Default		Selection of Value	Reference
	Fixed 1	Fixed 2		
Speed Dialing-Station Programming	6*	6*5	Enter one through four digits number consisting of 0 through 9, *, and #.	3-B-I .00 5-A-2.01
Station Lack Set	*6	6*6		3-B-I .00 4-I-9.00 5-G-7.00
Station Lock Cancel	#6	6#6		3-B-1.00 4-c-9.00 5-A-7.00
Walking COS Set	*7	6*7		3-B-I .00 3-F-3.00
Walking COS Cancel	#7	6#7		
Walking Station Set	*8	6*8		

Continued

Continued

Assigning items	Default		Selection of Value	Reference
	Fixed 1	Fixed 2		
Walking Station Cancel	#8	6#8	Enter one through four digitsnumber consisting of 0 through 9 , * , and #.	3-B-I .00 3-F-3.00
Message Set	*9	6*9		5-G-6.00
Message Cancel	#9	6#9		3-B-I .00 4-I-8.00 5-G-6.00 6-J-4.00
Station Program Clear	###	###		3-B-I .00 4-I- 0.00 5-G-8.00
Message Waiting Reply	57	657		5-G-6.00
TIE Trunk Access	84	7		3-F-1 4.00

Description of Assigning Items

Speed Dialing-Station Programming	Assigns the feature number for setting Speed Dialing to SLT(Single Line Telephone).
Station Lock Set	Assigns the feature number for setting Electronic Station Lock. When set the extension user cannot place outgoing CO calls from that extension.
Station Lock Cancel	Assigns the feature number for canceling Electronic Station Lock.
Walking COS Set	Assigns the feature number for setting Walking COS. This allows an extension user to temporarily change the COS of an extension to that of another extension.
Walking COS Cancel	Assigns the feature number for canceling Walking COS.
Walking Station Set	Assigns the feature number for starting to move a telephone set to another location.
Walking Station Cancel	Assigns the feature number for canceling the moved extension.
Message Set	Assigns the feature number for setting Message Waiting indication. This feature number is available only for SLT's not for PITS's .
Message Cancel	Assigns the feature number for canceling Message Waiting indication.
Station Program Clear	Assigns the feature number for clearing data assigned by other feature numbers, such as Call Forwarding/Do Not Disturb/Timed Reminder, etc..
Message Waiting Reply	Assigns the feature number for replying the Message Waiting Indication set by other extensions. This feature number is available only for a Single Line Telephone with MESSAGE lamp.
TIE Trunk Access	Assigns the feature number for TIE Trunk Access.

Conditions

Refer to 'Numbering Plan (01/1 1).'

Function

The following functions appear on the function line of this setting screen.



COMMON (SHOW LV, CHG LV, INS, OUS, REMOVE, EXIT) and HRD CPY keys are available in all setting screens. INDEX key is also available in this screen. The operation of function keys are described in Section 7-I "Operation of Function Keys." Only a message is provided here.

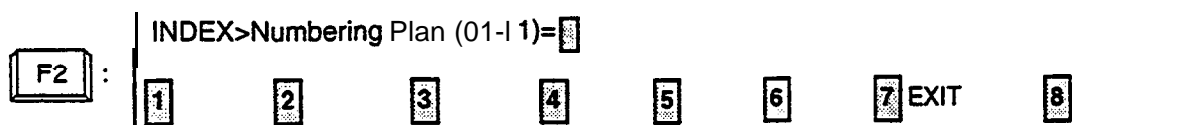

6.08 Numbering Plan (08/11)

System - Numbering Plan		I OFL	PRG	SCR	DIR
Numbering Plan (08/11)					
I Ho.	I Feature	DG1	DG2	DG3	DG4
85	Night Mode Set	7	0	*	
86	Night Mode Cancel	7	0	#	
87	Night Service Manual Mode Set	7	1	*	
88	Night Service Manual Mode Cancel	7	1	#	
89	Flexible Night Service	7	2		
90	Remote Station Lock Set	7	3	1	*
91	Remote Station Lock Cancel	7	3		#
92	Remote DND Set	7	4		*
93	Remote DND Cancel	7	4		#
94	Remote FWD Cancel	17151			
95	Remote FWD Cancel - One Time	7	6		
96	BGM Through External Pager	7	7		

COMMON INDEX HRD CPY

Summary

The **eighth** screen of the System-Numbering Plan sets feature numbers for executing or canceling various functions. (Password level : Two or higher)

Assigning Items	Default		Selection of Value	Reference
	Fixed1	Fixed 2		
Night Mode Set	70*	69*	Enter one through four digits number consisting of 0 through 9, *, and #.	3-B-8.05 4-I-1.03 5-G-1.03
Night Mode Cancel	70#	69#		
Night Service Manual Mode Set	71*	51*		3-B-1.00 4-I-1.03 5-G-1.03 6-J-1.02
Night Service Manual Mode Cancel	71#	51#		
Flexible Night Service	7 2	520		3-B-1.00 3-B-8.03 4-I-1.02 5-I-1.02 6-J-1.01

Continued

Continued

Assigning items	Default		Selection of Value	Reference
	Fixed 1	Fixed 2		
Remote Station Lock Set	73*	53*	Enter one through four digits number consisting of 0 through 9, *, and #.	3-B-1.00 4-I-11.00 j-G-9.00 3-J-5.00
Remote Station Lock Cancel	73#	53#		
Remote DND Set	74*	54*		
Remote DND Cancel	74#	54#		
Remote FWD Cancel	75	675		
Remote FWD Cancel- One Time	76	676		
BGM Through External Pager	77	677		3-B-1.00 t-H-2.00 j-F-2.00 3-I-2.00

Description of Assigning items

Night Mode Set	Assigns the feature number for setting Night mode manually (for operator 1 only). This is used when night mode is set to 'Manual.'
Night Mode Cancel	Assigns the feature number for setting Day mode manually (for operator 1 only).
Night Service Manual Mode Set	Assigns the feature number for starting Night Service mode manually (for operator 1 only). This is used when night mode is set to "Auto."
Night Service Manual Mode Cancel	Assigns the feature number for starting Night Service mode automatically (for operator 1 only).
Flexible Night Service	Assigns the feature number for setting an answering point in Night mode (for operator 1 only).
Remote Station Lock Set	Assigns the feature number for setting Electronic Station Lock to extensions (for operators 1 and 2 only).
Remote Station Lock Cancel	Assigns the feature number for unlocking extensions (for operators 1 and 2 only).
Remote DND Set	Assigns the feature number for setting Do Not Disturb to extensions (for operators 1 and 2 only).
Remote DND Cancel	Assigns the feature number for canceling Do Not Disturb for extensions (for operators 1 and 2 only).
Remote FWD Cancel	Assigns the feature number for canceling Call Forwarding feature for extensions (for operators 1 and 2 only).
Remote FWD Cancel- One Time	Assigns the feature number for canceling Call Forwarding feature for extensions only once (for operators 1 and 2 only).
BGM Through External Paging	Assigns the feature number for sending BGM (background music) through External Pager (for operator 1 only).

Conditions

Refer to 'Numbering Plan (01/1 1).'

Function

The following functions appear on the function line of this setting screen.

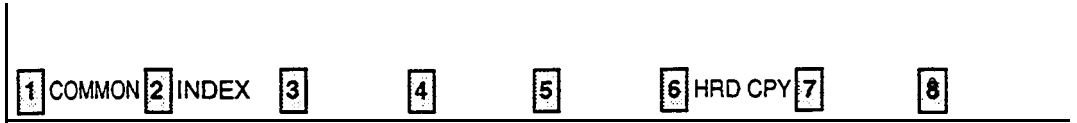

COMMON (SHOW LV, CHG LV, INS, OUS, REMOVE, EXIT) and HRD CPY keys are available in all setting screens. INDEX key is also available in this screen. The operation of function keys are described in Section 7-1 "Operation of Function Keys." Only a message is provided here.

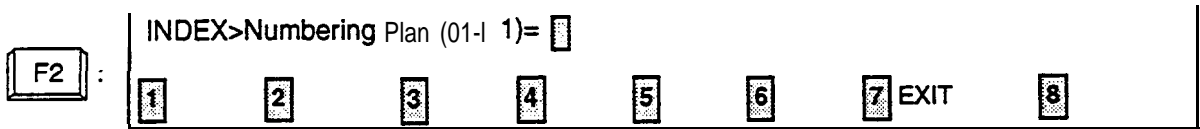

6.09 Numbering Plan (09/11)

System * Numbering Plan		OFL PRG SCR DIR			
Numbering Plan (09/11)					
No.	Feature	DG1	DG2	DG3	DG4
97	Busy Out Trunk	7	8	#	
98	Unbusy Trunk	I	7	8	#
991	OGM Record		7	g	1
100	OGM Playback	I	7	9	2
1101	UCD Log In	I	#	0	
1102	UCD Log Out		#	0	
103	Remote Timed Reminder Confirm		7	#	0
104	Remote Timed Reminder Set		7	#	1
105	Remote Timed Reminder Cancel		7	#	
106	Call Forwarding-Follow Me Set		#	#	7
107	Call Forwarding-Follow Me Cancel		#	#	8
108	(Reserve)		-	-	-

COMMON INDEX HRD CPY

Summary

The ninth screen of the System-Numbering Plan sets feature numbers for executing or canceling

various functions.
(Password level : Two or higher)

Assigning Items	Default		Selection of Value	Reference
	Fixed 1	Fixed 2		
Busy Out Trunk	78*	57*	Enter one through four digits number consisting of 0 through 9, *, and #.	3-B-1.00 3-F-8.00 8-J-10.00
Unbusy Trunk	78#	57#		
OGM Record	791	691		3-B-1.00 3-F-4.00 6-J-8.00
OGM Playback	792	692		
UCD Log In	*0	6*0		3-B-1.00 4-D-8.00 5-B-6.00
UCD Log Out	#0	6#0		
Remote Timed Reminder Confirm	7*0	5*0		4-I-14.00 6-J-1 3.00
Remote Timed Reminder Set	7*1	5*1		
Remote Timed Reminder Cancel	7#	50#		

Assigning Items	Default		Selection of Value	Reference
	Fixed 1	Fixed 2		
Call Forwarding-Follow Me Set	* * 7		Enter one through four digits number consisting of 0 through 9, *, and #.	4-F-2.06 1 O-C-68.00
Call Forwarding-Follow Me Cancel	* * 8			5-D-2.05 1 O-C-68.00

Description of Assigning Items

Busy Out Trunk	Assigns the feature number for manually putting a trunk into busy status (for operator 1 only).
Unbusy Trunk	Assigns the feature number for canceling Busy Out Trunk (for operator 1 only).
OGM Record	Assigns the feature number for recording OGM (for operator 1 only).
OGM Playback	Assigns the feature number for playback of OGM (for operator 1 only).
UCD Log In	Assigns the feature number for setting extensions to UCD (Uniform Call Distribution) service.
UCD Log Out	Assigns the feature number for removing extensions from UCD service.
Remote Timed Reminder Confirm	Assigns the feature number for confirming the time set by Remote Timed Reminder. This feature is available for the Operator 1 and 2 at the Attendant Consoles or PITS with display.
Remote Timed Reminder Set	Assigns the feature number for setting Remote Timed Reminder. This feature is available for the Operator 1 and 2 at the Attendant Consoles or PITS with display.
Remote Timed Reminder Cancel	Assigns the feature number for canceling Remote Timed Reminder. This feature is available for the Operator 1 and 2 at the Attendant Consoles or PITS with display.
Call Forwarding-Follow Me Set	Assigns the feature number for setting Call Forwarding-Follow Me feature.
Call Forwarding-Follow Me Cancel.	Assigns the feature number for canceling Call Forwarding-Follow Me feature.

Conditions

Refer to "Numbering Plan (01/1 1)."

Function

The following functions appear on the function line of this setting screen.

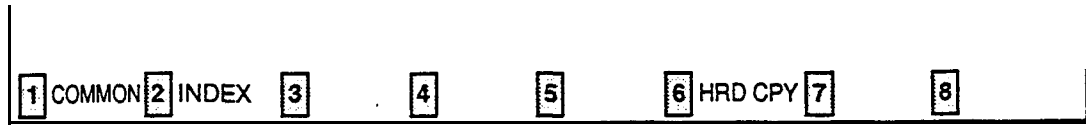

COMMON (SHOW LV, CHG LV, INS, OUS, REMOVE, EXIT) and HRD CPY keys are available in all setting screens. INDEX keys is also available in this screen. The operation of function keys are described in Section 7-1 "Operation of Function Keys." Only a message is provided here.

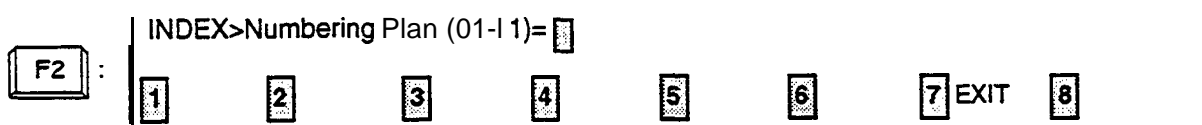

6.10 Numbering Plan (10/11)

System - Numbering Plan		OFL	PRG	SCR	DIR
Numbering Plan (10/11)					
No.	Feature	DG1	DC2	DC3	DC4
109	Other PBX Extension 01		-	-	
110	Other PBX Extension 02			-	-
111	Other PBX Extension 03			-	-
112	Other PBX Extension 04			-	-
113	Other PBX Extension 05			-	-
114	Other PBX Extension 06			-	-
115	Other PBX Extension 07			-	-
116	Other PBX Extension 08			-	-
117	Other PBX Extension 09			-	-
118	Other PBX Extension 10			-	-
119	Other PBX Extension 11			-	-
120	Other PBX Extension 12			-	-

COMMON INDEX HRD COPY

Summary

The tenth screen of the System-Numbering Plan sets the other PBX extension numbers for 01 through 12. (Password level : Two or higher)

Assigning Items	Default		Selection of Value	Reference
	Fixed 1	Fixed 2		
Other PBX Extension 01 through 12		blank	0 to 9: set "DG1" and leave "DG2" blank when the other PBX extension numbers are to be composed of three digits, and set both "DG1" and "DG2" when the other PBX extension numbers are to be composed of four digits.	3-B-1 .00 3-F-14.0'

Description of Assigning Items

Other PBX Extension 01 through 12 Assigns the leading one or two digits of other PBX extension numbers. If you employ PBX Code method for TIE calls (See Section 3-F-14.00), this programming is not required.

Conditions

Other PBX Extension 01 through 12 Cannot include "*" and "#".

6.11 Numbering Plan (1 1/1 1)

System - Numbering Plan		OFL	PRG	SCR	DIR
Numbering Plan (11/11)					
I No.	I Feature	DG1	DG2	DC3	DC4
121	Other PBX Extension 13			-	-
122	Other PBX Extension 14			-	-
123	Other PBX Extension 15			-	-
124	Other PBX Extension 16			-	-
125	Transfer	5	8		
126	Conference	5	9		
127	(Reserve)	-	-	-	-
128	(Reserve)	-	-	-	-
129	(Reserve)	-	-	-	-
130	(Reserve)	-	-	-	-
131	(Reserve)	-	-	-	-
132	(Reserve)	-	-	-	-

COMMON INDEX HRD CPY

Summary

The eleventh screen of the System-Numbering Plan sets the other PBX extension numbers for 13 through 16 and feature number for Transfer and Conference.

(Password level : Two or higher)

Assigning Items	Default		Selection of Value	Referenc
	Fixed 1	Fixed 2		
Other PBX Extension 13 through 16		blank	0 to 9: set "DG1" and leave "DG2" blank when the other PBX extension numbers are to be composed of three digits, and set both "DG1" and "DG2" when the other PBX extension numbers are to be composed of four digits.	3-B-1.00 3-F-14.0
Transfer		58	Enter one through four digits number consisting of 0 through 9, *, and #.	5-D-1.00
Conference		59		5-E-1.00

Description of Assigning Items

Other PBX Extension 13 through 16 Assigns the leading one or two digits of other PBX extension numb&s. If
If you employ PBX Code method for TIE calls (See Section 3-F-14.00)
this programming is not required.

Transfer Assigns the feature number for SLT Transfer Operation
This feature number is available for an SLT user when "SLT Transfer
Operation" (See section 10-C-53.00 "World Select 3 (WS3)") is set to
"Mode 2".

Conference Assigns the feature number for SLT Conference Operation.
This feature number is available for an SLT user when "SLT Transfer
Operation" (See section 10-C-53.00 "World Select 3 (WS3)") is set to
"Mode 2".

Conditions

Refer to "Numbering Plan (01/1 1)."

Other PBX Extension 13 through 16 Cannot include "*" and "#".

Description of Assigning items

- Fixed Message (1 to 6) Fixed messages to be displayed on a PITS telephone with the display. These messages cannot be changed by system programming. Extension user can set the desired one to his or her PITS telephone set. If the message assigned contains parameters, these should be entered by the extension user.
- Flexible Message (07 to 16) Assigns variable messages to be displayed on a PITS telephone with the display. These messages can be assigned and changed by system programming. Extension user can set the desired one to his or her PITS telephone and if the message contains any parameters, these should be entered by the extension user.

Conditions

If "System-Operation", Tenant Service is assigned to "Yes," 10 flexible messages (7 to 16) can be split between tenants 1 and 2. To split them, 'System-Tenant', Absent Message Boundary is used. Six **fixed** messages cannot be split between tenants. They are used by both tenants in common.

A flexible message in use by an extension user cannot be changed or deleted. If you attempt, the changed data cannot be saved and the following error message appears on the screen.

***** ERROR: Some extensions are using that message.

Function

The following functions appear on the function line of this setting screen.

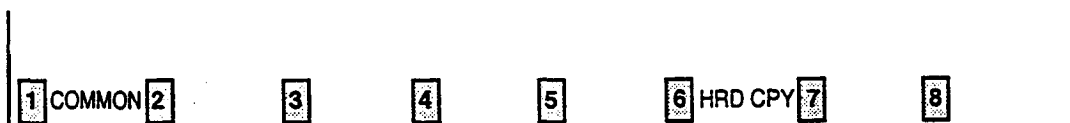

COMMON (**SHOW LV**, **CHG LV**, INS, OUS, REMOVE, EXIT) and HRD CPY keys are available in this setting screen.

For operation, refer to Section 7-I "Operation of Function Keys."

E. Group Screen

1 .00 Trunk Group

1 .01 Trunk Group (1/2)

```

Trunk Group          I OFL | PRG | SCR | SEL
-----+-----+-----+-----+
Trunk Group' No. = 01 (1/2)
-----+-----+-----+-----+
| Type -----| DDD
| Name -----|
| Tenant -----| 1
| Incoming/Outgoing -----| I Incoming Only
| Incoming Hode (Day) -----| I DIL 1:1
| Incoming Hode (Night) ---| I FLEXIBLE
| Intercept Routing (Day) -| A T T      (Type:No.)
| Intercept Routing (Night)| E X T:5002 (Type:No.)
| Toll Restriction Level --| 01
| Toll Restriction Table --| I 3
| Dialing Plan -----| Type-A
| CO-CO Duration Limit ---| I 3      minute(s) (1-64)
| Disconnect Time -----| I 1.5    second(s)
| Pause Time -----| 3.5     second(s)
| Hook Switch Flash Time --| None
-----+-----+-----+-----+
COMMON 2 INDEX 3 READ 4 HRD CPY 5
  
```

Summary

The Group-Trunk Group screen consists of 16 groups, each of which includes two screens. This screen is the first screen used to assign various

data for trunk groups.
(Password level : Two or higher)

Assigning Items	Default	Selection of Value	Reference
Type	DDD	DDD : Direct Distance Dialing FEX : Foreign Exchange WATS : Wide Area Telecommunication Service PVL : Private Line PBX : Behind PBX DID : Direct inward Dialing TIE : TIE Line	3-B-7.05 3-c-1 .01 3-c-1.03 3-c-4.00 3-D-2.03 3-D-2.07 3-F-1 4.00
N a m e	c o	A maximum of three digits consisting of characters, numbers and marks : Trunk group name	3-B-7.05
Tenant	blank	1 or 2 : tenant number	3-B-7.05 3-B-4.00
incoming/Outgoing	Both-Way	Incoming Only : for Incoming calls only Outgoing Only : for Outgoing calls only Both-Wav : for both	3-B-7.05

(2) Conditions for setting trunk groups

If a trunk group changes "Group-Trunk Group", Type assigned to "PVL" (Private Line) to another type and if any CO lines belonging to the trunk group are selected to be "PRV-CO" (Private CO) in "Extension-Station, Type/Number, those CO lines are canceled from "Extension-Station", Type/Number automatically.

2. Single CO, Group CO setting

If "Single CO" or "Group CO" is selected in 'Extension-Station', Type,

(1) Conditions of assigning DN buttons

- The designated CO line is assigned to a trunk group in **"Trunk-CO Line"**, Trunk Group.
The trunk group should have "Group-Trunk Group", Type assigned to other than **"PVL"** or "DID."

(2) Conditions of setting 'Incoming Mode (Day)

- 1) If "Incoming Mode (Day)" is changed from **"DIL 1:1"** to another mode, The trunk group changed to another mode in "Group-Trunk Group", incoming Mode (Day) is assigned in "Trunk-CO Line", Trunk Group. The **"Trunk-CO Line"**, Direct Termination setting is canceled.
- 2) If 'Incoming Mode (Day)' is changed from 'DIL 1 :N' to another mode, "Group-Trunk Group", Destination (DIL 1: N only) setting is canceled.

(3) Conditions of setting "Type"

Changing "Type" to **"PVL"** (Private Line) from any other modes cancels **"Single CO"** or 'Group CO' assigned to a DN button of an extension belonging to this trunk group in 'Extension-Station', Type.

It is impossible to change from 'DID' or **"TIE"** to any other modes and vice versa if any CO line in "Trunk-CO Line" belongs to the "Group-Trunk Group."

3. Other Conditions

The following tabular listings of items by trunk group type shows the items that cannot be assigned (“—” is displayed) when Incoming/Outgoing mode of the trunk group is set to “Both-Way (default).”

Trunk Group(1/2)

Type	DDD FEX WATS	PVL	PBX	DID	TIE
incoming/Outgoing	Both-Way				
Incoming Mode(Day)	ATT (1/2) or DIL 1:1	—	ATT (1/2) or DIL 1:1	—	—
Incoming Mode(Night)	FLEXIBLE	—	FLEXIBLE	—	—
Intercept Routing(Day)	blank	blank	blank	blank	—
Intercept Routing(Night)	blank	blank	blank	blank	—

Trunk Group(2/2)

Destination (DIL 1:N Only) Type and Number	blank	—	blank	—	blank
DID Digit Modification Table	—	—	—	1	—
PBX Access Code (No Restriction)	—	—	blank	—	—
PBX Access Code (Restriction)	—	—	blank	—	—
CO-TIE Restriction	Yes	Yes	Yes	Yes	—
TIE-CO Restriction	—	—	—	—	Yes
TIE Forced Account Code Mode	—	—	—	—	No
TIE Incoming Delete Digit	—	—	—	—	0
TIE Incoming Insert Dial	—	—	—	—	blank

- From software version **9.XX** and above, Incoming/Outgoing mode of the trunk group with DID can be assigned to ‘Both-Way,’ ‘Incoming Only,’ or ‘Outgoing Only.’ However, please select **“Incoming Only”** if DID lines are available with only receiving incoming calls in your area.

[Note]

When “Incoming Only” is selected in the trunk group with DID, the following items are assignable but they do not work at all in Incoming Only mode.

- Disconnect Time
- Pause Time
- Hook Switch Flash Time
- Max. Dial No. after EFA Signal

If the following types are selected for "Incoming/Outgoing," the items below cannot be assigned:

Incoming/Outgoing	Items impossible to Assign
incoming Only	Toll Restriction Level Toll Restriction Table Dialing Plan PBX Access Code (No Restriction), (Restriction)
Outgoing Only	Incoming Mode (Day), (Night) Destination (DIL 1 :N Only)

If the following types are selected for "Incoming Mode (Day)," the item below cannot be assigned:

Incoming Mode (Day)	Items Impossible to Assign
ATT DIL 1:1 DISA TAFAS 1 TAFAS 2	Destination (DIL I:N Only) Type and Number

If 'System-Operation' External Paging 1, 2 is set to "No," "TAFAS 1/TAFAS 2" cannot be assigned to 'Incoming Mode (Day)."

When pressing the NEXT key, this screen changes as follows:

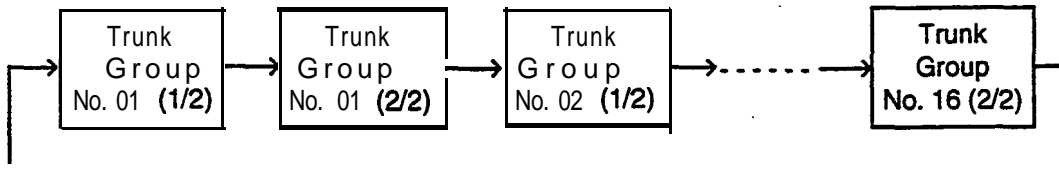

Pressing the PREV key changes the screen in reverse order.

Function

The following functions appear on the function line of this setting screen.

1	COMMON	2	INDEX	3		4	READ	5		6	HRD CPY	7		8
---	--------	---	-------	---	--	---	------	---	--	---	---------	---	--	---

COMMON (SHO LV, CHG LV, INS, OUS, REMOVE, EXIT) and HRD CPY keys are available in all setting screens. INDEX, READ keys are also available in this screen. The operation of function keys are described in Section 7-1 'Operation of Function Keys.' Only messages are provided here.

F2	:	INDEX>Trunk Group No. (01-16)=	1	2	3	4	5	6	7	EXIT	8
----	---	--------------------------------	---	---	---	---	---	---	---	------	---

F4	:	READ>Trunk Group No. (01-16)=	1	2	3	4	5	6	7	EXIT	8
----	---	-------------------------------	---	---	---	---	---	---	---	------	---

1.02 Trunk Group (2/2)

Group • Trunk Group		OFL	PRG	SCR	SEL
Trunk Group No. = 01 (22)					
Destination (DIL 1:N Only)	- , - , -				
Type and Number	I - , - , -				
	- , - , -				
DID Digit Modification Table	----- i s , - ::				
PBX Access Code (No Restriction)	- , - , - , - , - , -				
PBX Access Code (Restriction)	- , - , - , - , - , -				
Max. Dial No. after EFA Signal	----- 0 (0-32)				
CO - TIE Restriction	----- Yes				
TIE - CO Restriction	----- -				
TIE Forced Account Code Mode	----- -				
TIE Incoming Delete Digit	----- (0-4)				
TIE Incoming Insert Dial	----- -				
<div style="display: flex; justify-content: space-between; font-size: small;"> 1 COMMON 2 INDEX 3 4 READ 5 6 HRD CPY 7 8 </div>					

Summary

The Group-Trunk Group screen consists of a maximum of 16 groups, each of which includes two screens. This is the second screen used to

assign various data for trunk groups.
(Password level : Two or higher)

Assigning Items	Default	Selection of Value	Reference
Destination (DIL 1 :N Only) Type and Number	blank	Type : destination blank : if not assigned ICM : selecting intercom group PCKUP : selecting pickup group EXT : selecting extension	3-B-7.05 3-D-2.01
	blank	Number blank : when "blank" is selected for type 01 to 32: pickup group number : three or four digits : extension number 1 to 8 : intercom group number	
DID Digit Modification Table	b l a n k	K1 to 4 : table number	3-B-7.05 3-D-2.03 9-K-2.00

Continued

COMMON (SHO LV, CHG LV, INS, OUS, REMOVE, EXIT) and HRD CPY keys are available in all setting screens. INDEX, READ keys are also available in this screen. The operation of function keys are described in Section 7-1 'Operation of Function Keys.' Only messages are provided here.

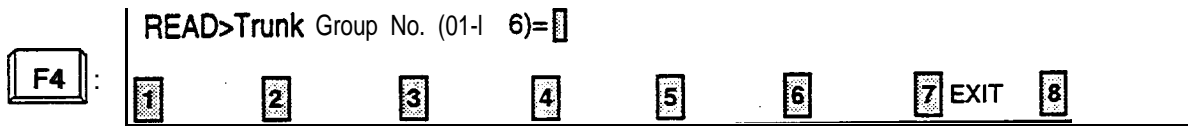
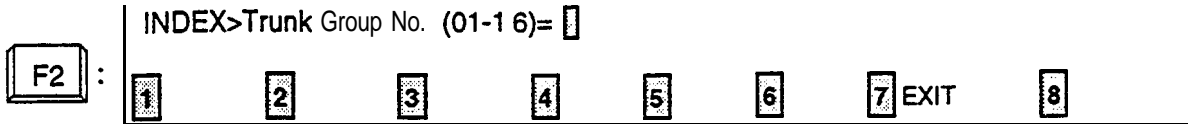

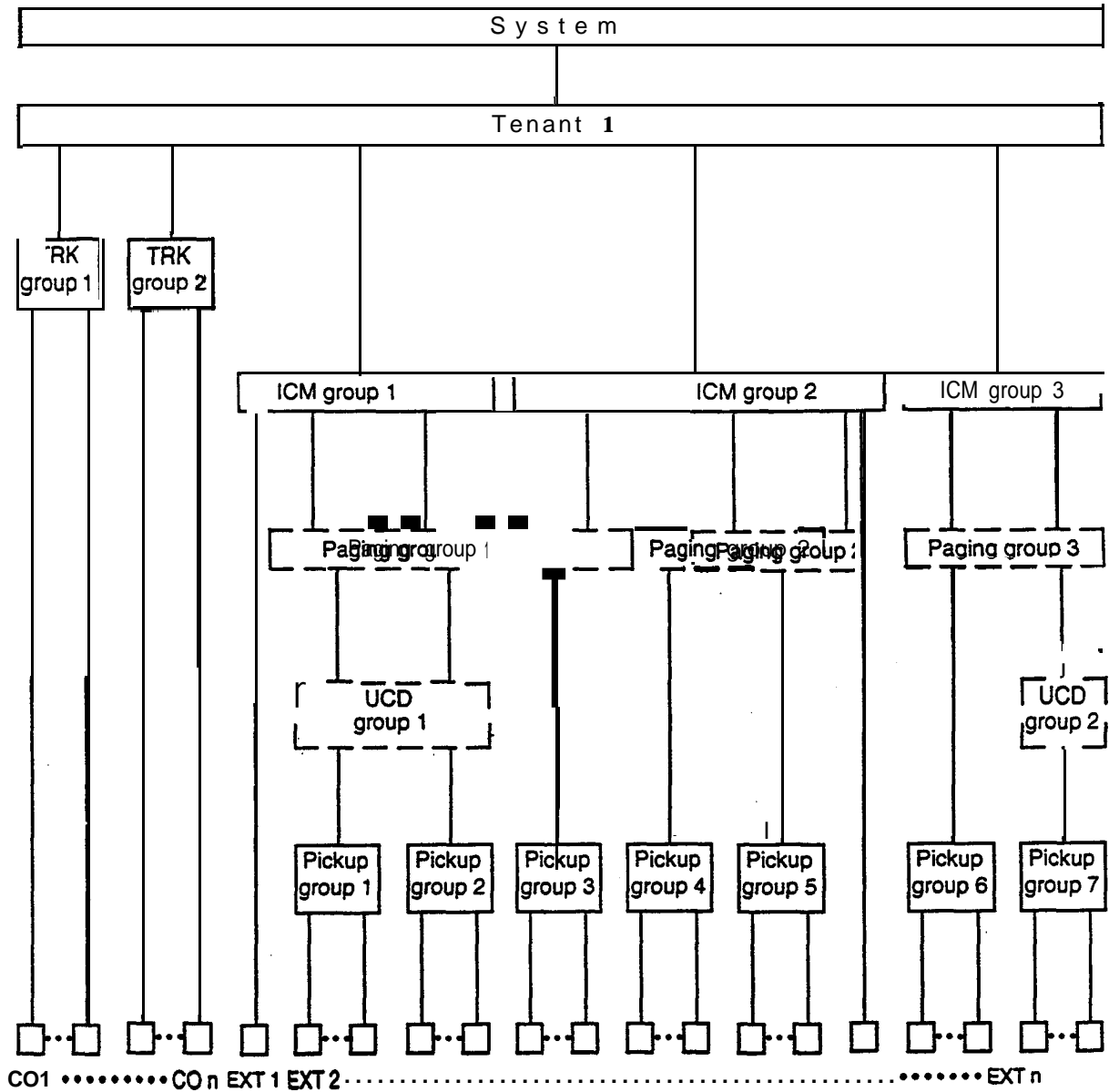

Function

The following functions appear on the function line of this setting screen.



COMMON (SHOW LV, CHG LV, INS, OUS, REMOVE, EXIT) and HRD CPY keys are available in this setting screen. For operation, refer to Section 7-1 'Operation of Function Keys.'

F. Trunk Screen

1.00 CO Line

Trunk - CO Line		OR.	PRG	SCR	DIR
Trunk Equipment No. = 2021					
Trunk Group	-----		01		
Trunk Name	-----		24		
Direct Termination	-----		D N : 5000		
Night Answer Point (Type:No.)	----		E X T : 401		
Dial Mode	-----		DTMF		
DTMF Duration Time	-----		80 msecond (s)		
Pulse Speed	-----		---		
Break	-----		--- %		
CPC Detection	-----		5*8 msecond (s)		
Start Arrangement	-----		---		
Wink Signal Time Out	-----		---*64 msecond (s)		

1 COMMON 2 INDEX 3 4 READ 5 6 HRD CPY 7 8

Summary

Assigns various parameters for CO lines. This screen does not appear if any CO trunk card is not assigned in Configuration-Slot Assignment screen.

144 screens are provided for CO Line. (Password level : Three or higher)

Assigning Items	Default	Selection of Value	Reference
Trunk Group	01 : for CO 15:forTIE 1 6 : f o r D I D	01 to 16 : trunk group number	3-B-7.05
Trunk Name	TXXXX Physical number	A maximum of ten digits composed of letters, numbers and symbols blank : no trunk name programmed	4-A-4.04
Direct Termination	blank : for "with ATLC" Directory number : for "without ATLC" in physical number order of extensions paired with CO lines	DN and directory number (three or four digits): call destination (Extension, Remote FDN, UCD FDN) None : no directtermination	3-D-2.01

Continued

Assigning Items	Default	Selection of Value	Reference
Night Answer Point (Type : No.)	Directory number : for each extension in physical number order	Type (select input) None : no Night Answer Point UNA : Universal Night Answer EXT : Extension User RMT : Remote Administration NAG : Night Answer Group No. 1 or 2 : for "UNA" three or four digits : extension number for "EXT"	3-B-8.00 10-C-59.00
Dial Mode	(for U.S.A. and Canada) DTMF	DTMF : DTMF mode Pulse : Pulse mode	3-c-3.00 10-C-51.00
	(for areas other than U.S.A. and Canada) Pulse	MFC-R2 : MFC-R2 mode	
DTMF Duration Time	(for U.S.A. and Canada) 80 ms	80 ms/160 ms : duration time	3-B-10.00
	(for areas other than U.S.A. and Canada) blank		
Pulse Speed	(for U.S.A. and Canada) blank	Low Speed/High Speed : pulse speed	None
	(for areas other than U.S.A. and Canada) Low Speed		
% Break	(for U.S.A. and Canada) blank	60% / 67% : % break	10-C-51.00
	(for areas other than U.S.A. and Canada) 60%		
CPC Detection	50 (400 ms)	00 : unavailable for CPC detection 01 : 6.5 ms detection 02 to 75 : 8 N ms detection	3-B-10.00 3-F-7.00 10-C-49.00
Start Arrangement	Send Delay Wink	Immediate Start : immediate start type Send Delay Wink : wink start type	3-D-2.03
Wink Signal Time-Out	16 (1.024 s)	1: 64ms 2: 128ms . . . 127 : 8.128 s	

Description of Assigning Items

Trunk Group	Assigns the trunk group number of the CO line.
Trunk Name	Assigns the name of the CO line. This will appear on the CRT screen of the Attendant Console and the display of PITS telephone (if provided) when making or receiving a CO call.
Direct Termination	Assigns the directory number of the destination, when the trunk group of the line is set to 'DIL 1:1' in Incoming Mode (Day).
Night Answer Point (Type : No.)	Assigns Night Answer point when the 'Incoming Mode (Night)' is assigned to "FIXED" or "FLEXIBLE." "NAG" can be selected only when Trunk Group "Incoming Mode (Night)" is assigned to "FIXED." If it is not assigned to 'FIXED' nor "FLEXIBLE," "—" appears in the setting field, and it is impossible to assign a destination.
Dial Mode	Assigns the dial type (DTMF, Pulse or MFC-R2). This is the output mode regardless of the dial mode of the telephone used. If Pulse is selected, refer to Section 10-C-51 .00 "World Select 1 (WS1) about the following items. <ul style="list-style-type: none">• Interdigit Pause• Pulse Type• % Break Detect
DTMF Duration Time	Assigns the duration of the DTMF tones sent. It is possible to assign this option only when the "Dial Mode" is set to 'DTMF. When the dial mode is set to 'Pulse," this field is blank.
Pulse Speed	Assigns the pulse speed. It is possible to assign this option only when the "Dial Mode" is set to "Pulse." When the dial mode is set to "DTMF," this field is blank.
% break	Assigns the % break for pulse digits. This is the ratio between on and off hook signals during digit transmission.
CPC Detection	Assigns the expected minimum duration for detecting CPC (Calling Party Control) signal.
Start Arrangement	Assigns DID/TIE/E&M start type. When the trunk group of the line is set to " DID/TIE/E&M ", there are two methods of initiating a call. One is immediate start where the system outpulses the digits as soon as the trunk is seized and the other is where the system waits for a signal (wink start) from the far end before any digits are sent.
Wink Signal Time-Out	Assignable when Start Arrangement is set to "Send Delay Wink."

Conditions

Before setting this screen, "**Group-Trunk** Group" screen must be programmed. This screen cannot be selected from Trunk-submenu screen, if no CO trunk card is programmed in 'System-Configuration', Slot Assignment. If any one of the CO trunk cards is programmed, this screen can be selected.

When selecting "1. CO Line" in Trunk submenu screen, the setting screen which has the smallest Trunk Equipment No. appears on the screen first.

If the "Group-Trunk Group" containing the CO line has "Type" assigned to "DID," the following items cannot be entered : " — " is displayed :

- Direct Termination
- Night Answer Point (Type : No)
- Dial Mode
- DTMF Duration Time
- Pulse Speed
- % Break
- CPC Detection

If "the Group-Trunk Group" containing the CO line has "Type" assigned to anything other than "DID" or "TIE", the following items cannot be entered : " — " is displayed :

- Start Arrangement
- Wink Signal Time-Out

Direct Termination This is assignable only when the "Group-Trunk Group" containing the CO line has "Incoming Mode (Day)" assigned to "DIL 1:1," Otherwise, " — " is displayed and setting is impossible.

Night Answer Point (Type : No) This is assignable only when the "Group-Trunk Group" containing the CO line has "Incoming Mode (Night)" assigned to "FIXED" or "FLEXIBLE." Otherwise, " — " is displayed and setting is impossible.

When pressing the NEXT key, this screen appears in ascending order of Trunk Equipment number. After the largest number appears, the smallest one appears. Pressing the PREV key changes the screen in reverse order.

Function

The following functions appear on the function line of this setting screen.



COMMON (SHOW LV, CHG LV, INS, OUS, REMOVE, EXIT) and HRD CPY keys are available in all setting screens. INDEX and READ keys are also available in this screen. The operation of function keys are described in Section 7-1 "Operation of Function Keys." Only messages are provided here.

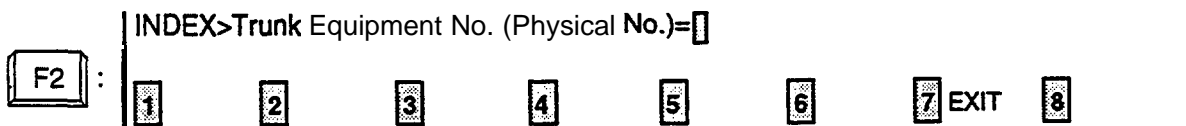

2.00 Pager and Music Source

Trunk		Pager & Music Source		I OFL I PRG I SCR I DIR	
		Tenant	Tone	BGM	
External Pager	1	1	Yes	Yes	
	2	1	Yes	No	
		Tenant	For Use		
Music Source	1	1	Hold&BGM		
	2	1	Hold&BGM		

COMMON HRD CPY

Summary

Assigns external pagers and music sources. This screen does not appear when all the assigning items of 'External Paging 1, 2' and 'External

Music Source 1, 2' are set to 'No' in the system-operation (1/3) screen. (Password level : Three or higher)

Assigning Items	Default	Selection of Value	Reference
External Pager 1/2 Tenant	1	1 : tenant 1 2 : tenant 2	3-D-2.04 4-D-4.00 4-H-1 .03 4-H-1 .04 4-H-2.00 5-B-2.00 5-F- 1.03 S-F-1.04 5-F-2.00 6-1-1 .03 6-1-1 .04 6-1-2.00

Continued

Description of Assigning Items

UCD No. (1 to 4)

UCD Time Table Assigns type of treatment for the calls arrived through UCD and placed in the Busy queue.

Conditions

To select this screen, press the NEXT key in the "System Attended-UCD (1/2)" screen.

Pressing the TAB key moves the cursor as follows:

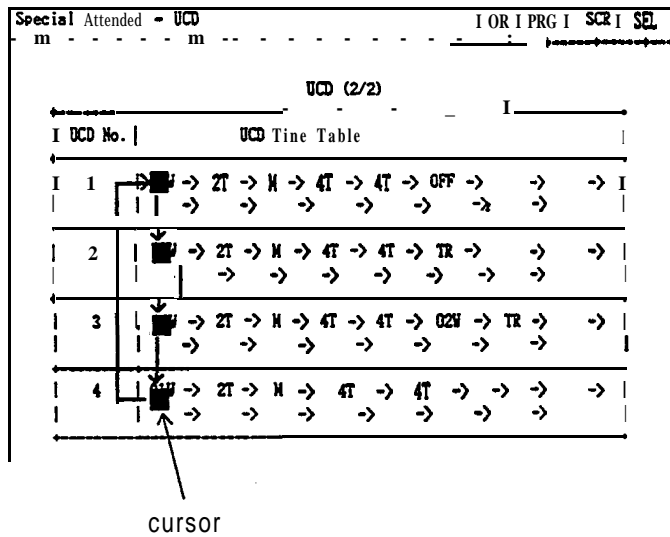

Function

The following functions appear on the function line of this setting screen.

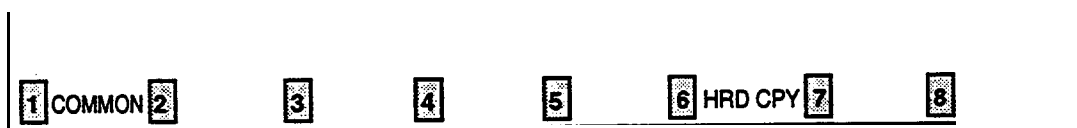

COMMON (SHOW LV, CHG LV, INS, OUS, REMOVE, EXIT) and HRD CPY keys are available in this setting screen. For operation, refer to Section 7-1 "Operation of Function Keys."

4.00 TIE Line Routing Table

Special Attended -TIE Lii Routing Table					OFL	PRG	SCR	DIR	
TLE Line Routing Table (1/3)									
					Trunk Group Hunt Sequence				
I	I	I	I	I					
No.	Code	Delete	Insert						
I	I	Digit	Dial	01	02	03	04	05	I
01	2XX	2	32	02	03				
02	31x	0		01	03				
03	950	3	3	01					
10419541	3		3	02	01				
05									
	06								
07									
08									
109									
10									
11									
12									

1 COMMON 2 3 4 5 6 ERDCPY 7 8

Summary

Assigns available trunk groups and parameters necessary (Password level : Two or higher) for making TIE calls. Three screens are provided.

Assigning Items	Default	Selection of Value	Reference
Code	blank	Up to three digits : 0 - 9, X (wild card)	3-F-1 4.00
Delete Digit	0	0 to 4 : number of deleting digit(s)	
Insert Dial	blank	Up to four digits : dialing number to be added	
Trunk Group Hunt Sequence	blank	01 to 16 : trunk group number	

Description of Assigning items

Up to 36 routing patterns can be programmed in this table.

This table is referenced by the system to identify the trunk route, when an extension user made a TIE call by dialing the feature number for "TIE Trunk Access" or 'Other PBX Extension number.

A routing pattern appropriate for each call is decided by the first three digits (except TIE trunk access code) of the dialed number.

The sequence is used by both tenants but the trunk group will be skipped if it does not belong to the same tenant as the caller.

Code	Assigns the leading one, two or three digits of the numbers for TIE calls. Used to determine which trunk group is used for a TIE call.
Delete Digit	Assigns the number of digits to be deleted from the beginning of the dialed digits.
Insert Dial	Assigns dialing number to be added to the beginning of the dialed digits.
Trunk Group Hunt Sequence (01 to 05)	Determines the trunk group hunt sequence to be used when placing a TIE call. The sequence is used by both tenants but trunk group will be skipped if it does not belong to the same tenant as the caller.

Conditions

By pressing the NEXT Key, TIE **Line** Routing Table screens change as follows.

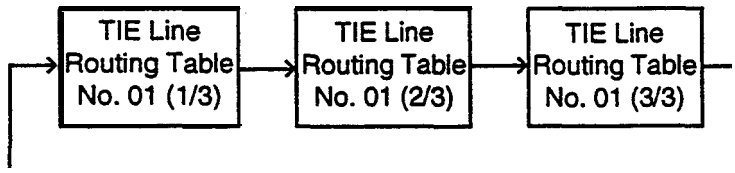

L. Miscellaneous Screen

1 .00 Installation Information

```

miscellaneous - Installation Information                I OFL I PRG I SCR I DIR
-----
-----
<< Customer & Installation Data >>
Customer Name          :
Location              :

Phone No.             :
Modem no.             :
Customer Contact      :
Date of Installation  :
Unit ID               :
Installers Name       :
Programmers Name      :
-----

Comments: Panasonic Hybrid PBX Install

COMMON
          HRD CPY
    
```

Summary

Assigns the customer's name, address, telephone number etc., of the installation point.
 (Password level : Two or higher)

Assigning Items	Default	Selection of Value	Reference
Customer Name	blank	Letters, numbers, marks within 32 digits	None
Location	blank	Letters, numbers, marks within 64 digits	
Phone No.	blank	Letters, numbers, marks within 16 digits	
Modem No.	blank	Letters, numbers, marks within 16 digits	
Customer Contact	blank	Letters, numbers, marks within 32 digits	
Date of Installation	blank	Letters, numbers, marks within 16 digits	
Unit ID	blank	Letters, numbers, marks within eight digits	

Continue

Error Message No.	Probable Cause	Countermeasure
141	Attempting to remove an extension or trunk port which is registered in Power Failure Transfer (PFT) assignment.	Cancel the PFT assignment of the corresponding card, and then delete the port.
150	Impossible to change the Numbering Plan to "Fixed," because there exist DN's which should be blank in the "Fixed" mode in the Hundred Block.	Clear DN's which should be blank.
160	Impossible to change KM/Paging group, for the pickup group belonging to the ICM/Paging group contains extensions.	Change after deleting all the extensions in the pickup group.

3.00 Other Error Messages

Error Message	Probable Cause	Countermeasure
Illegal parameter	Unacceptable value is assigned.	Assign an allowable value.
Parameter is not consecutive	Space exists between items.	Remove the space.
This parameter cannot assign	Assigned selection value is not for the item.	Set the assignable value.
Duplicate parameter definition internal	The number which is set previously in this screen is assigned again.	Set the number different from the previous number.
Duplicate parameter definition external	The number which is set previously in a different screen is assigned.	Set the number different from the previous number.
Not installed	Device is not installed	Assign the installed device.
Invalid status	Status of the specified device does not accept this command.	Change the status of the device to be acceptable for the command.
Diagnostic failure	Diagnostic error is checked when In-Service command is executed.	Execute test.
Insufficient privilege	Privilege level is lower than specified level.	increase the privilege level through the Change level function.
Failure	Port test is made during a card malfunction.	Repair the malfunctional card.
Service violation	Specified service is not executed.	Check specified service.
Already accessed by another device	Another maintenance device (remote, PITS, system) is in use.	Wait until another device is finished or let him finish.
Printer is not ready	Printer is not connected to the system or the power is off.	Connect the printer, and make the power on.
Cannot print out in remote	Print out is unavailable from Remote.	Execute print out on-site.
Waiting	Changing of program data is suspended because call placement is going on.	Wait for a while or cancel the setting by "CTRL+C"
Calendar IC trouble	Calendar IC malfunction.	Repair calendar IC.
Device error	Backup device is not connected (only when maintenance device is ATT).	Connect the backup device to SIO # 1 Port.
Version error	Different version at the time of backup.	Match the backup version.
Checksum error	A checksum error has been detected.	Communication line is defective, or backup data is destroyed.

Error Message	Probable Cause	Countermeasure
illegal code detected	Improper data is received.	Communication link is defective, or backup data is destroyed.
Off line	Execution is impossible during off-line.	Execute during on-line.
Status is already set	Impossible change such as [INS]→ [INS], [OUS]→ [OUS] is attempted.	Impossible.
Too many equipment assigned.	The number of equipment you attempt to assign is over the limit.	Assign the equipment within the limit of number .
Some extension are using that message	Attempting to change or delete the message which is in use by an extension user.	Change or delete the message after the extension cancels the setting .

Section 10

System Programming

Dumb Type Terminal

System Programming

Dumb Type Terminal

Contents

	Page
A Introduction	10-A-1
B Construction of Programming Mode	1 0-B-1
C Programming Commands.....	10-C-1
1.00 System Assignment (SYA)	10-C-1
2.00 Slot Assignment (SLA)	1 0-c-2
3.00 DN Assignment (DNA)	1 0-c-5
4.00 Operation (OPR)	1 0-C-6
5.00 Tenant (TNN)	1 0-c-1 1
6.00 System Timer (TIM)	10-c-14
7.00 Class of Service 1 (CS1)	1 0-c-1 5
8.00 Class of Service 2 (CS2)	10-c-17
9.00 Local Access Group (LAG)	10-c-19
10.00 Numbering Plan (NBP)	10-c-20
11.00 Communication Interface (COM)	1 0-c-25
12.00 Speed Dialing-System (SPD)	1 0-C-26
13.09 Absent Message (ABS)	10-C-27
14.09 Trunk Group 1 (TG1)	1 0-C-28
15.00 Trunk Group 2 (TG2)	1 0-c-31
16.00 ICM/Paging Group (IPG)	1 0-C-32
17.00 Call Pickup Group (CPG)	19-C-33
18.00 CO Line (COL)	10-c-34
19.06 Pager (PAG)	10-C-36
20.00 Music Source (MUS)	1 0-c-37
21.00 Automatic Gain Control (AGC)	1 0-C-38
22.00 Extension (EXT)	1 0-c-39
23.00 DSS Console (DSS)	10-c-42
24.00 DN Button Assignment (DNK)	10-c-43
25.00 PF Button Assignment (PFK)	10-C-46
26.00 DSS Button Assignment (DSK)	10-C-48
27.00 Doorphone (DPH)	1 0-c-50
28.09 Attendant Console (ATT)	1 0-c-51
29.00 Attendant Queue Priority (AQP)	1 0-c-53
30.00 Equal Access (EQU)	10-C-54
31.00 OCC Access (OCC)	1 0-C-56
32.00 Toll Restriction 1 (TR1)	10-C-58
33.06 Toll Restriction 2 (TR2)	10-c-59
34.00 Toll Restriction 3 (TR3)	10-c-60
35.00 Automatic Route Selection 1 (AR1)	10-c-61
36.00 Automatic Route Selection 2 (AR2)	10-C-62
37.06 Automatic Route Selection 3 (AR3)	10-c-63
38.00 Automatic Route Selection 4 (AR4)	10-C-64
39.00 Automatic Route Selection 5 (AR5)	10-C-65
40.00 DISA (DIS)	10-C-66

	Page
41.00 DISA Code (DIC)	1 0-C-67
42.00 DISA Password (DIP)	1 0-C-68
43.00 DID (DID)	1 0-C-69
44.00 UCD 1 (UC1)	1 0-c-70
45.00 UCD 2 (UC2)	1 0-c-71
46.00 Information (INF)	1 0-C-72
47.00 Power Failure Transfer (PFT)	1 0-c-73
48.00 Change Password (CHG)	1 0-c-74
49.00 CPC Signal Detect Timing-Outgoing CO Calls (CPC).....	10-C-75
50.00 Automatic Busy-Out Count (ABC)	10-C-76
51.00 World Select 1 (WS1)	1 0-c-77
(1) interdigit Pause.....	10-C-77
(2) Pulse Type.....	10-c-77
(3) Automatic Redial Retry Count	10-c-77
(4) Automatic Redial Retry Interval	10-c-77
(5) % Break Detect (SLT)	10-C-77
(6) Flash Detect (SLT)	10-c-77
(7) Flash Detect (TIE)	10-c-77
(8) Answer Decision Timer	10-C-77'
52.00 World Select 2 (WS2)	1 0-c-79
(1) First Dial Timer	10-c-79
(2) First Dial Timer (DID)	1 0-c-79
(3) EQU Access	1 0-c-79
(4) OCC Access	1 0-c-79
(5) Outgoing CO Back Tone.....	1 0-c-79
(6) L-COT Busy Out Looprelay	1 0-c-79
(7) G-COT Busy Out Looprelay	1 0-c-79
(8) Pay Tone Frequency.....	1 0-c-79
(9) Pay Tone Gain	1 0-c-79
53.00 World Select 3 (WS3)	10-C-81
(1) DIL 1:N CO Key Only (PITS only)	1 0-C-81
(2) EXT Off-hook BLF (PITS only)	1 0-C-81
(3) DTMF-Tone Integration.....	1 0-C-81
(4) SLT On-hook Operation Mode	1 0-C-82
(5) Mode Selection of Calls Arriving at ATT	1 0-C-82-l
(6) Centrex ARS.....	1 0-C-82-l
(7) Waiting for Second Dial Tone Mode	1 0-C-82-l
(8) Polarity Reversal Mode (Not available in your area)	10-C-82-1
(9) */# Allow Mode	1 0-C-82-l
(10) Message Waiting Lamp Off Control — Voice Mail	1 0-C-82-2
(11) μ law • A law (E-I only) (Not available in your area).	10-C-82-2
(12) SLT Transfer Operation	1 0-C-82-2
(13) Ringback Tone While Transfer	1 0-C-82-2
54.00 Voice Mail Directory number (VMD)	1 0-C-83
55.00 Mailbox Number (MBN)	1 0-C-86

	Page
56.00 Account Code Verified	1 o-c-90
(1) Programming the System Account Code -Speed Dialing Boundary (SPB)	1 0-c-90
(2) Assigning Account Code Verified (ACV) Feature to the Extension	1 o-c-91
57.00 Account Code Entry on Long Distance Calls (ACL)	10-C-93
58.00 CO Access Instantly (CAI)	1 o-c-95
59.00 Night Answer Group (NAG)	1 0-c-97
60.00 Polarity Reversal Detection (PRD)	10-c-100
61 .OO Waiting for Second Dial tone (WSD)	10-c-103
62.00 World Select 4(Ws4)	1 0-c-1 05
(1) Dial Tone Frequency Selection	10-C-1 05
(2) Paging Beep Tone Control	10-c-105
(3) TAFAS Confirmation Tone Control	10-C-105
(4) Paging Confirmation Tone Control	10-c-105
(5) Call Park Confirmation Tone Control	10-c-105
(6) Call Pickup Confirmation Tone Control	10-c-105
63.00 Equal Access Code (EQC)	1 0-C-1 07
64.00 T-I Related Commands	10-C-109
64.01 Channel Assignment (CHA) -T-I	1 0-c-1 09
64.02 System Clock Mode (CLK) — T-I	10-c-111
64.03 Master Clock Priority (CLP) — T-I	10-c-112
64.04 ESF Frame Option(EFO) — T-I	10-c-113
65.00 TIE Line Related Commands	10-c-120
65.01 TIE Line Routing Table (TIE)	10-c-120
65.02 TIE Account Code (TAC)	10-c-121
65.03 TIE Trunk Relay Restriction (TRR)	10-c-122
65.04 Line Hunting Sequence (LHS)	10-C-123
67.00 DISA/AGC Tone Detection Mode (TDM)	10-c-130
68.00 Call Forwarding-Follow Me (CFM)	10-c-131
69.60 Limited Call Duration (LCD)	10-c-132
 D Error Message Tables	 10-D-1
1 .00 Error Messages Related to the Assigning Items in the Same Command	10-D-1
2.00 Error Messages Related to the Assigning Items in the Other Commands	10-D-2
3.00 Fixed Error Messages	10-D-6
4.00 Other Error Messages	10-D-8

A. Introduction

This section provides system programming using Dumb type terminal. Before starting system programming, Section 8 "Preparation for Programming and Maintenance (Dumb Type Terminal)" must be read. This section describes the basic operations for programming.

Programming mode consists of a variety of commands, which enable users to assign or change various parameters concerning the system administration such as Tenant, Class of Service, Numbering Plan and so on. A list of all programming commands is provided on the following page.

B. Construction of Programming Mode

		Password Level	
PRG (Programming)	SYA (System Assignment)	1	First Set
	SLA (Slot Assignment)	1	
	DNA (DN Assignment)	1	
	CHA (Channel Assignment)	1	
	OPR (Operation)	2	
	TNN (Tenant)	2	Second Set
	TIM (System Timer)	2	
	CS1 (Class of Service 1)	2	
	CS2 (Class of Service 2)	2	
	LAG (Local Access Group)	2	
	NBP (Numbering Plan)	2	
	COM (Communication Interface)	2	
	SPD (Speed Dialing System)	3	
	ABS (Absent Message)	3	
	TG1 (Trunk Group 1)	2	
	TG2 (Trunk Group 2)	2	
	IPG (ICM/Paging Group)	2	
	CPG (Call Pickup Group)	2	
	COL (CO Line)	3	
	PAG (External Paging)	3	
	MUS (Music Source)	3	
	AGC (Automatic Gain Control)	3	
	EXT (Extension)	3	
	DSS (DSS Console)	3	Third Set
	DNK (DN Button Assignment)	3	
	PFK (PF Button Assignment)	3	
	DSK (DSS Button Assignment)	3	
	DPH (Doorphone)	3	
	ATT (Attendant Console)	2	
	AQP (Attendant Queue Priority)	2	
	EQU (Equal Access)	2	
	OCC (OCC Access)	2	
	TR1 (TRS Area/Office Code Tables)	2	
	TR2 (TRS Office Code Tables)	2	
	TR3 (TRS 7/10 or 7-Digit Table)	2	
	AR1 (ARS Leading Digit Table)	2	
	AR2 (ARS Office Code Tables)	2	
	AR3 (ARS Route Plan Tables)	2	
	AR4 (ARS Route Lists Tables)	2	
	AR5 (ARS Modified Digit Tables)	2	
DIS (Direct Inward System Access)	2		
DIC (DISA Code)	2		
DIP (DISA Password)	2		
DID (Direct Inward Dialing)	2		
UC1 (UCD 1/2)	2		
UC2 (UCD 2/2)	2		
TIE (TIE Line Routing Table)	2		
INF (Installation Information)	2		
PFT (Power Failure Transfer)	2		
CHG (Change Password)	1		
CPC (CPC Detect Timing-Outgoing)	3		
WS1 (World Select 1)	3		
WS2 (World Select 2)	2		
ABC (Automatic Busy-out Count)	2		

Continued

Continued

WS3 (World Select 3)	2
CAI (CO Access Instantly)	2
ACV (Account Code Verified)	2
ACL (Account Code Entry on Long Distance Calls)	2
SPB (Speed Dialing Boundary)	2
NAG (Night Answer Group)	2
PRD (Polarity Reversal Detection)	2
VMD (Voice Mail DN)	2
MBN (Mail Box Number)	2
WSD (Waiting for Second Dial Tone)	2
EQC (Equal Access Code)	2
WS4 (World Select 4)	2
TAC (TIE Account Code)	2
CLK (Clock Mode)	2
CLP (Clock Priority)	2
TRR (TIE Trunk Relay Restriction)	2
TDM (Tone Detection Mode (DISA/AGC))	2
LHS (Line Hunting Sequence)	2
EFO (ESF Frame-Option)	2
LCD (Limited Call Duration)	2
CFM (Call Forwarding-Follow Me)	2

These programs must be done in order from "First **Set**" "Second **Set**" to "Third Set" shown in the table. For example, if you program Operation (OPE) before doing System Assignment (SYA) program, an error message appears.

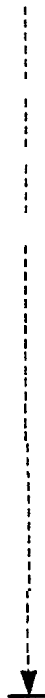

C. Programming Commands

1.00 System Assignment (SYA)

Description

This command is used to configure the system for:

- Expansion Shelf (1, or both 1 and 2)
- T-SW Conference Expansion Card

To expand the conference trunks, T-SW Conference Expansion Card (KX-T336104) must be installed.

(Password level : One)

Input Format

S **Y** **A** **Mode** (**Item Number**) **CR**←**J**

Input Value for Item Number

Item Number	Assigning Items	Input Value
1	Expansion Shelf	N : expansion shelf not installed 1: expansion shelf 1 available 2: both expansion shelves 1 and 2 available
2	TSW Additional CONF	Y : conference expansion card installed N: conference expansion card not installed

conditions

None

2.00 Slot Assignment (SLA)

Description

To assign the type of card equipped in each free slot on the basic and expansion shelves.
(Password level : One)

Input Format

S **L** **A** Mode (**Index Number**) **CR**←**J**

☛ In the AT mode, to display or edit in the conversation style, do not enter the index number :

<Example>

When you enter; **PRG>SLA AT** (←**J**), the display starts from the slot number 101 and moves one by **one**.

Index Number

Index Number	Explanation
XXX └── slot (01 to 15) └── shelf (1 to 3)	Physical number (101 to 315)

Input Value for Item Number

Item Number	Assigning Items	Input Value
1	Card Type	XX (00 to 18) (Version 12.XX) 00: none 01 : PLC (Proprietary integrated Telephone System Line Circuit card 02 : HLC (Hybrid Line Circuit) card 03 : SLC (Single Line Telephone Circuit) card 04 : MSLC(SLC with Message Waiting) card 06 : LCOT (Loop Start Central Office Trunk) card 07 : GCOT (Ground Start Central Office Trunk) card 08 : DID (Direct Inward Dialing) card 10 : T-1 (T1 DIGITAL TRUNK CARD) 12 : AGC (Automatic Gain Control) card 13 : DISA (Direct Inward System Access) card 14 : OPX (Off Premise <i>Extension</i>) card

Continued

Item Number	Assigning Items	Input Value
		15 : ATLC (Attendant Console Line Circuit) card 16 : DPH (Doorphone Circuit) card 17 : RMT (Remote Circuit) card 18 : OHCA (Off-Hook Call Announcement) card

Conditions

If **"SLA"** command is entered without index number, all physical slot numbers (except 113 and 115) will be displayed in ascending order (from 101 to 315).

It is impossible to select Index No.1 13 and 115, because Index No.1 13 is fixed to CPU card and 115 is fixed to T-SW card.

If Index No.1 14 is selected, assignable input value is limited to '00: none' or '18: OHCA.'

T-I card should be assigned to **FS01 , 05** or 09 of any shelf.

- One T-I card occupies three slots. If you assign a T-I card to **FS01** , FS02 and FS03 are not available for other cards. **"* * *"** is displayed in these two slots and the cursor skips them.

If no CO trunk card is assigned, it is not possible to program 'CO Line **(COL)."**

If AGC card is not assigned, **"Automatic Gain Control (AGC)"** cannot be programmed.

If DPH card is not assigned, **"Doorphone (DPH)"** cannot be programmed.

If ATLC card is not assigned, it is not possible to program 'Attendant Console (ATT)' and "Attendant Queue Priority (AQP)."

If **DISA** card is not assigned, it is not possible to program **"DISA (DIS)", "DISA Code (DIC)** and **"DISA Password (DIP)."**

If DID card is not assigned, it is not possible to program 'DID (DID)."

When assigning a card, the card status **is** Out of Service (OUS). When using the card, the card status should be set to In Service (INS).

For 'In Service (INS)' and "Out of Service **(OUS)"**, refer to Section 8-F-3.00 'In Service (INS)' and Section 8-F-4.00 "Out of Service **(OUS)."**

For confirming whether card status is INS or OUS, refer to Section 15-F-1.02 'Card Status Screen.'

When deleting or changing the pre-assigned card type, the conditions should be the followings:

- The card status is OUS or Fault.
- All of the port data has been deleted.

However, if there exist port data, it is possible to change the cards as follows:

- PLC card ↔ HLC card
- SLC card ↔ HLC card

Deleting the ATLC card will be an error if there exist the following assignments:

- "Trunk Group **(TG1)**",
incoming Mode (Day) is set to "1 (ATT)."
Intercept Routing (Day) is set to "**A** (ATT)."
- "Doorphone (DPH)",
Doorphone Assignment is set to "**A(ATT)**."

Deleting the **DISA** card will be an error if there exist the following assignments:

- "Trunk Group **(TG1)**",
Incoming Mode (Day) is set to "4 **(DISA)**."
Incoming Mode (Night) is set to "**4** (DISA)."

Deleting the HLC, SLC, LCOT or GCOT card will be an error if there is the following assignment to the slot to be deleted:

- "Power failure Transfer **(PFT)**

See Section I-A-5.00 "Service Cards Description" for installing the cards in combination.

3.00 DN Assignment (DNA)

Description

To assign a DN (directory number) to each port.
 (Password level : One)

Input Format



Index Number

index Number	Explanation
<p>X XX slot (01 to 15) shelf (1 to 3)</p>	Physical number (101 to 315)

Input Value for Item Number

Item Number	Assigning Items	Input Value
1	Port 1	Three or four numeric digits: directory number
2	Port 2	
3	Port 3	
4	Port 4	
5	Port 5	
6	Port 6	
7	Port 7	
a	Port a	

Conditions

None

When selecting "1. CO Line" in Trunk submenu screen, the setting screen the smallest Trunk Equipment No. appears on the screen first.

If the "Group-Trunk Group" containing the CO line has "Type" assigned to the following items cannot be entered : " —" is displayed :

- Direct Termination
- Night Answer Point (Type : No)
- Dial Mode
- DTMF Duration Time
- Pulse Speed
- % Break
- CPC Detection

If "the Group-Trunk Group" containing the CO line has "Type" assigned to other than "DID" or "TIE", the following items cannot be entered : " —" is

- Start Arrangement
- Wink Signal Time-Out

Direct Termination This is assignable only when the "Group line has 'Incoming Mode (Day)" assigned displayed and setting is impossible.

Night Answer Point (Type : No) This is assignable only when the "Group line has 'Incoming Mode (Night)" assigned. Otherwise, " --" is displayed and setting

When pressing the NEXT key, this screen appears in ascending order of Equipment number. After the largest number appears, the smallest one. Pressing the PREV key changes the screen in reverse order.

Function

The following functions appear on the function line of this setting screen.



COMMON (SHOW LV, CHG LV, INS, OUS, REMOVE, EXIT) and HRD (are available in all setting screens. INDEX and READ keys are also available in all setting screens. The operation of function keys are described in Section 7-1 "Operation of Function Keys." Only messages are provided here.

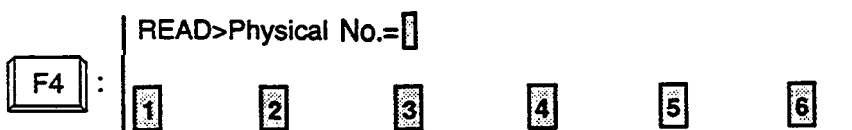
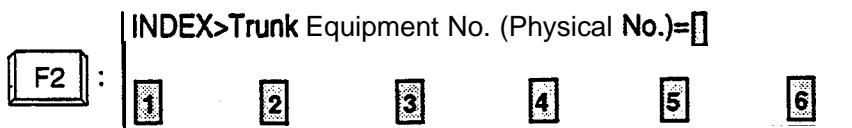

Continued

Item Number	Assigning Items	Input Value
07	Home Dialing Plan	A : Type-A : 1+NXX+NXX+XXXX NXX+XXXX B : Type-B : NPX+NXX+XXXX NNX+XXXX C : Type-C : 1 +NPX+NXX+XXXX 1+NNX+XXXX NXX+XXXX D : Type-D : 1 +NXX+NXX+XXXX NXX+NXX+XXXX NXX+XXXX (N: 2 to 9, P: 0,1, X: 0 to 9)
08	DSS Operation Mode	1 : disconnect and call 2 : hold and transfer
09	Busy Tone	1 : busy tone 1 2 : busy tone 2
10	Held Call Reminder	Y : Held Call Reminder is enabled N : Held Call Reminder is disabled
11	Beep Tone for Bsy-ovr / Brg-in	Y : overriding with beep tone N : overriding without beep tone
12	External Paging 1	Y: using external pager 1 N : not using external pager 1
13	External Paging 2	Y : using external pager 2 N : not using external pager 2
14	External Music Source 1	Y : using external music source 1 N : not using external music source 1
15	External Music Source 2	Y : using external music source 2 N : not using external music source 2
16	Idle Line Preference	1 : off-hook selects an idle DN button 2 : off-hook selects an idle CO button
17	FDN for General Operator Call 1	0 : no FDN DN XXXX (XXXX: three or four numeric digits): FDN for general operator call 1
18	FDN for General Operator Call 2	0 : no FDN DN XXXX (XXXX: three or four numeric digits): FDN for general operator call 2
19	PBX Code	0 : no PBX code Up to three numeric digits can be entered.

Description of Assigning Items

UCD No. (1 to 4)

UCD Time Table Assigns type of treatment for the calls arrived through UCD and placed in the Busy queue.

Conditions

To select this screen, press the NEXT key in the "System Attended-UCD (1/2)" screen.

Pressing the TAB key moves the cursor as follows:

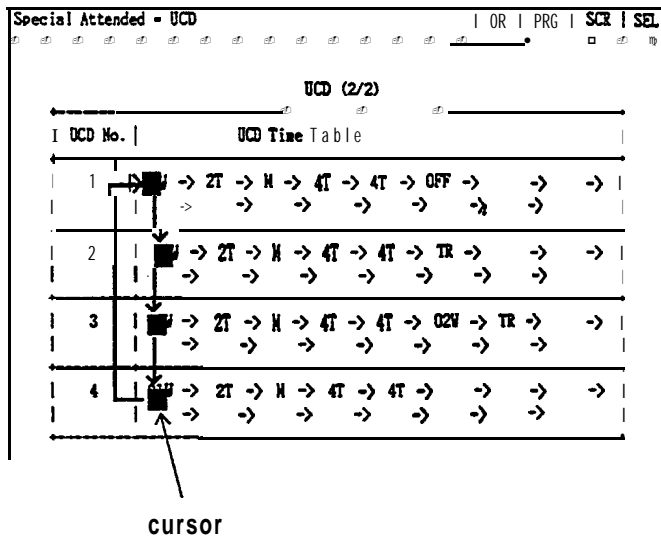

Function

The following functions appear on the function line of this setting screen.



COMMON (SHOW LV, CHG LV, INS, OUS, REMOVE, EXIT) and HRD CPY keys are available in this setting screen. For operation, refer to Section 7-I "Operation of Function Keys."

7.00 Class of Service 1 (CS1)

Description

This is the first Class of Service block which is used to assign toll restriction level, maximum dialing digits, Call Forwarding, Do Not Disturb, Do Not Disturb Override and so on.
(Password level: Two or higher)

Input Format

C S 1 **Mode** **Index Number** (**Item Number**) **CR←J**

Index Number

Index Number	Explanation
01 to 32	Class of Service number

input Value for Item Number

Item Number	Assigning Items.	Input Value
01	Toll Restriction Level (Day)	01 to 16
02	Toll Restriction Level (Night)	01 to 16
03	Max. Dialing Digits	002 to 255 : maximum number of dialed digits [input value -1 000 : no limit to digits dialed 001 : cannot dial
04	Call Forwarding/Do Not Disturb	Y : Call Forwarding/Do Not Disturb is available N : Call Forwarding/Do Not Disturb is unavailable
05	Do Not Disturb Override	Y : Do Not Disturb Override is available N : Do Not Disturb Override is unavailable
06	CO Forward Mode	Y : Call Forwarding to CO is available N : Call Forwarding to CO is unavailable
07	CO Transfer Mode	Y : Call Transfer to CO is available N : Call Transfer to CO is unavailable
08	Forced Account Code Mode	Y : account codes are required for outgoing CO calls N : account codes are optional for outgoing CO calls
09	BSS/OHCA	Y : Override is available N : Override is unavailable

Continued

Description of Assigning items

Up to 36 routing patterns can be programmed in this table.

This table is referenced by the system to identify the trunk route, when an extension user made a TIE call by dialing the feature number for "TIE Trunk Access" or "Other PBX Extension number".

A routing pattern appropriate for each call is decided by the first three digits (except TIE trunk access code) of the dialed number.

The sequence is used by both tenants but the trunk group will be skipped if it does not belong to the same tenant as the caller.

Code	Assigns the leading one, two or three digits of the numbers for TIE calls. Used to determine which trunk group is used for a TIE call.
Delete Digit	Assigns the number of digits to be deleted from the beginning of the dialed digits.
Insert Dial	Assigns dialing number to be added to the beginning of the dialed digits.
Trunk Group Hunt Sequence (01 to 05)	Determines the trunk group hunt sequence to be used when placing a TIE call. The sequence is used by both tenants but trunk group will be skipped if it does not belong to the same tenant as the caller.

Conditions

By pressing the NEXT Key, TIE **Line** Routing Table screens change as follows.

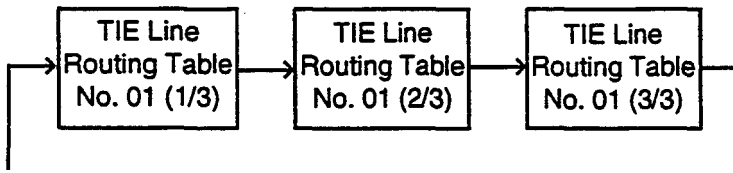

Continued

Item Number	Assigning Items	Input Value	CLR
076	Walking COS Set	Maximum four digits consisting of numbers, *, #	<input type="radio"/>
077	Walking COS Cancel		<input type="radio"/>
078	Walking Station Set		<input type="radio"/>
079	Walking Station Cancel		<input type="radio"/>
080	Message Set		<input type="radio"/>
081	Message Cancel		<input type="radio"/>
082	Station Program Clear		<input type="radio"/>
083	Message Waiting Reply		<input type="radio"/>
084	TIE Trunk Access		<input type="radio"/>
085	Night Mode Set		<input type="radio"/>
086	Night Mode Cancel		<input type="radio"/>
087	Night Service Manual Mode Set		<input type="radio"/>
088	Night Service Manual Mode Cancel		<input type="radio"/>
089	Flexible Night Service		<input type="radio"/>
090	Remote Station Lock Set		<input type="radio"/>
091	Remote Station Lock Cancel		<input type="radio"/>
092	Remote DND Set		<input type="radio"/>
093	Remote DND Cancel		<input type="radio"/>
094	Remote FWD Cancel		<input type="radio"/>
095	Remote FWD Cancel-One Time		<input type="radio"/>
096	BGM Through External Pager		<input type="radio"/>
097	Busy Out Trunk		<input type="radio"/>
098	Unbusy Trunk		<input type="radio"/>
099	OGM Record		<input type="radio"/>
100	OGM Playback		<input type="radio"/>
101	UCD Log In		<input type="radio"/>
102	UCD Log Out		<input type="radio"/>
103	Remote Timed Reminder Confirm		<input type="radio"/>
104	Remote Timed Reminder Set	<input type="radio"/>	
105	Remote Timed Reminder Cancel	<input type="radio"/>	

: clearing function is effective for the item

Error Message No.	Probable Cause	Countermeasure
141	Attempting to remove an extension or trunk port which is registered in Power Failure Transfer (PFT) assignment.	Cancel the PFT assignment of the corresponding card, and then delete the port.
150	Impossible to change the Numbering Plan to "Fixed," because there exist DN's which should be blank in the "Fixed" mode in the Hundred Block.	Clear DN's which should be blank.
160	Impossible to change ICM/Paging group, for the pickup group belonging to the ICM/Paging group contains extensions.	Change after deleting all the extensions in the pickup group.

Error Message	Probable Cause	Countermeasure
Illegal code detected	improper data is received.	Communication link is defective, or backup data is destroyed.
Off line	Execution is impossible during off-line.	Execute during on-line.
Status is already set	Impossible change such as [INS]→ [INS]. [OUS]→ [OUS] is attempted.	Impossible.
Too many equipment assigned.	The number of equipment you attempt to assign is over the limit.	Assign the equipment within the limit of number.
Some extension are using that message	Attempting to change or delete the message which is in use by an extension user.	Change or delete the message after the extension cancels the setting.

11 .OO Communication Interface (COM)

Description

To set parameters for the RS-232C and Modem (Modulator and Demodulator) ports.
(Password level: Two or higher)

Input Format

() ()

Index Number

Index Number	Explanation
1	SIO # 1 (terminal)
2	SIO # 2 (SMDR)
3	Remote

Input Value for Item Number

Item Number	Assigning Items	Input Value
1	NL-code	1: CR + LF 2: CR
2	Baud Rate	11 O/I 50/300/600/I 200/2400/4800/9600 : for SIO 300/1200 : for Remote
3	Word Length	6 : 6 bits (for Remote only) 7: 7 bii 8: 8 bits
4	Parity	1 : none 2 : mark (for SIO only) 3 : space (for SIO only) 4: even 5: odd
5	Stop Bit	1 : 1 bit 2 : 1.5 bits (for Remote only) 3 : 2 bits

Conditions

It is possible to change assigning **items in 'Communication Interface (COM)'** while on-site administration or remote administration is performed or SMDR is being printed out. New setting becomes effective **when** those operation modes are finished.

Section IO

System Programming

Dumb Type Terminal

	Page
41 .00 DISA Code (DIC)	1 O-C-67
42.00 DISA Password (DIP)	1 O-C-68
43.00 DID (DID)	1 O-C-69
44.00 UCD 1 (UC1)	10-C-70
45.00 UCD 2 (UC2)	10-C-71
46.00 Information (INF)	1 O-C-72
47.00 Power Failure Transfer (PFT)	1 o-c-73
48.00 Change Password (CHG)	10-c-74
49.00 CPC Signal Detect Timing-Outgoing CO Calls (CPC)	1 o-c-75
50.00 Automatic Busy-Out Count (ABC)	1 O-C-76
51.00 World Select 1 (WS1)	1 o-c-77
(1) Interdigit Pause	10-c-77
(2) Pulse Type..	10-c-77
(3) Automatic Redial Retry Count..	10-c-77
(4) Automatic Redial Retry Interval..	10-C-77
(5) % Break Detect (SLT)..	10-C-77
(6) Flash Detect (SLT)	10-c-77
(7) Flash Detect (TIE)	10-c-77
(8) Answer Decision Timer..	10-C-77'
52.00 World Select 2 (WS2)	1 o-c-79
(1) First Dial Timer	10-c-79
(2) First Dial Timer (DID).	10-C-79
(3) EQU Access	10-C-79
(4) OCC Access	1 O-c-79
(5) Outgoing CO Back Tone	1 O-c-79
(6) L-COT Busy Out Looprelay	1 O-c-79
(7) G-COT Busy Out Looprelay	10-c-79
(8) Pay Tone Frequency..	10-C-79
(9) Pay Tone Gain	10-C-79
53.00 World Select 3 (WS3)	10-C-81
(1) DIL 1:N CO Key Only (PITS only)	1 O-C-81
(2) EXT Off-hook BLF (PITS only)	10-C-81
(3) DTMF-Tone Integration	10-C-81
(4) SLT On-hook Operation Mode..	10-C-82
(5) Mode Selection of Calls Arriving at ATT..	10-C-82-1
(6) Centrex ARS	1 O-C-82-1
(7) Waiting for Second Dial Tone Mode	10-C-82-1
(8) Polarity Reversal Mode (Not available in your area)	10-C-82-1
(9) */# Allow Mode	10-C-82-1
(10) Message Waiting Lamp Off Control — Voice Mail..	1 O-C-82-2
(11) μ law • A law (E-I only) (Not available in your area).	10-C-82-2
(12) SLT Transfer Operation	10-C-82-2
(13) Ringback Tone While Transfer	1 O-C-82-2
54.00 Voice Mail Directory number (VMD)	1 O-C-83
55.00 Mailbox Number (MBN)	1 O-C-86

15.00 Trunk Group 2 (TG2)

Description

This is the second block to assign various data for trunk groups.
(Password level: Two or higher)

Input Format

T	G	2	Mode	Index Number	(Item Number)	CR←J
---	---	---	------	--------------	---	-------------	---	------

index Number

index Number	Explanation
01 to 16	Trunk group number

Input Value for Item Number

Item Number	Assigning Items	Input Value	CLR
01 to 08	Destination (DIL 1: N Only)	I X (X : 1 to 8): ICM group number P XX (XX : 01 to 32) : pickup group number DN XXXX (XXXX : three or four digits): extension number 0: none (Assignable only when "Incoming Mode (Day)" is set to DIL 1: N)	
09	DID Digit Modification Table	1 to 4 : table number (Assignable when the Trunk Group type is DID)	
10 to 17	PBX Access Code (No Restriction)	Maximum three digit numbers (Assignable when the Trunk Group type is PBX, and CO line access is both way)	0
18 to 25	PBX Access Code (Restriction)	Maximum three digits of numbers (Assignable when the Trunk Group type is PBX, and CO line access is both way)	0
26	Max. Dial No. after EFA Signal	01 to 32: maximum dialing digits 00: cannot dial after external feature access	
27	CO-TIE Restriction	Y : CO-TIE connection is restricted N : CO-TIE connection is allowed	
28	TIE-CO Restriction	Y : TIE-CO connection is restricted N : TIE-CO connection is allowed	

A. Introduction

This section provides system programming using Dumb type terminal. Before starting system programming, Section 8 "Preparation for Programming and Maintenance (Dumb Type Terminal)" must be read. This section describes the basic operations for programming.

Programming mode consists of a variety of commands, which enable users to assign or change various parameters concerning the system administration such as Tenant, Class of Service, Numbering Plan and so on. A list of all programming commands is provided on the following page.

Continued

WS3 (World Select 3)	2
CAI (CO Access Instantly)	2
ACV (Account Code Verified)	2
ACL (Account Code Entry on Long Distance Calls)	2
SPB (Speed Dialing Boundary)	2
NAG (Night Answer Group)	2
PRD (Polarity Reversal Detection)	2
VMD (Voice Mail DN)	2
MBN (Mail Box Number)	2
WSD (Waiting for Second Dial Tone)	2
EQC (Equal Access Code)	2
WS4 (World Select 4)	2
TAC (TIE Account Code)	2
CLK (Clock Mode)	2
CLP (Clock Priority)	2
TRR (TIE Trunk Relay Restriction)	2
TDM (Tone Detection Mode (DISA/AGC))	2
LHS (Line Hunting Sequence)	2
EFO (ESF Frame Option)	2
LCD (Limited Call Duration)	2
CFM (Call Forwarding-Follow Me)	2

These programs must be done in order from "First **Set**" "Second **Set**" to "Third **Set**" shown in the table. For example, if you program Operation (OPE) before doing System Assignment (SYA) program, an error message appears.

Item Number	Assigning Items	Input Value
08	% Break	1 : 60% break 2 : 67% break (Not assignable when the dial type is DTMF)
09	CPC Detection	00: none 01 : 6.5 ms detection 02 to 75 : 8N ms detection (Not assignable when the Trunk Group type is DID or TIE)
10	Start Arrangement	1 : immediate start 2 : delayed wink start (Assignable when the Trunk Group type is DID or TIE)
11	Wink Signal Time-Out	1 : 64ms 2 : 128ms ⋮ 127 : 8.128 s

Conditions

Before setting this screen, "Trunk Group **(TG1) (TG2)**" must be programmed.

This cannot be programmed if no CO trunk card is assigned in

"Slot Assignment (SLA)." If any one of the cards is programmed, this screen **can** be programmed.

If the "Trunk Group **(TG1)**" containing the CO line has "Type" assigned to '6 (DID),' or '7 **(TIE)**' the following items cannot be entered : " . ** " is displayed:-

- Direct Termination
- Night Answer Point (Type : No)
- CPC Detection

If the "Trunk Group **(TG1)**" containing the CO line has "Type" assigned to anything other than '6 (DID),' or '7 (TIE)', the following items cannot be entered : " . ** " is displayed :

- Start Arrangement
- Wink Signal Time-Out

Item
Number

03	Direct Termination	This is assignable only when the "Trunk Group (TG1) " containing the CO line has 'Incoming Mode (Day)' assigned to "2 (DIL 1:1)." Otherwise, " *** " is displayed and setting is impossible.
04	Night Answer Point (Type : No.)	This is assignable only when the "Trunk Group (TG1) " containing the CO line has 'Incoming Mode (Night) ' assigned to "2 (Fixed)" or 3 (Flexible)." Otherwise, " *** " is displayed and setting is impossible. "N (NAG) " can be selected only when Trunk Group 'Incoming Mode (Night)' is assigned to "2 (Fixed)."
05	Dial Type	If "Pulse mode" is selected, refer to Section 10-C-51 .00 "World Select 1 (WS1) " about the following items: <ul style="list-style-type: none"> • Interdigit Pause • Pulse Type • % Break Detect

2.00 Slot Assignment (SLA)

Description

To assign the type of card equipped in each free slot on the basic and expansion shelves.
(Password level : One)

Input Format

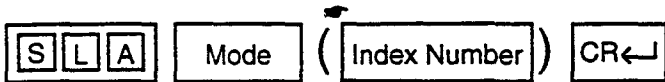

In the AT mode, to display or edit in the conversation style, do not enter the index number :

<Example>

When you enter; **PRG>SLA AT** (←), the display starts from the slot number 101 and moves one by one.

Index Number

index Number	Explanation
XXX └── slot (01 to 15) └── shelf (1 to 3)	Physical number (101 to 315)

Input Value for Item Number

Item Number	Assigning Items	Input Value
1	Card Type	XX (00 to 18) (Version 12.XX) 00: none 01 : PLC (Proprietary Integrated Telephone System Line Circuit card) 02 : HLC (Hybrid Line Circuit) card 03 : SLC (Single Line Telephone Circuit) card 04 : MSLC(SLC with Message Waiting) card 06 : LCOT (Loop Start Central Office Trunk) card 07 : GCOT (Ground Start Central Office Trunk) card 08 : DID (Direct inward Dialing) card 10 : T-I (T1 DIGITAL TRUNK CARD) 12 : AGC (Automatic Gain Control) card 13 : DISA (Direct Inward System Access) card 14 : OPX (Off Premise Extension) card

Continued

51.00 World Select 1 (WS1)

Description

“WS1” command provides the following assignments.
(Password level: Two or higher)

(1) Interdigit Pause (For Dial Pulse Trunk)

Interdigit Pause is used to distinguish between pulse signals. To meet the requirements of your central office, select the appropriate value that represents the delay between dial pulses. This setting is only required when using dial pulse trunks.

(2) Pulse Type (For Dial Pulse Trunk)

The system supports the following three types of dial pulse signaling. Select the appropriate option to your area. This setting is only required when using dial pulse trunks.

(3) Automatic Redial Retry Count

Used to set the number of times Automatic Redial is tried. Automatic redialing of the last dialed number is done up to the specified number of times.

(4) Automatic Redial Retry Interval

Used to set the interval time between Automatic Redial **attempts. Refer** to Section 4-C-4.04 “Automatic Redial” for further information.

(5) % Break Detect (SLT)

Dialed digits from dial pulse type Single Line Telephone (SLT) is transmitted to the system by making and breaking a loop current (dc path), thereby interrupting loop Current-Duration time required to detect the number of breaks depends on the SLT connected and can be administered to “16 to 96 ms” or “16 to 136 ms” by this command.

(6) Flash Detect (SLT)

It is assignable that the Flash signal transmitted from SLT is detected or not by the system. If “0=No” is selected, the system does not detect the Flash signal transmitted from SLT.

(7) Flash Detect (TIE)

Assigns the length of the flash time which applies to calls on TIE trunks.
This is the time the system needs to detect the flash signal sent from the other **PBX of a TIE Line Network**. Duration time required is determined by the other **PBXs**.

(8) Answer Decision Timer

This entry applies to calls on TIE trunks.
This is the time the system needs to recognize the off-hook signal sent from the other **PBX before** connecting the voice path.
The entry is entered in 32 ms increments.

Input Format

W	S	1
---	---	---

 Mode (SH/AT/BT) (

Item Number (1-8)

) CR ←

Index Number

None

When deleting or changing the pre-assigned card type, the conditions should be the followings:

- The card status is OUS or Fault.
- All of the port data has been deleted.

However, if there exist port data, it is possible to change the cards as follows:

- PLC card \longleftrightarrow HLC card
- SLC card \longleftrightarrow HLC card

Deleting the ATLC card will be an error if there exist the following assignments:

- "Trunk Group **(TG1)**",
Incoming Mode (Day) is set to **"1 (ATT)."**
Intercept Routing (Day) is set to **"A (ATT)."**
- "Doorphone (DPH)",
Doorphone Assignment is set to **"A(ATT)."**

Deleting the **DISA** card will be an error if there exist the following assignments:

- "Trunk Group **(TG1)**",
Incoming Mode (Day) is set to **"4 (DISA)."**
Incoming Mode (Night) is set to **"4 (DISA)."**

Deleting the HLC, SLC, LCOT or GCOT card will be an error if there is the following assignment to the slot to be deleted:

- "Power Failure Transfer **(PFT)**"

See Section 1 -A-5.00 "Service Cards Description" for installing the cards in combination.

52.00 World Select 2 (WS2)

Description

“WS2” command provides the following assignments.
(Password level: Two or higher)

(1) **First Dial Timer**

On outgoing CO calls, the system waits at least 0.5 seconds after seizing the CO line, before sending the dialing digits required by the central office. This allows the central office enough time to accept the dialing digits correctly. Default setting is 1.0 second and can be ranged from 0.5 to 8.0 seconds.

(2) **First Dial Timer (DID)**

Available when “Type” of a Trunk Group is set to “DID” or “TIE”.

(3) **EQU Access**

Used to activate or deactivate the EQU Access feature on a system-wide basis. If “N” is selected by this command, programming screen of “Special Carrier Access” Equal Access is not accessible.

(4) **OCC Access**

Used to activate or deactivate the OCC Access feature on a system-wide basis. If “N” is selected by this command, programming screen of “Special Carrier Access” OCC Access is not accessible.

(5) **Outgoing CO Back Tone**

On outgoing CO calls, dialed number is toned out, which informs the extension users that dialed number has been dialed. CO Dialing Tone is usually toned out by default setting, select “N” to turn off the CO dialing tone.

(6) **L-COT Busy Out Looprelay,**

When CO line is busied out either manually by the operator or automatically by the system, the state of Loop Relay is controlled by this setting.

(7) **G-COT Busy Out Looprelay**

When CO line is busied out either manually by the Operator 1, or automatically by the system, the state of Loop Relay and Ring-FG are controlled by this setting.

Input Format

W	S	2	Mode (SH/AT/BT)	(Item Number (1-7))	CR ←
---	---	---	-----------------	---	-------------------	---	------

Index Number

None

4.00 Operation (OPR)

Description

To assign data common to the whole system, by using indexes 1 and 2.
(Password level : Two or higher)

input Format

()

Index Number

Index Number	Explanation
1	The first Operation block

Input Value for Item Number

Item Number	Assigning Items	Input Value
01	Tenant Service	Y : Tenant Service is available N : Tenant Service is unavailable
02	Automatic Route Selection	Y : Automatic Route Selection is available N : Automatic Route Selection is unavailable
03	Numbering Plan	1 : Flex 2 : Fixed 1 3: Fixed2
04	Privacy on DN Key	1 : privacy enabled 2 : privacy disabled
05	Restriction Level - Operator	01 to 16 : the restriction level for telephone company operator call
06	Restriction Level - International	01 to 16 : the restriction level for international call

Continued

53.00 World Select 3 (WS3)

Description

“WS3” command provides the following assignments.
(Password level: Two or higher)

(1) DIL 1: N CO Key Only (PITS only)

It is programmable that an incoming CO call routed via “DIL 1: N” feature arrives at “CO button only” or “CO button or PDN button” as follows.

(Parameters)

Y : An incoming CO call routed via DIL 1: N feature only arrives at a PITS telephone which has associated CO button (SCO, GCO).

If no CO button is assigned on a PITS, an incoming CO call will not arrive at that extension.

N : An incoming CO call routed via DIL 1: N feature arrives at CO button (SCO, GCO) or PDN button.

If no CO button is available on a PITS, an incoming CO call will arrive at PDN button available. (default)

(2) EXT Off-hook BLF (PITS only)

The status indicator on DSS (DN) button reflects the idle/busy status of the associated extension user under one of the following settings.

(Parameters)

Y : The status indicator on DSS (DN) button is lighted steadily either when the associated extension user goes off-hook, or when all PDN buttons are busy. (default)

N : The status indicator on DSS (DN) button is lighted steadily only when all PDN buttons on the associated extension are busy.

(3) DTMF-Tone Integration

On extensions with the Voice Mail Port parameter enabled, the KX-T336 system can send codes (DTMF tones) to indicate the state of the call (busy, answered, ringing, disconnect, etc.) in addition to the normal call progress tones. These codes enable the Voice Processing system to immediately recognize the current state of the call and improve its call handling performance.

(Parameters)

Y : The KX-T336 system sends codes (DTMF tones) to the VPS.

N : The KX-T336 system does not send codes (DTMF tones) to the VPS. (default)

6.00 System Timer (TIM)

Description

To assign a value to the various system timers.
(Password level: Two or higher)

Input Format

T I M **Mode** (**Item Number**) **CR←J**

Input Value for Item Number

Item Number	Assigning Items	Input Value
01	Held Call Reminder	15 to 240 : s
02	Held Call Reminder (ATT)	15 to 240 : s
03	Transfer Recall	15 to 240 : s
04	Pickup Dial Waiting	1 to 5 : s
05	External First Digit Time-Out	5 to 120 : s
06	External Inter digit Time-Out	3 to 15 : s
07	External Inter digit Time-Out (PBX)	3 to 10 : s
08	Toll Restriction Guard Time-out	0 to 25 : s
09	Call Forwarding-No Answer Time-Out	5 to 60 : s
10	Intercept Routing Time-Out (System)	5 to 240 : s
11	Intercept Routing Time-Out (DISA)	5 to 240 : s
12	Attendant Overflow Time	5 to 240 : s
13	SMDR Duration Time	oto15 : s
14	TIE Interdigit Time-Out	3 to 30 : s

Conditions

Item
Number

01 to 02 Held Call Reminder/ Held Call Reminder (ATT) If these items are programmed but if "Operation (OPR)" Index Number 1, Held Call Reminder is set to "N," Held Call Reminder does not function.

(5) Mode Selection of **Calls Arriving at ATT**

When two attendant consoles are connected to the system, one of the following three types of Incoming Mode can be selected.

Options 2 and 3 work only for the incoming outside call routed via a CO line which belongs to the Trunk Group whose Incoming Mode (Day) is assigned as "ATT."

(Parameters)

1. Load Sharing

Incoming outside calls are distributed evenly to two attendant consoles so that they can share the same load. (default)

2. Simultaneous Ringing

An incoming outside call rings at two attendant consoles simultaneously.

3. Interconsole IRNA

If an incoming outside call ringing at one attendant console is not answered within a specified time period (Attendant Overflow Time), it will be automatically transferred to another attendant console automatically.

(6) **Centrex** ARS Mode

In ARS mode, not only a 7-digit or 1 O-digit number but a number equal to or less than **6-digit** (such as **CENTREX** feature access code) that follow the ARS access code (default: 9) can be routed via an outside line.

A number equal to or less than **6-digit** is routed via Local Trunk Dial Access procedure after passing toll restriction process.

A **7-digit** or IO-digit number is routed via ARS procedure after passing toll restriction process.

(Parameters)

Y : A number equal to or less than **6-digit** can be routed via an outside line in ARS mode.

N : A number equal to or less than 6-digit can not be routed via an outside line in ARS mode. (default)

(7) **Waiting for Second Dial Tone Mode**

In some area, upon completion of facility access code entry, the extension user must ensure the reception of the second dial tone from the Central Office before continuing to dial the telephone number.

(Parameters)

Y : The system waits for the second CO dial tone.

N : The system does not wait for the second CO dial tone. (default)

(8) Polarity **Reversal Mode** — (Not available in your area.)

(9) ***/# Allow Mode**

Used to determine if the dialed "*****" and/or "**#**" in the leading 3 digits will be checked by Toll Restriction. This assignment is required for certain central offices (CO) to prevent toll fraud. Some CO ignore the user-dialed "*****" and/or "**#**." If your CO is such a type, select "**N**" (Restricted).

(Parameters)

Y : Not restricted

N : Restricted (default)

Continued

Item Number	Assigning Items	Input Value	CLR	
048	Call Forwarding-Busy/No Answer	Maximum four digits consisting of numbers, *, #	0	
049	Do Not Disturb Set		0	
050	Call Forwarding/Do Not Disturb Cancel		0	
051	Dial Call Pickup Deny Set		0	
052	Dial Call Pickup Deny Cancel		0	
053	Call Waiting Set		0	
054	Call Waiting Cancel		0	
055	BSS/OHCA Deny Set		0	
056	BSS/OHCA Deny Cancel		0	
057	Busy Override Deny Set		0	
058	Busy Override Deny Cancel		0	
059	Data Line Security Set		0	
060	Data Line Security Cancel		0	
061	Pickup Dialing Programming		Maximum four digits consisting of numbers, *	0
062	Pickup Dialing Set		Maximum four digits consisting of numbers, *, #	0
063'	Pickup Dialing Cancel	0		
064	Absent Message Set	0		
065	Absent Message Cancel	0		
066	Timed Reminder Confirm	0		
067	Timed Reminder Set	0		
068	Timed Reminder Cancel	0		
069	Voice Calling Mode Set	0		
070	Voice Calling Mode Cancel	0		
071	Voice Calling Deny Set	0		
072	Voice Calling Deny Cancel	0		
073	Speed Dialing-Station Programming	0		
074	Station Lock Set	0		
075	Station Lock Cancel	0		

Continued

Code for Item Number

Number	Assigning Items	Input Value
01	DIL 1: N CO Key Only	Y: Arrives at CO button only N: Arrives at CO button or PDN button (Default = N)
02	EXT Off-hook BLF	Y: DSS indicator lights when all PDN buttons of the associated extension are busy or Off-Hook N : DSS indicator lights only when all PDN buttons of the associated extension are busy (Default = Y)
03	DTMF-Tone Integration	Y: The KX-T336 system sends codes (DTMF tones) to the VPS. N : The KX-T336 system does not send codes (DTMF tones) to the VPS. (Default = N)
04	SLT On-hook Operation mode	1 : Hang-up causes ringing of consultation hold recall tone. 2 : Hang-up disconnects a call on consultation hold. (Default = 1)
05	Mode Selection of Calls Arriving at ATT	1 : Load Sharing 2 : Simultaneous Ringing 3 : Interconsole IRNA (Default = 1)
06	Centrex ARS Mode	Y: A number equal to or less than 6-digit can be routed via an outside line in ARS mode. N : A number equal to or less than 6-digit can not be routed via an outside line in ARS mode. (Default = N)
07	Waiting for Second Dial Tone	Y: The system waits for the second CO dial tone. N : The system does not wait for the second CO dial tone. (Default = N)

Item Number	Assigning items	Input Value	CLR
106	Call Forwarding-Follow Me Set	Maximum four digits consisting of numbers, *, #	<input type="radio"/>
107	Call Forwarding-Follow Me Cancel		0
108	Other PBX Extension 01	One or two numeric digits	0
109	Other PBX Extension 02		0
110	Other PBX Extension 03		0
111	Other PBX Extension 04		0
112	Other PBX Extension 05		<input type="radio"/>
113	Other PBX Extension 06		<input type="radio"/>
114	Other PBX Extension 07		<input type="radio"/>
115	Other PBX Extension 08		<input type="radio"/>
116	Other PBX Extension 09		<input type="radio"/>
117	Other PBX Extension 10		<input type="radio"/>
118	Other PBX Extension 11		<input type="radio"/>
119	Other PBX Extension 12		<input type="radio"/>
120	Other PBX Extension 13		<input type="radio"/>
121	Other PBX Extension 14		<input type="radio"/>
122	Other PBX Extension 15		<input type="radio"/>
123	Other PBX Extension 16		<input type="radio"/>
124	Transfer	Maximum four digits consisting of numbers, *, #	<input type="radio"/>
125	Conference		0

: clearing function is effective for the item

54.00 Voice Mail Directory Number (VMD)

Description

Used to assign DN of a Voice Mail port (the extension port to which the Voice Mail system is connected.)

This means the KX-T336 system will send the mailbox number of the extension (on which a call forwarding feature is assigned) with DTMF tones to a Voice Mail port, when a call forwarded to a Voice Mail port is answered. Calls from any Voice Mail port will not be forwarded, if forwarding destination is another Voice Mail port.

Input Format

V **M** **D** **Mode** (**Item Number**) **CR** ←

Index Number

None

Input Value for Item Number

Item Number	Assigning Items	Input Value
01 . 16	Voice Mail DN	DNxxxx: Directory Number 0: None (Default = 0)

Programming

(Example)

When DN 109 to 112 are connected to the Voice Mail ports.

To assign the Voice Mail DN

- At the programming prompt (**PRG>**), type:

→ ; **PRG>VMD AT 01** (J)

The screen displays the Input prompt (**INPUT >>**) as follows:

; **PRG>** VMD AT 01

; 01: Voice Mail DN 0

→ ; **INPUT >>**

- At Input prompt (**INPUT >>**), type:

; **PRG>** VMD AT 01

; 01: Voice Mail DN 0

→ ; **INPUT >> DN109** (J)

The screen displays the next Input prompt (**INPUT >>**) as follows:

; **PRG>** VMD AT 01

; 01: Voice Mail DN 0

; **INPUT >> DN109**

; 02: Voice Mail DN 0

→ ; **INPUT >>**

Conditions

"Numbering Plan (NBP)" setting cannot be changed if "Operation (OPR)" index 1, Numbering Plan is set to "2 (Fixed 1)" or "3 (Fixed 2)." If '1' is selected, this setting is changeable.

Logical check is performed by every storage according to the following logic:

Extension numbers are **three** or four digits and the leading one or two digits are assigned in this screen.

Feature numbers may be one, two, three or four digits.

Those numbers assigned in this screen cannot include the same number assigned to other feature number as the part or whole of it. For example, the digit "2" is assigned to the feature number for "Trunk Group 01-08 Access" and another digits "21" is assigned for "Trunk Group 09-19 Access," it is checked at the time of data storage. Similarly, "35" and '351" cannot be present at the same time.

It is possible to store "0" through "9," "*", "#," as the feature numbers. However, if "*" or "#" is included in the feature numbers, those features are not accessed by the *rotary* telephone extensions.

Item

Number

01 to 16	1st to 16th Hundred Block Extension	Extension numbers cannot include "*" and "#."
108 to 123	Other PBX Extension 01 to 16	

63.00 Equal Access Code (EQC) (◆ for U.S.A. and Canada only)

Description

Either "10XXX" or "101 XXXX" can be selected as Equal Access Code.
(Password Level : Two or higher)
Refer to Section 1 O-H-I .00 "Equal Access" for further information.

input Format

E	Q	C	Mode	CR ↵
---	---	---	------	------

Index Number

None

Input Value

- 1: 1 OXXX (default)
- 2: 101XXXX

14.00 Trunk Group 1 (TG1)

Description

To assign information for the 16 trunk groups.
 This is the first of two blocks.
 (Password level: Two or higher)

input Format

()

Index Number

Index Number	Explanation
01 to 16	Trunk group number

Input Value for Item Number

Item Number	Assigning Items	Input Value	CLR
01	Type	1 : DDD(Direct Distance Dialing) 2 : FEX(Foreign Exchange) 3 : WATS (Wide Area Telecommunication Service) 4 : PVL (Private Line) 5 : PBX (Behind PBX) 6 : DID (Direct Inward Dialing) 7 : TIE (TIE Line)	
02	Name	Trunk group name Maximum three digits composed of characters, numbers, and marks (Enclose the name with double quotes ".")	0
03	Tenant	1/2: tenant number (not assignable when "Tenant Service" is set to "N")	
04	Incoming/Outgoing	1 : incoming only 2 : outgoing only 3 : both way	

Continued

continued

item Number	Assigning items	input Value
15	Channel No. 12	0: none 1: LCO 2: GCO 3: DID 4: OPX 5: TIE (Default=0)
16	Channel No. 13	
17	Channel No. 14	
18	Channel No. 15	
19	Channel No. 16	
20	Channel No. 17	
21	Channel No. 18	
22	Channel No. 19	
23	Channel No. 20	
24	Channel No. 21	
25	Channel No. 22	[Note] " * * * " will be displayed in the item numbers 28 through 35. These items cannot be assigned.
26	Channel No. 23	
27	Channel No. 24	
28	Channel No. 25	
29	Channel No. 26	
30	Channel No. 27	
31	Channel No. 28	
32	Channel No. 29	
33	Channel No. 30	
34	Channel No. 31	
35	Channel No. 32	Not assignable

Continued

item Number	Assigning Items	input Value	CLR
14	Pause Time	1 : 1.5s 2 : 2.5 s 3 : 3.5 s 4 : 4.5 s	
15	Hook Switch Flash Time	0 : none 1 : 80ms 2 : 300 ms 3 : 600ms 4 : 900 ms 5 : 1200ms	

○ : clearing function is effective for the item

Conditions

The assigning items:Type, Incoming Mode (Day/Night), Destination **(DIL 1:N Only)** and Type and Number can be changed only when all the trunks belonging to the trunk group are not in use. If any trunk is used, it is impossible to change.

Item Number

- | | | |
|----|----------------------------|---|
| 03 | Tenant | If "***" is displayed here, "Operation (OPR) "; Tenant Service is set to "N (No)." |
| 04 | Incoming/Outgoing | When "Incoming Only" is selected in the trunk group with DID, the following items are assignable but they do not work at all in Incoming Only mode. <ul style="list-style-type: none"> • Disconnect Time • Pause Time • Hook Switch Flash Time • Max. Dial No. after EFA Signal <p>For further information, refer to "3. Other Conditions" on page 9-E-7.</p> |
| 05 | Incoming Mode (Day) | Refer to Section 9-E-I .01 Trunk Group (1/2)." |
| 06 | Incoming Mode (Night) | If "2 (Fixed)" or "3 (Flexible)" is changed to another option, it cancels all the settings of CO lines in "CO Line (COL) ", Night Answer Point (Type: No.) which belong to the trunk group.
If "2 (Fixed)" is changed to "3 (Flexible)" and vice versa, the Night Answer Points are not canceled. |
| 11 | Dialing Plan | Refer to Section 9-E-I .01 "Trunk Group (1/2)." |

For the relation between trunk group/CO line setting and PITS **DN** button setting, refer to Section 9-E-I **.01 "Trunk Group (1/2)."**

64.03 Master Clock Priority (CLP) — T-I

Description

Used to decide to which external clock pulse the system synchronizes, when multiple T-I cards are installed.
(Password level : Two or higher)

Input Format

C	L	P
---	---	---

 Mode (SH/AT/BT) (Item Number) CR ↵

Index Number

None

Input Value for Item Number

Item Number	Assigning Items	Input Value
1 to 6	Priority 1 to 6	T-I card physical slot number (three digits number) (Default = None)

Note:

- You have to assign this item even if only one T-I card is installed.

Conditions

When more than two T-I cards are installed in the system, each of them should be registered by this command.

Item Number	Assigning Items	Input Value	CLR
29	TIE Forced Account mode	Y : TIE callers are required to enter account code when making CO calls. N : Entering account code is not required.	
30	TIE Incoming Delete Digit	0 : deleting no digits 1 to 4 : number of deleting digit(s)	
31	TIE Incoming Insert Dial	blank : Inserting no digit A maximum of four digits number composed of 0 through 9 can be entered.	

0 : clearing function is effective for the item

Conditions

Refer to Section 10-C-14.00 "Trunk Group 1 (TG1)."

65.00 TIE Line Related Commands

65.01 TIE Line Routing Table (TIE)

Description

Used to determine the routing of calls over the TIE Line Network
 Up to 36 routing patterns can be programmed by this command.
 Routing table is referenced by the system to identify the trunk route,
 when a TIE call is made by dialing the feature number for "TIE Trunk
 Access."
 (Password level: Two or higher)

input Format

T I E **Mode (SH/AT/BT)** **Index Number** (**Item Number**) **CR ↵**

Index Number

Index Number	Explanation
01 to 36	TIE Line Routing Table number

Input Value for Item Number

Item Number	Assigning Items	Input Value
1	Code	Up to three digits : 0 • 9, X (wild card) (Default = blank)
2	Delete digit	0 to 4 : number of deleting digit(s) (Default = 0)
3	Insert Dial	Up to four digits : dialing number to be added . (Default = blank)
4	Trunk Group Hunt Sequence 01	01 to 16 : trunk group number whose type is set to TIE. (Default = blank)
5	Trunk Group Hunt Sequence 02	
6	Trunk Group Hunt Sequence 03	
7	Trunk Group Hunt Sequence 04	
8	Trunk Group Hunt Sequence 05	

18.00 CO Line (COL)

Description

To assign parameters on a CO line basis. DATA ERROR appears on the entry of parameters if no trunk card is assigned in the Slot Assignment (SLA) programming. (Password level : Three or higher)

Input Format

C O L **Mode** **Index Number** (**Item Number**) **CR←J**

Index Number

index Number	Explanation
Four digit numbers (1011 to 3158)	Physical number of the CO line

Input Value for Item Number

Item Number	Assigning Items	Input Value
01	Trunk Group	01 to 16 : trunk group number
02	Trunk Name	Maximum ten digits consisting of letters, numbers and marks (Enclose the name with double quotes ".")
03	Direct Termination	DN XXXX (XXXX : three or four digits) : extension number 0 : none (Not assignable when the Trunk Group type is DID, PVL or TIE, or Incoming Mode (Day) is set to any mode except DIL 1:1)
04	Night Answer Point (Type : No.)	DN XXXX (XXXX : three or four digits) : extension number U1 : universal night answer 1 U2 : universal night answer 2 0 : none R : Remote Administration N : Night Answer Group Extensions (Not assignable in case of DID, TIE, or PVL, or outgoing only)
05	Dial Mode	1 : DTMF mode 2 : Pulse mode 3 : MFC-R2 mode
06	DTMF Duration Time	1 : 80ms 2 : 160ms (Not assignable when the dial type is pulse)
07	Pulse Speed	1 : low (10 pps) 2 : high (20 pps) (Not assignable when the dial type is DTMF)

Continued

65.03 TIE Trunk Relay Restriction (TRR)

Description

Used to allow or restrict the TIE trunk relay function on the trunk group basis. Refer to Section 3-F-I 4.04 'Alternate Routing' for further information. (Password level: Two or higher)

Input Format

T R R **Mode (SH/AT/BT)** **Index Number** (**Item Number**) **CR ↵**

Index Number

Index Number	Explanation
01 to 16	Trunk Group Number (Call receiver side)

Input Value for Item Number

Item Number	Assigning Items	Input Value
None	Trunk Group Number (Call initiator side)	Y : Restricted N : Allowed (Default = N)

Conditions

TRR command is valid for the trunk group whose type is set to TIE.

Programming example

TIE Trunk Relay Restriction setting

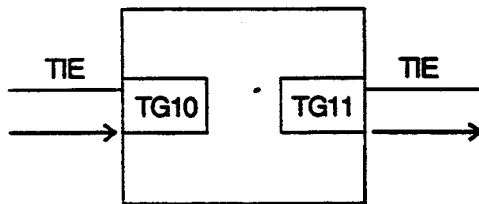

In this case, if you want to restrict 'TIE call relay from TG10 to TG1 1' program as follows:

```
; PRG > TRR AT 10 11 (J)
; Trunk Group No.1 0
; 11 : Trunk Group No.1 1 . . . . N
; INPUT >> Y (J)
```

50.00 Automatic Busy-out Count (ABC)

Description

It is administrable to busy out the invalid CO line automatically to prevent extension users from accessing it by monitoring the loop current sent through CO line.

(Password level: Three or higher).

One of the following three options is assignable on a CO line basis.

(1) N=0

On CO calls, the system monitors a loop current sent through the CO line, and if a loop current is not detected, busy tone is sent to the caller.

(2j) N=1 to 240

On CO calls, the system monitors a loop current sent through the CO line, and if a loop current is not detected pre-assigned times (1 to 240) consecutively, busy tone is sent to the caller.

Then the system busies out the corresponding CO line automatically.

(3) N=241

On CO calls, the system does not monitor the loop current sent through the CO line, **therefore**, CO line is always seized by extension users whether loop current is running or not.

Refer to Section 52.00 "WS 2" L-COT/G-COT Busy Out Looprelay.

Input Format

A	B	C	Mode	Index Number	CR ←
---	---	---	------	--------------	------

Index Number

Index Number	Explanation
1011 to 3166	Physical Number of the Trunk Port

Input Value for Item Number

Item Number	Assigning Items	Input Value
None	Automatic Busy-out Count	<p>xxx (0 to 241)</p> <p>(Loop Current Detection) (Automatic Busy-out)</p> <p>0: Yes No</p> <p>1 to 240: Yes Yes</p> <p>if loop current is not detected by the pre-assigned times (1 to 240)</p> <p>241: No No</p> <p>(Default = 241)</p>

67.00 DISA/AGC Tone Detection Mode (TDM)

Description

When Tone Detection for **DISA/AGC** is set to **"Yes"**, the system disconnects the lines if it detects any tones, regardless of tone type, during a **trunk-to-trunk** call (DISA or AGC).

This command is used to select a type of tones which applies to tone detection for **DISA/AGC** on a Trunk Group basis.

For example, if "2:cyclic tone only" is selected, the system disconnects the lines only when it detects cyclic tone during a trunk-to-trunk call (DISA or AGC).

(Password level : Two or higher)

Input Format

T D M Mode (SH/AT/BT) (Index Number(01-16)) CR ↵

Index Number

Index Number	Explanation
01 to 16	Trunk Group Number

Input Value for Item Number

Item Number	Assigning Items	Input Value
None	Tone Detection Mode (DISA/AGC)	0: all tones (no tone, cyclic tone, continuous tone) 1: no tone or cyclic tone 2: cyclic tone only (Default = 0)

Conditions

None

Input Value for item Number

em lumber	Assigning items	Input Value
1	Interdigit Pause	1 : 630 ms 2 : 830 ms 3: 1030ms (Default=2)
2	Pulse Type	1 : Normal 2 : New Zealand 3 : Sweden (Default=1)
3	Automatic Redial Retry Count	01 : 1 time : : 32 : 32 times (Default=1 5)
4	Automatic Redial Retry Interval	01 : 10s : : 32 : 320 s (Default=04)
5	% Break Detect	1 : 16 to 96 ms 2 : 16 to 136 ms (Default = 1)
6	Flash Detect (SLT)	0 : No 1 : Yes (Default = 1)
7	Flash Detect (Tie)	0 : Disabled (no detection) (200ms~ : On-hook) 1 : 200 ms to 1 s (1 s ~ : On-hook) 2 : 80 ms to 1 s (1 s ~ : On-hook) 3 : 200 ms to 1.5 s (1.5 s ~ : On-hook) 4 : 80 ms to 1.5 s (1.5 s ~ : On-hook) (Default = 1)
8	Answer Decision Timer	001: 32 ms 002 : 64 ms : : 255 : 8.16s (Default = 001)

69.00 Limited Call Duration (LCD)

Description

Used to set parameters on "Limited Call Duration" feature. This feature can be enabled or disabled on a COS basis. For further information, refer to Section 3-F-I 6.00 "Limited Call Duration".

(Password level : Two or higher)

Input Format

L	C	D	Mode (SH/AT/BT)	Index Number (01-32)	(Item Number (1-2))	CR ↵
---	---	---	-----------------	----------------------	---	-------------------	---	------

Index Number

Index Number	Explanation
01 to32	COS (Class of Service) number

Input Value for Item Number

Item Number	Assigning Items	Input Value
1	Extension-CO call duration time	00: No Limitation 01-60: Limitation Time (Minutes) (Default=00)
2	Call type	0: Outgoing CO call only 1: Incoming CO call onty 2: Both (Default=0)

input Value for Item Number

Item Number	Assigning items	Input Value
1	First Dial Timer	01 : 0.5 s 02 : 1.0 s . 16 : 8.0 s (Default=02)
2	First Dial Timer (DID)	001 : 32 ms 002 : 64 (32×2) ms . 255 : 8.16 (32×255) s (Default=002)
3	EQU Access	Y: EQU Access is allowed N : EQU Access is not allowed (Default = Y)
4	OCC Access	Y : OCC Access is allowed N : OCC Access is not allowed (Default = Y)
5	Outgoing CO Back Tone	Y : Dialed digits is toned out N : Dialed digits is not toned out (Default = Y)
6	L-COT Busy Out Looprelay	Y : Loop Relay ON N : Loop Relay OFF (Default = N)
7	G-COT Busy Out Looprelay	1 : Loop Relay ON + Ring-FG Open 2 : Loop Relay OFF + Ring-FG Close 3 : Loop Relay OFF + Ring-FG Open (Default = 3)

DATA ERROR No.	Probable Cause	Countermeasure
395	Attempting to delete the extension which is registered as an overflow extension for UCD group.	Cancel the storage as an overflow destination.
396	Attempting to delete the extension/RMT which is registered as a DIL 1 :1 call destination of CO line.	Cancel the storage as a DIL 1:1 call destination.
397	Attempting to delete the extension which is registered as a night answer point of CO line.	Cancel the storage as a night answer point.
398	Attempting to delete the extension which is registered as a walking station.	Cancel the storage as a walking station.
399	Attempting to delete the PITS paired with DSS -console.	Change the PITS paired with DSS Console.
400	Attempting to delete the extension which is registered as a night answer point for tenant.	Cancel the storage as night answer point.
401	Attempting to delete the extension which is set to SDN.	Cancel the assignment of SDN.
403	Attempting to delete the ATT when the ATT is assigned for day incoming mode in Trunk group.	Change the incoming mode destination other than AI-T.
404	Attempting to delete RMT when the RMT alarm is assigned.	Cancel the assignment of RMT alarm.
405	Attempting to delete the external pager which is registered as UNA point for CO line.	Change the night answer point.
406	Attempting to delete the external pager which is registered as a TAFAS for day/night incoming mode for Trunk group.	Change the incoming mode.
407	Attempting to delete the external pager which is registered as a paging destination for the ATT.	Change the paging destination.
408	Attempting to delete the ATT which is specified for maintenance device.	After changing maintenance device, delete the ATT.
409	When deleting ATT, combination of operators 1 and 2 is incorrect.	Check the combination of operators.
411	Impossible to delete the card, for all of the ports belonging to the card is not made pm-installed.	Delete all the ports belonging to the card.
412	Impossible to delete the card, for DN is assigned to an extension port.	Delete all the ports belonging to the card.
413	Deleting the card is impossible, for it is assigned as a maintenance device.	Change the maintenance device.

(4) SLT On-hook Operation Mode

In single line telephone procedures, active call is put on consultation hold when the switchhook is pressed down for approximately 1/2 second and released.

In this case, consultation hold recall tone will ring immediately if you replace the handset on the switchhook without dialing any digits. Then you may hear recorder tone when you lift the handset to reply this ringing

This, may happen sometimes if the handset is replaced on the switchhook after hopping on it.

To prevent such unexpected consultation hold tone from ringing, select "2" for this setting.

When setting "2" is selected, a call put consultation hold will be disconnected if you replace the handset on the switchhook without dialing any digits.

When "1" is selected. — default

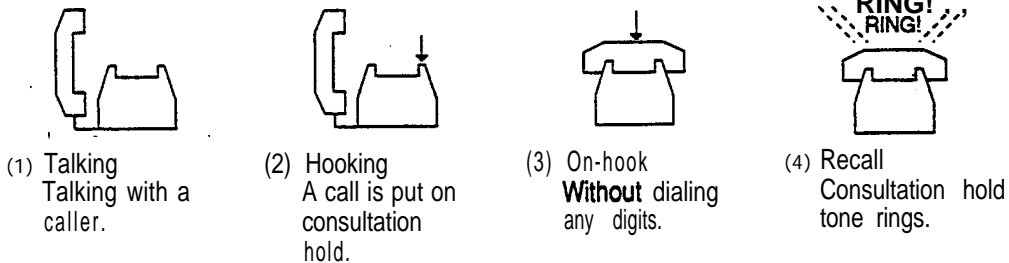

When "2" is selected

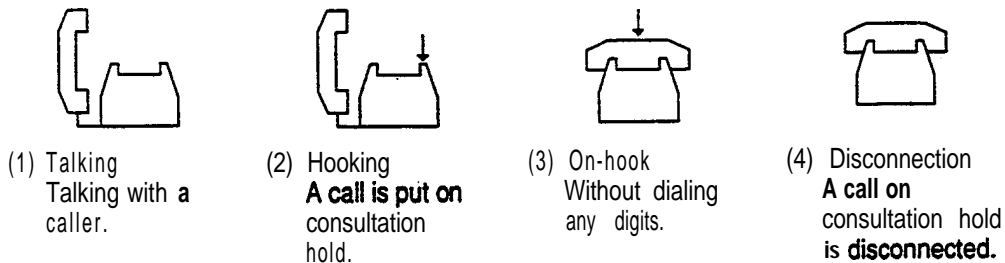

(Note)

To hang up and make another call right away, an SLT user should **be sure** to hold down the switchhook for more than two seconds.

(Parameters)

- 1 : Hang-up causes ringing of consultation hold recall tone. (default)
 - 2 : Hang-up disconnects a call on consultation hold.
-

DATA ERROR No.	Probable Cause	Countermeasure
431	Attempting to remove a card which is registered in Power Failure Transfer (PFT) assignment.	Cancel the PFT assignment of the card.
440	Impossible to change the Numbering Plan to "Fixed," because there exist DN's which should be blank in the 'Fixed" mode in the Hundred B l o c k .	Clear DN's which should be blank.
450	Impossible to change ICM/Paging group, for the pickup group belonging to the ICM/Paging group contains extensions.	Change after deleting all the extensions in the pickup group.

(10) Message Waiting Lamp Off-Control — Voice Mail

Used to determine whether the system turns off the Message Waiting lamp or the VPS does when the VPS answers the callback from the message receiver.

(Parameters)

1. Normal Mode

The system turns off the Message Waiting lamp. (default)

2. Voice Mail Mode 1

Only the VPS port that turned on the Message Waiting lamp can turn it off.

3. Voice Mail Mode 2

Any VPS port can turn off the Message Waiting lamp.

(11) μ -law-A-law (E-I only) — (Not available in your area.)

(12) SLT Transfer Operation

If set to 'Mode 2', the following operations become available with the SLT users.

- Screened Call Transfer to Trunk (Section 5-D-I .06)
- Call Transfer by using the feature number for "Transfer." (Section 5-D-I .01 through 1.05)
- Establishing a conference call by dialing the feature number for "Conference." (Section 5-E-1 .00)

(Parameters)

1: Mode 1 (default)

2: Mode 2

(13) Ringback Tone While Transfer

Used to select the type of sound source during an unscreened call transfer to an extension.

By default, the caller hears Music on Hold (if provided) while the caller is being transferred to another location. However, if no music source is provided with the system, the caller hears no sound. In this case, we recommend changing the setting to "Y(Ringback Tone)."

(Parameters)

Y : Ringback Tone

N : Music on Hold (default)

Input Format

()

Index Number

None

3.00 Fixed Error Messages

DATA ERROR No.	Probable Cause	Countermeasure
003	Unacceptable value is assigned.	Assign an allowable value.
004	Space exists between items.	Remove the space.
005	Some items are left blank.	Assign all required items, or leave all items blank.
006	At least one blank should be left among multiple items.	Leave at least one blank.
007	Assigned selection value is not for the item,	Set the assignable value.
008	The number which is set previously in this screen is assigned again.	Set the number different from the previous number.
009	The number which is set previously in a different screen is assigned.	Set the number different from the previous number.
012	Device is not installed.	Assign the installed device.
013	Status of the specified device does not accept this command.	Change the status of the device to be acceptable for the command.
016	Privilege level is lower than specified level.	Increase the privilege level through the Change level function.
017	Diagnostic error has been detected when INS command is executed.	Verify the related device.
018	Specified service is not executed.	Check specified service.
019	Another maintenance device (remote, PITS, system) is in use.	Wait until another device is finished or let him finish.
020	Printer is not connected to the system or the power is off.	Connect the printer, and make the power on.
021	Print out is unavailable from Remote.	Execute print out on-site.
022	Entered parameters for Item or Index is out of the specified range.	Enter the parameters within the specified range.
023	" , / " or ● , <CR> " is entered in BT (Batch) programming.	Correct the wrong entry.
024	Calendar IC malfunction.	Repair calendar IC .
027	Backup device is not connected (only when maintenance device is ATT).	Connect the backup device to SIO # 1 Port.
029	Different version at the time of backup.	Match the backup version .

Item Number	Assigning Items	Input Value
08	Polarity Reversal Mode	Not available in your area.
09	*/# Allow Mode	Y : Not restricted N : Restricted (Default = N)
10	Message Waiting Lamp Off Control --- Voice Mail	1 : Normal Mode 2 : Voice Mail Mode 1 3 : Voice Mail Mode 2 (Default = 1)
11	P-law-A-law (E-I only)	Not available in your area.
12	SLT Transfer Operation	1 : Mode 1 2: Mode2 (Default = 1)
1 3	Ringback Tone While Transfer	Y : Ringback Tone N : Music on Hold (Default = N)

Section 14

Maintenance

VT220 and Compatibles

	Page
3.06 Expansion shelf power down (DC)	14-E-9
3.07 Expansion shelf power down (AC)	14-E-10
3.08 Progress tone failure (TSW card).....	14-E-11
3.09 Check date/time (Real Time Clock IC)	14-E-12
3.10 Conference trunk failure (Basic)	14-E-13
3.11 Conference trunk failure (Option)	14-E-14
3.12 System memory error (Major)	14-E-15
3.13 System memory error (Minor).	14-E-16
3.14 Device not connect for SMDR	14-E-17
3.15 CPU RAM backup battery down	14-E-18
3.16 Card link failure (LPR)	14-E-19
3.17 LPR ROM checksum error	14-E-20
3.18 LPR RAM failure	14-E-21
3.19 Card disconnect.....	14-E-22
3.20 Modem failure (RMT card)	14-E-23
3.21 LPR memory checksum error	14-E-24
3.22 Card type error (LPR)	14-E-25
3.23 LPR runaway	14-E-26
3.24 OGM CPU runaway (DISA)	14-E-27
3.25 OGM lost (DISA)	14-E-28
3.26 OPX power down	14-E-29
3.27 DTMF generator failure (COT card)	14-E-30
3.28 DTMF receiver failure (SLC/HLC/OPX card).	14-E-31
3.29 Tone detector failure (DISA/AGC card)	14-E-32
3.30 HDLC failure (ATLC card)	14-E-33
3.31 Port link failure (ATT/DPH).....	14-E-34
3.32 OHCA SW failure(TSW card)	14-E-35
3.33 OHCA not installed (PLC/HLC)	14-E-36
3.34 TSW DTMF G/R. failure	14-E-37
3.35 Digital trunk failure (out of synchronization)	14-E-37-1
3.36 Digital trunk failure (RAI signal reception)	14-E-37-2
3.37 Digital trunk failure (AIS signal reception)	14-E-37-3
3.38 Digital trunk failure (frame trouble)	14-E-37-4
4.00 Troubleshooting via User-Reported Troubles	14-E-38
F Functional Test by Entering Commands	14-F-1
1 .OO introduction	14-F-1
2.00 Test Main Menu	14-F-2
3.00 Testing the Cards	14-F-3
3.01 Functions to be Verified	14-F-3
3.02 Card Test Initial screen	14-F-4

64.00 T-I Related Commands

64.01 Channel Assignment (CHA) — T-I

Description

Assigns the type of T-I trunk interface to each channel.
(Password level: One)

Input Format

C **H** **A** **Mode (SH/AT/BT)** **Index Number** (**Item Number (01-35)**) **CR** **↓**

Index Number

Index Number	Explanation
X <u> </u> <u> </u> - Slot No. Slot 05., or 09 Shelf (1 to 3)	Physical number (101,105,109,201,205,209,301,305,309)

Input Value for Item Number

Item Number	Assigning Items	Input Value
01	Option	Automatic Set
02	Frame Sequence	1: D4 2: ESF (Default=2)
03	Line Coding	1: B8ZS 2: AMI (Default=1)
04	Channel No. 01	0: none 1: LCO 2: GCO 3: DID 4: OPX 5: TIE (Default=0) [Note] "****" will be displayed in the item numbers 28 through 35. These items cannot be assigned.
05	Channel No. 02	
06	Channel No. 03	
07	Channel No. 04	
08	Channel No. 05	
09	Channel No. 06	
10	Channel No. 07	
11	Channel No. 08	
12	Channel No. 09	
13	Channel No. 10	
14	Channel No. 11	

3.00 Troubleshooting via Error Log Records

3.01 Error Log Record List

Background Diagnostic Errors

ERR CODE	Severity	AUTOMATIC FAILURE REPORT (SMDR) MESSAGE	LOCAL ALARM MESSAGE		COMMENTS
			ATT	PITS	
3100	MJ				NDT overflow
3200	MJ				soft timer overflow
3300	MJ	TSW clock down	TSW Clock Down	TSW DWN	internal clock down
0301	MJ	TSW clock down	TSW Clock Down	TSW DWN	external clock down
0400	MJ	Basic shelf power down			DC power down
0410	MN	Basic shelf power down	B-Shelf POW Down	POW DWN	AC power down
050n	MJ	Expansion shelf n (1/2) power down	E-Shelf POW Down	POW DWN	DC power down
051n	MN	Expansion shelf n (1/2) power down	E-Shelf POW Down	POW DWN	AC power down
0600	MN	Progress tone failure	Tone Failure	DIAL TN	
0700	MN	Check date/time	Check Date/Time	CLCK IC	
3800	MN	Conference trunk failure	CONF TRK Failure	CONF TK	all basic trunk failure
38bb	--	Conference trunk failure			trunk failure
0900	MN	Conference trunk failure	CONF TRK Failure	CONF TK	all optional trunk failure
09tt	--	Conference trunk failure			trunk failure
0Azz	MN	System memory error	SYS Memory Error	SYS MEM	read error
	MJ	System memory error	SYS Memory Error	SYS MEM	write/read error
DB00	MN		SMDR Not Connect	SMDR	
0C00	MN	CPU RAM backup battery down	Battery Down	BATTERY	
10xX	MN	Card link failure	Card Link Failure	CRD LNK	
11xx	MN	LPR ROM checksum error	LPR ROM Failure	CRD ROM	
12xx	MN	LPR RAM failure	LPR RAM Failure	CRD RAM	
1300	MJ	Card disconnect	Card Disconnect	DISCNCT	TSW card
13xx	MN	Card disconnect	Card Disconnect	DISCNCT	
14xx	MN	Modem failure	MODEM Failure	MODEM	
20xx	--	LPR memory checksum error			loaded data failure
21xx	--	Card type error			card type error
22xx	--	LPR runaway			LPR runaway
50xx	--	OGM CPU runaway			OGM CPU runaway
51xx	MN	OGM lost	OGM Lost	OGM LOS	
60xx	MN	OPX power down	OPX Power Down	OPX POW	
61xx	MN	OPX power down (b e l l)	OPX Power Down	OPX POW	
70xx	MN	Digital trunk failure	D-Trunk Failure	D-TRK	line trouble (out of synchronization)
71xx	MN	Digital trunk failure	D-Trunk Failure	D-TRK	line trouble (RAI signal reception)

Legend:
 MJ-Major Alarm
 MN-Minor Alarm

64.02 System Clock Mode (CLK) — T-1

Description

Used to set the system clock mode to 'External' or 'Internal.'

- External clock mode The system synchronizes to a clock pulse provided by the Central Office.
- internal clock mode The system synchronizes to a clock pulse provided by the internal **TSW** clock.

To utilize the T-1 lines, the system should synchronize to a clock pulse provided by the Central Office. However, if synchronization with External clock is lost, the system automatically switches to 'Internal clock mode.'
(Password level : Two or higher)

Input Format

C L K Mode (SH/AT/BT) **CR ↓**

Index Number

N o n e

Input Value for item Number

Item Number	Assigning Items	Input Value
None	TSW clock mode	1 : internal dock 2 : External clock (Default = 1)

Note :

- **When** utilizing the T-1 lines, the **clock** mode cannot be changed unless all **T1 DIGITAL TRUNK** Cards in the **system** turns to ● **OUS** or **"FAULT"** status.
- **When** the external clock has problems and is not working properly, the internal **clock** starts **to work** automatically.

64.04 ESF Frame Option (EFO) — T-I

Description

Used to define the values of C-bit and D-bit when Frame Sequence is **D4/ESF** in T-I interface.
(Password level : Two or higher)

Input Format

E	F	O	Mode (SH/AT/BT)	Index Number	CR ↵
---	---	---	-----------------	--------------	------

Index Number

Index Number	Explanation								
<table style="border-collapse: collapse;"> <tr> <td style="border: none; padding-right: 5px;">X</td> <td style="border: none; padding-right: 5px;">XX</td> <td style="border: none;"> </td> <td style="border: none;">Slot No. (01, 05 or 09)</td> </tr> <tr> <td style="border: none; padding-right: 5px;"></td> <td style="border: none; padding-right: 5px;"></td> <td style="border: none;"> </td> <td style="border: none;">Shelf (1 to 3)</td> </tr> </table>	X	XX		Slot No. (01, 05 or 09)				Shelf (1 to 3)	Physical number (101,105,109,201,205,209,301,305,309)
X	XX		Slot No. (01, 05 or 09)						
			Shelf (1 to 3)						

Input Value for Item Number

Item Number	Assigning Items	Input Value
None	Values for C-bit and D-bit	1: Option4 (C=A, D=B) 2: Option-16 (C=0, D=0) 3: Option-16 (C=1, D=0) 4: Option-16 (C=0, D=1) 5: Option-16 (C=1, D=1) (Default=1)

3.03 TSW clock down (Internal/External)

(1) Internal clock down

Error Code

0300

Possible cause of the malfunction

- 1) TSW card connection error
- 2) TSW card clock link failure (Internal)

Countermeasures

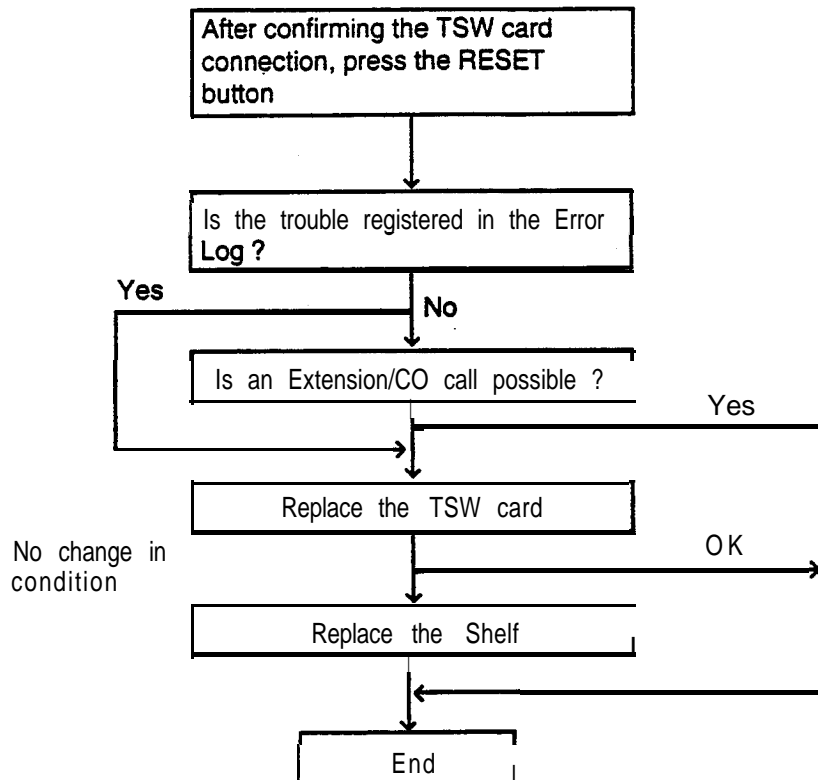

Note

- If the TSW clock malfunction occurs:
- 1) The attendant console does not function.
(Communication to the LPR becomes impossible)
 - 2) Calling becomes impossible
 - 3) Power Failure Transfer will be activated

65.02 TIE Account Code (TAC)

Description

TIE account codes registered by TAC command is used to prevent the tie callers from making unauthorized CO calls by checking the validity of the account code entered.

TIE callers must enter a TIE Account Code *to* make a CO call via TIE lines, if "TIE Forced Account Code Mode" is set to 'Yes.' Refer to Section 3-F-14.02 'Calling from TIE to CO' for further information.

(Password level : Two or higher)

Input Format

T	A	C
---	---	---

 Mode (SH/AT/BT) (Item Number (01-32)) CR J

Input Value for Item Number

Item Number	Assigning Items	Input Value
01 to 32	TIE Account Code	Four digits numeric number (0 - 9) (Default = blank)

Section 15

Maintenance

Dumb Type Terminal

65.04 Line Hunting Sequence(LHS)

Description

Used to change the hunting sequence of idle lines on a TIE trunk group basis.

By default, idle TIE lines are seized from the smallest to the largest **physical** number in order at **all** locations when **a TIE** call is initiated by a user. This may cause a frequently busy situation between a certain two locations.

In this case, we recommend to change the hunting sequence at one location from '1' (smallest+ largest) to '2' (largest **→smallest**).
(Password level : Two or higher)

Input Format

LHS Mode (SH/AT/BT) (Index Number (01-16)) CR ↵

Index Number

Index Number	Explanation
01 to 16	Trunk Group Number

input Value for item Number

Item Number	Assigning Items	Input Value
None	tine Hunting Sequence	1: From the smallest to the largest physical number of TIE lines 2: From the largest to the smallest physical number of TIE lines (Default = 1)

	Page
F Monitor	15-F-i
1 .00 SYM command (System Maintenance Monitor)	15-F-1
1 .01 System Status screen	15-F-2
1.02 Card Status screen	15-F-3
1.03 Port Status screen	15-F-4
1.04 Conference Trunk Status screen	15-F-5
2.00 TFD command (Traffic Display).	15-F-6
2.01 Station screen	15-F-7
2.02 Trunk Group screen	15-F-0
2.03 Attendant Console screen	15-F-9
2.04 DISA screen	15-F-10
2.05 OGM 1 screen	15-F-11
2.06 OGM 2 screen	15-F-12
2.07 AGC screen	15-F-13
G Other Features	15-G-1
1 .00 PFT command (Power Failure Transfer)	15-G-1
2.00 VUP command (Version-up)	15-G-3

68.00 Call Forwarding-Follow Me (CFM)

Description

Used to allow or disallow each extension from setting "Call Forwarding-Follow Me" feature on a COS basis. Refer to Section 4-F-2.06 and Section 5-D-2.06 'Call Forwarding-Follow Me' for further information.

(Password level : Two or higher)

Input Format

C	F	M	Mode (SH/AT/BT)	(Index Number (01-32))	CR	↓
---	---	---	-----------------	---	----------------------	---	----	---

Index Number

Index Number	Explanation
01 to 32	COS (Class of Service) number

Input Value for Item Number

Item Number	Assigning Items	Input Value
None	Call Forwarding-Follow Me	Y: Enabled N: Disabled (Default=N)

3.01 Loopback Test (LBT) -for T-I

Description

Used to verify the validity of the T-I DIGITAL TRUNK cards and line connections.

Before performing **Loopback** Test, set the card status to 'OUS'.

Command Format

- (1) OPE>LBT + Item1 + Item2 ↵
 (2) OPE>LBT + Item1 + Item2 + Item3 ↵

Command Format	Item1	Item2	Item3
(1)	1 or2 1: Internal Loopback *1	101,105,109,201,205, 209,301,305,309 (Card No.)*3	None
(2)	2: External Loopback *2	G xxxyy (DTMF Generator No.) xxx : Card No. yy : 01 too6	R xxxyy (DTMF Receiver No.) xxx: Card No. yy : 01 to24

- I. Loopback test is completed automatically inside the T-I DIGITAL TRUNK **card**.
- *2. **Loopback** test is completed between the T-I DIGITAL TRUNK card and the external equipment (CSU, DSU). In this case, **loopback** mode should be set at the external terminal beforehand.
- *3. **When** a card No. is specified, DTMF Generator No.1 and DTMF Receiver No.1 of that card are used for the test.

Results Display

Error Indication	Description
OK	Normal
Voice error	Speech path failure
Signal error.	Control signal path failure

D. Error Message Tables

1.00 Error Messages Related to the Assigning Items in the Same Command

If there is a wrong entry in the displayed screen, the following appears on the message line when storing the entry: "DATA ERROR (XXX)."

The (XXX) indicates one of the error message numbers shown below and possible causes of the errors and countermeasures for them are as follows.

DATA ERROR No. (XXX)	Probable Cause	Countermeasure
100	(page length)-(skip length) < 6	Make (page length)-(skip length) ≥ 6.
101	(receive digit) ≥ (delete digit) is not established in • Special Attended DID screen.	Make (receive digit) ≥ (delete digit).
102	Restriction Level-Operator ≤ Restriction Level-International is not established in • Operation (1/3) screen	Make Restriction Level-Operation 6 Restriction Level-International
110	Day-night combination in the incoming mode is not correct.	Change the day-night combination in incoming mode.
130	Combination of the terminals of operators 1, 2 is incorrect.	Change the combination of terminals for operators 1, 2.
140	DN is not installed.	Designate the installed DN.
141	Attempting to assign FDN's of UCD # 1 to # 4 for the overflow destination of UCD # 5 to # 32	Set FDN of other UCD. or extension director] number.
150	Attempting to assign its own extension number on the key which cannot be assigned to its own extension number. <example> DSS(ICM) DSS(DN) SDN	Specify the number except its own extension number.
160	Specifying UCD number incorrectly.	Assign UCD to only one ICM.
190	Date value is incorrect on the check of month, and leap year in the time and date setting screen.	Check the date setting.

3.00 Device Status screen

3.01 System Status Initial screen

Device Status (1/4)		ONL MON	
System Status			
ROM Version -----		V12.00	
Date -----		May.08 1995	
For Place -----		Area-2	
CPU RAM -----		INS	
Basic Shelf -----		INS	
Expansion Shelf 1 ---		INS	
Expansion Shelf 2 -----			
T S W			
Additional CONF -----			
S M D R - - - - -		INS	
Clock M o d e - - - - -		External	
Master Clock Card -----		101	

1 COMMON 2 3 4 5 6 HRD CPY 7 8

Description

ROM version	-----	Software's version
Date	-----	The date software was originated
For Place	-----	Destination
CPU RAM	-----	Current status of RAM area
Basic Shelf	-----	Current status of Basic Shelf
Expansion Shelf 1	-----	Current status of Expansion Shelf 1
Expansion Shelf 2	-----	Current status of Expansion Shelf 2
T S W	-----	Current status of TSW card
Additional CONF	-----	Current status of optional Conference card
SMDR	-----	Current status of SMDR device
Clock Mode	-----	Displayed only when T-I Digital Trunk card is installed. 'External' is displayed when the system synchronizes with the external clock - ' Internal ' is displayed when the system synchronizes with the internal dock. Refer to Section 10-C-64.02 'System Clock Mode (CLK)' for further information.
Master Clock Card	-----	Displayed only when T-I Digital Trunk card is installed. ' XXX ' (physical card No. of the master card) is displayed when the external clock mode is utilized. ' _ ' is displayed when the internal clock mode is utilized. Refer to Section 10-C-64.03 "Master Clock Priority (CLP)" for further information.

* In above screen, ^a "-" indicates that the device is not installed.

DATA ERROR No.	Probable Cause	Countermeasure
414	Deleting the card is impossible, because it is assigned for the intercept routing destination for the Trunk group.	Change the intercept routing destination.
415	Deleting the card is impossible, because it is assigned for doorphone call destination.	Cancel the doorphone call destination.
416	Attempting to delete the ATT which is specified for incoming mode destination of a trunk group.	Change the incoming mode destination.
417	Attempting to delete a DISA card which is specified for incoming mode destination of a trunk group.	Change the incoming mode destination.
418	Attempting to assign NAG as Night Answer Point of a CO line belonging to a Trunk Group whose Incoming Mode (Night) is not FIXED.	Assign Incoming Mode (Night) to FIXED.
420	Changing Tenant Service from 'Yes' to 'No' is impossible as all ATT's are not assigned to tenant 1.	Assign All's to tenant 1.
421	Changing Tenant Service from 'Yes' to 'No' is impossible as all music sources are not assigned to tenant 1.	Assign music sources to tenant 1.
422	Changing Tenant Service from 'Yes' to 'No' is impossible as all external pagers are not assigned to tenant 1.	Assign external pagers to tenant 1.
423	Changing Tenant Service from 'Yes' to 'No' is impossible as all doorphones are not assigned to tenant 1.	Assign doorphones to tenant 1.
424	Changing Tenant Service from 'Yes' to 'No' is impossible as all DISA's are not assigned to tenant 1.	Assign DISA's to tenant 1.
425	Changing Tenant Service from 'Yes' to 'No' is impossible as all AGC's are not assigned to tenant 1.	Assign AGC's to tenant 1.
426	Changing Tenant Service from "Yes" to 'No' is impossible as all paging groups are not assigned to tenant 1.	Assign all paging groups to tenant 1.
427	Changing Tenant Service from 'Yes' to 'No' is impossible as all ICM groups are not assigned to tenant 1.	Assign all ICM groups to tenant 1.
428	Changing Tenant Service from 'Yes' to 'No' is impossible as all trunk groups are not assigned to tenant 1.	Assign all trunk groups to tenant 1.
430	Deleting expansion shelf is impossible, as one or more cards are assigned to the expansion shelf.	Delete all the cards in the expansion shelf .

3.35 Digital trunk failure (out of synchronization)

Error Code

70xx xx=01 to 42 : Slot number

Possible cause of the malfunction

T-1 card (physical number xx) lost the synchronization with the clock time sent from the Central Office.

Countermeasures

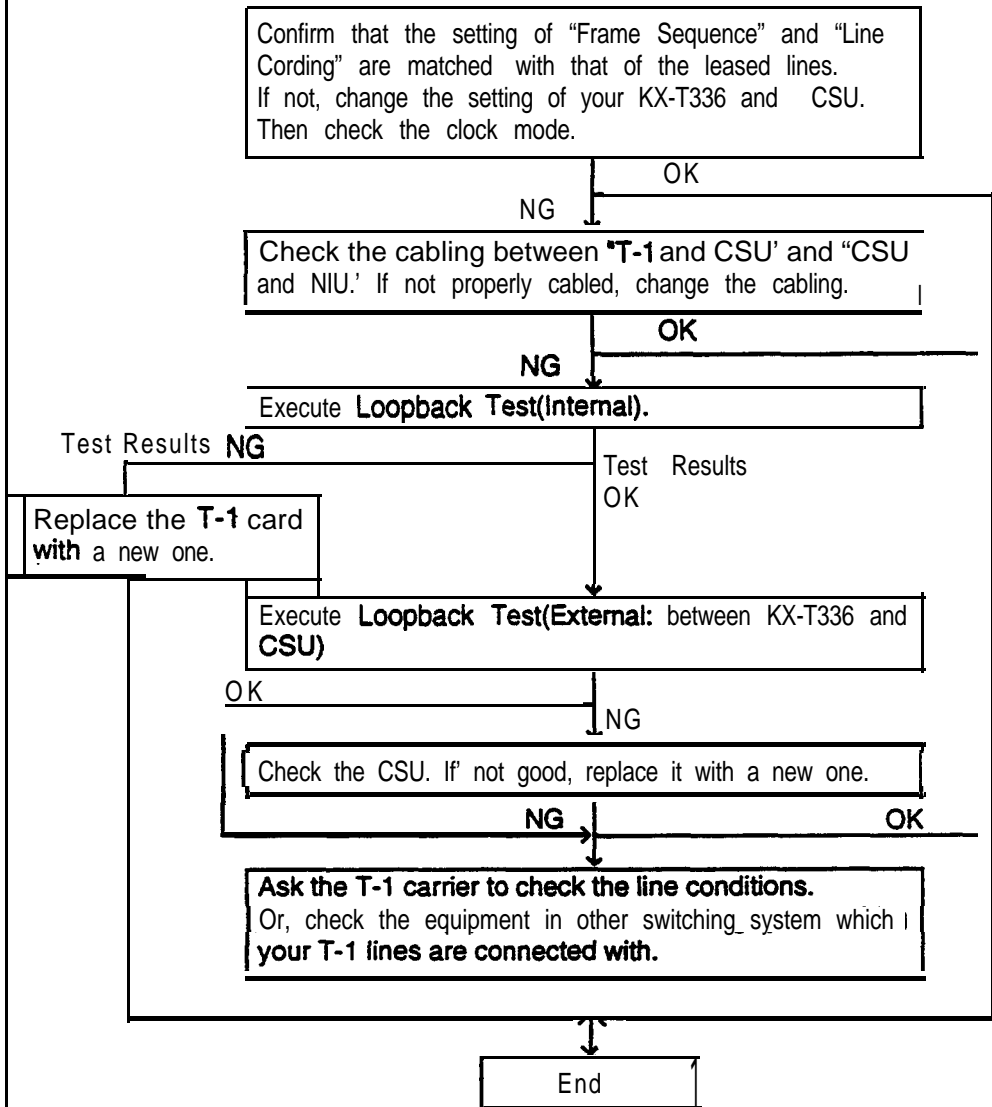

Note

Another T-1 card with next priority will work as a master card, if more than two T-1 cards were registered to the system by CLP command (Refer to Section 64.63) beforehand. **Otherwise**, the system will synchronize with the system internal clock.

3.37 Digital trunk failure (AIS signal reception)

Error Code 72xx xx=01 to 42 : Slot number

Possible cause of the malfunction T-1 card (physical number xx) received the **AIS** (Alarm indication Signal) signal from the Central Office.

Countermeasures

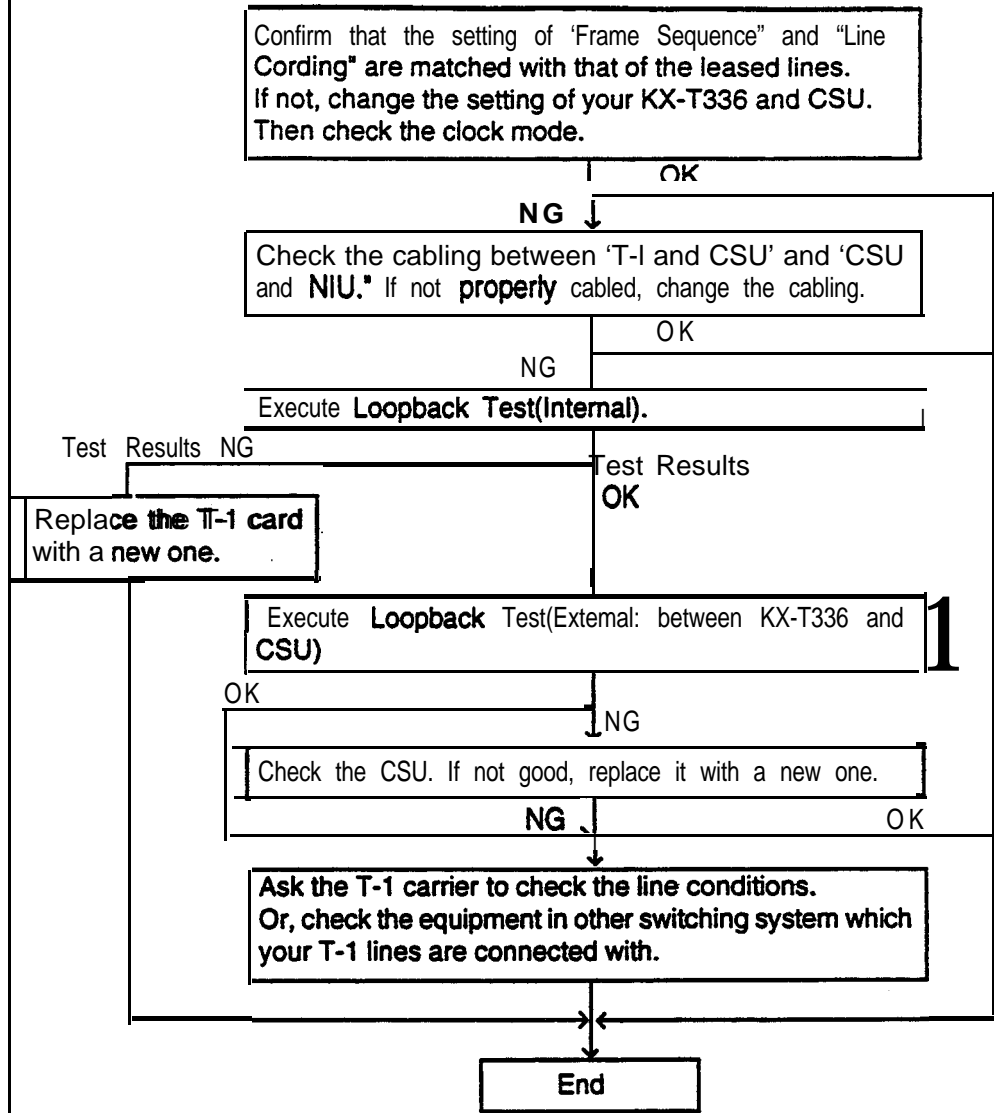

Note

Another T-1 card with next priority will work as a master card, if more than two T-1 cards were registered to the system by CLP command (Refer to Section 64.03) beforehand. Otherwise, the system will synchronize with the system internal clock.

DATA ERROR No.	Probable Cause	Countermeasure
030	A checksum error has been detected.	Communication line is defective, or backup data is destroyed.
031	improper data is received.	Communication link is defective, or backup data is destroyed.
	Execution is impossible.	Execute during on-line.
041	Impossible change such as [OUS] → [OUS] is attempted.	Impossible.
042	Some required items are omitted.	Enter the required items.
043	The number of equipment you attempt to assign is over the limit.	Assign the equipment within the limit of number.
045	Slot number you specified is not valid. (DTM, LBT, DSP commands)	Specify the slot in which T-I/E-I card is installed.
046	Card type you specified is not valid. (DTM, LBT, DSP commands)	Specify the T-I/E-I card.
047	The status of the card you specified is not valid. (DTM, LBT, DSP commands)	Change the status to valid one.
048	No DTMF Generator/Receiver is installed on the card you specified. (DTM, LBT commands)	Install the optional DTMF Generator/Receiver card.
049	You specified the DTMF Generator/Receiver of different cards. (DTM, LBT commands)	Specify the DTMF Generator/Receiver of the same card.

Maintenance VT220 and Compatibles

Contents

	Page
A Introduction	14-A-1
B System Administration	14-B-1
1 .00 On-Site Administration	14-6-1
1.01 Logging in to the System	14-B-1
1.02 Administration Main Menu screen	14-B-2
2.00 System Administration from a Remote Location	14-B-3
C Device Status	14-C-1
1.00 Service Commands and Their Functions	14-c-1
1.01 INS (In Service) Command	14-C-2
1.02 OUS (Out of Service) Command	14-c-3
2.00 Definition of Operating Status	14-c-4
2.01 Shelf, Slot, Resource	14-c-4
2.02 Port	14-c-4
2.03 Interactions among Devices	14-C-4
2.04 Changes of the Shelf Status	14-c-5
2.05 Changes of the Slot Status	14-C-6
D Self-Test (System-Detected Troubles)	14-D-1
1 .00 Error Record Display	14-D-1
1.01 Start Time of Self-Test	14-D-1
1.02 Error Log	14-D-1
1.03 Printing Out the Automatic Failure Reporting	14-D-1
1.04 Local Alarm	14-D-2
1.05 Remote Alarm	14-D-3
2.00 Clearing System-Detected Troubles	14-D-4
2.01 Introduction	14-D-4
2.02 Consulting the Error Log	14-D-4
2.03 Background Diagnostic Error List	14-D-5
E Troubleshooting Guide	14-E-1
1 .00 Introduction	14-E-1
2.00 Troubleshooting via the LED Indicators	14-E-2
3.00 Troubleshooting via Error Log Records	14-E-4
3.01 Error Log Record List	14-E-4
3.02 System Reset caused by CPU Runaway (Restart Procedure)	14-E-5
3.03 TSW clock down (Internal/External)	14-E-S
3.04 Basic shelf power down (DC)	14-E-7
3.05 Basic shelf power down (AC)	14-E-S

1 .01 System Status screen

Command Format

OPE>SYM1

Device Status (1/4)		ONL MON	
Systemstatus			
ROM Version	V12.00		
Date	May.08	1995	
For Place	Area-2		
CPU RAM	INS		
Basic Shelf	INS		
Expansion Shelf 1	INS		
Expansion Shelf 2			
TSW			
Additional CONF			
S M D R - - - - -	INS		
Clock Mode	External		
Master Clock Card	101		

Description

ROM version	——	Software's version
Date	——	The date software was originated
For Place	——	Destination
CPU RAM	——	Current status of RAM area
Basic Shelf	——	Current status of Basic Shelf
Expansion Shelf 1	——	Current status of Expansion Shelf 1
Expansion Shelf 2	——	Current status of Expansion Shelf 2
TSW	——	Current status of TSW card
Additional CONF	——	Current status of optional Conference card
SMDR	——	Current status of SMDR device
Clock Mode	——	Displayed only when T-I Digital Trunk card is installed.
	•	"External" is displayed when the system synchronizes with the external clock.
		"Internal" is displayed when the system synchronizes with the internal clock .
		Refer to Section 1 O-C-34.02 'System Clock Mode (CLK) ' for further information.
Master Clock Card	——	Displayed only when T-I Digital Trunk card is installed.
		"XXX" (physical card No. of the master card) is displayed when the external clock mode is utilized.
		'- -' is displayed when the internal clock mode is utilized.
		Refer to Section 1 O-C-64.03 'Master Clock Priority (CLP)' for further information.

* In above screen, "—" indicates that the device is not installed.

	Page
3.03 Card Test procedure.....	14-F-5
3.04 Card Test Results screen	14-F-6
4.00 Testing the Ports.....	14-F-7
4.01 Functions to be Verified	14-F-7
4.02 Port Test initial screen	14-F-8
4.03 Port Test procedure	14-F-9
4.04 Port Test Results screen	14-F-10
5.00 Testing PITS and ATT	14-F-11
5.01 Functions to be Verified..	14-F-11
5.02 PITS and ATT Test Initial screen	14-F-12
5.03 PITS and ATT Test procedure	14-F-13
5.04 PITS and ATT Test Results screen..	14-F-14
6.00 Return Messages	14-F-15
G Monitor.....	14-G-1
1.00 Monitor Main Menu screen	14-G-1
2.00 Error Log screen	14-G-2
3.00 Device Status screen..	14-G-3
3.01 System Status Initial screen	14-G-3
3.02 Card Status screen..	14-G-4
3.03 Port Status screen	14-G-5
3.04 Conference Trunk Status screen	14-G-6
4.00 Traffic Submenu screen..	14-G-7
4.01 Station initial Screen	14-G-8
4.02 Trunk Group Initial screen	14-G-9
4.03 Attendant Console Initial screen..	14-G-10
4.04 DISA screen	14-G-11
4.05 OGM 1 screen..	14-G-12
4.06 OGM 2 screen	14-G-13
4.07 AGC screen	14-G-14
H Other Features	14-H-1
1.00 Power Failure Transfer Assignment	14-H-1

2.00 VUP command (Version-up)

Description

Used to initialize the RAM area of the newly added system memory while keeping the current settings intact.

This command is valid when one of the following version of ROM is replaced with a new version of ROM (version **12.XX** and above).

- **V.6.5X,V.8.XX,V.9.XX,V.10.XX**

Command Format

OPE>VUP + old ROM Version No. (**Vxxxx**)* ↵

* If your old ROM version is **V.6.5X** or lower, enter **"V.6.50"**.

If your old ROM version is **V.7.XX**, enter **"V.8.00"**.

Display Example

```
; OPE>VUP V10.50 <CR>
;   V10.50 -> V12.00 version up
;   Are You Sure? (Y; Yes, Other: No) =
;
; OK
; OPE >
```

Conditions

After replacing an old version of ROM with a new version of ROM (Version **12.XX** or higher), "Additional System Memory Initialization" should be done before programming the newly added features. Then newly added system memory is initialized by default values.

Note:

- If you do not execute this operation after replacing the ROM, the system **malfunction** may occur.

72xx	MN	Digital trunk failure	D-Trunk Failure	D-TRK	line trouble (AIS signal reception)
75xx	MN	Digital trunk failure	D-Trunk Failure	D-TRK	line trouble (frame trouble)
80xx	MN	DTMF generator failure	DTMF G. Failure	DTMF G.	
9rxx	MN	DTMF receiver failure	DTMF R. Failure	DTMF R.	
Ayxx	MN	Tone detector failure	Tone Detector	TN DTCT	
Byxx	MN	HDLC failure	HDLC Failure	HDLC	
cyxx	--	Port link failure			
D000	M N	OHCA SW failure	OHCA sw Failure	OHCA SW	
Dyxx	--	OHCA not installed			
FFFF	MN	TSW DTMF G./R. failure	TSW Failure	TSW FLT	

Legend:
MJ-Major Alarm
MN-Minor Alarm

Panasonic

KX-T336 SYSTEM

Programming Forms

Panasonic Company
Division of Matsushita Electric Corporation of America
One Panasonic Way, Secaucus, New Jersey 07094

Panasonic Company (West) of America,
Division of Matsushita Electric Corporation of America
6550 **Katella** Avenue, Cypress, California 90630

Panasonic Sales Company ("**PSC**"),
Division of Matsushita Electric of Puerto Rico, inc.
San Gabriel Industrial Park, 65th Infantry Avenue, KM 9.5, Carolina, P. R. 00630

Printed in Japan

KX - A221
PQQX6488ZA Q069100

3.02 System Reset caused by CPU Runaway (Restart Procedure)

Error Code

0100 = Overflow of the watch dog timer.
0200 = Software Infinite Loop

Possible cause of the malfunction

- 1) External circumstance, such as introduced noise
- 2) Hardware is defective

Countermeasures

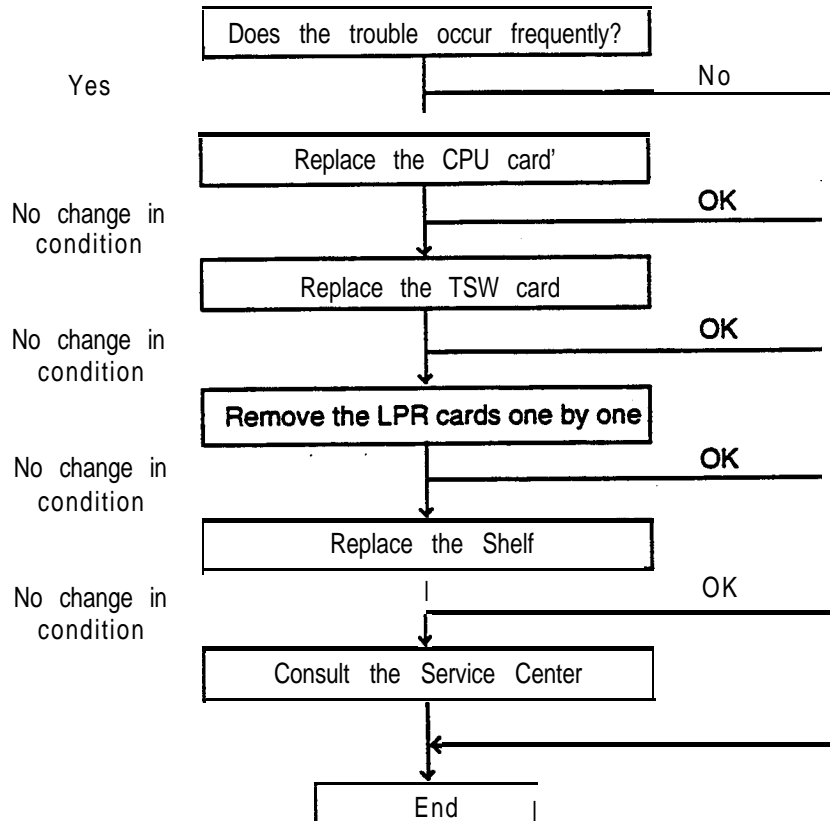

Note

- 1) If a reset occurs 16 times/in one hour due to overflow of the watch dog timer, the restart procedure is not activated and the system will be shut down. Press the **RESET** button to restart the procedure.

. It is recommended to have a current copy of the program on disk or tape to facilitate accurate and rapid recovery.

3.03 TSW clock down (Internal/External)

(1) Internal clock down

Error Code 0300

Possible cause of the malfunction
1) TSW card connection error
2) TSW card clock link failure (Internal)

Countermeasures

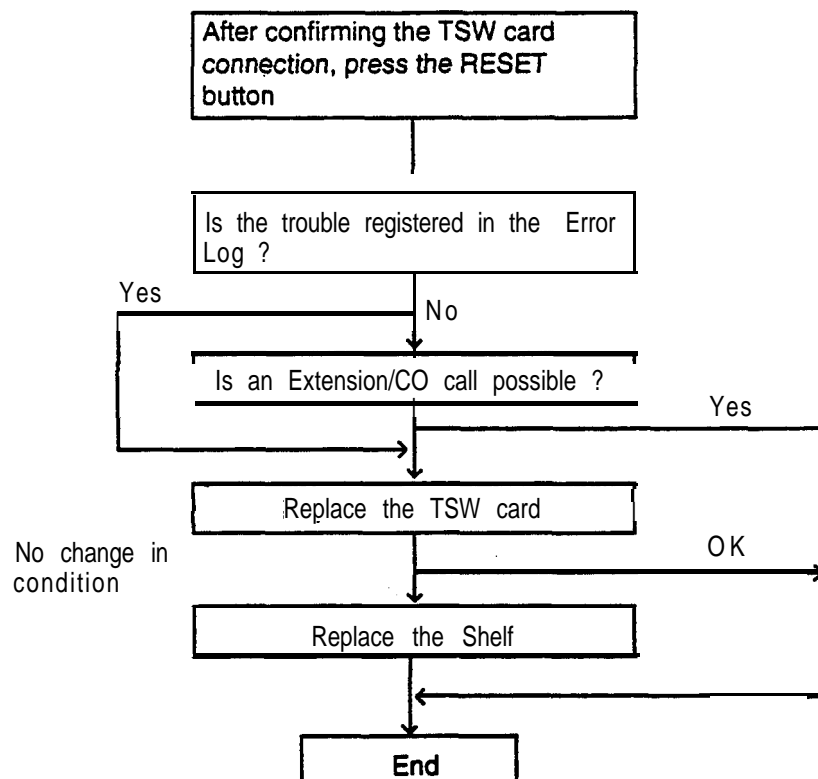

Note

- If the TSW clock malfunction occurs:
- 1) The attendant console does not function.
(Communication to the LPR becomes impossible)
 - 2) Calling becomes impossible
 - 3) Power Failure Transfer will **be** activated

(2) External clock down

Error Code

0301

Possible cause of the malfunction

- 1) TSW card connection error
- 2) TSW card clock link failure (External)
"TSW external clock down" has occurred, and the T-I master card does not synchronize with the clock time sent from the Central office.

Countermeasures

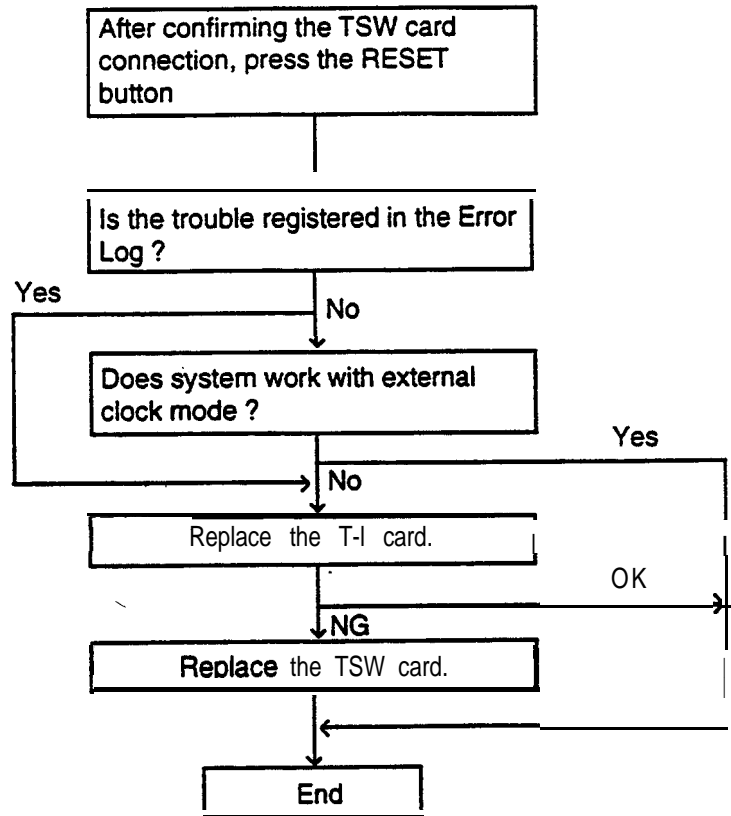

Note

Another T-I card **with** next priority will work as a master card, if more than two T-I cards were registered to the system by CLP command (Refer to Section 64.03) beforehand. **Otherwise**, the system will synchronize with the system internal clock.

Section 15

Maintenance

Dumb Type Terminal

(Section 15)

Maintenance
Dumb Type Terminal
Contents

	Page
A Introduction	15-A-1
B System Administration	15-B-1
1.00 On-site Administration	15-B-1
1.01 Logging in to the System..	15-B-1
1.02 Dumb Operation Mode	15-B-1
2.00 System Administration from a Remote Location	15-B-2
C Device Status	15-c-1
1 .00 Service Commands and Their Functions	15-C-1
1.01 INS (In Service) command	15-C-1
1.02 OUS (Out of Service) command	15-C-2
D Self-Test (System-Detected Troubles)	15-D-1
1.00 Error Record Display	15-D-1
1.01 Start Time of Self-Test	15-D-1
1.02 Error Log.....	15-D-1
1.03 Printing Out the Automatic Failure Reporting	15-D-1
1.04 Local Alarm..	15-D-2
1.05 Remote Alarm	15-D-3
E Functional Test by Entering Commands	15-E-1
1.00 Introduction	15-E-1
2.00 Functions to be Verified	15-E-2
2.01 Card Test	15-E-2
2.02 Port Test	15-E-3
2.03 PITS and ATT Test	15-E-4
3.09 TST command (Test)	15-E-5
3.01 Loopback Test (LBT) – for T-I	15-E-5-1
3.62 DTMF-G/R Diagnosis (DTM) – for T-I	15-E-5-2
4.09 Card Test Results Display	15-E-6
5.00 Port Test Results Display	15-E-7
6.00 PITS and ATT Test Results Display	15-E-6

	Page
F Monitor	15-F-1
1 .00 SYM command (System Maintenance Monitor)	15-F-1
1 .01 System Status screen	15-F-2
1.02 Card Status screen	15-F-3
1.03 Port Status screen	15-F-4
1.04 Conference Trunk Status screen	15-F-5
2.00 TFD command (Traffic Display)	15-F-6
2.01 Station screen	15-F-7
2.02 Trunk Group screen	15-F-8
2.03 Attendant Console screen	15-F-9
2.04 DISA screen	15-F-10
2.05 OGM 1 screen	15-F-11
2.06 OGM 2 screen	15-F-1 2
2.07 AGC screen	15-F-13
G Other Features	15-G-1
1.00 PFT command (Power Failure Transfer)	15-G-1
2.00 VUP command (Version-up)	15-G-3

3.02 DTMF-G/R Diagnosis (DTM) • for T-1

Description

Used to check the validity of DTMF Generators and Receivers on the T1 DIGITAL TRUNK cards. Before executing the test, set the status of the card to "OUS".

Command Format

(1) OPE>DTM + Item1 + Item2 ↵

Operation	Item1	Item2
G/R Status display	STS	101,105,109,201,205,209,301,305,309 (Card No.)
G/R OUS	ous	G xxxyy (Generator No.) or R xxxyy (Receiver No.) xxx : Card No. yy : Generator No. (01 to 06) or Receiver No. (01 to 24)
G/R INS	INS	
G-R Test	TST	101,105,109,201,205,209,301,305,309 (Card No.)

Result Display

G/R status display

```
OPE>DTM STS 101 ↵
DTMF-G 01 02 03 04 05 06
          | 0 . . .
DTMF-R 01 02 03 04 05 06 07 08
          | 0 | | | 0 | 0
DTMF-R 09 10 11 12 13 14 15 16
          . . . . .
DTMF-R 17 18 19 20 21 22 23 24
          . . . . .
```

Indication	Description
	INS (In Service)
0	OUS (Out of Service)
.	Not installed

G/R test results display

```
OPE>DTM TST 101 ↵
DTMF-G 01 02 03 04 05 06
          OK NG . . .
DTMF-R 01 02 03 04 05 06 07 08
          OK OK OK NG OK OK OK NG
DTMF-R 09 10 11 12 13 14 15 16
          . . . . .
DTMF-R 17 18 19 20 21 22 23 24
          . . . . .
```

Indication	Description
OK	Normal
NG	Failure
.	Not installed

3.00 Device Status screen

3.01 System Status Initial screen

Device Status (1/4)		ONL MON
System Status		
ROM Version	V12.00	
Date	May.08 1995	
For Place	Area-2	
CPU RAM	INS	
Basic Shelf	INS	
Expansion Shelf 1	INS	
Expansion Shelf 2		
T S W		
Additional CONF		
SMDR ---	INS	
Clock Mode - - - - -	External	
Master Clock Card-----	101	

1 COMMON 2 3 4 5 6 HRD CPY 7 8.

- Description
- ROM version ——— Software's version
 - Date ——— The date software was originated
 - For Place ——— Destination
 - CPU RAM ——— Current status of RAM area
 - Basic Shelf ——— Current status of Basic Shelf
 - Expansion Shelf 1 ——— Current status of Expansion Shelf 1
 - Expansion Shelf 2 ——— Current status of Expansion Shelf 2
 - TSW ——— Current status of TSW card
 - Additional CONF ——— Current status of optional Conference card
 - SMDR ——— Current status of SMDR device
 - Clock Mode ——— Displayed only when T-I Digital Trunk card is installed.
 "External" is displayed when the system synchronizes with the external clock.
 'Internal' is displayed when the system synchronizes with the internal clock.
 Refer to Section 1 **O-C-64.02 'System Clock Mode (CLK)'** for further information.
 - Master Clock Card ——— Displayed only when T-I Digital Trunk card is installed.
 "XXX" (physical card No. of the master card) is displayed when the external **clock mode** is utilized.
 "—" is displayed when the internal clock mode is utilized.
 Refer to Section 1 **O-C-64.03 "Master Clock Priority (CLP)'** for further information.

* In above screen, "—" indicates that the device is not installed.

3.02 Card Status screen

Device Status (2/4)				IONL MONI							
Card Status											
Basic Shelf	01	PLC		Expansion Shelf 1	01	PLC	F	Expansion Shelf 2	01	LCOT	0
	02	PLC			02	PLC	F		02	LCOT	0
	03	PLC			03	PLC	F		03	LCOT	0
	04	PLC			04	PLC	F		04	LCOT	0
	05	PLC			05	PLC	F		05	LCOT	0
	06	PLC			06	PLC	F		06	LCOT	0
	07	PLC			07	PLC	F		07	LCOT	0
	08	PLC			08	PLC	F		08	LCOT	0
	09	PLC			09	PLC	F		09	LCOT	0
	10	PLC			10	PLC	F		10	LCOT	0
	11	PLC			11	PLC	F		11	LCOT	0
	12	PLC			12	LCOT	F		12	LCOT	0
B2	OHCA	F	13	LCOT	F	13	ATLC	0			
B3	TSW		14	LCOT	F	14	DPH	0			
			15	LCOT	F	15	RMT	0			

I: In Service, O: Out of Service, F: Fault

COMMON 2' 3' 4' 5 6 HRD CPY 7 8

Description

In the above screen, a blank indicates that a card is not installed in the slot.

3.35 Digital trunk failure (out of synchronization)

Error Code

70xx xx=01 to 42 : Slot number

Possible cause of the malfunction

T-1 card (physical number xx) lost the synchronization with the clock time sent from the Central Office.

Countermeasures

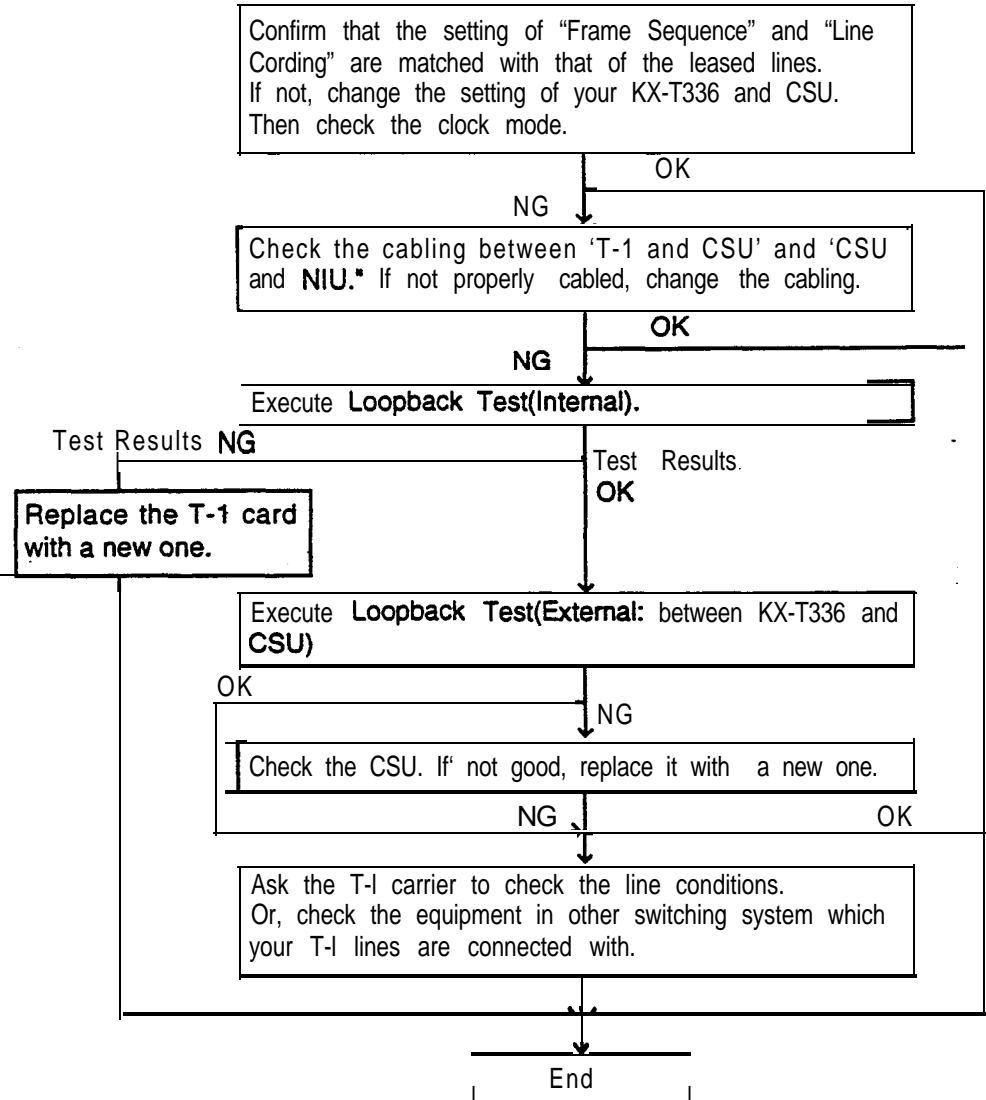

Note

Another T-1 card with next priority will work as a master card, if more than two T-1 cards were registered to the system by **CLP** command (Refer to Section 64.03) beforehand. Otherwise, the system will synchronize with the system internal clock.

3.36 Digital trunk failure (RAI signal reception)

Error Code	71xx xx=01 to 42 : Slot number
Possible Cause of the malfunction	T-1 card (physical number xx) received the RAI (Remote Alarm indication) signal sent from the Central Office.
Countermeasures	Ask the T-1 carrier to check the line conditions. Or, check the equipment in other switching system which your T-1 lines are connected with.
Note	None

3.37 Digital trunk failure (AIS signal reception)

Error Code

72xx xx=01 to 42 : Slot number

Possible cause of the malfunction

T-1 card (physical number xx) received the AIS (Alarm Indication Signal) signal from the Central Office.

Countermeasures

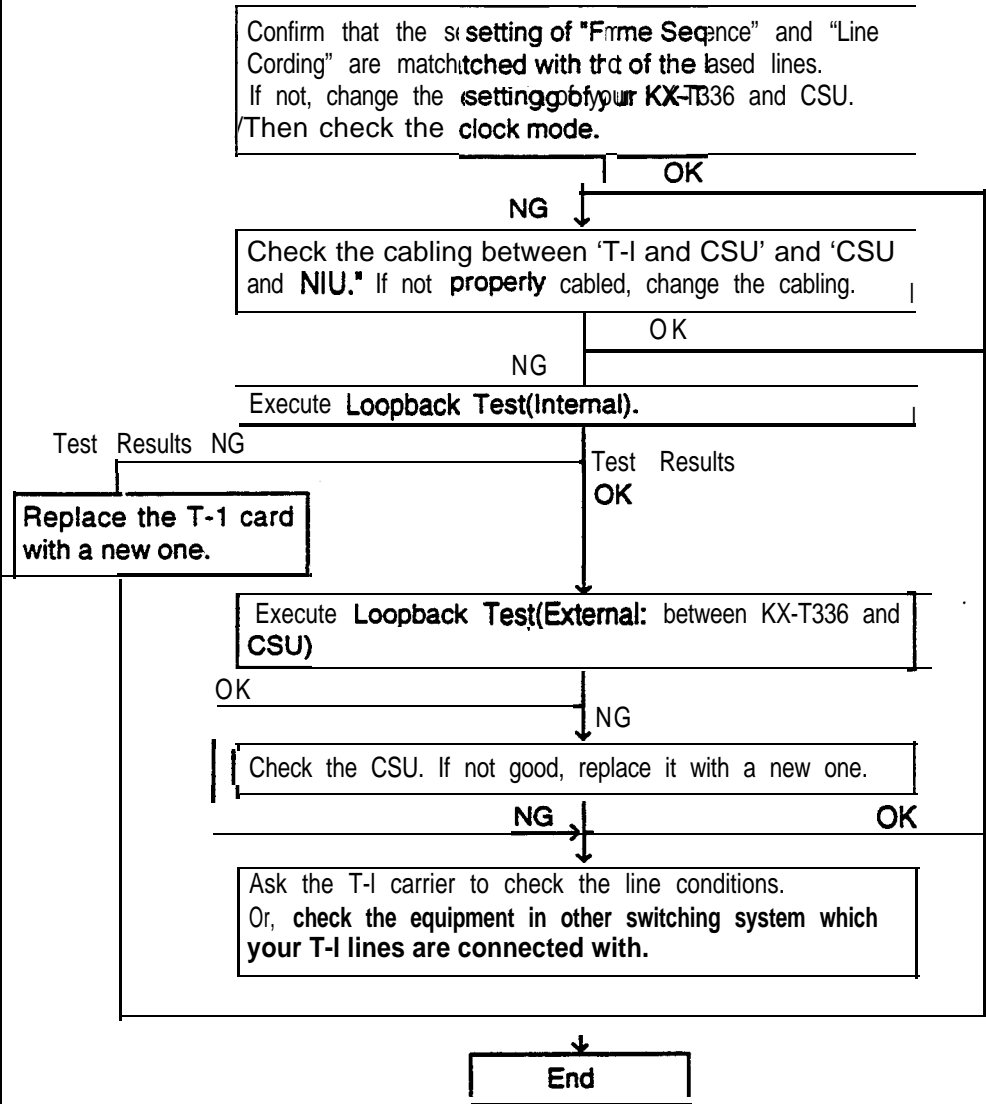

Note

Another T-1 card with next priority will work as a master card, if more than **two T-1 cards were registered to the system by CLP command (Refer to Section 64.03)** beforehand. Otherwise, the system will synchronize with the **system internal clock**.

3.38 Digital trunk failure (frame trouble)

Error Code

75xx xx=01 to 42 : Slot number

Possible cause of the malfunction

On booting-up of T-I card (physical number xx), it failed to synchronize with the clock time sent from the Central Office.

Countermeasures

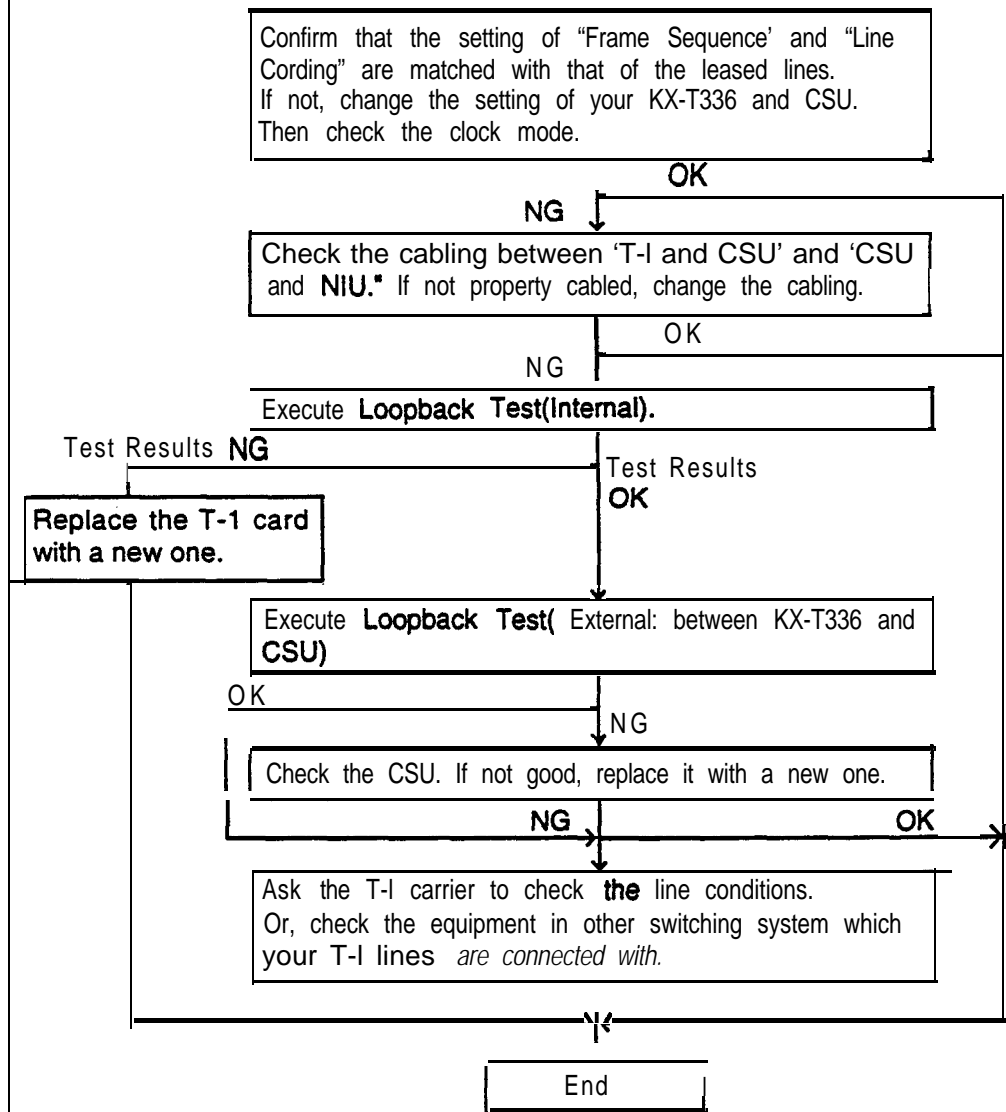

Note

Another T-I card with next priority will work as a master card, if more than two T-I cards were registered to the system by CLP command (Refer to Section 64.03) beforehand. Otherwise, the system will synchronize with the system internal clock.

3.04 Basic shelf power down (DC)

Error Code

0400

Possible cause of the malfunction

- 1) AC power cord is unplugged
- 2) Power Failure
- 3) Power Switch is turned off
- 4) Malfunction in the Power Supply Unit of the Basic Shelf, or the trouble with the Power Supply System (Backboard, CPU card) of the Shelf

Countermeasures

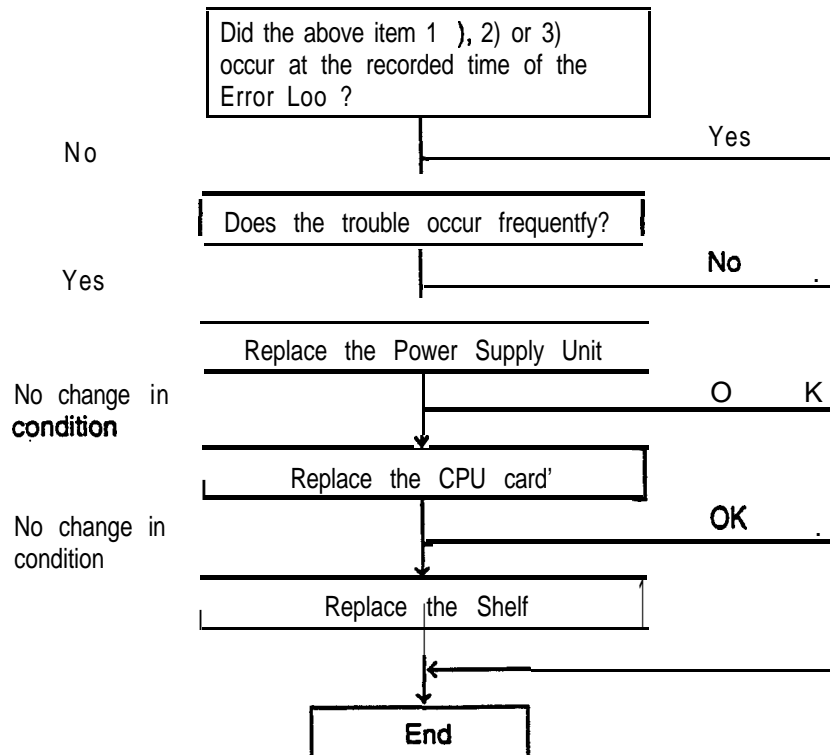

Note

- It is recommended to have a current copy of the program on disk or tape to facilitate accurate and rapid recovery.

1 .01 System Status screen

Command Format

OPE>SYM 1

Device status (1/4)		ONL MON
system status		
ROM Version -----	V12.00	
Date -----	May.08 1995	
For Place -----	Area-2	
CPU RAM -----	INS	
Basic Shelf -----	INS	
Expansion Shelf 1 -----	INS	
Expansion Shelf 2 -----		
TSW		
Addii CONF -----		
SMDR -----	INS	
Clock Mode -----	External	
Master Clock Card -----	101	

Description

ROM version	-----	Software's version
Date	-----	The date software was originated
For Place	-----	Destination
CPU RAM	-----	Current status of RAM area
Basic Shelf	-----	Current status of Basic Shelf
Expansion Shelf 1	-----	Current status of Expansion Shelf 1
Expansion Shelf 2	-----	Current status of Expansion Shelf 2
TSW	-----	Current status of TSW card
Additional CONF	-----	Current status of optional Conference card
SMDR	-----	Current status of SMDR device
Clock Mode	-----	Displayed only when T-I Digital Trunk card is installed. 'External' is displayed when the system synchronizes with the external clock. 'Internal' is displayed when the system synchronizes with the internal clock. Refer to Section 1 O-C-64.02 'System Clock Mode (CLK)' for further information.
Master Clock Card	-----	Displayed only when T-I Digital Trunk card is installed. "XXX" (physical card No. of the master card) is displayed when the external clock mode is utilized. '--' is displayed when the internal clock mode is utilized . Refer to Section 1 O-C-64.03 'Master Clock Priority (CLP) ' for further information.

* In above screen, "--" indicates that the device is not installed.

1.02 Card Status screen

Command **Format**

OPE>SYM 2 ↓

Device Status (2/4)				ONL MON							
Card Status											
Basic Shelf	01	PLC		Expansion Shelf 1	01	PLC	F	Expansion Shelf 2	01	LCOT	0
	02	PLC			02	PLC	F		02	LCOT	0
	03	PLC			03	PLC	F		03	LCOT	0
	04	PLC			04	PLC	F		04	LCOT	0
	05	PLC			05	PLC	F		05	LCOT	0
	06	PLC			06	PLC	F		06	LCOT	0
	07	PLC			07	PLC	F		07	LCOT	0
	08	PLC			08	PLC	F		08	LCOT	0
	09	PLC			09	PLC	F		09	LCOT	0
	10	PLC			10	PLC	F		10	LCOT	0
	11	PLC			11	PLC	F		11	LCOT	0
	12	PLC			12	LCOT	F		12	LCOT	0
	B2	OHCA	F	13	LCOT	F	13	ATLC	0		
B3	TSW		14	LCOT	F	14	DPH	0			
			15	LCOT	F	15	RMT	0			
I: In Service, O: Out of Service, F: Fault											

Description

In the above screen, a blank indicates that a card is not installed in the slot.

2.00 VUP command (Version-up)

Description

Used to initialize the RAM area of the newly added system memory while keeping the current settings intact.

This command is valid when one of the following version of ROM is replaced with a new version of ROM (version 1 **2.XX** and above).

. **V.6.5X,V.8.XX,V.9.XX,V.10.XX**

Command Format

OPE>VUP + old ROM Version No. (Vxxxx)* J

. If your old ROM version is **V.6.5X** or lower, enter **"V.6.50"**.

If your old ROM version is **V.7.XX**, enter **"V.8.00"**.

Display Example

```
; OPE>VUP V10.50 <CR>
; V10.50 -> V12.00 version up
; Are You Sure? (Y; Yes, Other: No) =
;
; OK
; OPE >
```

Conditions

After replacing an old version of ROM with a new version of ROM (Version **12.XX** or higher), "Additional System Memory initialization" should be done before programming the newly added features. **Then** newly added system memory is initialized by default values.

Note:

- If you do not execute this operation after replacing the ROM, the system malfunction may occur.

Panasonic

KX-T336 SYSTEM

Programming Forms

Panasonic Company
Division of Matsushita Electric Corporation of America
One Panasonic Way, Secaucus, New Jersey 07094

Panasonic Company (West) of America,
Division of Matsushita Electric Corporation of America
6550 Katella Avenue, Cypress, California 90630

Panasonic Sales Company ("PSC"),
Division of Matsushita Electric of Puerto Rico, inc.
San Gabriel Industrial Park, 65th Infantry Avenue, KM 9.5, Carolina, P. R. 00630

Printed in Japan

KX - A221
PQQX6488ZA Q069100

1. Panasonic KX-T336 System Installation

2. Configuration

CONFIGURATION-SYSTEM ASSIGNMENT

Version 1.0

Item	Set Data	Default Value
Expansion Shelf	<input type="checkbox"/> No <input type="checkbox"/> 1 Shelf <input type="checkbox"/> 2 Shelves	Automatic set
TSW Additional CONF	<input type="checkbox"/> Yes CI No	Automatic set

CONFIGURATION-SLOT ASSIGNMENT (1/3)

Item	Slot No.	Set Data	Default Value
Basic Shelf	FS 01	<input type="checkbox"/> Blank, <input type="checkbox"/> PLC, <input type="checkbox"/> HLC, <input type="checkbox"/> SLC, <input type="checkbox"/> LCOT, <input type="checkbox"/> GCOT, <input type="checkbox"/> DID, <input type="checkbox"/> AGC, <input type="checkbox"/> DISA, <input type="checkbox"/> OPX, <input type="checkbox"/> ATLC, <input type="checkbox"/> DPH, <input type="checkbox"/> RMT	Automatic set
	FS 02	<input type="checkbox"/> Blank, <input type="checkbox"/> PLC, <input type="checkbox"/> HLC, <input type="checkbox"/> SLC, <input type="checkbox"/> LCOT, <input type="checkbox"/> GCOT, <input type="checkbox"/> DID, <input type="checkbox"/> AGC, <input type="checkbox"/> DISA, <input type="checkbox"/> OPX, <input type="checkbox"/> ATLC, <input type="checkbox"/> DPH, <input type="checkbox"/> RMT	Automatic set
	FS 03	<input type="checkbox"/> Blank, <input type="checkbox"/> PLC, <input type="checkbox"/> HLC, <input type="checkbox"/> SLC, <input type="checkbox"/> LCOT, <input type="checkbox"/> IGCOT, <input type="checkbox"/> DID, <input type="checkbox"/> AGC, <input type="checkbox"/> DISA, <input type="checkbox"/> OPX, <input type="checkbox"/> ATLC, <input type="checkbox"/> IDPH, <input type="checkbox"/> IRMT	Automatic set
	FS 04 i	<input type="checkbox"/> Blank, <input type="checkbox"/> PLC, <input type="checkbox"/> HLC, <input type="checkbox"/> SLC, <input type="checkbox"/> LCOT, <input type="checkbox"/> GCOT, <input type="checkbox"/> DID, <input type="checkbox"/> AGC, <input type="checkbox"/> DISA, <input type="checkbox"/> OPX, <input type="checkbox"/> ATLC, <input type="checkbox"/> IDPH, <input type="checkbox"/> IRMT	Automatic set
	FS 05	<input type="checkbox"/> Blank, <input type="checkbox"/> PLC, <input type="checkbox"/> HLC, <input type="checkbox"/> SLC, <input type="checkbox"/> LCOT, <input type="checkbox"/> GCOT, <input type="checkbox"/> DID, <input type="checkbox"/> AGC, <input type="checkbox"/> DISA, <input type="checkbox"/> OPX, <input type="checkbox"/> ATLC, <input type="checkbox"/> DPH, <input type="checkbox"/> IRMT	Automatic set
	FS 06	<input type="checkbox"/> Blank, <input type="checkbox"/> PLC, <input type="checkbox"/> HLC, <input type="checkbox"/> SLC, <input type="checkbox"/> LCOT, <input type="checkbox"/> GCOT, <input type="checkbox"/> DID, <input type="checkbox"/> AGC, <input type="checkbox"/> DISA, <input type="checkbox"/> OPX, <input type="checkbox"/> ATLC, <input type="checkbox"/> DPH, <input type="checkbox"/> JRMT	Automatic set
	FS 07	<input type="checkbox"/> Blank, <input type="checkbox"/> PLC, <input type="checkbox"/> HLC, <input type="checkbox"/> SLC, <input type="checkbox"/> LCOT, <input type="checkbox"/> GCOT, <input type="checkbox"/> DID, <input type="checkbox"/> AGC, <input type="checkbox"/> DISA, <input type="checkbox"/> OPX, <input type="checkbox"/> ATLC, <input type="checkbox"/> DPH, <input type="checkbox"/> RMT	Automatic set
	FS 08	<input type="checkbox"/> Blank, <input type="checkbox"/> PLC, <input type="checkbox"/> HLC, <input type="checkbox"/> SLC, <input type="checkbox"/> LCOT, <input type="checkbox"/> IGCOT, <input type="checkbox"/> DID, <input type="checkbox"/> AGC, <input type="checkbox"/> DISA, <input type="checkbox"/> OPX, <input type="checkbox"/> ATK, <input type="checkbox"/> IDPH, <input type="checkbox"/> RMT	Automatic set
	FS 09	<input type="checkbox"/> Blank, <input type="checkbox"/> PLC, <input type="checkbox"/> HLC, <input type="checkbox"/> SLC, <input type="checkbox"/> LCOT, <input type="checkbox"/> GCOT, <input type="checkbox"/> DID, <input type="checkbox"/> AGC, <input type="checkbox"/> JDISA, <input type="checkbox"/> OPX, <input type="checkbox"/> ATLC, <input type="checkbox"/> DPH, <input type="checkbox"/> RMT	Automatic set
	FS 10	<input type="checkbox"/> Blank, <input type="checkbox"/> PLC, <input type="checkbox"/> HLC, <input type="checkbox"/> SLC, <input type="checkbox"/> LCOT, <input type="checkbox"/> GCOT, <input type="checkbox"/> IDID, <input type="checkbox"/> AGC, <input type="checkbox"/> DISA, <input type="checkbox"/> OPX, <input type="checkbox"/> ATK, <input type="checkbox"/> DPH, <input type="checkbox"/> RMT	Automatic set
	FS 11	<input type="checkbox"/> Blank, <input type="checkbox"/> PLC, <input type="checkbox"/> HLC, <input type="checkbox"/> SLC, <input type="checkbox"/> LCOT, <input type="checkbox"/> GCOT, <input type="checkbox"/> IDID, <input type="checkbox"/> AGC, <input type="checkbox"/> DISA, <input type="checkbox"/> OPX, <input type="checkbox"/> ATLC, <input type="checkbox"/> DPH, <input type="checkbox"/> RMT	Automatic set
	FS 12	<input type="checkbox"/> Blank, <input type="checkbox"/> PLC, <input type="checkbox"/> HLC, <input type="checkbox"/> SLC, <input type="checkbox"/> LCOT, <input type="checkbox"/> GCOT, <input type="checkbox"/> DID, <input type="checkbox"/> AGC, <input type="checkbox"/> DISA, <input type="checkbox"/> OPX, <input type="checkbox"/> ATLC, <input type="checkbox"/> IDPH, <input type="checkbox"/> RMT	Automatic set
	BS 01	CPU	
BS 02	OHCA		
BS 03	TSW		

Note: FS select sequence
 "Blank" → PLC → **HLC** → SLC → LCOT → GCOT → DID → AGC → DISA → OPX → ATLC → DPH → RMT

CONFIGURATION-SLOT ASSIGNMENT (2/3)

Item	Slot No.	Set Data	Default Value
Expansion Shell 1	FS 01	<input type="checkbox"/> Blank, <input type="checkbox"/> PLC, <input type="checkbox"/> HLC, <input type="checkbox"/> SLC, <input type="checkbox"/> LCOT, <input type="checkbox"/> GCOT, <input type="checkbox"/> DID, <input type="checkbox"/> AGC, <input type="checkbox"/> DISA, <input type="checkbox"/> OPX, <input type="checkbox"/> ATLC, <input type="checkbox"/> DPH, <input type="checkbox"/> RMT	Automatic set
	FS 02	<input type="checkbox"/> Blank, <input type="checkbox"/> PLC, <input type="checkbox"/> OHLC, <input type="checkbox"/> SLC, <input type="checkbox"/> LCOT, <input type="checkbox"/> GCOT, <input type="checkbox"/> DID, <input type="checkbox"/> AGC, <input type="checkbox"/> DISA, <input type="checkbox"/> OPX, <input type="checkbox"/> ATLC, <input type="checkbox"/> DPH, <input type="checkbox"/> IRMT	Automatic set
	FS 03	<input type="checkbox"/> Blank, <input type="checkbox"/> PLC, <input type="checkbox"/> HLC, <input type="checkbox"/> SLC, <input type="checkbox"/> LCOT, <input type="checkbox"/> GCOT, <input type="checkbox"/> DID, <input type="checkbox"/> AGC, <input type="checkbox"/> DISA, <input type="checkbox"/> OOPX, <input type="checkbox"/> ATLC, <input type="checkbox"/> RMT	Automatic set
	FS 04	<input type="checkbox"/> Blank, <input type="checkbox"/> PLC, <input type="checkbox"/> HLC, <input type="checkbox"/> SLC, <input type="checkbox"/> LCOT, <input type="checkbox"/> GCOT, <input type="checkbox"/> DID, <input type="checkbox"/> AGC, <input type="checkbox"/> DISA, <input type="checkbox"/> OOPX, <input type="checkbox"/> ATLC, <input type="checkbox"/> RMT	Automatic set
	FS 05	<input type="checkbox"/> Blank, <input type="checkbox"/> PLC, <input type="checkbox"/> HLC, <input type="checkbox"/> SLC, <input type="checkbox"/> LCOT, <input type="checkbox"/> GCOT, <input type="checkbox"/> DID, <input type="checkbox"/> AGC, <input type="checkbox"/> DISA, <input type="checkbox"/> OOPX, <input type="checkbox"/> ATLC, <input type="checkbox"/> DPH, <input type="checkbox"/> RMT	Automatic set
	FS 06	<input type="checkbox"/> Blank, <input type="checkbox"/> PLC, <input type="checkbox"/> HLC, <input type="checkbox"/> SLC, <input type="checkbox"/> LCOT, <input type="checkbox"/> GCOT, <input type="checkbox"/> DID, <input type="checkbox"/> AGC, <input type="checkbox"/> DISA, <input type="checkbox"/> OPX, <input type="checkbox"/> OATLC, <input type="checkbox"/> DPH, <input type="checkbox"/> RMT	Automatic set
	FS 07	<input type="checkbox"/> Blank, <input type="checkbox"/> PLC, <input type="checkbox"/> OHLC, <input type="checkbox"/> SLC, <input type="checkbox"/> LCOT, <input type="checkbox"/> GCOT, <input type="checkbox"/> DID, <input type="checkbox"/> AGC, <input type="checkbox"/> DISA, <input type="checkbox"/> OPX, <input type="checkbox"/> ATLC, <input type="checkbox"/> DPH, <input type="checkbox"/> RMT	Automatic set
	FS 08	<input type="checkbox"/> Blank, <input type="checkbox"/> PLC, <input type="checkbox"/> HLC, <input type="checkbox"/> SLC, <input type="checkbox"/> LCOT, <input type="checkbox"/> GCOT, <input type="checkbox"/> DID, <input type="checkbox"/> AGC, <input type="checkbox"/> DISA, <input type="checkbox"/> OPX, <input type="checkbox"/> ATLC, <input type="checkbox"/> DPH, <input type="checkbox"/> RMT	Automatic set
	FS 09	<input type="checkbox"/> Blank, <input type="checkbox"/> PLC, <input type="checkbox"/> HLC, <input type="checkbox"/> SLC, <input type="checkbox"/> LCOT, <input type="checkbox"/> GCOT, <input type="checkbox"/> DID, <input type="checkbox"/> AGC, <input type="checkbox"/> DISA, <input type="checkbox"/> OPX, <input type="checkbox"/> OATLC, <input type="checkbox"/> DPH, <input type="checkbox"/> RMT	Automatic set
	FS 10	<input type="checkbox"/> Blank, <input type="checkbox"/> PLC, <input type="checkbox"/> HLC, <input type="checkbox"/> SLC, <input type="checkbox"/> LCOT, <input type="checkbox"/> GCOT, <input type="checkbox"/> DID, <input type="checkbox"/> AGC, <input type="checkbox"/> DISA, <input type="checkbox"/> OPX, <input type="checkbox"/> OATLC, <input type="checkbox"/> DPH, <input type="checkbox"/> RMT	Automatic set
	FS 11	<input type="checkbox"/> Blank, <input type="checkbox"/> PLC, <input type="checkbox"/> HLC, <input type="checkbox"/> SLC, <input type="checkbox"/> LCOT, <input type="checkbox"/> GCOT, <input type="checkbox"/> ODID, <input type="checkbox"/> AGC, <input type="checkbox"/> DISA, <input type="checkbox"/> OPX, <input type="checkbox"/> ATLC, <input type="checkbox"/> DPH, <input type="checkbox"/> RMT	Automatic set
	FS 12	<input type="checkbox"/> Blank, <input type="checkbox"/> PLC, <input type="checkbox"/> HLC, <input type="checkbox"/> SLC, <input type="checkbox"/> LCOT, <input type="checkbox"/> GCOT, <input type="checkbox"/> DID, <input type="checkbox"/> AGC, <input type="checkbox"/> DISA, <input type="checkbox"/> OPX, <input type="checkbox"/> ATLC, <input type="checkbox"/> DPH, <input type="checkbox"/> RMT	Automatic set
	FS 13	<input type="checkbox"/> Blank, <input type="checkbox"/> PLC, <input type="checkbox"/> OHLC, <input type="checkbox"/> SLC, <input type="checkbox"/> LCOT, <input type="checkbox"/> GCOT, <input type="checkbox"/> DID, <input type="checkbox"/> AGC, <input type="checkbox"/> DISA, <input type="checkbox"/> OPX, <input type="checkbox"/> ATLC, <input type="checkbox"/> DPH, <input type="checkbox"/> RMT	Automatic set
	FS 14	<input type="checkbox"/> Blank, <input type="checkbox"/> PLC, <input type="checkbox"/> OHLC, <input type="checkbox"/> SLC, <input type="checkbox"/> LCOT, <input type="checkbox"/> GCOT, <input type="checkbox"/> DID, <input type="checkbox"/> AGC, <input type="checkbox"/> DISA, <input type="checkbox"/> OPX, <input type="checkbox"/> mc, <input type="checkbox"/> DPH, <input type="checkbox"/> RMT	Automatic set
	FS 15	<input type="checkbox"/> Blank, <input type="checkbox"/> PLC, <input type="checkbox"/> HLC, <input type="checkbox"/> SLC, <input type="checkbox"/> LCOT, <input type="checkbox"/> GCOT, <input type="checkbox"/> DID, <input type="checkbox"/> AGC, <input type="checkbox"/> DISA, <input type="checkbox"/> OPX, <input type="checkbox"/> ATLC, <input type="checkbox"/> DPH, <input type="checkbox"/> RMT	Automatic set

CONFIGURATION-SLOT ASSIGNMENT (3/3)

Item	Slot No.	Set Data	Default Value
Expansion Shelf 2	FS 01	<input type="checkbox"/> Blank.1 PLC. <input type="checkbox"/> HLC, <input type="checkbox"/> SLC, <input type="checkbox"/> LCOT, <input type="checkbox"/> GCOT, <input type="checkbox"/> DID, <input type="checkbox"/> AGC, <input type="checkbox"/> DISA, <input type="checkbox"/> OPX, CATLC, <input type="checkbox"/> DPH, <input type="checkbox"/> RMT	Automatic set
	FS 02	<input type="checkbox"/> Blank, <input type="checkbox"/> PLC, <input type="checkbox"/> HLC, <input type="checkbox"/> SLC, <input type="checkbox"/> LCOT, <input type="checkbox"/> IGCOT, <input type="checkbox"/> DID, <input type="checkbox"/> AGC, <input type="checkbox"/> DISA, <input type="checkbox"/> OPX, CATLC, <input type="checkbox"/> DPH, <input type="checkbox"/> IRMT	Automatic set
	FS 03	<input type="checkbox"/> Blank, <input type="checkbox"/> PLC, <input type="checkbox"/> HLC, <input type="checkbox"/> SLC, <input type="checkbox"/> LCOT, <input type="checkbox"/> GCOT, <input type="checkbox"/> DID, <input type="checkbox"/> AGC, <input type="checkbox"/> DISA, <input type="checkbox"/> OPX, <input type="checkbox"/> ATLC, <input type="checkbox"/> DPW, <input type="checkbox"/> IRMT	Automatic set
	FS 04	<input type="checkbox"/> Blank.0 PLC, <input type="checkbox"/> HLC, <input type="checkbox"/> SLC, <input type="checkbox"/> LCOT, <input type="checkbox"/> GCOT, <input type="checkbox"/> IDID, <input type="checkbox"/> AGC, <input type="checkbox"/> DISA, <input type="checkbox"/> OPX, CATLC, <input type="checkbox"/> IDPH, <input type="checkbox"/> RMT	Automatic set
	FS 05	<input type="checkbox"/> Blank, <input type="checkbox"/> PLC, <input type="checkbox"/> HLC, <input type="checkbox"/> SLC, <input type="checkbox"/> LCOT, <input type="checkbox"/> GCOT, <input type="checkbox"/> IDID, <input type="checkbox"/> AGC, <input type="checkbox"/> DISA, <input type="checkbox"/> OPX, <input type="checkbox"/> ATLC, <input type="checkbox"/> IDW, <input type="checkbox"/> IRMT	Automatic set
	FS 06	<input type="checkbox"/> Blank, <input type="checkbox"/> PLC, <input type="checkbox"/> HLC, <input type="checkbox"/> SLC, <input type="checkbox"/> LCOT, <input type="checkbox"/> GCOT, <input type="checkbox"/> IDID, <input type="checkbox"/> AGC, <input type="checkbox"/> DISA, <input type="checkbox"/> OPX, <input type="checkbox"/> ATLC, <input type="checkbox"/> IDPH, <input type="checkbox"/> IRMT	Automatic set
	FS 07	<input type="checkbox"/> Blank, <input type="checkbox"/> PLC, <input type="checkbox"/> HLC, <input type="checkbox"/> SLC, <input type="checkbox"/> LCOT, <input type="checkbox"/> GCOT, <input type="checkbox"/> DID, <input type="checkbox"/> AGC, <input type="checkbox"/> DISA, <input type="checkbox"/> OPX, <input type="checkbox"/> ATLC, <input type="checkbox"/> DPH, <input type="checkbox"/> IRMT	Automatic set
	FS 08	<input type="checkbox"/> Blank, <input type="checkbox"/> PLC, <input type="checkbox"/> HLC, <input type="checkbox"/> SLC, <input type="checkbox"/> LCOT, <input type="checkbox"/> JGCOT, <input type="checkbox"/> DID, <input checked="" type="checkbox"/> AGC, <input type="checkbox"/> DISA, <input type="checkbox"/> IATLC, <input type="checkbox"/> IDPH, <input type="checkbox"/> RMT	Automatic set
	FS 09	<input type="checkbox"/> Blank, <input type="checkbox"/> PLC, <input type="checkbox"/> HLC, <input type="checkbox"/> SLC, <input type="checkbox"/> LCOT, <input type="checkbox"/> JGCOT, <input type="checkbox"/> DID, <input type="checkbox"/> AGC, <input type="checkbox"/> DISA, <input type="checkbox"/> OPX, <input type="checkbox"/> ATLC, <input type="checkbox"/> WH, <input type="checkbox"/> FIMT	Automatic set
	FS 10	<input type="checkbox"/> Blank, <input type="checkbox"/> PLC, <input type="checkbox"/> HLC, <input type="checkbox"/> SLC, <input type="checkbox"/> LCOT, <input type="checkbox"/> GCOT, <input type="checkbox"/> DID, <input type="checkbox"/> AGC, <input type="checkbox"/> WSA, <input type="checkbox"/> opx, <input type="checkbox"/> ATLC, <input type="checkbox"/> DPH, <input type="checkbox"/> RMT	Automatic set
	FS 11	<input type="checkbox"/> Blank, <input type="checkbox"/> PLC, <input type="checkbox"/> HLC, <input type="checkbox"/> SLC, <input type="checkbox"/> LCOT, <input type="checkbox"/> IGCOT, <input type="checkbox"/> IDID, <input type="checkbox"/> AGC, <input type="checkbox"/> DISA, <input type="checkbox"/> ATLC, <input type="checkbox"/> DPH, <input type="checkbox"/> RMT	Automatic set
	FS 12	<input type="checkbox"/> Blank, <input type="checkbox"/> PLC, <input type="checkbox"/> HLC, <input type="checkbox"/> SLC, <input type="checkbox"/> LCOT, <input type="checkbox"/> IGCOT, <input type="checkbox"/> IDID, <input type="checkbox"/> AGC, <input type="checkbox"/> DISA, <input type="checkbox"/> ATLC, <input type="checkbox"/> DPH, <input type="checkbox"/> RMT	Automatic set
	FS 13	<input type="checkbox"/> Blank.0 PLC, <input type="checkbox"/> HLC, <input type="checkbox"/> ISLC, <input type="checkbox"/> LCOT, <input type="checkbox"/> JGCOT, <input type="checkbox"/> DID, <input type="checkbox"/> AGC, <input type="checkbox"/> DISA, <input type="checkbox"/> OPX, <input type="checkbox"/> ATLC, <input type="checkbox"/> DPH, <input type="checkbox"/> RMT	Automatic set
	FS 14	<input type="checkbox"/> Blank, <input type="checkbox"/> PLC, <input type="checkbox"/> HLC, <input type="checkbox"/> SLC, <input type="checkbox"/> LCOT, <input type="checkbox"/> GCOT, <input type="checkbox"/> DID, <input type="checkbox"/> AGC, <input type="checkbox"/> DISA, <input type="checkbox"/> ATLC, <input type="checkbox"/> IDPH, <input type="checkbox"/> RMT	Automatic set
	FS 15	<input type="checkbox"/> Blank, <input type="checkbox"/> PLC, <input checked="" type="checkbox"/> HLC, <input type="checkbox"/> ISLC, <input type="checkbox"/> LCOT, <input type="checkbox"/> GCOT, <input type="checkbox"/> DID, <input type="checkbox"/> AGC, <input type="checkbox"/> DISA, <input type="checkbox"/> OPX, <input type="checkbox"/> ATLC, <input type="checkbox"/> DPH, <input type="checkbox"/> RMT	Automatic set

CONFIGURATION-DN ASSIGNMENT (114)

2-5

Card Type										
Slot No.										
Port No.	Set Data									
	DN	DN.	DN	DN	DN	DN	DN	DN	DN	DN
1										
2										
3										
4										
5										
6										
7										
8										

Note:

Item	Selection of Value	Default Value
Card Type	SLC, PLC, HLC, OPX	Automatic set
Slot No	3 digits	Automatic set
DN.	3 or 4-digit DN, blank	100 to 387

CONFIGURATION-DN ASSIGNMENT (214)

Card Type										
Slot No.										
Port No.	Set Data.									
	DN	DN	DN	DN	DN	DN	DN	DN	DN	DN
1										
2										
3										
4										
5										
6										
7										
8										

CONFIGURATION-DN ASSIGNMENT (3/4)

Card Type										
Slot No.										
Port No.	Set Data									
	DN	DN	DN	DN	DN	DN	DN	DN	DN	DN
1										
2										
3										
4										
5										
6										
7										
8										

Card Type						
Slot No.						
Port No.	Set Data					
	DN	DN	DN	DN	DN	DN
1						
2						
3						
4						
5						
6						
7						
8						

SYSTEM-OPERATION (1/2)

	Set Data	Default Value
	Yes. <input type="checkbox"/> No	No
te Selection	Yes <input type="checkbox"/> No	No
n	<input type="checkbox"/> Flex, <input type="checkbox"/> Fixed 1, <input type="checkbox"/> Fixed 2	Fixed 1
Key	<input type="checkbox"/> Yes, <input type="checkbox"/> No	Yes
el—Operator	- - <u> </u> (2 digits: 01 to 16)	01
el—Internationa	- - <u> </u> (2 digits: 01 to 16)	01
Plan	<input type="checkbox"/> Type A (Toll call) 1 +NPA+NXX+XXXX (Local call) NXX+XXXX <input type="checkbox"/> Type B (Toll call) NPA+NXX+XXXX (Local call) NNX+XXXX <input type="checkbox"/> Type C (Toll call) 1+NPA+NXX+XXXX, 1+NNX+XXXX (Local call) NNX+XXXX	Type-A
l Mode	c With Transfer, <input type="checkbox"/> Without Transfer	With Transfer
	<input type="checkbox"/> Tone-1, <input type="checkbox"/> Tone-2	Tone-2
nder	c Yes, <input type="checkbox"/> No	Yes
bsy-ovribrg-in	c Yes, <input type="checkbox"/> No	Yes
g 1	<input type="checkbox"/> Yes, <input type="checkbox"/> No	Yes
g 2	<input type="checkbox"/> Yes, <input type="checkbox"/> No	Yes
Source 1	c Yes, <input type="checkbox"/> No	Yes
Source 2	c Yes, <input type="checkbox"/> <input type="checkbox"/>	Yes
rence	<input checked="" type="checkbox"/> DN, <input type="checkbox"/> CO	DN
al Operator Call	<input type="checkbox"/> <input type="checkbox"/> <input type="checkbox"/> <input type="checkbox"/> <input type="checkbox"/> <input type="checkbox"/> <input type="checkbox"/> <input type="checkbox"/> (3 or 4 digits: 000 to 9999), <input type="checkbox"/> blank	blank
stration Device	<input type="checkbox"/> VT220, <input type="checkbox"/> Dumb, <input type="checkbox"/> ATT1, <input type="checkbox"/> ATT2	Automatic set
	c Yes, <input type="checkbox"/> No	No
	- - <u> </u> (1 or 2 digits: 4 to 99)	blank
	- - <u> </u> (1 or 2 digits: 0 to 95)	blank
tion Log	<input type="checkbox"/> All Call, <input type="checkbox"/> Toll Only, <input type="checkbox"/> No	blank
tion Log	<input type="checkbox"/> Yes, <input type="checkbox"/> <input type="checkbox"/>	blank
ition	<input type="checkbox"/> Separate, <input type="checkbox"/> Summary	blank.
Name	<input type="checkbox"/> Default, <input type="checkbox"/> User Name, <input type="checkbox"/> Dial No.	blank

SYSTEM-OPERATION (212)

Item	Set Data	Default Value																								
Print Secret Dial	<input type="checkbox"/> Yes, <input type="checkbox"/> No	blank																								
Error Log	<input type="checkbox"/> Yes, <input type="checkbox"/> No	blank																								
Programming	<input type="checkbox"/> Yes, <input type="checkbox"/> No	blank																								
Traffic	<input type="checkbox"/> Yes, <input type="checkbox"/> No	blank																								
Start Time of Traffic Measurement	<input type="checkbox"/> AM, <input type="checkbox"/> PM (hour: 1 to 12, minute: 00 to 59) <input type="checkbox"/> blank	blank																								
Start Time of Test	- - - - @AM, <input type="checkbox"/> PM (hour: 1 to 12, minute: 00 to 59) <input type="checkbox"/> blank	blank																								
Remote Directory Number	- - - - (3 or 4 digits), <input type="checkbox"/> blank	with RMT: 399 without RMT: blank																								
Remote Alarm	<input type="checkbox"/> Yes, <input type="checkbox"/> No	No																								
Destination Address	<input type="checkbox"/> blank (Max. 26 digits)	blank																								
Operator 1	<input type="checkbox"/> ATT1, <input type="checkbox"/> All-2 <input type="checkbox"/> EXT → (3 or 4-digit D N) <input type="checkbox"/> None	with ATLC: ATT1 without ATLC: EXT 100																								
Operator 2	<input type="checkbox"/> ATT1, <input type="checkbox"/> ATT2 <input type="checkbox"/> EXT → (3 or 4-digit D N) <input type="checkbox"/> None	with ATLC: ATT2 without ATLC: None																								
Night Service	<input type="checkbox"/> Manual <input type="checkbox"/> Auto	Manual																								
Auto Start Time	<table border="1" style="width: 100%; border-collapse: collapse;"> <thead> <tr> <th></th> <th style="text-align: center;">Day Mode</th> <th style="text-align: center;">Night Mode</th> </tr> </thead> <tbody> <tr> <td>MON.</td> <td> <input type="checkbox"/> AM, <input type="checkbox"/> PM </td> <td> <input type="checkbox"/> AM, <input type="checkbox"/> PM </td> </tr> <tr> <td>TUE.</td> <td> <input type="checkbox"/> AM, <input type="checkbox"/> PM </td> <td> <input type="checkbox"/> AM, <input type="checkbox"/> PM </td> </tr> <tr> <td>WED.</td> <td> <input type="checkbox"/> AM, <input type="checkbox"/> PM </td> <td> <input type="checkbox"/> AM, <input type="checkbox"/> PM </td> </tr> <tr> <td>THU.</td> <td> <input type="checkbox"/> AM, <input type="checkbox"/> PM </td> <td> <input type="checkbox"/> AM, <input type="checkbox"/> PM </td> </tr> <tr> <td>FRI.</td> <td> <input type="checkbox"/> AM, <input type="checkbox"/> PM </td> <td> <input type="checkbox"/> AM, <input type="checkbox"/> PM </td> </tr> <tr> <td>SAT.</td> <td> <input type="checkbox"/> AM, <input type="checkbox"/> PM </td> <td> <input type="checkbox"/> AM, <input type="checkbox"/> PM </td> </tr> <tr> <td>SUN.</td> <td> <input type="checkbox"/> AM, <input type="checkbox"/> PM </td> <td> <input type="checkbox"/> AM, <input type="checkbox"/> PM </td> </tr> </tbody> </table>		Day Mode	Night Mode	MON.	<input type="checkbox"/> AM, <input type="checkbox"/> PM 	<input type="checkbox"/> AM, <input type="checkbox"/> PM 	TUE.	<input type="checkbox"/> AM, <input type="checkbox"/> PM 	<input type="checkbox"/> AM, <input type="checkbox"/> PM 	WED.	<input type="checkbox"/> AM, <input type="checkbox"/> PM 	<input type="checkbox"/> AM, <input type="checkbox"/> PM 	THU.	<input type="checkbox"/> AM, <input type="checkbox"/> PM 	<input type="checkbox"/> AM, <input type="checkbox"/> PM 	FRI.	<input type="checkbox"/> AM, <input type="checkbox"/> PM 	<input type="checkbox"/> AM, <input type="checkbox"/> PM 	SAT.	<input type="checkbox"/> AM, <input type="checkbox"/> PM 	<input type="checkbox"/> AM, <input type="checkbox"/> PM 	SUN.	<input type="checkbox"/> AM, <input type="checkbox"/> PM 	<input type="checkbox"/> AM, <input type="checkbox"/> PM 	blank
	Day Mode	Night Mode																								
MON.	<input type="checkbox"/> AM, <input type="checkbox"/> PM 	<input type="checkbox"/> AM, <input type="checkbox"/> PM 																								
TUE.	<input type="checkbox"/> AM, <input type="checkbox"/> PM 	<input type="checkbox"/> AM, <input type="checkbox"/> PM 																								
WED.	<input type="checkbox"/> AM, <input type="checkbox"/> PM 	<input type="checkbox"/> AM, <input type="checkbox"/> PM 																								
THU.	<input type="checkbox"/> AM, <input type="checkbox"/> PM 	<input type="checkbox"/> AM, <input type="checkbox"/> PM 																								
FRI.	<input type="checkbox"/> AM, <input type="checkbox"/> PM 	<input type="checkbox"/> AM, <input type="checkbox"/> PM 																								
SAT.	<input type="checkbox"/> AM, <input type="checkbox"/> PM 	<input type="checkbox"/> AM, <input type="checkbox"/> PM 																								
SUN.	<input type="checkbox"/> AM, <input type="checkbox"/> PM 	<input type="checkbox"/> AM, <input type="checkbox"/> PM 																								
PTS Programming Password	- - - - (4 digits), <input type="checkbox"/> blank	1234																								
Walking COS Password	- - - - (4 digits), <input type="checkbox"/> blank	blank																								

SYSTEM-TENANT

Item	Set Data	Default Value			
Operator 1 (Tenant 2)	<input type="checkbox"/> ATT1, <input type="checkbox"/> ATT2 <input type="checkbox"/> EXT → - - - - (3 or 4-digit DN) <input type="checkbox"/> None	None			
Operator 2 (Tenant 2)	<input type="checkbox"/> ATT1, <input type="checkbox"/> ATT2 c EXT → (3 o r 4-digit D N) c None	None			
Night Service (Tenant 2)	<input type="checkbox"/> Manual, <input type="checkbox"/> Auto	Manual			
Auto Start Time (Tenant 2)	<table style="width: 100%; border-collapse: collapse;"> <tr> <td style="width: 33%;"></td> <td style="width: 33%; text-align: center;">Dav Mode</td> <td style="width: 33%; text-align: center;">Night Mode</td> </tr> </table>		Dav Mode	Night Mode	
		Dav Mode	Night Mode		
	MON. -- -- <input type="checkbox"/> AM, <input type="checkbox"/> PM	: -- -- <input type="checkbox"/> AM, <input type="checkbox"/> PM	blank		
	TUE. -- -- <input type="checkbox"/> AM, <input type="checkbox"/> AM, <input type="checkbox"/> PM	-- -- : -- --			
	WED. -- -- <input type="checkbox"/> AM, <input type="checkbox"/> AM, <input type="checkbox"/> PM	-- -- : -- --			
	THU. -- -- <input type="checkbox"/> AM, <input type="checkbox"/> AM, <input type="checkbox"/> PM	-- -- : -- --			
	FRI. -- -- <input type="checkbox"/> AM, <input type="checkbox"/> AM, <input type="checkbox"/> PM	-- -- : -- --			
	SAT. -- -- <input type="checkbox"/> AM, <input type="checkbox"/> PM	<input type="checkbox"/> AM.aPM			
SUN. -- -- <input type="checkbox"/> AM, <input type="checkbox"/> AM, <input type="checkbox"/> PM	-- -- : -- --				
PITS Programming Password (Tenant 2)	-- -- -- (4 digits), <input type="checkbox"/> blank	blank			
Walking COS Password (Tenant 2)	- - - - (4 digits), <input type="checkbox"/> blank	blank			
Inter-Tenant Calling	c Yes. <input type="checkbox"/> No	No			
Speed Dialing-System Boundary	-- -- -- (3 digits: 000 to 200)	200			
Call Park Boundary	-- -- (2 digits: 00 to 20)	20			
Message Waiting Boundary	- - - (3 digits: 000 to 500)	500			
Absent Message Boundary	- - (2 digits: 06 to 16)	16			

SYSTEM-SYSTEM TIMER

Item	Set Data	Default Value
Held Call Reminder	seconds (15 to 240)	60
Held Call Reminder (ATT)	seconds (15 to 240)	60
Transfer Recall	seconds (15 to 240)	30
Pickup Dial Waiting	second(s) (1 to 5)	1
External First Digit Time-out	<u>s e c o n d s</u> (5 to 20)	10
External Interdigit Time-out	- - seconds (3 to 15)	5
External Interdigit Time-out (PBX)	- - seconds (3 to 10)	5
Toll Restriction Guard Time-out	- - second(s) (0 to 25)	10
Call Forwarding-No Answer Time-out	- - seconds (5 to 60)	15
Intercept Routing Time-out (System)	- - - seconds (15 to 240)	60
Intercept Routing Time-out (DISA)	- - - seconds (15 to 240)	30
Attendant Overflow Time	- - - seconds (15 to 240)	60
SMDR Duration Time	<u>s e c o n d (s)</u> (0 to 15)	5

SYSTEM-CLASS OF SERVICE

Note:

Item	Selection of Value	Default Value			
		cos 01	cos 02	COS 03 to 31	COS 32
Toll Restriction Level (Day)	2 digits (01 to 16)	01	01	01	16
Toll Restriction Level (Night)	2 digits (01 to 16)	01	01	01	16
Max. Dialing Digits	1 to 3 digit(s) (0 to 255) 0: unlimited	0	0	0	0
Call Forwarding/Do Not Disturb	Yes/No	Yes	Yes	Yes	No
Do Not Disturb Override	Yes/No	Yes	No	No	No
CO Forward Mode	Yes/No	Yes	No	No	No
CO Transfer Mode	Yes/No	Yes	No	No	No
Forced Account Code Mode	Yes/No	No	No	No	No
BSS/OHCA	Yes/No	Yes	Yes	Yes	No
BSS/OHCA Deny	Yes/No	No	No	No	No
Executive Busy Override	Yes/No	Yes	No	No	No
Executive Busy Override Deny	Yes/No	No	No	No	No
Station Lock	Yes / No	No	No	No	No
Walking Station	Yes/No	No	No	No	No
Maintenance Capability	Yes/No	Yes	No	No	No
ARS/Local Access	W/RSTR No RSTR No ACCS	W/RSTR	W/RSTR	W/RSTR No	ACCS

item	Selection of Value	Default Value
Trunk Group Access Trunk Group 01 to 16	Yes/No	Yes
Special Carrier Access EQA 1 to 4, OCC 1 to 4	Yes/No	No
Station Paging Access PAG 1 to 8	Yes/No	Yes
External Paging	Yes/No	Yes

Class of Service No. 01

Item	Set Data	Item	Set Data
Toll Restriction Level (Day)	- - (01 to 16)	Trunk Group Access	Trunk Group C1 <input type="checkbox"/> Yes, <input type="checkbox"/> No
Toll Restriction Level (Night)	- - (01 to 16)		Trunk Group C2 <input type="checkbox"/> Yes, <input type="checkbox"/> No
Max. Dialing Digits	- - - (0 to 255)		Trunk Group C3 <input type="checkbox"/> Yes, <input type="checkbox"/> No
Call Forwarding/Do Not Disturb	<input type="checkbox"/> Yes, <input type="checkbox"/> No		Trunk Group C4 <input type="checkbox"/> Yes, <input type="checkbox"/> No
Do Not Disturb Override	<input type="checkbox"/> Yes, <input type="checkbox"/> No		Trunk Group 05 <input type="checkbox"/> Yes, <input type="checkbox"/> No
CO Forward Mode	<input type="checkbox"/> Yes, <input type="checkbox"/> No		Trunk Group 06 <input type="checkbox"/> Yes, <input type="checkbox"/> No
CO Transfer Mode	<input type="checkbox"/> Yes, <input type="checkbox"/> No		Trunk Group 07 <input type="checkbox"/> Yes, <input type="checkbox"/> No
Forced Account Code Mode	<input type="checkbox"/> Yes, <input type="checkbox"/> No		Trunk Group 08 <input type="checkbox"/> Yes, <input type="checkbox"/> No
BSS/OHCA	<input type="checkbox"/> Yes, <input type="checkbox"/> No		Trunk Group 09 <input type="checkbox"/> Yes, <input type="checkbox"/> No
BSS/OHCA Deny	<input type="checkbox"/> Yes, <input type="checkbox"/> No		Trunk Group 10 <input type="checkbox"/> Yes, <input type="checkbox"/> No
Executive Busy Override	<input type="checkbox"/> Yes, <input type="checkbox"/> No		Trunk Group 11 <input type="checkbox"/> Yes, <input type="checkbox"/> No
Executive Busy Override Deny	<input type="checkbox"/> Yes, <input type="checkbox"/> No		Trunk Group 12 <input type="checkbox"/> Yes, <input type="checkbox"/> No
Station Lock	<input type="checkbox"/> Yes, <input type="checkbox"/> No		Trunk Group 13 <input type="checkbox"/> Yes, <input type="checkbox"/> No
Walking Station	<input type="checkbox"/> Yes, <input type="checkbox"/> No		Trunk Group 14 <input type="checkbox"/> Yes, <input type="checkbox"/> No
Maintenance Capability	<input type="checkbox"/> Yes, <input type="checkbox"/> No		Trunk Group 15 <input type="checkbox"/> Yes, <input type="checkbox"/> No
ARS/Local Access	<input type="checkbox"/> W/RSTR, <input type="checkbox"/> No RSTR <input type="checkbox"/> No ACCS		Trunk Group 16 <input type="checkbox"/> Yes, <input type="checkbox"/> No
		Special Carrier Access	EQA1 <input type="checkbox"/> Yes, <input type="checkbox"/> No OCC1 <input type="checkbox"/> Yes, <input type="checkbox"/> No EQA2 <input type="checkbox"/> Yes, <input type="checkbox"/> No OCC2 <input type="checkbox"/> Yes, <input type="checkbox"/> No EQA3 <input type="checkbox"/> Yes, <input type="checkbox"/> No OCC3 <input type="checkbox"/> Yes, <input type="checkbox"/> No EQA4 <input type="checkbox"/> Yes, <input type="checkbox"/> No OCC4 <input type="checkbox"/> Yes, <input type="checkbox"/> No
		Station Paging Access	PAG1 <input type="checkbox"/> Yes, <input type="checkbox"/> No PAG5 <input type="checkbox"/> Yes, <input type="checkbox"/> No PAG2 <input type="checkbox"/> Yes, <input type="checkbox"/> No PAG6 <input type="checkbox"/> Yes, <input type="checkbox"/> No PAG3 <input type="checkbox"/> Yes, <input type="checkbox"/> No PAG7 <input type="checkbox"/> Yes, <input type="checkbox"/> No PAG4 <input type="checkbox"/> Yes, <input type="checkbox"/> No PAG8 <input type="checkbox"/> Yes, <input type="checkbox"/> No
		External Paging	External paging 1 <input type="checkbox"/> Yes, <input type="checkbox"/> No External paging 2 <input type="checkbox"/> Yes, <input type="checkbox"/> No

Class of Service No. 02

Item	Set Data	Item	Set Data
Toll Restriction Level (Day)	- - (01 to 16)	Trunk Group Access	Trunk Group 01 <input type="checkbox"/> Yes, <input type="checkbox"/> No
Toll Restriction Level (Night)	- - (01 to 16)		Trunk Group 02 <input type="checkbox"/> Yes, <input type="checkbox"/> No
Max. Dialing Digits	- - - (0 to 255)		Trunk Group 03 <input type="checkbox"/> Yes, <input type="checkbox"/> No
Call Forwarding/Do Not Disturb	<input type="checkbox"/> Yes, <input type="checkbox"/> No		Trunk Group 04 <input type="checkbox"/> Yes, <input type="checkbox"/> No
Do Not Disturb Override	<input type="checkbox"/> Yes, <input type="checkbox"/> No		Trunk Group 05 <input type="checkbox"/> Yes, <input type="checkbox"/> No
CO Forward Mode	<input type="checkbox"/> Yes, <input type="checkbox"/> No		Trunk Group 06 <input type="checkbox"/> Yes, <input type="checkbox"/> No
CO Transfer Mode	<input type="checkbox"/> Yes, <input type="checkbox"/> No		Trunk Group 07 <input type="checkbox"/> Yes, <input type="checkbox"/> No
Forced Account Code Mode	<input type="checkbox"/> Yes, <input type="checkbox"/> No		Trunk Group 08 <input type="checkbox"/> Yes, <input type="checkbox"/> No
BSS/OHCA	<input type="checkbox"/> Yes, <input type="checkbox"/> No		Trunk Group 09 <input type="checkbox"/> Yes, <input type="checkbox"/> No
BSS/OHCA Deny	<input type="checkbox"/> Yes, <input type="checkbox"/> No		Trunk Group 10 <input type="checkbox"/> Yes, <input type="checkbox"/> No
Executive Busy Override	<input type="checkbox"/> Yes, <input type="checkbox"/> No		Trunk Group 11 <input type="checkbox"/> Yes, <input type="checkbox"/> No
Executive Busy Override Deny	<input type="checkbox"/> Yes, <input type="checkbox"/> No		Trunk Group 12 <input type="checkbox"/> Yes, <input type="checkbox"/> No
Station Lock	<input type="checkbox"/> Yes, <input type="checkbox"/> No		Trunk Group 13 <input type="checkbox"/> Yes, <input type="checkbox"/> No
Walking Station	<input type="checkbox"/> Yes, <input type="checkbox"/> No		Trunk Group 14 <input type="checkbox"/> Yes, <input type="checkbox"/> No
Maintenance Capability	<input type="checkbox"/> Yes, <input type="checkbox"/> No		Trunk Group 15 <input type="checkbox"/> Yes, <input type="checkbox"/> No
ARS/Local Access	<input type="checkbox"/> W/RSTR, <input type="checkbox"/> No RSTR <input type="checkbox"/> No ACCS		Trunk Group 16 <input type="checkbox"/> Yes, <input type="checkbox"/> No
		Special Carrier Access	EQA1 <input type="checkbox"/> Yes, <input type="checkbox"/> No OCC1 <input type="checkbox"/> Yes, <input type="checkbox"/> No EQA2 <input type="checkbox"/> Yes, <input type="checkbox"/> No OCC2 <input type="checkbox"/> Yes, <input type="checkbox"/> No EQA3 <input type="checkbox"/> Yes, <input type="checkbox"/> No OCC3 <input type="checkbox"/> Yes, <input type="checkbox"/> No EQA4 <input type="checkbox"/> Yes, <input type="checkbox"/> No OCC4 <input type="checkbox"/> Yes, <input type="checkbox"/> No
		Station Paging Access	PAG1 <input type="checkbox"/> Yes, <input type="checkbox"/> No PAG5 <input type="checkbox"/> Yes, <input type="checkbox"/> No PAG2 <input type="checkbox"/> Yes, <input type="checkbox"/> No PAG6 <input type="checkbox"/> Yes, <input type="checkbox"/> No PAG3 <input type="checkbox"/> Yes, <input type="checkbox"/> No PAG7 <input type="checkbox"/> Yes, <input type="checkbox"/> No PAG4 <input type="checkbox"/> Yes, <input type="checkbox"/> No PAG8 <input type="checkbox"/> Yes, <input type="checkbox"/> No
		External Paging	External paging 1 <input type="checkbox"/> Yes, <input type="checkbox"/> No External paging 2 <input type="checkbox"/> Yes, <input type="checkbox"/> No

Class of Service No. 03

item	Set Data	Item	Set Data
Toll Restriction Level (Day)	- - (01 to 16)	Trunk Group Access	Trunk Group 01 <input type="checkbox"/> Yes, <input type="checkbox"/> No
Toll Restriction Level (Night)	- - - (01 to 16)		Trunk Group 02 <input type="checkbox"/> Yes,
Max Dialing Digits	- - - (0 to 255)		Trunk Group 03 <input type="checkbox"/> Yes, <input type="checkbox"/> No
Call Forwarding/Do Not Disturb	<input type="checkbox"/> <input type="checkbox"/>		Trunk Group 04 <input type="checkbox"/> Yes, <input type="checkbox"/> No
Do Not Disturb Override	<input type="checkbox"/> <input type="checkbox"/> No		Trunk Group 05 <input type="checkbox"/> Yes, <input type="checkbox"/> No
CO Forward Mode	<input type="checkbox"/> Yes, <input type="checkbox"/> No		Trunk Group 06 <input type="checkbox"/> Yes, <input type="checkbox"/> No
CO Transfer Mode	<input type="checkbox"/> <input type="checkbox"/> No		Trunk Group 07 <input type="checkbox"/> Yes, <input type="checkbox"/> No
Forced Account Code Mode	<input type="checkbox"/> <input type="checkbox"/> No		Trunk Group 08 <input type="checkbox"/> Yes, <input type="checkbox"/> No
BSS/OHCA	<input type="checkbox"/> <input type="checkbox"/> No		Trunk Group 09 <input type="checkbox"/> Yes, <input type="checkbox"/> No
BSS/OHCA Deny	<input type="checkbox"/> <input type="checkbox"/> No		Trunk Group 10 <input type="checkbox"/> Yes, <input type="checkbox"/> No
Executive Busy Override	<input type="checkbox"/> <input type="checkbox"/> No		Trunk Group 11 <input type="checkbox"/> Yes, <input type="checkbox"/> No
Executive Busy Override Deny	<input type="checkbox"/> <input type="checkbox"/> No		Trunk Group 12 <input type="checkbox"/> Yes, <input type="checkbox"/> No
Station Lock	<input type="checkbox"/> <input type="checkbox"/> No		Trunk Group 13 <input type="checkbox"/> Yes, <input type="checkbox"/> No
Walking Station	<input type="checkbox"/> <input type="checkbox"/> No		Trunk Group 14 <input type="checkbox"/> Yes, <input type="checkbox"/> No
Maintenance Capability	<input type="checkbox"/> Yes, <input type="checkbox"/> No		Trunk Group 15 <input type="checkbox"/> Yes, <input type="checkbox"/> No
ARS/Local Access	<input type="checkbox"/> W/RSTR, <input type="checkbox"/> No RSTR <input type="checkbox"/> No ACCS		Trunk Group 16 <input type="checkbox"/> Yes, <input type="checkbox"/> No
		Special Carrier Access	EQA1 <input type="checkbox"/> Yes, <input type="checkbox"/> No OCC1 <input type="checkbox"/> Yes, <input type="checkbox"/> No EQA2 <input type="checkbox"/> Yes, <input type="checkbox"/> No OCC2 <input type="checkbox"/> Yes, <input type="checkbox"/> No EOA3 <input type="checkbox"/> Yes, <input type="checkbox"/> No OCC3 <input type="checkbox"/> Yes, <input type="checkbox"/> No EQA4 <input type="checkbox"/> Yes, <input type="checkbox"/> No OCC4 <input type="checkbox"/> Yes, <input type="checkbox"/> No
		Station Paging Access	PAG1 <input type="checkbox"/> Yes, <input type="checkbox"/> No PAG2 <input type="checkbox"/> Yes, <input type="checkbox"/> No PAG3 <input type="checkbox"/> Yes, <input type="checkbox"/> No PAG4 <input type="checkbox"/> Yes, <input type="checkbox"/> No PAG5 <input type="checkbox"/> Yes, <input type="checkbox"/> No PAG6 <input type="checkbox"/> Yes, <input type="checkbox"/> No PAG7 <input type="checkbox"/> Yes, <input type="checkbox"/> No PAG8 <input type="checkbox"/> Yes, <input type="checkbox"/> No
		External Paging	External paging 1 <input type="checkbox"/> Yes, <input type="checkbox"/> No External paging 2 <input type="checkbox"/> Yes, <input type="checkbox"/> No

Class of Service No. 04

Item	Set Data	Item	Set Data
Toll Restriction Level (Day)	- - (01 to 16)	Trunk Group Access	Trunk Group 01 <input type="checkbox"/> Yes, <input type="checkbox"/> No
Toll Restriction Level (Night)	(0 1 t o 1 6)		Trunk Group 02 <input type="checkbox"/> Yes, <input type="checkbox"/> No
Max. Dialing Digits	- - - (0 to 255)		Trunk Group 03 <input type="checkbox"/> Yes, <input type="checkbox"/> No
Call Forwarding/Do Not Disturb	<input type="checkbox"/> <input type="checkbox"/>		Trunk Group 04 <input type="checkbox"/> Yes, <input type="checkbox"/> No
Do Not Disturb Override	<input type="checkbox"/> Yes, <input type="checkbox"/> No		Trunk Group 05 <input type="checkbox"/> Yes, <input type="checkbox"/> No
CO Forward Mode	<input type="checkbox"/> <input type="checkbox"/> No		Trunk Group 06 <input type="checkbox"/> Yes, <input type="checkbox"/> No
CO Transfer Mode	<input type="checkbox"/> <input type="checkbox"/> No		Trunk Group 07 <input type="checkbox"/> Yes, <input type="checkbox"/> No
Forced Account Code Mode	<input type="checkbox"/> <input type="checkbox"/> No		Trunk Group 08 <input type="checkbox"/> Yes, <input type="checkbox"/> No
BSS/OHCA	<input type="checkbox"/> Yes, <input type="checkbox"/> No		Trunk Group 09 <input type="checkbox"/> Yes, <input type="checkbox"/> No
BSS/OHCA Deny	<input type="checkbox"/> Yes, <input type="checkbox"/> No		Trunk Group 10 <input type="checkbox"/> Yes, <input type="checkbox"/> No
Executive Busy Override	<input type="checkbox"/> <input type="checkbox"/> No		Trunk Group 11 <input type="checkbox"/> Yes, <input type="checkbox"/> No
Executive Busy Override Deny	<input type="checkbox"/> Yes, <input type="checkbox"/> No		Trunk Group 12 <input type="checkbox"/> Yes, <input type="checkbox"/> No
Station Lock	<input type="checkbox"/> <input type="checkbox"/> No		Trunk Group 13 <input type="checkbox"/> Yes, <input type="checkbox"/> No
Walking Station	<input type="checkbox"/> <input type="checkbox"/> No		Trunk Group 14 <input type="checkbox"/> Yes, <input type="checkbox"/> No
Maintenance Capability	<input type="checkbox"/> <input type="checkbox"/> No		Trunk Group 15 <input type="checkbox"/> Yes, <input type="checkbox"/> No
ARS/Local Access	<input type="checkbox"/> W/RSTR, <input type="checkbox"/> No RSTR <input type="checkbox"/> No ACCS		Trunk Group 16 <input type="checkbox"/> Yes, <input type="checkbox"/> No
		Special Carrier Access	EQA1 <input type="checkbox"/> Yes, <input type="checkbox"/> No OCC1 <input type="checkbox"/> Yes, <input type="checkbox"/> No EQA2 <input type="checkbox"/> Yes, <input type="checkbox"/> No OCC2 <input type="checkbox"/> Yes, <input type="checkbox"/> No EQA3 <input type="checkbox"/> Yes, <input type="checkbox"/> No OCC3 <input type="checkbox"/> Yes, <input type="checkbox"/> No EQA4 <input type="checkbox"/> Yes, <input type="checkbox"/> No OCC4 <input type="checkbox"/> Yes, <input type="checkbox"/> No
		Station Paging Access	PAG1 <input type="checkbox"/> Yes, <input type="checkbox"/> No PAG2 <input type="checkbox"/> Yes, <input type="checkbox"/> No PAG3 <input type="checkbox"/> Yes, <input type="checkbox"/> No PAG4 <input type="checkbox"/> Yes, <input type="checkbox"/> No PAG5 <input type="checkbox"/> Yes, <input type="checkbox"/> No PAG6 <input type="checkbox"/> Yes, <input type="checkbox"/> No PAG7 <input type="checkbox"/> Yes, <input type="checkbox"/> No PAG8 <input type="checkbox"/> Yes, <input type="checkbox"/> No
		External Paging	External paging 1 <input type="checkbox"/> Yes, <input type="checkbox"/> No External paging 2 <input type="checkbox"/> Yes, <input type="checkbox"/> No

of Service No. 05

Item	Set Data	Item	Set Data
Trunk Level (Day)	(0 1 t o 1 6)	Trunk Group Access	Trunk Group 01 <input type="checkbox"/> Yes, <input type="checkbox"/> No
Trunk Level (Night)	(0 1 t o 1 6)		Trunk Group 02 <input type="checkbox"/> Yes, <input type="checkbox"/> No
Trunk Digits	- - - (0 to 255)		Trunk Group 03 <input type="checkbox"/> Yes, <input type="checkbox"/> No
Trunk Do Not Disturb	<input type="checkbox"/> Yes, <input type="checkbox"/> No		Trunk Group 04 <input type="checkbox"/> Yes, <input type="checkbox"/> No
Trunk Override	<input type="checkbox"/> Yes, <input type="checkbox"/> No		Trunk Group 05 <input type="checkbox"/> Yes, <input type="checkbox"/> No
Trunk Mode	<input type="checkbox"/> Yes, <input type="checkbox"/> No		Trunk Group 06 <input type="checkbox"/> Yes, <input type="checkbox"/> No
Trunk Transfer Mode	<input type="checkbox"/> Yes, <input type="checkbox"/> No		Trunk Group 07 <input type="checkbox"/> Yes, <input type="checkbox"/> No
Trunk Account Code Mode	<input type="checkbox"/> Yes, <input type="checkbox"/> No		Trunk Group 08 <input type="checkbox"/> Yes, <input type="checkbox"/> No
Trunk CA	<input type="checkbox"/> Yes, <input type="checkbox"/> No		Trunk Group 09 <input type="checkbox"/> Yes, <input type="checkbox"/> No
Trunk CA Deny	<input type="checkbox"/> Yes, <input type="checkbox"/> No		Trunk Group 10 <input type="checkbox"/> Yes, <input type="checkbox"/> No
Trunk Busy Override	<input type="checkbox"/> Yes, <input type="checkbox"/> No		Trunk Group 11 <input type="checkbox"/> Yes, <input type="checkbox"/> No
Trunk Busy Override Deny	<input type="checkbox"/> Yes, <input type="checkbox"/> No		Trunk Group 12 <input type="checkbox"/> Yes, <input type="checkbox"/> No
Trunk Lock	<input type="checkbox"/> Yes, <input type="checkbox"/> No		Trunk Group 13 <input type="checkbox"/> Yes, <input type="checkbox"/> No
Trunk Station	<input type="checkbox"/> Yes, <input type="checkbox"/> No		Trunk Group 14 <input type="checkbox"/> Yes, <input type="checkbox"/> No
Trunk Station Capability	<input type="checkbox"/> Yes, <input type="checkbox"/> No		Trunk Group 15 <input type="checkbox"/> Yes, <input type="checkbox"/> No
Trunk Local Access	<input type="checkbox"/> W/RSTR, <input type="checkbox"/> No RSTR <input type="checkbox"/> No ACCS		Trunk Group 16 <input type="checkbox"/> Yes, <input type="checkbox"/> No
		Special Carrier Access	EQA1 <input type="checkbox"/> Yes, <input type="checkbox"/> No EQA2 <input type="checkbox"/> Yes, <input type="checkbox"/> No EQA3 <input type="checkbox"/> Yes, <input type="checkbox"/> No EQA4 <input type="checkbox"/> Yes, <input type="checkbox"/> No
		Station Paging Access	PAG1 <input type="checkbox"/> Yes, <input type="checkbox"/> No PAG2 <input type="checkbox"/> Yes, <input type="checkbox"/> No PAG3 <input type="checkbox"/> Yes, <input type="checkbox"/> No PAG4 <input type="checkbox"/> Yes, <input type="checkbox"/> No PAG5 <input type="checkbox"/> Yes, <input type="checkbox"/> No PAG6 <input type="checkbox"/> Yes, <input type="checkbox"/> No PAG7 <input type="checkbox"/> Yes, <input type="checkbox"/> No PAG8 <input type="checkbox"/> Yes, <input type="checkbox"/> No
		External Paging	External paging 1 <input type="checkbox"/> Yes, <input type="checkbox"/> No External paging 2 <input type="checkbox"/> Yes, <input type="checkbox"/> No

of Service No. 06

Item	Set Data	Item	Set Data
Trunk Level (Day)	(0 1 t o 1 6)	Trunk Group Access	Trunk Group 01 <input type="checkbox"/> Yes, <input type="checkbox"/> No
Trunk Level (Night)	(0 1 t o 1 6)		Trunk Group 02 <input type="checkbox"/> Yes, <input type="checkbox"/> No
Trunk Digits	- - - (0 to 255)		Trunk Group 03 <input type="checkbox"/> Yes, <input type="checkbox"/> No
Trunk Do Not Disturb	<input type="checkbox"/> Yes, <input type="checkbox"/> No		Trunk Group 04 <input type="checkbox"/> Yes, <input type="checkbox"/> No
Trunk Override	<input type="checkbox"/> Yes, <input type="checkbox"/> No		Trunk Group 05 <input type="checkbox"/> Yes, <input type="checkbox"/> No
Trunk Mode	<input type="checkbox"/> Yes, <input type="checkbox"/> No		Trunk Group 06 <input type="checkbox"/> Yes, <input type="checkbox"/> No
Trunk Transfer Mode	<input type="checkbox"/> Yes, <input type="checkbox"/> No		Trunk Group 07 <input type="checkbox"/> Yes, <input type="checkbox"/> No
Trunk Account Code	<input type="checkbox"/> Yes, <input type="checkbox"/> No		Trunk Group 08 <input type="checkbox"/> Yes, <input type="checkbox"/> No
Trunk CA	<input type="checkbox"/> Yes, <input type="checkbox"/> No		Trunk Group 09 <input type="checkbox"/> Yes, <input type="checkbox"/> No
Trunk CA Deny	<input type="checkbox"/> Yes, <input type="checkbox"/> No		Trunk Group 10 <input type="checkbox"/> Yes, <input type="checkbox"/> No
Trunk Busy Override	<input type="checkbox"/> Yes, <input type="checkbox"/> No		Trunk Group 11 <input type="checkbox"/> Yes, <input type="checkbox"/> No
Trunk Busy Override Deny	<input type="checkbox"/> Yes, <input type="checkbox"/> No		Trunk Group 12 <input type="checkbox"/> Yes, <input type="checkbox"/> No
Trunk Lock	<input type="checkbox"/> Yes, <input type="checkbox"/> No		Trunk Group 13 <input type="checkbox"/> Yes, <input type="checkbox"/> No
Trunk Station	<input type="checkbox"/> Yes, <input type="checkbox"/> No		Trunk Group 14 <input type="checkbox"/> Yes, <input type="checkbox"/> No
Trunk Station Capability	<input type="checkbox"/> Yes, <input type="checkbox"/> No		Trunk Group 15 <input type="checkbox"/> Yes, <input type="checkbox"/> No
Trunk Local Access	<input type="checkbox"/> W/RSTR, <input type="checkbox"/> No RSTR <input type="checkbox"/> No ACCS		Trunk Group 16 <input type="checkbox"/> Yes, <input type="checkbox"/> No
		Special Carrier Access	EQA1 <input type="checkbox"/> Yes, <input type="checkbox"/> No EQA2 <input type="checkbox"/> Yes, <input type="checkbox"/> No EQA3 <input type="checkbox"/> Yes, <input type="checkbox"/> No EQA4 <input type="checkbox"/> Yes, <input type="checkbox"/> No
		Station Paging Access	PAG1 <input type="checkbox"/> Yes, <input type="checkbox"/> No PAG2 <input type="checkbox"/> Yes, <input type="checkbox"/> No PAG3 <input type="checkbox"/> Yes, <input type="checkbox"/> No PAG4 <input type="checkbox"/> Yes, <input type="checkbox"/> No PAG5 <input type="checkbox"/> Yes, <input type="checkbox"/> No PAG6 <input type="checkbox"/> Yes, <input type="checkbox"/> No PAG7 <input type="checkbox"/> Yes, <input type="checkbox"/> No PAG8 <input type="checkbox"/> Yes, <input type="checkbox"/> No
		External Paging	External paging 1 <input type="checkbox"/> Yes, <input type="checkbox"/> No External paging 2 <input type="checkbox"/> Yes, <input type="checkbox"/> No

- No
- No
- No
- No
- No
- No
- No

Service No. 11

Item	Set Data	item	Set Data
on Level (Day)	- - (CI to 16)	Trunk Group Access	Trunk Group 01 <input type="checkbox"/> Yes, <input type="checkbox"/> No
on Level (Night)	- - (CI to 16)		Trunk Group 02 <input checked="" type="checkbox"/> Yes, <input type="checkbox"/> No
Digits	_____ (0 to 255)		Trunk Group 03 <input type="checkbox"/> Yes, <input type="checkbox"/> No
ing/Do Not Disturb	<input type="checkbox"/> <input checked="" type="checkbox"/> <input checked="" type="checkbox"/> <input checked="" type="checkbox"/> No		Trunk Group 04 <input type="checkbox"/> Yes, <input type="checkbox"/> No
rb Override	<input type="checkbox"/> <input checked="" type="checkbox"/> <input checked="" type="checkbox"/> <input checked="" type="checkbox"/> No		Trunk Group 05 <input type="checkbox"/> Yes, <input type="checkbox"/> No
Mode	<input type="checkbox"/> Yes, <input type="checkbox"/> No		Trunk Group 06 <input type="checkbox"/> Yes, <input type="checkbox"/> No
Mode	<input type="checkbox"/> <input checked="" type="checkbox"/> <input checked="" type="checkbox"/> <input checked="" type="checkbox"/> No		Trunk Group 07 <input type="checkbox"/> Yes, <input type="checkbox"/> No
unt Code Mode	<input type="checkbox"/> Yes, <input type="checkbox"/> No		Trunk Group 08 <input type="checkbox"/> Yes, <input type="checkbox"/> No
	<input type="checkbox"/> Yes, <input type="checkbox"/> No		Trunk Group 09 <input type="checkbox"/> Yes, <input type="checkbox"/> No
eny	<input type="checkbox"/> <input checked="" type="checkbox"/> <input checked="" type="checkbox"/> <input checked="" type="checkbox"/> No		Trunk Group 10 <input type="checkbox"/> Yes, <input type="checkbox"/> No
isy Override	<input type="checkbox"/> Yes, <input type="checkbox"/> <input checked="" type="checkbox"/> <input checked="" type="checkbox"/>		Trunk Group 11 <input type="checkbox"/> Yes, <input type="checkbox"/> No
isy Override Deny	<input type="checkbox"/> <input checked="" type="checkbox"/> <input checked="" type="checkbox"/> <input checked="" type="checkbox"/>		Trunk Group 12 <input type="checkbox"/> Yes, <input type="checkbox"/> No
ion	<input type="checkbox"/> <input checked="" type="checkbox"/> <input checked="" type="checkbox"/> <input checked="" type="checkbox"/>		Trunk Group 13 <input type="checkbox"/> Yes, <input type="checkbox"/> No
apability	<input type="checkbox"/> Yes, <input type="checkbox"/> No		Trunk Group 14 <input type="checkbox"/> Yes, <input type="checkbox"/> No
ccess	<input type="checkbox"/> W/RSTR, <input type="checkbox"/> No RSTR <input type="checkbox"/> No ACCS		Trunk Group 15 <input type="checkbox"/> Yes, <input type="checkbox"/> No
			Trunk Group 16 <input type="checkbox"/> Yes, <input type="checkbox"/> No
		Special Carrier Access	EQA1 <input type="checkbox"/> Yes, <input type="checkbox"/> No EOA2 <input type="checkbox"/> Yes, <input type="checkbox"/> No EOA3 <input type="checkbox"/> Yes, <input type="checkbox"/> No EQA4 <input type="checkbox"/> Yes, <input type="checkbox"/> No OCC1 <input type="checkbox"/> Yes, <input type="checkbox"/> No OCC2 <input type="checkbox"/> Yes, <input type="checkbox"/> No OCC3 <input type="checkbox"/> Yes, <input type="checkbox"/> No OCC4 <input type="checkbox"/> Yes, <input type="checkbox"/> No
		Station Paging Access	PAG1 <input type="checkbox"/> Yes, <input type="checkbox"/> No PAG2 <input type="checkbox"/> Yes, <input type="checkbox"/> No PAG3 <input type="checkbox"/> Yes, <input type="checkbox"/> No PAG4 <input type="checkbox"/> Yes, <input type="checkbox"/> No PAG5 <input type="checkbox"/> Yes, <input type="checkbox"/> No PAG6 <input type="checkbox"/> Yes, <input type="checkbox"/> No PAG7 <input type="checkbox"/> Yes, <input type="checkbox"/> No PAG8 <input type="checkbox"/> Yes, <input type="checkbox"/> No
		External Paging	External paging 1 <input type="checkbox"/> Yes, <input type="checkbox"/> No External paging 2 <input checked="" type="checkbox"/> Yes, <input type="checkbox"/> No

Yes, Yes,

No
No
No
No
No
No
Jo
Jo
Jo
Jo
Jo
Jo
Jo
Jo

es. No
es. No
es. No
es. No

es, No

Service No. 12

Item	Set Data	Item	Set Data
on Level (Day)	(0 1 t o 1 6)	Trunk Group Access	Trunk Group 01 <input type="checkbox"/> Yes, <input type="checkbox"/> No
on Level (Night)	(0 1 t o 1 6)		Trunk Group 02 <input type="checkbox"/> Yes, <input type="checkbox"/> No
Digit	_____ (0 to 255)		Trunk Group 03 <input checked="" type="checkbox"/> Yes, <input type="checkbox"/> No
ing/Do Not Disturb	<input type="checkbox"/> Yes, <input type="checkbox"/> No		Trunk Group 04 <input type="checkbox"/> Yes, <input type="checkbox"/> No
rb Override	<input type="checkbox"/> Yes, <input type="checkbox"/> No		Trunk Group 05 <input type="checkbox"/> Yes, <input type="checkbox"/> No
Mode	<input type="checkbox"/> <input checked="" type="checkbox"/> <input checked="" type="checkbox"/> <input checked="" type="checkbox"/>		Trunk Group 06 <input type="checkbox"/> Yes, <input type="checkbox"/> No
Mode	<input type="checkbox"/> Yes, <input type="checkbox"/> <input checked="" type="checkbox"/> <input checked="" type="checkbox"/>		Trunk Group 07 <input type="checkbox"/> Yes, <input type="checkbox"/> No
unt Code Mode	<input type="checkbox"/> Yes, <input type="checkbox"/> No		Trunk Group 08 <input type="checkbox"/> Yes, <input type="checkbox"/> No
	<input type="checkbox"/> <input checked="" type="checkbox"/> <input checked="" type="checkbox"/> <input checked="" type="checkbox"/>		Trunk Group 09 <input type="checkbox"/> Yes, <input type="checkbox"/> No
eny	<input type="checkbox"/> Yes, <input type="checkbox"/> No		Trunk Group 10 <input type="checkbox"/> Yes, <input type="checkbox"/> No
isy Override	<input type="checkbox"/> Yes, <input type="checkbox"/> <input checked="" type="checkbox"/> <input checked="" type="checkbox"/>		Trunk Group 11 <input type="checkbox"/> Yes, <input type="checkbox"/> No
isy Override Deny	<input type="checkbox"/> Yes, <input type="checkbox"/> No		Trunk Group 12 <input type="checkbox"/> Yes, <input type="checkbox"/> No
ion	<input type="checkbox"/> <input checked="" type="checkbox"/> <input checked="" type="checkbox"/> <input checked="" type="checkbox"/>		Trunk Group 13 <input type="checkbox"/> Yes, <input type="checkbox"/> No
apability	<input type="checkbox"/> Yes, <input type="checkbox"/> No		Trunk Group 14 <input type="checkbox"/> Yes, <input type="checkbox"/> No
ccess	<input type="checkbox"/> W/RSTR, <input type="checkbox"/> No RSTR <input type="checkbox"/> No ACCS		Trunk Group 15 <input type="checkbox"/> Yes, <input type="checkbox"/> No
			Trunk Group 16 <input type="checkbox"/> Yes, <input type="checkbox"/> No
		special carrier Access	EQA1 <input type="checkbox"/> Yes, <input type="checkbox"/> No EOA2 <input type="checkbox"/> Yes, <input type="checkbox"/> No EOA3 <input type="checkbox"/> Yes, <input type="checkbox"/> No EQA4 <input type="checkbox"/> Yes, <input type="checkbox"/> No OCC1 <input type="checkbox"/> Yes, <input type="checkbox"/> No OCC2 <input type="checkbox"/> Yes, <input type="checkbox"/> No OCC3 <input type="checkbox"/> Yes, <input type="checkbox"/> No OCC4 <input type="checkbox"/> Yes, <input type="checkbox"/> No
		Station Paging Access	PAG1 <input type="checkbox"/> Yes, <input type="checkbox"/> No PAG2 <input type="checkbox"/> Yes, <input type="checkbox"/> No PAG3 <input type="checkbox"/> Yes, <input type="checkbox"/> No PAG4 <input type="checkbox"/> Yes, <input type="checkbox"/> No PAG5 <input type="checkbox"/> Yes, <input type="checkbox"/> No PAG6 <input type="checkbox"/> Yes, <input type="checkbox"/> No PAG7 <input type="checkbox"/> Yes, <input type="checkbox"/> No PAG8 <input type="checkbox"/> Yes, <input type="checkbox"/> No
		External Paging	External paging 1 <input type="checkbox"/> Yes, <input type="checkbox"/> No External paging 2 <input type="checkbox"/> Yes, <input type="checkbox"/> No

No
 No
 No
 No
 No
 No
 No
 No

is

Class of Service No. 13

Item	Set Data	Item	Set Data
Toll Restriction Level (Day)	(0 1 t o 1 6)	Trunk Group Access	Trunk Group 01 <input type="checkbox"/> Yes, <input type="checkbox"/> No
Toll Restriction Level (Night)	__ __ (01 to 16)		Trunk Group 02 <input type="checkbox"/> Yes, <input type="checkbox"/> No
Max. Dialing Digits	____ (0 to 255)		Trunk Group 03 <input type="checkbox"/> Yes, <input type="checkbox"/> No
Call Forwarding/Do Not Disturb	<input type="checkbox"/> Yes, <input type="checkbox"/> No		Trunk Group 04 <input type="checkbox"/> Yes, <input type="checkbox"/> No
Do Not Disturb Override	<input type="checkbox"/> Yes, <input type="checkbox"/> No		Trunk Group 05 <input type="checkbox"/> Yes, <input type="checkbox"/> No
CO Forward Mode	<input type="checkbox"/> Yes, <input type="checkbox"/> No		Trunk Group 06 <input type="checkbox"/> Yes, <input type="checkbox"/> No
CO Transfer Mode	<input type="checkbox"/> Yes, <input type="checkbox"/> No		Trunk Group 07 <input type="checkbox"/> Yes, <input type="checkbox"/> No
Forced Account Code Mode	<input type="checkbox"/> Yes, <input type="checkbox"/> No		Trunk Group 08 <input type="checkbox"/> Yes, <input type="checkbox"/> No
BSS/OHCA	<input type="checkbox"/> Yes, <input type="checkbox"/> No		Trunk Group 09 <input type="checkbox"/> Yes, <input type="checkbox"/> No
BSS/OHCA Deny	<input type="checkbox"/> Yes, <input type="checkbox"/> No		Trunk Group 10 <input type="checkbox"/> Yes, <input type="checkbox"/> No
Executive Busy Override	<input type="checkbox"/> Yes, <input type="checkbox"/> No		Trunk Group 11 <input type="checkbox"/> Yes, <input type="checkbox"/> No
Executive Busy Override Deny	<input type="checkbox"/> Yes, <input type="checkbox"/> No		Trunk Group 12 <input type="checkbox"/> Yes, <input type="checkbox"/> No
Station Lock	<input type="checkbox"/> Yes, <input type="checkbox"/> No		Trunk Group 13 <input type="checkbox"/> Yes, <input type="checkbox"/> No
Walking Station	<input type="checkbox"/> Yes, <input type="checkbox"/> No		Trunk Group 14 <input type="checkbox"/> Yes, <input type="checkbox"/> No
Maintenance Capability	<input type="checkbox"/> Yes, <input type="checkbox"/> No		Trunk Group 15 <input type="checkbox"/> Yes, <input type="checkbox"/> No
ARS/Local Access	<input type="checkbox"/> W/RSTR, <input type="checkbox"/> No RSTR <input type="checkbox"/> No ACCS		Trunk Group 16 <input type="checkbox"/> Yes, <input type="checkbox"/> No
		Special Carrier Access	EQA1 <input type="checkbox"/> Yes, <input type="checkbox"/> No
			EQA2 <input type="checkbox"/> Yes, <input type="checkbox"/> No
			EQA3 <input type="checkbox"/> Yes, <input type="checkbox"/> No
			EQA4 <input type="checkbox"/> Yes, <input type="checkbox"/> No
		Station Paging Access	OCC1 <input type="checkbox"/> Yes, <input type="checkbox"/> No
			OCC2 <input type="checkbox"/> Yes, <input type="checkbox"/> No
			OCC3 <input type="checkbox"/> Yes, <input type="checkbox"/> No
			OCC4 <input type="checkbox"/> Yes, <input type="checkbox"/> No
		External Paging	PAG1 <input type="checkbox"/> Yes, <input type="checkbox"/> No
			PAG2 <input type="checkbox"/> Yes, <input type="checkbox"/> No
			PAG3 <input type="checkbox"/> Yes, <input type="checkbox"/> No
			PAG4 <input type="checkbox"/> Yes, <input type="checkbox"/> No
			PAG5 <input type="checkbox"/> Yes, <input type="checkbox"/> No
			PAG6 <input type="checkbox"/> Yes, <input type="checkbox"/> No
			PAG7 <input type="checkbox"/> Yes, <input type="checkbox"/> No
			PAG8 <input type="checkbox"/> Yes, <input type="checkbox"/> No
			External paging 1 <input type="checkbox"/> Yes, <input type="checkbox"/> No
			External paging 2 <input type="checkbox"/> Yes, <input type="checkbox"/> No

Class of Service No. 14

Item	Set Data	Item	Set Data
Toll Restriction Level (Day)	(0 1 t o 1 6)	Trunk Group Access	Trunk Group 01 <input type="checkbox"/> Yes, <input type="checkbox"/> No
Toll Restriction Level (Night)	(0 1 t o 1 6)		Trunk Group 02 <input type="checkbox"/> Yes, <input type="checkbox"/> No
Max. Dialing Digits	- - - (0 to 255)		Trunk Group 03 <input type="checkbox"/> Yes, <input type="checkbox"/> No
Call Forwarding/Do Not Disturb	<input type="checkbox"/> Yes, <input type="checkbox"/> No		Trunk Group 04 <input type="checkbox"/> Yes, <input type="checkbox"/> No
Do Not Disturb Override	<input type="checkbox"/> Yes, <input type="checkbox"/> No		Trunk Group 05 <input type="checkbox"/> Yes, <input type="checkbox"/> No
CO Forward Mode	<input type="checkbox"/> Yes, <input type="checkbox"/> No		Trunk Group 06 <input type="checkbox"/> Yes, <input type="checkbox"/> No
CO Transfer Mode	<input type="checkbox"/> Yes, <input type="checkbox"/> No		Trunk Group 07 <input type="checkbox"/> Yes, <input type="checkbox"/> No
Forced Account Code Mode	<input type="checkbox"/> Yes, <input type="checkbox"/> No		Trunk Group 08 <input type="checkbox"/> Yes, <input type="checkbox"/> No
BSS/OHCA	<input type="checkbox"/> Yes, <input type="checkbox"/> No		Trunk Group 09 <input type="checkbox"/> Yes, <input type="checkbox"/> No
BSS/OHCA Deny	<input type="checkbox"/> Yes, <input type="checkbox"/> No		Trunk Group 10 <input type="checkbox"/> Yes, <input type="checkbox"/> No
Executive Busy Override	<input type="checkbox"/> Yes, <input type="checkbox"/> No		Trunk Group 11 <input type="checkbox"/> Yes, <input type="checkbox"/> No
Executive Busy Override Deny	<input type="checkbox"/> Yes, <input type="checkbox"/> No		Trunk Group 12 <input type="checkbox"/> Yes, <input type="checkbox"/> No
Station Lock	<input type="checkbox"/> Yes, <input type="checkbox"/> No		Trunk Group 13 <input type="checkbox"/> Yes, <input type="checkbox"/> No
Walking Station	<input type="checkbox"/> Yes, <input type="checkbox"/> No		Trunk Group 14 <input type="checkbox"/> Yes, <input type="checkbox"/> No
Maintenance Capability	<input type="checkbox"/> Yes, <input type="checkbox"/> No		Trunk Group 15 <input type="checkbox"/> Yes, <input type="checkbox"/> No
ARS/Local Access	<input type="checkbox"/> W/RSTR, <input type="checkbox"/> No RSTR <input type="checkbox"/> No ACCS		Trunk Group 16 <input type="checkbox"/> Yes, <input type="checkbox"/> No
		Special carrier Access	EQA1 <input type="checkbox"/> Yes, <input type="checkbox"/> No
			EQA2 <input type="checkbox"/> Yes, <input type="checkbox"/> No
			EQA3 <input type="checkbox"/> Yes, <input type="checkbox"/> No
			EQA4 <input type="checkbox"/> Yes, <input type="checkbox"/> No
		Station Paging Access	OCC1 <input type="checkbox"/> Yes, <input type="checkbox"/> No
			OCC2 <input type="checkbox"/> Yes, <input type="checkbox"/> No
			OCC3 <input type="checkbox"/> Yes, <input type="checkbox"/> No
			OCC4 <input type="checkbox"/> Yes, <input type="checkbox"/> No
		External Paging	PAG1 <input type="checkbox"/> Yes, <input type="checkbox"/> No
			PAG2 <input type="checkbox"/> Yes, <input type="checkbox"/> No
			PAG3 <input type="checkbox"/> Yes, <input type="checkbox"/> No
			PAG4 <input type="checkbox"/> Yes, <input type="checkbox"/> No
			PAG5 <input type="checkbox"/> Yes, <input type="checkbox"/> No
			PAG6 <input type="checkbox"/> Yes, <input type="checkbox"/> No
			PAG7 <input type="checkbox"/> Yes, <input type="checkbox"/> No
			PAG8 <input type="checkbox"/> Yes, <input type="checkbox"/> No
			External paging 1 <input type="checkbox"/> Yes, <input type="checkbox"/> No
			External paging 2 <input type="checkbox"/> Yes, <input type="checkbox"/> No

Class of Service No. 15

Item	Set Data	Item	Set Data
To Restriction Level (Day)	- - (01 to 16)	Trunk Group Access	Trunk Group 01 <input type="checkbox"/> Yes, <input type="checkbox"/> No
To Restriction Level (Night)	(0 1 t o 1 6)		Trunk Group 02 <input type="checkbox"/> Yes, <input type="checkbox"/> No
Max. Dialing Digits	- - - (0 to 255)		Trunk Group 03 <input type="checkbox"/> Yes, <input type="checkbox"/> No
Call Forwarding/Do Not Disturb	<input type="checkbox"/> <input type="checkbox"/>		Trunk Group 04 <input type="checkbox"/> Yes, <input type="checkbox"/> No
Do Not Disturb Override	<input type="checkbox"/> <input type="checkbox"/>		Trunk Group 05 <input type="checkbox"/> Yes, <input type="checkbox"/> No
CO Forward Mode	<input type="checkbox"/> Yes, <input type="checkbox"/>		Trunk Group 06 <input type="checkbox"/> Yes, <input type="checkbox"/> No
CC Transfer Mode	<input type="checkbox"/> <input type="checkbox"/> No		Trunk Group 07 <input type="checkbox"/> Yes, <input type="checkbox"/> No
Forced Account Code Mode	<input type="checkbox"/> <input type="checkbox"/> No		Trunk Group 08 <input type="checkbox"/> Yes, <input type="checkbox"/> No
BSS/OHCA	<input type="checkbox"/> <input type="checkbox"/> No		Trunk Group 09 <input type="checkbox"/> Yes, <input type="checkbox"/> No
BSS/OHCA Deny	<input type="checkbox"/> <input type="checkbox"/>		Trunk Group 10 <input type="checkbox"/> <input type="checkbox"/> No
Executive Busy Override	<input type="checkbox"/> <input type="checkbox"/> No		Trunk Group 11 <input type="checkbox"/> Yes, <input type="checkbox"/> No
Executive Busy Override Deny	<input type="checkbox"/> <input type="checkbox"/> No		Trunk Group 12 <input type="checkbox"/> Yes, <input type="checkbox"/> No
Station Lock	<input type="checkbox"/> <input type="checkbox"/> No		Trunk Group 13 <input type="checkbox"/> Yes, <input type="checkbox"/> No
Walking Station	<input type="checkbox"/> <input type="checkbox"/> No		Trunk Group 14 <input type="checkbox"/> Yes, <input type="checkbox"/> No
Maintenance Capability	<input type="checkbox"/> <input type="checkbox"/>		Trunk Group 15 <input type="checkbox"/> Yes, <input type="checkbox"/> No
ARS/Local Access	<input type="checkbox"/> W/RSTR, <input type="checkbox"/> No RSTR <input type="checkbox"/> No ACCS		Trunk Group 16 <input type="checkbox"/> Yes, <input type="checkbox"/> No
		Special Carrier Access	EQA1 <input type="checkbox"/> Yes, <input type="checkbox"/> No OCC1 <input type="checkbox"/> Yes, <input type="checkbox"/> No EQA2 <input type="checkbox"/> Yes, <input type="checkbox"/> No OCC2 <input type="checkbox"/> Yes, <input type="checkbox"/> No EQA3 <input type="checkbox"/> Yes, <input type="checkbox"/> No OCC3 <input type="checkbox"/> Yes, <input type="checkbox"/> No EQA4 <input type="checkbox"/> Yes, <input type="checkbox"/> No OCC4 <input type="checkbox"/> Yes, <input type="checkbox"/> No
		Station Paging Access	PAG1 <input type="checkbox"/> Yes, <input type="checkbox"/> No PAG5 <input type="checkbox"/> Yes, <input type="checkbox"/> No PAG2 <input type="checkbox"/> Yes, <input type="checkbox"/> No PAG6 <input type="checkbox"/> Yes, <input type="checkbox"/> No PAG3 <input type="checkbox"/> Yes, <input type="checkbox"/> No PAG7 <input type="checkbox"/> Yes, <input type="checkbox"/> No PAG4 <input type="checkbox"/> Yes, <input type="checkbox"/> No PAG8 <input type="checkbox"/> Yes, <input type="checkbox"/> No
		External Paging	External paging 1 <input type="checkbox"/> Yes, <input type="checkbox"/> No External paging 2 <input type="checkbox"/> Yes, <input type="checkbox"/> No

Class of Service No. 16

Item	Set Data	Item	Set Data
Toll Restriction Level (Day)	- - (01 to 16)	Trunk Group Access	Trunk Group 01 <input type="checkbox"/> Yes, <input type="checkbox"/> No
Toll Restriction Level (Night)	(0 1 t o 1 6)		Trunk Group 02 <input type="checkbox"/> Yes, <input type="checkbox"/> No
Max. Dialing Digits	- - - (0 to 255)		Trunk Group 03 <input type="checkbox"/> Yes, <input type="checkbox"/> No
Call Forwarding/Do Not Disturb	<input type="checkbox"/> Yes, <input type="checkbox"/>		Trunk Group 04 <input type="checkbox"/> Yes, <input type="checkbox"/> No
Do Not Disturb Override	<input type="checkbox"/> <input type="checkbox"/>		Trunk Group 05 <input type="checkbox"/> Yes, <input type="checkbox"/> No
CO Forward Mode	<input type="checkbox"/> <input type="checkbox"/>		Trunk Group 06 <input type="checkbox"/> Yes, <input type="checkbox"/> No
CC Transfer Mode	<input type="checkbox"/> <input type="checkbox"/> No		Trunk Group 07 <input type="checkbox"/> Yes, <input type="checkbox"/> No
Forced Account Code Mode	<input type="checkbox"/> <input type="checkbox"/> No		Trunk Group 08 <input type="checkbox"/> Yes, <input type="checkbox"/> No
BSS/OHCA	<input type="checkbox"/> <input type="checkbox"/>		Trunk Group 09 <input type="checkbox"/> Yes, <input type="checkbox"/> No
BSS/OHCA Deny	<input type="checkbox"/> <input type="checkbox"/>		Trunk Group 10 <input type="checkbox"/> Yes, <input type="checkbox"/> No
Executive Busy Override	<input type="checkbox"/> <input type="checkbox"/> No		Trunk Group 11 <input type="checkbox"/> Yes, <input type="checkbox"/> No
Executive Busy Override Deny	<input type="checkbox"/> <input type="checkbox"/>		Trunk Group 12 <input type="checkbox"/> Yes, <input type="checkbox"/> No
Station Lock	<input type="checkbox"/> <input type="checkbox"/>		Trunk Group 13 <input type="checkbox"/> Yes, <input type="checkbox"/> No
Walking Station	<input type="checkbox"/> <input type="checkbox"/> No		Trunk Group 14 <input type="checkbox"/> Yes, <input type="checkbox"/> No
Maintenance Capability	<input type="checkbox"/> Yes, <input type="checkbox"/>		Trunk Group 15 <input type="checkbox"/> Yes, <input type="checkbox"/> No
ARS/Local Access	<input type="checkbox"/> W/RSTR, <input type="checkbox"/> No RSTR <input type="checkbox"/> No ACCS		Trunk Group 16 <input type="checkbox"/> Yes, <input type="checkbox"/> No
		Special Carrier Access	EQA1 <input type="checkbox"/> Yes, <input type="checkbox"/> No OCC1 <input type="checkbox"/> Yes, <input type="checkbox"/> No EQA2 <input type="checkbox"/> Yes, <input type="checkbox"/> No OCC2 <input type="checkbox"/> Yes, <input type="checkbox"/> No EQA3 <input type="checkbox"/> Yes, <input type="checkbox"/> No OCC3 <input type="checkbox"/> Yes, <input type="checkbox"/> No EQA4 <input type="checkbox"/> Yes, <input type="checkbox"/> No OCC4 <input type="checkbox"/> Yes, <input type="checkbox"/> No
		Station Paging Access	PAG1 <input type="checkbox"/> Yes, <input type="checkbox"/> No PAG5 <input type="checkbox"/> Yes, <input type="checkbox"/> No PAG2 <input type="checkbox"/> Yes, <input type="checkbox"/> No PAG6 <input type="checkbox"/> Yes, <input type="checkbox"/> No PAG3 <input type="checkbox"/> Yes, <input type="checkbox"/> No PAG7 <input type="checkbox"/> Yes, <input type="checkbox"/> No PAG4 <input type="checkbox"/> Yes, <input type="checkbox"/> No PAG8 <input type="checkbox"/> Yes, <input type="checkbox"/> No
		External Paging	External paging 1 <input type="checkbox"/> Yes, <input type="checkbox"/> No External paging 2 <input type="checkbox"/> Yes, <input type="checkbox"/> No

Class of Service No. 17

Item	Set Data	Item	Set Data
Toll Restriction Level (Day)	____ (01 to 16)	Trunk Group Access	Trunk Group 01 <input type="checkbox"/> Yes, <input type="checkbox"/> No
Toll Restriction Level (Night)	____ (01 to 16)		Trunk Group 02 <input type="checkbox"/> Yes, <input type="checkbox"/> No
Max. Dialing Digits	____ (0 to 255)		Trunk Group 03 <input type="checkbox"/> Yes, <input type="checkbox"/> No
Call Forwarding/Do Not Disturb	<input type="checkbox"/> Yes, <input type="checkbox"/> No		Trunk Group 04 <input type="checkbox"/> Yes, <input type="checkbox"/> No
Do Not Disturb Override	<input type="checkbox"/> Yes, <input type="checkbox"/> No		Trunk Group 05 <input type="checkbox"/> Yes, <input type="checkbox"/> No
CO Forward Mode	<input type="checkbox"/> Yes, <input type="checkbox"/> No		Trunk Group 06 <input type="checkbox"/> Yes, <input type="checkbox"/> No
CO Transfer Mode	<input type="checkbox"/> Yes, <input type="checkbox"/> No		Trunk Group 07 <input type="checkbox"/> Yes, <input type="checkbox"/> No
Forced Account Code Mode	<input type="checkbox"/> <input type="checkbox"/> <input type="checkbox"/> <input type="checkbox"/>		Trunk Group 08 <input type="checkbox"/> Yes, <input type="checkbox"/> No
BSS/OHCA	<input type="checkbox"/> Yes, <input type="checkbox"/> <input type="checkbox"/>		Trunk Group 09 <input type="checkbox"/> Yes, <input type="checkbox"/> No
BSS/OHCA Deny	<input type="checkbox"/> Yes, <input type="checkbox"/> <input type="checkbox"/>		Trunk Group 10 <input type="checkbox"/> <input type="checkbox"/>
Executive Busy Override	<input type="checkbox"/> Yes, <input type="checkbox"/> No		Trunk Group 11 <input type="checkbox"/> Yes, <input type="checkbox"/> No
Executive Busy Override Deny	<input type="checkbox"/> Yes, <input type="checkbox"/> No		Trunk Group 12 <input type="checkbox"/> Yes, <input type="checkbox"/> No
Station Lock	<input type="checkbox"/> Yes, <input type="checkbox"/> No		Trunk Group 13 <input type="checkbox"/> Yes, <input type="checkbox"/> No
Walking Station	<input type="checkbox"/> <input type="checkbox"/> <input type="checkbox"/> No		Trunk Group 14 <input type="checkbox"/> Yes, <input type="checkbox"/> No
Maintenance Capability	<input type="checkbox"/> Yes, <input type="checkbox"/> No		Trunk Group 15 <input type="checkbox"/> Yes, <input type="checkbox"/> No
ARS/Local Access	<input type="checkbox"/> W/RSTR, <input type="checkbox"/> No RSTR <input type="checkbox"/> No ACCS		Trunk Group 16 <input type="checkbox"/> Yes, <input type="checkbox"/> No
		Special Carrier Access	EQA1 <input type="checkbox"/> Yes, <input type="checkbox"/> No OCC1 <input type="checkbox"/> Yes, <input type="checkbox"/> No EQA2 <input type="checkbox"/> Yes, <input type="checkbox"/> No OCC2 <input type="checkbox"/> Yes, <input type="checkbox"/> No EQA3 <input type="checkbox"/> Yes, <input type="checkbox"/> No OCC3 <input type="checkbox"/> Yes, <input type="checkbox"/> No EQA4 <input type="checkbox"/> Yes, <input type="checkbox"/> No OCC4 <input type="checkbox"/> Yes, <input type="checkbox"/> No
		Station Paging Access	PAG1 <input type="checkbox"/> Yes, <input type="checkbox"/> No PAG5 <input type="checkbox"/> Yes, <input type="checkbox"/> No PAG2 <input type="checkbox"/> Yes, <input type="checkbox"/> No PAG6 <input type="checkbox"/> Yes, <input type="checkbox"/> No PAG3 <input type="checkbox"/> Yes, <input type="checkbox"/> No PAG7 <input type="checkbox"/> Yes, <input type="checkbox"/> No PAG4 <input type="checkbox"/> Yes, <input type="checkbox"/> No PAG8 <input type="checkbox"/> Yes, <input type="checkbox"/> No
		External Paging	External paging 1 <input type="checkbox"/> Yes, <input type="checkbox"/> No External paging 2 <input type="checkbox"/> Yes, <input type="checkbox"/> No

Class of Service No. 18

Item	Set Data	Item	Set Data
Toll Restriction Level (Day)	(0 1 t o 1 6)	Trunk Group Access	Trunk Group 01 <input type="checkbox"/> Yes, <input type="checkbox"/> No
Toll Restriction Level (Night)	(0 1 t o 1 6)		Trunk Group 02 <input type="checkbox"/> Yes, <input type="checkbox"/> No
Max. Dialing Digits	- - - (0 to 255)		Trunk Group 03 <input type="checkbox"/> Yes, <input type="checkbox"/> No
Call Forwarding/Do Not Disturb	<input type="checkbox"/> Yes, <input type="checkbox"/> <input type="checkbox"/>		Trunk Group 04 <input type="checkbox"/> Yes, <input type="checkbox"/> No
Do Not Disturb Override	<input type="checkbox"/> Yes, <input type="checkbox"/> <input type="checkbox"/>		Trunk Group 05 <input type="checkbox"/> Yes, <input type="checkbox"/> No
CO Forward Mode	<input type="checkbox"/> Yes, <input type="checkbox"/> No		Trunk Group 06 <input type="checkbox"/> Yes, <input type="checkbox"/> No
CO Transfer Mode	<input type="checkbox"/> <input type="checkbox"/> <input type="checkbox"/> <input type="checkbox"/>		Trunk Group 07 <input type="checkbox"/> Yes, <input type="checkbox"/> No
Forced Account Code Mode	<input type="checkbox"/> <input type="checkbox"/> <input type="checkbox"/> <input type="checkbox"/> <input type="checkbox"/> No		Trunk Group 08 <input type="checkbox"/> Yes, <input type="checkbox"/> No
BSS/OHCA	<input type="checkbox"/> <input type="checkbox"/> <input type="checkbox"/> No		Trunk Group 09 <input type="checkbox"/> Yes, <input type="checkbox"/> No
BSS/OHCA Deny	<input type="checkbox"/> Yes, <input type="checkbox"/> <input type="checkbox"/>		Trunk Group 10 <input type="checkbox"/> Yes, <input type="checkbox"/> No
Executive Busy Override	<input type="checkbox"/> Yes, <input type="checkbox"/> No		Trunk Group 11 <input type="checkbox"/> Yes, <input type="checkbox"/> No
Executive Busy Override Deny	<input type="checkbox"/> Yes, <input type="checkbox"/> <input type="checkbox"/>		Trunk Group 12 <input type="checkbox"/> Yes, <input type="checkbox"/> No
Station Lock	<input type="checkbox"/> <input type="checkbox"/> <input type="checkbox"/> No		Trunk Group 13 <input type="checkbox"/> Yes, <input type="checkbox"/> No
Walking Station	<input type="checkbox"/> Yes, <input type="checkbox"/> No		Trunk Group 14 <input type="checkbox"/> Yes, <input type="checkbox"/> No
Maintenance Capability	<input type="checkbox"/> <input type="checkbox"/> <input type="checkbox"/> No		Trunk Group 15 <input type="checkbox"/> Yes, <input type="checkbox"/> No
ARS/Local Access	<input type="checkbox"/> W/RSTR, <input type="checkbox"/> NO RSTR <input type="checkbox"/> No ACCS		Trunk Group 16 <input type="checkbox"/> Yes, <input type="checkbox"/> No
		Special Carrier Access	EQA1 <input type="checkbox"/> Yes, <input type="checkbox"/> No OCC1 <input type="checkbox"/> Yes, <input type="checkbox"/> No EQA2 <input type="checkbox"/> Yes, <input type="checkbox"/> No OCC2 <input type="checkbox"/> Yes, <input type="checkbox"/> No EQA3 <input type="checkbox"/> Yes, <input type="checkbox"/> No OCC3 <input type="checkbox"/> Yes, <input type="checkbox"/> No EQA4 <input type="checkbox"/> Yes, <input type="checkbox"/> No OCC4 <input type="checkbox"/> Yes, <input type="checkbox"/> No
		Station Paging Access	PAG1 <input type="checkbox"/> Yes, <input type="checkbox"/> No PAG5 <input type="checkbox"/> Yes, <input type="checkbox"/> No PAG2 <input type="checkbox"/> Yes, <input type="checkbox"/> No PAG6 <input type="checkbox"/> Yes, <input type="checkbox"/> No PAG3 <input type="checkbox"/> Yes, <input type="checkbox"/> No PAG7 <input type="checkbox"/> Yes, <input type="checkbox"/> No PAG4 <input type="checkbox"/> Yes, <input type="checkbox"/> No PAG8 <input type="checkbox"/> Yes, <input type="checkbox"/> No
		External Paging	External paging 1 <input type="checkbox"/> Yes, <input type="checkbox"/> No External paging 2 <input type="checkbox"/> Yes, <input type="checkbox"/> No

Class of Service No. 19

Item	Set Data	Item	Set Data
Toll Restriction Level (Day)	- - (01 to 3)	Trunk Group Access	Trunk Group 01 <input type="checkbox"/> Yes, <input type="checkbox"/> No
Toll Restriction Level (Night)	(0 1 to 3)		Trunk Group 02 <input type="checkbox"/> Yes, <input type="checkbox"/> No
Max Dialing Digits	_____ (0 to 255)		Trunk Group 03 <input type="checkbox"/> Yes, <input type="checkbox"/> No
Call Forwarding/Do Not Disturb	<input type="checkbox"/> Yes, <input type="checkbox"/> No		Trunk Group 04 <input type="checkbox"/> Yes, <input type="checkbox"/> No
Do Not Disturb Override	<input type="checkbox"/> Yes, <input type="checkbox"/> No		Trunk Group 05 <input type="checkbox"/> Yes, <input type="checkbox"/> No
CO Forward Mode	<input type="checkbox"/> Yes, <input type="checkbox"/> No		Trunk Group 06 <input type="checkbox"/> Yes, <input type="checkbox"/> No
CO Transfer Mode	<input type="checkbox"/> Yes, <input type="checkbox"/> No		Trunk Group 07 <input type="checkbox"/> Yes, <input type="checkbox"/> No
Forced Account Code Mode	<input type="checkbox"/> Yes, <input type="checkbox"/> No		Trunk Group 08 <input type="checkbox"/> Yes, <input type="checkbox"/> No
BSS/OHCA	<input type="checkbox"/> Yes, <input type="checkbox"/> No		Trunk Group 09 <input type="checkbox"/> Yes, <input type="checkbox"/> No
BSS/OHCA Deny	<input type="checkbox"/> Yes, <input type="checkbox"/> No		Trunk Group 10 <input type="checkbox"/> Yes, <input type="checkbox"/> No
Executive Busy Override	<input type="checkbox"/> Yes, <input type="checkbox"/> No		Trunk Group 11 <input type="checkbox"/> Yes, <input type="checkbox"/> No
Executive Busy Override Deny	<input type="checkbox"/> Yes, <input type="checkbox"/> No		Trunk Group 12 <input type="checkbox"/> Yes, <input type="checkbox"/> No
Station Lock	<input type="checkbox"/> Yes, <input type="checkbox"/> No		Trunk Group 13 <input type="checkbox"/> Yes, <input type="checkbox"/> No
Walking Station	<input type="checkbox"/> Yes, <input type="checkbox"/> No		Trunk Group 14 <input type="checkbox"/> Yes, <input type="checkbox"/> No
Maintenance Capability	<input type="checkbox"/> Yes, <input type="checkbox"/> No		Trunk Group 15 <input type="checkbox"/> Yes, <input type="checkbox"/> No
ARS/Local Access	<input type="checkbox"/> W/RSTR, <input type="checkbox"/> No RSTR <input type="checkbox"/> No ACCS		Trunk Group 16 <input type="checkbox"/> Yes, <input type="checkbox"/> No
		Special Carrier Access	EQA1 <input type="checkbox"/> Yes, <input type="checkbox"/> No OCC1 <input type="checkbox"/> Yes, <input type="checkbox"/> No EQA2 <input type="checkbox"/> Yes, <input type="checkbox"/> No OCC2 <input type="checkbox"/> Yes, <input type="checkbox"/> No EQA3 <input type="checkbox"/> Yes, <input type="checkbox"/> No OCC3 <input type="checkbox"/> Yes, <input type="checkbox"/> No EQA4 <input type="checkbox"/> Yes, <input type="checkbox"/> No OCC4 <input type="checkbox"/> Yes, <input type="checkbox"/> No
		Station Paging Access	PAG1 <input type="checkbox"/> Yes, <input type="checkbox"/> No PAG5 <input type="checkbox"/> Yes, <input type="checkbox"/> No PAG2 <input type="checkbox"/> Yes, <input type="checkbox"/> No PAG6 <input type="checkbox"/> Yes, <input type="checkbox"/> No PAG3 <input type="checkbox"/> Yes, <input type="checkbox"/> No PAG7 <input type="checkbox"/> Yes, <input type="checkbox"/> No PAG4 <input type="checkbox"/> Yes, <input type="checkbox"/> No PAG8 <input type="checkbox"/> Yes, <input type="checkbox"/> No
		External Paging	External paging 1 <input type="checkbox"/> Yes, <input type="checkbox"/> No External paging 2 <input type="checkbox"/> Yes, <input type="checkbox"/> No

Class of Service No. 20

Item	Set Data	Item	Set Data
Toll Restriction Level (Day)	(0 1 to 16)	Trunk Group Access	Trunk Group 01 <input type="checkbox"/> Yes, <input type="checkbox"/> No
Toll Restriction Level (Night)	(0 1 to 16)		Trunk Group 02 <input type="checkbox"/> Yes, <input type="checkbox"/> No
Max. Dialing Digits	_____ (C to 255)		Trunk Group 03 <input type="checkbox"/> Yes, <input type="checkbox"/> No
Call Forwarding/Do Not Disturb	<input type="checkbox"/> Yes, <input type="checkbox"/> No		Trunk Group 04 <input type="checkbox"/> Yes, <input type="checkbox"/> No
Do Not Disturb Override	<input type="checkbox"/> Yes, <input type="checkbox"/> No		Trunk Group 05 <input type="checkbox"/> Yes, <input type="checkbox"/> No
CO Forward Mode	<input type="checkbox"/> Yes, <input type="checkbox"/> No		Trunk Group 06 <input type="checkbox"/> Yes, <input type="checkbox"/> No
CO Transfer Mode	<input type="checkbox"/> Yes, <input type="checkbox"/> No		Trunk Group 07 <input type="checkbox"/> Yes, <input type="checkbox"/> No
Forced Account Code Mode	<input type="checkbox"/> Yes, <input type="checkbox"/> No		Trunk Group 08 <input type="checkbox"/> Yes, <input type="checkbox"/> No
BSS/OHCA	<input type="checkbox"/> Yes, <input type="checkbox"/> No		Trunk Group 09 <input type="checkbox"/> Yes, <input type="checkbox"/> No
BSS/OHCA Deny	<input type="checkbox"/> Yes, <input type="checkbox"/> No		Trunk Group 10 <input type="checkbox"/> Yes, <input type="checkbox"/> No
Executive Busy Override	<input type="checkbox"/> Yes, <input type="checkbox"/> No		Trunk Group 11 <input type="checkbox"/> Yes, <input type="checkbox"/> No
Executive Busy Override Deny	<input type="checkbox"/> Yes, <input type="checkbox"/> No		Trunk Group 12 <input type="checkbox"/> Yes, <input type="checkbox"/> No
Station Lock	<input type="checkbox"/> Yes, <input type="checkbox"/> No		Trunk Group 13 <input type="checkbox"/> Yes, <input type="checkbox"/> No
Walking Station	<input type="checkbox"/> Yes, <input type="checkbox"/> No		Trunk Group 14 <input type="checkbox"/> Yes, <input type="checkbox"/> No
Maintenance Capability	<input type="checkbox"/> Yes, <input type="checkbox"/> No		Trunk Group 15 <input type="checkbox"/> Yes, <input type="checkbox"/> No
ARS/Local Access	<input type="checkbox"/> W/RSTR, <input type="checkbox"/> No RSTR <input type="checkbox"/> No ACCS		Trunk Group 16 <input type="checkbox"/> Yes, <input type="checkbox"/> No
		Special Carrier Access	EQA1 <input type="checkbox"/> Yes, <input type="checkbox"/> No OCC1 <input type="checkbox"/> Yes, <input type="checkbox"/> No EQA2 <input type="checkbox"/> Yes, <input type="checkbox"/> No OCC2 <input type="checkbox"/> Yes, <input type="checkbox"/> No EQA3 <input type="checkbox"/> Yes, <input type="checkbox"/> No OCC3 <input type="checkbox"/> Yes, <input type="checkbox"/> No EQA4 <input type="checkbox"/> Yes, <input type="checkbox"/> No OCC4 <input type="checkbox"/> Yes, <input type="checkbox"/> No
		Station Paging Access	PAG1 <input type="checkbox"/> Yes, <input type="checkbox"/> No PAG5 <input type="checkbox"/> Yes, <input type="checkbox"/> No PAG2 <input type="checkbox"/> Yes, <input type="checkbox"/> No PAG6 <input type="checkbox"/> Yes, <input type="checkbox"/> No PAG3 <input type="checkbox"/> Yes, <input type="checkbox"/> No PAG7 <input type="checkbox"/> Yes, <input type="checkbox"/> No PAG4 <input type="checkbox"/> Yes, <input type="checkbox"/> No PAG8 <input type="checkbox"/> Yes, <input type="checkbox"/> No
		External Paging	External paging 1 <input type="checkbox"/> Yes, <input type="checkbox"/> No External paging 2 <input type="checkbox"/> Yes, <input type="checkbox"/> No

Class of Service No. 21

Item	Set Data	Item	Set Data
Toll Restriction Level (Day)	(01 to 16)	Trunk Group Access	Trunk Group C1 <input type="checkbox"/> Yes, <input type="checkbox"/> No
Toll Restriction Level (Night)	(01 to 16)		Trunk Group C2 <input type="checkbox"/> Yes, <input type="checkbox"/> No
Max. Dialing Digits	(0 to 255)		Trunk Group 03 <input type="checkbox"/> Yes, <input type="checkbox"/> No
Call Forwarding/Do Not Disturb	<input type="checkbox"/> Yes, <input type="checkbox"/> No		Trunk Group 04 <input type="checkbox"/> Yes, <input type="checkbox"/> No
Do Not Disturb Override	<input type="checkbox"/> Yes, <input type="checkbox"/> No		Trunk Group 05 <input type="checkbox"/> Yes, <input type="checkbox"/> No
CO Forward Mode	<input type="checkbox"/> Yes, <input type="checkbox"/>		Trunk Group 06 <input type="checkbox"/> Yes, <input type="checkbox"/> No
CO Transfer Mode	<input type="checkbox"/> Yes, <input type="checkbox"/>		Trunk Group 07 <input type="checkbox"/> Yes, <input type="checkbox"/> No
Forced Account Code Mode	<input type="checkbox"/> Yes, <input type="checkbox"/> No		Trunk Group 08 <input type="checkbox"/> Yes, <input type="checkbox"/> No
BSS/OHCA	<input type="checkbox"/> Yes, <input type="checkbox"/> No		Trunk Group 09 <input type="checkbox"/> Yes, <input type="checkbox"/> No
BSS/OHCA Deny	<input type="checkbox"/> <input type="checkbox"/> No		Trunk Group 10 <input type="checkbox"/> Yes, <input type="checkbox"/> No
Executive Busy Override	<input type="checkbox"/> Yes, <input type="checkbox"/>		Trunk Group 11 <input type="checkbox"/> Yes, <input type="checkbox"/>
Executive Busy Override Deny	<input type="checkbox"/> Yes, <input type="checkbox"/>		Trunk Group 12 <input type="checkbox"/> Yes, <input type="checkbox"/> No
Station Lock	<input type="checkbox"/> Yes, <input type="checkbox"/> No		Trunk Group 13 <input type="checkbox"/> Yes, <input type="checkbox"/> No
Walking Station	<input type="checkbox"/> Yes, <input type="checkbox"/>		Trunk Group 14 <input type="checkbox"/> Yes, <input type="checkbox"/> No
Maintenance Capability	<input type="checkbox"/> Yes, <input type="checkbox"/>		Trunk Group 15 <input type="checkbox"/> Yes, <input type="checkbox"/> No
ARS/Local Access	<input type="checkbox"/> W/RSTR, <input type="checkbox"/> No RSTR <input type="checkbox"/> No ACCS		Trunk Group 16 <input type="checkbox"/> Yes, <input type="checkbox"/> No
		Special Carrier Access	EQA1 <input type="checkbox"/> Yes, <input type="checkbox"/> No EOA2 <input type="checkbox"/> Yes, <input type="checkbox"/> No EOA3 <input type="checkbox"/> Yes, <input type="checkbox"/> No EOA4 <input type="checkbox"/> Yes, <input type="checkbox"/> No OCC1 <input type="checkbox"/> Yes, <input type="checkbox"/> No OCC2 <input type="checkbox"/> Yes, <input type="checkbox"/> No OCC3 <input type="checkbox"/> Yes, <input type="checkbox"/> No OCC4 <input type="checkbox"/> Yes, <input type="checkbox"/> No
		Station Paging Access	PAG1 <input type="checkbox"/> Yes, <input type="checkbox"/> No PAG2 <input type="checkbox"/> Yes, <input type="checkbox"/> No PAG3 <input type="checkbox"/> Yes, <input type="checkbox"/> No PAG4 <input type="checkbox"/> Yes, <input type="checkbox"/> No PAG5 <input type="checkbox"/> Yes, <input type="checkbox"/> No PAG6 <input type="checkbox"/> Yes, <input type="checkbox"/> No PAG7 <input type="checkbox"/> Yes, <input type="checkbox"/> No PAG8 <input type="checkbox"/> Yes, <input type="checkbox"/> No
		External Paging	External paging 1 <input type="checkbox"/> Yes, <input type="checkbox"/> No External paging 2 <input type="checkbox"/> Yes, <input type="checkbox"/> No

Class of Service No. 22

Item	Set Data	item	Set Data
Toll Restriction Level (Day)	(0 1 t o 1 6)	Trunk Group Access	Trunk Group 01 <input type="checkbox"/> Yes, <input type="checkbox"/> No
Toll Restriction Level (Night)	(0 1 t o 1 6)		Trunk Group 02 <input type="checkbox"/> Yes, <input type="checkbox"/> No
Max. Dialing Digits	(0 to 255)		Trunk Group 03 <input type="checkbox"/> Yes, <input type="checkbox"/> No
Call Forwarding/Do Not Disturb	<input type="checkbox"/> Yes, <input type="checkbox"/> No		Trunk Group 04 <input type="checkbox"/> Yes, <input type="checkbox"/> No
Do Not Disturb Override	<input type="checkbox"/> Yes, <input type="checkbox"/> No		Trunk Group 05 <input type="checkbox"/> Yes, <input type="checkbox"/> No
CO Forward Mode	<input type="checkbox"/> <input type="checkbox"/> No		Trunk Group 06 <input type="checkbox"/> Yes, <input type="checkbox"/> No
CO Transfer Mode	<input type="checkbox"/> Yes, <input type="checkbox"/>		Trunk Group 07 <input type="checkbox"/> Yes, <input type="checkbox"/> No
Forced Account Code Mode	<input type="checkbox"/> Yes, <input type="checkbox"/> No		Trunk Group 08 <input type="checkbox"/> Yes, <input type="checkbox"/> No
BSS/OHCA	<input type="checkbox"/> <input type="checkbox"/> No		Trunk Group 09 <input type="checkbox"/> Yes, <input type="checkbox"/> No
BSS/OHCA Deny	<input type="checkbox"/> Yes, <input type="checkbox"/> No		Trunk Group 10 <input type="checkbox"/> Yes, <input type="checkbox"/> No
Executive Busy Override	<input type="checkbox"/> <input type="checkbox"/>		Trunk Group 11 <input type="checkbox"/> Yes, <input type="checkbox"/> No
Executive Busy Override Deny	<input type="checkbox"/> Yes, <input type="checkbox"/> No		Trunk Group 12 <input type="checkbox"/> Yes, <input type="checkbox"/> No
Station Lock	<input type="checkbox"/> <input type="checkbox"/>		Trunk Group 13 <input type="checkbox"/> Yes, <input type="checkbox"/> No
Walking Station	<input type="checkbox"/> Yes, <input type="checkbox"/>		Trunk Group 14 <input type="checkbox"/> Yes, <input type="checkbox"/> No
Maintenance Capability	<input type="checkbox"/> <input type="checkbox"/>		Trunk Group 15 <input type="checkbox"/> Yes, <input type="checkbox"/> No
ARS/Local Access	<input type="checkbox"/> W/RSTR, <input type="checkbox"/> No RSTR <input type="checkbox"/> No ACCS		Trunk Group 16 <input type="checkbox"/> Yes, <input type="checkbox"/> No
		Special carrier Access	EQA1 <input type="checkbox"/> Yes, <input type="checkbox"/> No EOA2 <input type="checkbox"/> Yes, <input type="checkbox"/> No EOA3 <input type="checkbox"/> Yes, <input type="checkbox"/> No EOA4 <input type="checkbox"/> Yes, <input type="checkbox"/> No OCC1 <input type="checkbox"/> Yes, <input type="checkbox"/> No OCC2 <input type="checkbox"/> Yes, <input type="checkbox"/> No OCC3 <input type="checkbox"/> Yes, <input type="checkbox"/> No OCC4 <input type="checkbox"/> Yes, <input type="checkbox"/> No
		Station Paging Access	PAG1 <input type="checkbox"/> Yes, <input type="checkbox"/> No PAG2 <input type="checkbox"/> Yes, <input type="checkbox"/> No PAG3 <input type="checkbox"/> Yes, <input type="checkbox"/> No PAG4 <input type="checkbox"/> Yes, <input type="checkbox"/> No PAG5 <input type="checkbox"/> Yes, <input type="checkbox"/> No PAG6 <input type="checkbox"/> Yes, <input type="checkbox"/> No PAG7 <input type="checkbox"/> Yes, <input type="checkbox"/> No PAG8 <input type="checkbox"/> Yes, <input type="checkbox"/> No
		External Paging	External paging 1 <input type="checkbox"/> Yes, <input type="checkbox"/> No External paging 2 <input type="checkbox"/> Yes, <input type="checkbox"/> No

Class of Service No. 23

Item	Set Data	Item	Set Data
Toll Restriction Level (Day)	(0 1 t o 1 6)	Trunk Group Access	Trunk Group 01 <input type="checkbox"/> Yes, <input type="checkbox"/> No
Toll Restriction Level (Night)	(0 1 t o 1 6)		Trunk Group 02 <input type="checkbox"/> Yes, <input type="checkbox"/> No
Max. Dialing Digits	_____ (0 to 255)		Trunk Group 03 <input type="checkbox"/> Yes, <input type="checkbox"/> No
Call Forwarding Do Not Disturb	<input type="checkbox"/> Yes, <input type="checkbox"/> No		Trunk Group 04 <input type="checkbox"/> Yes, <input type="checkbox"/> No
Do Not Disturb Override	<input type="checkbox"/> Yes, <input type="checkbox"/> No		Trunk Group 05 <input type="checkbox"/> Yes, <input type="checkbox"/> No
CO Forward Mode	<input type="checkbox"/> Yes, <input type="checkbox"/> No		Trunk Group 06 <input type="checkbox"/> Yes, <input type="checkbox"/> No
CO Transfer Mode	<input type="checkbox"/> Yes, <input type="checkbox"/> No		Trunk Group 07 <input type="checkbox"/> Yes, <input type="checkbox"/> No
Forced Account Code Mode	<input type="checkbox"/> Yes, <input type="checkbox"/> No		Trunk Group 08 <input type="checkbox"/> Yes, <input type="checkbox"/> No
BSS/OHCA	<input type="checkbox"/> Yes, <input type="checkbox"/> No		Trunk Group 09 <input type="checkbox"/> Yes, <input type="checkbox"/> No
BSS/OHCA Deny	<input type="checkbox"/> Yes, <input type="checkbox"/> No		Trunk Group 10 <input type="checkbox"/> Yes, <input type="checkbox"/> No
Executive Busy Override	<input type="checkbox"/> Yes, <input type="checkbox"/> No		Trunk Group 11 <input type="checkbox"/> Yes, <input type="checkbox"/> No
Executive Busy Override Deny	<input type="checkbox"/> Yes, <input type="checkbox"/> No		Trunk Group 12 <input type="checkbox"/> Yes, <input type="checkbox"/> No
Station Lock	<input type="checkbox"/> Yes, <input type="checkbox"/> No		Trunk Group 13 <input type="checkbox"/> Yes, <input type="checkbox"/> No
Walking Station	<input type="checkbox"/> Yes, <input type="checkbox"/> No		Trunk Group 14 <input type="checkbox"/> Yes, <input type="checkbox"/> No
Maintenance Capabifii	<input type="checkbox"/> Yes, <input type="checkbox"/> No		Trunk Group 15 <input type="checkbox"/> Yes, <input type="checkbox"/> No
ARS/Local Access	<input type="checkbox"/> W/RSTR, <input type="checkbox"/> No RSTR <input type="checkbox"/> No ACCS		Trunk Group 16 <input type="checkbox"/> Yes, <input type="checkbox"/> No
		Special Carrier Access	EQA1 <input type="checkbox"/> Yes, <input type="checkbox"/> No EQA2 <input type="checkbox"/> Yes, <input type="checkbox"/> No EQA3 <input type="checkbox"/> Yes, <input type="checkbox"/> No EQA4 <input type="checkbox"/> Yes, <input type="checkbox"/> No OCC1 <input type="checkbox"/> Yes, <input type="checkbox"/> No OCC2 <input type="checkbox"/> Yes, <input type="checkbox"/> No OCC3 <input type="checkbox"/> Yes, <input type="checkbox"/> No OCC4 <input type="checkbox"/> Yes, <input type="checkbox"/> No
		Station Paging Access	PAG1 <input type="checkbox"/> Yes, <input type="checkbox"/> No PAG2 <input type="checkbox"/> Yes, <input type="checkbox"/> No PAG3 <input type="checkbox"/> Yes, <input type="checkbox"/> No PAG4 <input type="checkbox"/> Yes, <input type="checkbox"/> No PAG5 <input type="checkbox"/> Yes, <input type="checkbox"/> No PAG6 <input type="checkbox"/> Yes, <input type="checkbox"/> No PAG7 <input type="checkbox"/> Yes, <input type="checkbox"/> No PAG8 <input type="checkbox"/> Yes, <input type="checkbox"/> No
		External Paging	External paging 1 <input type="checkbox"/> Yes, <input type="checkbox"/> No External paging 2 <input type="checkbox"/> Yes, <input type="checkbox"/> No

Class of Service No. 24

item	Set Data	Item	Set Data
Toll Restriction Level (Day)	(0 1 t o 1 6)	Trunk Group Access	Trunk Group 01 <input type="checkbox"/> Yes, <input type="checkbox"/> No
Toll Restriction Level (Night)	(0 1 t o 1 6)		Trunk Group 02 <input type="checkbox"/> Yes, <input type="checkbox"/> No
Max. Dialing Digits	_____ (0 to 255)		Trunk Group 03 <input type="checkbox"/> Yes, <input type="checkbox"/> No
Call Forwarding/Do Not Disturb	<input type="checkbox"/> Yes, <input type="checkbox"/> No		Trunk Group 04 <input type="checkbox"/> Yes, <input type="checkbox"/> No
Do Not Disturb Override	<input type="checkbox"/> Yes, <input type="checkbox"/> No		Trunk Group 05 <input type="checkbox"/> Yes, <input type="checkbox"/> No
CO Forward Mods	<input type="checkbox"/> Yes, <input type="checkbox"/> No		Trunk Group 06 <input type="checkbox"/> Yes, <input type="checkbox"/> No
CO Transfer Mode	<input type="checkbox"/> Yes, <input type="checkbox"/> No		Trunk Group 07 <input type="checkbox"/> Yes, <input type="checkbox"/> No
Forced Account Code Mode	<input type="checkbox"/> Yes, <input type="checkbox"/> No		Trunk Group 08 <input type="checkbox"/> Yes, <input type="checkbox"/> No
BSS/OHCA	<input type="checkbox"/> Yes, <input type="checkbox"/> No		Trunk Group 09 <input type="checkbox"/> Yes, <input type="checkbox"/> No
BSS/OHCA Deny	<input type="checkbox"/> Yes, <input type="checkbox"/> No		Trunk Group 10 <input type="checkbox"/> Yes, <input type="checkbox"/> No
Executive Busy Override	<input type="checkbox"/> Yes, <input type="checkbox"/> No		Trunk Group 11 <input type="checkbox"/> Yes, <input type="checkbox"/> No
Executive Busy Override Deny	<input type="checkbox"/> Yes, <input type="checkbox"/> No		Trunk Group 12 <input type="checkbox"/> Yes, <input type="checkbox"/> No
Station Lock	<input type="checkbox"/> Yes, <input type="checkbox"/> No		Trunk Group 13 <input type="checkbox"/> Yes, <input type="checkbox"/> No
Walking Station	<input type="checkbox"/> Yes, <input type="checkbox"/> No		Trunk Group 14 <input type="checkbox"/> Yes, <input type="checkbox"/> No
Maintenance Capability	<input type="checkbox"/> Yes, <input type="checkbox"/> No		Trunk Group 15 <input type="checkbox"/> Yes, <input type="checkbox"/> No
ARS/Local Access	<input type="checkbox"/> W/RSTR, <input type="checkbox"/> NO RSTR <input type="checkbox"/> No ACCS		Trunk Group 16 <input type="checkbox"/> Yes, <input type="checkbox"/> No
		Special Carrier Access	EQA1 <input type="checkbox"/> Yes, <input type="checkbox"/> No EQA2 <input type="checkbox"/> Yes, <input type="checkbox"/> No EQA3 <input type="checkbox"/> Yes, <input type="checkbox"/> No EQA4 <input type="checkbox"/> Yes, <input type="checkbox"/> No OCC1 <input type="checkbox"/> Yes, <input type="checkbox"/> No OCC2 <input type="checkbox"/> Yes, <input type="checkbox"/> No OCC3 <input type="checkbox"/> Yes, <input type="checkbox"/> No OCC4 <input type="checkbox"/> Yes, <input type="checkbox"/> No
		Station Paging Access	PAG1 <input type="checkbox"/> Yes, <input type="checkbox"/> No PAG2 <input type="checkbox"/> Yes, <input type="checkbox"/> No PAG3 <input type="checkbox"/> Yes, <input type="checkbox"/> No PAG4 <input type="checkbox"/> Yes, <input type="checkbox"/> No PAG5 <input type="checkbox"/> Yes, <input type="checkbox"/> No PAG6 <input type="checkbox"/> Yes, <input type="checkbox"/> No PAG7 <input type="checkbox"/> Yes, <input type="checkbox"/> No PAG8 <input type="checkbox"/> Yes, <input type="checkbox"/> No
		External Paging	External paging 1 <input type="checkbox"/> Yes, <input type="checkbox"/> No External paging 2 <input type="checkbox"/> Yes, <input type="checkbox"/> No

Class of Service No. 25

Item	Set Data	Item	Set Data
Toll Restriction Level (Day)	____ (01 to 16)	Trunk Group Access	Trunk Group 01 <input type="checkbox"/> Yes, <input type="checkbox"/> No
Toll Restriction Level (Night)	____ (01 to 16)		Trunk Group 02 <input type="checkbox"/> Yes, <input type="checkbox"/> No
Max. Dialing Digits	____ (0 to 255)		Trunk Group 03 <input type="checkbox"/> Yes, <input type="checkbox"/> No
Call Forwarding/Do Not Disturb	<input type="checkbox"/> Yes, <input type="checkbox"/> No		Trunk Group 04 <input type="checkbox"/> Yes, <input type="checkbox"/> No
Do Not Disturb Override	<input type="checkbox"/> Yes, <input type="checkbox"/> No		Trunk Group 05 <input type="checkbox"/> Yes, <input type="checkbox"/> No
CO Forward Mode	<input type="checkbox"/> Yes, <input type="checkbox"/> No		Trunk Group 06 <input type="checkbox"/> Yes, <input type="checkbox"/> No
CO Transfer Mode	<input type="checkbox"/> Yes, <input type="checkbox"/> No		Trunk Group 07 <input type="checkbox"/> Yes, <input type="checkbox"/> No
Forced Account Code Mode	<input type="checkbox"/> Yes, <input type="checkbox"/> No		Trunk Group 08 <input type="checkbox"/> Yes, <input type="checkbox"/> No
BSS/OHCA	<input type="checkbox"/> Yes, <input type="checkbox"/> No		Trunk Group 09 <input type="checkbox"/> Yes, <input type="checkbox"/> No
BSS/OHCA Deny	<input type="checkbox"/> Yes, <input type="checkbox"/> No		Trunk Group 10 <input type="checkbox"/> Yes, <input type="checkbox"/> No
Executive Busy Override	<input type="checkbox"/> Yes, <input type="checkbox"/> No		Trunk Group 11 <input type="checkbox"/> Yes, <input type="checkbox"/> No
Executive Busy Override Deny	<input type="checkbox"/> Yes, <input type="checkbox"/> No		Trunk Group 12 <input type="checkbox"/> Yes, <input type="checkbox"/> No
Station Lock	<input type="checkbox"/> Yes, <input type="checkbox"/> No		Trunk Group 13 <input type="checkbox"/> Yes, <input type="checkbox"/> No
Walking Station	<input type="checkbox"/> Yes, <input type="checkbox"/> No		Trunk Group 14 <input type="checkbox"/> Yes, <input type="checkbox"/> No
Maintenance Capability	<input type="checkbox"/> Yes, <input type="checkbox"/> No		Trunk Group 15 <input type="checkbox"/> Yes, <input type="checkbox"/> No
ARS/Local Access	<input type="checkbox"/> W/RSTR, <input type="checkbox"/> No RSTR <input type="checkbox"/> No ACCS		Trunk Group 16 <input type="checkbox"/> Yes, <input type="checkbox"/> No
		Special Carrier Access	EQA1 <input type="checkbox"/> Yes, <input type="checkbox"/> No OCC1 <input type="checkbox"/> Yes, <input type="checkbox"/> No EQA2 <input type="checkbox"/> Yes, <input type="checkbox"/> No OCC2 <input type="checkbox"/> Yes, <input type="checkbox"/> No EQA3 <input type="checkbox"/> Yes, <input type="checkbox"/> No OCC3 <input type="checkbox"/> Yes, <input type="checkbox"/> No EQA4 <input type="checkbox"/> Yes, <input type="checkbox"/> No OCC4 <input type="checkbox"/> Yes, <input type="checkbox"/> No
		Station Paging Access	PAG1 <input type="checkbox"/> Yes, <input type="checkbox"/> No PAG5 <input type="checkbox"/> Yes, <input type="checkbox"/> No PAG2 <input type="checkbox"/> Yes, <input type="checkbox"/> No PAG6 <input type="checkbox"/> Yes, <input type="checkbox"/> No PAG3 <input type="checkbox"/> Yes, <input type="checkbox"/> No PAG7 <input type="checkbox"/> Yes, <input type="checkbox"/> No PAG4 <input type="checkbox"/> Yes, <input type="checkbox"/> No PAG8 <input type="checkbox"/> Yes, <input type="checkbox"/> No
		External Paging	External paging 1 <input type="checkbox"/> Yes, <input type="checkbox"/> No External paging 2 <input type="checkbox"/> Yes, <input type="checkbox"/> No

Class of Service No. 26

Item	Set Data	Item	Set Data
Toll Restriction Level (Day)	- - (01 to 16)	Trunk Group Access	Trunk Group 01 <input type="checkbox"/> Yes, <input type="checkbox"/> No
Toll Restriction Level (Night)	- - (01 to 16)		Trunk Group 02 <input type="checkbox"/> Yes, <input type="checkbox"/> No
Max. Dialing Digits	- - - (0 to 255)		Trunk Group 03 <input type="checkbox"/> Yes, <input type="checkbox"/> No
Call Forwarding/Do Not Disturb	<input type="checkbox"/> Yes, <input type="checkbox"/> No		Trunk Group 04 <input type="checkbox"/> Yes, <input type="checkbox"/> No
Do Not Disturb Override	<input type="checkbox"/> Yes, <input type="checkbox"/> No		Trunk Group 05 <input type="checkbox"/> Yes, <input type="checkbox"/> No
CO Forward Mode	<input type="checkbox"/> Yes, <input type="checkbox"/> No		Trunk Group 06 <input type="checkbox"/> Yes, <input type="checkbox"/> No
CO Transfer Mode	<input type="checkbox"/> Yes, <input type="checkbox"/> No		Trunk Group 07 <input type="checkbox"/> Yes, <input type="checkbox"/> No
Forced Account Code Mode	<input type="checkbox"/> Yes, <input type="checkbox"/> No		Trunk Group 08 <input type="checkbox"/> Yes, <input type="checkbox"/> No
BSS/OHCA	<input type="checkbox"/> Yes, <input type="checkbox"/> No		Trunk Group 09 <input type="checkbox"/> Yes, <input type="checkbox"/> No
BSS/OHCA Deny	<input type="checkbox"/> Yes, <input type="checkbox"/> No		Trunk Group 10 <input type="checkbox"/> Yes, <input type="checkbox"/> No
Executive Busy Override	<input type="checkbox"/> Yes, <input type="checkbox"/> No		Trunk Group 11 <input type="checkbox"/> Yes, <input type="checkbox"/> No
Executive Busy Override Deny	<input type="checkbox"/> Yes, <input type="checkbox"/> No		Trunk Group 12 <input type="checkbox"/> Yes, <input type="checkbox"/> No
Station Lock	<input type="checkbox"/> Yes, <input type="checkbox"/> No		Trunk Group 13 <input type="checkbox"/> Yes, <input type="checkbox"/> No
Walking Station	<input type="checkbox"/> Yes, <input type="checkbox"/> No		Trunk Group 14 <input type="checkbox"/> Yes, <input type="checkbox"/> No
Maintenance Capability	<input type="checkbox"/> Yes, <input type="checkbox"/> No		Trunk Group 15 <input type="checkbox"/> Yes, <input type="checkbox"/> No
ARS/Local Access	<input type="checkbox"/> W/RSTR, <input type="checkbox"/> No RSTR <input type="checkbox"/> No ACCS		Trunk Group 16 <input type="checkbox"/> Yes, <input type="checkbox"/> No
		Special Carrier Access	EQA1 <input type="checkbox"/> Yes, <input type="checkbox"/> No OCC1 <input type="checkbox"/> Yes, <input type="checkbox"/> No EQA2 <input type="checkbox"/> Yes, <input type="checkbox"/> No OCC2 <input type="checkbox"/> Yes, <input type="checkbox"/> No EQA3 <input type="checkbox"/> Yes, <input type="checkbox"/> No OCC3 <input type="checkbox"/> Yes, <input type="checkbox"/> No EQA4 <input type="checkbox"/> Yes, <input type="checkbox"/> No OCC4 <input type="checkbox"/> Yes, <input type="checkbox"/> No
		Station Paging Access	PAG1 <input type="checkbox"/> Yes, <input type="checkbox"/> No PAG5 <input type="checkbox"/> Yes, <input type="checkbox"/> No PAG2 <input type="checkbox"/> Yes, <input type="checkbox"/> No PAG6 <input type="checkbox"/> Yes, <input type="checkbox"/> No PAG3 <input type="checkbox"/> Yes, <input type="checkbox"/> No PAG7 <input type="checkbox"/> Yes, <input type="checkbox"/> No PAG4 <input type="checkbox"/> Yes, <input type="checkbox"/> No PAG8 <input type="checkbox"/> Yes, <input type="checkbox"/> No
		External Paging	External paging 1 <input type="checkbox"/> Yes, <input type="checkbox"/> No External paging 2 <input type="checkbox"/> Yes, <input type="checkbox"/> No

Class of Service No. 27

item	Set Data	Item	Set Data
Toll Restriction Level (Day)	- - (01 to 16)	Trunk Group Access	Trunk Group 01 <input type="checkbox"/> Yes, <input type="checkbox"/> No
Toll Restriction Level (Night)	- - (01 to 16)		Trunk Group 02 <input type="checkbox"/> Yes, <input type="checkbox"/> No
Max Dialing Digits	- - - (0 to 255)		Trunk Group 03 <input type="checkbox"/> Yes, <input type="checkbox"/> No
Call Forwarding/Do Not Disturb	<input type="checkbox"/> Yes, <input type="checkbox"/> No		Trunk Group 04 <input type="checkbox"/> Yes, <input type="checkbox"/> No
Do Not Disturb Override	<input type="checkbox"/> Yes, <input type="checkbox"/> No		Trunk Group 05 <input type="checkbox"/> Yes, <input type="checkbox"/> No
CO Forward Mode	<input type="checkbox"/> Yes, <input type="checkbox"/> No		Trunk Group 06 <input type="checkbox"/> Yes, <input type="checkbox"/> No
CO Transfer Mode	<input type="checkbox"/> Yes, <input type="checkbox"/> No		Trunk Group 07 <input type="checkbox"/> Yes, <input type="checkbox"/> No
Forced Account Code Mode	<input type="checkbox"/> Yes, <input type="checkbox"/> No		Trunk Group 08 <input type="checkbox"/> Yes, <input type="checkbox"/> No
BSS/OHCA	<input type="checkbox"/> Yes, <input type="checkbox"/> No		Trunk Group 09 <input type="checkbox"/> Yes, <input type="checkbox"/> No
BSS/OHCA Deny	<input type="checkbox"/> Yes, <input type="checkbox"/> No		Trunk Group 10 <input type="checkbox"/> Yes, <input type="checkbox"/> No
Executive Busy Override	<input type="checkbox"/> Yes, <input type="checkbox"/> No		Trunk Group 11 <input type="checkbox"/> Yes, <input type="checkbox"/> No
Executive Busy Override Deny	<input type="checkbox"/> Yes, <input type="checkbox"/> No		Trunk Group 12 <input type="checkbox"/> Yes, <input type="checkbox"/> No
Station Lock	<input type="checkbox"/> Yes, <input type="checkbox"/> No		Trunk Group 13 <input type="checkbox"/> Yes, <input type="checkbox"/> No
Walking Station	<input type="checkbox"/> Yes, <input type="checkbox"/> No		Trunk Group 14 <input type="checkbox"/> Yes, <input type="checkbox"/> No
Maintenance Capability	<input type="checkbox"/> Yes, <input type="checkbox"/> No		Trunk Group 15 <input type="checkbox"/> Yes, <input type="checkbox"/> No
ARS/Local Access	<input type="checkbox"/> W/RSTR, <input type="checkbox"/> No RSTR <input type="checkbox"/> No ACCS		Trunk Group 16 <input type="checkbox"/> Yes, <input type="checkbox"/> No
		Special Carrier Access	EQA1 <input type="checkbox"/> Yes, <input type="checkbox"/> No EQA2 <input type="checkbox"/> Yes, <input type="checkbox"/> No EQA3 <input type="checkbox"/> Yes, <input type="checkbox"/> No EOA4 <input type="checkbox"/> Yes, <input type="checkbox"/> No OCC1 <input type="checkbox"/> Yes, <input type="checkbox"/> No OCC2 <input type="checkbox"/> Yes, <input type="checkbox"/> No OCC3 <input type="checkbox"/> Yes, <input type="checkbox"/> No OCC4 <input type="checkbox"/> Yes, <input type="checkbox"/> No
		Station Paging Access	PAG1 <input type="checkbox"/> Yes, <input type="checkbox"/> No PAG2 <input type="checkbox"/> Yes, <input type="checkbox"/> No PAG3 <input type="checkbox"/> Yes, <input type="checkbox"/> No PAG4 <input type="checkbox"/> Yes, <input type="checkbox"/> No PAG5 <input type="checkbox"/> Yes, <input type="checkbox"/> No PAG6 <input type="checkbox"/> Yes, <input type="checkbox"/> No PAG7 <input type="checkbox"/> Yes, <input type="checkbox"/> No PAG8 <input type="checkbox"/> Yes, <input type="checkbox"/> No
		External Paging	External paging 1 <input type="checkbox"/> Yes, <input type="checkbox"/> No External paging 2 <input type="checkbox"/> Yes, <input type="checkbox"/> No

Class of Service No. 28

Item	Set Data	item	Set Data
Toll Restriction Level (Day)	(0 1 t o 1 6)	Trunk Group Access	Trunk Group 01 <input type="checkbox"/> Yes, <input type="checkbox"/> No
Toll Restriction Level (Night)	(0 1 t o 1 6)		Trunk Group 02 <input type="checkbox"/> Yes, <input type="checkbox"/> No
Max. Dialing Digits	- - - (0 t o 2 5 5)		Trunk Group 03 <input type="checkbox"/> Yes, <input type="checkbox"/> No
Call Forwarding/Do Not Disturb	<input type="checkbox"/> Yes, <input type="checkbox"/> No		Trunk Group 04 <input type="checkbox"/> Yes, <input type="checkbox"/> No
Do Not Disturb Override	<input type="checkbox"/> Yes, <input type="checkbox"/> No		Trunk Group 05 <input type="checkbox"/> Yes, <input type="checkbox"/> No
CO Forward Mode	<input type="checkbox"/> Yes, <input type="checkbox"/> No		Trunk Group 06 <input type="checkbox"/> Yes, <input type="checkbox"/> No
CO Transfer Mode	<input type="checkbox"/> Yes, <input type="checkbox"/> No		Trunk Group 07 <input type="checkbox"/> Yes, <input type="checkbox"/> No
Forced Account Code Mode	<input type="checkbox"/> Yes, <input type="checkbox"/> No		Trunk Group 08 <input type="checkbox"/> Yes, <input type="checkbox"/> No
BSS/OHCA	<input type="checkbox"/> Yes, <input type="checkbox"/> No		Trunk Group 09 <input type="checkbox"/> Yes, <input type="checkbox"/> No
BSS/OHCA Deny	<input type="checkbox"/> Yes, <input type="checkbox"/> No		Trunk Group 10 <input type="checkbox"/> Yes, <input type="checkbox"/> No
Executive Busy Override	<input type="checkbox"/> Yes, <input type="checkbox"/> No		Trunk Group 11 <input type="checkbox"/> Yes, <input type="checkbox"/> No
Executive Busy Override Deny	<input type="checkbox"/> Yes, <input type="checkbox"/> No		Trunk Group 12 <input type="checkbox"/> Yes, <input type="checkbox"/> No
Station Lock	<input type="checkbox"/> Yes, <input type="checkbox"/> No		Trunk Group 13 <input type="checkbox"/> Yes, <input type="checkbox"/> No
Walking Station	<input type="checkbox"/> Yes, <input type="checkbox"/> No		Trunk Group 14 <input type="checkbox"/> Yes, <input type="checkbox"/> No
Maintenance Capability	<input type="checkbox"/> Yes, <input type="checkbox"/> No		Trunk Group 15 <input type="checkbox"/> Yes, <input type="checkbox"/> No
ARS/Local Access	<input type="checkbox"/> W/RSTR, <input type="checkbox"/> No RSTR <input type="checkbox"/> No ACCS		Trunk Group 16 <input type="checkbox"/> Yes, <input type="checkbox"/> No
		Special Carrier Access	EQA1 <input type="checkbox"/> Yes, <input type="checkbox"/> No EQA2 <input type="checkbox"/> Yes, <input type="checkbox"/> No EQA3 <input type="checkbox"/> Yes, <input type="checkbox"/> No EOA4 <input type="checkbox"/> Yes, <input type="checkbox"/> No OCC1 <input type="checkbox"/> Yes, <input type="checkbox"/> No OCC2 <input type="checkbox"/> Yes, <input type="checkbox"/> No OCC3 <input type="checkbox"/> Yes, <input type="checkbox"/> No OCC4 <input type="checkbox"/> Yes, <input type="checkbox"/> No
		Station Paging Access	PAG1 <input type="checkbox"/> Yes, <input type="checkbox"/> No PAG2 <input type="checkbox"/> Yes, <input type="checkbox"/> No PAG3 <input type="checkbox"/> Yes, <input type="checkbox"/> No PAG4 <input type="checkbox"/> Yes, <input type="checkbox"/> No PAG5 <input type="checkbox"/> Yes, <input type="checkbox"/> No PAG6 <input type="checkbox"/> Yes, <input type="checkbox"/> No PAG7 <input type="checkbox"/> Yes, <input type="checkbox"/> No PAG8 <input type="checkbox"/> Yes, <input type="checkbox"/> No
		External Paging	External paging 1 <input type="checkbox"/> Yes, <input type="checkbox"/> No External paging 2 <input type="checkbox"/> Yes, <input type="checkbox"/> No

Class of Service No. 29

Item	Set Data	Item	Set Data
Toll Restriction Level (Day)	____ (01 to 16)	Trunk Group Access	Trunk Group 01 <input type="checkbox"/> Yes, <input type="checkbox"/> No
Toll Restriction Level (Night)	(0 1 t o 1 6)		Trunk Group 02 <input type="checkbox"/> Yes, <input type="checkbox"/> No
Max. Dialing Digits	_____ (0 to 255)		Trunk Group 03 <input type="checkbox"/> Yes, <input type="checkbox"/> No
Call Forwarding/Do Not Disturb	<input type="checkbox"/> Yes, <input type="checkbox"/> No		Trunk Group 04 <input type="checkbox"/> Yes, <input type="checkbox"/> No
Do Not Disturb Override	<input type="checkbox"/> Yes, <input type="checkbox"/> No		Trunk Group 05 <input type="checkbox"/> Yes, <input type="checkbox"/> No
CO Forward Mode	<input type="checkbox"/> Yes, <input type="checkbox"/> No		Trunk Group 06 <input type="checkbox"/> Yes, <input type="checkbox"/> No
CO Transfer Mode	<input type="checkbox"/> Yes, <input type="checkbox"/> No		Trunk Group 07 <input type="checkbox"/> Yes, <input type="checkbox"/> No
Forced Account Code Mode	<input type="checkbox"/> Yes, <input type="checkbox"/> No		Trunk Group 08 <input type="checkbox"/> Yes, <input type="checkbox"/> No
BSS/OHCA	<input type="checkbox"/> Yes, <input type="checkbox"/> No		Trunk Group 09 <input type="checkbox"/> Yes, <input type="checkbox"/> No
BSS/OHCA Deny	<input type="checkbox"/> Yes, <input type="checkbox"/> No		Trunk Group 10 <input type="checkbox"/> Yes, <input type="checkbox"/> No
Executive Busy Override	<input type="checkbox"/> Yes, <input type="checkbox"/> No		Trunk Group 11 <input type="checkbox"/> Yes, <input type="checkbox"/> No
Executive Busy Override Deny	<input type="checkbox"/> Yes, <input type="checkbox"/> No		Trunk Group 12 <input type="checkbox"/> Yes, <input type="checkbox"/> No
Station Lock	<input type="checkbox"/> Yes, <input type="checkbox"/> No		Trunk Group 13 <input type="checkbox"/> Yes, <input type="checkbox"/> No
Walking Station	<input type="checkbox"/> Yes, <input type="checkbox"/> No		Trunk Group 14 <input type="checkbox"/> Yes, <input type="checkbox"/> No
Maintenance Capability	<input type="checkbox"/> Yes, <input type="checkbox"/> No		Trunk Group 15 <input type="checkbox"/> Yes, <input type="checkbox"/> No
ARS/Local Access	<input type="checkbox"/> W/RSTR, <input type="checkbox"/> No RSTR <input type="checkbox"/> No ACCS		Trunk Group 16 <input type="checkbox"/> Yes, <input type="checkbox"/> No
		Sped Carrier Access	EQA1 <input type="checkbox"/> Yes, <input type="checkbox"/> No OCC1 <input type="checkbox"/> Yes, <input type="checkbox"/> No EQA2 <input type="checkbox"/> Yes, <input type="checkbox"/> No OCC2 <input type="checkbox"/> Yes, <input type="checkbox"/> No EQA3 <input type="checkbox"/> Yes, <input type="checkbox"/> No OCC3 <input type="checkbox"/> Yes, <input type="checkbox"/> No EQA4 <input type="checkbox"/> Yes, <input type="checkbox"/> No OCC4 <input type="checkbox"/> Yes, <input type="checkbox"/> No
		Station Paging Access	PAG1 <input type="checkbox"/> Yes, <input type="checkbox"/> No PAG5 <input type="checkbox"/> Yes, <input type="checkbox"/> No PAG2 <input type="checkbox"/> Yes, <input type="checkbox"/> No PAG6 <input type="checkbox"/> Yes, <input type="checkbox"/> No PAG3 <input type="checkbox"/> Yes, <input type="checkbox"/> No PAG7 <input type="checkbox"/> Yes, <input type="checkbox"/> No PAG4 <input type="checkbox"/> Yes, <input type="checkbox"/> No PAG8 <input type="checkbox"/> Yes, <input type="checkbox"/> No
		External Paging	External paging 1 <input type="checkbox"/> Yes, <input type="checkbox"/> No External paging 2 <input type="checkbox"/> Yes, <input type="checkbox"/> No

Class of Service No. 30

Item	Set Data	Item	Set Data
Toll Restriction Level (Day)	- - (01 to 16)	Trunk Group Access	Trunk Group 01 <input type="checkbox"/> Yes, <input type="checkbox"/> No
Toll Restriction Level (Night)	- - (01 to 16)		Trunk Group 02 <input type="checkbox"/> Yes, <input type="checkbox"/> No
Max. Dialing Digits	- - - (0 to 255)		Trunk Group 03 <input type="checkbox"/> Yes, <input type="checkbox"/> No
Call Forwarding/Do Not Disturb	<input type="checkbox"/> Yes, <input type="checkbox"/> No		Trunk Group 04 <input type="checkbox"/> Yes, <input type="checkbox"/> No
Do Not Disturb Override	<input type="checkbox"/> Yes, <input type="checkbox"/> No		Trunk Group 05 <input type="checkbox"/> Yes, <input type="checkbox"/> No
CO Forward Mode	<input type="checkbox"/> Yes, <input type="checkbox"/> No		Trunk Group 06 <input type="checkbox"/> Yes, <input type="checkbox"/> No
CO Transfer Mode	<input type="checkbox"/> Yes, <input type="checkbox"/> No		Trunk Group 07 <input type="checkbox"/> Yes, <input type="checkbox"/> No
Forced Account Code Mode	<input type="checkbox"/> Yes, <input type="checkbox"/> No		Trunk Group 08 <input type="checkbox"/> Yes, <input type="checkbox"/> No
BSS/OHCA	<input type="checkbox"/> Yes, <input type="checkbox"/> No		Trunk Group 09 <input type="checkbox"/> Yes, <input type="checkbox"/> No
BSS/OHCA Deny	<input type="checkbox"/> Yes, <input type="checkbox"/> No		Trunk Group 10 <input type="checkbox"/> Yes, <input type="checkbox"/> No
Executive Busy Override	<input type="checkbox"/> Yes, <input type="checkbox"/> No		Trunk Group 11 <input type="checkbox"/> Yes, <input type="checkbox"/> No
Executive Busy Override Deny	<input type="checkbox"/> Yes, <input type="checkbox"/> No		Trunk Group 12 <input type="checkbox"/> Yes, <input type="checkbox"/> No
Station Lock	<input type="checkbox"/> Yes, <input type="checkbox"/> No		Trunk Group 13 <input type="checkbox"/> Yes, <input type="checkbox"/> No
Walking Station	<input type="checkbox"/> Yes, <input type="checkbox"/> No		Trunk Group 14 <input type="checkbox"/> Yes, <input type="checkbox"/> No
Maintenance Capability	<input type="checkbox"/> Yes, <input type="checkbox"/> No		Trunk Group 15 <input type="checkbox"/> Yes, <input type="checkbox"/> No
ARS/Local Access	<input type="checkbox"/> W/RSTR, <input type="checkbox"/> No RSTR <input type="checkbox"/> No ACCS		Trunk Group 16 <input type="checkbox"/> Yes, <input type="checkbox"/> No
		Special carrier Access	EQA1 <input type="checkbox"/> Yes, <input type="checkbox"/> No OCC1 <input type="checkbox"/> Yes, <input type="checkbox"/> No EQA2 <input type="checkbox"/> Yes, <input type="checkbox"/> No OCC2 <input type="checkbox"/> Yes, <input type="checkbox"/> No EQA3 <input type="checkbox"/> Yes, <input type="checkbox"/> No OCC3 <input type="checkbox"/> Yes, <input type="checkbox"/> No EQA4 <input type="checkbox"/> Yes, <input type="checkbox"/> No OCC4 <input type="checkbox"/> Yes, <input type="checkbox"/> No
		Station Paging Access	PAG1 <input type="checkbox"/> Yes, <input type="checkbox"/> No PAG5 <input type="checkbox"/> Yes, <input type="checkbox"/> No PAG2 <input type="checkbox"/> Yes, <input type="checkbox"/> No PAG6 <input type="checkbox"/> Yes, <input type="checkbox"/> No PAG3 <input type="checkbox"/> Yes, <input type="checkbox"/> No PAG7 <input type="checkbox"/> Yes, <input type="checkbox"/> No PAG4 <input type="checkbox"/> Yes, <input type="checkbox"/> No PAG8 <input type="checkbox"/> Yes, <input type="checkbox"/> No
		External Paging	External paging 1 <input type="checkbox"/> Yes, <input type="checkbox"/> No External paging 2 <input type="checkbox"/> Yes, <input type="checkbox"/> No

Class of Service No. 31

Item	Set Data	Item	Set Data
To: Restriction Level (Day)	<u> </u> (01 to 16)	Trunk Group Access	Trunk Group 01 <input type="checkbox"/> Yes, <input type="checkbox"/> No
To: Restriction Level (Night)	(<u>0 1</u> t o 1 6)		Trunk Group 02 <input type="checkbox"/> Yes, <input type="checkbox"/> No
Max Dialing Digits	- - - (0 to 2 5 5)		Trunk Group 03 <input type="checkbox"/> Yes, <input type="checkbox"/> No
Call Forwarding Do Not Disturb	<input type="checkbox"/> Yes, <input type="checkbox"/> No		Trunk Group 04 <input type="checkbox"/> Yes, <input type="checkbox"/> No
Do Not Disturb Override	<input type="checkbox"/> Yes, <input type="checkbox"/> No		Trunk Group 05 <input type="checkbox"/> Yes, <input type="checkbox"/> No
CO Forward Mode	<input type="checkbox"/> Yes, <input type="checkbox"/> No		Trunk Group 06 <input type="checkbox"/> Yes, <input type="checkbox"/> No
CO Transfer Mode	<input type="checkbox"/> Yes, <input type="checkbox"/> No		Trunk Group 07 <input type="checkbox"/> Yes, <input type="checkbox"/> No
Forced Account Code Mode	<input type="checkbox"/> Yes, <input type="checkbox"/> No		Trunk Group 08 <input type="checkbox"/> Yes, <input type="checkbox"/> No
BSS/OHCA	<input type="checkbox"/> Yes, <input type="checkbox"/> No		Trunk Group 09 <input type="checkbox"/> Yes, <input type="checkbox"/> No
BSS/OHCA Deny	<input type="checkbox"/> Yes, <input type="checkbox"/> No		Trunk Group 10 <input type="checkbox"/> Yes, <input type="checkbox"/> No
Executive Busy Override	<input type="checkbox"/> Yes, <input type="checkbox"/> No		Trunk Group 11 <input type="checkbox"/> Yes, <input type="checkbox"/> No
Executive Busy Override Deny	<input type="checkbox"/> Yes, <input type="checkbox"/> No		Trunk Group 12 <input type="checkbox"/> Yes, <input type="checkbox"/> No
Station Lock	<input type="checkbox"/> Yes, <input type="checkbox"/> No		Trunk Group 13 <input type="checkbox"/> Yes, <input type="checkbox"/> No
Walking Station	<input type="checkbox"/> Yes, <input type="checkbox"/> No		Trunk Group 14 <input type="checkbox"/> Yes, <input type="checkbox"/> No
Maintenance Capability	<input type="checkbox"/> Yes, <input type="checkbox"/> No		Trunk Group 15 <input type="checkbox"/> Yes, <input type="checkbox"/> No
ARS/Local Access	<input type="checkbox"/> W/RSTR, <input type="checkbox"/> No RSTR <input type="checkbox"/> No ACCS		Trunk Group 16 <input type="checkbox"/> Yes, <input type="checkbox"/> No
		Special Carrier Access	EQA1 <input type="checkbox"/> Yes, <input type="checkbox"/> No OCC1 <input type="checkbox"/> Yes, <input type="checkbox"/> No EQA2 <input type="checkbox"/> Yes, <input type="checkbox"/> No OCC2 <input type="checkbox"/> Yes, <input type="checkbox"/> No EQA3 <input type="checkbox"/> Yes, <input type="checkbox"/> No OCC3 <input type="checkbox"/> Yes, <input type="checkbox"/> No EOA4 <input type="checkbox"/> Yes, <input type="checkbox"/> No OCC4 <input type="checkbox"/> Yes, <input type="checkbox"/> No
		Station Paging Access	PAG1 <input type="checkbox"/> Yes, <input type="checkbox"/> No PAG5 <input type="checkbox"/> Yes, <input type="checkbox"/> No PAG2 <input type="checkbox"/> Yes, <input type="checkbox"/> No PAG6 <input type="checkbox"/> Yes, <input type="checkbox"/> No PAG3 <input type="checkbox"/> Yes, <input type="checkbox"/> No PAG7 <input type="checkbox"/> Yes, <input type="checkbox"/> No PAG4 <input type="checkbox"/> Yes, <input type="checkbox"/> No PAG8 <input type="checkbox"/> Yes, <input type="checkbox"/> No
		External Paging	External paging 1 <input type="checkbox"/> Yes, <input type="checkbox"/> No External paging 2 <input type="checkbox"/> Yes, <input type="checkbox"/> No

Class of Service No.32

Item	Set Data	Item	Set Data
Toll Restriction Level (Day)	(<u>0 1</u> t o 1 6)	Trunk Group Access	Trunk Group 01 <input type="checkbox"/> Yes, <input type="checkbox"/> No
Toll Restriction Level (Night)	(<u>0 1</u> t o 1 6)		Trunk Group 02 <input type="checkbox"/> Yes, <input type="checkbox"/> No
Max. Dialing Digits	- - - (0 to 255)		Trunk Group 03 <input type="checkbox"/> Yes, <input type="checkbox"/> No
Call Forwarding&b Not Disturb	<input type="checkbox"/> Yes, <input type="checkbox"/> No		Trunk Group 04 <input type="checkbox"/> Yes, <input type="checkbox"/> No
Do Not Disturb Override	<input type="checkbox"/> Yes, <input type="checkbox"/> No		Trunk Group 05 <input type="checkbox"/> Yes, <input type="checkbox"/> No
CO Forward Mode	<input type="checkbox"/> Yes, <input type="checkbox"/> No		Trunk Group 06 <input type="checkbox"/> Yes, <input type="checkbox"/> No
CO Transfer Mode	<input type="checkbox"/> Yes, <input type="checkbox"/> No		Trunk Group 07 <input type="checkbox"/> Yes, <input type="checkbox"/> No
Forced Account Code Mode	<input type="checkbox"/> Yes, <input type="checkbox"/> No		Trunk Group 08 <input type="checkbox"/> Yes, <input type="checkbox"/> No
BSS/OHCA	<input type="checkbox"/> Yes, <input type="checkbox"/> No		Trunk Group 09 <input type="checkbox"/> Yes, <input type="checkbox"/> No
BSS/OHCA Deny	<input type="checkbox"/> Yes, <input type="checkbox"/> No		Trunk Group 10 <input type="checkbox"/> Yes, <input type="checkbox"/> No
Executive Busy Override	<input type="checkbox"/> Yes, <input type="checkbox"/> No		Trunk Group 11 <input type="checkbox"/> Yes, <input type="checkbox"/> No
Executive Busy Override Deny	<input type="checkbox"/> Yes, <input type="checkbox"/> No		Trunk Group 12 <input type="checkbox"/> Yes, <input type="checkbox"/> No
Station Lock	<input type="checkbox"/> Yes, <input type="checkbox"/> No		Trunk Group 13 <input type="checkbox"/> Yes, <input type="checkbox"/> No
walking station	<input type="checkbox"/> Yes, <input type="checkbox"/> No		Trunk Group 14 <input type="checkbox"/> Yes, <input type="checkbox"/> No
Maintenance Capability	<input type="checkbox"/> Yes, <input type="checkbox"/> No		Trunk Group 15 <input type="checkbox"/> Yes, <input type="checkbox"/> No
ARS/Local Access	<input type="checkbox"/> W/RSTR, <input type="checkbox"/> No RSTR <input type="checkbox"/> No ACCS		Trunk Group 16 <input type="checkbox"/> Yes, <input type="checkbox"/> No
		Special Carrier Access	EQA1 <input type="checkbox"/> Yes, <input type="checkbox"/> No OCC1 <input type="checkbox"/> Yes, <input type="checkbox"/> No EQA2 <input type="checkbox"/> Yes, <input type="checkbox"/> No OCC2 <input type="checkbox"/> Yes, <input type="checkbox"/> No EQA3 <input type="checkbox"/> Yes, <input type="checkbox"/> No OCC3 <input type="checkbox"/> Yes, <input type="checkbox"/> No EOA4 <input type="checkbox"/> Yes, <input type="checkbox"/> No OCC4 <input type="checkbox"/> Yes, <input type="checkbox"/> No
		Station Paging Access	PAG1 <input type="checkbox"/> Yes, <input type="checkbox"/> No PAG5 <input type="checkbox"/> Yes, <input type="checkbox"/> No PAG2 <input type="checkbox"/> Yes, <input type="checkbox"/> No PAG6 <input type="checkbox"/> Yes, <input type="checkbox"/> No PAG3 <input type="checkbox"/> Yes, <input type="checkbox"/> No PAG7 <input type="checkbox"/> Yes, <input type="checkbox"/> No PAG4 <input type="checkbox"/> Yes, <input type="checkbox"/> No PAG8 <input type="checkbox"/> Yes, <input type="checkbox"/> No
		External Paging	External paging 1 <input type="checkbox"/> Yes, <input type="checkbox"/> No External paging 2 <input type="checkbox"/> Yes, <input type="checkbox"/> No

SYSTEM-LOCAL ACCESS GROUP

item	Set Data	Default Value
Toll Restriction Level	_ _ 2 digits (01 to 16)	16
Toil Restriction Table	_ 1 digit (1 to 8)	1
Local Access		
Trunk Group Hunt Sequence		
01	_ _ 2 digits (01 to 16)	01
02	_ _ 2 digits (01 to 16)	blank
03	_ _ 2 digits (01 to 16)	blank
04	_ _ 2 digits (01 to 16)	blank
05	_ _ 2 digits (01 to 16)	blank
06	_ _ 2 digits (01 to 16)	blank
07	_ _ 2 digits (01 to 16)	blank
08	_ _ 2 digits (01 to 16)	blank
09	_ _ 2 digits (01 to 16)	blank
10	_ _ 2 digits (01 to 16)	b l a n k
11	_ _ 2 digits (01 to 16)	blank
12	_ _ 2 digits (01 to 16)	blank
13	_ _ 2 digits (01 to 16)	blank
14	_ _ 2 digits (01 to 16)	blank
15	_ _ 2 digits (01 to 16)	blank
16	_ _ 2 digits (01 to 16)	blank

SYSTEM-NUMBERING PLAN (1/4)

No.	item	Set Data	Default Value
1	1 st Hundred Block Extension	- - 1 or 2 digits (0 to 9)	1
2	2nd Hundred Block Extension	- - 1 or 2 digits (0 to 9)	2
3	3rd Hundred Block Extension	- - 1 or 2 digits (0 to 9)	3
4	4th Hundred Block Extension	- - 1 or 2 digits (0 to 9)	-
5	5th Hundred Block Extension	- - 1 or 2 digits (0 to 9)	-
6	6th Hundred Block Extension	- - 1 or 2 digits (0 to 9)	-
7	7th Hundred Block Extension	- - 1 or 2 digits (0 to 9)	-
8	8th Hundred Block Extension	- - 1 or 2 digits (0 to 9)	-
9	9th Hundred Block Extension	- - 1 or 2 digits (0 to 9)	-
10	10th Hundred Block Extension	- - 1 or 2 digits (0 to 9)	-
11	11 th Hundred Block Extension	- - 1 or 2 digits (0 to 9)	-
12	12th Hundred Block Extension	- - 1 or 2 digits (0 to 9)	-
13	13th Hundred Block Extension	- - 1 or 2 digits (0 to 9)	-
14	14th Hundred Block Extension	- - 1 or 2 digits (0 to 9)	-
15	15th Hundred Block Extension	- - 1 or 2 digits (0 to 9)	-
16	16th Hundred Block Extension	- - 1 or 2 digits (0 to 9)	-
17	Operator Call (General)	- - - - 1 to 4 digits (0 to 9, *, #)	0
18	Operator Call (Specific)	- - - - 1 to 4 digits (0 to 9, *, #)	3
19	ARS/Local CO Line Access	- - - - 1 to 4 digits (0 to 9, *, #)	9
20	Trunk Group 01-08 Access	- - - - 1 to 4 digits (0 to 9, *, #)	81
21	Trunk Group 09-16 Access	- - - - 1 to 4 digits (0 to 9, *, #)	82
22	Trunk Group 17-24 Access	- - - - 1 to 4 digits (0 to 9, *, #)	83
23	Speed Dialing-System	- - - - 1 to 4 digits (0 to 9, *, #)	1
24	Speed Dialing-Station	- - - - 1 to 4 digits (0 to 9, *, #)	*2
25	Doorphone Call (i-4)	- - - - 1 to 4 digits (0 to 9, *, #)	40
26	External Paging	- - - - 1 to 4 digits (0 to 9, *, #)	41
27	Station Paging	- - - - 1 to 4 digits (0 to 9, *, #)	42
28	External Paging Answer	- - - - 1 to 4 digits (0 to 9, *, #)	43
29	Station Paging Answer	- - - - 1 to 4 digits (0 to 9, *, #)	44
30	Night Answer 1	- - - - 1 to 4 digits (0 to 9, *, #)	45
31	Night Answer 2	- - - - 1 to 4 digits (0 to 9, *, #)	46
32	Dial Call Pickup	- - - - 1 to 4 digits (0 to 9, *, #)	47

SYSTEM-NUMBERING PLAN (214)

No.	Item	Set Data	Default Value
33	Directed Call Pickup	_____ 1 to digits(0 to 9, *, #)	48
34	Hold Extension Retrieve	- - - - - 1 to digit(0 to 9, *, #)	49
35	Redial	_____ 1 to digit(0 to 9, *, #)	' 3
36	External Feature Access	- - - - - 1 to 4 digits (0 to 9, *, #)	50
37	Account Code	- - - - - 1 to 4 digits (0 to 9, *, #)	*#
38	Hold	- - - - - 1 to digit(0 to 9, *, #)	51
39	Hold Retrieve	1 to 4 digits (0 to 9, *, #)	52
40	Call Park-System	- - - - - 1 to 4 digits (0 to 9, *, #)	53
41	Call Park Retrieve—System	1 to 4 digits (0 to 9, *, #)	54
42	Call Park-Station	- - - - - 1 to 4 digits (0 to 9, *, #)	55
43	Call Park Retrieve-Station	1 to 4 digits (0 to 9, *, #)	56
44	Call Forwarding-All Call Set	- - - - - 1 to 4 digits (0 to 9, *, #)	**2
45	Call Forwarding—Busy Set	- - - - - 1 to digit(0 to 9, *, #)	**3
46	Call Forwarding—No Answer Set	- - - - - 1 to digit(0 to 9, *, #)	**4
47	Call Forwarding-To Trunk	- - - - - 1 to digit(0 to 9, *, #)	**5
46	Call Forwarding--Busy/No Answer	- - - - - 1 to 4 digits (0 to 9, *, #)	**6
49	Do Not Disturb Set	1 to 4 digits (0 to 9, *, #)	**1
50	Call Forwarding/Do Not Disturb Cancel	_____ 1 to 4 digits (0 to 9, *, #)	##0
51	Dial Call Pickup Deny Set	- - - - - 1 to digit(0 to 9, *, #)	61"
52	Dial Call Pickup Deny Cancel	- - - - - 1 to digit(0 to 9, *, #)	61#
53	Call Waiting Set	_____ 1 to digit(0 to 9, *, #)	62"
54	Call Waiting Cancel	- - - - - 1 to 4 digits (0 to 9, *, #)	62#
55	BSS/OHCA Deny Set	1 to 4 digits (0 to 9, *, #)	63*
56	BSS/OHCA Deny Cancel	1 to 4 digits (0 to 9, *, #)	63#
57	Busy Override Deny Set	- - - - - 1 to digit(0 to 9, *, #)	64*
58	Busy Override Deny Cancel	- - - - - 1 to digit(0 to 9, *, #)	64#
59	Data Line Security Set	- - - - - 1 to 4 digits (0 to 9, *, #)	65*
60	Data Line Security Cancel	- - - - - 1 to digit(0 to 9, *, #)	65#
61	Pickup Dialing Programming	- - - - - 1 to digit(0 to 9, *, #)	660
62	Pickup Dialing Set	_____ 1 to digit(0 to 9, *, #)	66*
63	Pickup Dialing Cancel	- - - - - 1 to digit(0 to 9, *, #)	66#

SYSTEM-NUMBERING PLAN (3/4)

No.	Item	Set Data	Default Value
64	Absent Message Set	- - - - 1 to 4 digits (0 to 9, *, #)	*4
65	Absent Message Cancel	_____ 1 to 4 digits (0 to 9, *, #)	#4
66	Timed Reminder Confirm	- - - - 1 to 4 digits (0 to 9, *, #)	'50
67	Timed Reminder Set	_____ 1 to 4 digits (0 to 9, *, #)	*51
68	Timed Reminder Cancel	- - - - 1 to 4 digits (0 to 9, *, #)	#5
69	Voice Calling Mode Set	- - - - 1 to 4 digits (0 to 9, *, #)	67*
70	Voice Calling Mode Cancel	_____ 1 to 4 digits (0 to 9, *, #)	67#
71	Voice Calling Deny Set	- - - - 1 to 4 digits (0 to 9, *, #)	68*
72	Voice Calling Deny Cancel	- - - - 1 to 4 digits (0 to 9, *, #)	68#
73	Speed Dialing-Station Programming	- - - - 1 to 4 digits (0 to 9, *, #)	6'
74	Station Lock Set	- - - - 1 to 4 digits (0 to 9, *, #)	"6
75	Station Lock Cancel	_____ 1 to 4 digits (0 to 9, *, #)	#6
76	Walking COS Set	- - - - 1 to 4 digits (0 to 9, *, #)	*7
77	Walking COS Cancel	- - - - 1 to 4 digits (0 to 9, *, #)	#7
78	Walking Station Set	- - - - 1 to 4 digits (0 to 9, *, #)	*8
79	Walking Station Cancel	- - - - 1 to 4 digits (0 to 9, *, #)	#8
80	Message Set	- - - - 1 to 4 digits (0 to 9, *, #)	'9
81	Message Cancel	- - - - 1 to 4 digits (0 to 9, *, #)	#
82	Station Program Clear	- - - - 1 to 4 digits (0 to 9, *, #)	###
83	(Reserve)		
84	(Reserve)		
85	Night Mode Set	- - - - 1 to 4 digits (0 to 9, *, #)	70*
86	Night Mode Cancel	- - - - 1 to 4 digits (0 to 9, *, #)	70#
87	Night Service Manual Mode Set	- - - - 1 to 4 digits (0 to 9, *, #)	71*
88	Night Service Manual Mode Cancel	- - - - 1 to 4 digits (0 to 9, *, #)	71#
89	Flexible Night Service	- - - - 1 to 4 digits (0 to 9, *, #)	72
90	Remote Station Lock Set	- - - - 1 to 4 digits (0 to 9, *, #)	73'
91	Remote Station Lock Cancel	- - - - 1 to 4 digits (0 to 9, *, #)	73#
92	Remote DND Set	- - - - 1 to 4 digits (0 to 9, *, #)	74*
93	Remote DND Cancel	- - - - 1 to 4 digits (0 to 9, *, #)	74#
94	Remote FWD Cancel	- - - - 1 to 4 digits (0 to 9, *, #)	75
95	Remote FWD Cancel-One Time	_____ 1 to 4 digits (0 to 9, *, #)	76

SYSTEM-NUMBERING PLAN (4/4)

NO.	Item	Set Data	Default Value
96	BGM Through External Paging	- - - - 1 to 4 digits (0 to 9, *, #)	77
97	Busy Out Trunk	- - - - 1 to 4 digits (0 to 9, *, #)	78'
98	Unbusy Trunk	- - - - 1 to 4 digits (0 to 9, *, #)	78#
99	OGM Record	- - - - 1 to 4 digits (0 to 9, *, #)	791
100	OGM Playback	- - - - 1 to 4 digits (0 to 9, *, #)	792
101	UCD Log In	- - - - 1 to 4 digits (0 to 9, *, #)	' 0
102	UCD Log Out	- - - - 1 to 4 digits (0 to 9, *, #)	#0
103	(Reserve)		
104	(Reserve)		
105	(Reserve)		
106	(Reserve)		
107	(Reserve)		
108	(Reserve)		

SYSTEM-COMMUNICATION INTERFACE

Item	SIO No. 1 (Terminal)		SIO No. 2 (SMDR)		Remote (Modem)	
	Set Data	Default Value	Set Data	Default Value	Set Data	Default Value
VL-Code	<input type="checkbox"/> <CR> <input type="checkbox"/> <CR+LF>	<CR+LF> <input type="checkbox"/>	<input type="checkbox"/> <CR> <input type="checkbox"/> <CR+LF>	<CR+LF>	<input type="checkbox"/> <CR> <input checked="" type="checkbox"/> <CR+LF>	<CR+LF>
Baud Rate	<input type="checkbox"/> 110 baud <input type="checkbox"/> 150 baud <input type="checkbox"/> 300 baud <input type="checkbox"/> 600 baud <input type="checkbox"/> 1200 baud <input type="checkbox"/> 2400 baud <input checked="" type="checkbox"/> 4800 baud <input type="checkbox"/> 9600 baud	1200	<input type="checkbox"/> 110 baud <input type="checkbox"/> 150 baud <input type="checkbox"/> 300 baud <input type="checkbox"/> 600 baud <input checked="" type="checkbox"/> 1200 baud <input type="checkbox"/> 2400 baud <input type="checkbox"/> 4800 baud <input type="checkbox"/> 9600 baud	1200	<input type="checkbox"/> 300baud <input type="checkbox"/> 1200 baud	300
Word Length	<input type="checkbox"/> 7 bits <input type="checkbox"/> 8 bits	7	<input type="checkbox"/> 7 bits <input type="checkbox"/> 8 bits	7	<input type="checkbox"/> 6 bits <input type="checkbox"/> 7 bits <input type="checkbox"/> 8 bits	8
Parity	<input type="checkbox"/> Mark <input checked="" type="checkbox"/> Space <input type="checkbox"/> Even <input type="checkbox"/> Odd <input type="checkbox"/> None	Mark	<input type="checkbox"/> Mark <input type="checkbox"/> Space <input type="checkbox"/> Even <input type="checkbox"/> Odd <input type="checkbox"/> None	Mark	<input type="checkbox"/> Even <input type="checkbox"/> Odd <input checked="" type="checkbox"/> None	None
Stop Bit	<input type="checkbox"/> 1 bit <input type="checkbox"/> 2 bits	1	<input type="checkbox"/> 1 bit <input type="checkbox"/> 2 bits	1	<input type="checkbox"/> 1 bit <input type="checkbox"/> 1.5 bits <input type="checkbox"/> 2 bits	1

SYSTEM-SPEED DIALING-SYSTEM (119)

ire-7	Selection of value	Default value																		
Type: Toll Restriction Level) 2 digits (00-16)	<table style="width: 100%; border-collapse: collapse;"> <tr> <td style="width: 50%;">00: Normal</td> <td style="width: 50%;">09: Restriction level-9</td> </tr> <tr> <td>01: Restriction level-1</td> <td>10: Restriction level-10</td> </tr> <tr> <td>02: Restriction level-2</td> <td>11: Restriction level-11</td> </tr> <tr> <td>03: Restriction level-3</td> <td>12: Restriction level-12</td> </tr> <tr> <td>04: Restriction level-4</td> <td>13: Restriction level-13</td> </tr> <tr> <td>05: Restriction level-5</td> <td>14: Restriction level-14</td> </tr> <tr> <td>06: Restriction level-6</td> <td>15: Restriction level-15</td> </tr> <tr> <td>07: Restriction level-7</td> <td>16: Restriction level-16</td> </tr> <tr> <td>08: Restriction level-8</td> <td></td> </tr> </table>	00: Normal	09: Restriction level-9	01: Restriction level-1	10: Restriction level-10	02: Restriction level-2	11: Restriction level-11	03: Restriction level-3	12: Restriction level-12	04: Restriction level-4	13: Restriction level-13	05: Restriction level-5	14: Restriction level-14	06: Restriction level-6	15: Restriction level-15	07: Restriction level-7	16: Restriction level-16	08: Restriction level-8		00
00: Normal	09: Restriction level-9																			
01: Restriction level-1	10: Restriction level-10																			
02: Restriction level-2	11: Restriction level-11																			
03: Restriction level-3	12: Restriction level-12																			
04: Restriction level-4	13: Restriction level-13																			
05: Restriction level-5	14: Restriction level-14																			
06: Restriction level-6	15: Restriction level-15																			
07: Restriction level-7	16: Restriction level-16																			
08: Restriction level-8																				
Dial Number (including CO access code)	Max. 32 digits consisting of numbers, *, # and marks below: P : Pause F : Flash [: Start of secret numbers] : End of secret numbers - : Hyphen	blank																		

- Pressing the **NEXT** button shows next 14 numbers from the last number shown on the screen.
- Pressing the **PREVIOUS** button shows previous 14 numbers from the first number shown on the screen.

Speed Dial No. (Toll Restriction Level)	Set Data	
	Type	Dial Number (including CO access code)
001		
002		
003		
004		
005		
006		
007		
008		
009		
010		

SYSTEM-SPEED DIALING-SYSTEM (2/9)

Speed Dial No. (T	Set Data	
	Type oII Restric- tion Level)	Dial Number (including CO access code)
011		
012		
013		
014		
015		
016		
017		
018		
019		
020		
021		
022		
023		
024		
025		
026		
027		
028		
029		
030		.
031		
032		
033		
034		
035		

SYSTEM-SPEED DIALING-SYSTEM (319)

Speed Dial No	Set Data	
	Type (Toll Restriction Level)	Dial Number (including CO access code)
036		
037		
038		
039		
040		
041		
042		
043		
044		
045		
046		
047		
048		
049		
050		
051		
052		
053		
054		
055		
056		
057		
058		
059		
060		

SYSTEM-SPEED DIALING-SYSTEM (4/9)

Speed		Set Data
Dial No.	Type (Toll Restriction Level)	Dial Number (including CO access code)
061		
062		
063		
064		
065		
066		
067		
068		
069		
070		
071		
072		
073		
074		
075		
076		
077		
078		
079		
080		
081		
082		
083		
084		
085		

SYSTEM-SPEED DIALING-SYSTEM (5/9)

Speed Dial No.	Set Data	
	Type (Toll Restriction Level)	Dial Number (including CO access code)
086		
087		
088		
089		
090		
091		
092		
093		
094		
095		
096		
097		
098		
099		
100		
101		
102		
103		
104		
105		
106		
107		
108		
109		
110		

SYSTEM-SPEED DIALING-SYSTEM (6/9)

Speed Dial No.	Set Data	
	Type Restriction Level	Dial Number (including CO access code)
111		
112		
113		
1 1 4		
115		
116		
117		
118		
119		
120		
121		
122		
123		
124		
125		
126		
127		
128		
129		
130		
131		
132		
133		
134		
135		

SYSTEM-SPEED DIALING-SYSTEM (7/9)

Speed Dial No.	Set Data	
	Type (Toll Restric- tion Level)	Dial Number (including CO access code)
136		
137		
138		
139		
140		
141		
142		
143		
144		
145		
146		
147		
148		
149		
150		
151		
152		
153		
154		
155		
156		
157		
158		
159		
160		

SYSTEM-SPEED DIALING-SYSTEM (8/9)

Speed Dial No.	Set Data	
	Type (Toll Restriction Level)	Dial Number (including CO access code)
161		
162		
163		
164		
165		
166		
167		
168		
169		
170		
171		
172		
173		
174		
175		
176		
177		
178		
179		
180		
181		
182		
183		
184		
185		

SYSTEM-SPEED DIALING-SYSTEM (9/9)

Speed	Set Data	
Dial No. (Toll Restriction Level)	Type	Dial Number (including CO access code)
186		
187		
188		
189		
190		
191		
192		
193		
194		
195		
196		
197		
198		
199		
200		

SYSTEM-ABSENT MESSAGE

item	Set Data	Default Value
Fixed Message	1 Will Return Soon	All display
	2 Gone Home	
	3 In a Meeting	
	4 Back At %%.% %%%%	
	5 Out Until %%%%	
	6 At Ext %%%%	
Flexible Message	7	blank
	8	
	9	
	10	
	11	
	12	
	13	
	14	
	15	
	16	

Remark:

Fixed Message (1 to 6):

Fixed messages cannot be changed.

%: enter these at extensions

Flexible Message (7 to 16):

letters, numbers, and up to five % within 16 digits

%: enter these at extensions

4. Group

GROUP-TRUNK GROUP (1/2)

Trunk Group No. 01

Item	Set Data	Default Value
Type	<input type="checkbox"/> DDD, <input type="checkbox"/> FEX, <input type="checkbox"/> WATS, <input type="checkbox"/> PVL, <input type="checkbox"/> PBX, <input type="checkbox"/> DID	DDD
Name	- - - 3 digits (alphanumeric characters)	co
Tenant	<input type="checkbox"/> 1, <input type="checkbox"/> 2	1
Incoming/Outgoing	<input type="checkbox"/> Incoming only, <input type="checkbox"/> Outgoing only, <input type="checkbox"/> Both-way	Both-way
Incoming Mode (Day)	<input type="checkbox"/> ATT, <input type="checkbox"/> DKSA, <input type="checkbox"/> DIL 1:1, <input type="checkbox"/> DIL 1:N, <input type="checkbox"/> TAFAS 1, <input type="checkbox"/> TAFAS 2	DIL 1:1
Incoming Mode (Night)	<input type="checkbox"/> FLEXIBLE, <input type="checkbox"/> FIXED, <input type="checkbox"/> Day Mode, <input type="checkbox"/> DISA	Flexible
Intercept Routing (Day)	<input type="checkbox"/> ATT <input type="checkbox"/> EXT- (3 or 4 digits), <input type="checkbox"/> None	None
Intercept Routing (Night)	<input type="checkbox"/> EXT→ (3 or 4 digits), <input type="checkbox"/> None	None
Toll Restriction Level	- - 2 digits (01 to 16)	16
Toll Restriction Table	1 digit (1 to 8)	1
Dialing Plan	<input type="checkbox"/> Type-A, <input type="checkbox"/> Type-B, <input type="checkbox"/> Type-C, <input type="checkbox"/> None	None
CO-CO Duration Limit	1 or 2 minutes (1 to 64)	10
Disconnect Time	<input type="checkbox"/> 1.5 seconds, <input type="checkbox"/> 4.0 seconds	1.5
Pause Time	<input type="checkbox"/> 1.5 seconds, <input type="checkbox"/> 2.5 seconds, 03.5 seconds, 04.5 seconds	3.5
Hook Switch Flash Time	<input type="checkbox"/> 80 mseconds, <input type="checkbox"/> 300 mseconds, <input type="checkbox"/> 600 mseconds, <input type="checkbox"/> 900 mseconds, <input type="checkbox"/> 1200 mseconds, <input type="checkbox"/> None	None

Remark	
DDD: Direct Distance Dialing FEX: Foreign Exchange WATS: Wide Area Telecommunication Service PVL: Private Line PBX: Behind PBX DID: Direct Inward Dialing	All-: Attendant Console DIL 1 :1: Direct In Line (1 :1) DIL 1 :N: Direct In Lines (1 :N) DISA: Direct Inward System Access TAFAS1, 2: Trunk Answer From Any Station
Day mode: Change Night receiving mode to Day receiving mode. Fixed: Incoming call only arrives on either DN which set by Night Answer point of Trunk or External pager of Universal Night Answer (Can not change at Operator). Flexible: Incoming call only arrives on either DN which set by Night Answer point of Trunk or External pager of Universal Night Answer (Can be changed at Operator). . If ATLC is installed, default value for Incoming Mode (Day) is ATT.	

GROUP-TRUNK GROUP (2/2)

Trunk Group No. 01

Item	Set Data	Default Value
destination (DIL 1: N only) Type and Number	<input type="checkbox"/> " " → None <input type="checkbox"/> PCKUP → <input type="checkbox"/> <input type="checkbox"/> Pickup group No. (01 to 32) <input type="checkbox"/> EXT → <input type="checkbox"/> <input type="checkbox"/> <input type="checkbox"/> <input type="checkbox"/> DN (3 or 4 digits) <input type="checkbox"/> ICM → <input type="checkbox"/> ICM group No. (1 to 8)	blank
	<input type="checkbox"/> " " → None <input type="checkbox"/> PCKUP, <input type="checkbox"/> <input type="checkbox"/> Pickup group No. (01 to 32) <input type="checkbox"/> JEXT → <input type="checkbox"/> <input type="checkbox"/> <input type="checkbox"/> <input type="checkbox"/> DN (3 or 4 digits) <input type="checkbox"/> ICM → <input type="checkbox"/> ICM group No. (1 to 8)	blank
	<input type="checkbox"/> " " → None <input type="checkbox"/> PCKUP- <input type="checkbox"/> <input type="checkbox"/> Pickup group No. (01 to 32) <input type="checkbox"/> EXT → <input type="checkbox"/> <input type="checkbox"/> <input type="checkbox"/> <input type="checkbox"/> DN (3 or 4 digits) <input type="checkbox"/> ICM → <input type="checkbox"/> ICM group No. (1 to 8)	blank
	<input type="checkbox"/> " " → None <input type="checkbox"/> PCKUP- <input type="checkbox"/> <input type="checkbox"/> Pickup group No. (01 to 32) <input type="checkbox"/> JEXT → <input type="checkbox"/> <input type="checkbox"/> <input type="checkbox"/> <input type="checkbox"/> DN (3 or 4 digits) <input type="checkbox"/> ICM → <input type="checkbox"/> ICM group No. (1 to 8)	blank
	<input type="checkbox"/> " " → None <input type="checkbox"/> PCKUP- <input type="checkbox"/> <input type="checkbox"/> Pickup group No. (01 to 32) <input type="checkbox"/> JEXT → <input type="checkbox"/> <input type="checkbox"/> <input type="checkbox"/> <input type="checkbox"/> DN (3 or 4 digits) <input type="checkbox"/> ICM → <input type="checkbox"/> ICM group No. (1 to 8)	blank
	<input type="checkbox"/> " " → None <input type="checkbox"/> PCKUP- <input type="checkbox"/> <input type="checkbox"/> Pickup group No. (01 to 32) <input type="checkbox"/> EXT → <input type="checkbox"/> <input type="checkbox"/> <input type="checkbox"/> <input type="checkbox"/> DN (3 or 4 digits) <input type="checkbox"/> ICM → <input type="checkbox"/> ICM group No. (1 to 8)	blank
	<input type="checkbox"/> " " → None <input type="checkbox"/> PCKUP → <input type="checkbox"/> <input type="checkbox"/> Pickup group No. (01 to 32) <input type="checkbox"/> EXT → <input type="checkbox"/> <input type="checkbox"/> <input type="checkbox"/> <input type="checkbox"/> DN (3 or 4 digits) <input type="checkbox"/> ICM → <input type="checkbox"/> ICM group No. (1 to 8)	blank
	<input type="checkbox"/> c I " " → None <input type="checkbox"/> PCKUP- <input type="checkbox"/> <input type="checkbox"/> Pickup group No. (01 to 32) <input type="checkbox"/> EXT → <input type="checkbox"/> <input type="checkbox"/> <input type="checkbox"/> <input type="checkbox"/> DN (3 or 4 digits) <input type="checkbox"/> ICM → <input type="checkbox"/> ICM group No. (1 to 8)	blank
DID Digit Modification Table	<input type="checkbox"/> 1 digit (1 to 4)	1
PBX Access Code with Pause	<input type="checkbox"/> <input type="checkbox"/> <input type="checkbox"/> <input type="checkbox"/> <input type="checkbox"/> <input type="checkbox"/> <input type="checkbox"/> <input type="checkbox"/> <input type="checkbox"/> <input type="checkbox"/> <input type="checkbox"/> Max. 3 digits <input type="checkbox"/> <input type="checkbox"/> <input type="checkbox"/> <input type="checkbox"/> <input type="checkbox"/> <input type="checkbox"/> <input type="checkbox"/> <input type="checkbox"/> <input type="checkbox"/> <input type="checkbox"/> <input type="checkbox"/> Figures (0 to 9)	blank
PBX Access Code with Restriction	<input type="checkbox"/> <input type="checkbox"/> <input type="checkbox"/> <input type="checkbox"/> <input type="checkbox"/> <input type="checkbox"/> <input type="checkbox"/> <input type="checkbox"/> <input type="checkbox"/> <input type="checkbox"/> <input type="checkbox"/> Max. 3 digits <input type="checkbox"/> <input type="checkbox"/> <input type="checkbox"/> <input type="checkbox"/> <input type="checkbox"/> <input type="checkbox"/> <input type="checkbox"/> <input type="checkbox"/> <input type="checkbox"/> <input type="checkbox"/> <input type="checkbox"/> Figures (0 to 9)	blank
Max. Dial No. after EFA Signal	c I (0 to 7)	0
CO Appearance Type	<input type="checkbox"/> Single <input type="checkbox"/> Group	Single

GROUP-TRUNK GROUP (1/2)

Trunk Group No. 02

Item	Set Data	Default Value
Type	<input type="checkbox"/> DDD, <input type="checkbox"/> FEX <input type="checkbox"/> WATS, <input type="checkbox"/> PVL, <input type="checkbox"/> PBX, <input type="checkbox"/> DID	DDD
Name	_____ 3 digits (alphanumeric characters)	CO
Tenant	<input type="checkbox"/> 1, <input type="checkbox"/> 2	1
Incoming/Outgoing	<input type="checkbox"/> Incoming only, <input type="checkbox"/> Outgoing only, <input type="checkbox"/> Both-way	Both-way
Incoming Mode (Day)	<input type="checkbox"/> ATT, <input type="checkbox"/> <input type="checkbox"/> <input type="checkbox"/> DIL1:1, <input type="checkbox"/> DIL1:N, <input type="checkbox"/> TAFAS1, <input type="checkbox"/> TAFAS 2	DIL 1:1 .
incoming Mode (Night)	<input type="checkbox"/> FLEXIBLE, <input type="checkbox"/> FIXED, <input type="checkbox"/> Day Mode, <input type="checkbox"/> DISA	Flexible
Intercept Routing (Day)	<input type="checkbox"/> <input type="checkbox"/> EXT → (<u>3</u> o r 4digits), <input type="checkbox"/> None	None
Intercept Routing (Night)	<input type="checkbox"/> → (<u>3</u> o r 4digits), <input type="checkbox"/> N o n e	None
Toll Restriction Level	_____ 2 digits (01 to 16)	16
Toil Restriction Table	_____ 1 digit (1 to 8)	1
Dialing Plan	<input type="checkbox"/> Type-A, <input type="checkbox"/> Type-B, <input type="checkbox"/> Type-C, <input type="checkbox"/> None	None
CO-CO Duration Limit	<u>1</u> o r <u>2</u> in <u>6</u> (g) it s (1 t o 6 4)	10
Disconnect Time	<input type="checkbox"/> 1.5 seconds, <input type="checkbox"/> 4.0 seconds	1.5
Pause Time	<input type="checkbox"/> 1.5 seconds, <input type="checkbox"/> 02.5 seconds, <input checked="" type="checkbox"/> 03.5 seconds, <input type="checkbox"/> 04.5 seconds	3.5
Hook Switch Flash Time	<input type="checkbox"/> 80 mseconds, <input type="checkbox"/> 300 mseconds, <input type="checkbox"/> 600 mseconds, <input type="checkbox"/> 900mseconds, <input type="checkbox"/> 1200 mseconds, <input type="checkbox"/> None	None

Remark	
DDD: Direct Distance Dialing FEX: Foreign Exchange WATS: Wide Area Telecommunication Service PVL: Private Line PBX: Behind PBX DID: Direct Inward Dialing	ATT: Attendant Console DIL 1 :1: Direct In Line (1 :1) DIL 1 :N: Dired In Lines (1:N) DISA Direct Inward System Access TAFAS1, 2: Trunk Answer From Any Station
Day mode: Change Night receiving mode to Day receiving mode. Fixed: Incoming call only arrives on either DN which set by Night Answer point of Trunk or External pager of Universal Night Answer (Can not change at Operator). Flexible: Incoming call only arrives on either DN which set by Night Answer point of Trunk or External pager of Universal Night Answer (Can be changed at Operator). . If ATLC is installed, default value for Incoming Mode (Day) is ATT.	

GROUP-TRUNK GROUP (212)

Trunk Group No. 02

item	Sei Data	Default Value
Destination (DIL 1: N only) Type and Number	<input type="checkbox"/> " " → None <input type="checkbox"/> PCKUP → <input type="checkbox"/> <input type="checkbox"/> Pickup group No. (01 to 32) <input type="checkbox"/> EXT → <input type="checkbox"/> <input type="checkbox"/> <input type="checkbox"/> DN (3 or 4 digits) <input type="checkbox"/> ICM → <input type="checkbox"/> ICM group No. (1 to 8)	blank
	<input checked="" type="checkbox"/> 3" " - None <input type="checkbox"/> PCKUP → <input type="checkbox"/> <input type="checkbox"/> Pickup group No. (01 to 32) <input type="checkbox"/> EXT → <input type="checkbox"/> <input type="checkbox"/> <input type="checkbox"/> DN (3 or 4 digits) <input type="checkbox"/> ICM → <input type="checkbox"/> ICM group No. (1 to 8)	blank
	<input type="checkbox"/> 7" " → None <input type="checkbox"/> PCKUP → <input type="checkbox"/> <input type="checkbox"/> Pickup group No. (01 to 32) <input type="checkbox"/> EXT → <input type="checkbox"/> <input type="checkbox"/> <input type="checkbox"/> DN (3 or 4 digits) <input type="checkbox"/> ICM → <input type="checkbox"/> ICM group No. (1 to 8)	blank
	<input type="checkbox"/> " " → None <input type="checkbox"/> PCKUP → <input type="checkbox"/> <input type="checkbox"/> Pickup group No. (01 to 32) <input type="checkbox"/> EXT → <input type="checkbox"/> <input type="checkbox"/> <input type="checkbox"/> DN (3 or 4 digits) <input type="checkbox"/> ICM → <input type="checkbox"/> ICM group No. (1 to 8)	blank
	<input type="checkbox"/> " " → None <input type="checkbox"/> PCKUP → <input type="checkbox"/> <input type="checkbox"/> Pickup group No. (01 to 32) <input type="checkbox"/> EXT → <input type="checkbox"/> <input type="checkbox"/> <input type="checkbox"/> DN (3 or 4 digits) <input type="checkbox"/> ICM → <input type="checkbox"/> ICM group No. (1 to 8)	blank
	<input type="checkbox"/> " " → None <input type="checkbox"/> PCKUP → <input type="checkbox"/> <input type="checkbox"/> Pickup group No. (01 to 32) <input type="checkbox"/> EXT → <input type="checkbox"/> <input type="checkbox"/> <input type="checkbox"/> DN (3 or 4 digits) <input type="checkbox"/> ICM → <input type="checkbox"/> ICM group No. (1 to 8)	blank
	<input type="checkbox"/> " " → None <input type="checkbox"/> PCKUP → <input type="checkbox"/> <input type="checkbox"/> Pickup group No. (01 to 32) <input type="checkbox"/> EXT → <input type="checkbox"/> <input type="checkbox"/> <input type="checkbox"/> DN (3 or 4 digits) <input type="checkbox"/> ICM → <input type="checkbox"/> ICM group No. (1 to 8)	blank
	<input type="checkbox"/> " " → None <input type="checkbox"/> PCKUP → <input type="checkbox"/> <input type="checkbox"/> Pickup group No. (01 to 32) <input type="checkbox"/> EXT → <input type="checkbox"/> <input type="checkbox"/> <input type="checkbox"/> DN (3 or 4 digits) <input type="checkbox"/> ICM → <input type="checkbox"/> ICM group No. (1 to 8)	blank
DID Digit Modification Table	<input type="checkbox"/> 1 digit (1 to 4)	1
PBX Access Code with Pause	<input type="checkbox"/> <input checked="" type="checkbox"/> <input checked="" type="checkbox"/> <input type="checkbox"/> <input checked="" type="checkbox"/> <input checked="" type="checkbox"/> <input type="checkbox"/> <input type="checkbox"/> <input type="checkbox"/> <input type="checkbox"/> <input checked="" type="checkbox"/> <input checked="" type="checkbox"/> Max. 3 digits <input type="checkbox"/> UU <input type="checkbox"/> U <input type="checkbox"/> <input type="checkbox"/> UU <input type="checkbox"/> U <input type="checkbox"/> Figures (0 to 9)	blank
PBX Access Codewith Restriction	<input type="checkbox"/> <input checked="" type="checkbox"/> <input checked="" type="checkbox"/> <input type="checkbox"/> <input checked="" type="checkbox"/> <input checked="" type="checkbox"/> <input type="checkbox"/> <input type="checkbox"/> <input type="checkbox"/> <input type="checkbox"/> <input checked="" type="checkbox"/> <input checked="" type="checkbox"/> Max. 3 digits <input type="checkbox"/> UU <input type="checkbox"/> OU <input type="checkbox"/> <input type="checkbox"/> <input type="checkbox"/> <input type="checkbox"/> <input type="checkbox"/> <input type="checkbox"/> Figures (0 to 9)	blank
Max. Dial No. after EFA Signal	<input type="checkbox"/> (0 to 7)	0
CO Appearance Type	<input type="checkbox"/> Single <input type="checkbox"/> Group	Single

GROUP-TRUNK GROUP (1/2)

Trunk Group No. 03

Item	Set Data	Default Value
Type	<input type="checkbox"/> DDD, <input type="checkbox"/> FEX, <input type="checkbox"/> WATS, <input type="checkbox"/> PVL, <input type="checkbox"/> Imx, <input type="checkbox"/> DID	DDD
Name	_____ 3 digits (alphanumeric characters)	C 0
Tenant	<input type="checkbox"/> 1, <input type="checkbox"/> 2	1
Incoming/Outgoing	<input type="checkbox"/> Incoming only, <input type="checkbox"/> Outgoing only, <input type="checkbox"/> Both-way	Both-way
Incoming Mode (Day)	<input type="checkbox"/> ATT, <input type="checkbox"/> DISA, <input type="checkbox"/> DIL 1:1, <input type="checkbox"/> DIL 1:N, <input type="checkbox"/> TAFAS 1, <input type="checkbox"/> TAFAS 2	DIL 1:1 *
Incoming Mode (Night)	<input type="checkbox"/> FLEXIBLE, <input type="checkbox"/> FIXED, <input type="checkbox"/> Day Mode, <input type="checkbox"/> DISA	Flexible
Intercept Routing (Day)	<input type="checkbox"/> Arr <input type="checkbox"/> EXT → (3 or 4 digits), <input type="checkbox"/> None	None
Intercept Routing (Night)	<input type="checkbox"/> EXT → (3 or 4 digits), <input type="checkbox"/> None	None
Toll Restriction Level	- - 2 digits (01 to 16)	16
Toil Restriction Table	_____ 1 digit (1 to 8)	1
Dialing Plan	<input type="checkbox"/> Type-A, <input type="checkbox"/> Type-B, <input type="checkbox"/> Type-C, <input type="checkbox"/> None	None
CO-CO Duration Limit	1 or 2 minutes (1 to 64)	10
Disconnect Time	<input type="checkbox"/> 1.5 seconds, <input type="checkbox"/> 4.0 seconds	1.5
Pause Time	<input type="checkbox"/> 1.5 seconds, <input type="checkbox"/> 2.5 seconds, <input checked="" type="checkbox"/> 3.5 seconds, <input type="checkbox"/> 4.5 seconds	3.5
Hook Switch Flash Time	<input type="checkbox"/> 80 mseconds, <input type="checkbox"/> 300 mseconds, <input type="checkbox"/> 600 mseconds, <input type="checkbox"/> 900 mseconds, <input type="checkbox"/> 1200 mseconds, <input type="checkbox"/> None	None

Remark

<p>DDD: Direct Distance Dialing</p> <p>FEX: Foreign Exchange</p> <p>WATS: Wide Area Telecommunication Service</p> <p>PVL: Private Line</p> <p>PBX: Behind PBX</p> <p>DID: Direct Inward Dialing</p>	<p>A-I-T: Attendant Console</p> <p>DIL 1:1: Direct In Line (1 :1)</p> <p>DIL 1 :N: Direct In Lines (1 :N)</p> <p>DISA Direct Inward System Access</p> <p>TAFAS1,2: Trunk Answer From Any Station</p>
--	---

Day mode: Change Night receiving mode to Day receiving mode.

Fixed: Incoming call only arrives on either DN which set by Night Answer point of Trunk or External pager of Universal Night Answer (Can not change at Operator).

Flexible: Incoming call only arrives on either DN which set by Night Answer point of Trunk or External pager of Universal Night Answer (Can be changed at Operator).

• If ATLC is installed, default value for Incoming Mode (Day) is ATT.

GROUP-TRUNK GROUP (2/2)

Trunk Group No. 03

Item	Set Data	Default Value
Destination (DIL 1. N only) Type and Number	<input type="checkbox"/> " " → None <input type="checkbox"/> PCKUP → <input type="checkbox"/> <input type="checkbox"/> Pickup group No. (01 to 32) <input type="checkbox"/> EXT → <input type="checkbox"/> <input type="checkbox"/> <input type="checkbox"/> <input type="checkbox"/> DN (3 or 4 digits) <input type="checkbox"/> → <input type="checkbox"/> ICM group No. (1 to 8)	blank
	<input type="checkbox"/> " " - None <input type="checkbox"/> PCKUP, <input type="checkbox"/> <input type="checkbox"/> Pickup group No. (01 to 32) <input type="checkbox"/> EXT → <input type="checkbox"/> <input type="checkbox"/> <input type="checkbox"/> <input type="checkbox"/> DN (3 or 4 digits) <input type="checkbox"/> → <input type="checkbox"/> ICM group No. (1 to 8)	blank
	<input type="checkbox"/> " " → None <input type="checkbox"/> PCKUP → <input type="checkbox"/> <input type="checkbox"/> Pickup group No. (01 to 32) <input type="checkbox"/> EXT → <input type="checkbox"/> <input type="checkbox"/> <input type="checkbox"/> <input type="checkbox"/> DN (3 or 4 digits) <input type="checkbox"/> → <input type="checkbox"/> ICM group No. (1 to 8)	blank
	<input type="checkbox"/> " " → None <input type="checkbox"/> PCKUP → <input type="checkbox"/> <input type="checkbox"/> Pickup group No. (01 to 32) <input type="checkbox"/> EXT → <input type="checkbox"/> <input type="checkbox"/> <input type="checkbox"/> <input type="checkbox"/> DN (3 or 4 digits) <input type="checkbox"/> → <input type="checkbox"/> ICM group No. (1 to 8)	blank
	<input type="checkbox"/> " " → None <input type="checkbox"/> PCKUP → <input type="checkbox"/> <input type="checkbox"/> Pickup group No. (01 to 32) <input type="checkbox"/> EXT → <input type="checkbox"/> <input type="checkbox"/> <input type="checkbox"/> <input type="checkbox"/> DN (3 or 4 digits) <input type="checkbox"/> → <input type="checkbox"/> ICM group No. (1 to 8)	blank
	<input type="checkbox"/> " " → None <input type="checkbox"/> PCKUP → <input type="checkbox"/> <input type="checkbox"/> Pickup group No. (01 to 32) <input type="checkbox"/> EXT → <input type="checkbox"/> <input type="checkbox"/> <input type="checkbox"/> <input type="checkbox"/> DN (3 or 4 digits) <input type="checkbox"/> ICM → <input type="checkbox"/> ICM group No. (1 to 8)	blank
	<input type="checkbox"/> " " → None <input type="checkbox"/> PCKUP- <input type="checkbox"/> <input type="checkbox"/> Pickup group No. (01 to 32) <input type="checkbox"/> EXT → <input type="checkbox"/> <input type="checkbox"/> <input type="checkbox"/> <input type="checkbox"/> DN (3 or 4 digits) <input type="checkbox"/> ICM → <input type="checkbox"/> ICM group No. (1 to 8)	blank
	<input type="checkbox"/> " " → None <input type="checkbox"/> PCKUP- <input type="checkbox"/> <input type="checkbox"/> Pickup group No. (01 to 32) <input type="checkbox"/> EXT → <input type="checkbox"/> <input type="checkbox"/> <input type="checkbox"/> <input type="checkbox"/> DN (3 or 4 digits) <input type="checkbox"/> → <input type="checkbox"/> ICM group No. (1 to 8)	blank
<input type="checkbox"/> " " → None <input type="checkbox"/> PCKUP- <input type="checkbox"/> <input type="checkbox"/> Pickup group No. (01 to 32) <input type="checkbox"/> EXT → <input type="checkbox"/> <input type="checkbox"/> <input type="checkbox"/> <input type="checkbox"/> DN (3 or 4 digits) <input type="checkbox"/> ICM → <input type="checkbox"/> ICM group No. (1 to 8)	blank	
DID Diait Modification Table	<input type="checkbox"/> 1 digit (1 to 4)	1
PBX Access Code with Pause	<input type="checkbox"/> <input type="checkbox"/> <input type="checkbox"/> <input type="checkbox"/> <input type="checkbox"/> <input type="checkbox"/> <input type="checkbox"/> <input type="checkbox"/> <input type="checkbox"/> <input type="checkbox"/> <input type="checkbox"/> <input type="checkbox"/> <input type="checkbox"/> <input type="checkbox"/> Max. 3 digits <input type="checkbox"/> <input type="checkbox"/> <input type="checkbox"/> <input type="checkbox"/> <input type="checkbox"/> <input type="checkbox"/> <input type="checkbox"/> <input type="checkbox"/> <input type="checkbox"/> <input type="checkbox"/> Figures (0 to 9)	blank
PBX Access Code with Restrictior	<input type="checkbox"/> <input type="checkbox"/> <input type="checkbox"/> <input type="checkbox"/> <input type="checkbox"/> <input type="checkbox"/> <input type="checkbox"/> <input type="checkbox"/> <input type="checkbox"/> <input type="checkbox"/> <input type="checkbox"/> <input type="checkbox"/> <input type="checkbox"/> <input type="checkbox"/> Max. 3 digits <input type="checkbox"/> <input type="checkbox"/> <input type="checkbox"/> <input type="checkbox"/> <input type="checkbox"/> <input type="checkbox"/> <input type="checkbox"/> <input type="checkbox"/> Figures (0 to 9)	blank
Max. Dial No. after EFA Signal	<input type="checkbox"/> (0 to 7)	0
CO Appearance Type	<input type="checkbox"/> Single <input type="checkbox"/> Group	Single

GROUP-TRUNK GROUP (1/2)

Trunk Group No. 04

Item	Set Data	Default Value
Type	<input type="checkbox"/> DDD, <input type="checkbox"/> FEX, <input type="checkbox"/> WATS, <input type="checkbox"/> PVL, <input type="checkbox"/> Pex, <input type="checkbox"/> DID	DDD
Name	_____ 3 digits (alphanumeric characters)	co
Tenant	<input type="checkbox"/> 1, <input type="checkbox"/> 2	1
incoming/Outgoing	<input type="checkbox"/> Incoming only, <input type="checkbox"/> Outgoing only, <input type="checkbox"/> Both-way	Both-way
Incoming Mode (Day)	<input type="checkbox"/> ATT, <input type="checkbox"/> DISA, <input type="checkbox"/> DIL 1:1, <input type="checkbox"/> DIL 1:N, <input type="checkbox"/> TAFAS1, <input type="checkbox"/> TAFAS 2	DIL 1:1 .
Incoming Mode (Night)	<input type="checkbox"/> FLEXIBLE, <input type="checkbox"/> FIXED, <input type="checkbox"/> Day Mode, <input type="checkbox"/> DISA	Flexible
Intercept Routing (Day)	<input type="checkbox"/> ATT <input type="checkbox"/> EXT → (3 or 4 digits), <input type="checkbox"/> None	None
Intercept Routing (Night)	<input type="checkbox"/> EXT → (3 or 4 digits), <input type="checkbox"/> None	None
Toll Restriction Level	- - 2 digits (01 to 16)	16
Toll Restriction Table	_____ 1 digit (1 to 8)	1
Dialing Plan	<input type="checkbox"/> Type-A, <input type="checkbox"/> Type-B, <input type="checkbox"/> Type-C, <input type="checkbox"/> None	None
CO-CO Duration Limit	1 or 2 minutes (1 to 64)	10
Disconnect Time	<input type="checkbox"/> 1.5 seconds, <input type="checkbox"/> 4.0 seconds	1.5
Pause Time	<input type="checkbox"/> 1.5 seconds, <input type="checkbox"/> 2.5 seconds, <input type="checkbox"/> 3.5 seconds, <input type="checkbox"/> 4.5 seconds	3.5
Hook Switch Flash Time	<input type="checkbox"/> 80 mseconds, <input type="checkbox"/> 300 mseconds, <input type="checkbox"/> 600 mseconds, <input type="checkbox"/> 900 mseconds, <input type="checkbox"/> 1200 mseconds. <input type="checkbox"/> None	None

Remark

- | | |
|---|--|
| DDD: Direct Distance Dialing | AI-T: Attendant Console |
| FEX: Foreign Exchange | DIL 1:1: Direct In Line (1 :1) |
| WATS: Wide Area Telecommunication Service | DIL 1:N: Direct In Lines (1 :N) |
| PVL: Private Line | DISA: Direct Inward System Access |
| PBX: Behind PBX | TAFAS1, 2: Trunk Answer From Any Station |
| DID: Direct Inward Dialing | |

Day mode: Change Night receiving mode to Day receiving mode.
 Fixed: Incoming call **only** arrives on either DN which set by Night Answer point of Trunk or External pager of Universal Night Answer (Can not change at Operator).
 Flexible: Incoming call only arrives on either DN which set by Night Answer point of Trunk or External pager of Universal Night Answer (Can be changed at Operator).
 . If ATLC is installed, default value for Incoming Mode (Day) is ATT.

GROUP-TRUNK GROUP (2/2)

Trunk Group No. 04

item	Set Data	Default Value
Destination (DIL 1: N only) Type and Number	<input type="checkbox"/> " " - N o n e <input type="checkbox"/> PCKUP → <input type="checkbox"/> <input type="checkbox"/> Pickup group No. (01 to 32) <input type="checkbox"/> EXT → <input type="checkbox"/> <input type="checkbox"/> <input type="checkbox"/> <input type="checkbox"/> DN (3 or 4 digits) <input type="checkbox"/> ICM → <input type="checkbox"/> ICM group No. (1 to 8)	blank
	<input type="checkbox"/> " " → None <input type="checkbox"/> PCKUP → <input type="checkbox"/> <input type="checkbox"/> Pickup group No. (01 to 32) <input type="checkbox"/> EXT → <input type="checkbox"/> <input type="checkbox"/> <input type="checkbox"/> <input type="checkbox"/> DN (3 or 4 digits) <input type="checkbox"/> ICM → <input type="checkbox"/> ICM group No. (1 to 8)	blank
	<input type="checkbox"/> " " - N o n e <input type="checkbox"/> PCKUP → <input type="checkbox"/> <input type="checkbox"/> Pickup group No. (01 to 32) <input type="checkbox"/> EXT → <input type="checkbox"/> <input type="checkbox"/> <input type="checkbox"/> <input type="checkbox"/> DN (3 or 4 digits) <input type="checkbox"/> ICM → <input type="checkbox"/> ICM group No. (1 to 8)	blank
	<input type="checkbox"/> " " → None <input type="checkbox"/> PCKUP → <input type="checkbox"/> <input type="checkbox"/> Pickup group No. (01 to 32) <input type="checkbox"/> EXT → <input type="checkbox"/> <input type="checkbox"/> <input type="checkbox"/> <input type="checkbox"/> DN (3 or 4 digits) <input checked="" type="checkbox"/> ICM → <input type="checkbox"/> ICM group No. (1 to 8)	blank
	<input type="checkbox"/> " " → None <input checked="" type="checkbox"/> PCKUP → <input type="checkbox"/> <input type="checkbox"/> Pickup group No. (01 to 32) <input type="checkbox"/> EXT → <input type="checkbox"/> <input type="checkbox"/> <input type="checkbox"/> <input type="checkbox"/> DN (3 or 4 digits) <input checked="" type="checkbox"/> ICM → <input type="checkbox"/> ICM group No. (1 to 8)	blank
	<input type="checkbox"/> " " → None <input type="checkbox"/> PCKUP → <input type="checkbox"/> <input type="checkbox"/> Pickup group No. (01 to 32) <input type="checkbox"/> EXT → <input type="checkbox"/> <input type="checkbox"/> <input type="checkbox"/> <input type="checkbox"/> DN (3 or 4 digits) <input checked="" type="checkbox"/> ICM → <input type="checkbox"/> ICM group No. (1 to 8)	"
	<input type="checkbox"/> " " → None <input checked="" type="checkbox"/> PCKUP- <input type="checkbox"/> <input type="checkbox"/> Pickup group No. (01 to 32) <input type="checkbox"/> EXT → <input type="checkbox"/> <input type="checkbox"/> <input type="checkbox"/> <input type="checkbox"/> DN (3 or 4 digits) <input checked="" type="checkbox"/> ICM → <input type="checkbox"/> ICM group No. (1 to 8)	blank
	<input type="checkbox"/> " " → None <input checked="" type="checkbox"/> PCKUP- <input type="checkbox"/> <input type="checkbox"/> Pickup group No. (01 to 32) <input type="checkbox"/> EXT → <input type="checkbox"/> <input type="checkbox"/> <input type="checkbox"/> <input type="checkbox"/> DN (3 or 4 digits) <input type="checkbox"/> ICM → <input type="checkbox"/> ICM group No. (1 to 8)	blank
DID Digit Modification Table	<input type="checkbox"/> 1 digit (1 to 4)	1
PBX Access Code with Pause	<input type="checkbox"/> <input type="checkbox"/> <input type="checkbox"/> <input type="checkbox"/> <input type="checkbox"/> <input type="checkbox"/> <input type="checkbox"/> <input type="checkbox"/> Max. 3 digits <input type="checkbox"/> <input type="checkbox"/> <input type="checkbox"/> <input type="checkbox"/> <input type="checkbox"/> <input type="checkbox"/> <input type="checkbox"/> <input type="checkbox"/> Figures (0 to 9)	blank
PBX Access Code with Restrictor	<input type="checkbox"/> <input type="checkbox"/> <input type="checkbox"/> <input type="checkbox"/> <input type="checkbox"/> <input type="checkbox"/> <input type="checkbox"/> <input type="checkbox"/> Max. 3 digits <input type="checkbox"/> <input type="checkbox"/> <input type="checkbox"/> <input type="checkbox"/> <input type="checkbox"/> <input type="checkbox"/> <input type="checkbox"/> <input type="checkbox"/> Figures (0 to 9)	blank
Max. Dial No. after EFA Signal	<input type="checkbox"/> c (0 to 7)	0
CO Appearance Type	<input type="checkbox"/> Single <input type="checkbox"/> Group	Single

GROUP-TRUNK GROUP (1/2)

Trunk Group No. 05

Item	Set Data	Default Value
Type	<input type="checkbox"/> DDD, <input type="checkbox"/> FEX, <input type="checkbox"/> WATS, <input type="checkbox"/> PVL, <input type="checkbox"/> PBX, <input type="checkbox"/> DID	DDD
Name	- - - 3 digits (alphanumeric characters)	CO 1
Tenant	<input type="checkbox"/> 1, <input type="checkbox"/> 2	1
Incoming/Outgoing	<input type="checkbox"/> Incoming only, <input type="checkbox"/> Outgoing only, <input type="checkbox"/> Both-way	Both-way
Incoming Mode (Day)	<input type="checkbox"/> ATT, <input type="checkbox"/> DISA, <input type="checkbox"/> 0 1:1, <input type="checkbox"/> <input type="checkbox"/> <input type="checkbox"/> <input type="checkbox"/> <input type="checkbox"/> <input type="checkbox"/> <input type="checkbox"/> TAFAS 2	DIL 1:1
Incoming Mode (Night)	<input type="checkbox"/> FLEXIBLE, <input type="checkbox"/> FIXED, <input type="checkbox"/> Day Mode, <input type="checkbox"/> DISA	Flexible
Intercept Routing (Day)	<input type="checkbox"/> ATT <input type="checkbox"/> EXT---+ (3 o r 4digits), <input type="checkbox"/> N o n e	None
Intercept Routing (Night)	<input type="checkbox"/> EXT → _____ (3 or 4digits), <input type="checkbox"/> None	None
Toll Restriction Level	_____ 2 digits (01 to 16)	16
Toll. Restriction Table	_____ 1 digit (1 to 8)	
Dialing Plan	<input type="checkbox"/> Type-A, <input type="checkbox"/> Type-B, <input type="checkbox"/> Type-C, <input type="checkbox"/> None	None
CO-CO Duration Limit	1 o r _____ minutes (1 to 6 4)	10
Disconnect Time	<input type="checkbox"/> 1.5 seconds, <input type="checkbox"/> 4.0 seconds	1.5
Pause Time	IC 1.5 seconds, <input type="checkbox"/> 2.5 seconds, <input type="checkbox"/> 3.5 seconds, <input type="checkbox"/> 4.5 seconds	3.5
Hook Switch Flash Time	<input type="checkbox"/> 80 mseconds, <input type="checkbox"/> 300 mseconds, <input type="checkbox"/> 600 mseconds, <input type="checkbox"/> 900 mseconds, <input type="checkbox"/> 1200 mseconds, <input type="checkbox"/> None	None

Remark

DDD: Direct Distance Dialing	ATT: Attendant Console
FEX: Foreign Exchange	DIL 1:1: Direct In Line (1:1)
WA-IS: Wide Area Telecommunication Service	DIL 1:N: Direct In Lines (1 :N)
PVL: Private Line	DISA: Direct Inward System Access
PBX: Behind PBX	TAFAS1, 2: Trunk Answer From Any Station
DID: Direct Inward Dialing	

Day mode: **Change Night** receiving mode to Day receiving mode.

Fixed: incoming call only arrives on either DN which set by Night Answer point of Trunk or External pager of Universal Night Answer (Can not change at Operator).

Flexible: Incoming call only arrives on either DN which set by Night Answer point of Trunk or External pager of Universal Night Answer (Can be changed at Operator).

• If ATLC is installed, default value for Incoming Mode (Day) is ATT.

GROUP-TRUNK GROUP (1/2)

Trunk Group No. 06

Item	Set Data	Default Value
Type	<input type="checkbox"/> DDD, <input type="checkbox"/> FEX, <input type="checkbox"/> WATS, <input type="checkbox"/> PVL, <input type="checkbox"/> PBX, <input type="checkbox"/> DID	DDD
Name	- - - 3 digits (alphanumeric characters)	c o
Tenant	<input type="checkbox"/> 1, <input type="checkbox"/> 2	1
Incoming/Outgoing	<input type="checkbox"/> incoming only, <input type="checkbox"/> Outgoing only, <input type="checkbox"/> Both-way	Both-way
Incoming Mode (Day)	<input type="checkbox"/> AT, <input type="checkbox"/> DISA, <input type="checkbox"/> DIL1:1, <input type="checkbox"/> DIL1:N, <input type="checkbox"/> TAFAS1, <input type="checkbox"/> TAFAS2	DIL 1:1 *
Incoming Mode (Night)	<input type="checkbox"/> FLEXIBLE, <input type="checkbox"/> FIXED, <input type="checkbox"/> Day Mode, <input type="checkbox"/> DISA	Flexible
Intercept Routing (Day)	<input type="checkbox"/> ATT <input type="checkbox"/> EXT--, (3 or 4 digits), <input type="checkbox"/> None	None
Intercept Routing (Night)	<input type="checkbox"/> EXT--> (3 or 4 digits), <input type="checkbox"/> None	None
Toll Restriction Level	- - 2 digits (01 to 16)	16
Toll Restriction Table	-- 1 digit (1 to 8)	1
Dialing Plan	<input type="checkbox"/> Type-A, <input type="checkbox"/> Type-B, <input type="checkbox"/> Type-C, <input type="checkbox"/> None	None
CO-CO Duration Limit	1 or 2 minutes (1 to 64)	10
Disconnect Time	<input type="checkbox"/> 1.5 seconds, <input type="checkbox"/> 4.0 seconds	1.5
Pause Time	01.5 seconds, 02.5 seconds, <input type="checkbox"/> 3.5 seconds, 04.5 seconds	3.5
Hook Switch Flash Time	<input type="checkbox"/> 80 mseconds, <input type="checkbox"/> 300 mseconds, <input type="checkbox"/> 600 mseconds. <input type="checkbox"/> 900 mseconds, <input type="checkbox"/> 1200 mseconds, <input type="checkbox"/> None	None

Remark

DDD: Direct Distance Dialing FEX: Foreign Exchange WATS: Wide Area Telecommunication Service PVL: Private Line PBX: Behind PBX DID: Direct Inward Dialing	ATT: Attendant Console DIL 1:1: Direct In Line (1 :1) DIL 1:N: Direct In Lines (1:N) DISA Direct Inward System Access TAFAS1, 2: Trunk Answer From Any Station
--	--

Day mode: Change Night receiving mode to Day receiving mode.
 Fixed: Incoming call only arrives on either DN which set by Night Answer point of Trunk or External pager of Universal Night Answer (Can not change at Operator).
 Flexible: Incoming call only arrives on either DN which set by Night Answer point of Trunk or External pager of Universal Night Answer (Can be changed at Operator).
 • if ATLC is installed, default value for Incoming Mode (Day) is **ATT**.

GROUP-TRUNK GROUP (1/2)

Trunk Group No. 07

Item	Set Data	Default Value
Type	<input type="checkbox"/> DDD, <input type="checkbox"/> FEX, <input type="checkbox"/> WAE, <input type="checkbox"/> PvL, <input type="checkbox"/> PBX, <input type="checkbox"/> DID	DDD
Name	- - - 3 digits (alphanumeric characters)	c o
Tenant	<input type="checkbox"/> 1, <input type="checkbox"/> 2	1
Incoming/Outgoing	<input type="checkbox"/> Incoming only, <input type="checkbox"/> Outgoing only, <input type="checkbox"/> Both-way	Both-way
Incoming Mode (Day)	<input type="checkbox"/> ATT, <input type="checkbox"/> DISA, <input type="checkbox"/> DIL 1:1, <input type="checkbox"/> DILYN, <input type="checkbox"/> TAFAS 1, <input type="checkbox"/> TAFAS 2	DIL 1:1
incoming Mode (Night)	<input type="checkbox"/> FLEXIBLE, <input type="checkbox"/> FIXED, <input type="checkbox"/> Day Mode, <input type="checkbox"/> DISA	Flexible
Intercept Routing (Day)	<input type="checkbox"/> ATT <input type="checkbox"/> EXT- (3 o r 4digits), <input type="checkbox"/> None	None
Intercept Routing (Night)	<input checked="" type="checkbox"/> EXT → (3 o r 4digits), <input type="checkbox"/> None	None
(Toll Restriction Level	____ 2 digits (01 to 16)	16
Toll Restriction Table	___ 1 digit (1 to 8)	1
Dialing Plan	<input type="checkbox"/> Type-A, <input type="checkbox"/> Type-B, <input type="checkbox"/> Type-C, <input type="checkbox"/> None	None
CO-CO Duration Limit	1 o r @inude(s) its (1 t o 6 4)	10
Disconnect Time	<input type="checkbox"/> 1.5 seconds, <input type="checkbox"/> 4.0 seconds	1.5
Pause Time	<input type="checkbox"/> 1.5 seconds, <input type="checkbox"/> 2.5 seconds, 03.5 seconds. <input type="checkbox"/> 4.5 seconds	3.5
Hook Switch Flash Time	<input type="checkbox"/> 80 mseconds, <input type="checkbox"/> 300 mseconds. <input type="checkbox"/> 600 mseconds, <input type="checkbox"/> 900 mseconds, <input type="checkbox"/> 1200 mseconds, <input type="checkbox"/> None	None

Remark	
DDD: Direct Distance Dialing FEX: Foreign Exchange WATS: Wide Area Telecommunication Service PVL: Private Line PBX: Behind PBX DID: Direct Inward Dialing	ATT: Attendant Console DIL 1:1: Direct In Line (1 :1) DIL 1:N: Direct In Lines (1:N) DISA Direct Inward System Access TAFAS1, 2: Trunk Answer From Any Station
Day mode: Change Night receiving mode to Day receiving mode. Fixed: Incoming-call only arrives on either DN which set by Night Answer Point of Trunk or External pager of Universal Night Answer (Can not change at Operator). Flexible: Incoming call only arrives on either DN which set by Night Answer point of Trunk or External Pager of Universal Night Answer (Can be changed at Operator). . If ATLC is installed. default value for Incoming Mode (Day) is ATT.	

GROUP-TRUNK GROUP (2/2)

Trunk Group No. 08

Item	Set Data	Default Value
Destination (DIL 1 : N only) Type and Number	<input type="checkbox"/> " " → None <input type="checkbox"/> PCKUP → <input type="checkbox"/> <input type="checkbox"/> Pickup group No. (01 to 32) <input type="checkbox"/> EXT → <input type="checkbox"/> <input type="checkbox"/> <input type="checkbox"/> <input type="checkbox"/> DN (3 or 4 digits) <input type="checkbox"/> → <input type="checkbox"/> ICM group No. (1 to 8)	blank
	<input type="checkbox"/> " " - None <input type="checkbox"/> PCKUP- <input type="checkbox"/> <input type="checkbox"/> Pickup group No. (01 to 32) <input type="checkbox"/> EXT → <input type="checkbox"/> <input type="checkbox"/> <input type="checkbox"/> <input type="checkbox"/> DN (3 or 4 digits) <input type="checkbox"/> → <input type="checkbox"/> ICM group No. (1 to 8)	blank
	<input type="checkbox"/> " " - None <input type="checkbox"/> PCKUP-• <input type="checkbox"/> Pickup group No. (01 to 32) <input type="checkbox"/> EXT → <input type="checkbox"/> <input type="checkbox"/> <input type="checkbox"/> <input type="checkbox"/> DN (3 or 4 digits) <input type="checkbox"/> → <input type="checkbox"/> ICM group No. (1 to 8)	blank
	<input type="checkbox"/> " " - None <input type="checkbox"/> PCKUP → <input type="checkbox"/> <input type="checkbox"/> Pickup group No. (01 to 32) <input type="checkbox"/> → <input type="checkbox"/> <input type="checkbox"/> <input type="checkbox"/> <input type="checkbox"/> DN (3 or 4 digits) <input type="checkbox"/> → <input type="checkbox"/> ICM group No. (1 to 8)	blank
	<input type="checkbox"/> " " - None <input type="checkbox"/> PCKUP → <input type="checkbox"/> <input type="checkbox"/> Pickup group No. (01 to 32) <input type="checkbox"/> EXT → <input type="checkbox"/> <input type="checkbox"/> <input type="checkbox"/> <input type="checkbox"/> DN (3 or 4 digits) <input type="checkbox"/> → <input type="checkbox"/> ICM group No. (1 to 8)	blank
	<input type="checkbox"/> " " → None <input type="checkbox"/> PCKUP- <input type="checkbox"/> <input type="checkbox"/> Pickup group No. (01 to 32) <input type="checkbox"/> EXT → <input type="checkbox"/> <input type="checkbox"/> <input type="checkbox"/> <input type="checkbox"/> DN (3 or 4 digits) <input type="checkbox"/> → <input type="checkbox"/> ICM group No. (1 to 8)	blank
	<input type="checkbox"/> " " → None <input type="checkbox"/> PCKUP- <input type="checkbox"/> <input type="checkbox"/> Pickup group No. (01 to 32) <input type="checkbox"/> EXT → <input type="checkbox"/> <input type="checkbox"/> <input type="checkbox"/> <input type="checkbox"/> DN (3 or 4 digits) <input type="checkbox"/> → <input type="checkbox"/> ICM group No. (1 to 8)	blank
	<input type="checkbox"/> " " → None <input type="checkbox"/> PCKUP → <input type="checkbox"/> <input type="checkbox"/> Pickup group No. (01 to 32) <input type="checkbox"/> → <input type="checkbox"/> <input type="checkbox"/> <input type="checkbox"/> <input type="checkbox"/> DN (3 or 4 digits) <input type="checkbox"/> ICM → <input type="checkbox"/> ICM group No. (1 to 8)	blank
MO Digit Modification Table	<input type="checkbox"/> 1 digit (1 to 4)	1
MOBX Access Code with Pause	<input type="checkbox"/> <input type="checkbox"/> <input type="checkbox"/> <input type="checkbox"/> <input type="checkbox"/> <input type="checkbox"/> <input type="checkbox"/> <input type="checkbox"/> Max. 3 digits <input type="checkbox"/> <input type="checkbox"/> <input type="checkbox"/> <input type="checkbox"/> <input type="checkbox"/> <input type="checkbox"/> <input type="checkbox"/> Figures (0 to 9)	blank
MOBX Access Code with Restriction	<input type="checkbox"/> <input type="checkbox"/> <input type="checkbox"/> <input type="checkbox"/> <input type="checkbox"/> <input type="checkbox"/> <input type="checkbox"/> <input type="checkbox"/> <input type="checkbox"/> <input type="checkbox"/> Max. 3 digits <input type="checkbox"/> <input type="checkbox"/> <input type="checkbox"/> <input type="checkbox"/> <input type="checkbox"/> <input type="checkbox"/> <input type="checkbox"/> Figures (0 to 9)	blank
Max. Dial No. after EFA Signal	<input type="checkbox"/> (0 to 7)	0
MO Appearance Type	<input type="checkbox"/> Single <input type="checkbox"/> Group	Single

GROUP-TRUNK GROUP (1/2)

Trunk Group No. 08

Item	Set Data	Default Value
Type	<input type="checkbox"/> DDD, <input type="checkbox"/> FEX, <input type="checkbox"/> WATS, <input type="checkbox"/> PVL, <input type="checkbox"/> IPBX, <input type="checkbox"/> DID	DDD
Name	- - - 3 digits (alphanumeric characters)	co
Tenant	<input type="checkbox"/> 1, <input type="checkbox"/> 2	1
Incoming/Outgoing	<input type="checkbox"/> Incoming only, <input type="checkbox"/> Outgoing only, <input type="checkbox"/> Both-way	Both-way
Incoming Mode (Day)	<input type="checkbox"/> ATT, <input type="checkbox"/> DISA, <input type="checkbox"/> DIL1:1, <input type="checkbox"/> DIL1:N, <input type="checkbox"/> TAFAS1, <input type="checkbox"/> TAFAS 2	DIL 1:1 .
Incoming Mode (Night)	<input type="checkbox"/> FLEXIBLE, <input type="checkbox"/> FIXED, <input type="checkbox"/> Day Mode, <input type="checkbox"/> D1.W	Flexible
Intercept Routing (Day)	<input type="checkbox"/> ATT <input type="checkbox"/> EXT → (3 o r 4digits), <input type="checkbox"/> N o n e	None
Intercept Routing (Night)	<input type="checkbox"/> EXT → (3 o r 4digits), <input type="checkbox"/> N o n e	None
Toll Restriction Level	_____ 2 digits (01 to 16)	16
Toll Restriction Table	_____ 1 digit (1 to 8)	1
Dialing Plan	<input type="checkbox"/> Type-A, <input type="checkbox"/> Type-B, <input type="checkbox"/> Type-C <input type="checkbox"/> None	None
CO-CO Duration Limit	1 o r 2 in d i g i t s (1 t o 6 4)	10
Disconnect Time	<input type="checkbox"/> 1.5 seconds, <input type="checkbox"/> 4.0 seconds	1.5
Pause Time	<input type="checkbox"/> 1.5 seconds, <input type="checkbox"/> 2.5 seconds, <input type="checkbox"/> 3.5 seconds, <input type="checkbox"/> 4.5 seconds	3.5
Hook Switch Flash Time	<input type="checkbox"/> 80 mseconds, <input type="checkbox"/> 300 mseconds, <input type="checkbox"/> 600 mseconds. <input type="checkbox"/> 900 mseconds, <input type="checkbox"/> 1200 mseconds, <input type="checkbox"/> None	None

Remark			
DDD:	Direct Distance Dialing	ATT:	Attendant Console
FEX:	Foreign Exchange	DIL 1:1:	Direct In Line (1 :1)
WATS:	Wide Area Telecommunication Service	DIL 1:N:	Direct In Lines (1:N)
PVL:	Private Line	DISA	Direct Inward System Access
PBX:	Behind PBX	TAFAS1, 2:	Trunk Answer From Any Station
DID:	Direct Inward Dialing		
Day mode: Change Night receiving mode to Day receiving mode.			
Fixed: Incoming-call only arrives on either DN which set by Night Answer point of Trunk or External pager of Universal Night Answer (Can not change at Operator).			
Flexible: Incoming call only arrives on either DN which set by Night Answer point of Trunk or External pager of Universal Night Answer (Can be changed at Operator).			
. If ATLC is installed, default value for Incoming Mode (Day) is ATT .			

GROUP-TRUNK GROUP (212)

Trunk Group No. 08

item	Set Data	Default Value
Destination (DIL 1: N only) Type and Number	<input type="checkbox"/> " " → None <input type="checkbox"/> PCKUP → <input type="checkbox"/> <input type="checkbox"/> Pickup group No. (01 to 32) <input type="checkbox"/> EXT → <input type="checkbox"/> <input type="checkbox"/> <input type="checkbox"/> DN (3 or 4 digits) <input type="checkbox"/> ICM → <input type="checkbox"/> ICM group No. (1 to 8)	blank
	<input type="checkbox"/> " " → None <input type="checkbox"/> PCKUP → <input type="checkbox"/> <input type="checkbox"/> Pickup group No. (01 to 32) <input type="checkbox"/> EXT → <input type="checkbox"/> <input type="checkbox"/> <input type="checkbox"/> DN (3 or 4 digits) <input type="checkbox"/> ICM → <input type="checkbox"/> ICM group No. (1 to 8)	blank
	<input type="checkbox"/> " " - None <input type="checkbox"/> PCKUP → <input type="checkbox"/> <input type="checkbox"/> Pickup group No. (01 to 32) <input type="checkbox"/> EXT → <input type="checkbox"/> <input type="checkbox"/> <input type="checkbox"/> DN (3 or 4 digits) <input type="checkbox"/> ICM → <input checked="" type="checkbox"/> ICM group No. (1 to 8)	blank
	<input type="checkbox"/> " " → None <input type="checkbox"/> PCKUP → <input type="checkbox"/> <input type="checkbox"/> Pickup group No. (01 to 32) <input type="checkbox"/> EXT → <input type="checkbox"/> <input type="checkbox"/> <input type="checkbox"/> DN (3 or 4 digits) <input type="checkbox"/> ICM → <input checked="" type="checkbox"/> ICM group No. (1 to 8)	blank
	<input type="checkbox"/> " " → None <input type="checkbox"/> PCKUP → <input type="checkbox"/> <input type="checkbox"/> Pickup group No. (01 to 32) <input type="checkbox"/> EXT → <input type="checkbox"/> <input type="checkbox"/> <input type="checkbox"/> DN (3 or 4 digits) <input checked="" type="checkbox"/> → <input type="checkbox"/> ICM group No. (1 to 8)	blank
	<input type="checkbox"/> " " → None <input checked="" type="checkbox"/> PCKUP- <input type="checkbox"/> <input type="checkbox"/> Pickup group No. (01 to 32) <input type="checkbox"/> EXT → <input type="checkbox"/> <input type="checkbox"/> <input type="checkbox"/> DN (3 or 4 digits) <input type="checkbox"/> ICM → <input type="checkbox"/> ICM group No. (1 to 8)	blank
	<input type="checkbox"/> " " → None <input checked="" type="checkbox"/> PCKUP- <input type="checkbox"/> <input type="checkbox"/> Pickup group No. (01 to 32) <input type="checkbox"/> EXT → <input type="checkbox"/> <input type="checkbox"/> <input type="checkbox"/> DN (3 or 4 digits) <input checked="" type="checkbox"/> → <input type="checkbox"/> ICM group No. (1 to 8)	blank
	<input type="checkbox"/> " " → None <input checked="" type="checkbox"/> PCKUP- <input type="checkbox"/> <input type="checkbox"/> Pickup group No. (01 to 32) <input type="checkbox"/> EXT → <input type="checkbox"/> <input type="checkbox"/> <input type="checkbox"/> DN (3 or 4 digits) <input checked="" type="checkbox"/> → <input type="checkbox"/> ICM group No. (1 to 8)	blank
	<input type="checkbox"/> 1 digit (1 to 4)	1
DID Digit Modification Table	<input type="checkbox"/> <input type="checkbox"/> <input type="checkbox"/> <input type="checkbox"/> <input type="checkbox"/> Max. 3 digits	blank
PBX Access Code with Pause	<input type="checkbox"/> <input type="checkbox"/> <input type="checkbox"/> <input type="checkbox"/> <input type="checkbox"/> <input type="checkbox"/> <input type="checkbox"/> <input type="checkbox"/> Figures (0 to 9)	blank
PBX Access Code with Restrictio	<input type="checkbox"/> <input type="checkbox"/> <input type="checkbox"/> <input type="checkbox"/> <input type="checkbox"/> <input type="checkbox"/> <input type="checkbox"/> <input type="checkbox"/> <input type="checkbox"/> Max. 3 digits <input type="checkbox"/> <input type="checkbox"/> <input type="checkbox"/> <input type="checkbox"/> <input type="checkbox"/> <input type="checkbox"/> <input type="checkbox"/> <input type="checkbox"/> <input type="checkbox"/> Figures (0 to 9)	blank
Max. Dial No. after EFA Signal	cl (0 to 7)	0
CO Appearance Type	<input type="checkbox"/> Single <input type="checkbox"/> Group	Single

GROUP-TRUNK GROUP (1/2)

Trunk Group No. 09

Item	Set Data	Default Value
Type	<input type="checkbox"/> DDD, <input type="checkbox"/> FEX, <input type="checkbox"/> WATS, <input type="checkbox"/> <input type="checkbox"/> <input type="checkbox"/> <input type="checkbox"/> <input type="checkbox"/> <input type="checkbox"/> DID	DDD
Name	- - - 3 digits (alphanumeric characters)	CO
Tenant	<input type="checkbox"/> 1, <input type="checkbox"/> 2	1
Incoming/Outgoing	<input type="checkbox"/> Incoming only, <input type="checkbox"/> Outgoing only, <input type="checkbox"/> Both-way	Both-way
Incoming Mode (Day)	<input type="checkbox"/> ATT, <input type="checkbox"/> DISA, <input type="checkbox"/> JDIL1:1, <input type="checkbox"/> DIL1:N, <input type="checkbox"/> TAFAS1, <input type="checkbox"/> TAFAS 2	DIL 1:1 .
Incoming Mode (Night)	<input type="checkbox"/> FLEXIBLE, <input type="checkbox"/> FIXED, <input type="checkbox"/> Day Mode, <input type="checkbox"/> DISA	Flexible
Intercept Routing (Day)	<input type="checkbox"/> ATT <input type="checkbox"/> EXT- (<u>3</u> or 4digits), <input type="checkbox"/> None	None
Intercept Routing (Night)	<input type="checkbox"/> EXT - - - - (3 or 4digits), <input type="checkbox"/> None	None
Toll Restriction Level	- - 2 digits (01 to 16)	16
Toll Restriction Table	<u> </u> 1 digit (1 to 8)	1
Dialing Plan	<input type="checkbox"/> Type-A, <input type="checkbox"/> Type-B, <input type="checkbox"/> Type-C, <input type="checkbox"/> None	None
CO-CO Duration Limit	<u>1</u> or 2 minutes (1 to 64)	10
Disconnect Time	01.5 seconds, 04.0 seconds	1.5
Pause Time	<input type="checkbox"/> 1.5 seconds, <input type="checkbox"/> 2.5 seconds, <input type="checkbox"/> 3.5 seconds, <input type="checkbox"/> 4.5 seconds	3.5
Hook Switch Flash Time	<input type="checkbox"/> 80 mseconds, <input type="checkbox"/> 300 mseconds, <input type="checkbox"/> 600 mseconds, <input type="checkbox"/> 900 mseconds, <input type="checkbox"/> 1200 mseconds, <input type="checkbox"/> None	None

Remark			
DDD:	Dired Distance Dialing	AI-I:	Attendant Console
FEX:	Foreign Exchange	DIL 1:1:	Direct In Line (1:1)
WATS:	Wide Area Telecommunication Service	DIL 1:N:	Dired In Lines (1 :N)
PVL:	Private Line	DISA	Direct Inward System Access
PBX:	Behind PBX	TAFAS1, 2:	Trunk Answer From Any Station
DID:	Direct Inward Dialing		
Day mode: Change Night receiving mode to Day receiving mode.			
Fixed: Incoming call only arrives on either DN which set by Night Answer point of Trunk or External pager of Universal Night Answer (Can not change at Operator).			
Flexible: Incoming call only arrives on either DN which set by Night Answer point of Trunk or External pager of Universal Night Answer (Can be changed at Operator).			
• If ATLC is installed, default value for Incoming Mode (Day) is ATT.			

GROUP-TRUNK GROUP (2/2)

Trunk Group No. 09

Item	Set Data	Default Value
Destination (DIL 1: N only) Type and Number	<input type="checkbox"/> " " → None <input type="checkbox"/> PCKUP- <input type="checkbox"/> <input type="checkbox"/> Pickup group No. (01 to 32) <input type="checkbox"/> EXT → <input type="checkbox"/> <input type="checkbox"/> <input type="checkbox"/> <input type="checkbox"/> DN (3 or 4 digits) <input type="checkbox"/> → <input type="checkbox"/> ICM group No. (1 to 8)	blank
	<input type="checkbox"/> " " → None <input type="checkbox"/> PCKUP- <input type="checkbox"/> <input type="checkbox"/> Pickup group No. (01 to 32) <input type="checkbox"/> EXT → <input type="checkbox"/> <input type="checkbox"/> <input type="checkbox"/> <input type="checkbox"/> DN (3 or 4 digits) <input type="checkbox"/> → <input type="checkbox"/> ICM group No. (1 to 8)	blank
	<input type="checkbox"/> " " → None <input type="checkbox"/>]PCKUP- <input type="checkbox"/> <input type="checkbox"/> Pickup group No. (01 to 32) <input type="checkbox"/> EXT → <input type="checkbox"/> <input type="checkbox"/> <input type="checkbox"/> <input type="checkbox"/> DN (3 or 4 digits) <input type="checkbox"/> ICM → <input type="checkbox"/> ICM group No. (1 to 8)	blank
	<input type="checkbox"/> " " → None <input type="checkbox"/> PCKUP- <input type="checkbox"/> <input type="checkbox"/> Pickup group No. (01 to 32) <input type="checkbox"/> EXT → <input type="checkbox"/> <input type="checkbox"/> <input type="checkbox"/> <input type="checkbox"/> DN (3 or 4 digits) <input type="checkbox"/> → <input type="checkbox"/> ICM group No. (1 to 8)	blank
	<input type="checkbox"/> " " → None <input type="checkbox"/> PCKUP- <input type="checkbox"/> <input type="checkbox"/> Pickup group No. (01 to 32) <input type="checkbox"/> EXT → <input type="checkbox"/> <input type="checkbox"/> <input type="checkbox"/> <input type="checkbox"/> DN (3 or 4 digits) <input type="checkbox"/> ICM - <input type="checkbox"/> ICM group No. (1 to 8)	blank
	<input type="checkbox"/> " " → None <input type="checkbox"/> PCKUP- <input type="checkbox"/> <input type="checkbox"/> Pickup group No. (01 to 32) <input type="checkbox"/> EXT → <input type="checkbox"/> <input type="checkbox"/> <input type="checkbox"/> <input type="checkbox"/> DN (3 or 4 digits) <input type="checkbox"/> - <input type="checkbox"/> ICM group No. (1 to 8)	blank
	<input type="checkbox"/> " " → None <input type="checkbox"/> PCKUP- <input type="checkbox"/> <input type="checkbox"/> Pickup group No. (01 to 32) <input type="checkbox"/> EXT → <input type="checkbox"/> <input type="checkbox"/> <input type="checkbox"/> <input type="checkbox"/> DN (3 or 4 digits) <input type="checkbox"/> ICM → <input type="checkbox"/> ICM group No. (1 to 8)	blank
	<input type="checkbox"/> " " → None <input type="checkbox"/> PCKUP- <input type="checkbox"/> <input type="checkbox"/> Pickup group No. (01 to 32) <input type="checkbox"/> EXT → <input type="checkbox"/> <input type="checkbox"/> <input type="checkbox"/> <input type="checkbox"/> DN (3 or 4 digits) <input type="checkbox"/> ICM - <input type="checkbox"/> ICM group No. (1 to 8)	blank
IDDigitModification Table	<input type="checkbox"/> 1 digit (1 to 4)	1
VBX Access Code with Pause	<input type="checkbox"/> <input type="checkbox"/> <input type="checkbox"/> <input type="checkbox"/> <input type="checkbox"/> <input type="checkbox"/> <input type="checkbox"/> <input type="checkbox"/> <input type="checkbox"/> <input type="checkbox"/> <input type="checkbox"/> <input type="checkbox"/> <input type="checkbox"/> <input type="checkbox"/> <input type="checkbox"/> <input type="checkbox"/> <input type="checkbox"/> Max. 3 digits <input type="checkbox"/> <input type="checkbox"/> <input type="checkbox"/> <input type="checkbox"/> <input type="checkbox"/> <input type="checkbox"/> <input type="checkbox"/> <input type="checkbox"/> <input type="checkbox"/> <input type="checkbox"/> <input type="checkbox"/> <input type="checkbox"/> <input type="checkbox"/> <input type="checkbox"/> <input type="checkbox"/> <input type="checkbox"/> <input type="checkbox"/> <input type="checkbox"/> <input type="checkbox"/> <input type="checkbox"/> <input type="checkbox"/> Figures (0 to 9)	blank
VBX Access Code with Restriction	<input type="checkbox"/> <input type="checkbox"/> <input type="checkbox"/> <input type="checkbox"/> <input type="checkbox"/> <input type="checkbox"/> <input type="checkbox"/> <input type="checkbox"/> <input type="checkbox"/> <input type="checkbox"/> <input type="checkbox"/> <input type="checkbox"/> <input type="checkbox"/> <input type="checkbox"/> <input type="checkbox"/> <input type="checkbox"/> <input type="checkbox"/> <input type="checkbox"/> <input type="checkbox"/> <input type="checkbox"/> <input type="checkbox"/> Max. 3 digits <input type="checkbox"/> <input type="checkbox"/> <input type="checkbox"/> <input type="checkbox"/> <input type="checkbox"/> <input type="checkbox"/> <input type="checkbox"/> <input type="checkbox"/> <input type="checkbox"/> <input type="checkbox"/> <input type="checkbox"/> <input type="checkbox"/> <input type="checkbox"/> <input type="checkbox"/> <input type="checkbox"/> <input type="checkbox"/> <input type="checkbox"/> <input type="checkbox"/> <input type="checkbox"/> <input type="checkbox"/> <input type="checkbox"/> Figures (0 to 9)	blank
Max. Dial No. after EFA Signal	<input type="checkbox"/> (0 to 7)	0
Appearance Type	<input type="checkbox"/> Single <input type="checkbox"/> Group	Single

GROUP-TRUNK GROUP (1/2)

Trunk_Group No. 10

Item	Set Data	Default Value
Type	<input type="checkbox"/> DDD, <input type="checkbox"/> FEX, <input type="checkbox"/> JWATS, <input type="checkbox"/> PVL, <input type="checkbox"/> PBX, <input type="checkbox"/> DID	DDD
Name	- - - 3 digits (alphanumeric characters)	c o
Tenant	<input type="checkbox"/> 1, <input type="checkbox"/> 2	1
Incoming/Outgoing	<input type="checkbox"/> Incoming only, <input type="checkbox"/> Outgoing only, <input type="checkbox"/> Both-way	Both-way
Incoming Mode (Day)	<input type="checkbox"/> ATT, <input type="checkbox"/> DISA, <input type="checkbox"/> DIL 1:1, <input type="checkbox"/> DIL 1:N, <input type="checkbox"/> TAFAS1, <input type="checkbox"/> TAFAS 2	DIL 1:1 .
Incoming Mode (Night)	<input type="checkbox"/> FLEXIBLE, <input type="checkbox"/> FIXED, <input type="checkbox"/> Day Mode, <input type="checkbox"/> DISA	Flexible
Intercept Routing (Day)	<input type="checkbox"/> AT7 <input type="checkbox"/> EXT → (3 or 4 digits), <input type="checkbox"/> None	None
Intercept Routing (Night)	<input type="checkbox"/> JEXT → (3 o r 4 digits), <input type="checkbox"/> N o n e	None
Toll Restriction Level	2 digits (01 to 16)	16
Toll Restriction Table	1 digit (1 to 8)	1
Dialing Plan	<input type="checkbox"/> Type-A, <input type="checkbox"/> Type-B, <input type="checkbox"/> Type-C, <input type="checkbox"/> None	None
CO-CO Duration Limit	1 o r 2 minute(s) (1 t o 6 4)	10
Disconnect Time	<input type="checkbox"/> 1.5 seconds, <input type="checkbox"/> 4.0 seconds	1.5
Pause Time	<input type="checkbox"/> 1.5 seconds, <input type="checkbox"/> 2.5 seconds, <input type="checkbox"/> 3.5 seconds, 04.5 seconds	3.5
Hook Switch Flash Time	<input type="checkbox"/> 80 mseconds, <input type="checkbox"/> 300 mseconds, <input type="checkbox"/> 600 mseconds, <input type="checkbox"/> 900 mseconds, <input type="checkbox"/> 1200 mseconds, <input type="checkbox"/> None	None

Remark

DDD: Direct Distance D ialing FEX: Foreign Exchange WATS: W ide Area Telecommunication Service PVL: Private Line PBX: Behind PBX DID: Direct Inward Dialing	AI-f: Attendant Console DIL 1:1: Direct In Line (1 :1) DIL 1 :N: Direct In Lines (1 :N) DISA Direct Inward System Access TAFAS1, 2: Trunk Answer From Any Station
--	---

Day mode: Change Night receiving mode to Day receiving mode.
 Fixed: Incoming call only arrives on either DN which set by Night Answer point of Trunk or External pager of Universal Night Answer (Can not change at Operator).
 Flexible: Incoming call only arrives on either DN which set by Night Answer point of Trunk or External pager of Universal Night Answer (Can be changed at Operator).
 . If ATLC is installed, default value for Incoming Mode (Day) is ATT.

GROUP-TRUNK GROUP (212)

Trunk Group No. 10

Item	Set Data	Default Value
Destination (DIL 1: N only) Type and Number	<input type="checkbox"/> " " → None <input type="checkbox"/> PCKUP → <input type="checkbox"/> <input type="checkbox"/> Pickup group No. (01 to 32) <input type="checkbox"/> EXT → <input type="checkbox"/> <input type="checkbox"/> <input type="checkbox"/> <input type="checkbox"/> DN (3 or 4 digits) <input type="checkbox"/> ICM → <input type="checkbox"/> ICM group No. (1 to 8)	blank
	<input type="checkbox"/> " " → None <input type="checkbox"/> PCKUP → <input type="checkbox"/> <input type="checkbox"/> Pickup group No. (01 to 32) <input type="checkbox"/> EXT → <input type="checkbox"/> <input type="checkbox"/> <input type="checkbox"/> <input type="checkbox"/> DN (3 or 4 digits) <input type="checkbox"/> ICM → <input type="checkbox"/> ICM group No. (1 to 8)	blank
	<input type="checkbox"/> " " → None <input type="checkbox"/> PCKUP → <input type="checkbox"/> <input type="checkbox"/> Pickup group No. (01 to 32) <input type="checkbox"/> EXT → <input type="checkbox"/> <input type="checkbox"/> <input type="checkbox"/> <input type="checkbox"/> DN (3 or 4 digits) <input type="checkbox"/> ICM → <input type="checkbox"/> ICM group No. (1 to 8)	blank
	<input type="checkbox"/> " " → None <input type="checkbox"/> PCKUP → <input type="checkbox"/> <input type="checkbox"/> Pickup group No. (01 to 32) <input type="checkbox"/> EXT → <input type="checkbox"/> <input type="checkbox"/> <input type="checkbox"/> <input type="checkbox"/> DN (3 or 4 digits) <input type="checkbox"/> ICM → <input type="checkbox"/> ICM group No. (1 to 8)	blank
	<input type="checkbox"/> " " → None <input type="checkbox"/> PCKUP → <input type="checkbox"/> <input type="checkbox"/> Pickup group No. (01 to 32) <input type="checkbox"/> EXT → <input type="checkbox"/> <input type="checkbox"/> <input type="checkbox"/> <input type="checkbox"/> DN (3 or 4 digits) <input type="checkbox"/> ICM → <input type="checkbox"/> ICM group No. (1 to 8)	blank
	<input type="checkbox"/> " " → None <input type="checkbox"/> PCKUP → <input type="checkbox"/> <input type="checkbox"/> Pickup group No. (01 to 32) <input type="checkbox"/> EXT → <input type="checkbox"/> <input type="checkbox"/> <input type="checkbox"/> <input type="checkbox"/> DN (3 or 4 digits) <input type="checkbox"/> ICM → <input type="checkbox"/> ICM group No. (1 to 8)	blank
	<input type="checkbox"/> " " → None <input type="checkbox"/> PCKUP → <input type="checkbox"/> <input type="checkbox"/> Pickup group No. (01 to 32) <input type="checkbox"/> EXT → <input type="checkbox"/> <input type="checkbox"/> <input type="checkbox"/> <input type="checkbox"/> DN (3 or 4 digits) <input type="checkbox"/> ICM → <input type="checkbox"/> ICM group No. (1 to 8)	blank
	<input type="checkbox"/> " " → None <input type="checkbox"/> PCKUP-w <input type="checkbox"/> <input type="checkbox"/> Pickup group No. (01 to 32) <input type="checkbox"/> EXT → <input type="checkbox"/> <input type="checkbox"/> <input type="checkbox"/> <input type="checkbox"/> DN (3 or 4 digits) <input type="checkbox"/> ICM → <input type="checkbox"/> ICM group No. (1 to 8)	blank
①D Digit Modification Table	<input type="checkbox"/> 1 digit (1 to 4)	1
①BX Access Code with Pause	<input type="checkbox"/> <input type="checkbox"/> <input type="checkbox"/> <input type="checkbox"/> <input type="checkbox"/> <input type="checkbox"/> <input type="checkbox"/> <input type="checkbox"/> <input type="checkbox"/> <input type="checkbox"/> <input type="checkbox"/> <input type="checkbox"/> ☺👉👉👉 Max. 3 digits <input type="checkbox"/> <input type="checkbox"/> <input type="checkbox"/> <input type="checkbox"/> <input type="checkbox"/> <input type="checkbox"/> <input type="checkbox"/> <input type="checkbox"/> <input type="checkbox"/> <input type="checkbox"/> <input type="checkbox"/> <input type="checkbox"/> Figures (0 to 9)	blank
①BX Access Code with Restrictor	<input type="checkbox"/> <input type="checkbox"/> <input type="checkbox"/> <input type="checkbox"/> <input type="checkbox"/> <input type="checkbox"/> <input type="checkbox"/> <input type="checkbox"/> <input type="checkbox"/> <input type="checkbox"/> <input type="checkbox"/> <input type="checkbox"/> Max. 3 digits <input type="checkbox"/> 👉👉👉 <input type="checkbox"/> 👉👉👉 <input type="checkbox"/> 👉👉👉 <input type="checkbox"/> 👉👉👉 Figures (0 to 9)	blank
Max. Dial No. after EFA Signal	cl (0 to 7)	0
CO Appearance Type	<input type="checkbox"/> Single <input type="checkbox"/> Group	Single

GROUP-TRUNK GROUP (1/2)

Trunk Group No. 11

Item	Set Data	Default Value
Type	<input type="checkbox"/> DDD, <input type="checkbox"/> FEX, <input type="checkbox"/> WATS, <input type="checkbox"/> PVL, <input type="checkbox"/> PBX, <input type="checkbox"/> DID	DDD
Name	- - - 3 digits (alphanumeric characters)	c o
Tenant	<input type="checkbox"/> 1, <input type="checkbox"/> 2	1
Incoming/Outgoing	<input type="checkbox"/> Incoming only, <input type="checkbox"/> Outgoing only, <input type="checkbox"/> Both-way	Both-way
Incoming Mode (Day)	<input type="checkbox"/> ATT, <input type="checkbox"/> DISA, <input type="checkbox"/> DIL 1:1, <input type="checkbox"/> DIL 1:N, <input type="checkbox"/> TAFAS 1, <input type="checkbox"/> TAFAS 2	DIL 1:1 .
Incoming Mode (Night)	<input type="checkbox"/> FLEXIBLE, <input type="checkbox"/> FIXED, <input type="checkbox"/> Day Mode, <input type="checkbox"/> DISA	Flexible
Intercept Routing (Day)	<input type="checkbox"/> AIT <input type="checkbox"/> EXT → (3 o r 4digits), <input type="checkbox"/> N o n e	None
Intercept Routing (Night)	<input type="checkbox"/> EXT → (3 <input type="checkbox"/> <input type="checkbox"/> 4digits), <input type="checkbox"/> None	None
Toll Restriction Level	2 digits (01 to 16)	16
Toll Restriction Table	-- 1 digit (1 to 8)	1
Dialing Plan	<input type="checkbox"/> Type-A, <input type="checkbox"/> Type-B, <input type="checkbox"/> Type-C, <input type="checkbox"/> None	None
CO-CO Duration Limit	1 o r 2 minute(s) (1 t o 6 4)	10
Disconnect Time	<input type="checkbox"/> 1.5 seconds, 04.0 seconds	1.5
Pause Time	<input type="checkbox"/> 1.5 seconds, <input type="checkbox"/> 2.5 seconds, <input type="checkbox"/> 3.5 seconds, 04.5 seconds	3.5
Hook Switch Flash Time	<input type="checkbox"/> 80 mseconds, <input type="checkbox"/> 300 mseconds, <input type="checkbox"/> 600 mseconds, <input type="checkbox"/> 900 mseconds. <input type="checkbox"/> 1200 mseconds, <input type="checkbox"/> None	None

Remark

- | | |
|---|--|
| <p>DDD: Direct Distance Dialing</p> <p>FEX: Foreign Exchange</p> <p>WATS: Wide Area Telecommunication Service</p> <p>PVL: Private Line</p> <p>PBX: Behind PBX</p> <p>DID: Direct Inward Dialing</p> | <p>ATT: Attendant Console</p> <p>DIL 1 :1: Direct In Line(1:1)</p> <p>DIL 1 :N: Direct In Lines (1 :N)</p> <p>DISA Direct Inward System Access</p> <p>TAFAS1, 2: Trunk Answer From Any Station</p> |
|---|--|

Day mode: **Change Night** receiving mode to Day receiving mode.

Fixed: Incoming call only arrives on either DN which set by Night Answer point of Trunk or External pager of Universal Night Answer (Can not change at Operator).

Flexible: Incoming call only arrives on either DN which set by Night Answer point of Trunk or External pager of Universal Night Answer (Can be changed at Operator).

. If ATLC is installed, default value for Incoming Mode (Day) is **ATT**.

GROUP-TRUNK GROUP (2/2)

Trunk Group No. 11

Item	Set Data	Default Value
Destination (DIL 1: N only) Type and Number	<input type="checkbox"/> " " → None <input type="checkbox"/> PCKUP → <input type="checkbox"/> Pickup group No. (01 to 32) <input type="checkbox"/> EXT → <input type="checkbox"/> <input type="checkbox"/> <input type="checkbox"/> <input type="checkbox"/> DN (3 or 4 digits) <input type="checkbox"/> → <input type="checkbox"/> ICM group No. (1 to 8)	blank
	<input type="checkbox"/> " " → None <input type="checkbox"/> PCKUP → <input type="checkbox"/> <input type="checkbox"/> Pickup group No. (01 to 32) <input type="checkbox"/> EXT → <input type="checkbox"/> <input type="checkbox"/> <input type="checkbox"/> <input type="checkbox"/> DN (3 or 4 digits) <input type="checkbox"/> ICM → <input type="checkbox"/> ICM group No. (1 to 8)	blank
	<input type="checkbox"/> " " - None <input type="checkbox"/> PCKUP- <input type="checkbox"/> <input type="checkbox"/> Pickup group No. (01 to 32) <input type="checkbox"/> EXT → <input type="checkbox"/> <input type="checkbox"/> <input type="checkbox"/> <input type="checkbox"/> DN(3or4digits) <input type="checkbox"/> ICM → <input type="checkbox"/> ICM group No. (1 to 8)	blank
	<input type="checkbox"/> " " - None <input type="checkbox"/> PCKUP- <input type="checkbox"/> <input type="checkbox"/> Pickup group No. (01 to 32) <input type="checkbox"/> → <input type="checkbox"/> <input type="checkbox"/> <input type="checkbox"/> <input type="checkbox"/> DN (3 or 4 digits) <input type="checkbox"/> ICM → <input type="checkbox"/> ICM group No. (1 to 8)	blank
	<input type="checkbox"/> " " → None <input type="checkbox"/> PCKUP → <input type="checkbox"/> <input type="checkbox"/> Pickup group No. (01 to 32) <input type="checkbox"/> EXT → <input type="checkbox"/> <input type="checkbox"/> <input type="checkbox"/> <input type="checkbox"/> DN (3 or 4 digits) <input type="checkbox"/> → <input type="checkbox"/> ICM group No. (1 to 8)	blank
	<input type="checkbox"/> " " → None <input type="checkbox"/> PCKUP- <input type="checkbox"/> <input type="checkbox"/> Pickup group No. (01 to 32) <input type="checkbox"/> EXT → <input type="checkbox"/> <input type="checkbox"/> <input type="checkbox"/> <input type="checkbox"/> DN (3 or 4 digits) <input type="checkbox"/> ICM → <input type="checkbox"/> ICM group No. (1 to 8)	blank
	<input type="checkbox"/> " " → None <input type="checkbox"/> PCKUP- <input type="checkbox"/> <input type="checkbox"/> Pickup group No. (01 to 32) <input type="checkbox"/> EXT → <input type="checkbox"/> <input type="checkbox"/> <input type="checkbox"/> <input type="checkbox"/> DN (3 or 4 digits) <input type="checkbox"/> ICM → <input type="checkbox"/> ICM group No. (1 to 8)	blank
	<input type="checkbox"/> " " → None <input type="checkbox"/> PCKUP- <input type="checkbox"/> <input type="checkbox"/> Pickup group No. (01 to 32) <input type="checkbox"/> EXT → <input type="checkbox"/> <input type="checkbox"/> <input type="checkbox"/> <input type="checkbox"/> DN (3 or 4 digits) <input type="checkbox"/> → <input type="checkbox"/> ICM group No. (1 to 8)	blank
DD Digit Modification Table	<input type="checkbox"/> 1 digit (1 to 4)	1
PBX Access Code with Pause	<input type="checkbox"/> <input type="checkbox"/> <input type="checkbox"/> <input type="checkbox"/> IJCI <input type="checkbox"/> <input type="checkbox"/> <input type="checkbox"/> <input type="checkbox"/> <input type="checkbox"/> Max. 3 digits <input type="checkbox"/> <input type="checkbox"/> <input type="checkbox"/> <input type="checkbox"/> <input type="checkbox"/> <input type="checkbox"/> <input type="checkbox"/> <input type="checkbox"/> Figures (0 to 9)	blank
PBX Access Code with Restriction	<input type="checkbox"/> <input type="checkbox"/> <input type="checkbox"/> <input type="checkbox"/> <input type="checkbox"/> <input type="checkbox"/> <input type="checkbox"/> Max. 3 digits <input type="checkbox"/> <input type="checkbox"/> <input type="checkbox"/> <input type="checkbox"/> <input type="checkbox"/> <input type="checkbox"/> <input type="checkbox"/> <input type="checkbox"/> Figures (0 to 9)	blank
Max. Dial Nd. after EFA Signal	cl (0 to 7)	0
CO Appearance Type	<input type="checkbox"/> Single <input type="checkbox"/> Group	Single

GROUP-TRUNK GROUP (1/2)

Trunk Group No. 12

Item	Set Data	Default Value
Type	<input type="checkbox"/> DDD, <input type="checkbox"/> FEX, <input type="checkbox"/> WATS, <input type="checkbox"/> PVL, <input type="checkbox"/> PBX, <input type="checkbox"/> DD	DDD
Name	_____ 3 digits (alphanumeric characters)	c o
Tenant	<input type="checkbox"/> 1, <input type="checkbox"/> 2	
Incoming/Outgoing	<input type="checkbox"/> Incoming only, <input type="checkbox"/> Outgoing only, <input type="checkbox"/> Both-way	Both-way
Incoming Mode (Day)	<input type="checkbox"/> ATT, <input type="checkbox"/> DISA, <input type="checkbox"/> DIL 1:1, <input type="checkbox"/> DIL 1:N, <input type="checkbox"/> TAFAS1, <input type="checkbox"/> TAWS2	DIL 1:1 .
Incoming Mode (Night)	<input type="checkbox"/> FLEWLIE, <input type="checkbox"/> FIXW, <input type="checkbox"/> Day Mode, <input type="checkbox"/> DISA	Flexible
Intercept Routing (Day)	<input type="checkbox"/> ATT <input type="checkbox"/> EXT → (3 o r 4digits), <input type="checkbox"/> N o n e	None
Intercept Routing (Night)	<input type="checkbox"/> EXT → _____ (3 or 4digits), <input type="checkbox"/> None	None
Toll Restriction Level	_____ 2 digits (01 to 16)	16
Toll Restriction Table	_____ 1 digit (1 to 8)	.1
Dialing Plan	<input type="checkbox"/> Type-A, <input type="checkbox"/> Type-B, <input type="checkbox"/> Type-C, <input type="checkbox"/> None	None
CO-CO Duration Limit	1 o r 2 in d e i (g i t s (1 t o 6 4)	10
Disconnect Time	<input type="checkbox"/> 1.5 seconds, <input type="checkbox"/> 4.0 seconds	1.5
Pause Time	<input type="checkbox"/> 1.5 seconds, <input type="checkbox"/> 2.5 seconds, <input type="checkbox"/> 3.5 seconds, 0.4.5 seconds	3.5
Hook Switch Flash Time	<input type="checkbox"/> 80 mseconds, <input type="checkbox"/> 300 mseconds, <input type="checkbox"/> 600 mseconds, <input type="checkbox"/> 900 mseconds, <input type="checkbox"/> 1200 mseconds, <input type="checkbox"/> None	None

Remark

DDD: Direct Distance Dialing FEX: Foreign Exchange WATS: Wide Area Telecommunication Service PVL: Private Line PBX: Behind PBX DID: Direct Inward Dialing	ATT: Attendant Console DIL 1:1: Direct In Line (1 :1) DIL 1:N: Direct In Lines (1 :N) DISA Direct Inward System Access TAFAS1, 2: Trunk Answer From Any Station
--	--

Day mode: Change Night receiving mode to Day receiving mode.
 Fixed: Incoming call only arrives on either DN which set by Night Answer point of Trunk or External pager of Universal Night Answer (Can not change at Operator).
 Flexible: Incoming call only arrives on either DN which set by Night Answer point of Trunk or External pager of Universal Night Answer (Can be changed at Operator).
 • If ATLC is installed, default value for Incoming Mode (Day) is ATT.

GROUP-TRUNK GROUP (2/2)

Trunk Group No. 12

Item	Set Data	Default Value
Destination (DIL 1: N only) Type and Number	<input type="checkbox"/> " " - None <input type="checkbox"/> PCKUP → <input type="checkbox"/> <input type="checkbox"/> Pickup group No. (01 to 32) <input type="checkbox"/> EXT → <input type="checkbox"/> <input type="checkbox"/> <input type="checkbox"/> <input type="checkbox"/> DN (3 or 4 digits) <input type="checkbox"/> ICM → <input type="checkbox"/> ICM group No. (1 to 8)	blank
	<input type="checkbox"/> " " → None <input type="checkbox"/> PCKUP, <input type="checkbox"/> <input type="checkbox"/> Pickup group No. (01 to 32) <input type="checkbox"/> EXT → <input type="checkbox"/> <input type="checkbox"/> <input type="checkbox"/> <input type="checkbox"/> DN (3 or 4 digits) <input type="checkbox"/> ICM → <input type="checkbox"/> ICM group No. (1 to 8)	blank
	<input type="checkbox"/> 0 " → None <input type="checkbox"/> PCKUP → <input type="checkbox"/> <input type="checkbox"/> Pickup group No. (01 to 32) <input type="checkbox"/> EXT → <input type="checkbox"/> <input type="checkbox"/> <input type="checkbox"/> <input type="checkbox"/> DN (3 or 4 digits) <input type="checkbox"/> ICM → <input type="checkbox"/> ICM group No. (1 to 8)	blank
	<input type="checkbox"/> " " → None <input checked="" type="checkbox"/> PCKUP- <input type="checkbox"/> <input type="checkbox"/> Pickup group No. (01 to 32) <input type="checkbox"/> EXT → <input type="checkbox"/> <input type="checkbox"/> <input type="checkbox"/> <input type="checkbox"/> DN (3 or 4 digits) <input type="checkbox"/> ICM → <input type="checkbox"/> ICM group No. (1 to 8)	blank
	<input type="checkbox"/> " " → None <input type="checkbox"/> PCKUP- <input type="checkbox"/> <input type="checkbox"/> Pickup group No. (01 to 32) <input type="checkbox"/> EXT → <input type="checkbox"/> <input type="checkbox"/> <input type="checkbox"/> <input type="checkbox"/> DN (3 or 4 digits) <input type="checkbox"/> ICM → <input type="checkbox"/> ICM group No. (1 to 8)	blank
	<input checked="" type="checkbox"/> " " → None <input type="checkbox"/> PCKUP- <input type="checkbox"/> <input type="checkbox"/> Pickup group No. (01 to 32) <input type="checkbox"/> EXT → <input type="checkbox"/> <input type="checkbox"/> <input type="checkbox"/> <input type="checkbox"/> DN (3 or 4 digits) <input type="checkbox"/> ICM → <input type="checkbox"/> ICM group No. (1 to 8)	blank
	<input checked="" type="checkbox"/> " " → None <input type="checkbox"/> PCKUP- <input type="checkbox"/> <input type="checkbox"/> Pickup group No. (01 to 32) <input type="checkbox"/> EXT → <input type="checkbox"/> <input type="checkbox"/> <input type="checkbox"/> <input type="checkbox"/> DN (3 or 4 digits) <input type="checkbox"/> ICM → <input type="checkbox"/> ICM group No. (1 to 8)	blank
	<input checked="" type="checkbox"/> " " → None <input type="checkbox"/> PCKUP- <input type="checkbox"/> <input type="checkbox"/> Pickup group No. (01 to 32) <input type="checkbox"/> EXT → <input type="checkbox"/> <input type="checkbox"/> <input type="checkbox"/> <input type="checkbox"/> DN (3 or 4 digits) <input type="checkbox"/> ICM → <input type="checkbox"/> ICM group No. (1 to 8)	blank
DID Digit Modification Table	<input type="checkbox"/> 1 digit (1 to 4)	1
PBX Access Code with Pause	<input type="checkbox"/> <input type="checkbox"/> <input type="checkbox"/> <input type="checkbox"/> Max. 3 digits <input type="checkbox"/> <input type="checkbox"/> <input type="checkbox"/> <input type="checkbox"/> <input type="checkbox"/> <input type="checkbox"/> <input type="checkbox"/> <input type="checkbox"/> <input type="checkbox"/> <input type="checkbox"/> Figures (0 to 9)	blank
PBX Access Code with Restriction	<input type="checkbox"/> <input type="checkbox"/> <input type="checkbox"/> <input type="checkbox"/> <input type="checkbox"/> <input type="checkbox"/> <input type="checkbox"/> <input type="checkbox"/> <input type="checkbox"/> <input type="checkbox"/> Max. 3 digits <input type="checkbox"/> <input type="checkbox"/> <input type="checkbox"/> <input type="checkbox"/> <input type="checkbox"/> <input type="checkbox"/> <input type="checkbox"/> <input type="checkbox"/> <input type="checkbox"/> <input type="checkbox"/> Figures (0 to 9)	blank
Cr. Dial No. after EFA Signal	<input type="checkbox"/> (0 to 7)	0
CO Appearance Type	<input type="checkbox"/> Single <input type="checkbox"/> Group	Single

GROUP-TRUNK GROUP (1/2)

Trunk Group No. 13

Item	Set Data	Default Value
Type	<input type="checkbox"/> DDD, <input type="checkbox"/> FEX, <input type="checkbox"/> WAX, <input type="checkbox"/> PVL, <input type="checkbox"/> PBX, <input type="checkbox"/> DID	DDD
Name	- - - 3 digits (alphanumeric characters)	C O
Tenant	<input type="checkbox"/> 1, <input type="checkbox"/> 2	1 !
Incoming/Outgoing	<input type="checkbox"/> Incoming only, <input type="checkbox"/> Outgoing only, <input type="checkbox"/> Both-way	Both-way
incoming Mode (Day)	<input type="checkbox"/> ATT, <input type="checkbox"/> DISA, <input type="checkbox"/> DIL 1:1, <input type="checkbox"/> DIL 1:N, <input type="checkbox"/> TARS 1, <input type="checkbox"/> TAFAS 2	DIL 1:1 .
Incoming Mode (Night)	<input type="checkbox"/> FLEXIBLE, <input type="checkbox"/> FIXED, <input type="checkbox"/> Day Mode, <input type="checkbox"/> CXA	Flexible
Intercept Routing (Day)	<input type="checkbox"/> EXT → (3 o r 4 digits), <input type="checkbox"/> N o n e	None
Intercept Routing (Night)	<input type="checkbox"/> EXT → (3 o r 4 digits), <input type="checkbox"/> N o n e	None
Toll Restriction Level	2 digits (01 to 16)	16
Toll Restriction Table	1 digit (1 to 8)	1
Dialing Plan	<input type="checkbox"/> Type-A, <input type="checkbox"/> Type-B, <input type="checkbox"/> Type-C, <input type="checkbox"/> None	None
CO-CO Duration Limit	1 o r 2 minute(s) (1 t o 6 4)	10
Disconnect Time	<input type="checkbox"/> 1.5 seconds, <input type="checkbox"/> 4.0 seconds	1.5
Pause Time	<input type="checkbox"/> 1.5 seconds, <input type="checkbox"/> 2.5 seconds, <input type="checkbox"/> 3.5 seconds, <input type="checkbox"/> 4.5 seconds	3.5
Hook Switch Flash Time	<input type="checkbox"/> 80 m s e c o n d s, <input type="checkbox"/> 300 m s e c o n d s, <input type="checkbox"/> 600 m s e c o n d s, <input type="checkbox"/> 900 m s e c o n d s, <input type="checkbox"/> 1200 m s e c o n d s, <input type="checkbox"/> None	None

Remark	
DDD: Direct Distance Dialing FEX: Foreign Exchange WATS: Wide Area Telecommunication Service PVL: Private Line PBX: Behind PBX DID: Direct Inward Dialing	AI-I: Attendant Console DIL 1:1: Direct In Line (1 :1) DIL 1:N: Direct In Lines (1 :N) DISA: Direct Inward System Access TAFAS1, 2: Trunk Answer From Any Station
Day mode: Change Night receiving mode to Day receiving mode. Fixed: Incoming call only arrives on either DN which set by Night Answer point of Trunk or External pager of Universal Night Answer (Can not change at Operator). Flexible: Incoming call only arrives on either DN which set by Night Answer point of Trunk or External pager of Universal Night Answer (Can be changed at Operator). . If ATLC is installed, default value for Incoming Mode (Day) is ATT .	

GROUP-TRUNK GROUP (1/2)

Trunk Group No. 14

Item	Set Data	Default Value
Type	<input type="checkbox"/> DDD, <input type="checkbox"/> FEX, <input type="checkbox"/> WATS, <input type="checkbox"/> PVL, <input type="checkbox"/> PBX, <input type="checkbox"/> IDID	DDD
Name	- - - 3 digits (alphanumeric characters)'	c o
Tenant	<input type="checkbox"/> 1, <input type="checkbox"/> 2	1
Incoming/Outgoing	<input type="checkbox"/> Incoming only, <input type="checkbox"/> Outgoing only, <input type="checkbox"/> Both-way	Both-way
Incoming Mode (Day)	<input type="checkbox"/> JATT, <input type="checkbox"/> DISA, <input type="checkbox"/> DIL1:1, <input type="checkbox"/> DIL1:N, <input type="checkbox"/> TAFAS1, <input type="checkbox"/> TAFAS 2	DIL 1:1 .
Incoming Mode (Night)	<input type="checkbox"/> FLEXIBLE, <input type="checkbox"/> JFIXED, <input type="checkbox"/> Day Mode, <input type="checkbox"/> DISA	Flexible
Intercept Routing (Day)	<input type="checkbox"/> ATT <input type="checkbox"/> EXT → (3 or 4 digits). <input type="checkbox"/> None	None
Intercept Routing (Night)	<input type="checkbox"/> EXT → (3 or 4 digits), <input type="checkbox"/> None	None
Toll Restriction Level	2 digits (01 to 16)	16
Toll Restriction Table	_ _ 1 digit (1 to 8)	1
Dialing Plan	<input type="checkbox"/> Type-A, <input type="checkbox"/> Type-B, <input type="checkbox"/> Type-C, <input type="checkbox"/> None	None
CO-CO Duration Limit	1 or 2 minutes (1 to 64)	10
Disconnect Time	<input type="checkbox"/> 1.5 seconds, <input type="checkbox"/> 4.0 seconds	1.5
Pause Time	<input type="checkbox"/> 1.5 seconds, <input type="checkbox"/> 2.5 seconds, <input type="checkbox"/> 3.5 seconds, <input type="checkbox"/> 4.5 seconds	3.5
Hook Switch Flash Time	<input type="checkbox"/> 80 mseconds, <input type="checkbox"/> 300 mseconds, <input type="checkbox"/> 600 mseconds, <input type="checkbox"/> 900 mseconds, <input type="checkbox"/> 1200 mseconds, <input type="checkbox"/> None	None

Remark	
DDD: Direct Distance Dialing FEX: Foreign Exchange WATS: Wide Area Telecommunication Service PVL: Private Line PBX: Behind PBX DID: Direct Inward Dialing	AI-T: Attendant Console DIL 1:1: Direct In Line (1 :1) DIL 1:N: Direct In Lines (1:N) DISA Direct Inward System Access TAFAS1,2: Trunk Answer From Any Station
Day mode: Change Night receiving mode to Day receiving mode. Fixed: Incoming call only arrives on either DN which set by Night Answer point of Trunk or External pager of Universal Night Answer (Can not change at Operator). Flexible: Incoming call only arrives on either DN which set by Night Answer point of Trunk or External pager of Universal Night Answer (Can be changed at Operator). . If ATLC is installed, default value for Incoming Mode (Day) is ATT .	

GROUP-TRUNK GROUP (2/2)

Trunk Group No. 14

Item	Set Data	Default Value
Destination (DIL 1: N only) Type and Number	<input type="checkbox"/> " " - None <input type="checkbox"/> PCKUP- <input type="checkbox"/> <input type="checkbox"/> Pickup group No. (01 to 32) <input type="checkbox"/> EXT → <input type="checkbox"/> <input type="checkbox"/> <input type="checkbox"/> <input type="checkbox"/> DN (3 or 4 digits) <input type="checkbox"/> → <input type="checkbox"/> ICM group No. (1 to 8)	blank
	<input type="checkbox"/> " " - None <input type="checkbox"/> PCKUP- <input type="checkbox"/> <input type="checkbox"/> Pickup group No. (01 to 32) <input type="checkbox"/> EXT → <input type="checkbox"/> <input type="checkbox"/> <input type="checkbox"/> <input type="checkbox"/> DN (3 or 4 digits) <input type="checkbox"/> ICM → <input type="checkbox"/> ICM group No. (1 to 8)	blank
	<input type="checkbox"/> " " → None <input type="checkbox"/> PCKUP- <input type="checkbox"/> <input type="checkbox"/> Pickup group No. (01 to 32) <input type="checkbox"/> EXT → <input type="checkbox"/> <input type="checkbox"/> <input type="checkbox"/> <input type="checkbox"/> DN (3 or 4 digits) <input type="checkbox"/> → <input type="checkbox"/> ICM group No. (1 to 8)	blank
	<input type="checkbox"/> " " → None <input type="checkbox"/> PCKUP- <input type="checkbox"/> <input type="checkbox"/> Pickup group No. (01 to 32) <input type="checkbox"/> → <input type="checkbox"/> <input type="checkbox"/> <input type="checkbox"/> <input type="checkbox"/> DN (3 or 4 digits) <input type="checkbox"/> ICM → <input type="checkbox"/> ICM group No. (1 to 8)	blank
	<input type="checkbox"/> " " → None <input type="checkbox"/> PCKUP → <input type="checkbox"/> <input type="checkbox"/> Pickup group No. (01 to 32) <input type="checkbox"/> EXT → <input type="checkbox"/> <input type="checkbox"/> <input type="checkbox"/> <input type="checkbox"/> DN (3 or 4 digits) <input type="checkbox"/> → <input type="checkbox"/> ICM group No. (1 to 8)	blank
	<input type="checkbox"/> " " → None <input type="checkbox"/> PCKUP → <input type="checkbox"/> <input type="checkbox"/> Pickup group No. (01 to 32) <input type="checkbox"/> EXT → <input type="checkbox"/> <input type="checkbox"/> <input type="checkbox"/> <input type="checkbox"/> DN (3 or 4 digits) <input type="checkbox"/> → <input type="checkbox"/> ICM group No. (1 to 8)	blank
	<input type="checkbox"/> " " → None <input type="checkbox"/> PCKUP → <input type="checkbox"/> <input type="checkbox"/> Pickup group No. (01 to 32) <input type="checkbox"/> EXT → <input type="checkbox"/> <input type="checkbox"/> <input type="checkbox"/> <input type="checkbox"/> DN (3 or 4 digits) <input type="checkbox"/> ICM → <input type="checkbox"/> ICM group No. (1 to 8)	blank
	<input type="checkbox"/> " " → None <input type="checkbox"/> PCKUP → <input type="checkbox"/> <input type="checkbox"/> Pickup group No. (01 to 32) <input type="checkbox"/> → <input type="checkbox"/> <input type="checkbox"/> <input type="checkbox"/> <input type="checkbox"/> DN (3 or 4 digits) <input type="checkbox"/> ICM → <input type="checkbox"/> ICM group No. (1 to 8)	blank
MO Digit Modification Table	<input type="checkbox"/> 1 digit (1 to 4)	1
MBX Access Code with Pause	<input type="checkbox"/> ● <input type="checkbox"/> ☺ <input type="checkbox"/> Ⓜ <input type="checkbox"/> ● <input type="checkbox"/> ☺ <input type="checkbox"/> ● <input type="checkbox"/> <input type="checkbox"/> <input type="checkbox"/> <input type="checkbox"/> <input type="checkbox"/> <input type="checkbox"/> <input type="checkbox"/> <input type="checkbox"/> Max. 3 digits <input type="checkbox"/> † † <input type="checkbox"/> † <input type="checkbox"/> <input type="checkbox"/> <input type="checkbox"/> <input type="checkbox"/> <input type="checkbox"/> <input type="checkbox"/> <input type="checkbox"/> <input type="checkbox"/> Figures (0 to 9)	blank
MBX Access Code with Restriction	<input type="checkbox"/> <input type="checkbox"/> o n <input type="checkbox"/> <input type="checkbox"/> <input type="checkbox"/> <input type="checkbox"/> <input type="checkbox"/> <input type="checkbox"/> <input type="checkbox"/> <input type="checkbox"/> <input type="checkbox"/> <input type="checkbox"/> Max. 3 digits <input type="checkbox"/> ● <input type="checkbox"/> ● <input type="checkbox"/> <input type="checkbox"/> † <input type="checkbox"/> <input type="checkbox"/> † <input type="checkbox"/> ☺ <input type="checkbox"/> <input type="checkbox"/> Figures (0 to 9)	blank
Max. Dial No. after EFA Signal	<input type="checkbox"/> (0 to 7)	0
MO Appearance Type	<input type="checkbox"/> Single <input type="checkbox"/> Group	Single

GROUP-TRUNK GROUP (112)

Trunk Group No. 15

Item	Set Data	Default Value
Type	<input type="checkbox"/> DDD, <input type="checkbox"/> EX, <input type="checkbox"/> WATS, <input type="checkbox"/> PVL, <input type="checkbox"/> PBx, <input type="checkbox"/> DID	DDD
Name	- - - 3 digits (alphanumeric characters)	co
Tenant	<input type="checkbox"/> 1, <input type="checkbox"/> 2	1
Incoming/Outgoing	<input type="checkbox"/> Incoming only, <input type="checkbox"/> Outgoing only, <input type="checkbox"/> Both-way	Both-way
Incoming Mode (Day)	<input type="checkbox"/> ATT, <input type="checkbox"/> DISA, <input type="checkbox"/> DIL 1:1, <input type="checkbox"/> DIL 1:N, <input type="checkbox"/> TAFAS 1, <input type="checkbox"/> TAFAS 2	DIL 1:1
Incoming Mode (Night)	<input type="checkbox"/> FLEXIBLE, <input type="checkbox"/> VXED, <input type="checkbox"/> Day Mode, <input type="checkbox"/> DISA	Flexible
Intercept Routing (Day)	<input type="checkbox"/> → (3 or 4 digits), <input type="checkbox"/> None	None
Intercept Routing (Night)	<input type="checkbox"/> EXT → (3 or 4 digits), <input type="checkbox"/> None	None
Toll Restriction Level	- - 2 digits (01 to 16)	16
Toll Restriction Table	___ 1 digit (1 to 8)	1
Dialing Plan	<input type="checkbox"/> Type-A, <input type="checkbox"/> Type-B, <input type="checkbox"/> Type-C, <input type="checkbox"/> None	None
CO-CO Duration Limit	1 or 2 minute(s) (1 to 64)	10
Disconnect Time	<input type="checkbox"/> 1.5 seconds, <input type="checkbox"/> 4.0 seconds	1.5
Pause Time	<input type="checkbox"/> 1.5 seconds, <input type="checkbox"/> 2.5 seconds, <input type="checkbox"/> 3.5 seconds, <input type="checkbox"/> 4.5 seconds	3.5
Hook Switch Flash Time	<input type="checkbox"/> 80 mseconds, <input type="checkbox"/> 300 mseconds, <input type="checkbox"/> 600 mseconds, <input type="checkbox"/> 900 mseconds, <input type="checkbox"/> 1200 mseconds, <input type="checkbox"/> None	None

Remark

- | | |
|---|---|
| <p>DDD: Direct Distance Dialing</p> <p>FEX: Foreign Exchange</p> <p>WATS: Wide Area Telecommunication Service</p> <p>PVL: Private Line</p> <p>PBX: Behind PBX</p> <p>DID: Direct Inward Dialing</p> | <p>AI-r: Attendant Console</p> <p>DIL 1:1: Direct In Line (1 :1)</p> <p>DIL 1 :N: Direct In Lines (1:N)</p> <p>DISA: Direct inward System Access</p> <p>TAFAS1, 2: Trunk Answer From Any Station</p> |
|---|---|

Day mode: Change Night receiving mode to Day receiving mode.

Fixed: Incoming call only arrives on either DN which set by Night Answer point of Trunk or External pager of Universal Night Answer (Can not change at Operator).

Flexible: Incoming call only arrives on either DN which set by Night Answer point of Trunk or External pager of Universal Night Answer (Can be changed at Operator).

. if ATLC is installed, default value for Incoming Mode (Day) is **ATT**.

GROUP—TRUNK GROUP (1/2)

Trunk Group No. 16

Item	Set Data	Default Value
Type	<input type="checkbox"/> DDD, <input type="checkbox"/> FEX, <input type="checkbox"/> WATS, <input type="checkbox"/> PVL, <input type="checkbox"/> PBX, <input type="checkbox"/> DID	DDD
Name	_____ 3 digits (alphanumeric characters)	CO
Tenant	<input type="checkbox"/> 1, <input type="checkbox"/> 2	1
Incoming/Outgoing	<input type="checkbox"/> Incoming only, <input type="checkbox"/> Outgoing only, <input type="checkbox"/> Both-way	Both-way
Incoming Mode (Day)	<input type="checkbox"/> ATT, <input type="checkbox"/> DISA, <input type="checkbox"/> DIL 1:1, <input type="checkbox"/> DIL 1:N, <input type="checkbox"/> TAFAS 1, <input type="checkbox"/> TAFAS 2	DIL 1:1
Incoming Mode (Night)	<input type="checkbox"/> FLEXIBLE, <input type="checkbox"/> FIXED, <input type="checkbox"/> Day Mode, <input type="checkbox"/> DISA	Flexible
Intercept Routing (Day)	<input type="checkbox"/> ATT <input type="checkbox"/> EXT → _____ (3 or 4digits), <input type="checkbox"/> None	None
Intercept Routing (Night)	<input type="checkbox"/> EXT → _____ (3 or 4digits), <input type="checkbox"/> None	None
Toll Restriction Level	_____ 2 digits (01 to 16)	16
Toll Restriction Table	_____ 1 digit (1 to 8)	1
Dialing Plan	<input type="checkbox"/> Type-A, <input type="checkbox"/> Type-B, <input type="checkbox"/> Type-C, <input type="checkbox"/> None	None
CO-CO Duration Limit	_____ minute(s) 1 or 2 digits (1 to 64)	10
Disconnect Time	<input type="checkbox"/> 1.5 seconds, <input type="checkbox"/> 4.0 seconds	1.5
Pause Time	<input type="checkbox"/> 1.5 seconds, <input type="checkbox"/> 2.5 seconds, <input type="checkbox"/> 3.5 seconds, <input type="checkbox"/> 4.5 seconds	3.5
Hook Switch Flash Time	<input type="checkbox"/> 80 mseconds, <input type="checkbox"/> 300 mseconds, <input type="checkbox"/> 600 mseconds, <input type="checkbox"/> 900 mseconds, <input type="checkbox"/> 1200 mseconds, <input type="checkbox"/> None	None

Remark

DDD: Direct Distance Dialing	ATT: Attendant Console
FEX: Foreign Exchange	DIL 1:1: Direct In Line (1:1)
WATS: Wide Area Telecommunication Service	DIL 1:N: Direct In Lines (1:N)
PVL: Private Line	DISA: Direct Inward System Access
PBX: Behind PBX	TAFAS1, 2: Trunk Answer From Any Station
DID: Direct Inward Dialing	

Day mode: Change Night receiving mode to Day receiving mode.

Fixed: Incoming call only arrives on either DN which set by Night Answer point of Trunk or External pager of Universal Night Answer (Can not change at Operator).

Flexible: Incoming call only arrives on either DN which set by Night Answer point of Trunk or External pager of Universal Night Answer (Can be changed at Operator).

* If ATLC is installed, default value for Incoming Mode (Day) is ATT.

GROUP-TRUNK GROUP (2/2)

Trunk Group No. 16

Item	Set Data	Default Value
Destination (DIL 1: N only) Type and Number	<input type="checkbox"/> " " → None <input type="checkbox"/> PCKUP- <input type="checkbox"/> <input type="checkbox"/> Pickup group No. (01 to 32) <input type="checkbox"/> EXT → <input type="checkbox"/> <input type="checkbox"/> <input type="checkbox"/> <input type="checkbox"/> DN (3 or 4 digits) <input type="checkbox"/> ICM → <input type="checkbox"/> ICM group No. (1 to 8)	blank
	<input type="checkbox"/> c l " " → None <input type="checkbox"/> PCKUP → <input type="checkbox"/> <input type="checkbox"/> Pickup group No. (01 to 32) <input type="checkbox"/> EXT → <input type="checkbox"/> <input type="checkbox"/> <input type="checkbox"/> <input type="checkbox"/> DN (3 or 4 digits) <input type="checkbox"/> → <input type="checkbox"/> ICM group No. (1 to 8)	blank
	<input type="checkbox"/> c l " " → None <input type="checkbox"/> PCKUP- <input type="checkbox"/> <input type="checkbox"/> Pickup group No. (01 to 32) <input type="checkbox"/> → <input type="checkbox"/> <input type="checkbox"/> <input type="checkbox"/> <input type="checkbox"/> DN (3 or 4 digits) <input type="checkbox"/> → <input type="checkbox"/> ICM group No. (1 to 8)	blank
	<input type="checkbox"/> " " → None <input type="checkbox"/> PCKUP → <input type="checkbox"/> <input type="checkbox"/> Pickup group No. (01 to 32) <input type="checkbox"/> EXT → <input type="checkbox"/> <input type="checkbox"/> <input type="checkbox"/> <input type="checkbox"/> DN (3 or 4 digits) <input type="checkbox"/> → <input type="checkbox"/> ICM group No. (1 to 8)	blank
	<input type="checkbox"/> " " - None <input type="checkbox"/> PCKUP → <input type="checkbox"/> <input type="checkbox"/> Pickup group No. (01 to 32) <input type="checkbox"/> EXT → <input type="checkbox"/> <input type="checkbox"/> <input type="checkbox"/> <input type="checkbox"/> DN (3 or 4 digits) <input type="checkbox"/> → <input type="checkbox"/> ICM group No. (1 to 8)	blank
	<input type="checkbox"/> " " → None <input type="checkbox"/> PCKUP → <input type="checkbox"/> <input type="checkbox"/> Pickup group No. (01 to 32) <input type="checkbox"/> EXT → <input type="checkbox"/> <input type="checkbox"/> <input type="checkbox"/> <input type="checkbox"/> DN (3 or 4 digits) <input type="checkbox"/> ICM → <input type="checkbox"/> ICM group No. (1 to 8)	blank
	<input type="checkbox"/> c l " " → None <input type="checkbox"/> PCKUP → <input type="checkbox"/> <input type="checkbox"/> Pickup group No. (01 to 32) <input type="checkbox"/> EXT → <input type="checkbox"/> <input type="checkbox"/> <input type="checkbox"/> <input type="checkbox"/> DN (3 or 4 digits) <input type="checkbox"/> ICM → <input type="checkbox"/> ICM group No. (1 to 8)	blank
	<input type="checkbox"/> " " → None <input type="checkbox"/> PCKUP → <input type="checkbox"/> <input type="checkbox"/> Pickup group No. (01 to 32) <input type="checkbox"/> EXT → <input type="checkbox"/> <input type="checkbox"/> <input type="checkbox"/> <input type="checkbox"/> DN (3 or 4 digits) <input type="checkbox"/> ICM → <input type="checkbox"/> ICM group No. (1 to 8)	blank
CO Digit Modification Table	<input type="checkbox"/> 1 digit (1 to 4)	1
CBX Access Code with Pause	<input type="checkbox"/> <input type="checkbox"/> <input type="checkbox"/> <input type="checkbox"/> <input type="checkbox"/> <input type="checkbox"/> <input type="checkbox"/> <input type="checkbox"/> <input type="checkbox"/> <input type="checkbox"/> <input type="checkbox"/> <input type="checkbox"/> <input type="checkbox"/> <input type="checkbox"/> <input type="checkbox"/> Max. 3 digits <input type="checkbox"/> <input type="checkbox"/> <input type="checkbox"/> <input type="checkbox"/> <input type="checkbox"/> <input type="checkbox"/> <input type="checkbox"/> <input type="checkbox"/> <input type="checkbox"/> <input type="checkbox"/> <input type="checkbox"/> Figures (0 to 9)	blank
CBX Access Code with Restriction	<input type="checkbox"/> <input type="checkbox"/> <input type="checkbox"/> <input type="checkbox"/> <input type="checkbox"/> <input type="checkbox"/> <input type="checkbox"/> <input type="checkbox"/> <input type="checkbox"/> <input type="checkbox"/> <input type="checkbox"/> Max. 3 digits <input type="checkbox"/> <input type="checkbox"/> <input type="checkbox"/> <input type="checkbox"/> <input type="checkbox"/> <input type="checkbox"/> <input type="checkbox"/> <input type="checkbox"/> <input type="checkbox"/> <input type="checkbox"/> <input type="checkbox"/> <input type="checkbox"/> Figures (0 to 9)	blank
Max. Dial No. after EFA Signal	c l (0 to 7)	0
CO Appearance Type	<input type="checkbox"/> Single <input type="checkbox"/> Group	Single

GROUP—ICM/PAGING GROUP

Item	Set Data		Default Value
ICM Group	1	<input type="checkbox"/> Tenant 1, <input type="checkbox"/> Tenant 2	Tenant 1
	2	<input type="checkbox"/> Tenant 1, <input type="checkbox"/> Tenant 2	
	3	<input type="checkbox"/> Tenant 1, <input type="checkbox"/> Tenant 2	
	4	<input type="checkbox"/> Tenant 1, <input type="checkbox"/> Tenant 2	
	5	<input type="checkbox"/> Tenant 1, <input type="checkbox"/> Tenant 2	
	6	<input type="checkbox"/> Tenant 1, <input type="checkbox"/> Tenant 2	
	7	<input type="checkbox"/> Tenant 1, <input type="checkbox"/> Tenant 2	
	8	<input type="checkbox"/> Tenant 1, <input type="checkbox"/> Tenant 2	
PAG Group	1	<input type="checkbox"/> Tenant 1, <input type="checkbox"/> Tenant 2	Tenant 1
	2	<input type="checkbox"/> Tenant 1, <input type="checkbox"/> Tenant 2	
	3	<input type="checkbox"/> Tenant 1, <input type="checkbox"/> Tenant 2	
	4	<input type="checkbox"/> Tenant 1, <input type="checkbox"/> Tenant 2	
	5	<input type="checkbox"/> Tenant 1, <input type="checkbox"/> Tenant 2	
	6	<input type="checkbox"/> Tenant 1, <input checked="" type="checkbox"/> Tenant 2	
	7	<input checked="" type="checkbox"/> Tenant 1, <input type="checkbox"/> Tenant 2	
	8	<input type="checkbox"/> Tenant 1, <input type="checkbox"/> Tenant 2	

GROUP-CALL PICKUP GROUP

Call Pickup Group	Set Data			Call Pickup Group	Set Data		
	ICM Group Number	UCD Group Number	Paging Group Number		ICM Group Number	UCD Group Number	Paging Group Number
01	---	---		17		---	
02		---		18		---	
03	---	---		19		---	
04		---		20		---	---
05	---	---	---	21	---	---	---
06		---		22	---	---	
07	---	---	---	23		---	
08	---	---		24		---	
09	---	---		25		---	
10	---	---		26		---	
11	---	---		27		---	
12	---	---		28		---	
13		---		29		---	
14	---	---		30		---	
15	---	---		31		---	
16	---	---		32		---	

Note:

	Selection of Value	Default Value
ICM Group Number	1 digit (1 to 8)	1
UCD Group Number	2 digits (01 to 32) or space (no belonging)	blank
Paging Group Number	1 digit (1 to 8) or space (no belonging)	blank

5. Trunk

)

TRUNK—CO LINE

Item	Trunk Equipment Number								Default Value
Trunk Group	(2 digits: 01 to 16)	(2 digits: 01 to 16)	(2 digits: 01 to 16)	(2 digits: 01 to 16)	(2 digits: 01 to 16)	(2 digits: 01 to 16)	(2 digits: 01 to 16)	(2 digits: 01 to 16)	co: 01 DID: 16
Trunk Name	-----	-----	-----	-----	-----	-----	-----	-----	Txxxx Physical Number
Direct Termination	<input type="checkbox"/> DN (3 or 4 digits) <input type="checkbox"/> None	<input type="checkbox"/> DN (3 or 4 digits) <input type="checkbox"/> None	<input type="checkbox"/> DN (3 or 4 digits) <input type="checkbox"/> None	<input type="checkbox"/> DN (3 or 4 digits) <input type="checkbox"/> None	<input type="checkbox"/> DN (3 or 4 digits) <input type="checkbox"/> None	<input type="checkbox"/> DN (3 or 4 digits) <input type="checkbox"/> None	<input type="checkbox"/> DN (3 or 4 digits) <input type="checkbox"/> None	<input type="checkbox"/> DN (3 or 4 digits) <input type="checkbox"/> None	CO: Ext. No with ATLC: blank
Night Answer Point (Type: No.)	<input type="checkbox"/> <input type="checkbox"/> uNA2 <input type="checkbox"/> EXT (3 or 4 digits) <input type="checkbox"/> RMT <input type="checkbox"/> None	<input type="checkbox"/> UNA1 <input type="checkbox"/> UNA2 <input type="checkbox"/> EXT (3 or 4 digits) <input type="checkbox"/> RMT <input type="checkbox"/> None	<input type="checkbox"/> UNA1 <input type="checkbox"/> lntdA2 <input type="checkbox"/> EXT (3 or 4 digits) <input type="checkbox"/> RMT <input type="checkbox"/> None	<input type="checkbox"/> uNAi, <input type="checkbox"/> UNA2 <input type="checkbox"/> EXT (3 or 4 digits) <input type="checkbox"/> RMT <input type="checkbox"/> None	<input type="checkbox"/> lUNAI, <input type="checkbox"/> UNA2 <input type="checkbox"/> EXT (3 or 4 digits) <input type="checkbox"/> RMT <input type="checkbox"/> None	<input type="checkbox"/> UNA1, <input type="checkbox"/> UNA2 <input type="checkbox"/> EXT (3 or 4 digits) <input type="checkbox"/> RMT <input type="checkbox"/> None	<input type="checkbox"/> lUNAI, <input type="checkbox"/> UNA2 <input type="checkbox"/> EXT (3 or 4 digits) <input type="checkbox"/> RMT <input type="checkbox"/> None	<input type="checkbox"/> lUNAI, <input type="checkbox"/> UNA2 <input type="checkbox"/> EXT (3 or 4 digits) <input type="checkbox"/> RMT <input type="checkbox"/> None	CO: Ext. No
Dial Mode	<input type="checkbox"/> DTMF Pulse <input type="checkbox"/> Pulse	<input type="checkbox"/> DTMF Pulse <input type="checkbox"/> Pulse	<input type="checkbox"/> DTMF Pulse <input type="checkbox"/> Pulse	<input type="checkbox"/> IDTMF Pulse <input type="checkbox"/> Pulse	<input type="checkbox"/> DTMF <input type="checkbox"/> Pulse	<input type="checkbox"/> DTMF <input type="checkbox"/> Pulse	<input type="checkbox"/> DTMF <input type="checkbox"/> Pulse	<input type="checkbox"/> DTMF <input type="checkbox"/> Pulse	DTMF 80
DTMF Duration Time	<input type="checkbox"/> 80 mseconds <input type="checkbox"/> 160 mseconds	<input type="checkbox"/> 80 mseconds <input type="checkbox"/> 160 mseconds	<input type="checkbox"/> 80 mseconds <input type="checkbox"/> 160 mseconds	<input type="checkbox"/> 80 mseconds <input type="checkbox"/> 160 mseconds	<input type="checkbox"/> 80 mseconds <input type="checkbox"/> 160 mseconds	<input type="checkbox"/> 80 mseconds <input type="checkbox"/> 160 mseconds	<input type="checkbox"/> 80 mseconds <input type="checkbox"/> 160 mseconds	<input type="checkbox"/> 80 mseconds <input type="checkbox"/> 160 mseconds	80
Pulse Speed	<input type="checkbox"/> LOW (10 pps) <input type="checkbox"/> High (20 pps)	<input type="checkbox"/> Low (10 pps) <input type="checkbox"/> High (20 pps)	<input type="checkbox"/> LOW (10 pps) <input type="checkbox"/> High (20 pps)	<input type="checkbox"/> Low (10 pps) <input type="checkbox"/> High (20 pps)	<input type="checkbox"/> LOW (10 pps) <input type="checkbox"/> High (20 pps)	<input type="checkbox"/> Low (10 pps) <input type="checkbox"/> High (20 pps)	<input type="checkbox"/> Low (10 pps) <input type="checkbox"/> High (20 pps)	<input type="checkbox"/> Low (10 pps) <input type="checkbox"/> High (20 pps)	
% Break	<input type="checkbox"/> 60% <input type="checkbox"/> 67%	<input type="checkbox"/> 60% <input type="checkbox"/> 67%	<input type="checkbox"/> <input type="checkbox"/> 67%	<input type="checkbox"/> <input type="checkbox"/> 67%	<input type="checkbox"/> 60% <input type="checkbox"/> 67%	<input type="checkbox"/> 60% <input type="checkbox"/> 67%	<input type="checkbox"/> 60% <input type="checkbox"/> 67%	<input type="checkbox"/> 60% <input type="checkbox"/> 67%	
CPC Detection	<input type="checkbox"/> 06.5 mseconds <input type="checkbox"/> 8 x ___ /msec. <input type="checkbox"/> None	<input type="checkbox"/> 6.5 mseconds <input type="checkbox"/> 8 x ___ /msec. <input type="checkbox"/> None	<input type="checkbox"/> 6.5 mseconds <input type="checkbox"/> 8 x ___ /msec. <input type="checkbox"/> None	<input type="checkbox"/> 06.5 mseconds <input type="checkbox"/> 8 x ___ /msec. <input type="checkbox"/> None	<input type="checkbox"/> 6.5 mseconds <input type="checkbox"/> 8 x ___ /msec. <input type="checkbox"/> None	<input type="checkbox"/> 6.5 mseconds <input type="checkbox"/> 8 x ___ /msec. <input type="checkbox"/> None	<input type="checkbox"/> 6.5 mseconds <input type="checkbox"/> 8 x ___ /msec. <input type="checkbox"/> None	<input type="checkbox"/> 6.5 mseconds <input type="checkbox"/> 8 x ___ /msec. <input type="checkbox"/> None	50 (400ms)
DID start Arrangement	<input type="checkbox"/> immediate Start <input type="checkbox"/> Send Delay Wink	<input type="checkbox"/> Immediate Start <input type="checkbox"/> Send Delay Wink	<input type="checkbox"/> immediate Start <input type="checkbox"/> Send Delay Wink	<input type="checkbox"/> immediate Start <input type="checkbox"/> Send Delay Wink	<input type="checkbox"/> Immediate Start <input type="checkbox"/> Send Delay Wink	<input type="checkbox"/> Immediate Start <input type="checkbox"/> Send Delay Wink	<input type="checkbox"/> Immediate Start <input type="checkbox"/> Send Delay Wink	<input type="checkbox"/> Immediate Start <input type="checkbox"/> Send Delay Wink	Send Delay Wink

TRUNK--CO LINE

Item	Trunk Equipment Number								Default Value
Trunk Group	(2 digits: 01 to 16)	(2 digits: 01 to 16)	(2 digits: 01 to 16)	(2 digits: 01 to 16)	(2 digits: 01 to 16)	(2 digits: 01 to 16)	(2 digits: 01 to 16)	(2 digits: 01 to 16)	co: 01 DID: 16
Trunk Name									Txxxx Physical Number
Direct Termination	<input type="checkbox"/> ON (3 or 4 digits) <input type="checkbox"/> None	<input type="checkbox"/> DN (3 or 4 digits) <input type="checkbox"/> None	<input type="checkbox"/> DN (3 or 4 digits) <input type="checkbox"/> None	<input type="checkbox"/> DN (3 or 4 digits) <input type="checkbox"/> None	<input type="checkbox"/> DN (3 or 4 digits) <input type="checkbox"/> None	<input type="checkbox"/> DN (3 or 4 digits) <input type="checkbox"/> None	<input type="checkbox"/> DN (3 or 4 digits) <input type="checkbox"/> None	<input type="checkbox"/> DN (3 or 4 digits) <input type="checkbox"/> None	CO: Ext. No. with ATLC: blank
Night Answer Point (Type: No.)	<input type="checkbox"/> IUNAI <input type="checkbox"/> UNAI <input type="checkbox"/> EXT (3 or 4 digits) <input type="checkbox"/> RMT <input type="checkbox"/> None	<input type="checkbox"/> IUNAI <input type="checkbox"/> UNAI <input type="checkbox"/> EXT (3 or 4 digits) <input type="checkbox"/> RMT <input type="checkbox"/> None	<input type="checkbox"/> UNAI <input type="checkbox"/> UNAI <input type="checkbox"/> EXT (3 or 4 digits) <input type="checkbox"/> RMT <input type="checkbox"/> None	<input type="checkbox"/> UNAI <input type="checkbox"/> UNAI <input type="checkbox"/> EXT (3 or 4 digits) <input type="checkbox"/> RMT <input type="checkbox"/> None	<input type="checkbox"/> UNAI <input type="checkbox"/> UNAI <input type="checkbox"/> EXT (3 or 4 digits) <input type="checkbox"/> RMT <input type="checkbox"/> None	<input type="checkbox"/> IUNAI <input type="checkbox"/> UNAI <input type="checkbox"/> EXT (3 or 4 digits) <input type="checkbox"/> RMT <input type="checkbox"/> None	<input type="checkbox"/> UNAI <input type="checkbox"/> UNAI <input type="checkbox"/> EXT (3 or 4 digits) <input type="checkbox"/> RMT <input type="checkbox"/> None	<input type="checkbox"/> IUNAI <input type="checkbox"/> UNAI <input type="checkbox"/> EXT (3 or 4 digits) <input type="checkbox"/> RMT <input type="checkbox"/> None	CO: Ext. No.
Dial Mode	<input type="checkbox"/> DTMF <input type="checkbox"/> Pulse	<input type="checkbox"/> DTMF <input type="checkbox"/> IPulse	<input type="checkbox"/> DTMF <input type="checkbox"/> Pulse	<input type="checkbox"/> DTMF <input type="checkbox"/> Pulse	<input type="checkbox"/> DTMF <input type="checkbox"/> Pulse	<input type="checkbox"/> DTMF <input type="checkbox"/> Pulse	<input type="checkbox"/> DTMF <input type="checkbox"/> Pulse	<input type="checkbox"/> DTMF <input type="checkbox"/> Pulse	DTMF
DTMF Duration Time	<input type="checkbox"/> 80 mseconds <input type="checkbox"/> 160 mseconds	<input type="checkbox"/> 80 mseconds <input type="checkbox"/> 160 mseconds	<input type="checkbox"/> 80 mseconds <input type="checkbox"/> 160 mseconds	<input type="checkbox"/> 80 mseconds <input type="checkbox"/> 160 mseconds	<input type="checkbox"/> 80 mseconds <input type="checkbox"/> 160 mseconds	<input type="checkbox"/> 80 mseconds <input type="checkbox"/> 160 mseconds	<input type="checkbox"/> 80 mseconds <input type="checkbox"/> 160 mseconds	<input type="checkbox"/> 80 mseconds <input type="checkbox"/> 160 mseconds	80
Pulse Speed	<input type="checkbox"/> Low (10 pps) <input type="checkbox"/> High (20 pps)	<input type="checkbox"/> Low (10 pps) <input type="checkbox"/> High (20 pps)	<input type="checkbox"/> Low (10 pps) <input type="checkbox"/> High (20 pps)	<input type="checkbox"/> Low (10 pps) <input type="checkbox"/> High (20 pps)	<input type="checkbox"/> Low (10 pps) <input type="checkbox"/> High (20 pps)	<input type="checkbox"/> Low (10 pps) <input type="checkbox"/> High (20 pps)	<input type="checkbox"/> Low (10 pps) <input type="checkbox"/> High (20 pps)	<input type="checkbox"/> Low (10 pps) <input type="checkbox"/> High (20 pps)	—
% Break	<input type="checkbox"/> 60% <input type="checkbox"/> 67%	<input type="checkbox"/> 60% <input type="checkbox"/> 67%	<input type="checkbox"/> 60% <input type="checkbox"/> 67%	<input type="checkbox"/> 60% <input type="checkbox"/> 67%	<input type="checkbox"/> 60% <input type="checkbox"/> 67%	<input type="checkbox"/> 60% <input type="checkbox"/> 67%	<input type="checkbox"/> 60% <input type="checkbox"/> 67%	<input type="checkbox"/> 60% <input type="checkbox"/> 67%	—
CPC Detection	<input type="checkbox"/> 6.5 mseconds <input type="checkbox"/> 8 x ___ /msec. <input type="checkbox"/> None	<input type="checkbox"/> 6.5 mseconds <input type="checkbox"/> 8 x ___ /msec. <input type="checkbox"/> None	<input type="checkbox"/> 6.5 mseconds <input type="checkbox"/> 8 x ___ /msec. <input type="checkbox"/> None	<input type="checkbox"/> 6.5 mseconds <input type="checkbox"/> 8 x ___ /msec. <input type="checkbox"/> None	<input type="checkbox"/> 6.5 mseconds <input type="checkbox"/> 8 x ___ /msec. <input type="checkbox"/> None	<input type="checkbox"/> 6.5 mseconds <input type="checkbox"/> 8 x ___ /msec. <input type="checkbox"/> None	<input type="checkbox"/> 6.5 mseconds <input type="checkbox"/> 8 x ___ /msec. <input type="checkbox"/> None	<input type="checkbox"/> 6.5 mseconds <input type="checkbox"/> 8 x ___ /msec. <input type="checkbox"/> None	50 (400ms)
DID start Arrangement	<input type="checkbox"/> Immediate Start <input type="checkbox"/> Send Delay Wink	<input type="checkbox"/> immediate Start <input type="checkbox"/> Send Delay Wink	<input type="checkbox"/> immediate Start <input type="checkbox"/> Send Delay Wink	<input type="checkbox"/> immediate Start <input type="checkbox"/> Send Delay Wink	<input type="checkbox"/> immediate Start <input type="checkbox"/> Send Delay Wink	<input type="checkbox"/> immediate Start <input type="checkbox"/> Send Delay Wink	<input type="checkbox"/> immediate Start <input type="checkbox"/> Send Delay Wink	<input type="checkbox"/> immediate Start <input type="checkbox"/> Send Delay Wink	Send Delay Wink

5-2

TRUNK—CO LINE

Item	Trunk Equipment Number								Default Value
Trunk Group	(2 digits: 01 to 16)	(2 digits: 01 to 16)	(2 digits: 01 to 16)	(2 digits: 01 to 16)	(2 digits: 01 to 16)	(2 digits: 01 to 16)	(2 digits: 01 to 16)	(2 digits: 01 to 16)	co: 01 DID: 16
Trunk Name	-----								Txxxx Physical Number
Direct Termination	<input type="checkbox"/> ON (3 or 4 digits) <input type="checkbox"/> None	<input type="checkbox"/> DN (3 or 4 digits) <input type="checkbox"/> None	<input type="checkbox"/> DN (3 or 4 digits) <input type="checkbox"/> None	<input type="checkbox"/> DN (3 or 4 digits) <input type="checkbox"/> None	<input type="checkbox"/> DN (3 or 4 digits) <input type="checkbox"/> None	<input type="checkbox"/> DN (3 or 4 digits) <input type="checkbox"/> None	<input type="checkbox"/> DN (3 or 4 digits) <input type="checkbox"/> None	<input type="checkbox"/> DN (3 or 4 digits) <input type="checkbox"/> None	CO: Ext No with ATLC: blank
Night Answer Point (Type: No.)	<input type="checkbox"/> uNAi, <input type="checkbox"/> qT (3 or 4 digits) <input type="checkbox"/> RMT <input type="checkbox"/> None	<input type="checkbox"/> uNA2 <input type="checkbox"/> UNA1, <input type="checkbox"/> EXT (3 or 4 digits) <input type="checkbox"/> RMT <input type="checkbox"/> None	<input type="checkbox"/> uNA2 <input type="checkbox"/> UNA1, <input type="checkbox"/> EXT (3 or 4 digits) <input type="checkbox"/> RMT <input type="checkbox"/> None	<input type="checkbox"/> uNA2 <input type="checkbox"/> UNA1, <input type="checkbox"/> EXT (3 or 4 digits) <input type="checkbox"/> RMT <input type="checkbox"/> None	<input type="checkbox"/> uNA2 <input type="checkbox"/> UNA1, <input type="checkbox"/> EXT (3 or 4 digits) <input type="checkbox"/> RMT <input type="checkbox"/> None	<input type="checkbox"/> uNA2 <input type="checkbox"/> UNA1, <input type="checkbox"/> EXT (3 or 4 digits) <input type="checkbox"/> RUT <input type="checkbox"/> None	<input type="checkbox"/> uNA2 <input type="checkbox"/> UNA1, <input type="checkbox"/> EXT (3 or 4 digits) <input type="checkbox"/> RMT <input type="checkbox"/> None	<input type="checkbox"/> uNA2 <input type="checkbox"/> UNA1, <input type="checkbox"/> EXT (3 or 4 digits) <input type="checkbox"/> RMT <input type="checkbox"/> None	CO: Ext. No
Dial Mode	<input type="checkbox"/> DTMF <input type="checkbox"/> Pulse	<input type="checkbox"/> DTMF <input type="checkbox"/> Pulse	<input type="checkbox"/> DTMF <input type="checkbox"/> Pulse	<input type="checkbox"/> DTMF <input type="checkbox"/> Pulse	<input type="checkbox"/> DTMF <input type="checkbox"/> Pulse	<input type="checkbox"/> DTMF <input type="checkbox"/> Pulse	<input type="checkbox"/> DTMF <input type="checkbox"/> Pulse	<input type="checkbox"/> DTMF <input type="checkbox"/> Pulse	DTMF
DTMF Duration Time	<input type="checkbox"/> 80 mseconds <input type="checkbox"/> 160 mseconds	<input type="checkbox"/> 80 mseconds <input type="checkbox"/> 160 mseconds	<input type="checkbox"/> 80 mseconds <input type="checkbox"/> 160 mseconds	<input type="checkbox"/> 80 mseconds <input type="checkbox"/> 160 mseconds	<input type="checkbox"/> 80 mseconds <input type="checkbox"/> 160 mseconds	<input type="checkbox"/> 80 mseconds <input type="checkbox"/> 160 mseconds	<input type="checkbox"/> 80 mseconds <input type="checkbox"/> 160 mseconds	<input type="checkbox"/> 80 mseconds <input type="checkbox"/> 160 mseconds	80
Pulse speed	<input type="checkbox"/> 10 pps <input type="checkbox"/> 20 pps	<input type="checkbox"/> Low (10 pps) <input type="checkbox"/> High (20 pps)	<input type="checkbox"/> 10 pps <input type="checkbox"/> 20 pps	<input type="checkbox"/> Low (10 pps) <input type="checkbox"/> High (20 pps)	<input type="checkbox"/> Low (10 pps) <input type="checkbox"/> High (20 pps)	<input type="checkbox"/> Low (10 pps) <input type="checkbox"/> High (20 pps)	<input type="checkbox"/> Low (10 pps) <input type="checkbox"/> High (20 pps)	<input type="checkbox"/> Low (10 pps) <input type="checkbox"/> High (20 pps)	---
% Break	<input type="checkbox"/> 60% <input type="checkbox"/> 67%	<input type="checkbox"/> 60% <input type="checkbox"/> 67%	<input type="checkbox"/> 60% <input type="checkbox"/> 67%	<input type="checkbox"/> 60% <input type="checkbox"/> 67%	<input type="checkbox"/> 60% <input type="checkbox"/> 67%	<input type="checkbox"/> 60% <input type="checkbox"/> 67%	<input type="checkbox"/> 60% <input type="checkbox"/> 67%	<input type="checkbox"/> 60% <input type="checkbox"/> 67%	---
CPC Detection	06.5 mseconds <input type="checkbox"/> 8 x ___/msec. <input type="checkbox"/> None	06.5 mseconds <input type="checkbox"/> 8 x ___/msec. <input type="checkbox"/> None	06.5 mseconds <input type="checkbox"/> 8 x ___/msec. <input type="checkbox"/> None	06.5 mseconds <input type="checkbox"/> 8 x ___/msec. <input type="checkbox"/> None	06.5 mseconds <input type="checkbox"/> 8 x ___/msec. <input type="checkbox"/> None	06.5 mseconds <input type="checkbox"/> 8 x ___/msec. <input type="checkbox"/> None	06.5 mseconds <input type="checkbox"/> 8 x ___/msec. <input type="checkbox"/> None	06.5 mseconds <input type="checkbox"/> 8 x ___/msec. <input type="checkbox"/> None	50 (400ms)
DID start Arrangement	<input type="checkbox"/> immediate Start <input type="checkbox"/> Send Delay Wink	<input type="checkbox"/> immediate Start <input type="checkbox"/> Send Delay Wink	<input type="checkbox"/> immediate Start <input type="checkbox"/> Send Delay Wink	<input type="checkbox"/> immediate Start <input type="checkbox"/> Send Delay Wink	<input type="checkbox"/> immediate Start <input type="checkbox"/> Send Delay Wink	<input type="checkbox"/> immediate Start <input type="checkbox"/> Send Delay Wink	<input type="checkbox"/> immediate Start <input type="checkbox"/> Send Delay Wink	<input type="checkbox"/> immediate Start <input type="checkbox"/> Send Delay Wink	Send Delay Wink

53

TRUNK—CO LINE

Item	Trunk Equipment Number								Default Value
Trunk Group	(2 digits: 01 to 16)	(2 digits: 01 to 16)	(2 digits: 01 to 16)	(2 digits: 01 to 16)	(2 digits: 01 to 16)	(2 digits: 01 to 16)	(2 digits: 01 to 16)	(2 digits: 01 to 16)	co: 01 DID: '6
Trunk Name	-----	-----	-----	-----	-----	-----	-----	-----	Txxxx Physical Number
Direct Termination	<input type="checkbox"/> DN (3 or 4 digits) <input type="checkbox"/> None	<input type="checkbox"/> DN (3 or 4 digits) <input type="checkbox"/> None	<input type="checkbox"/> DN (3 or 4 digits) <input type="checkbox"/> None	<input type="checkbox"/> DN (3 or 4 digits) <input type="checkbox"/> None	<input type="checkbox"/> DN (3 or 4 digits) <input type="checkbox"/> None	<input type="checkbox"/> DN (3 or 4 digits) <input type="checkbox"/> None	<input type="checkbox"/> DN (3 or 4 digits) <input type="checkbox"/> None	<input type="checkbox"/> DN (3 or 4 digits) <input type="checkbox"/> None	CO: Ext. No. with ATLC: blank
Night Answer Point (Type: No.)	<input type="checkbox"/> UNA1 <input type="checkbox"/> UNA2 <input type="checkbox"/> EXT (3 or 4 digits)	<input type="checkbox"/> UNA1 <input type="checkbox"/> UNA2 <input type="checkbox"/> EXT (3 or 4 digits)	<input type="checkbox"/> UNA1 <input type="checkbox"/> UNA2 <input type="checkbox"/> EXT (3 or 4 digits)	<input type="checkbox"/> UNA1 <input type="checkbox"/> UNA2 <input type="checkbox"/> EXT (3 or 4 digits)	<input type="checkbox"/> UNA1 <input type="checkbox"/> UNA2 <input type="checkbox"/> EXT (3 or 4 digits)	<input type="checkbox"/> UNA1 <input type="checkbox"/> UNA2 <input type="checkbox"/> EXT (3 or 4 digits)	<input type="checkbox"/> UNA1 <input type="checkbox"/> UNA2 <input type="checkbox"/> EXT (3 or 4 digits)	<input type="checkbox"/> UNA1 <input type="checkbox"/> UNA2 <input type="checkbox"/> EXT (3 or 4 digits)	CO: Ext. No.
Dial Mode	<input type="checkbox"/> DTMF <input type="checkbox"/> Pulse	<input type="checkbox"/> DTMF <input type="checkbox"/> Pulse	<input type="checkbox"/> DTMF <input type="checkbox"/> Pulse	<input type="checkbox"/> DTMF <input type="checkbox"/> Pulse	<input type="checkbox"/> DTMF <input type="checkbox"/> Pulse	<input type="checkbox"/> DTMF <input type="checkbox"/> Pulse	<input type="checkbox"/> DTMF <input type="checkbox"/> Pulse	<input type="checkbox"/> DTMF <input type="checkbox"/> Pulse	DTMF
DTMF Duration Time	<input type="checkbox"/> 80 mseconds <input type="checkbox"/> 160 mseconds	<input type="checkbox"/> 80 mseconds <input type="checkbox"/> 160 mseconds	<input type="checkbox"/> 80 mseconds <input type="checkbox"/> 160 mseconds	<input type="checkbox"/> 80 mseconds <input type="checkbox"/> 160 mseconds	<input type="checkbox"/> 80 mseconds <input type="checkbox"/> 160 mseconds	<input type="checkbox"/> 80 mseconds <input type="checkbox"/> 160 mseconds	<input type="checkbox"/> 80 mseconds <input type="checkbox"/> 160 mseconds	<input type="checkbox"/> 80 mseconds <input type="checkbox"/> 160 mseconds	80
Pulse Speed	<input type="checkbox"/> 10 pps <input type="checkbox"/> 20 pps	<input type="checkbox"/> Low (10 pps) <input type="checkbox"/> High (20 pps)	<input type="checkbox"/> Low (10 pps) <input type="checkbox"/> High (20 pps)	<input type="checkbox"/> Low (10 pps) <input type="checkbox"/> High (20 pps)	<input type="checkbox"/> 10 pps <input type="checkbox"/> 20 pps	<input type="checkbox"/> Low (10 pps) <input type="checkbox"/> High (20 pps)	<input type="checkbox"/> Low (10 pps) <input type="checkbox"/> High (20 pps)	<input type="checkbox"/> Low (10 pps) <input type="checkbox"/> High (20 pps)	---
% Break	060% 067%	060% 067%	<input type="checkbox"/> 60% <input type="checkbox"/> 67%	<input type="checkbox"/> 60% <input type="checkbox"/> 67%	<input checked="" type="checkbox"/> 60% <input type="checkbox"/> 67%	<input type="checkbox"/> 60% <input type="checkbox"/> 67%	<input type="checkbox"/> 60% <input type="checkbox"/> 67%	<input type="checkbox"/> 60% <input type="checkbox"/> 67%	---
CPC Detection	06.5 mseconds <input type="checkbox"/> 8 x ___ /msec. <input type="checkbox"/> None	<input type="checkbox"/> 6.5 mseconds <input type="checkbox"/> 8 x ___ /msec. <input type="checkbox"/> NonF	06.5 mseconds <input type="checkbox"/> 8 x ___ /msec. <input type="checkbox"/> None	06.5 mseconds <input type="checkbox"/> 8 x ___ /msec. <input type="checkbox"/> None	06.5 mseconds <input type="checkbox"/> 8 x ___ /msec. <input type="checkbox"/> None	06.5 mseconds <input type="checkbox"/> 8 x ___ /msec. <input type="checkbox"/> None	06.5 mseconds <input type="checkbox"/> 8 x ___ /msec. <input type="checkbox"/> None	06.5 mseconds <input type="checkbox"/> 8 x ___ /msec. <input type="checkbox"/> None	50 (400ms)
DID start Arrangement	<input type="checkbox"/> Immediate Start <input type="checkbox"/> Send Delay Wink	<input type="checkbox"/> Immediate Start <input type="checkbox"/> Send Delay Wink	<input type="checkbox"/> Immediate Start <input type="checkbox"/> Send Delay Wink	<input type="checkbox"/> Immediate Start <input type="checkbox"/> Send Delay Wink	<input type="checkbox"/> Immediate Start <input type="checkbox"/> Send Delay Wink	<input type="checkbox"/> Immediate Start <input type="checkbox"/> Send Delay Wink	<input type="checkbox"/> Immediate Start <input type="checkbox"/> Send Delay Wink	<input type="checkbox"/> Immediate Start <input type="checkbox"/> Send Delay Wink	Send Delay Wink

TRUNK—CO LINE

Item	Trunk Equipment Number								Default Value
Trunk Group	(2 digits: 01 to 16)	(2 digits: 01 to 16)	(2 digits: 01 to 16)	(2 digits: 01 to 16)	(2 digits: 01 to 16)	(2 digits: 01 to 16)	(2 digits: 01 to 16)	(2 digits: 01 to 16)	CO: 01 DID: 16
Trunk Name	-----	-----	-----	-----	-----	-----	-----	-----	Txxxx ----- Physical Number
Direct Termination	<input type="checkbox"/> DrJ (3 or 4 digits) <input type="checkbox"/> None	<input type="checkbox"/> DN (3 or 4 digits) <input type="checkbox"/> None	<input type="checkbox"/> DN (3 or 4 digits) <input type="checkbox"/> None	<input type="checkbox"/> DN (3 or 4 digits) <input type="checkbox"/> None	<input type="checkbox"/> DN (3 or 4 digits) <input type="checkbox"/> None	<input type="checkbox"/> DN (3 or 4 digits) <input type="checkbox"/> None	<input type="checkbox"/> IDN (3 or 4 digits) <input type="checkbox"/> None	<input type="checkbox"/> IDN (3 or 4 digits) <input type="checkbox"/> None	CO: Ext. No with ATLC: blank
Night Answer Point (Type: No.)	<input type="checkbox"/> UNA1, <input type="checkbox"/> UNA2 <input type="checkbox"/> EXT (3 or 4 digits) <input type="checkbox"/> RMT <input type="checkbox"/> None	<input type="checkbox"/> UNA1, <input type="checkbox"/> UNA2 <input type="checkbox"/> EXT (3 or 4 digits) <input type="checkbox"/> RMT <input type="checkbox"/> None	<input type="checkbox"/> UNA1, <input type="checkbox"/> UNM <input type="checkbox"/> EXT (3 or 4 digits) <input type="checkbox"/> RMT <input type="checkbox"/> None	<input type="checkbox"/> IUNA1, <input type="checkbox"/> IUNA2 <input type="checkbox"/> EXT (3 or 4 digits) <input type="checkbox"/> RMT <input type="checkbox"/> None	<input type="checkbox"/> IUNA1, <input type="checkbox"/> IUNA2 <input type="checkbox"/> EXT (3 or 4 digits) <input type="checkbox"/> RMT <input type="checkbox"/> None	<input type="checkbox"/> IUNA1, <input type="checkbox"/> IUNA2 <input type="checkbox"/> EXT (3 or 4 digits) <input type="checkbox"/> RMT <input type="checkbox"/> None	<input type="checkbox"/> UNA1, <input type="checkbox"/> UNA2 <input type="checkbox"/> EXT (3 or 4 digits) <input type="checkbox"/> RMT <input type="checkbox"/> None	<input type="checkbox"/> UNA1, <input type="checkbox"/> UNA2 <input type="checkbox"/> UT (3 or 4 digits) <input type="checkbox"/> RMT <input type="checkbox"/> None	CO: Ext. No
Dial Mode	<input type="checkbox"/> DTMF <input type="checkbox"/> Pulse	<input type="checkbox"/> DTMF <input type="checkbox"/> Pulse	<input type="checkbox"/> DTMF <input type="checkbox"/> IPulse	<input type="checkbox"/> DTMF <input type="checkbox"/> Pulse	<input type="checkbox"/> DTMF <input type="checkbox"/> IPulse	<input type="checkbox"/> DTMF <input type="checkbox"/> Pulse	<input type="checkbox"/> DTMF <input type="checkbox"/> Pulse	<input type="checkbox"/> DTMF <input type="checkbox"/> Pulse	DTMF
DTMF Duration Time	<input type="checkbox"/> 80 mseconds <input type="checkbox"/> 160 mseconds	<input type="checkbox"/> 80 mseconds <input type="checkbox"/> 160 mseconds	<input type="checkbox"/> 80 mseconds <input type="checkbox"/> 160 mseconds	<input type="checkbox"/> 80 mseconds <input type="checkbox"/> 160 mseconds	<input type="checkbox"/> 80 mseconds <input type="checkbox"/> 160 mseconds	<input type="checkbox"/> 80 mseconds <input type="checkbox"/> 160 mseconds	<input type="checkbox"/> 80 mseconds <input type="checkbox"/> 160 mseconds	<input type="checkbox"/> 80 mseconds <input type="checkbox"/> 160 mseconds	80
Pulse Speed	<input type="checkbox"/> 10 pps <input type="checkbox"/> 20 pps	<input type="checkbox"/> LOW (10 pps) <input type="checkbox"/> High (20 pps)	<input type="checkbox"/> 10 pps <input type="checkbox"/> High (20 pps)	<input type="checkbox"/> LOW (10 pps) <input type="checkbox"/> High (20 pps)	<input type="checkbox"/> LOW (10 pps) <input type="checkbox"/> High (20 pps)	<input type="checkbox"/> LOW (10 pps) <input type="checkbox"/> High (20 pps)	<input type="checkbox"/> LOW (10 pps) <input type="checkbox"/> High (20 pps)	<input type="checkbox"/> Low (10 pps) <input type="checkbox"/> High (20 pps)	—
% Break	060% 067%	<input type="checkbox"/> 60% <input type="checkbox"/> 67%	060% 067%	060% <input type="checkbox"/> 67%	<input type="checkbox"/> 60% <input type="checkbox"/> 67%	060% <input type="checkbox"/> 67%	060% <input type="checkbox"/> 67%	060% <input type="checkbox"/> 67%	—
CPC Detection	06.5 mseconds 08 x ___ /msec. <input type="checkbox"/> None	<input type="checkbox"/> 6.5 mseconds 08 x ___ /msec. <input type="checkbox"/> None	06.5 mseconds 08 x ___ /msec. <input type="checkbox"/> None	<input type="checkbox"/> 6.5 mseconds 08 x ___ /msec. <input type="checkbox"/> None	<input type="checkbox"/> 6.5 mseconds 08 x ___ /msec. <input type="checkbox"/> None	<input type="checkbox"/> 6.5 mseconds 08 x ___ /msec. <input type="checkbox"/> None	06.5 mseconds 08 x ___ /msec. <input type="checkbox"/> None	<input type="checkbox"/> 6.5 mseconds 08 x ___ /msec. <input type="checkbox"/> None	50 (400ms)
DID start Arrangement	<input type="checkbox"/> Immediate Start <input type="checkbox"/> Send Delay Wink	<input type="checkbox"/> immediate Start <input type="checkbox"/> Send Delay Wink	<input type="checkbox"/> immediate Start <input type="checkbox"/> Send Delay Wink	<input type="checkbox"/> Immediate Start <input type="checkbox"/> Send Delay Wink	<input type="checkbox"/> Immediate Start <input type="checkbox"/> Send Delay Wink	<input type="checkbox"/> Immediate Start <input type="checkbox"/> Send Delay Wink	<input type="checkbox"/> immediate Start <input type="checkbox"/> Send Delay Wink	<input type="checkbox"/> Immediate Start <input type="checkbox"/> Send Delay Wink	Send Delay Wink

TRUNK—CO LINE

Item	Trunk Equipment Number								Default Value
Trunk Group	(2 digits: 01 to 16)	(2 digits: 01 to 16)	(2 digits: 01 to 16)	(2 digits: 01 to 16)	(2 digits: 01 to 16)	(2 digits: 01 to 16)	(2 digits: 01 to 16)	(2 digits: 01 to 16)	co: 01 DID: 16
Trunk Name									Txxxx Physical Number
Direct Termination	<input type="checkbox"/> DN (3 or 4 digits) <input type="checkbox"/> None	<input type="checkbox"/> DN (3 or 4 digits) <input type="checkbox"/> None	<input type="checkbox"/> DN (3 or 4 digits) <input type="checkbox"/> None	<input type="checkbox"/> DN (3 or 4 digits) <input type="checkbox"/> None	<input type="checkbox"/> DN (3 or 4 digits) <input type="checkbox"/> None	<input type="checkbox"/> DN (3 or 4 digits) <input type="checkbox"/> None	<input type="checkbox"/> DN (3 or 4 digits) <input type="checkbox"/> None	<input type="checkbox"/> DN (3 or 4 digits) <input type="checkbox"/> None	CO: Ext. No. with ATLC: blank
Night Answer Point (Type: No.)	<input type="checkbox"/> UNA1, <input type="checkbox"/> UNA2 <input type="checkbox"/> EXT (3 or 4 digits) <input type="checkbox"/> RMT <input type="checkbox"/> None	<input type="checkbox"/> UNA1, <input type="checkbox"/> UNA2 <input type="checkbox"/> EXT (3 or 4 digits) <input type="checkbox"/> RMT <input type="checkbox"/> None	<input type="checkbox"/> UNA1, <input type="checkbox"/> UNA2 <input type="checkbox"/> EXT (3 or 4 digits) <input type="checkbox"/> RMT <input type="checkbox"/> None	<input type="checkbox"/> UNA1, <input type="checkbox"/> UNA2 <input type="checkbox"/> EXT (3 or 4 digits) <input type="checkbox"/> RMT <input type="checkbox"/> None	<input type="checkbox"/> UNA1, <input type="checkbox"/> UNA2 <input type="checkbox"/> EXT (3 or 4 digits) <input type="checkbox"/> RMT <input type="checkbox"/> None	<input type="checkbox"/> UNA1, <input type="checkbox"/> UNA2 <input type="checkbox"/> EXT (3 or 4 digits) <input type="checkbox"/> RMT <input type="checkbox"/> None	<input type="checkbox"/> UNA1, <input type="checkbox"/> UNA2 <input type="checkbox"/> EXT (3 or 4 digits) <input type="checkbox"/> RMT <input type="checkbox"/> None	<input type="checkbox"/> UNA1, <input type="checkbox"/> UNA2 <input type="checkbox"/> EXT (3 or 4 digits) <input type="checkbox"/> RMT <input type="checkbox"/> None	CO: Ext. No.
Dial Mode	<input type="checkbox"/> DTMF <input type="checkbox"/> Pulse	<input type="checkbox"/> DTMF <input type="checkbox"/> Pulse	<input type="checkbox"/> DTMF <input type="checkbox"/> Pulse	<input type="checkbox"/> DTMF <input type="checkbox"/> Pulse	<input type="checkbox"/> DTMF <input type="checkbox"/> Pulse	<input type="checkbox"/> DTMF <input type="checkbox"/> Pulse	<input type="checkbox"/> DTMF <input type="checkbox"/> Pulse	<input type="checkbox"/> DTMF <input type="checkbox"/> Pulse	DTMF
DTMF Duration Time	<input type="checkbox"/> 80 mseconds <input type="checkbox"/> 160 mseconds	<input type="checkbox"/> 80 mseconds <input type="checkbox"/> 160 mseconds	<input type="checkbox"/> 80 mseconds <input type="checkbox"/> 160 mseconds	<input type="checkbox"/> 80 mseconds <input type="checkbox"/> 160 mseconds	<input type="checkbox"/> 80 mseconds <input type="checkbox"/> 160 mseconds	<input type="checkbox"/> 80 mseconds <input type="checkbox"/> 160 mseconds	<input type="checkbox"/> 80 mseconds <input type="checkbox"/> 160 mseconds	<input type="checkbox"/> 80 mseconds <input type="checkbox"/> 160 mseconds	80
Pulse Speed	<input type="checkbox"/> Low (10 pps) <input type="checkbox"/> High (20 pps)	<input type="checkbox"/> Low (10 pps) <input type="checkbox"/> High (20 pps)	<input type="checkbox"/> Low (10 pps) <input type="checkbox"/> High (20 pps)	<input type="checkbox"/> Low (10 pps) <input type="checkbox"/> High (20 pps)	<input type="checkbox"/> Low (10 pps) <input type="checkbox"/> High (20 pps)	<input type="checkbox"/> Low (10 pps) <input type="checkbox"/> High (20 pps)	<input type="checkbox"/> Low (10 pps) <input type="checkbox"/> High (20 pps)	<input type="checkbox"/> Low (10 pps) <input type="checkbox"/> High (20 pps)	—
% Break	<input type="checkbox"/> 60% <input type="checkbox"/> 67%	<input type="checkbox"/> 60% <input type="checkbox"/> 67%	<input type="checkbox"/> 60% <input type="checkbox"/> 67%	<input type="checkbox"/> 60% <input type="checkbox"/> 67%	<input type="checkbox"/> 60% <input type="checkbox"/> 67%	060% <input type="checkbox"/> 67%	060% 067%	060% 067%	—
CPC Detection	<input type="checkbox"/> 6.5 mseconds <input type="checkbox"/> 8 x ___/msec. <input type="checkbox"/> None	<input type="checkbox"/> 6.5 mseconds <input type="checkbox"/> 8 x ___/msec. <input type="checkbox"/> None	<input type="checkbox"/> 6.5 mseconds <input type="checkbox"/> 8 x ___/msec. <input type="checkbox"/> None	<input type="checkbox"/> 6.5 mseconds <input type="checkbox"/> 8 x ___/msec. <input type="checkbox"/> None	<input type="checkbox"/> 6.5 mseconds <input type="checkbox"/> 8 x ___/msec. <input type="checkbox"/> None	<input type="checkbox"/> 6.5 mseconds <input type="checkbox"/> 8 x ___/msec. <input type="checkbox"/> None	06.5 mseconds <input type="checkbox"/> 8 x ___/msec. <input type="checkbox"/> None	<input type="checkbox"/> 6.5 mseconds <input type="checkbox"/> 8 x ___/msec. <input type="checkbox"/> None	50 (400ms)
DID start Arrangement	<input type="checkbox"/> Immediate Start <input type="checkbox"/> Send Delay Wink	<input type="checkbox"/> Immediate Start <input type="checkbox"/> &d Delay Wink	<input type="checkbox"/> Immediate Start <input type="checkbox"/> %td Delay Wink	<input type="checkbox"/> Immediate Start <input type="checkbox"/> Send Delay Wink	<input type="checkbox"/> Immediate Start <input type="checkbox"/> Send Delay Wink	<input type="checkbox"/> Immediate Start <input type="checkbox"/> Send Delay Wink	<input type="checkbox"/> Immediate Start <input type="checkbox"/> Send Delay Wink	<input type="checkbox"/> Immediate Start <input type="checkbox"/> &d Delay Wink	Send Delay Wink

TRUNK420 LINE

Item	Trunk Equipment Number'								Default Value
	,								
Trunk Group	(2 digits: 01 to 16)	(2 digits: 01 to 16)	(2 digits: 01 to 16)	(2 digits: 01 to 16)	(2 digits: 01 to 16)	(2 digits: 01 to 16)	(2 digits: 01 to 16)	(2 digits: 01 to 16)	co: 01 DID: 16
Trunk Name	-----	-----	-----	-----	-----	-----	-----	-----	Txxxx Physical Number
Direct Termination	<input type="checkbox"/> DN (3 or 4 digits) <input type="checkbox"/> None	<input type="checkbox"/> DN (3 or 4 digits) <input type="checkbox"/> None	<input type="checkbox"/> DN (3 or 4 digits) <input type="checkbox"/> None	<input type="checkbox"/> DN (3 or 4 digits) <input type="checkbox"/> None	<input type="checkbox"/> DN (3 or 4 digits) <input type="checkbox"/> None	<input type="checkbox"/> DN (3 or 4 digits) <input type="checkbox"/> None	<input type="checkbox"/> DN (3 or 4 digits) <input type="checkbox"/> None	<input type="checkbox"/> DN (3 or 4 digits) <input type="checkbox"/> None	CO: Ext. No. with ATLC: blank
Night Answer Point (Type: No.)	<input type="checkbox"/> IEXT (3 or 4 digits) <input type="checkbox"/> RMT <input type="checkbox"/> None	<input type="checkbox"/> UNA1, <input type="checkbox"/> UNA2 <input type="checkbox"/> EXT (3 or 4 digits) <input type="checkbox"/> RMT <input type="checkbox"/> None	<input type="checkbox"/> UNA1, <input type="checkbox"/> UNA2 <input type="checkbox"/> EXT (3 or 4 digits) <input type="checkbox"/> RMT <input type="checkbox"/> None	<input type="checkbox"/> UNA1, <input type="checkbox"/> UNA2 <input type="checkbox"/> EXT (3 or 4 digits) <input type="checkbox"/> RMT <input type="checkbox"/> None	<input type="checkbox"/> uNA1, <input type="checkbox"/> uNA2 <input type="checkbox"/> EXT (3 or 4 digits) <input type="checkbox"/> RMT <input type="checkbox"/> None	<input type="checkbox"/> UNA1, <input type="checkbox"/> UNA2 <input type="checkbox"/> EXT (3 or 4 digits) <input type="checkbox"/> RMT <input type="checkbox"/> None	<input type="checkbox"/> UNA1, <input type="checkbox"/> UNA2 <input type="checkbox"/> EXT (3 or 4 digits) <input type="checkbox"/> RMT <input type="checkbox"/> None	<input type="checkbox"/> uNA1, <input type="checkbox"/> uNA2 <input type="checkbox"/> EXT (3 or 4 digits) <input type="checkbox"/> RMT <input type="checkbox"/> None	CO: Ext. No.
Dial Mode	<input type="checkbox"/> DTMF <input type="checkbox"/> Pulse	<input type="checkbox"/> DTMF <input type="checkbox"/> Pulse	<input type="checkbox"/> DTMF <input type="checkbox"/> Pulse	<input type="checkbox"/> DTMF <input type="checkbox"/> Pulse	<input type="checkbox"/> DTMF <input type="checkbox"/> Pulse	<input type="checkbox"/> DTMF <input type="checkbox"/> Pulse	<input type="checkbox"/> DTMF <input type="checkbox"/> Pulse	<input type="checkbox"/> DTMF <input type="checkbox"/> Pulse	DTMF
DTMF Duration Time	<input type="checkbox"/> 80 mseconds <input type="checkbox"/> 160 mseconds	<input type="checkbox"/> 80 mseconds <input type="checkbox"/> 160 mseconds	<input type="checkbox"/> 80 mseconds <input type="checkbox"/> 160 mseconds	<input type="checkbox"/> 80 mseconds <input type="checkbox"/> 160 mseconds	<input type="checkbox"/> 80 mseconds <input type="checkbox"/> 160 mseconds	<input type="checkbox"/> 80 mseconds <input type="checkbox"/> 160 mseconds	<input type="checkbox"/> 80 mseconds <input type="checkbox"/> 160 mseconds	<input type="checkbox"/> 80 mseconds <input type="checkbox"/> 160 mseconds	80
Pulse Speed	<input type="checkbox"/> Low (10 pps) <input type="checkbox"/> High (20 pps)	<input type="checkbox"/> Low (10 pps) <input type="checkbox"/> High (20 pps)	<input type="checkbox"/> Low (10 pps) <input type="checkbox"/> High (20 pps)	<input type="checkbox"/> Low (10 pps) <input type="checkbox"/> High (20 pps)	<input type="checkbox"/> Low (10 pps) <input type="checkbox"/> High (20 pps)	<input type="checkbox"/> Low (10 pps) <input type="checkbox"/> High (20 pps)	<input type="checkbox"/> Low (10 pps) <input type="checkbox"/> High (20 pps)	<input type="checkbox"/> Low (10 pps) <input type="checkbox"/> High (20 pps)	---
% Break	<input type="checkbox"/> 60% <input type="checkbox"/> 67%	<input type="checkbox"/> 60% <input type="checkbox"/> 67%	<input type="checkbox"/> 60% <input type="checkbox"/> 67%	<input type="checkbox"/> 60% <input type="checkbox"/> 67%	060% 067%	<input type="checkbox"/> 60% <input type="checkbox"/> 67%	060% 067%	<input type="checkbox"/> 60% <input type="checkbox"/> 67%	---
CPC Detection	<input type="checkbox"/> 6.5 mseconds <input type="checkbox"/> 8 x ___/msec. <input type="checkbox"/> None	<input type="checkbox"/> 6.5 mseconds <input type="checkbox"/> 8 x ___/msec. <input type="checkbox"/> None	<input type="checkbox"/> 6.5 mseconds <input type="checkbox"/> 8 x ___/msec. <input type="checkbox"/> None	<input type="checkbox"/> 6.5 mseconds <input type="checkbox"/> 8 x ___/msec. <input type="checkbox"/> None	<input type="checkbox"/> 6.5 mseconds <input type="checkbox"/> 8 x ___/msec. <input type="checkbox"/> None	<input type="checkbox"/> 6.5 mseconds <input type="checkbox"/> 8 x ___/msec. <input type="checkbox"/> None	<input type="checkbox"/> 6.5 mseconds <input type="checkbox"/> 8 x ___/msec. <input type="checkbox"/> None	<input type="checkbox"/> 6.5 mseconds <input type="checkbox"/> 8 x ___/msec. <input type="checkbox"/> None	50 (400ms)
DID start Arrangement	<input type="checkbox"/> Immediate Start <input type="checkbox"/> Send Delay Wink	<input type="checkbox"/> Immediate Start <input type="checkbox"/> Send Delay Wink	<input type="checkbox"/> Immediate Start <input type="checkbox"/> Send Delay Wink	<input type="checkbox"/> Immediate Start <input type="checkbox"/> Send Delay Wink	<input type="checkbox"/> Immediate Start <input type="checkbox"/> Send Delay Wink	<input type="checkbox"/> Immediate Start <input type="checkbox"/> Send Delay Wink	<input type="checkbox"/> Immediate Start <input type="checkbox"/> Send Delay Wink	<input type="checkbox"/> Immediate Start <input type="checkbox"/> Send Delay Wink	Send Delay Wink

TRUNK—CO LINE

Item	Trunk Equipment Number								Default Value
Trunk Group	(2 digits: 01 to 16)	(2 digits: 01 to 16)	(2 digits: 01 to 16)	(2 digits: 01 to 16)	(2 digits: 01 to 16)	(2 digits: 01 to 16)	(2 digits: 01 to 16)	(2 digits: 01 to 16)	co: 01 DID: 16
Trunk Name									Txxxx Physical Number
Direct Termination	<input type="checkbox"/> DN (3 or 4 digits) <input type="checkbox"/> None	<input type="checkbox"/> DN (3 or 4 digits) <input type="checkbox"/> None	<input type="checkbox"/> DN (3 or 4 digits) <input type="checkbox"/> None	<input type="checkbox"/> DN (3 or 4 digits) <input type="checkbox"/> None	<input type="checkbox"/> DN (3 or 4 digits) <input type="checkbox"/> None	<input type="checkbox"/> DN (3 or 4 digits) <input type="checkbox"/> None	<input type="checkbox"/> DN (3 or 4 digits) <input type="checkbox"/> None	<input type="checkbox"/> DN (3 or 4 digits) <input type="checkbox"/> None	CO: Ext. No with ATLC: blank
Night Answer Point (Type: No.)	<input type="checkbox"/> UNAI <input type="checkbox"/> uNA2 <input type="checkbox"/> EXT (3 or 4 digits) <input type="checkbox"/> RMT <input type="checkbox"/> None	<input type="checkbox"/> UNAI <input type="checkbox"/> lwtw <input type="checkbox"/> EXT (3 or 4 digits) <input type="checkbox"/> RMT <input type="checkbox"/> None	<input type="checkbox"/> UNAI <input type="checkbox"/> uNA2 <input type="checkbox"/> EXT (3 or 4 digits) <input type="checkbox"/> RMT <input type="checkbox"/> None	<input type="checkbox"/> UNAI <input type="checkbox"/> uNA2 <input type="checkbox"/> EXT (3 or 4 digits) <input type="checkbox"/> RMT <input type="checkbox"/> None	<input type="checkbox"/> uNAi <input type="checkbox"/> UNAI <input type="checkbox"/> EXT (3 or 4 digits) <input type="checkbox"/> RMT <input type="checkbox"/> None	<input type="checkbox"/> UNAI <input type="checkbox"/> UNAI <input type="checkbox"/> EXT (3 or 4 digits) <input type="checkbox"/> RMT <input type="checkbox"/> None	<input type="checkbox"/> UNAI <input type="checkbox"/> UNAI <input type="checkbox"/> EXT (3 or 4 digits) <input type="checkbox"/> RMT <input type="checkbox"/> None	<input type="checkbox"/> UNAI <input type="checkbox"/> UNAI <input type="checkbox"/> EXT (3 or 4 digits) <input type="checkbox"/> RMT <input type="checkbox"/> None	CO Ext No
Dial Mode	<input type="checkbox"/> DTMF <input type="checkbox"/> Pulse	<input type="checkbox"/> Pulse	<input type="checkbox"/> DTMF <input type="checkbox"/> Pulse	<input type="checkbox"/> DTMF <input type="checkbox"/> Pulse	<input type="checkbox"/> Pulse	<input type="checkbox"/> DTMF <input type="checkbox"/> Pulse	<input type="checkbox"/> DTMF <input type="checkbox"/> Pulse	<input type="checkbox"/> DTMF <input type="checkbox"/> Pulse	DTMF
DTMF Duration Time	<input type="checkbox"/> 80 mseconds <input type="checkbox"/> 160 mseconds	<input type="checkbox"/> 80 mseconds <input type="checkbox"/> 160 mseconds	<input type="checkbox"/> 80 mseconds <input type="checkbox"/> 160 mseconds	<input type="checkbox"/> 80 mseconds <input type="checkbox"/> 160 mseconds	<input type="checkbox"/> 80 mseconds <input type="checkbox"/> 160 mseconds	<input type="checkbox"/> 80 mseconds <input type="checkbox"/> 160 mseconds	<input type="checkbox"/> 80 mseconds <input type="checkbox"/> 160 mseconds	<input type="checkbox"/> 80 mseconds <input type="checkbox"/> 160 mseconds	80
Pulse Speed	<input type="checkbox"/> Low (10 pps) <input type="checkbox"/> High (20 pps)	<input type="checkbox"/> Low (10 pps) <input type="checkbox"/> High (20 pps)	<input type="checkbox"/> Low (10 pps) <input type="checkbox"/> High (20 pps)	<input type="checkbox"/> Low (10 pps) <input type="checkbox"/> High (20 pps)	<input type="checkbox"/> Low (10 pps) <input type="checkbox"/> High (20 pps)	<input type="checkbox"/> Low (10 pps) <input type="checkbox"/> High (20 pps)	<input type="checkbox"/> Low (10 pps) <input type="checkbox"/> High (20 pps)	<input type="checkbox"/> Low (10 pps) <input type="checkbox"/> High (20 pps)	---
% Break	<input type="checkbox"/> 60% <input type="checkbox"/> 67%	<input type="checkbox"/> 60% <input type="checkbox"/> 67%	<input type="checkbox"/> 60% <input type="checkbox"/> 67%	<input type="checkbox"/> 60% <input type="checkbox"/> 67%	<input type="checkbox"/> 60% <input type="checkbox"/> 67%	<input type="checkbox"/> 60% <input type="checkbox"/> 67%	<input type="checkbox"/> 60% <input type="checkbox"/> 67%	<input type="checkbox"/> 60% <input type="checkbox"/> 67%	---
CPC Detection	06.5 mseconds <input type="checkbox"/> 8 x ___ /msec. <input type="checkbox"/> None	06.5 mseconds <input type="checkbox"/> 8 x ___ /msec. <input type="checkbox"/> None	06.5 mseconds <input type="checkbox"/> 8 x ___ /msec. <input type="checkbox"/> None	06.5 mseconds <input type="checkbox"/> 8 x ___ /msec. <input type="checkbox"/> None	06.5 mseconds <input type="checkbox"/> 8 x ___ /msec. <input type="checkbox"/> None	06.5 mseconds <input type="checkbox"/> 8 x ___ /msec. <input type="checkbox"/> None	06.5 mseconds <input type="checkbox"/> 8 x ___ /msec. <input type="checkbox"/> None	06.5 mseconds <input type="checkbox"/> 8 x ___ /msec. <input type="checkbox"/> None	50 (400ms)
DID start Arrangement	<input type="checkbox"/> immediate Start <input type="checkbox"/> Send Delay Wink	<input type="checkbox"/> immediate Start <input type="checkbox"/> Send Delay Wink	<input type="checkbox"/> Immediate Start <input type="checkbox"/> Send Delay Wink	<input type="checkbox"/> Immediate Start <input type="checkbox"/> Send Delay Wink	<input type="checkbox"/> immediate Start <input type="checkbox"/> Send Delay Wink	<input type="checkbox"/> Immediate Start <input type="checkbox"/> Send Delay Wink	<input type="checkbox"/> Immediate Start <input type="checkbox"/> Send Delay Wink	<input type="checkbox"/> immediate Start <input type="checkbox"/> Send Delay Wink	Send Delay Wink

TRUNK-CO LINE

Item	Trunk Equipment Number								Default Value
Trunk Group	(2 digits: 01 to 16)	(2 digits: 01 to 16)	(2 digits: 01 to 16)	(2 digits: 01 to 16)	(2 digits: 01 to 16)	(2 digits: 01 to 16)	(2 digits: 01 to 16)	(2 digits: 01 to 16)	CO: 01 DID: 16
Trunk Name	-----	-----	-----	-----	-----	-----	-----	-----	1 xxxx Physical Number
Direct Termination	<input type="checkbox"/> DN (3 or 4 digits) <input type="checkbox"/> None	<input type="checkbox"/> DN (3 or 4 digits) <input type="checkbox"/> None	<input type="checkbox"/> DN (3 or 4 digits) <input type="checkbox"/> None	<input type="checkbox"/> DN (3 or 4 digits) <input type="checkbox"/> None	<input type="checkbox"/> DN (3 or 4 digits) <input type="checkbox"/> None	<input type="checkbox"/> DN (3 or 4 digits) <input type="checkbox"/> None	<input type="checkbox"/> DN (3 or 4 digits) <input type="checkbox"/> None	<input type="checkbox"/> DN (3 or 4 digits) <input type="checkbox"/> None	CO: Ext. No. with ATLC. blank
Night Answer Point (Type: No.)	<input type="checkbox"/> UNA1, <input type="checkbox"/> UNA2 <input type="checkbox"/> EXT (3 or 4 digits) ORMT <input type="checkbox"/> None	<input type="checkbox"/> UNA1, <input type="checkbox"/> UNA2 <input type="checkbox"/> EXT (3 or 4 digits) <input type="checkbox"/> RMT <input type="checkbox"/> None	<input type="checkbox"/> UNA1, <input type="checkbox"/> UNA2 <input type="checkbox"/> EXT (3 or 4 digits) <input type="checkbox"/> RMT <input type="checkbox"/> None	<input type="checkbox"/> UNA1, <input type="checkbox"/> UNA2 <input type="checkbox"/> EXT (3 or 4 digits) <input type="checkbox"/> RMT <input type="checkbox"/> None	<input type="checkbox"/> UNA1, <input type="checkbox"/> UNA2 <input type="checkbox"/> EXT (3 or 4 digits) <input type="checkbox"/> RMT <input type="checkbox"/> None	<input type="checkbox"/> UNA1, <input type="checkbox"/> UNA2 <input type="checkbox"/> EXT (3 or 4 digits) <input type="checkbox"/> RMT <input type="checkbox"/> None	<input type="checkbox"/> UNA1, <input type="checkbox"/> UNA2 <input type="checkbox"/> EXT (3 or 4 digits) <input type="checkbox"/> RMT <input type="checkbox"/> None	<input type="checkbox"/> UNA1, <input type="checkbox"/> UNA2 <input type="checkbox"/> EXT (3 or 4 digits) <input type="checkbox"/> RMT <input type="checkbox"/> None	CO: Ext. No.
Dial Mode	<input type="checkbox"/> DTMF <input type="checkbox"/> Pulse	<input type="checkbox"/> DTMF <input type="checkbox"/> Pulse	<input type="checkbox"/> DTMF <input type="checkbox"/> Pulse	<input type="checkbox"/> DTMF <input type="checkbox"/> Pulse	<input type="checkbox"/> DTMF <input type="checkbox"/> Pulse	<input type="checkbox"/> DTMF <input type="checkbox"/> Pulse	<input type="checkbox"/> DTMF <input type="checkbox"/> Pulse	<input type="checkbox"/> DTMF <input type="checkbox"/> Pulse	DTMF
DTMF Duration Time	<input type="checkbox"/> 80 mseconds <input type="checkbox"/> 160 mseconds	<input type="checkbox"/> 80 mseconds <input type="checkbox"/> 160 mseconds	<input type="checkbox"/> 80 mseconds <input type="checkbox"/> 164 mseconds	<input type="checkbox"/> 80 mseconds <input type="checkbox"/> 160 mseconds	<input type="checkbox"/> 80 mseconds <input type="checkbox"/> 160 mseconds	<input type="checkbox"/> 80 mseconds <input type="checkbox"/> 160 mseconds	<input type="checkbox"/> 80 mseconds <input type="checkbox"/> 160 mseconds	<input type="checkbox"/> 80 mseconds <input type="checkbox"/> 160 mseconds	80
Pulse Speed	<input type="checkbox"/> Low (10 pps) <input type="checkbox"/> High (20 pps)	<input type="checkbox"/> Low (10 pps) <input type="checkbox"/> High (20 pps)	<input type="checkbox"/> Low (10 pps) <input type="checkbox"/> High (20 pps)	<input type="checkbox"/> Low (10 pps) <input type="checkbox"/> High (20 pps)	<input type="checkbox"/> Low (10 pps) <input type="checkbox"/> High (20 pps)	<input type="checkbox"/> Low (10 pps) <input type="checkbox"/> High (20 pps)	<input type="checkbox"/> Low (10 pps) <input type="checkbox"/> High (20 pps)	<input type="checkbox"/> Low (10 pps) <input type="checkbox"/> High (20 pps)	---
% Break	<input type="checkbox"/> 60% <input type="checkbox"/> 67%	<input type="checkbox"/> 60% <input type="checkbox"/> 67%	<input type="checkbox"/> 60% <input type="checkbox"/> 67%	<input type="checkbox"/> 60% <input type="checkbox"/> 67%	<input type="checkbox"/> 60% <input type="checkbox"/> 67%	<input type="checkbox"/> 60% <input type="checkbox"/> 67%	<input type="checkbox"/> 60% <input type="checkbox"/> 67%	<input type="checkbox"/> 60% <input type="checkbox"/> 67%	---
CPC Detection	<input type="checkbox"/> 6.5 mseconds <input type="checkbox"/> 8 x ___ /msec. <input type="checkbox"/> None	<input type="checkbox"/> 6.5 mseconds <input type="checkbox"/> 8 x ___ /msec. <input type="checkbox"/> None	<input type="checkbox"/> 6.5 mseconds <input type="checkbox"/> 8 x ___ /msec. <input type="checkbox"/> None	<input type="checkbox"/> 6.5 mseconds <input type="checkbox"/> 8 x ___ /msec. <input type="checkbox"/> None	<input type="checkbox"/> 6.5 mseconds <input type="checkbox"/> 8 x ___ /msec. <input type="checkbox"/> None	<input type="checkbox"/> 6.5 mseconds <input type="checkbox"/> 8 x ___ /msec. <input type="checkbox"/> None	<input type="checkbox"/> 6.5 mseconds <input type="checkbox"/> 8 x ___ /msec. <input type="checkbox"/> None	<input type="checkbox"/> 6.5 mseconds <input type="checkbox"/> 8 x ___ /msec. <input type="checkbox"/> None	50 (400ms)
DID start Arrangement	<input type="checkbox"/> immediate Start <input type="checkbox"/> Send Delay Wink	<input type="checkbox"/> Immediate Start <input type="checkbox"/> Send Delay Wink	<input type="checkbox"/> Immediate Start <input type="checkbox"/> Send Delay Wink	<input type="checkbox"/> immediate Start <input type="checkbox"/> Send Delay Wink	<input type="checkbox"/> immediate Start <input type="checkbox"/> Send Delay Wink	<input type="checkbox"/> Immediate Start <input type="checkbox"/> Send Delay Wink	<input type="checkbox"/> Immediate Start <input type="checkbox"/> Send Delay Wink	<input type="checkbox"/> Immediate Start <input type="checkbox"/> Send Delay Wink	Send Delay Wink

TRUNK—CO LINE

item	Trunk Equipment Number								Default Value
Trunk Group	(2 digits: 01 to 16)	(2 digits: 01 to 16)	(2 digits: 01 to 16)	(2 digits: 01 to 16)	(2 digits: 01 to 16)	(2 digits: 01 to 16)	(2 digits: 01 to 16)	(2 digits: 01 to 16)	CO: 01 DID: 16
Trunk Name	-----								Txxxx Physical Number
Direct Termination	<input type="checkbox"/> DN (3 or 4 digits) <input type="checkbox"/> None	<input type="checkbox"/> DN (3 or 4 digits) <input type="checkbox"/> None	<input type="checkbox"/> DN (3 or 4 digits) <input type="checkbox"/> None	<input type="checkbox"/> DN (3 or 4 digits) <input type="checkbox"/> None	<input type="checkbox"/> DN (3 or 4 digits) <input type="checkbox"/> None	<input type="checkbox"/> DN (3 or 4 digits) <input type="checkbox"/> None	<input type="checkbox"/> DN (3 or 4 digits) <input type="checkbox"/> None	<input type="checkbox"/> DN (3 or 4 digits) <input type="checkbox"/> None	CO: Ext. No. with ATLC: blank
Night Answer Point (Type: No.)	<input type="checkbox"/> UNA1, <input type="checkbox"/> UNA2 <input type="checkbox"/> EXT (3 or 4 digits) <input type="checkbox"/> IRMT <input type="checkbox"/> None	<input type="checkbox"/> uNA1, <input type="checkbox"/> uNA2 <input type="checkbox"/> EXT (3 or 4 digits) <input type="checkbox"/> RMT <input type="checkbox"/> None	<input type="checkbox"/> UNA1, <input type="checkbox"/> UNA2 <input type="checkbox"/> EXT (3 or 4 digits) <input type="checkbox"/> RMT <input type="checkbox"/> None	<input type="checkbox"/> uNA1, <input type="checkbox"/> uNA2 <input type="checkbox"/> EXT (3 or 4 digits) <input type="checkbox"/> RMT <input type="checkbox"/> None	<input type="checkbox"/> UNA1, <input type="checkbox"/> UNA2 <input type="checkbox"/> EXT (3 or 4 digits) <input type="checkbox"/> RMT <input type="checkbox"/> None	<input type="checkbox"/> uNA1, <input type="checkbox"/> uNA2 <input type="checkbox"/> EXT (3 or 4 digits) <input type="checkbox"/> RMT <input type="checkbox"/> None	<input type="checkbox"/> UNA1, <input type="checkbox"/> UNA2 <input type="checkbox"/> EXT (3 or 4 digits) <input type="checkbox"/> RMT <input type="checkbox"/> None	<input type="checkbox"/> uNA1, <input type="checkbox"/> uNA2 <input type="checkbox"/> EXT (3 or 4 digits) <input type="checkbox"/> RMT <input type="checkbox"/> None	CO: Ext. No.
Dial Mode	<input type="checkbox"/> DTMF <input type="checkbox"/> Pulse	<input type="checkbox"/> DTMF <input type="checkbox"/> Pulse	<input type="checkbox"/> DTMF <input type="checkbox"/> Pulse	<input type="checkbox"/> DTMF <input type="checkbox"/> Pulse	<input type="checkbox"/> DTMF <input type="checkbox"/> Pulse	<input type="checkbox"/> DTMF <input type="checkbox"/> Pulse	<input type="checkbox"/> DTMF <input type="checkbox"/> Pulse	<input type="checkbox"/> DTMF <input type="checkbox"/> Pulse	DTMF
DTMF Duration Time	<input type="checkbox"/> 80 mseconds <input type="checkbox"/> 160 mseconds	<input type="checkbox"/> 80 mseconds <input type="checkbox"/> 160 mseconds	<input type="checkbox"/> 80 mseconds <input type="checkbox"/> 160 mseconds	<input type="checkbox"/> 80 mseconds <input type="checkbox"/> 160 mseconds	<input type="checkbox"/> 80 mseconds <input type="checkbox"/> 160 mseconds	<input type="checkbox"/> 80 mseconds <input type="checkbox"/> 160 mseconds	<input type="checkbox"/> 80 mseconds <input type="checkbox"/> 160 mseconds	<input type="checkbox"/> 80 mseconds <input type="checkbox"/> 160 mseconds	80
Pulse Speed	<input type="checkbox"/> 10 pps <input type="checkbox"/> High (20 pps)	<input type="checkbox"/> 10 pps <input type="checkbox"/> High (20 pps)	<input type="checkbox"/> 10 pps <input type="checkbox"/> High (20 pps)	<input type="checkbox"/> LOW (10 pps) <input type="checkbox"/> High (20 pps)	<input type="checkbox"/> Low (10 pps) <input type="checkbox"/> High (20 pps)	<input type="checkbox"/> Low (10 pps) <input type="checkbox"/> High (20 pps)	<input type="checkbox"/> Low (10 pps) <input type="checkbox"/> High (20 pps)	<input type="checkbox"/> Low (10 pps) <input type="checkbox"/> High (20 pps)	—
% Break	<input type="checkbox"/> 60% <input type="checkbox"/> 67%	<input type="checkbox"/> 60% <input type="checkbox"/> 67%	<input type="checkbox"/> 60% <input type="checkbox"/> 67%	<input type="checkbox"/> 60% <input type="checkbox"/> 67%	<input type="checkbox"/> 60% <input type="checkbox"/> 67%	<input type="checkbox"/> 60% <input type="checkbox"/> 67%	<input type="checkbox"/> 60% <input type="checkbox"/> 67%	<input type="checkbox"/> 60% <input type="checkbox"/> 67%	---
CPC Detection	<input type="checkbox"/> 6.5 mseconds <input type="checkbox"/> 8 x ___ /msec. <input type="checkbox"/> None	<input type="checkbox"/> 6.5 mseconds <input type="checkbox"/> 8 x ___ /msec. <input type="checkbox"/> None	<input type="checkbox"/> 6.5 mseconds <input type="checkbox"/> 8 x ___ /msec. <input type="checkbox"/> None	<input type="checkbox"/> 6.5 mseconds <input type="checkbox"/> 8 x ___ /msec. <input type="checkbox"/> None	<input type="checkbox"/> 6.5 mseconds <input type="checkbox"/> 8 x ___ /msec. <input type="checkbox"/> None	<input type="checkbox"/> 6.5 mseconds <input type="checkbox"/> 8 x ___ /msec. <input type="checkbox"/> None	<input type="checkbox"/> 6.5 mseconds <input type="checkbox"/> 8 x ___ /msec. <input type="checkbox"/> None	<input type="checkbox"/> 6.5 mseconds <input type="checkbox"/> 8 x ___ /msec. <input type="checkbox"/> None	50 (400ms)
DID start Arrangement	<input type="checkbox"/> immediate Start <input type="checkbox"/> Send Delay Wink	<input type="checkbox"/> immediate Start <input type="checkbox"/> Send Delay Wink	<input type="checkbox"/> immediate Start <input type="checkbox"/> Send Delay Wink	<input type="checkbox"/> immediate Start <input type="checkbox"/> Send Delay Wink	<input type="checkbox"/> immediate Start <input type="checkbox"/> Send Delay Wink	<input type="checkbox"/> immediate Start <input type="checkbox"/> Send Delay Wink	<input type="checkbox"/> immediate Start <input type="checkbox"/> Send Delay Wink	<input type="checkbox"/> immediate Start <input type="checkbox"/> Send Delay Wink	Send Delay Wink

TRUNK'CO LINE

Item	Trunk Equipment Number								Default Value
Trunk Group	(2 digits: 01 to 16)	(2 digits: 01 to 16)	(2 digits: 01 to 16)	(2 digits: 01 to 16)	(2 digits: 01 to 16)	(2 digits: 01 to 16)	(2 digits: 01 to 16)	(2 digits: 01 to 16)	co: 01 DID: 16
Trunk Name	-----	-----	-----	-----	-----	-----	-----	-----	Txxxx Physical Number
Direct Termination	<input type="checkbox"/> DN (3 or 4 digits) <input type="checkbox"/> None	<input type="checkbox"/> DN (3 or 4 digits) <input type="checkbox"/> None	<input type="checkbox"/> DN (3 or 4 digits) <input type="checkbox"/> None	<input type="checkbox"/> DN (3 or 4 digits) <input type="checkbox"/> None	<input type="checkbox"/> DN (3 or 4 digits) <input type="checkbox"/> None	<input type="checkbox"/> DN (3 or 4 digits) <input type="checkbox"/> None	<input type="checkbox"/> DN (3 or 4 digits) <input type="checkbox"/> None	<input type="checkbox"/> DN (3 or 4 digits) <input type="checkbox"/> None	CO: Ext. No. with ATLC: blank
Night Answer Point (Type: No.)	<input type="checkbox"/> IUNA2 <input type="checkbox"/> EXT (3 or 4 digits) <input type="checkbox"/> RMT <input type="checkbox"/> None	<input type="checkbox"/> IUNAI, <input type="checkbox"/> UNM <input type="checkbox"/> EXT (3 or 4 digits) <input type="checkbox"/> RMT <input type="checkbox"/> None	<input type="checkbox"/> UNAI1, <input type="checkbox"/> UNAI2 <input type="checkbox"/> EXT (3 or 4 digits) <input type="checkbox"/> RMT <input type="checkbox"/> None	<input type="checkbox"/> UNAI, <input type="checkbox"/> uNA2 <input type="checkbox"/> EXT (3 or 4 digits) <input type="checkbox"/> RMT <input type="checkbox"/> None	<input type="checkbox"/> UNAI, <input type="checkbox"/> UNAI2 <input type="checkbox"/> EXT (3 or 4 digits) <input type="checkbox"/> RMT <input type="checkbox"/> None	<input type="checkbox"/> UNAI1, <input type="checkbox"/> UNAI2 <input type="checkbox"/> EXT (3 or 4 digits) <input type="checkbox"/> RMT <input type="checkbox"/> None	<input type="checkbox"/> UNAI, <input type="checkbox"/> UNAI2 <input type="checkbox"/> EXT (3 or 4 digits) <input type="checkbox"/> RMT <input type="checkbox"/> None	<input type="checkbox"/> UNAI, <input type="checkbox"/> UNAI2 <input type="checkbox"/> EXT (3 or 4 digits) <input type="checkbox"/> RMT <input type="checkbox"/> None	CO: Ext. No.
Dial Mode	<input type="checkbox"/> DTMF <input type="checkbox"/> Pulse	<input type="checkbox"/> DTMF <input type="checkbox"/> Pulse	<input type="checkbox"/> Pulse	<input type="checkbox"/> DTMF <input type="checkbox"/> Pulse	<input type="checkbox"/> DTMF <input type="checkbox"/> IPulse	<input type="checkbox"/> IDTMF <input type="checkbox"/> Pulse	<input type="checkbox"/> DTMF <input type="checkbox"/> Pulse	<input type="checkbox"/> IDTMF <input type="checkbox"/> Pulse	DTMF
IDTMF Duration Time	<input type="checkbox"/> KIO mseconds <input type="checkbox"/> 160 mseconds	<input type="checkbox"/> 80 mseconds <input type="checkbox"/> 160 mseconds	<input type="checkbox"/> 80 mseconds <input type="checkbox"/> 160 mseconds	<input type="checkbox"/> 80 mseconds <input type="checkbox"/> 160 mseconds	<input type="checkbox"/> 80 mseconds <input type="checkbox"/> 160 mseconds	<input type="checkbox"/> 80 mseconds <input type="checkbox"/> 160 mseconds	<input type="checkbox"/> 80 mseconds <input type="checkbox"/> 160 mseconds	<input type="checkbox"/> 80 mseconds <input type="checkbox"/> 160 mseconds	80
IPulse Speed	<input type="checkbox"/> (10 pps) <input type="checkbox"/> High (20 pps)	<input type="checkbox"/> Low (10 pps) <input type="checkbox"/> High (20 pps)	<input type="checkbox"/> Low (10 pps) <input type="checkbox"/> High (20 pps)	<input type="checkbox"/> Low (10 pps) <input type="checkbox"/> High (20 pps)	<input type="checkbox"/> Low (10 pps) <input type="checkbox"/> High (20 pps)	<input type="checkbox"/> Low (10 pps) <input type="checkbox"/> High (20 pps)	<input type="checkbox"/> Low (10 pps) <input type="checkbox"/> High (20 pps)	<input type="checkbox"/> Low (10 pps) <input type="checkbox"/> High (20 pps)	---
% Break	<input type="checkbox"/> 60% <input type="checkbox"/> 67%	<input type="checkbox"/> 60% <input type="checkbox"/> 67%	<input type="checkbox"/> 60% <input type="checkbox"/> 67%	060% 067%	060% 067%	060% <input type="checkbox"/> 67%	<input type="checkbox"/> 60% <input type="checkbox"/> 67%	<input type="checkbox"/> 60% <input type="checkbox"/> 67%	---
CPC Detection	06.5 mseconds <input type="checkbox"/> 8 x ___/msec. <input type="checkbox"/> None	<input type="checkbox"/> 6.5 mseconds <input type="checkbox"/> 8 x ___/msec. <input type="checkbox"/> None	<input type="checkbox"/> 6.5 mseconds <input type="checkbox"/> 8 x ___/msec. <input type="checkbox"/> None	06.5 mseconds <input type="checkbox"/> 8 x ___/msec. <input type="checkbox"/> None	<input type="checkbox"/> 6.5 mseconds <input type="checkbox"/> 8 x ___/msec. <input type="checkbox"/> None	<input type="checkbox"/> 6.5 mseconds <input type="checkbox"/> 8 x ___/msec. <input type="checkbox"/> None	<input type="checkbox"/> 6.5 mseconds <input type="checkbox"/> 8 x ___/msec. <input type="checkbox"/> None	<input type="checkbox"/> 6.5 mseconds <input type="checkbox"/> 8 x ___/msec. <input type="checkbox"/> None	50 (400ms)
DID start Arrangement	<input type="checkbox"/> immediate Start <input type="checkbox"/> Send Delay Wink	<input type="checkbox"/> immediate Start <input type="checkbox"/> Send Delay Wink	<input type="checkbox"/> immediate Start Send Delay Wink	<input type="checkbox"/> immediate Start <input type="checkbox"/> Send Delay Wink	<input type="checkbox"/> Immediate Start <input type="checkbox"/> Send Delay Wink	<input type="checkbox"/> Immediate Start <input type="checkbox"/> Send Delay Wink	<input type="checkbox"/> Immediate Start <input type="checkbox"/> Send Delay Wink	<input type="checkbox"/> Immediate Start <input type="checkbox"/> Send Delay Wink	Send Delay Wink

TRUNK—CO LINE

Item	Trunk Equipment Number								Default Value
Trunk Group	<input type="text" value=""/> (2 digits: 01 to 16)	<input type="text" value=""/> (2 digits: 01 to 16)	<input type="text" value=""/> (2 digits: 01 to 16)	<input type="text" value=""/> (2 digits: 01 to 16)	<input type="text" value=""/> (2 digits: 01 to 16)	<input type="text" value=""/> (2 digits: 01 to 16)	<input type="text" value=""/> (2 digits: 01 to 16)	<input type="text" value=""/> (2 digits: 01 to 16)	co: 01 DID: 16
Trunk Name	<input type="text" value=""/>	<input type="text" value=""/>	<input type="text" value=""/>	<input type="text" value=""/>	<input type="text" value=""/>	<input type="text" value=""/>	<input type="text" value=""/>	<input type="text" value=""/>	Txxxx Physical Number
Direct Termination	<input type="checkbox"/> DN (3 or 4 digits) <input type="checkbox"/> None	<input type="checkbox"/> DN (3 or 4 digits) <input type="checkbox"/> None	<input type="checkbox"/> DN (3 or 4 digits) <input type="checkbox"/> None	<input type="checkbox"/> DN (3 or 4 digits) <input type="checkbox"/> None	<input type="checkbox"/> DN (3 or 4 digits) <input type="checkbox"/> None	<input type="checkbox"/> DN (3 or 4 digits) <input type="checkbox"/> None	<input type="checkbox"/> DN (3 or 4 digits) <input type="checkbox"/> None	<input type="checkbox"/> DN (3 or 4 digits) <input type="checkbox"/> None	CO: Ext. No. with ATLC: blank
Night Answer Point (Type: No.)	<input type="checkbox"/> UNA1, <input type="checkbox"/> UNA2 <input type="checkbox"/> EXT (3 or 4 digits) <input type="checkbox"/> RMT <input type="checkbox"/> None	<input type="checkbox"/> UNA1, <input type="checkbox"/> UNA2 <input type="checkbox"/> EXT (3 or 4 digits) <input type="checkbox"/> RMT <input type="checkbox"/> None	<input type="checkbox"/> UNA1, <input type="checkbox"/> UNA2 <input type="checkbox"/> EXT (3 or 4 digits) <input type="checkbox"/> RMT <input type="checkbox"/> None	<input type="checkbox"/> UNA1, <input type="checkbox"/> UNA2 <input type="checkbox"/> EXT (3 or 4 digits) <input type="checkbox"/> RMT <input type="checkbox"/> None	<input type="checkbox"/> UNA1, <input type="checkbox"/> UNA2 <input type="checkbox"/> EXT (3 or 4 digits) <input type="checkbox"/> RMT <input type="checkbox"/> None	<input type="checkbox"/> UNA1, <input type="checkbox"/> UNA2 <input type="checkbox"/> EXT (3 or 4 digits) <input type="checkbox"/> RMT <input type="checkbox"/> None	<input type="checkbox"/> UNA1, <input type="checkbox"/> UNA2 <input type="checkbox"/> EXT (3 or 4 digits) <input type="checkbox"/> RMT <input type="checkbox"/> None	<input type="checkbox"/> UNA1, <input type="checkbox"/> UNA2 <input type="checkbox"/> EXT (3 or 4 digits) <input type="checkbox"/> RMT <input type="checkbox"/> None	CO: Ext. No.
Dial Mode	<input type="checkbox"/> DTMF <input type="checkbox"/> Pulse	<input type="checkbox"/> DTMF <input type="checkbox"/> Pulse	<input type="checkbox"/> DTMF <input type="checkbox"/> Pulse	<input type="checkbox"/> DTMF <input type="checkbox"/> Pulse	<input type="checkbox"/> DTMF <input type="checkbox"/> Pulse	<input type="checkbox"/> DTMF <input type="checkbox"/> Pulse	<input type="checkbox"/> DTMF <input type="checkbox"/> Pulse	<input type="checkbox"/> DTMF <input type="checkbox"/> Pulse	DTMF
DTMF Duration Time	080 mseconds <input type="checkbox"/> 160 mseconds	<input type="checkbox"/> 80 mseconds <input type="checkbox"/> 160 mseconds	<input type="checkbox"/> 80 mseconds <input type="checkbox"/> 160 mseconds	<input type="checkbox"/> 80 mseconds <input type="checkbox"/> 160 mseconds	<input type="checkbox"/> 80 mseconds <input type="checkbox"/> 160 mseconds	<input type="checkbox"/> 80 mseconds <input type="checkbox"/> 160 mseconds	<input type="checkbox"/> 80 mseconds <input type="checkbox"/> 160 mseconds	<input type="checkbox"/> 80 mseconds <input type="checkbox"/> 160 mseconds	80
Pulse Speed	<input type="checkbox"/> Low (10 pps) <input type="checkbox"/> High (20 pps)	<input type="checkbox"/> Low (10 pps) <input type="checkbox"/> High (20 pps)	<input type="checkbox"/> Low (10 pps) <input type="checkbox"/> High (20 pps)	<input type="checkbox"/> Low (10 pps) <input type="checkbox"/> High (20 pps)	<input type="checkbox"/> Low (10 pps) <input type="checkbox"/> High (20 pps)	<input type="checkbox"/> Low (10 pps) <input type="checkbox"/> High (20 pps)	<input type="checkbox"/> Low (10 pps) <input type="checkbox"/> High (20 pps)	<input type="checkbox"/> Low (10 pps) <input type="checkbox"/> High (20 pps)	---
% Break	060% <input type="checkbox"/> 067%	060% <input type="checkbox"/> 067%	060% <input type="checkbox"/> 067%	060% <input type="checkbox"/> 067%	060% <input type="checkbox"/> 067%	060% <input type="checkbox"/> 067%	060% <input type="checkbox"/> 067%	060% <input type="checkbox"/> 067%	---
CPC Detection	06.5 mseconds <input type="checkbox"/> 8 x ___/msec. <input type="checkbox"/> None	06.5 mseconds <input type="checkbox"/> 8 x ___/msec. <input type="checkbox"/> None	<input type="checkbox"/> 6.5 mseconds <input type="checkbox"/> 8 x ___/msec. <input type="checkbox"/> None	<input type="checkbox"/> 6.5 mseconds <input type="checkbox"/> 8 x ___/msec. <input type="checkbox"/> None	06.5 mseconds <input type="checkbox"/> 8 x ___/msec. <input type="checkbox"/> None	06.5 mseconds <input type="checkbox"/> 8 x ___/msec. <input type="checkbox"/> None	<input type="checkbox"/> 6.5 mseconds <input type="checkbox"/> 8 x ___/msec. <input type="checkbox"/> None	<input type="checkbox"/> 6.5 mseconds <input type="checkbox"/> 8 x ___/msec. <input type="checkbox"/> None	50 /(400ms)
DID start Arrangement	<input type="checkbox"/> immediate Start <input type="checkbox"/> Send Delay Wink	<input type="checkbox"/> immediate Start <input type="checkbox"/> Send Delay Wink	<input type="checkbox"/> immediate Start <input type="checkbox"/> Send Delay Wink	<input type="checkbox"/> immediate Start <input type="checkbox"/> Send Delay Wink	<input type="checkbox"/> immediate Start <input type="checkbox"/> Send Delay Wink	<input type="checkbox"/> immediate Start <input type="checkbox"/> Send Delay Wink	<input type="checkbox"/> immediate Start <input type="checkbox"/> Send Delay Wink	<input type="checkbox"/> immediate Start <input type="checkbox"/> Send Delay Wink	Send Delay Wink

TRUNK-CO LINE

5-13

Item	Trunk Equipment Number								Default Value
Trunk Group	(2 digits: 01 to 16)	(2 digits: 01 to 16)	(2 digits: 01 to 16)	(2 digits: 01 to 16)	(2 digits: 01 to 16)	(2 digits: 01 to 16)	(2 digits: 01 to 16)	(2 digits: 01 to 16)	CO: 01 DID: 16
Trunk Name	-----	-----	-----	-----	-----	-----	-----	-----	Txxxx Physical Number
Direct Termination	<input type="checkbox"/> DN (3 or 4 digits) <input type="checkbox"/> None	<input type="checkbox"/> DN (3 or 4 digits) <input type="checkbox"/> None	<input type="checkbox"/> DN (3 or 4 digits) <input type="checkbox"/> None	<input type="checkbox"/> DN (3 or 4 digits) <input type="checkbox"/> None	<input type="checkbox"/> DN (3 or 4 digits) <input type="checkbox"/> None	<input type="checkbox"/> DN (3 or 4 digits) <input type="checkbox"/> None	<input type="checkbox"/> DN (3 or 4 digits) <input type="checkbox"/> None	<input type="checkbox"/> DN (3 or 4 digits) <input type="checkbox"/> None	(30: Ext. No with ATLC: blank
Night Answer Point [Type: No.]	<input type="checkbox"/> ☺☎ <input type="checkbox"/> W2 <input type="checkbox"/> EXT (3 or 4 digits) <input type="checkbox"/> IRMT <input type="checkbox"/> None	<input type="checkbox"/> IUNAI, <input type="checkbox"/> UNA2 <input type="checkbox"/> IEXT (3 or 4 digits) <input type="checkbox"/> RMT <input type="checkbox"/> None	<input type="checkbox"/> IUNAI <input type="checkbox"/> UNA2 <input type="checkbox"/> EXT (3 or 4 digits) <input type="checkbox"/> RMT <input type="checkbox"/> None	<input type="checkbox"/> UNA1, <input type="checkbox"/> UNA2 <input type="checkbox"/> JEXT (3 or 4 digits) <input type="checkbox"/> RMT <input type="checkbox"/> None	<input type="checkbox"/> UNA1 <input type="checkbox"/> UNA2 <input type="checkbox"/> EXT (3 or 4 digits) <input type="checkbox"/> RMT <input type="checkbox"/> None	<input type="checkbox"/> IUNAI <input type="checkbox"/> UNA2 <input type="checkbox"/> EXT (3 or 4 digits) <input type="checkbox"/> RMT <input type="checkbox"/> None	<input type="checkbox"/> ☺☎ <input type="checkbox"/> W2 <input type="checkbox"/> JEXT (3 or 4 digits) <input type="checkbox"/> RMT <input type="checkbox"/> None	<input type="checkbox"/> IUNAI <input type="checkbox"/> UNA2 <input type="checkbox"/> EXT (3 or 4 digits) <input type="checkbox"/> RMT <input type="checkbox"/> None	CO: Ext. No.
Dial Mode	<input type="checkbox"/> DTMF <input type="checkbox"/> Pulse	<input type="checkbox"/> DTMF <input type="checkbox"/> Pulse	<input type="checkbox"/> DTMF <input type="checkbox"/> Pulse	<input type="checkbox"/> DTMF <input type="checkbox"/> Pulse	<input type="checkbox"/> DTMF <input type="checkbox"/> Pulse	<input type="checkbox"/> DTMF <input type="checkbox"/> Pulse	<input type="checkbox"/> DTMF <input type="checkbox"/> Pulse	<input type="checkbox"/> DTMF <input type="checkbox"/> Pulse	DTMF
DTMF Duration Time	<input type="checkbox"/> 80 mseconds <input type="checkbox"/> 160 mseconds	<input type="checkbox"/> 80 mseconds <input type="checkbox"/> 160 mseconds	<input type="checkbox"/> 80 mseconds <input type="checkbox"/> 160 mseconds	<input type="checkbox"/> 80 mseconds <input type="checkbox"/> 160 mseconds	<input type="checkbox"/> 80 mseconds <input type="checkbox"/> 160 mseconds	<input type="checkbox"/> 80 mseconds <input type="checkbox"/> 160 mseconds	<input type="checkbox"/> 80 mseconds <input type="checkbox"/> 160 mseconds	<input type="checkbox"/> 80 mseconds <input type="checkbox"/> 160 mseconds	80
Pulse Speed	<input type="checkbox"/> Low (10 pps) <input type="checkbox"/> High (20 pps)	<input type="checkbox"/> LOW (10 pps) <input type="checkbox"/> High (20 pps)	<input type="checkbox"/> LOW (10 pps) <input type="checkbox"/> High (20 pps)	<input type="checkbox"/> LOW (10 pps) <input type="checkbox"/> High (20 pps)	<input type="checkbox"/> LOW (10 pps) <input type="checkbox"/> High (20 pps)	<input type="checkbox"/> LOW (10 pps) <input type="checkbox"/> High (20 pps)	<input type="checkbox"/> LOW (10 pps) <input type="checkbox"/> High (20 pps)	<input type="checkbox"/> Low (10 pps) <input type="checkbox"/> High (20 pps)	—
% Break	<input type="checkbox"/> 60% <input type="checkbox"/> 67%	<input type="checkbox"/> 60% <input type="checkbox"/> 67%	<input type="checkbox"/> 60% <input type="checkbox"/> 67%	<input type="checkbox"/> 60% <input type="checkbox"/> 67%	<input type="checkbox"/> 60% <input type="checkbox"/> 67%	<input type="checkbox"/> 60% <input type="checkbox"/> 67%	<input type="checkbox"/> 60% <input type="checkbox"/> 67%	<input type="checkbox"/> 60% <input type="checkbox"/> 67%	
CPC Detection	<input type="checkbox"/> 6.5 mseconds <input type="checkbox"/> 8 x ___ /msec. <input type="checkbox"/> None	<input type="checkbox"/> 6.5 mseconds <input type="checkbox"/> 8 x ___ /msec. <input type="checkbox"/> None	<input type="checkbox"/> 6.5 mseconds <input type="checkbox"/> 8 x ___ /msec. <input type="checkbox"/> None	<input type="checkbox"/> 6.5 mseconds <input type="checkbox"/> 8 x ___ /msec. <input type="checkbox"/> None	<input type="checkbox"/> 6.5 mseconds <input type="checkbox"/> 8 x ___ /msec. <input type="checkbox"/> None	<input type="checkbox"/> 6.5 mseconds <input type="checkbox"/> 8 x ___ /msec. <input type="checkbox"/> None	<input type="checkbox"/> 6.5 mseconds <input type="checkbox"/> 8 x ___ /msec. <input type="checkbox"/> None	<input type="checkbox"/> 6.5 mseconds <input type="checkbox"/> 8 x ___ /msec. <input type="checkbox"/> None	50 (400ms)
DID start Arrangement	<input type="checkbox"/> immediate Start <input type="checkbox"/> Send Delay Wink	<input type="checkbox"/> immediate Start <input type="checkbox"/> Send Delay Wink	<input type="checkbox"/> Immediate Start <input type="checkbox"/> Send Delay Wink	<input type="checkbox"/> immediate Start <input type="checkbox"/> Send Delay Wink	<input type="checkbox"/> immediate Start <input type="checkbox"/> Send Delay Wink	<input type="checkbox"/> immediate Start <input type="checkbox"/> Send Delay Wink	<input type="checkbox"/> Immediate Start <input type="checkbox"/> Send Delay Wink	<input type="checkbox"/> Immediate Start <input type="checkbox"/> Send Delay Wink	Send Delay Wink

TRUNK—CO LINE

Item	Trunk Group	Trunk Name	Direct Termination	Right Answer Type: (NO.) <input type="checkbox"/> RMT	Dial Mode	DTMF <input type="checkbox"/> Pulse <input type="checkbox"/> DTMF	Duration Time	Pulse Speed	% Break	CPC Detection	CID start Arrangement	Trunk Equipment Number											
												CO: 01 DID: 16 Txxxx Physical Number	CO: Ext. No. with ATLC: blank	CO: Ext. No. <input type="checkbox"/> UNA1, <input type="checkbox"/> UNA2 <input type="checkbox"/> EXT (3 or 4 digits) <input type="checkbox"/> RMT <input type="checkbox"/> None	CO: Ext. No. <input type="checkbox"/> DN (3 or 4 digits) <input type="checkbox"/> None	CO: Ext. No. <input type="checkbox"/> UNA1, <input type="checkbox"/> UNA2 <input type="checkbox"/> EXT (3 or 4 digits) <input type="checkbox"/> RMT <input type="checkbox"/> None	CO: Ext. No. <input type="checkbox"/> DN (3 or 4 digits) <input type="checkbox"/> None	CO: Ext. No. <input type="checkbox"/> UNA1, <input type="checkbox"/> UNA2 <input type="checkbox"/> EXT (3 or 4 digits) <input type="checkbox"/> RMT <input type="checkbox"/> None	CO: Ext. No. <input type="checkbox"/> DN (3 or 4 digits) <input type="checkbox"/> None	CO: Ext. No. <input type="checkbox"/> UNA1, <input type="checkbox"/> UNA2 <input type="checkbox"/> EXT (3 or 4 digits) <input type="checkbox"/> RMT <input type="checkbox"/> None	CO: Ext. No. <input type="checkbox"/> DN (3 or 4 digits) <input type="checkbox"/> None	CO: Ext. No. <input type="checkbox"/> UNA1, <input type="checkbox"/> UNA2 <input type="checkbox"/> EXT (3 or 4 digits) <input type="checkbox"/> RMT <input type="checkbox"/> None	CO: Ext. No. <input type="checkbox"/> DN (3 or 4 digits) <input type="checkbox"/> None
Default Value	CO: 01 DID: 16	Txxxx Physical Number	CO: Ext. No. with ATLC: blank	CO: Ext. No. <input type="checkbox"/> UNA1, <input type="checkbox"/> UNA2 <input type="checkbox"/> EXT (3 or 4 digits) <input type="checkbox"/> RMT <input type="checkbox"/> None	CO: Ext. No. <input type="checkbox"/> DTMF <input type="checkbox"/> Pulse	80 ms <input type="checkbox"/> 80 <input type="checkbox"/> 160 <input type="checkbox"/> 80 <input type="checkbox"/> 160 msec	Low (10 pps) High (20 pps)	<input type="checkbox"/> 60% <input type="checkbox"/> 67%	<input type="checkbox"/> 6.5 msec <input type="checkbox"/> 8 x /msec. <input type="checkbox"/> None	<input type="checkbox"/> 6.5 msec <input type="checkbox"/> 8 x /msec. <input type="checkbox"/> None	<input type="checkbox"/> Immediate Start <input type="checkbox"/> Send Delay Wink	Trunk Equipment Number											

TRUNK—CO LINE

Item	Trunk Equipment Number								Default Value
Trunk Group	(2 digits: 01 to 16)	(2 digits: 01 to 16)	(2 digits: 01 to 16)	(2 digits: 01 to 16)	(2 digits: 01 to 16)	(2 digits: 01 to 16)	(2 digits: 01 to 16)	(2 digits: 01 to 16)	co: 01 DID: 16
Trunk Name	-----	-----	-----	-----	-----	-----	-----	-----	Txxxx Physical Number
Direct Termination	<input type="checkbox"/> DN (3 or 4 digits) <input type="checkbox"/> None	<input type="checkbox"/> DN (3 or 4 digits) <input type="checkbox"/> None	<input type="checkbox"/> DN (3 or 4 digits) <input type="checkbox"/> None	<input type="checkbox"/> DN (3 or 4 digits) <input type="checkbox"/> None	<input type="checkbox"/> DN (3 or 4 digits) <input type="checkbox"/> None	<input type="checkbox"/> DN (3 or 4 digits) <input type="checkbox"/> None	<input type="checkbox"/> DN (3 or 4 digits) <input type="checkbox"/> None	<input type="checkbox"/> DN (3 or 4 digits) <input type="checkbox"/> None	CO: Ext. No. with ATLC: blank
Night Answer Point (Type: No.)	<input type="checkbox"/> luw <input type="checkbox"/> UNA2 <input type="checkbox"/> EXT (3 or 4 digits) <input type="checkbox"/> RMT <input type="checkbox"/> None	<input type="checkbox"/> UNAI <input type="checkbox"/> UNA2 <input type="checkbox"/> EXT (3 or 4 digits) <input type="checkbox"/> RMT <input type="checkbox"/> None	<input type="checkbox"/> UNAI <input type="checkbox"/> UNA2 <input type="checkbox"/> EXT (3 or 4 digits) <input type="checkbox"/> RMT <input type="checkbox"/> None	<input type="checkbox"/> uNAI <input type="checkbox"/> UNA2 <input type="checkbox"/> EXT (3 or 4 digits) <input type="checkbox"/> RMT <input type="checkbox"/> None	<input type="checkbox"/> uNAI <input type="checkbox"/> UNA2 <input type="checkbox"/> EXT (3 or 4 digits) <input type="checkbox"/> RMT <input type="checkbox"/> None	<input type="checkbox"/> luNAI <input type="checkbox"/> UNA2 <input type="checkbox"/> EXT (3 or 4 digits) <input type="checkbox"/> RMT <input type="checkbox"/> None	<input type="checkbox"/> luNAI <input type="checkbox"/> UNA2 <input type="checkbox"/> EXT (3 or 4 digits) <input type="checkbox"/> RMT <input type="checkbox"/> None	<input type="checkbox"/> UNA1 <input type="checkbox"/> UNA2 <input type="checkbox"/> EXT (3 or 4 digits) <input type="checkbox"/> RMT <input type="checkbox"/> None	CO: Ext. No.
Dial Mode	<input type="checkbox"/> DTMF <input type="checkbox"/> Pulse	<input type="checkbox"/> DTMF <input type="checkbox"/> Pulse	<input type="checkbox"/> DTMF <input type="checkbox"/> Pulse	<input type="checkbox"/> DTMF <input type="checkbox"/> Pulse	<input type="checkbox"/> DTMF <input type="checkbox"/> Pulse	<input type="checkbox"/> DTMF <input type="checkbox"/> Pulse	<input type="checkbox"/> DTMF <input type="checkbox"/> Pulse	<input type="checkbox"/> DTMF <input type="checkbox"/> Pulse	DTMF
DTMF Duration Time	080 mseconds <input type="checkbox"/> 160 mseconds	<input type="checkbox"/> 80 mseconds <input type="checkbox"/> 160 mseconds	<input type="checkbox"/> 80 mseconds <input type="checkbox"/> 160 mseconds	<input type="checkbox"/> 80 mseconds <input type="checkbox"/> 160 mseconds	<input type="checkbox"/> 80 mseconds <input type="checkbox"/> 160 mseconds	<input type="checkbox"/> 80 mseconds <input type="checkbox"/> 160 mseconds	<input type="checkbox"/> 80 mseconds <input type="checkbox"/> 160 mseconds	<input type="checkbox"/> 80 mseconds <input type="checkbox"/> 160 mseconds	80
Pulse Speed	<input type="checkbox"/> Low (10 pps) <input type="checkbox"/> High (20 pps)	<input type="checkbox"/> Low (10 pps) <input type="checkbox"/> High (20 pps)	<input type="checkbox"/> Low (10 pps) <input type="checkbox"/> High (20 pps)	<input type="checkbox"/> Low (10 pps) <input type="checkbox"/> High (20 pps)	<input type="checkbox"/> Low (10 pps) <input type="checkbox"/> High (20 pps)	<input type="checkbox"/> Low (10 pps) <input type="checkbox"/> High (20 pps)	<input type="checkbox"/> Low (10 pps) <input type="checkbox"/> High (20 pps)	<input type="checkbox"/> Low (10 pps) <input type="checkbox"/> High (20 pps)	—
% Break	<input type="checkbox"/> 60% <input type="checkbox"/> 67%	060% <input type="checkbox"/> 67%	<input type="checkbox"/> 60% <input type="checkbox"/> 67%	<input type="checkbox"/> 60% <input type="checkbox"/> 67%	060% 067%	<input type="checkbox"/> 60% <input type="checkbox"/> 67%	067%	<input type="checkbox"/> 60% <input type="checkbox"/> 67%	—
CPC Detection	06.5 mseconds <input type="checkbox"/> 8 x ___/msec. <input type="checkbox"/> None	<input type="checkbox"/> 6.5 mseconds <input type="checkbox"/> 8 x ___/msec. <input type="checkbox"/> None	06.5 mseconds <input type="checkbox"/> 8 x ___/msec. <input type="checkbox"/> None	<input type="checkbox"/> 6.5 mseconds <input type="checkbox"/> 8 x ___/msec. <input type="checkbox"/> None	<input type="checkbox"/> 6.5 mseconds <input type="checkbox"/> 8 x ___/msec. <input type="checkbox"/> None	<input type="checkbox"/> 6.5 mseconds <input type="checkbox"/> 8 x ___/msec. <input type="checkbox"/> None	<input type="checkbox"/> 6.5 mseconds <input type="checkbox"/> 8 x ___/msec. <input type="checkbox"/> None	06.5 mseconds <input type="checkbox"/> 8 x ___/msec. <input type="checkbox"/> None	50 (400ms)
DID start Arrangement	<input type="checkbox"/> immediate Start <input type="checkbox"/> Send Delay Wink	<input type="checkbox"/> Immediate Start <input type="checkbox"/> Send Delay Wink	<input type="checkbox"/> immediate Start <input type="checkbox"/> Send Delay Wink	<input type="checkbox"/> immediate Start <input type="checkbox"/> Send Delay Wink	<input type="checkbox"/> Immediate Start <input type="checkbox"/> Send Delay Wink	<input type="checkbox"/> Immediate Start <input type="checkbox"/> Send Delay Wink	<input type="checkbox"/> immediate Start <input type="checkbox"/> Send Delay Wink	<input type="checkbox"/> Immediate Start <input type="checkbox"/> Send Delay Wink	Send Delay Wink

5-15

TRUNK—CO LINE

Item	Trunk Equipment Number								Default Value
Trunk Group	(2 digits: 01 to 16)	(2 digits: 01 to 16)	(2 digits: 01 to 16)	(2 digits: 01 to 16)	(2 digits: 01 to 16)	(2 digits: 01 to 16)	(2 digits: 01 to 16)	(2 digits: 01 to 16)	co: 01 DID: 16
Trunk Name	-----	-----	-----	-----	-----	-----	-----	-----	Txxx Physical Number
Direct Termination	<input type="checkbox"/> DN (3 or 4 digits) <input type="checkbox"/> None	<input type="checkbox"/> DN (3 or 4 digits) <input type="checkbox"/> None	<input type="checkbox"/> -DN (3 or 4 digits) <input type="checkbox"/> None	<input type="checkbox"/> DN (3 or 4 digits) <input type="checkbox"/> None	<input type="checkbox"/> DN (3 or 4 digits) <input type="checkbox"/> None	<input type="checkbox"/> DN (3 or 4 digits) <input type="checkbox"/> None	<input type="checkbox"/> DN (3 or 4 digits) <input type="checkbox"/> None	<input type="checkbox"/> DN (3 or 4 digits) <input type="checkbox"/> None	CO: Ext. No. with ATLC: blank
Night Answer Point (Type: No.)	<input type="checkbox"/> uNA1, <input type="checkbox"/> uNA2 <input type="checkbox"/> EXT (3 or 4 digits) <input type="checkbox"/> R	<input type="checkbox"/> uNA1, <input type="checkbox"/> uNA2 <input type="checkbox"/> IEXT (3 or 4 digits) M T	<input type="checkbox"/> IUNAI, <input type="checkbox"/> uNA2 <input type="checkbox"/> EXT (3 or 4 digits) <input type="checkbox"/> None <input type="checkbox"/> RMT	<input type="checkbox"/> UNAI, <input type="checkbox"/> IuNA2 <input type="checkbox"/> IEXT (3 or 4 digits) <input type="checkbox"/> None <input type="checkbox"/> RMT	<input type="checkbox"/> uNA1, <input type="checkbox"/> uNA2 <input type="checkbox"/> EXT (3 or 4 digits) <input type="checkbox"/> RMT <input type="checkbox"/> None	<input type="checkbox"/> IUNAI, <input type="checkbox"/> uNA2 <input type="checkbox"/> EXT (3 or 4 digits) <input type="checkbox"/> RMT <input type="checkbox"/> None	<input type="checkbox"/> UNAI, <input type="checkbox"/> uNA2 <input type="checkbox"/> EXT (3 or 4 digits) <input type="checkbox"/> RMT <input type="checkbox"/> None	<input type="checkbox"/> IUNAI, <input type="checkbox"/> uNA2 <input type="checkbox"/> EXT (3 or 4 digits) <input type="checkbox"/> RMT <input type="checkbox"/> None	CO: Ext. No.
Dial Mode	<input type="checkbox"/> DTMF <input type="checkbox"/> IPulse	<input type="checkbox"/> DTMF <input type="checkbox"/> Pulse	<input type="checkbox"/> DTMF <input type="checkbox"/> Pulse	<input type="checkbox"/> DTMF <input type="checkbox"/> Pulse	<input type="checkbox"/> DTMF <input type="checkbox"/> Pulse	<input type="checkbox"/> DTMF <input type="checkbox"/> Pulse	<input type="checkbox"/> DTMF <input type="checkbox"/> Pulse	<input type="checkbox"/> DTMF <input type="checkbox"/> Pulse	DTMF
DTMF Duration Time	080 mseconds <input type="checkbox"/> 160 mseconds	<input type="checkbox"/> 80 mseconds <input type="checkbox"/> 160 mseconds	<input type="checkbox"/> 80 mseconds <input type="checkbox"/> 160 mseconds	<input type="checkbox"/> 80 mseconds <input type="checkbox"/> 160 mseconds	<input type="checkbox"/> 80 mseconds <input type="checkbox"/> 160 mseconds	<input type="checkbox"/> 80 mseconds <input type="checkbox"/> 160 mseconds	<input type="checkbox"/> 80 mseconds <input type="checkbox"/> 160 mseconds	<input type="checkbox"/> 80 mseconds <input type="checkbox"/> 160 mseconds	80
Pulse Speed	<input type="checkbox"/> 10 pps <input type="checkbox"/> High (20 pps)	<input type="checkbox"/> Low (10 pps) <input type="checkbox"/> High (20 pps)	<input type="checkbox"/> Low (10 pps) <input type="checkbox"/> High (20 pps)	<input type="checkbox"/> Low (10 pps) <input type="checkbox"/> High (20 pps)	<input type="checkbox"/> Low (10 pps) <input type="checkbox"/> High (20 pps)	<input type="checkbox"/> Low (10 pps) <input type="checkbox"/> High (20 pps)	<input type="checkbox"/> Low (10 pps) <input type="checkbox"/> High (20 pps)	<input type="checkbox"/> 10 pps <input type="checkbox"/> High (20 pps)	--
% Break	060% <input type="checkbox"/> 67%	<input type="checkbox"/> 60% <input type="checkbox"/> 67%	<input type="checkbox"/> 60% <input type="checkbox"/> 67%	060% <input type="checkbox"/> 67%	<input type="checkbox"/> 60% <input type="checkbox"/> 67%	060% <input type="checkbox"/> 67%	060% <input type="checkbox"/> 67%	<input type="checkbox"/> 60% <input type="checkbox"/> 67%	--
CPC Detection	<input type="checkbox"/> 6.5 mseconds <input type="checkbox"/> 8 x ___ /msec. <input type="checkbox"/> None	06.5 mseconds <input type="checkbox"/> 8 x ___ /msec. <input type="checkbox"/> None	06.5 mseconds <input type="checkbox"/> 8 x ___ /msec. <input type="checkbox"/> None	<input type="checkbox"/> 6.5 mseconds <input type="checkbox"/> 8 x ___ /msec. <input type="checkbox"/> None	06.5 mseconds <input type="checkbox"/> 8 x ___ /msec. <input type="checkbox"/> None	06.5 mseconds <input type="checkbox"/> 8 x ___ /msec. <input type="checkbox"/> None	06.5 mseconds <input type="checkbox"/> 8 x ___ /msec. <input type="checkbox"/> None	<input type="checkbox"/> 6.5 mseconds <input type="checkbox"/> 8 x ___ /msec. <input type="checkbox"/> None	50 (400ms)
DID start Arrangement	<input type="checkbox"/> immediate Start <input type="checkbox"/> Send Delay Wink	<input type="checkbox"/> immediate Start <input type="checkbox"/> Send Delay Wink	<input type="checkbox"/> Immediate Start <input type="checkbox"/> Send Delay Wink	<input type="checkbox"/> Immediate Start <input type="checkbox"/> Send Delay Wink	<input type="checkbox"/> immediate Start <input type="checkbox"/> Send Delay Wink	<input type="checkbox"/> Immediate Start <input type="checkbox"/> Send Delay Wink	<input type="checkbox"/> Immediate Start <input type="checkbox"/> Send Delay Wink	<input type="checkbox"/> Immediate Start <input type="checkbox"/> Send Delay Wink	Send Delay Wink

TRUNK—CO LINE

Item	Trunk Equipment Number								Default Value
Trunk Group	(2 digits: 01 to 16)	(2 digits: 01 to 16)	(2 digits: 01 to 16)	(2 digits: 01 to 16)	(2 digits: 01 to 16)	(2 digits: 01 to 16)	(2 digits: 01 to 16)	(2 digits: 01 to 16)	CO: 01 DID: 16
Trunk Name	----- ----- -----	----- ----- -----	----- ----- -----	----- ----- -----	----- ----- -----	----- ----- -----	----- ----- -----	----- ----- -----	Txxxx Physical Number
Direct Termination	<input type="checkbox"/> IDN (3 or 4 digits) <input type="checkbox"/> None	<input type="checkbox"/> DN (3 or 4 digits) <input type="checkbox"/> None	<input type="checkbox"/> DN (3 or 4 digits) <input type="checkbox"/> None	<input type="checkbox"/> DN (3 or 4 digits) <input type="checkbox"/> None	<input type="checkbox"/> DN (3 or 4 digits) <input type="checkbox"/> None	<input type="checkbox"/> DN (3 or 4 digits) <input type="checkbox"/> None	<input type="checkbox"/> DN (3 or 4 digits) <input type="checkbox"/> None	<input type="checkbox"/> DN (3 or 4 digits) <input type="checkbox"/> None	CO: Ext. No. with ATLC: blank
Night Answer Point (Type: No.)	<input type="checkbox"/> UNAI, <input type="checkbox"/> UNAI2 <input type="checkbox"/> EXT (3 or 4 digits) <input type="checkbox"/> RMT <input type="checkbox"/> None	<input type="checkbox"/> UNAI, <input type="checkbox"/> UNAI2 <input type="checkbox"/> EXT (3 or 4 digits) <input type="checkbox"/> RMT <input type="checkbox"/> None	<input type="checkbox"/> UNAI, <input type="checkbox"/> UNAI2 <input type="checkbox"/> EXT (3 or 4 digits) <input type="checkbox"/> RMT <input type="checkbox"/> None	<input type="checkbox"/> UNAI, <input type="checkbox"/> UNAI2 <input type="checkbox"/> EXT (3 or 4 digits) <input type="checkbox"/> RMT <input type="checkbox"/> None	<input type="checkbox"/> UNAI, <input type="checkbox"/> UNAI2 <input type="checkbox"/> EXT (3 or 4 digits) <input type="checkbox"/> RMT <input type="checkbox"/> None	<input type="checkbox"/> UNAI, <input type="checkbox"/> UNAI2 <input type="checkbox"/> EXT (3 or 4 digits) <input type="checkbox"/> RMT <input type="checkbox"/> None	<input type="checkbox"/> UNAI, <input type="checkbox"/> UNAI2 <input type="checkbox"/> EXT (3 or 4 digits) <input type="checkbox"/> RMT <input type="checkbox"/> None	<input type="checkbox"/> UNAI, <input type="checkbox"/> UNAI2 <input type="checkbox"/> EXT (3 or 4 digits) <input type="checkbox"/> RMT <input type="checkbox"/> None	CO: Ext. No.
Dial Mode	<input type="checkbox"/> DTMF <input type="checkbox"/> Pulse	<input type="checkbox"/> DTMF <input type="checkbox"/> Pulse	<input type="checkbox"/> DTMF <input type="checkbox"/> Pulse	<input type="checkbox"/> DTMF <input type="checkbox"/> Pulse	<input type="checkbox"/> DTMF <input type="checkbox"/> Pulse	<input type="checkbox"/> DTMF <input type="checkbox"/> Pulse	<input type="checkbox"/> DTMF <input type="checkbox"/> Pulse	<input type="checkbox"/> DTMF <input type="checkbox"/> Pulse	DTMF
DTMF Duration Time	<input type="checkbox"/> 80 mseconds <input type="checkbox"/> 160 mseconds	<input type="checkbox"/> 80 mseconds <input type="checkbox"/> 160 mseconds	<input type="checkbox"/> 80 mseconds <input type="checkbox"/> 160 mseconds	<input type="checkbox"/> 80 mseconds <input type="checkbox"/> 160 mseconds	<input type="checkbox"/> 80 mseconds <input type="checkbox"/> 160 mseconds	<input type="checkbox"/> 80 mseconds <input type="checkbox"/> 160 mseconds	<input type="checkbox"/> 80 mseconds <input type="checkbox"/> 160 mseconds	<input type="checkbox"/> 80 mseconds <input type="checkbox"/> 160 mseconds	80
Use Speed	<input type="checkbox"/> Low (10 pps) <input type="checkbox"/> High (20 pps)	<input type="checkbox"/> Low (10 pps) <input type="checkbox"/> High (20 pps)	<input type="checkbox"/> Low (10 pps) <input type="checkbox"/> High (20 pps)	<input type="checkbox"/> Low (10 pps) <input type="checkbox"/> High (20 pps)	<input type="checkbox"/> Low (10 pps) <input type="checkbox"/> High (20 pps)	<input type="checkbox"/> Low (10 pps) <input type="checkbox"/> High (20 pps)	<input type="checkbox"/> Low (10 pps) <input type="checkbox"/> High (20 pps)	<input type="checkbox"/> Low (10 pps) <input type="checkbox"/> High (20 pps)	---
% Break	060% <input type="checkbox"/> 67%	<input type="checkbox"/> 60% <input type="checkbox"/> 67%	060% 067%	<input type="checkbox"/> 60% <input type="checkbox"/> 67%	060% 067%	060% <input type="checkbox"/> 67%	<input type="checkbox"/> 60% <input type="checkbox"/> 67%	<input type="checkbox"/> 60% <input type="checkbox"/> 67%	
CPC Detection	<input type="checkbox"/> 6.5 mseconds <input type="checkbox"/> 8 x ___/msec. <input type="checkbox"/> None	06.5 mseconds 08 x ___/msec. <input type="checkbox"/> None	<input type="checkbox"/> 6.5 mseconds <input type="checkbox"/> 8 x ___/msec. <input type="checkbox"/> None	<input type="checkbox"/> 6.5 mseconds <input type="checkbox"/> 8 x ___/msec. <input type="checkbox"/> None	<input type="checkbox"/> 6.5 mseconds <input type="checkbox"/> 8 x ___/msec. <input type="checkbox"/> None	<input type="checkbox"/> 6.5 mseconds <input type="checkbox"/> 8 x ___/msec. <input type="checkbox"/> None	<input type="checkbox"/> 6.5 mseconds <input type="checkbox"/> 8 x ___/msec. <input type="checkbox"/> None	<input type="checkbox"/> 6.5 mseconds <input type="checkbox"/> 8 x ___/msec. <input type="checkbox"/> None	50 (400ms)
DID start Arrangement	<input type="checkbox"/> immediate Start <input type="checkbox"/> Send Delay Wink	<input type="checkbox"/> immediate Start <input type="checkbox"/> Send Delay Wink	<input type="checkbox"/> immediate Start <input type="checkbox"/> Send Delay Wink	<input type="checkbox"/> immediate Start <input type="checkbox"/> Send Delay Wink	<input type="checkbox"/> immediate Start <input type="checkbox"/> Send Delay Wink	<input type="checkbox"/> immediate Start <input type="checkbox"/> Send Delay Wink	<input type="checkbox"/> immediate Start <input type="checkbox"/> Send Delay Wink	<input type="checkbox"/> immediate Start <input type="checkbox"/> Send Delay Wink	Send Delay Wink

TRUNK-CO LINE

Item	Trunk Equipment Number								Default Value
Trunk Group	(2 digits: 01 to 16)	(2 digits: 01 to 16)	(2 digits: 01 to 16)	(2 digits: 01 to 16)	(2 digits: 01 to 16)	(2 digits: 01 to 16)	(2 digits: 01 to 16)	(2 digits: 01 to 16)	co: 01 DID: 16
Trunk Name									Txxxx Physical Number
Direct Termination	<input type="checkbox"/> LIN (3 or 4 digits) <input type="checkbox"/> None	<input type="checkbox"/> DN (3 or 4 digits) <input type="checkbox"/> None	<input type="checkbox"/> DN (3 or 4 digits) <input type="checkbox"/> None	<input type="checkbox"/> DN (3 or 4 digits) <input type="checkbox"/> None	<input type="checkbox"/> DN (3 or 4 digits) <input type="checkbox"/> None	<input type="checkbox"/> DN (3 or 4 digits) <input type="checkbox"/> None	<input type="checkbox"/> DN (3 or 4 digits) <input type="checkbox"/> None	<input type="checkbox"/> DN (3 or 4 digits) <input type="checkbox"/> None	CO: Ext. No. with ATLC: blank
Night Answer Point (Type: No.)	<input type="checkbox"/> uNA1 <input type="checkbox"/> luw2 <input type="checkbox"/> EXT (3 or 4 digits) <input type="checkbox"/> RMT <input type="checkbox"/> None	<input type="checkbox"/> UNA1 <input type="checkbox"/> UNA2 <input type="checkbox"/> EXT (3 or 4 digits) <input type="checkbox"/> RMT <input type="checkbox"/> None	<input type="checkbox"/> UNA1 <input type="checkbox"/> UNA2 <input type="checkbox"/> EXT (3 or 4 digits) <input type="checkbox"/> RMT <input type="checkbox"/> None	<input type="checkbox"/> UNA1, <input type="checkbox"/> UNA2 <input type="checkbox"/> EXT (3 or 4 digits) <input type="checkbox"/> RMT <input type="checkbox"/> None	<input type="checkbox"/> uNAi, <input type="checkbox"/> UNA2 <input type="checkbox"/> EXT (3 or 4 digits) <input type="checkbox"/> RMT <input type="checkbox"/> None	<input type="checkbox"/> UNA1, <input type="checkbox"/> UNA2 <input type="checkbox"/> EXT (3 or 4 digits) <input type="checkbox"/> RMT <input type="checkbox"/> None	<input type="checkbox"/> UNA1, <input type="checkbox"/> UNA2 <input type="checkbox"/> EXT (3 or 4 digits) <input type="checkbox"/> RMT <input type="checkbox"/> None	<input type="checkbox"/> UNA1, <input type="checkbox"/> UNA2 <input type="checkbox"/> EXT (3 or 4 digits) <input type="checkbox"/> RMT <input type="checkbox"/> None	CO: Ext. No.
Dial Mode	<input type="checkbox"/> DTMF <input type="checkbox"/> Pulse	<input type="checkbox"/> DTMF <input type="checkbox"/> Pulse	<input type="checkbox"/> DTMF <input type="checkbox"/> Pulse	<input type="checkbox"/> DTMF <input type="checkbox"/> Pulse	<input type="checkbox"/> DTMF <input type="checkbox"/> Pulse	<input type="checkbox"/> DTMF <input type="checkbox"/> Pulse	<input type="checkbox"/> DTMF <input type="checkbox"/> Pulse	<input type="checkbox"/> DTMF <input type="checkbox"/> Pulse	DTMF
DTMF Duration Time	<input type="checkbox"/> 80 mseconds. <input type="checkbox"/> 160 mseconds	<input type="checkbox"/> 80 mseconds <input type="checkbox"/> 160 mseconds	<input type="checkbox"/> 80 mseconds <input type="checkbox"/> 160 mseconds	<input type="checkbox"/> 80 mseconds <input type="checkbox"/> 160 mseconds	<input type="checkbox"/> 80 mseconds <input type="checkbox"/> 160 mseconds	<input type="checkbox"/> 80 mseconds <input type="checkbox"/> 160 mseconds	<input type="checkbox"/> 80 mseconds <input type="checkbox"/> 160 mseconds	<input type="checkbox"/> 80 mseconds <input type="checkbox"/> 160 mseconds	80
Pulse Speed	<input type="checkbox"/> (10 pps) <input type="checkbox"/> (20 pps)	<input type="checkbox"/> (10 pps) <input type="checkbox"/> High (20 pps)	<input type="checkbox"/> LOW (10 pps) <input type="checkbox"/> High (20 pps)	<input type="checkbox"/> (10 pps) <input type="checkbox"/> High (20 pps)	<input type="checkbox"/> LOW (10 pps) <input type="checkbox"/> High (20 pps)	<input type="checkbox"/> LOW (10 pps) <input type="checkbox"/> High (20 pps)	<input type="checkbox"/> Low (10 pps) <input type="checkbox"/> High (20 pps)	<input type="checkbox"/> Low (10 pps) <input type="checkbox"/> High (20 pps)	—
% Break	060% 067%	<input type="checkbox"/> 60% 067%	<input type="checkbox"/> 60% <input type="checkbox"/> 67%	060% 067%	<input type="checkbox"/> 60% <input type="checkbox"/> 67%	060% 067%	060% 067%	060% <input type="checkbox"/> 67%	—
CPC Detection	06.5 mseconds <input type="checkbox"/> 8 x ___ /msec. <input type="checkbox"/> None	06.5 mseconds <input type="checkbox"/> 8 x ___ /msec. <input type="checkbox"/> None	06.5 mseconds <input type="checkbox"/> 8 x ___ /msec. <input type="checkbox"/> None	06.5 mseconds <input type="checkbox"/> 8 x ___ /msec. <input type="checkbox"/> None	06.5 mseconds <input type="checkbox"/> 8 x ___ /msec. <input type="checkbox"/> None	06.5 mseconds <input type="checkbox"/> 8 x ___ /msec. <input type="checkbox"/> None	06.5 mseconds <input type="checkbox"/> 8 x ___ /msec. <input type="checkbox"/> None	<input type="checkbox"/> 6.5 mseconds <input type="checkbox"/> 8 x ___ /msec. <input type="checkbox"/> None	50 (400ms)
DID start Arrangement	<input type="checkbox"/> immediate Start <input type="checkbox"/> Send Delay Wink	<input type="checkbox"/> Immediate Start <input type="checkbox"/> Send Delay Wink	<input type="checkbox"/> immediate Start <input type="checkbox"/> Send delay Wink	<input type="checkbox"/> immediate Start <input type="checkbox"/> Send Delay Wink	<input type="checkbox"/> Immediate Start <input type="checkbox"/> Send Delay Wink	<input type="checkbox"/> Immediate Start <input type="checkbox"/> Send Delay Wink	<input type="checkbox"/> Immediate Start <input type="checkbox"/> Send Delay Wink	<input type="checkbox"/> Immediate Start <input type="checkbox"/> Send Delay Wink	Send Delay Wink

TRUNK-PAGER & MUSIC SOURCE

Item		Tenant		Tone		BGM	
		Set Data	Default Value	Set Data	Default Value	Set Data	Default Value
External Pager	1	<input type="checkbox"/> 1 <input type="checkbox"/> 2	1	<input type="checkbox"/> Yes <input type="checkbox"/> No 0	No	<input type="checkbox"/> Yes <input type="checkbox"/> No	No
	2	<input type="checkbox"/> 1 <input type="checkbox"/> 2	1	<input type="checkbox"/> Yes <input type="checkbox"/> No	No	<input type="checkbox"/> Yes <input type="checkbox"/> No	No
Music Source	1	Tenant		For User			
		Set Data	Default Value	Set Data	Default Value		
	1	<input type="checkbox"/> 1 <input type="checkbox"/> 2	1	<input type="checkbox"/> Hold <input type="checkbox"/> BGM <input type="checkbox"/> Hold & BGM	Hold 8 BGM		
	2	<input type="checkbox"/> 1 <input type="checkbox"/> 2	1	<input type="checkbox"/> Hold <input type="checkbox"/> BGM <input type="checkbox"/> Hold & BGM	Hold & BGM		

Note:
 Press TAB → → External pager → Music source 1

TRUNK-CO LINE

Item	Trunk Equipment Number								Default Value
	(2 digits: 01 to 16)	(2 digits: 01 to 16)	(2 digits: 01 to 16)	(2 digits: 01 to 16)	(2 digits: 01 to 16)	(2 digits: 01 to 16)	(2 digits: 01 to 16)	(2 digits: 01 to 16)	
Trunk Group	(2 digits: 01 to 16)	(2 digits: 01 to 16)	(2 digits: 01 to 16)	(2 digits: 01 to 16)	(2 digits: 01 to 16)	(2 digits: 01 to 16)	(2 digits: 01 to 16)	(2 digits: 01 to 16)	co: 01 DID: 16
Trunk Name	-----	-----	-----	-----	-----	-----	-----	-----	Txxxx Physical Number
Direct Termination	<input type="checkbox"/> DN (3 or 4 digits) <input type="checkbox"/> None	<input type="checkbox"/> BN (3 or 4 digits) <input type="checkbox"/> None	<input type="checkbox"/> DN (3 or 4 digits) <input type="checkbox"/> None	<input type="checkbox"/> DN (3 or 4 digits) <input type="checkbox"/> None	<input type="checkbox"/> DN (3 or 4 digits) <input type="checkbox"/> None	<input type="checkbox"/> DN (3 or 4 digits) <input type="checkbox"/> None	<input type="checkbox"/> DN (3 or 4 digits) <input type="checkbox"/> None	<input type="checkbox"/> DN (3 or 4 digits) <input type="checkbox"/> None	CO: Ext. No. with ATLC: blank
Night Answer Point (Type: No.)	<input type="checkbox"/> uNA1, <input type="checkbox"/> uM2 <input type="checkbox"/> EXT (3 or 4 digits) <input type="checkbox"/> RMT <input type="checkbox"/> None	<input type="checkbox"/> uNA1 <input type="checkbox"/> uNA2 <input type="checkbox"/> EXT (3 or 4 digits) <input type="checkbox"/> RMT <input type="checkbox"/> None	<input type="checkbox"/> luNA1 <input type="checkbox"/> uNA2 <input type="checkbox"/> EXT (3 or 4 digits) <input type="checkbox"/> RMT <input type="checkbox"/> None	<input type="checkbox"/> uNA1, <input type="checkbox"/> uNA2 <input type="checkbox"/> EXT (3 or 4 digits) <input type="checkbox"/> RMT <input type="checkbox"/> None	<input type="checkbox"/> uNA1, <input type="checkbox"/> uNA2 <input type="checkbox"/> EXT (3 or 4 digits) <input type="checkbox"/> RMT <input type="checkbox"/> None	<input type="checkbox"/> luNA1 <input type="checkbox"/> uNA2 <input type="checkbox"/> EXT (3 or 4 digits) <input type="checkbox"/> RMT <input type="checkbox"/> None	<input type="checkbox"/> uNA1 <input type="checkbox"/> uNA2 <input type="checkbox"/> EXT (3 or 4 digits) <input type="checkbox"/> RUT <input type="checkbox"/> None	<input type="checkbox"/> uNA1 <input type="checkbox"/> uNA2 <input type="checkbox"/> EXT (3 or 4 digits) <input type="checkbox"/> \$ITO None	CO: Ext. No
Dial Mode	<input type="checkbox"/> DTMF <input type="checkbox"/> Pulse	<input type="checkbox"/> DTMF <input type="checkbox"/> Pulse	<input type="checkbox"/> DTMF <input type="checkbox"/> Pulse	<input type="checkbox"/> DTMF <input type="checkbox"/> Pulse	<input type="checkbox"/> DTMF <input type="checkbox"/> Pulse	<input type="checkbox"/> DTMF <input type="checkbox"/> Pulse	<input type="checkbox"/> DTMF <input type="checkbox"/> Pulse	<input type="checkbox"/> DTMF <input type="checkbox"/> Pulse	DTMF
DTMF Duration Time	<input type="checkbox"/> 80 mseconds <input type="checkbox"/> 160 mseconds	<input type="checkbox"/> 80 mseconds <input type="checkbox"/> 160 mseconds	<input type="checkbox"/> 80 mseconds <input type="checkbox"/> 160 mseconds	<input type="checkbox"/> 80 mseconds <input type="checkbox"/> 160 mseconds	<input type="checkbox"/> 80 mseconds <input type="checkbox"/> 160 mseconds	<input type="checkbox"/> 80 mseconds <input type="checkbox"/> 160 mseconds	<input type="checkbox"/> 80 mseconds <input type="checkbox"/> 160 mseconds	<input type="checkbox"/> 80 mseconds <input type="checkbox"/> 160 mseconds	80
Pulse Speed	<input type="checkbox"/> Low (10 pps) <input type="checkbox"/> High (20 pps)	<input type="checkbox"/> 10 pps <input type="checkbox"/> 20 pps	<input type="checkbox"/> 10 pps <input type="checkbox"/> High (20 pps)	<input type="checkbox"/> 10 pps <input type="checkbox"/> High (20 pps)	<input type="checkbox"/> Low (10 pps) <input type="checkbox"/> High (20 pps)	<input type="checkbox"/> Low (10 pps) <input type="checkbox"/> High (20 pps)	<input type="checkbox"/> Low (10 pps) <input type="checkbox"/> High (20 pps)	<input type="checkbox"/> Low (10 pps) <input type="checkbox"/> High (20 pps)	—
% Break	<input type="checkbox"/> 60% <input type="checkbox"/> 67%	<input type="checkbox"/> 60% <input type="checkbox"/> 67%	<input checked="" type="checkbox"/> 60% 067%	<input checked="" type="checkbox"/> 80% <input type="checkbox"/> 67%	<input checked="" type="checkbox"/> 60% 067%	<input checked="" type="checkbox"/> 60% 067%	<input checked="" type="checkbox"/> 60% 067%	060% <input type="checkbox"/> 67%	—
CPC Detection	06.5 mseconds <input type="checkbox"/> 8 x ___/msec. <input type="checkbox"/> None	<input type="checkbox"/> 6.5 mseconds <input type="checkbox"/> 8 x ___/msec. <input type="checkbox"/> None	<input type="checkbox"/> 6.5 mseconds <input type="checkbox"/> 8 x ___/msec. <input type="checkbox"/> None	<input type="checkbox"/> 6.5 mseconds <input type="checkbox"/> 8 x ___/msec. <input type="checkbox"/> None	<input type="checkbox"/> 6.5 mseconds <input type="checkbox"/> 8 x ___/msec. <input type="checkbox"/> None	<input type="checkbox"/> 6.5 mseconds <input type="checkbox"/> 8 x ___/msec. <input type="checkbox"/> None	<input type="checkbox"/> 6.5 mseconds <input type="checkbox"/> 8 x ___/msec. <input type="checkbox"/> None	06.5 mseconds <input type="checkbox"/> 8 x ___/msec. <input type="checkbox"/> None	50 (400ms)
DID start Arrangement	<input type="checkbox"/> immediate Start <input type="checkbox"/> Send Delay Wink	<input type="checkbox"/> immediate Start <input type="checkbox"/> Send Delay Wink	<input type="checkbox"/> immediate Stan <input type="checkbox"/> Send Delay Wink	<input type="checkbox"/> Immediate Start <input type="checkbox"/> Send Delay Wink	<input type="checkbox"/> Immediate Stan <input type="checkbox"/> Send Delay Wink	<input type="checkbox"/> immediate Stan <input type="checkbox"/> Send Delay Wink	<input type="checkbox"/> immediate Start <input type="checkbox"/> Send Delay Wink	<input type="checkbox"/> immediate Start <input type="checkbox"/> Send Delay Wink	Send Delay Wink

TRUNK - PAGER & MUSIC SOURCE

Item	Tenant		Tone		BGM		
	Set Data	Default Value	Set Data	Default Value	Set Data	Default Value	
External Pager	1	<input type="checkbox"/> 1 <input type="checkbox"/> 2	1	<input type="checkbox"/> Yes <input type="checkbox"/> No <input type="checkbox"/> Yes	No	<input type="checkbox"/> Yes <input type="checkbox"/> No	No
	2	<input type="checkbox"/> 1 <input type="checkbox"/> 2	1	<input type="checkbox"/> No 0	No	<input type="checkbox"/> Yes <input type="checkbox"/> No	No
Music Source		Tenant		For User			
		Set Data	Default Value	Set Data	Default Value		
	1	<input type="checkbox"/> 1 <input type="checkbox"/> 2	1	<input type="checkbox"/> Hold <input type="checkbox"/> BGM <input type="checkbox"/> Hold 8 BGM	Hold 8 BGM		
	2	<input type="checkbox"/> 1 <input type="checkbox"/> 2	1	<input type="checkbox"/> Hold <input type="checkbox"/> BGM <input type="checkbox"/> Hold & BGM	Hold 8 BGM		

Note:

Press TAB →

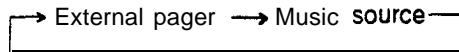

TRUNK-AGC

AGC Card	Shelf No	Slot No.	Set Data	Default Value
			Tenant	
1			<input type="checkbox"/> 1, <input type="checkbox"/> 2	1
2			<input type="checkbox"/> 1, <input type="checkbox"/> 2	
3			<input type="checkbox"/> 1, <input type="checkbox"/> 2	
4			<input type="checkbox"/> 1, <input type="checkbox"/> 2	
Tone Detect:			<input type="checkbox"/> Yes <input type="checkbox"/> No	Yes

Note:

Shelf No.—1 digit (1, 2 or 3)
 Slot No.—2 digits (01 to 15)

6. Extension

EXTENSION-STATION

Item	Selection of Value	Default Value
Telephone Type	SLT PTS CPX	SLC—SLT PLC-PITS HLC-P ITS OPX—OPX
Model	KX-T7020, KX-T7030, KX-T7050 KX-T123220, KX-T123230, KX-T123235 (7130) KX-T123250, KX-T30820, KX-T30830, KX-T30850, KX-T61620, KX-T61630, KX-T61650	KX-T123235 (7130)
OHCA Circuit	Yes/No	No
Primary Directory Number	3 or 4-digit DN	100~
Intercom Number	1 or 2 digits (0 to 99), or blank	blank
Station Name	Within 10-digit alphanumeric characters	blank
ICM Group	1 digit (1 to 8)	1
Pickup Group	2 digits (01 to 32), or None	None
Next Hunt Station	3 or 4 digit DN, or None	None
Class of Service	2 digits (01 to 32)	01: for DN 100 02: for DN except DN * CO
Data Line Security	Yes/No	No
Automatic Callback-Trunk	Yes/No	Yes
Parallel Connect	Yes/No	No
Key Type	PDN, SDN, PRV-CO, OHCA MW, LOGIN , ALARM, SINGLE CO, GROUP CO, DSS(DN) , DSS (ICM) , ONE TOUCH, PRV-CHG, EXT FEAT, CALL PAR. CALL STA, RNG TRAN, SPLIT, TONE-BRK, or blank	PDN for DN-01 blank for the others
Number	3 or 4 digits: directory number for "PDN" , "SDN", "DSS (ON)" 1311 to 3158: physical number for "PRV-CO", *Single CO" 1 or 2 digits: intercom number for "DSS (ICM) " 01 to 16: trunk group number for "Group CO" maximum 16 digits: destination number for "ONE TOUCH"	blank
SDN COS	Station: using COS of own extension DN: using COS of PDN	blank
Day Ring	No ring instantly Delayed. 1 Delayed 3 Delayed 6	blank

(continued)

item	Selection of Value	Default Value
Night Ring	No ring Instantly Delayed 1 Delayed 3 Delayed 6	blank
PF Key Type	DSS (ICM), ONE TOUCH, EXT FEAT, CALL PAR, CALL STA, RGN TRAN, SPLIT, FWD/DND , TONE-BRK, SNR or blank	blank
PF Key Number	maximum 16 digits: destination number for "ONE TOUCH" 1 or 2 digits: intercom number for "DSS (ICM)"	blank
DSS Key Type	MW, LOGIN , ALARM, DSS (DN), DSS (ICM), ONE TOUCH, PRV-CHG. EXT FEAT, CALL PAR, CALL STA, RGN TRAN. SPLIT, TONE-BRK, or blank	blank
DSS Key Number	3 or 4 digits: directory number for 'DSS (DN)' 1 or 2 digits: intercom number for 'DSS (ICM)' maximum 16 digits: destination number for "ONE TOUCH"	blank

EXTENSION-STATION

Station Equipment No.

Item	Set Data
Telephone Type and Model	Type _____ Model _____
OHCA Circuit	<input type="checkbox"/> <input type="checkbox"/>
Primary Directory Number	- - - -
Intercom Number	- -
Station Name	_____
ICM Group	_____
Pickup Group	- - [? None
Next Hunt Station	<input type="checkbox"/> <input type="checkbox"/> <input type="checkbox"/> <input type="checkbox"/> None
Class of Service	- -
Data Line Security	<input type="checkbox"/> <input type="checkbox"/> <input type="checkbox"/> No
Automatic Callback-Trunk	<input type="checkbox"/> <input type="checkbox"/> <input type="checkbox"/> No
Parallel Connect	<input type="checkbox"/> <input type="checkbox"/>

Key	Key Type	Number	SDN COS	Day Ring	Night Ring
DN-01	PDN		<input type="checkbox"/> Station,ODN		
DN-02			<input type="checkbox"/> Station,nDN		
DN-03			<input type="checkbox"/> Station, <input type="checkbox"/> DN		
DN-04			<input type="checkbox"/> Station, <input type="checkbox"/> DN		
DN-05			<input type="checkbox"/> Station, <input type="checkbox"/> DN		
DN-06			<input type="checkbox"/> Station, <input type="checkbox"/> DN		
DN-07			<input type="checkbox"/> Station, <input type="checkbox"/> DN		
DN-08			<input type="checkbox"/> Station,uDN		
DN-09			<input type="checkbox"/> Station,ODN		
DN-10			<input type="checkbox"/>]Station,nDN		
DN-11			<input type="checkbox"/> Station.uDN		
DN-12			<input type="checkbox"/>]Station, <input type="checkbox"/> DN		

PF Key	PF Key Type	Number	DSS Key	DSS Key Type	Number
01			01		
02			02		
03			03		
04			04		
05			05		
06			06		
07			07		
08			08		
09					
10					
11					
12					

EXTENSION-STATION

Station Equipment No.

Item	Set Data
Telephone Type and Model	Type _____ Model _____
OHCA Circuit	<input type="checkbox"/> <input type="checkbox"/>
Primary Directory Number	- - - -
Intercom Number	- -
Station Name	_____
ICM Group	_____
Pickup Group	- - J None
Next Hunt Station	<input type="checkbox"/> EXT <input type="checkbox"/> N o n e
Class of Service	- -
Data Line Security	<input type="checkbox"/> Yes, <input type="checkbox"/>
Automatic Callback-Trunk	<input type="checkbox"/> Yes, <input type="checkbox"/> No
Parallel Connect	<input type="checkbox"/> <input type="checkbox"/>

Key	Key Type	Number	SDN COS	Day Ring	Night Ring
DN-01	PDN		<input type="checkbox"/> Station, <input type="checkbox"/> DN		
DN-02			<input type="checkbox"/> Station, <input type="checkbox"/> DN		
DN-03			<input type="checkbox"/> Station, <input type="checkbox"/> DN		
DN-04			<input type="checkbox"/> Station, <input type="checkbox"/> DN		
DN-05			<input type="checkbox"/> Station, <input type="checkbox"/> DN		
DN-06			<input type="checkbox"/> Station, <input type="checkbox"/> DN		
DN-07			<input type="checkbox"/> Station, <input type="checkbox"/> DN		
DN-08			<input type="checkbox"/> Station, <input type="checkbox"/> DN		
DN-09			<input type="checkbox"/> Station, <input type="checkbox"/> DN		
DN-10			<input type="checkbox"/> Station.ODN		
DN-11			<input type="checkbox"/> Station.C DN		
DN-12			<input type="checkbox"/> tation.nDN		

PF Key	PF Key Type	Number
01		
02		
03		
04		
05		
06		
07		
08		
09		
10		
11		
12		

DSS Key	DSS Key Type	Number
01		
02		
03		
04		
05		
06		
07		
08		

EXTENSION-STATION

Station Equipment No

Item	Set Data
Telephone Type and Model	Type _____ Model _____
OHCA Circuit	<input type="checkbox"/> Yes. <input type="checkbox"/> No
Primary Directory Number	_____
Intercom Number	- -
Station Name	- - - - - A -
ICM Group	_____
Pickup Group	- - <input type="checkbox"/> None
Next Hunt Station	<input type="checkbox"/> EXT <input type="checkbox"/> N o n e
Class of Service	- -
Data Line Security	<input type="checkbox"/> Yes <input type="checkbox"/> No
Automatic Callback-Trunk	<input type="checkbox"/> Yes. <input type="checkbox"/> No
Parallel Connect	<input type="checkbox"/> Yes. <input type="checkbox"/> No

Key	Key Type	Number	SDN COS	Day Ring	Night Ring
DN-01	PDN		<input type="checkbox"/> Station, <input type="checkbox"/> DN		
DN-02			<input type="checkbox"/> Station, <input type="checkbox"/> DN		
DN-03			<input type="checkbox"/> Station, <input type="checkbox"/> DN		
DN-04			<input type="checkbox"/> Station, <input type="checkbox"/> DN		
DN-05			<input type="checkbox"/> Station, <input type="checkbox"/> DN		
DN-06			<input type="checkbox"/> Station, <input type="checkbox"/> DN		
DN-07			<input type="checkbox"/> Station, <input type="checkbox"/> DN		
DN-08			<input type="checkbox"/> Station, <input type="checkbox"/> DN		
DN-09			<input type="checkbox"/> Station, <input type="checkbox"/> DN		
DN-10			<input type="checkbox"/> Station, <input type="checkbox"/> DN		
DN-11			<input type="checkbox"/> Station, <input type="checkbox"/> DN		
DN-12			<input type="checkbox"/> Station, <input type="checkbox"/> DN		

PF Key	PF Key Type	Number
01		
02		
03		
04		
05		
06		
07		
08		
09		
10		
11		
12		

DSS Key	DSS Key Type	Number
01		
02		
03		
04		
05		
06		
07		
08		

EXTENSION-STATION

Station Equipment No.

Item	Set Data
Telephone Type and Model	Type _____ Model _____
OHCA Circuit	<input type="checkbox"/> <input type="checkbox"/> No
Primary Directory Number	_____
Intercom Number	- -
Station Name	_____
ICM Group	_____
Pickup Group	- - <input type="checkbox"/> None
Next Hunt Station	<input type="checkbox"/> _____ <input type="checkbox"/>
Class of Service	- -
Data Line Security	<input type="checkbox"/> Yes, <input type="checkbox"/> No
Automatic Callback-Trunk	<input type="checkbox"/> Yes, <input type="checkbox"/> No
Parallel Connect	<input type="checkbox"/> Yes, <input type="checkbox"/> No

Key	Key Type	Number	SEN COS	Day Ring	Night Ring
DN-01	PDN		<input type="checkbox"/> Station, <input type="checkbox"/> DN		
DN-02			<input type="checkbox"/> Station, <input type="checkbox"/> DN		
DN-03			<input type="checkbox"/> Station, <input type="checkbox"/> DN		
DN-04			<input type="checkbox"/> Station, <input type="checkbox"/> DN		
DN-05			<input type="checkbox"/> Station, <input type="checkbox"/> DN		
DN-06			<input type="checkbox"/> Station, <input type="checkbox"/> DN		
DN-07			<input type="checkbox"/> Station, <input type="checkbox"/> DN		
DN-08			<input type="checkbox"/> Station, <input type="checkbox"/> DN		
DN-09			<input type="checkbox"/> Station, <input type="checkbox"/> DN		
DN-10			<input type="checkbox"/> Station, <input type="checkbox"/> DN		
DN-11			<input type="checkbox"/> Station, <input type="checkbox"/> DN		
DN-12			<input type="checkbox"/> Station, <input type="checkbox"/> DN		

PF Key	PF Key Type	Number
01		
02		
03		
04		
05		
06		
07		
08		
09		
10		
11		
12		

DSS Key	DSS Key Type	Number
01		
02		
03		
04		
05		
06		
07		
08		

EXTENSION-STATION

Station Equipment No.

Item	Set Data
Telephone Type and Model	Type _____ Model _____
OHCA Circuit	<input type="checkbox"/> Yes, <input type="checkbox"/> No <input type="checkbox"/>
Primary Directory Number	- - - - -
Intercom Number	- -
Station Name	_____
ICM Group	_____
Pickup Group	- - <input type="checkbox"/> None
Next Hunt Station	<input type="checkbox"/> <input type="checkbox"/> <input type="checkbox"/> <input type="checkbox"/> <input type="checkbox"/> None
Class of Service	- -
Data Line Security	<input type="checkbox"/> <input type="checkbox"/> <input type="checkbox"/>
Automatic Callback-Trunk	<input type="checkbox"/> <input type="checkbox"/> <input type="checkbox"/> No
Parallel Connect	<input type="checkbox"/> <input type="checkbox"/> <input type="checkbox"/> No

Key	Key Type	Number	SDN COS	Day Ring	Night Ring
DN-01	PDN		<input type="checkbox"/> Station, <input type="checkbox"/> DN		
DN-02			<input type="checkbox"/> Station, <input type="checkbox"/> DN		
DN-03			<input type="checkbox"/> Station, <input type="checkbox"/> DN		
DN-04			<input type="checkbox"/> Station, <input type="checkbox"/> DN		
DN-05			<input type="checkbox"/> Station, <input type="checkbox"/> DN		
DN-06			<input type="checkbox"/> Station, <input type="checkbox"/> DN		
DN-07			<input type="checkbox"/> Station, <input type="checkbox"/> DN		
DN-08			<input type="checkbox"/> Station, <input type="checkbox"/> DN		
DN-09			<input type="checkbox"/> Station, <input type="checkbox"/> DN		
DN-10			<input type="checkbox"/> Station, <input type="checkbox"/> DN		
DN-11			<input type="checkbox"/> Station, <input type="checkbox"/> DN		
DN-12			<input type="checkbox"/> Station, <input type="checkbox"/> DN		

PF Key	PF Key Type	Number
01		
02		
03		
04		
05		
06		
07		
08		
09		
10		
11		
12		

DSS Key	DSS Key Type	Number
01		
02		
03		
04		
05		
06		
07		
08		

EXTENSION-STATION

Station Equipment No.

Item	Set Data
Telephone Type and Model	Type _____ Model _____
OHCA Circuit	<input type="checkbox"/> <input type="checkbox"/> No
Primary Directory Number	- - - - -
Intercom Number	- -
Station Name	- - - - -
ICM Group	—
Pickup Group	- - <input type="checkbox"/> None
Next Hunt Station	<input type="checkbox"/> <input type="checkbox"/> <input type="checkbox"/> <input type="checkbox"/> <input type="checkbox"/> None
Class of Service	- -
Data Line Security	<input type="checkbox"/> <input type="checkbox"/> No
Automatic Callback-Trunk	<input type="checkbox"/> Yes, <input type="checkbox"/> No
Parallel Connect	<input type="checkbox"/> Yes, <input type="checkbox"/> No

Key	Key Type	Number	SDN COS	Day Ring	Night Ring
DN-01	PDN		<input type="checkbox"/> Station, <input type="checkbox"/> DN		
DN-02			<input type="checkbox"/> Station, <input type="checkbox"/> DN		
DN-03			<input type="checkbox"/> Station, <input type="checkbox"/> DN		
DN-04			<input type="checkbox"/> Station, <input type="checkbox"/> DN		
DN-05			<input type="checkbox"/> Station, <input type="checkbox"/> DN		
DN-06			<input type="checkbox"/> Station, <input type="checkbox"/> DN		
DN-07			<input type="checkbox"/> Station, <input type="checkbox"/> DN		
DN-08			<input type="checkbox"/> Station, <input type="checkbox"/> DN		
DN-09			<input type="checkbox"/> Station, <input type="checkbox"/> DN		
DN-10			<input type="checkbox"/> Station, <input type="checkbox"/> DN		
DN-11			<input type="checkbox"/> Station, <input type="checkbox"/> DN		
DN-12			<input type="checkbox"/> Station, <input type="checkbox"/> DN		

PF Key	PF Key Type	Number	DSS Key	DSS Key Type	Number
01			01		
02			02		
03			03		
04			04		
05			05		
06			06		
07			07		
08			08		
09					
10					
11					
12					

EXTENSION-STATION

Station Equipment No.

item	Set Data
Telephone Type and Model	Type _____ Model _____
OHCA Circuit	<input type="checkbox"/> Yes <input type="checkbox"/> No <input type="checkbox"/>
Primary Directory Number	- - - -
Intercom Number	- -
Station Name	_____
ICM Group	_____
Pickup Group	- - <input type="checkbox"/> None
Next Hunt Station	<input type="checkbox"/> _____ <input type="checkbox"/> None
Class of Service	- -
Data Line Security	<input type="checkbox"/> Yes, <input type="checkbox"/> No
Automatic Callback-Trunk	<input type="checkbox"/> Yes, <input type="checkbox"/> No <input type="checkbox"/>
Parallel Connect	<input type="checkbox"/> Yes, <input type="checkbox"/> No

Key	Key Type	Number	SDN COS	Day Ring	Night Ring
ON-01	PDN		<input type="checkbox"/> Station, <input type="checkbox"/> DN		
DN-02			<input type="checkbox"/> Station, nDN		
DN-03			<input type="checkbox"/> Station, <input type="checkbox"/> DN		
DN-04			<input type="checkbox"/> Station, <input type="checkbox"/> DN		
DN-06			<input type="checkbox"/> Station, <input type="checkbox"/> DN		
DN-06			<input type="checkbox"/> Station, nDN		
DN-07			<input type="checkbox"/> Station, <input type="checkbox"/> DN		
DN-08			<input type="checkbox"/> Station, <input type="checkbox"/> DN		
DN-09			<input type="checkbox"/> Station, C)DN		
DN-10			<input type="checkbox"/> Station, nDN		
DN-11			<input type="checkbox"/> Station, nDN		
DN-12			<input type="checkbox"/> Station, <input type="checkbox"/> DN		

PF-Key	PF-Key Type	Number	DSS Key	DSS Key Type	Number
01			01		
02			02		
03			03		
04			04		
05			05		
06			06		
07			07		
08			08		
09					
10					
11					
12					

EXTENSION-STATION

Station Equipment No.

Item	Set Data
Telephone Type and Model	Type _____ Model _____
OHCA Circuit	<input type="checkbox"/> Yes, <input type="checkbox"/> No
Primary Directory Number	_____
Intercom Number	- -
Station Name	_____
ICM Group	_____
Pickup Group	- - - 2 None
Next Hunt Station	<input type="checkbox"/> <input type="checkbox"/> None
Class of Service	- -
Data Line Security	<input type="checkbox"/> Yes, <input type="checkbox"/> No
Automatic Callback-Trunk	<input type="checkbox"/> Yes, <input type="checkbox"/> No
Parallel Connect	<input type="checkbox"/> <input type="checkbox"/> No

Key	Key Type	Number	SDN COS	Day Ring	Night Ring
DN-01	PDN		<input type="checkbox"/> Station, <input type="checkbox"/> DN		
DN-02			<input type="checkbox"/> Station, <input type="checkbox"/> DN		
DN-03			<input type="checkbox"/> Station, <input type="checkbox"/> DN		
DN-04			<input type="checkbox"/> Station, <input type="checkbox"/> DN		
DN-05			<input type="checkbox"/> Station, <input type="checkbox"/> DN		
DN-06			<input type="checkbox"/> Station, <input type="checkbox"/> DN		
DN-07			<input type="checkbox"/> Station, <input type="checkbox"/> DN		
DN-08			<input type="checkbox"/> Station, <input type="checkbox"/> DN		
DN-09			<input type="checkbox"/> Station, <input type="checkbox"/> DN		
DN-10			<input type="checkbox"/> Station, <input type="checkbox"/> DN		
DN-11			<input type="checkbox"/> Station, <input type="checkbox"/> DN		
DN-12			<input type="checkbox"/> Station, <input type="checkbox"/> DN		

PF Key	PF Key Type	Number
01		
02		
03		
04		
05		
06		
07		
08		
09		
10		
11		
12		

DSS Key	DSS Key Type	Number
01		
02		
03		
04		
05		
06		
07		
08		

EXTENSION-STATION

Station Equipment No.

Item	Set Data
Telephone Type and Model	Type _____ Model _____
OHCA Circuit	<input type="checkbox"/> <input type="checkbox"/> <input type="checkbox"/> <input type="checkbox"/>
Primary Directory Number	- - - -
Intercom Number	- -
Station Name	_____
ICM Group	_____
Pickup Group	- - <input type="checkbox"/> None
Next Hunt Station	<input type="checkbox"/> <input type="checkbox"/> <input type="checkbox"/> _____ <input type="checkbox"/> None
Class of Service	- -
Data Line Security	<input type="checkbox"/> <input type="checkbox"/> <input type="checkbox"/> <input type="checkbox"/> <input type="checkbox"/> No
Automatic Callback-Trunk	<input type="checkbox"/> Yes, <input type="checkbox"/> No
Parallel Connect	<input type="checkbox"/> <input type="checkbox"/> <input type="checkbox"/> <input type="checkbox"/>

Key	Key Type	Number	SDN COS	Day Ring	Night Ring
DN-01	PDN		<input type="checkbox"/> Station, <input type="checkbox"/> DN		
DN-02			<input type="checkbox"/> Station, <input type="checkbox"/> DN		
DN-03			<input type="checkbox"/> Station, <input type="checkbox"/> DN		
DN-04			<input type="checkbox"/> Station, <input type="checkbox"/> DN		
DN-05			<input type="checkbox"/> Station, <input type="checkbox"/> DN		
DN-06			<input type="checkbox"/> Station, <input type="checkbox"/> DN		
DN-07			<input type="checkbox"/> Station, <input type="checkbox"/> DN		
DN-08			<input type="checkbox"/> Station, <input type="checkbox"/> DN		
DN-09			<input type="checkbox"/> Station, <input type="checkbox"/> DN		
DN-10			<input type="checkbox"/> Station, <input type="checkbox"/> DN		
DN-11			<input type="checkbox"/> Station, <input type="checkbox"/> DN		
DN-12			<input type="checkbox"/> Station, <input type="checkbox"/> DN		

PF Key	PF Key Type	Number	DSS Key	DSS Key Type	Number
01			01		
02			02		
03			03		
04			04		
05			05		
06			06		
07			07		
08 !			08		
09					
10					
11					
12					

EXTENSION-STATION

Station Equipment No.

Item	Set Data
Telephone Type and Model	Type _____ Model _____
OHCA Circuit	<input type="checkbox"/> Yes, <input type="checkbox"/> No
Primary Directory Number	- - - -
Intercom Number	- -
Station Name	- - - - -
ICM Group	—
Pickup Group	- - <input type="checkbox"/> None
Next Hunt Station	<input type="checkbox"/> EXT - - - - <input type="checkbox"/> None
Class of Service	- -
Data Line Security	<input type="checkbox"/> Yes, <input type="checkbox"/> X <input type="checkbox"/>
Automatic Callback-Trunk	<input type="checkbox"/> Yes, <input type="checkbox"/> X <input type="checkbox"/>
Parallel Connect	<input type="checkbox"/> Yes, <input type="checkbox"/> No

Key	Key Type	Number	SDN COS	Day Ring	Night Ring
DN-01	PDN		<input type="checkbox"/> Station, <input type="checkbox"/> DN		
DN-02			<input type="checkbox"/> Station, <input type="checkbox"/> DN		
DN-03			<input type="checkbox"/> Station, <input type="checkbox"/> DN		
DN-04			<input type="checkbox"/> Station, <input type="checkbox"/> DN		
DN-05			<input type="checkbox"/> Station, <input type="checkbox"/> DN		
DN-06			<input type="checkbox"/> Station, <input type="checkbox"/> DN		
DN-07			<input type="checkbox"/> Station, <input type="checkbox"/> DN		
DN-08			<input type="checkbox"/> Station, <input type="checkbox"/> DN		
DN-09			<input type="checkbox"/> Station, <input type="checkbox"/> DN		
DN-10			<input type="checkbox"/> Station, <input type="checkbox"/> DN		
DN-11			<input type="checkbox"/> Station, <input type="checkbox"/> DN		
DN-12			<input type="checkbox"/> Station, <input type="checkbox"/> DN		

PF Key	PF Key Type	Number
01		
02		
03		
04		
05		
06		
07		
08		
09		
10		
11		
12		

DSS Key	DSS Key Type	Number
01		
02		
03		
04		
05		
06		
07		
08		

EXTENSION-STATION

Station Equipment No.

Item	Set Data
Telephone Type and Model	Type _____ Model _____
OHCA Circuit	<input type="checkbox"/> Yes, <input type="checkbox"/> No
Primary Directory Number	_____
Intercom Number	- -
Station Name	_____
ICM Group	_____
Pickup Group	- - 0 None
Next Hunt Station	<input type="checkbox"/> <input type="checkbox"/> _____ <input type="checkbox"/> None
Class of Service	- -
Data Line Security	<input type="checkbox"/> Yes, <input type="checkbox"/> <input type="checkbox"/>
Automatic Callback-Trunk	<input type="checkbox"/> Yes, <input type="checkbox"/> No
Parallel Connect	<input type="checkbox"/> <input type="checkbox"/> <input type="checkbox"/> <input type="checkbox"/>

Key	Key Type	Number	SDN COS	Day Ring	Night Ring
DN-01	PDN		<input type="checkbox"/> Station, <input type="checkbox"/> DN		
DN-02			<input type="checkbox"/> Station, <input type="checkbox"/> DN		
DN-03			<input type="checkbox"/> Station, <input type="checkbox"/> DN		
DN-04			<input type="checkbox"/> Station, <input type="checkbox"/> DN		
DN-05			<input type="checkbox"/> Station, <input type="checkbox"/> DN		
DN-06			<input type="checkbox"/> Station, <input type="checkbox"/> DN		
DN-07			<input type="checkbox"/> Station, <input type="checkbox"/> DN		
DN-08			<input type="checkbox"/> Station, <input type="checkbox"/> DN		
DN-09			<input type="checkbox"/> Station, <input type="checkbox"/> DN		
DN-10			<input type="checkbox"/> Station, <input type="checkbox"/> DN		
DN-11			<input type="checkbox"/> Station, <input type="checkbox"/> DN		
DN-12			<input type="checkbox"/> Station, <input type="checkbox"/> DN		

PF Key	PF Key Type	Number
01		
02		
03		
04		
05		
06		
07		
08		
09		
10		
11		
12		

DSS Key	DSS Key Type	Number
01		
02		
03		
04		
05		
06		
07		
08		

EXTENSION-STATION

Station Equipment No.

Item	Set Data
Telephone Type and Model	Type _____ Model _____
OHCA Circuit	<input type="checkbox"/> <input type="checkbox"/> No
Primary Directory Number	- - - -
Intercom Number	- -
Station Name	_____
ICM Group	_____
Pickup Group	- - 0 None
Next Hunt Station	<input type="checkbox"/> _____ <input type="checkbox"/> None
Class of Service	- -
Data Line Security	<input type="checkbox"/> Yes, <input type="checkbox"/> <input type="checkbox"/>
Automatic Callback-Trunk	<input type="checkbox"/> Yes, <input type="checkbox"/> No
Parallel Connect	<input type="checkbox"/> Yes, <input type="checkbox"/> No

Key	Key Type	Number	SDN COS	Day Ring	Night Ring
DN-01	PDN		<input type="checkbox"/>]Station,nDN		
DN-02			<input type="checkbox"/> Station, <input type="checkbox"/> DN		
ON-03			<input type="checkbox"/> Station, <input type="checkbox"/> DN		
DN-04			<input type="checkbox"/> Station,nDN		
DN-05			<input type="checkbox"/> Station, <input type="checkbox"/> DN		
DN-06			<input type="checkbox"/> Station,CjDN		
DN-07			<input type="checkbox"/> Station,nDN		
DN-08			<input type="checkbox"/> Station, <input type="checkbox"/> DN		
DN-09			<input type="checkbox"/> Station,nDN		
DN-10			<input type="checkbox"/> Station,nDN		
DN-11			<input type="checkbox"/> Station.ODN		
DN-12			<input type="checkbox"/> Station, <input type="checkbox"/> DN		

PF Key	PF Key Type	Number	DSS Key	DSS Key Type	Number
01			01		
02			02		
03			03		
04			04		
05			05		
06			06		
07			07		
08			08		
09					
10					
11					
12					

EXTENSION-STATION

Station Equipment No.

Item	Set Data
Telephone Type and Model	Type _____ Model _____
OHCA Circuit	<input type="checkbox"/> Yes, <input type="checkbox"/> No
Primary Directory Number	- - - - -
Intercom Number	- - -
Station Name	- - - - -
ICM Group	-
Pickup Group	- - <input type="checkbox"/> None
Next Hunt Station	<input type="checkbox"/> <input type="checkbox"/> <input type="checkbox"/> <input type="checkbox"/> <input type="checkbox"/> <input type="checkbox"/> None
Class of Service	- -
Data Line Security	<input type="checkbox"/> Yes, <input type="checkbox"/> <input type="checkbox"/>
Automatic Callback-Trunk	<input type="checkbox"/> Yes, <input type="checkbox"/> No
Parallel Connect	<input type="checkbox"/> Yes, <input type="checkbox"/> <input type="checkbox"/>

Key	Key Type	Number	SDN COS	Day Ring	Night Ring
DN-01	PDN		<input type="checkbox"/> Station, <input type="checkbox"/> DN		
DN-02			<input type="checkbox"/> Station, <input type="checkbox"/> DN		
DN-03			<input type="checkbox"/> Station, <input type="checkbox"/> DN		
DN-04			<input type="checkbox"/> Station, <input type="checkbox"/> DN		
DN-05			<input type="checkbox"/> Station, <input type="checkbox"/> DN		
DN-06			<input type="checkbox"/> Station, <input type="checkbox"/> DN		
DN-07			<input type="checkbox"/> Station, <input type="checkbox"/> DN		
DN-08			<input type="checkbox"/> Station, <input type="checkbox"/> DN		
DN-09			<input type="checkbox"/> Station, <input type="checkbox"/> DN		
DN-10			<input type="checkbox"/> Station, <input type="checkbox"/> DN		
DN-11			<input type="checkbox"/> Station, <input type="checkbox"/> DN		
DN-12			<input type="checkbox"/> Station, <input type="checkbox"/> ODN		

PF Key	PF Key Type	Number	DSS Key	DSS Key Type	Number
01			01		
02			02		
03			03		
04			04		
05			05		
06			06		
07			07		
08			08		
09					
10					
11					
12					

EXTENSION-STATION

Station Equipment No.

item	Set Data
Telephone Type and Model	Type _____ Model _____
OHCA Circuit	<input type="checkbox"/> Yes, <input type="checkbox"/> <input type="checkbox"/>
Primary Directory Number	- - - -
Intercom Number	- -
Station Name	-----
ICM Group	---
Pickup Group	- - <input type="checkbox"/> None
Next Hunt Station	<input type="checkbox"/> _____ <input type="checkbox"/> None
Class of Service	- -
Data Line Security	<input type="checkbox"/> <input type="checkbox"/> No
Automatic Callback-Trunk	<input type="checkbox"/> <input type="checkbox"/> No
Parallel Connect	<input type="checkbox"/> Yes, <input type="checkbox"/> No

Key	Key Type	Number	SDN COS	Day Ring	Night Ring
DN-01	PDN		<input type="checkbox"/> Station, <input type="checkbox"/> DN		
DN-02			<input type="checkbox"/> Station, <input type="checkbox"/> DN		
DN-03			<input type="checkbox"/> Station, <input type="checkbox"/> DN		
DN-04			<input type="checkbox"/> Station, <input type="checkbox"/> DN		
DN-05			<input type="checkbox"/> Station, <input type="checkbox"/> DN		
DN-06			<input type="checkbox"/> Station, <input type="checkbox"/> DN		
DN-07			<input type="checkbox"/> Station, <input type="checkbox"/> DN		
DN-08			<input type="checkbox"/> Station, <input type="checkbox"/> DN		
DN-09			<input type="checkbox"/> Station, <input type="checkbox"/> DN		
DN-10			<input type="checkbox"/> Station, <input type="checkbox"/> DN		
DN-11			<input type="checkbox"/> Station, <input type="checkbox"/> DN		
DN-12			<input type="checkbox"/> Station, <input type="checkbox"/> DN		

PF Key	PF Key Type	Number	DSS Key	DSS Key Type	Number
01			01		
02			02		
03			03		
04			04		
05			05		
06			06		
07			07		
08			06		
09					
10					
11					
12					

EXTENSION-STATION

Station Equipment No.

Item	Set Data
Telephone Type and Model	Type _____ Model _____
OHCA Circuit	<input type="checkbox"/> Yes <input type="checkbox"/> No
Primary Directory Number	- - - -
Intercom Number	- -
Station Name	_____
ICM Group	_____
Pickup Group	- - <input type="checkbox"/> None
Next Hunt Station	<input type="checkbox"/> EXT _____ <input type="checkbox"/> None
Class of Service	- -
Data Line Security	<input type="checkbox"/> Yes, <input type="checkbox"/> No
Automatic Callback-Trunk	<input type="checkbox"/> Yes, <input type="checkbox"/> No
Parallel Connect	<input type="checkbox"/> Yes, <input type="checkbox"/> No

Key	Key Type	Number	SDN COS	Day Ring	Night Ring
DN-01	PDN		<input type="checkbox"/> Station, <input type="checkbox"/> DN		
DN-02			<input type="checkbox"/> Station, nDN		
DN-03			<input type="checkbox"/> Station, <input type="checkbox"/> DN		
DN-04			<input type="checkbox"/> Station, <input type="checkbox"/> DN		
DN-05			<input type="checkbox"/> Station, <input type="checkbox"/> DN		
DN-06			<input type="checkbox"/> Station, <input type="checkbox"/> DN		
DN-07			<input type="checkbox"/> Station, <input type="checkbox"/> DN		
DN-08			<input type="checkbox"/> Station, <input type="checkbox"/> DN		
DN-09			<input type="checkbox"/> Station, <input type="checkbox"/> DN		
DN-10			<input type="checkbox"/> Station, <input type="checkbox"/> DN		
DN-11			<input type="checkbox"/> Station, <input type="checkbox"/> DN		
DN-12			<input type="checkbox"/> Station, <input type="checkbox"/> DN		

PF Key	PF Key Type	Number	DSS Key	DSS Key Type	Number
01			01		
02			02		
03			03		
04			04		
05			05		
06			06		
07			07		
08			08		
09					
10					
12					

EXTENSION-STATION

Station Equipment No.

item	Set Data
Telephone Type and Model	Type _____ Model _____
OHCA Circuit	<input type="checkbox"/> Yes, <input type="checkbox"/> No
Primary Directory Number	- - - -
Intercom Number	- -
Station Name	_____
ICM Group	_____
Pickup Group	- - <input type="checkbox"/> None
Next Hunt Station	<input type="checkbox"/> EXT <input type="checkbox"/> None _____
Class of Service	- -
Data Line Security	<input type="checkbox"/> Yes, <input type="checkbox"/> <input type="checkbox"/>
Automatic Callback-Trunk	<input type="checkbox"/> Yes, <input type="checkbox"/> No
Parallel Connect	<input type="checkbox"/> <input type="checkbox"/> No

Key	Key Type	Number	SDN COS	Day Ring	Night Ring
DN-01	PDN		<input type="checkbox"/> Station, fIDN		
DN-02			<input type="checkbox"/> Station, <input type="checkbox"/> DN		
DN-03			<input type="checkbox"/> Station, ODN		
DN-04			<input type="checkbox"/> Station, <input type="checkbox"/> DN		
DN-05			<input type="checkbox"/> Station, <input type="checkbox"/> DN		
DN-06			<input type="checkbox"/> Station, uDN		
DN-07	..		<input type="checkbox"/> Station, uDN		
DN-08			<input type="checkbox"/> Station, nDN		
DN-09			<input type="checkbox"/> Station, nDN		
DN-10			<input type="checkbox"/> Station, <input type="checkbox"/> DN		
DN-11			<input type="checkbox"/> Station, ODN		
DN-12			<input type="checkbox"/> Station, ODN		

PF Key	PF Key Type	Number	DSS Key	DSS Key Type	Number
01			01		
02			02		
03			03		
04			04		
05			05		
06			06		
07			07		
08			08		
09					
10					
11					
12					

EXTENSION-STATION

Station Equipment No.

Item	Set Data
Telephone Type and Model	Type_____ Model_____
OHCA Circuit	<input type="checkbox"/> Yes, <input type="checkbox"/> No
Primary Directory Number	- - - -
Intercom Number	- -
Station Name	_____
ICM Group	—
Pickup Group	- - <input type="checkbox"/> None
Next Hunt Station	<input type="checkbox"/> EXT _____ <input type="checkbox"/> None
Class of Service	- -
Data Line Security	<input type="checkbox"/> Yes, <input type="checkbox"/> No
Automatic Callback-Trunk	<input type="checkbox"/> Yes, <input type="checkbox"/> No
Parallel Connect	<input type="checkbox"/> Yes, <input type="checkbox"/> No

Key	Key Type	Number	SDN COS	Day Ring	Night Ring
DN-01	PDN		<input type="checkbox"/> Station, <input type="checkbox"/> DN		
DN-02			<input type="checkbox"/> Station, <input type="checkbox"/> DN		
DN-03			<input type="checkbox"/> Station, <input type="checkbox"/> DN		
DN-04			<input type="checkbox"/> Station, <input type="checkbox"/> DN		
DN-05			<input type="checkbox"/> Station, <input type="checkbox"/> DN		
DN-06			<input type="checkbox"/> Station, <input type="checkbox"/> DN		
DN-07			<input type="checkbox"/> Station, <input type="checkbox"/> DN		
DN-08			<input type="checkbox"/> Station, <input type="checkbox"/> DN		
DN-09			<input type="checkbox"/> Station, <input type="checkbox"/> DN		
DN-10			<input type="checkbox"/> Station, <input type="checkbox"/> DN		
DN-11			<input type="checkbox"/> Station, <input type="checkbox"/> DN		
DN-12			<input type="checkbox"/> Station, <input type="checkbox"/> DN		

PF Key	PF Key Type	Number
01		
02		
03		
04		
05		
06		
07		
08		
09		
10		
11		
12		

DSS Key	DSS Key Type	Number
01		
02		
03		
04		
05		
06		
07		
08		

EXTENSION-STATION

Station Equipment No.

Item	Set Data
Telephone Type and Model	Type _____ Model _____
OHCA Circuit	<input type="checkbox"/> Yes <input checked="" type="checkbox"/> No
Primary Directory Number	- - - -
Intercom Number	- -
Station Name	_____
ICM Group	_____
Pickup Group	- - <input type="checkbox"/> None
Next Hunt Station	<input type="checkbox"/> <input type="checkbox"/> <input type="checkbox"/> <input type="checkbox"/> <input type="checkbox"/> None
Class of Service	- -
Data Line Security	<input type="checkbox"/> <input type="checkbox"/> No
Automatic Callback-Trunk	<input type="checkbox"/> Yes, <input type="checkbox"/> No
Parallel Connect	<input type="checkbox"/> <input type="checkbox"/>

Key	Key Type	Number	SDN COS	Day Ring	Night Ring
DN-01	PDN		<input type="checkbox"/> Station, <input type="checkbox"/> DN		
DN-02			<input type="checkbox"/> Station, <input type="checkbox"/> DN		
DN-03			<input type="checkbox"/> Station, <input type="checkbox"/> DN		
DN-04			<input type="checkbox"/> Station, <input type="checkbox"/> DN		
DN-05			<input type="checkbox"/> Station, <input type="checkbox"/> DN		
DN-06			<input type="checkbox"/> Station, <input type="checkbox"/> DN		
DN-07			<input type="checkbox"/> Station, <input type="checkbox"/> DN		
DN-08			<input type="checkbox"/> Station, <input type="checkbox"/> DN		
DN-09			<input type="checkbox"/> Station, <input type="checkbox"/> DN		
DN-10			<input type="checkbox"/> Station, <input type="checkbox"/> DN		
DN-11			<input type="checkbox"/> Station, <input type="checkbox"/> DN		
DN-12			<input type="checkbox"/> Station, <input type="checkbox"/> DN		

PF Key	PF Key Type	Number
01		
02		
03		
04		
05		
06		
07		
08		
09		
10		
11		
12		

DSS Key	DSS Key Type	Number
01		
02		
03		
04		
05		
06		
07		
08		

EXTENSION-STATION

Station Equipment No.

Item	Set Data
Telephone Type and Model	Type _____ Model _____
OHCA Circuit	<input type="checkbox"/> <input type="checkbox"/> <input type="checkbox"/> <input type="checkbox"/>
Primary Directory Number	_____
Intercom Number	_____
Station Name	_____
ICM Group	_____
Pickup Group	_____ 0 None
Next Hunt Station	<input type="checkbox"/> EXT _____ <input type="checkbox"/> None
Class of Service	_____
Data Line Security	<input type="checkbox"/> <input type="checkbox"/> <input type="checkbox"/>
Automatic Callback-Trunk	<input type="checkbox"/> Yes, <input type="checkbox"/> <input type="checkbox"/>
Parallel Connect	<input type="checkbox"/> <input type="checkbox"/> <input type="checkbox"/>

Key	Key Type	Number	SDN COS	Day Ring	Night Ring
DN-01	PDN		<input type="checkbox"/> Station, <input type="checkbox"/> DN		
DN-02			<input type="checkbox"/> Station, <input type="checkbox"/> ODN		
DN-03			<input type="checkbox"/> Station, <input type="checkbox"/> DN		
DN-04			<input type="checkbox"/> Station, <input type="checkbox"/> DN		
DN-05			<input type="checkbox"/> Station, <input type="checkbox"/> DN		
DN-06			<input type="checkbox"/> Station, <input type="checkbox"/> DN		
DN-07			<input type="checkbox"/> Station, <input type="checkbox"/> uDN		
DN-08			<input type="checkbox"/> Station, <input type="checkbox"/> jDN		
DN-09			<input type="checkbox"/> Station, <input type="checkbox"/> DN		
DN-10			<input type="checkbox"/> Station, <input type="checkbox"/> uDN		
DN-11			<input type="checkbox"/> Station, <input type="checkbox"/> aDN		
DN-12			<input type="checkbox"/> Station, <input type="checkbox"/> nDN		

PF Key	PF Key Type	Number	DSS Key	DSS Key Type	Number
01			01		
02			02		
03			03		
04			04		
05			05		
06			06		
07			07		
08			08		
09					
10					
11					
12					

EXTENSION-STATION

Station Equipment No.

Item	Set Data
Telephone Type and Model	Type _____ Model _____
OHCA Circuit	<input type="checkbox"/> Yes, <input type="checkbox"/> No
Primary Directory Number	- - - -
Intercom Number	- -
Station Name	-----
ICM Group	---
Pickup Group	- - 0 None
Next Hunt Station	<input type="checkbox"/> EXT <input type="checkbox"/> N o n e
Class of Service	- -
Data Line Security	<input type="checkbox"/> Yes, <input type="checkbox"/> No
Automatic Callback-Trunk	<input type="checkbox"/> Yes, <input type="checkbox"/> No
Parallel Connect	<input type="checkbox"/> <input type="checkbox"/> <input type="checkbox"/> <input type="checkbox"/> No

Key	Key Type	Number	SDN COS	Day Ring	Night Ring
DN-01	PDN		<input type="checkbox"/> Station,uDN		
DN-02			<input type="checkbox"/> Station,nDN		
DN-03			<input type="checkbox"/> Station,ODN		
<input type="checkbox"/> N-04			<input type="checkbox"/> Station, <input type="checkbox"/> DN		
DN-05			<input type="checkbox"/> Station,ODN		
DN-06			<input type="checkbox"/> Station, <input type="checkbox"/> DN		
DN-07			<input type="checkbox"/> Station, <input type="checkbox"/> DN		
DN-08			<input type="checkbox"/> Station, <input type="checkbox"/> DN		
DN-09			<input type="checkbox"/> Station, <input type="checkbox"/> DN		
DN-10			<input type="checkbox"/> Station, <input type="checkbox"/> DN		
DN-11			<input type="checkbox"/> Station, <input type="checkbox"/> DN		
DN-12			<input type="checkbox"/> Station, <input type="checkbox"/> DN		

PF Key	PF Key Type	Number
01		
02		
03		
04		
05		
06		
07		
08		
09		
10		
11		
12		

DSS Key	DSS Key Type	Number
01		
02		
03		
04		
05		
06		
07		
08		

EXTENSION-STATION

Station Equipment No.

Item	Set Data
Telephone Type and Model	Type _____ Model _____
OHCA Circuit	<input type="checkbox"/> Yes, <input type="checkbox"/> No
Primary Directory Number	- - - -
Intercom Number	- -
Station Name	_____
ICM Group	_____
Pickup Group	- - -J None
Next Hunt Station	<input type="checkbox"/> IEXT _____ <input type="checkbox"/> None
Class of Service	- -
Data Line Security	<input type="checkbox"/> Yes, <input type="checkbox"/> No
Automatic Callback-Trunk	<input type="checkbox"/> Yes, <input type="checkbox"/> No
Parallel Connect	<input type="checkbox"/> <input type="checkbox"/> <input type="checkbox"/> <input type="checkbox"/> <input type="checkbox"/> No

Key	Key Type	Number	SDN COS	Day Ring	Night Ring
DN-01	PDN		<input type="checkbox"/> Station, C DN		
DN-02			<input type="checkbox"/> Station, <input type="checkbox"/> DN		
DN-03			<input type="checkbox"/> Station, <input type="checkbox"/> DN		
DN-04			<input type="checkbox"/> Station, <input type="checkbox"/> DN		
DN-05			<input type="checkbox"/> Station, <input type="checkbox"/> DN		
DN-06			<input type="checkbox"/> Station, <input type="checkbox"/> DN		
DN-07			<input type="checkbox"/> Station, <input type="checkbox"/> DN		
DN-08			<input type="checkbox"/> Station, <input type="checkbox"/> DN		
DN-09			<input type="checkbox"/> Station, ODN		
DN-10			<input type="checkbox"/> Station, nDN		
DN-11			<input type="checkbox"/> Station, ODN		
DN-12			<input type="checkbox"/> Station, ODN		

PF Key	PF Key Type	Number	DSS Key	DSS Key Type	Number
01			01		
02			02		
03			03		
04			04		
05			05		
06			06		
07			07		
08			08		
09					
10					
11					
12					

EXTENSION-STATION

Station Equipment No.

Item	Set Data
Telephone Type and Model	Type _____ Model _____
OHCA Circuit	<input type="checkbox"/> <input type="checkbox"/>
Primary Directory Number	_____
Intercom Number	- -
Station Name	- - - - -
ICM Group	_____
Pickup Group	- - <input type="checkbox"/> None
Next Hunt Station	<input type="checkbox"/> _____ <input type="checkbox"/> None
Class of Service	- -
Data Line Security	<input type="checkbox"/> <input type="checkbox"/>
Automatic Callback-Trunk	<input type="checkbox"/> Yes, <input type="checkbox"/> N3
Parallel Connect	<input type="checkbox"/> <input type="checkbox"/> <input type="checkbox"/> No

Key	Key Type	Number	SDN COS	Day Ring	Night Ring
DN-01	PDN		<input type="checkbox"/> Station, <input type="checkbox"/> DN		
DN-02			<input type="checkbox"/> Station, <input type="checkbox"/> DN		
DN-03			<input type="checkbox"/> Station, <input type="checkbox"/> DN		
DN-04			<input type="checkbox"/> Station, <input type="checkbox"/> DN		
DN-05			<input type="checkbox"/> Station, <input type="checkbox"/> DN		
DN-06			<input type="checkbox"/> Station, <input type="checkbox"/> DN		
DN-07			<input type="checkbox"/> Station, <input type="checkbox"/> DN		
DN-08			<input type="checkbox"/> Station, <input type="checkbox"/> DN		
DN-09			<input type="checkbox"/> Station, <input type="checkbox"/> DN		
DN-10			<input type="checkbox"/> Station, <input type="checkbox"/> DN		
DN-11			<input type="checkbox"/> Station, <input type="checkbox"/> DN		
DN-12			<input type="checkbox"/> Station, <input type="checkbox"/> DN		

PF Key	PF Key Type	Number
01		
02		
03		
04		
05		
06		
07		
08		
09		
10		
11		
12		

DSS Key	DSS Key Type	Number
01		
02		
03		
04		
05		
06		
07		
08		

EXTENSION-STATION

Station Equipment No.

Item	Set Data
Telephone Type and Model	Type _____ Model _____
OHCA Circuit	<input type="checkbox"/> <input type="checkbox"/>
Primary Directory Number	_____
Intercom Number	_____
Station Name	_____
ICM Group	_____
Pickup Group	_____ <input type="checkbox"/> None
Next Hunt Station	<input type="checkbox"/> EXT <input type="checkbox"/> None _____
Class of Service	_____
Data Line Security	<input type="checkbox"/> <input type="checkbox"/>
Automatic Callback-Trunk	<input type="checkbox"/> <input type="checkbox"/>
Parallel Connect	<input type="checkbox"/> <input type="checkbox"/> No

Key	Key Type	Number	SDN COS	Day Ring	Night Ring
DN-01	PDN		<input type="checkbox"/> Station, <input type="checkbox"/> DN		
DN-02			<input type="checkbox"/> Station, <input type="checkbox"/> DN		
DN-03			<input type="checkbox"/> Station, <input type="checkbox"/> DN		
DN-04			<input type="checkbox"/> Station, <input type="checkbox"/> DN		
DN-05			<input type="checkbox"/> Station, <input type="checkbox"/> DN		
DN-06			<input type="checkbox"/> Station, <input type="checkbox"/> DN		
DN-07			<input type="checkbox"/> Station, <input type="checkbox"/> DN		
DN-08			<input type="checkbox"/> Station, <input type="checkbox"/> DN		
DN-09			<input type="checkbox"/> Station, <input type="checkbox"/> DN		
DN-10			<input type="checkbox"/> Station, <input type="checkbox"/> DN		
DN-11			<input type="checkbox"/> Station, <input type="checkbox"/> DN		
DN-12			<input type="checkbox"/> Station, <input type="checkbox"/> DN		

PF Key	PF Key Type	Number
01		
02		
03		
04		
05		
06		
07		
08		
09		
10		
11		
12		

DSS Key	DSS Key Type	Number
01		
02		
03		
04		
05		
06		
07		
08		

EXTENSION-STATION

Station Equipment No.

Item	Set Data
Telephone Type and Model	Type _____ Model _____
OHCA Circuit	<input type="checkbox"/> Yes, <input type="checkbox"/> No
Primary Directory Number	- - - -
Intercom Number	- -
Station Name	_____
ICM Group	_____
Pickup Group	- - 0 None
Next Hunt Station	<input type="checkbox"/> EXT - - - - <input type="checkbox"/> None
Class of Service	- -
Data Line Security	<input type="checkbox"/> Yes, <input type="checkbox"/> No
Automatic Callback-Trunk	<input type="checkbox"/> Yes, <input type="checkbox"/> No
Parallel Connect	<input type="checkbox"/> Yes, <input type="checkbox"/> No

Key	Key Type	Number	SDN COS	Day Ring	Night Ring
DN-01	PDN		<input type="checkbox"/> Station, <input type="checkbox"/> DN		
DN-02			<input type="checkbox"/> Station, <input type="checkbox"/> DN		
DN-03			<input type="checkbox"/> Station, <input type="checkbox"/> DN		
DN-04			<input type="checkbox"/> Station, <input type="checkbox"/> DN		
DN-05			<input type="checkbox"/> Station, <input type="checkbox"/> DN		
DN-06			<input type="checkbox"/> Station, <input type="checkbox"/> DN		
DN-07			<input type="checkbox"/> Station, <input type="checkbox"/> DN		
DN-08			<input type="checkbox"/> Station, <input type="checkbox"/> DN		
DN-09			<input type="checkbox"/> Station, <input type="checkbox"/> DN		
DN-10			<input type="checkbox"/> Station, <input type="checkbox"/> DN		
DN-11			<input type="checkbox"/> Station, <input type="checkbox"/> DN		
DN-12			<input type="checkbox"/> Station, <input type="checkbox"/> DN		

PF Key	PF Key Type	Number	DSS Key	DSS Key Type	Number
01			01		
02			02		
03			03		
04			04		
05			05		
06			06		
07			07		
08			08		
09					
10					
11					
12					

EXTENSION-STATION

Station Equipment No.

Item	Set Data
Telephone Type and Model	Type _____ Model _____
OHCA Circuit	<input type="checkbox"/> <input type="checkbox"/> No
Primary Directory Number	_____
Intercom Number	_____
Station Name	_____
ICM Group	_____
Pickup Group	_____ <input type="checkbox"/> None
Next Hunt Station	<input type="checkbox"/> <input type="checkbox"/> <input type="checkbox"/> <input type="checkbox"/> None
Class of Service	_____
Data Line Security	<input type="checkbox"/> Yes, <input type="checkbox"/>
Automatic Callback-Trunk	<input type="checkbox"/> <input type="checkbox"/> No
Parallel Connect	<input type="checkbox"/> <input type="checkbox"/>

Key	Key Type	Number	SDN COS	Day Ring	Night Ring
DN-01	PDN		<input type="checkbox"/> Station, <input type="checkbox"/> DN		
DN-02			<input type="checkbox"/> Station, <input type="checkbox"/> DN		
DN-03			<input type="checkbox"/> Station, <input type="checkbox"/> DN		
DN-04			<input type="checkbox"/> Station, <input type="checkbox"/> DN		
DN-05			<input type="checkbox"/> Station, <input type="checkbox"/> DN		
DN-06			<input type="checkbox"/> Station, <input type="checkbox"/> DN		
DN-07			<input type="checkbox"/> Station, <input type="checkbox"/> DN		
DN-08			<input type="checkbox"/> Station, <input type="checkbox"/> DN		
DN-09			<input type="checkbox"/> Station, <input type="checkbox"/> DN		
DN-10			<input type="checkbox"/> Station, <input type="checkbox"/> DN		
DN-11			<input type="checkbox"/> Station, <input type="checkbox"/> DN		
DN-12			<input type="checkbox"/> Station, <input type="checkbox"/> DN		

PF Key	PF Key Type	Number	DSS Key	DSS Key Type	Number
01			01		
02			02		
03			03		
04			04		
05			05		
06			06		
07			07		
08			08		
09					
10					
11					
12					

EXTENSION-STATION

Station Equipment No.

Item	Set Data
Telephone Type and Model	Type _____ Model. _____
OHCA Circuit	<input type="checkbox"/> Yes, <input type="checkbox"/> <input type="checkbox"/>
Primary Directory Number	_____
Intercom Number	_____
Station Name	_____
ICM Group	_____
Pickup Group	_____ <input type="checkbox"/> None
Next Hunt Station	<input type="checkbox"/> <input type="checkbox"/> None
Class of Service	_____
Data Line Security	<input type="checkbox"/> <input type="checkbox"/>
Automatic Callback-Trunk	<input type="checkbox"/> Yes, <input type="checkbox"/> <input type="checkbox"/>
Parallel Connect	<input type="checkbox"/> <input type="checkbox"/>

Key	Key Type	Number	SDN	COS	Day Ring	Night Ring
ON-01	PDN		<input type="checkbox"/>	Station, <input type="checkbox"/> DN		
ON-02			<input type="checkbox"/>	Station, <input type="checkbox"/> DN		
ON-03			<input type="checkbox"/>	Station, nDN		
ON-04			<input type="checkbox"/>	Station, <input type="checkbox"/> DN		
ON-05			<input type="checkbox"/>	Station, <input type="checkbox"/> DN		
ON-06			<input type="checkbox"/>	Station, <input type="checkbox"/> DN		
ON-07			<input type="checkbox"/>	Station, <input type="checkbox"/> DN		
ON-08			<input type="checkbox"/>	Station, <input type="checkbox"/> DN		
ON-09			<input type="checkbox"/>	jStation, nDN		
ON-10			<input type="checkbox"/>	Station, <input type="checkbox"/> DN		
ON-11			<input type="checkbox"/>	Station, uDN		
ON-12			<input type="checkbox"/>	Station, <input type="checkbox"/> DN		

PF Key	PF Key Type	Number	DSS Key	DSS Key Type	Number
01			01		
02			02		
03			03		
04			04		
05			05		
06			06		
07			07		
08			08		
09					
10					
11					
12					

EXTENSION-STATION

Station Equipment No.

Item	Set Data
Telephone Type and Model	Type _____ Model _____
OHCA Circuit	<input type="checkbox"/> Yes, <input type="checkbox"/> Yes
Primary Directory Number	- - - -
Intercom Number	- -
Station Name	_____
ICM Group	_____
Pickup Group	- - <input type="checkbox"/> None
Next Hunt Station	<input type="checkbox"/> Yes _____ <input type="checkbox"/> None
Class of Service	- -
Data Line Security	<input type="checkbox"/> Yes, <input type="checkbox"/> Yes
Automatic Callback-Trunk	<input type="checkbox"/> Yes, <input type="checkbox"/> No
Parallel Connect	<input type="checkbox"/> Yes <input type="checkbox"/> No

Key	Key Type	Number	SDNCOS	Day Ring	Night Ring
DN-01	PDN		<input type="checkbox"/> Station, <input type="checkbox"/> DN		
DN-02			<input type="checkbox"/> Station, <input type="checkbox"/> DN		
DN-03			<input type="checkbox"/> Station, <input type="checkbox"/> DN		
DN-04			<input type="checkbox"/> Station, <input type="checkbox"/> DN		
DN-05			<input type="checkbox"/> Station, <input type="checkbox"/> DN		
DN-06			<input type="checkbox"/> Station, <input type="checkbox"/> DN		
DN-07			<input type="checkbox"/> Station, <input type="checkbox"/> DN		
DN-08			<input type="checkbox"/> Station, <input type="checkbox"/> DN		
DN-09			<input type="checkbox"/> Station, <input type="checkbox"/> DN		
DN-10			<input type="checkbox"/> Station, <input type="checkbox"/> DN		
DN-11			<input type="checkbox"/> Station, <input type="checkbox"/> DN		
DN-12			<input type="checkbox"/> Station, <input type="checkbox"/> DN		

PF Key	PF Key Type	Number	DSS Key	DSS Key Type	Number
01			01		
02			02		
03			03		
04			04		
05			05		
08			06		
07			07		
08			08		
09					
10					
11					
12					

EXTENSION-STATION

Station Equipment No.

Item	Set Data
Telephone Type and Model	Type _____ Model _____
OHCA Circuit	<input type="checkbox"/> Yes, <input type="checkbox"/> No
Primary Directory Number	- - - -
Intercom Number	- -
Station Name	- - - - - - - - - -
ICM Group	_____
Pickup Group	- - <input type="checkbox"/> None
Next Hunt Station	<input type="checkbox"/> _____ <input type="checkbox"/> None
Class of Service	- -
Data Line Security	<input type="checkbox"/> <input type="checkbox"/> No
Automatic Callback-Trunk	<input type="checkbox"/> <input type="checkbox"/> No
Parallel Connect	<input type="checkbox"/> <input type="checkbox"/> No

Key	Key Type	Number	SDN COS	Day Ring	Night Ring
DN-01	PDN		<input type="checkbox"/> Station, <input type="checkbox"/> DN		
DN-02			<input type="checkbox"/> Station, <input type="checkbox"/> DN		
DN-03			<input type="checkbox"/> Station, <input type="checkbox"/> DN		
DN-04			<input type="checkbox"/> Station, <input type="checkbox"/> DN		
DN-05			<input type="checkbox"/> Station, <input type="checkbox"/> DN		
DN-06			<input type="checkbox"/> Station, <input type="checkbox"/> DN		
DN-07			<input type="checkbox"/> Station, <input type="checkbox"/> DN		
DN-08			<input type="checkbox"/> Station, <input type="checkbox"/> DN		
DN-09			<input type="checkbox"/> Station, <input type="checkbox"/> DN		
DN-10			<input type="checkbox"/> Station, <input type="checkbox"/> DN		
DN-11			<input type="checkbox"/> Station, <input type="checkbox"/> DN		
DN-12			<input type="checkbox"/> Station, <input type="checkbox"/> DN		

PF Key	PF Key Type	Number
01		
02		
03		
04		
05		
06		
07		
08		
09		
10		
11		
12		

DSS Key	DSS Key Type	Number
01		
02		
03		
04		
05		
06		
07		
08		

EXTENSION-STATION

Station Equipment No.

Item	Set Data
Telephone Type and Model	Type _____ Model _____
OHCA Circuit	<input type="checkbox"/> <input type="checkbox"/> No
Primary Directory Number	_____
Intercom Number	_____
Station Name	_____
ICM Group	-
Pickup Group	- - <input type="checkbox"/> None
Next Hunt Station	<input type="checkbox"/> <input type="checkbox"/> <input type="checkbox"/> None
Class of Service	_____
Data Line Security	<input type="checkbox"/> <input type="checkbox"/> No
Automatic Callback-Trunk	<input type="checkbox"/> <input type="checkbox"/> No
Parallel Connect	<input type="checkbox"/> <input type="checkbox"/> No

Key	Key Type	Number	SDN COS	Day Ring	Night Ring
DN-01	PDN		<input type="checkbox"/>]Station,ODN		
DN-02			<input type="checkbox"/> Station, <input type="checkbox"/> DN		
DN-03			<input type="checkbox"/> Station, <input type="checkbox"/> DN		
DN-04			<input type="checkbox"/> Station,fJDN		
DN-05			<input type="checkbox"/> Station,ODN		
DN-06			<input type="checkbox"/> Station <input type="checkbox"/> DN		
DN-07			<input type="checkbox"/> Station <input type="checkbox"/> DN		
DN-08			<input type="checkbox"/> Station,nDN		
DN-09			<input type="checkbox"/> Station, <input type="checkbox"/> DN		
DN-10			<input type="checkbox"/> Station.nDN		
DN-11			<input type="checkbox"/> Station <input type="checkbox"/> DN		
DN-12			<input type="checkbox"/> Station <input type="checkbox"/> DN		

PF Key	PF Key Type	Number	DSS Key	DSS Key Type	Number
01			01		
02			02		
03			03		
04			04		
05			05		
06			06		
07			07		
08			08		
09					
10					
11					
12					

EXTENSION-STATION

Station Equipment No.

Item	Set Data
Telephone Type and Model	Type _____ Model _____
OHCA Circuit	<input type="checkbox"/> Yes, <input type="checkbox"/> No
Primary Directory Number	_____
Intercom Number	_____
Station Name	_____
ICM Group	_____
Pickup Group	_____ <input type="checkbox"/> None
Next Hunt Station	<input type="checkbox"/> EXT <input type="checkbox"/> None
Class of Service	_____
Data Line Security	_____ <input type="checkbox"/> No
Automatic Callback-Trunk	<input type="checkbox"/> Yes, <input type="checkbox"/> No
Parallel Connect	<input type="checkbox"/> Yes, <input type="checkbox"/> No

Key	Key Type	Number	SDN COS	Day Ring	Night Ring
DN-01	PDN		<input type="checkbox"/> Station, ODN		
DN-02			<input type="checkbox"/> Station, ODN		
DN-03			<input type="checkbox"/> Station, <input type="checkbox"/> DN		
DN-04			<input type="checkbox"/> Station, <input type="checkbox"/> DN		
DN-05			<input type="checkbox"/> Station, ODN		
DN-06			<input type="checkbox"/> Station, <input type="checkbox"/> DN		
DN-07			<input type="checkbox"/> Station, <input type="checkbox"/> DN		
DN-08			<input type="checkbox"/> Station, ODN		
DN-09			<input type="checkbox"/> Station, <input type="checkbox"/> DN		
DN-10			<input type="checkbox"/> Station, <input type="checkbox"/> DN		
DN-11			<input type="checkbox"/> Station, nDN		
DN-12			<input type="checkbox"/> Station, <input type="checkbox"/> DN		

PF Key	PF Key Type	Number	DSS Key	DSS Key Type	Number
01			01		
02			02		
03			03		
	04		04		
	05		05		
06			06		
07			07		
08			08		
09					
10					
11					
12					

EXTENSION-STATION

Station Equipment No.

item	Set Data				
Telephone Type and Model	Type _____ Model _____				
OHCA Circuit	<input type="checkbox"/> Yes, <input type="checkbox"/> No				
Primary Directory Number	- - - - -				
Intercom Number	- - -				
Station Name	- - - - -				
ICM Group	-				
Pickup Group	- - - 0 None				
Next Hunt Station	<input type="checkbox"/> None				
Class of Service	- - -				
Data Line Security	<input type="checkbox"/> Yes, <input type="checkbox"/> No				
Automatic Callback-Trunk	<input type="checkbox"/> Yes, <input type="checkbox"/> No				
Parallel Connect	<input type="checkbox"/> Yes, <input type="checkbox"/> No				

Key	Key Type	Number	SDN COS	Day Ring	Night Ring
DN-01	PDN		<input type="checkbox"/> Station, <input type="checkbox"/> DN		
DN-02			<input type="checkbox"/> Station, <input type="checkbox"/> DN		
DN-03			<input type="checkbox"/> Station, <input type="checkbox"/> DN		
DN-04			<input type="checkbox"/> Station, <input type="checkbox"/> DN		
DN-05			<input type="checkbox"/> Station, <input type="checkbox"/> DN		
DN-06			<input type="checkbox"/> Station, <input type="checkbox"/> DN		
DN-07			<input type="checkbox"/> Station, <input type="checkbox"/> DN		
DN-08			<input type="checkbox"/> Station, <input type="checkbox"/> DN		
DN-09			<input type="checkbox"/> Station, <input type="checkbox"/> DN		
DN-10			<input type="checkbox"/> Station, <input type="checkbox"/> DN		
DN-11			<input type="checkbox"/> Station, <input type="checkbox"/> DN		
DN-12			<input type="checkbox"/> Station, <input type="checkbox"/> DN		

PF Key	PF Key Type	Number	DSS Key	DSS Key Type	Number
0			01		
02			02		
03			03		
04			04		
05			05		
06			06		
07			07		
08			08		
09					
10					
11					
12					

EXTENSION-STATION

Station Equipment No.

Item	Set Data
Telephone Type and Model	Type _____ Model _____
OHCA Circuit	<input type="checkbox"/> Yes, <input type="checkbox"/> No
Primary Directory Number	_____
Intercom Number	_____
Station Name	-----
ICM Group	_____
Pickup Group	- - <input type="checkbox"/> None
Next Hunt Station	<input type="checkbox"/> EXT _____ <input type="checkbox"/> None
Class of Service	- -
Data Line Security	a y e s , <input type="checkbox"/> No
Automatic Callback-Trunk	<input type="checkbox"/> Yes, <input type="checkbox"/> No
Parallel Connect	<input type="checkbox"/> Yes, <input type="checkbox"/> <input type="checkbox"/>

Key	Key Type	Number	SDN COS	Day Ring	Night Ring
DN-01	PDN		<input type="checkbox"/> Station, <input type="checkbox"/> DN		
DN-02			<input type="checkbox"/> Station, <input type="checkbox"/> DN		
DN-03			<input type="checkbox"/> Station, <input type="checkbox"/> DN		
DN-04			<input type="checkbox"/> Station, <input type="checkbox"/> DN		
DN-05			<input type="checkbox"/> Station, <input type="checkbox"/> DN		
DN-06			<input type="checkbox"/> Station, <input type="checkbox"/> DN		
DN-07			<input type="checkbox"/> Station, <input type="checkbox"/> DN		
DN-08			<input type="checkbox"/> Station, <input type="checkbox"/> DN		
DN-09			<input type="checkbox"/> Station, <input type="checkbox"/> DN		
DN-10			<input type="checkbox"/> Station, <input type="checkbox"/> DN		
DN-11			<input type="checkbox"/> Station, <input type="checkbox"/> DN		
DN-12			<input type="checkbox"/> Station, <input type="checkbox"/> DN		

PF Key	PF Key Type	Number
01		
02		
03		
04		
05		
06		
07		
08		
09		
10		
11		
12		

DSS Key	DSS Key Type	Number
01		
02		
03		
04		
05		
06		
07		
08		

EXTENSION-STATION

Station Equipment No.

Item	Set Data
Telephone Type and Model	Type _____ Model _____
OHCA Circuit	<input type="checkbox"/> Yes <input type="checkbox"/> <input type="checkbox"/>
Primary Directory Number	- - - -
Intercom Number	- -
Station Name	_____
ICM Group	_____
Pickup Group	- - <input type="checkbox"/> None
Next Hunt Station	<input type="checkbox"/> _____ <input type="checkbox"/> None
Class of Service	- -
Data Line Security	<input type="checkbox"/> Yes, <input type="checkbox"/> No
Automatic Callback-Trunk	<input type="checkbox"/> Yes, <input type="checkbox"/> No
Parallel Connect	<input type="checkbox"/> Yes, <input type="checkbox"/> <input type="checkbox"/>

Key	Key Type	Number	SDN COS	Day Ring	Night Ring
DN-01	PDN		<input type="checkbox"/> Station, <input type="checkbox"/> DN		
DN-02			<input type="checkbox"/> Station, <input type="checkbox"/> DN		
DN-03			<input type="checkbox"/> Station, <input type="checkbox"/> DN		
DN-04			<input type="checkbox"/> Station, <input type="checkbox"/> DN		
DN-05			<input type="checkbox"/> Station, <input type="checkbox"/> DN		
DN-06			<input type="checkbox"/> Station, <input type="checkbox"/> DN		
DN-07			<input type="checkbox"/> Station, <input type="checkbox"/> DN		
DN-08			<input type="checkbox"/> Station, <input type="checkbox"/> DN		
DN-09			<input type="checkbox"/> Station, <input type="checkbox"/> DN		
DN-10			<input type="checkbox"/> Station, <input type="checkbox"/> DN		
DN-11			<input type="checkbox"/> Station, <input type="checkbox"/> DN		
DN-12			<input type="checkbox"/> Station, <input type="checkbox"/> DN		

PF Key	PF Key Type	Number
01		
02		
03		
04		
05		
06		
07		
08		
09		
10		
11		
12		

DSS Key	DSS Key Type	Number
01		
02		
03		
04		
05		
06		
07		
08		

EXTENSION-STATION

Station Equipment No.

item	Set Data
Telephone Type and Model	Type _____ Model _____
OHCA Circuit	<input type="checkbox"/> <input type="checkbox"/> No
Primary Directory Number	- - - -
intercom Number	- -
Station Name	_____
ICM Group	_____
Pickup Group	- - <input type="checkbox"/> None
Nexr Hunt Station	<input type="checkbox"/> _____ <input type="checkbox"/> None
Class of Service	- -
Data Line Security	<input type="checkbox"/> Yes, <input type="checkbox"/>
Automatic Callback-Trunk	<input type="checkbox"/> Yes, <input type="checkbox"/> No
Parallel Connect	<input type="checkbox"/> <input type="checkbox"/>

Key	Key Type	Number	SDN COS	Day Ring	Night Ring
DN-01	PDN		<input type="checkbox"/> Station, <input type="checkbox"/> DN		
DN-02			<input type="checkbox"/> Station, <input type="checkbox"/> DN		
DN-03			<input type="checkbox"/> Station, <input type="checkbox"/> DN		
DN-04			<input type="checkbox"/> Station, <input type="checkbox"/> DN		
DN-05			<input type="checkbox"/> Station, <input type="checkbox"/> DN		
DN-06			<input type="checkbox"/> Station, <input type="checkbox"/> DN		
DN-07			<input type="checkbox"/> Station, <input type="checkbox"/> DN		
DN-08			<input type="checkbox"/> Station, <input type="checkbox"/> DN		
DN-09			<input type="checkbox"/> Station, <input type="checkbox"/> DN		
DN-10			<input type="checkbox"/> Station, <input type="checkbox"/> DN		
DN-11			<input type="checkbox"/> Station, <input type="checkbox"/> DN		
DN-12			<input type="checkbox"/> Station, <input type="checkbox"/> DN		

PF Key	PF Key Type	Number	DSS Key	DSS Key Type	Number
01			01		
02			02		
03			03		
04			04		
05			05		
06			06		
07			07		
08			08		
09					
10					
11					
12					

EXTENSION-STATION

Station Equipment No.

Item	Set Data
Telephone Type and Model	Type _____ Model _____
OHCA Circuit	<input type="checkbox"/> <input type="checkbox"/> No
Primary Directory Number	- - - - -
Intercom Number	- -
Station Name	- - - - -
ICM Group	-
Pickup Group	- - <input type="checkbox"/> None
Next Hunt Station	<input type="checkbox"/> EXT <u> </u> <input type="checkbox"/> None
Class of Service	- -
Data Line Security	<input type="checkbox"/> Yes, <input type="checkbox"/> No
Automatic Callback-Trunk	<input type="checkbox"/> Yes, <input type="checkbox"/> No
Parallel Connect	<input type="checkbox"/> <input type="checkbox"/> No

Key	Key Type	Number	SDN COS	Day Ring	Night Ring
DN-01	PDN		<input type="checkbox"/> Station, <input type="checkbox"/> DN		
DN-02			<input type="checkbox"/> Station, <input type="checkbox"/> DN		
DN-03			<input type="checkbox"/> Station, <input type="checkbox"/> DN		
DN-04			<input type="checkbox"/> Station, <input type="checkbox"/> DN		
DN-05			<input type="checkbox"/> Station, <input type="checkbox"/> DN		
DN-06			<input type="checkbox"/> Station, <input type="checkbox"/> DN		
DN-07			<input type="checkbox"/> Station, <input type="checkbox"/> DN		
DN-09			<input type="checkbox"/> Station, <input type="checkbox"/> DN		
DN-09			<input type="checkbox"/> Station, <input type="checkbox"/> DN		
DN-10			<input type="checkbox"/> Station, <input type="checkbox"/> DN		
DN-11			<input type="checkbox"/> Station, <input type="checkbox"/> DN		
DN-12			<input type="checkbox"/> Station, <input type="checkbox"/> DN		

PF Key	PF Key Type	Number	DSS Key	DSS Key Type	Number
01			01		
02			02		
03			03		
04			04		
05			05		
06			06		
07			07		
08			08		
09					
10					
11					
12					

EXTENSION-STATION

Station Equipment No.

Item	Set Data
Telephone Type and Model	Type _____ Model _____
OHCA Circuit	<input type="checkbox"/> Yes, <input type="checkbox"/> No
Primary Directory Number	- - - -
Intercom Number	- -
Station Name	_____
ICM Group	_____
Pickup Group	- - <input type="checkbox"/> None
Next Hunt Station	<input type="checkbox"/> EXT - - - - <input type="checkbox"/> None
Class of Service	- -
Data Line Security	<input type="checkbox"/> Yes, <input type="checkbox"/> No
Automatic Callback-Trunk	<input type="checkbox"/> Yes, <input type="checkbox"/> No
Parallel Connect	<input type="checkbox"/> Yes, <input type="checkbox"/> No

Key	Key Type	Number	SDN COS	Day Ring	Night Ring
DN-01	PDN		<input type="checkbox"/> Station, <input type="checkbox"/> DN		
DN-02			<input type="checkbox"/> Station, <input type="checkbox"/> DN		
DN-03			<input type="checkbox"/> Station, <input type="checkbox"/> DN		
DN-04			<input type="checkbox"/> Station, <input type="checkbox"/> DN		
DN-05			<input type="checkbox"/> Station, <input type="checkbox"/> DN		
DN-06			<input type="checkbox"/> Station, <input type="checkbox"/> DN		
DN-07			<input type="checkbox"/> Station, <input type="checkbox"/> DN		
DN-08			<input type="checkbox"/> Station, <input type="checkbox"/> DN		
DN-09			<input type="checkbox"/> Station, <input type="checkbox"/> DN		
DN-10			<input type="checkbox"/> Station, <input type="checkbox"/> DN		
DN-11			<input type="checkbox"/> Station, <input type="checkbox"/> DN		
DN-12			<input type="checkbox"/> Station, <input type="checkbox"/> DN		

PF Key	PF Key Type	Number
01		
02		
03		
04		
05		
06		
07		
08		
09		
10		
11		
12		

DSS Key	DSS Key Type	Number
01		
02		
03		
04		
05		
06		
07		
08		

EXTENSION-STATION

Station Equipment No.

Item	Set Data
Telephone Type and Model	Type _____ Model _____
OHCA Circuit	<input type="checkbox"/> Yes, <input type="checkbox"/> <input type="checkbox"/>
Primary Directory Number	- - - - -
Intercom Number	- -
Station Name	-----
ICM Group	---
Pickup Group	- - 0 None
Next Hunt Station	<input type="checkbox"/> <input type="checkbox"/> <input type="checkbox"/> <input type="checkbox"/> <input type="checkbox"/> <input type="checkbox"/> None
Class of Service	- -
Data Line Security	<input type="checkbox"/> <input type="checkbox"/>
Automatic Callback-Trunk	<input type="checkbox"/> Yes, <input type="checkbox"/> No
Parallel Connect	<input type="checkbox"/> Yes, <input type="checkbox"/> <input type="checkbox"/>

Key	Key Type	Number	SDN COS	Dav Rina	Night Ring I
DN-01	PDN		<input type="checkbox"/> Station, <input type="checkbox"/> DN		
DN-02			<input type="checkbox"/> Station, <input type="checkbox"/> DN		
DN-03			<input type="checkbox"/> Station, <input type="checkbox"/> DN		
DN-04			<input type="checkbox"/> Station, <input type="checkbox"/> DN		
DN-05			<input type="checkbox"/> Station, <input type="checkbox"/> DN		
DN-06			<input type="checkbox"/> Station, <input type="checkbox"/> DN		
DN-07			<input type="checkbox"/> Station, <input type="checkbox"/> DN		
DN-08			<input type="checkbox"/> Station, <input type="checkbox"/> DN		
DN-09			<input type="checkbox"/> Station, <input type="checkbox"/> DN		
DN-10			<input type="checkbox"/> Station, <input type="checkbox"/> DN		
DN-11			<input type="checkbox"/> Station, <input type="checkbox"/> DN		
DN-12			<input type="checkbox"/> Stat-m, <input type="checkbox"/> DN		

PF Key	PF Key Type	Number	DSS Key	DSS Key Type	Number
01			01		
02			02		
03			03		
04			04		
05			05		
06			06		
07			07		
08			08		
09					
10					
11					
12					

EXTENSION-STATION

Station Equipment No.

Item	Set Data
Telephone Type and Model	Type _____ Model _____
OHCA Circuit	<input type="checkbox"/> <input type="checkbox"/>
Primary Directory Number	- - - -
Intercom Number	- -
Station Name	_____
ICM Group	---
Pickup Group	- - <input type="checkbox"/> None
Next Hunt Station	<input type="checkbox"/> _____ <input type="checkbox"/> None
Class of Service	- -
Data Line Security	<input type="checkbox"/> <input type="checkbox"/> No
Automatic Callback-Trunk	<input type="checkbox"/> Yes, <input type="checkbox"/> No
Parallel Connect	<input type="checkbox"/> Yes, <input type="checkbox"/>

Key	Key Type	Number	SDN COS	Day Ring	Night Ring
DN-01	PDN		<input type="checkbox"/> Station, <input type="checkbox"/> DN		
DN-02			<input type="checkbox"/> Station, <input type="checkbox"/> DN		
DN-03			<input type="checkbox"/> Station, <input type="checkbox"/> DN		
DN-04			<input type="checkbox"/> Station, <input type="checkbox"/> DN		
DN-05			<input type="checkbox"/> Station, <input type="checkbox"/> DN		
DN-06			<input type="checkbox"/> Station, <input type="checkbox"/> DN		
DN-07			<input type="checkbox"/> Station, <input type="checkbox"/> DN		
DN-08			<input type="checkbox"/> Station, <input type="checkbox"/> DN		
DN-09			<input type="checkbox"/> Station, <input type="checkbox"/> DN		
DN-10			<input type="checkbox"/> Station, <input type="checkbox"/> DN		
DN-11			<input type="checkbox"/> Station, <input type="checkbox"/> DN		
DN-12			<input type="checkbox"/> Station, <input type="checkbox"/> DN		

PF Key	PF Key Type	Number	DSS Key	DSS Key Type	Number
01			01		
02			02		
03			03		
04			04		
05			05		
06			06		
07			07		
08			08		
09					
10					
11					
12					

EXTENSION-STATION

Station Equipment No.

Item	Set Data
Telephone Type and Model	Type _____ Model _____
OHCA Circuit	<input type="checkbox"/> <input type="checkbox"/>
Primary Directory Number	_____
Intercom Number	____
Station Name	_____
ICM Group	_____
Pickup Group	- - - - - 0 None
Next Hunt Station	<input type="checkbox"/> EXT _____ <input type="checkbox"/> None
Class of Service	_____
Data Line Security	<input type="checkbox"/> <input type="checkbox"/>
Automatic Callback-Trunk	<input type="checkbox"/> Yes, <input type="checkbox"/>
Parallel Connect	<input type="checkbox"/> Yes, <input type="checkbox"/>

Key	Key Type	Number	SDN COS	Day Ring	Night Ring
DN-01	PDN		<input type="checkbox"/> Station, <input type="checkbox"/> DN		
DN-02			<input type="checkbox"/> Station, <input type="checkbox"/> DN		
DN-03			<input type="checkbox"/> Station, <input type="checkbox"/> DN		
DN-04			<input type="checkbox"/> Station, <input type="checkbox"/> DN		
DN-05			<input type="checkbox"/> Station, <input type="checkbox"/> DN		
DN-06			<input type="checkbox"/> Station, <input type="checkbox"/> DN		
DN-07			<input type="checkbox"/> Station, <input type="checkbox"/> DN		
DN-08			<input type="checkbox"/> Station, <input type="checkbox"/> DN		
DN-09			<input type="checkbox"/> Station, <input type="checkbox"/> DN		
DN-10			<input type="checkbox"/> Station, <input type="checkbox"/> DN		
DN-11			<input type="checkbox"/> Station, <input type="checkbox"/> DN		
DN-12			<input type="checkbox"/> Station, <input type="checkbox"/> DN		

PF Key	PF Key Type	Number	DSS Key	DSS Key Type	Number
01			01		
02			02		
03			03		
04			04		
05			05		
06			06		
07			07		
08			08		
09					
10					
11					
12					

EXTENSION-STATION

Station Equipment No.

Item	Set Data
Telephone Type and Model	Type _____ Model _____
OHCA Circuit	<input type="checkbox"/> Yes, <input type="checkbox"/> <input type="checkbox"/>
Primary Directory Number	- - - -
Intercom Number	- -
Station Name	-----
ICM Group	---
Pickup Group	- - <input type="checkbox"/> None
Next Hunt Station	<input type="checkbox"/> <input type="checkbox"/> _____ <input type="checkbox"/> None
Class of Service	- -
Data Line Security	<input type="checkbox"/> Yes, <input type="checkbox"/> <input type="checkbox"/>
Automatic Callback-Trunk	<input type="checkbox"/> Yes, <input type="checkbox"/> No
Parallel Connect	<input type="checkbox"/> <input type="checkbox"/>

Key	Key Type	Number	SDN COS	Day Ring	Night Ring
DN-01	PDN		<input type="checkbox"/> Station, <input type="checkbox"/> DN		
DN-02			<input type="checkbox"/> Station, <input type="checkbox"/> DN		
DN-03			<input type="checkbox"/> Station, <input type="checkbox"/> DN		
DN-04			<input type="checkbox"/> Station, <input type="checkbox"/> DN		
DN-05			<input type="checkbox"/> Station, <input type="checkbox"/> DN		
DN-06			<input type="checkbox"/> Station, <input type="checkbox"/> DN		
DN-07			<input type="checkbox"/> Station, <input type="checkbox"/> DN		
DN-08			<input type="checkbox"/> Station, <input type="checkbox"/> DN		
DN-09			<input type="checkbox"/> Station, <input type="checkbox"/> DN		
DN-10			<input type="checkbox"/> Station, <input type="checkbox"/> DN		
DN-11			<input type="checkbox"/> Station, <input type="checkbox"/> DN		
DN-12			<input type="checkbox"/> Station, <input type="checkbox"/> DN		

PF Key	PF Key Type	Number
01		
02		
03		
04		
05		
06		
07		
08		
09		
10		
11		
12		

DSS Key	DSS Key Type	Number
01		
02		
03		
04		
05		
06		
07		
08		

EXTENSION-STATION

Station Equipment No.

Item	Set Data
Telephone Type and Model	Type _____ Model _____
OHCA Circuit	<input type="checkbox"/> Yes, <input type="checkbox"/> <input type="checkbox"/>
Primary Directory Number	- - - - -
Intercom Number	- -
Station Name	_____
ICM Group	_____
Pickup Group	- - <input type="checkbox"/> None
Next Hunt Station	<input type="checkbox"/> _____ <input type="checkbox"/>
Class of Service	- -
Data Line Security	<input type="checkbox"/> Yes, <input type="checkbox"/> <input type="checkbox"/>
Automatic Callback-Trunk	<input type="checkbox"/> Yes, <input type="checkbox"/> No
Parallel Connect	<input type="checkbox"/> <input type="checkbox"/> No

Key	Key Type	Number	SDN COS	Day Ring	Night Ring
DN-01	PDN		<input type="checkbox"/> Station, <input type="checkbox"/> DN		
DN-02			<input type="checkbox"/> Station, <input type="checkbox"/> DN		
DN-03			<input type="checkbox"/> Station, <input type="checkbox"/> DN		
DN-04			<input type="checkbox"/> Station, <input type="checkbox"/> DN		
DN-05			<input type="checkbox"/> Station, <input type="checkbox"/> DN		
DN-06			<input type="checkbox"/> Station, <input type="checkbox"/> DN		
DN-07			<input type="checkbox"/> Station, <input type="checkbox"/> DN		
DN-08			<input type="checkbox"/> Station, <input type="checkbox"/> DN		
DN-09			<input type="checkbox"/> Station, <input type="checkbox"/> DN		
DN-10			<input type="checkbox"/> Station, <input type="checkbox"/> DN		
DN-11			<input type="checkbox"/> Station, nDN		
DN-12			<input type="checkbox"/> Station, <input type="checkbox"/> DN		

PF Key	PF Key Type	Number
0	1	
	02	
	03	
	04	
	05	
	06	
	07	
	08	
	09	
	10	
	11	
	12	

DSS Key	DSS Key Type	Number
01		
02		
03		
04		
05		
06		
07		
08		

EXTENSION-STATION

Station Equipment No.

Item	Set Data
Telephone Type and Model	Type _____ Model _____
OHCA Circuit	<input type="checkbox"/> <input type="checkbox"/>
Primary Directory Number	- - - - -
Intercom Number	- -
Station Name	- - - - -
ICM Gnup	—
Pickup Group	- - <input type="checkbox"/> None
Next Hunt Station	<input type="checkbox"/> EXT - - - - <input type="checkbox"/> None
Class of Service	- -
Data Line Security	<input type="checkbox"/> <input type="checkbox"/> No
Automatic Callback-Trunk	<input type="checkbox"/> Yes, <input type="checkbox"/> No
Parallel Connect	<input type="checkbox"/> Yes, <input type="checkbox"/> No

Key	Key Type	Number	SDN COS	Day Ring	Night Ring
DN-01	PDN		<input type="checkbox"/> Station, <input type="checkbox"/> DN		
DN-02			<input type="checkbox"/> Station, <input type="checkbox"/> DN		
DN-03			<input type="checkbox"/> Station, <input type="checkbox"/> DN		
DN-04			<input type="checkbox"/> Station, <input type="checkbox"/> DN		
DN-05			<input type="checkbox"/> Station, <input type="checkbox"/> DN		
DN-06			<input type="checkbox"/> Station, <input type="checkbox"/> DN		
DN-07			<input type="checkbox"/> Station, <input type="checkbox"/> DN		
DN-08			<input type="checkbox"/> Station, <input type="checkbox"/> DN		
DN-09			<input type="checkbox"/> Station, <input type="checkbox"/> DN		
DN-10			<input type="checkbox"/> Station, <input type="checkbox"/> DN		
DN-11			<input type="checkbox"/> Station, <input type="checkbox"/> DN		
DN-12			<input type="checkbox"/> Station, <input type="checkbox"/> DN		

PF Key	PF Key Type	Number
01		
02		
03		
04		
05		
06		
07		
08		
09		
10		
11		
12		

DSS Key	DSS Key Type	Number
01		
02		
03		
04		
05		
06		
07		
08		

EXTENSION-STATION

Station Equipment No.

Item	Set Data
Telephone Type and Model	Type _____ Model _____
OHCA Circuit	<input type="checkbox"/> Yes, <input type="checkbox"/> No
Primary Directory Number	- - - -
Intercom Number	- -
Station Name	- - - - - - - -
ICM Group	-
Pickup Group	- - <input type="checkbox"/> None
Next Hunt Station	<input type="checkbox"/> IEXT _____ <input type="checkbox"/> None
Class of Service	- -
Data Line Security	<input type="checkbox"/> <input type="checkbox"/> No
Automatic Callback-Trunk	<input type="checkbox"/> <input type="checkbox"/> No
Parallel Connect	<input type="checkbox"/> Yes, <input type="checkbox"/> No

Key	Key Type	Number	SDN COS	Day Ring	Night Ring
DN-01	PDN		<input type="checkbox"/> Station, <input type="checkbox"/> DN		
DN-02			<input type="checkbox"/> Station, <input type="checkbox"/> DN		
DN-03			<input type="checkbox"/> Station, <input type="checkbox"/> DN		
DN-04			<input type="checkbox"/> Station, <input type="checkbox"/> DN		
DN-05			<input type="checkbox"/> Station, ODN		
DN-06			<input type="checkbox"/> Station, /-JDN		
DN-07			<input type="checkbox"/> Station, <input type="checkbox"/> DN		
DN-08			<input type="checkbox"/> jStation, <input type="checkbox"/> DN		
DN-09			<input type="checkbox"/> Station, <input type="checkbox"/> DN		
DN-10			<input type="checkbox"/> Station, QDN		
DN-11			<input type="checkbox"/> Station, <input type="checkbox"/> DN		
DN-12			<input type="checkbox"/> Station, <input type="checkbox"/> DN		

PF Key	PF Key Type	Number
01		
02		
03		
04		
05		
06		
07		
08		
09		
10		
11		
12		

DSS Key	DSS Key Type	Number
01		
02		
03		
04		
05		
06		
07		
08		

EXTENSION-STATION

Equipment No.

Item	Set Data
Type and Model	Type _____ Model _____
Unit	<input type="checkbox"/> Yes, <input type="checkbox"/> No
Factory Number	_____
Number	_____
Name	_____
JP	<input type="checkbox"/> None
Station	<input type="checkbox"/> <input type="checkbox"/> None
Service	_____
Security	<input type="checkbox"/> Yes, <input type="checkbox"/> <input type="checkbox"/>
Callback-Trunk	<input type="checkbox"/> Yes, <input type="checkbox"/> No
Connect	<input type="checkbox"/> Yes, <input type="checkbox"/> No

Key Type	Number	SDN COS	Day Ring	Night Ring
PDN		<input type="checkbox"/> Station, <input type="checkbox"/> DN		
		<input type="checkbox"/> Station, <input type="checkbox"/> DN		
		<input type="checkbox"/> Station, <input type="checkbox"/> DN		
		<input type="checkbox"/> Station, <input type="checkbox"/> DN		
		<input type="checkbox"/> Station, <input type="checkbox"/> DN		
		<input type="checkbox"/> Station, <input type="checkbox"/> DN		
		<input type="checkbox"/> Station, <input type="checkbox"/> DN		
		<input type="checkbox"/> Station, <input type="checkbox"/> DN		
		<input type="checkbox"/> Station, <input type="checkbox"/> DN		
		<input type="checkbox"/> Station, <input type="checkbox"/> DN		
		<input type="checkbox"/> Station, <input type="checkbox"/> DN		

Key Type	Number

DSS Key	DSS Key Type	Number
01		
02		
03		
04		
05		
06		
07		
08		

Ring

EXTENSION-STATION

it No.

Set Data	
<p>3 Model _____</p> <p>umber _____</p> <p>_____</p> <p>_____</p> <p>_____ <input type="checkbox"/> None</p> <p><input type="checkbox"/> _____ <input type="checkbox"/> None</p> <p><input type="checkbox"/> <input type="checkbox"/> <input type="checkbox"/> _____</p> <p>-Trunk <input type="checkbox"/> <input type="checkbox"/> <input type="checkbox"/> <input type="checkbox"/> <input type="checkbox"/> _____</p> <p><input type="checkbox"/> <input type="checkbox"/> <input type="checkbox"/> <input type="checkbox"/> <input type="checkbox"/> <input type="checkbox"/> <input type="checkbox"/> _____</p>	<p>Type _____ Model _____</p> <p><input type="checkbox"/> Yes, <input type="checkbox"/> No</p>

Number	SDN COS	Day Ring	Night Ring
	<input type="checkbox"/> Station, <input type="checkbox"/> DN		
	<input type="checkbox"/> Station, <input type="checkbox"/> DN		
	<input type="checkbox"/> Station, <input type="checkbox"/> DN		
	<input type="checkbox"/> Station, <input type="checkbox"/> DN		
	<input type="checkbox"/> Station, <input type="checkbox"/> DN		
	<input type="checkbox"/> Station, <input type="checkbox"/> DN		
	<input type="checkbox"/> Station, <input type="checkbox"/> DN		
	<input type="checkbox"/> Station, <input type="checkbox"/> DN		
	<input type="checkbox"/> Station, <input type="checkbox"/> DN		
	<input type="checkbox"/> Station, <input type="checkbox"/> DN		
	<input type="checkbox"/> Station, <input type="checkbox"/> DN		
	<input type="checkbox"/> Station, <input type="checkbox"/> DN		
	<input type="checkbox"/> Station, <input type="checkbox"/> DN		
	<input type="checkbox"/> Station, <input type="checkbox"/> DN		
	<input type="checkbox"/> Station, <input type="checkbox"/> DN		

Number

DSS Key	DSS Key Type	Number
01		
02		
03		
04		
05		
06		
07		
08		

Night Ring

EXTENSION-STATION

Station Equipment No.

Item	Set Data
Telephone Type and Model	Type _____ Model _____
OHCA Circuit	<input type="checkbox"/> Yes, <input type="checkbox"/> No
Primary Directory Number	- - - - -
intercom Number	- -
Station Name	- - - - -
ICM Group	-
Pickup Group	- - 0 None
Next Hunt Station	<input type="checkbox"/> <input type="checkbox"/> _____ <input type="checkbox"/> None
Class of Service	- -
Data Line Security	<input type="checkbox"/> Yes, <input type="checkbox"/> No
Automatic Callback-Trunk	<input type="checkbox"/> Yes, <input type="checkbox"/> No
Parallel Connect	<input type="checkbox"/> <input type="checkbox"/>

Key	Key Type	Number	SDN COS	Day Ring	Night Ring
DN-01	PDN		<input type="checkbox"/> Station,nDN		
DN-02			<input type="checkbox"/> Station, <input type="checkbox"/> DN		
DN-03			<input type="checkbox"/> Station, <input type="checkbox"/> DN		
DN-04			<input type="checkbox"/> Station.C]DN		
DN-05			<input type="checkbox"/> Station,fJDN		
DN-06			<input type="checkbox"/> Station, <input type="checkbox"/> DN		
DN - 07			<input type="checkbox"/> Station, <input type="checkbox"/> DN		
DN-08			<input type="checkbox"/> Station, <input type="checkbox"/> DN		
DN-09			<input type="checkbox"/> Station, <input type="checkbox"/> DN		
DN-10			<input type="checkbox"/> Station, <input type="checkbox"/> DN		
DN-11			<input type="checkbox"/> tation,[7DN		
DN-12			<input type="checkbox"/> station, <input type="checkbox"/> DN		

PF Key	PF Key Type	Number	DSS Key	DSS Key Type	Number
01			01		
02			02		
03			03		
04			04		
05			05		
06			06		
07			07		
08			08		
09					
10					
11					
12					

EXTENSION-STATION

Station Equipment No.

Item	Set Data
Telephone Type and Model	Type _____ Model _____
OHCA Circuit	<input type="checkbox"/> <input type="checkbox"/> <input type="checkbox"/> <input type="checkbox"/> No
Primary Directory Number	_____
Intercom Number	_____
Station Name	_____
ICM Group	_____ <input type="checkbox"/> None
Pickup Group	_____ <input type="checkbox"/> None
Next Hunt Station	<input type="checkbox"/> <input type="checkbox"/> <input type="checkbox"/> <input type="checkbox"/> <input type="checkbox"/> None
Class of Service	_____
Data Line Security	<input type="checkbox"/> <input type="checkbox"/> <input type="checkbox"/> <input type="checkbox"/> <input type="checkbox"/>
Automatic Callback-Trunk	<input type="checkbox"/> <input type="checkbox"/> <input type="checkbox"/> <input type="checkbox"/>
Parallel Connect.	<input type="checkbox"/> Yes, <input type="checkbox"/> <input type="checkbox"/>

Key	Key Type	Number	SDN COS	Day Ring	Night Ring
DN-01	PDN		<input type="checkbox"/> Station, <input type="checkbox"/> DN		
DN-02			<input type="checkbox"/> Station, <input type="checkbox"/> DN		
DN-03			<input type="checkbox"/> Station, <input type="checkbox"/> DN		
DN-04			<input type="checkbox"/> Station, <input type="checkbox"/> DN		
DN-05			<input type="checkbox"/> Station, <input type="checkbox"/> DN		
DN-06			<input type="checkbox"/> Station, <input type="checkbox"/> DN		
DN-07			<input type="checkbox"/> Station, <input type="checkbox"/> DN		
DN-08			<input type="checkbox"/> Station, <input type="checkbox"/> DN		
DN-09			<input type="checkbox"/> Station, <input type="checkbox"/> DN		
DN-10			<input type="checkbox"/> Station, <input type="checkbox"/> DN		
DN-11			<input type="checkbox"/> Station, <input type="checkbox"/> DN		
DN-12			<input type="checkbox"/> Station, <input type="checkbox"/> DN		

PF Key	PF Key Type	Number	DSS Key	DSS Key Type	Number
01			01		
02			02		
03			03		
04			04		
05			05		
06			06		
07			07		
08			08		
09					
10					
11					
12					

EXTENSION-STATION

Station Equipment No.

item	Set Data
Telephone Type and Model	Type _____ Model _____
OHCA Circuit	<input type="checkbox"/> Yes, <input type="checkbox"/> Yes
Primary Directory Number	- - - - -
intercom Number	- -
Station Name	- - - - -
ICM Group	—
Pickup Group	— <input type="checkbox"/> None
Next Hunt Station	<input type="checkbox"/> EXT - - - - <input type="checkbox"/> None
Class of Service	- -
Data Line Security	<input type="checkbox"/> <input type="checkbox"/> No
Automatic Callback-Trunk	<input type="checkbox"/> <input type="checkbox"/>
Parallel Connect	<input type="checkbox"/> <input type="checkbox"/>

Key	Key Type	Number	SDNCOS	Day Rina	Niaht Rina
DN-01	PDN		<input type="checkbox"/> Station, <input type="checkbox"/> DN		
DN-02			<input type="checkbox"/> Station, uDN		
DN-03			<input type="checkbox"/> Station, nDN		
DN-04			<input type="checkbox"/> Station, C]DN		
DN-05			<input type="checkbox"/> Station, <input type="checkbox"/> DN		
DN-06			<input type="checkbox"/> Station <input type="checkbox"/> DN		
DN-07			<input type="checkbox"/> Station, <input type="checkbox"/> DN		
DN-08			<input type="checkbox"/> Station <input type="checkbox"/> DN		
DN-09			<input type="checkbox"/> Station, <input type="checkbox"/> DN		
DN-10			<input type="checkbox"/>]Station, <input type="checkbox"/> DN		
DN-11			<input type="checkbox"/> Station <input type="checkbox"/> DN		
DN-12			<input type="checkbox"/> Station, ODN		

PF Key	PF Key Type	Number
01		
02		
03		
04		
05		
06		
07		
08		
09		
10		
11		
12		

DSS Key	DSS Key Type	Number
01		
02		
03		
04		
05		
06		
07		
08		

EXTENSION-STATION

Station Equipment No.

Item	Set Data
Telephone Type and Model	Type _____ Model _____
OHC A Circuit	<input type="checkbox"/> Yes, <input type="checkbox"/> <input type="checkbox"/>
Primary Directory Number	_____
Intercom Number	_____
Station Name	_____
ICM Group	_____
Pickup Group	_____ <input type="checkbox"/> None
Next Hunt Station	<input type="checkbox"/> _____ <input type="checkbox"/> None
Class of Service	<input type="checkbox"/>
Data Line Security	<input type="checkbox"/> <input type="checkbox"/> No
Automatic Callback-Trunk	<input type="checkbox"/> <input type="checkbox"/>
Parallel Connect	<input type="checkbox"/> Yes, <input type="checkbox"/> No

Key	Key Type	Number	SDN COS	Day Ring	Night Ring
DN-01	PDN		<input type="checkbox"/> Station, <input type="checkbox"/> DN		
DN-02			<input type="checkbox"/> Station, <input type="checkbox"/> DN		
DN-03			<input type="checkbox"/> Station, <input type="checkbox"/> DN		
DN-04			<input type="checkbox"/> Station, <input type="checkbox"/> DN		
DN-05			<input type="checkbox"/> Station, <input type="checkbox"/> DN		
DN-06			<input type="checkbox"/> Station, <input type="checkbox"/> DN		
DN-07			<input type="checkbox"/> Station, <input type="checkbox"/> DN		
DN-08			<input type="checkbox"/> Station, <input type="checkbox"/> DN		
DN-09			<input type="checkbox"/> Station, <input type="checkbox"/> DN		
DN-10			<input type="checkbox"/> Station, <input type="checkbox"/> DN		
DN-11			<input type="checkbox"/> Station, <input type="checkbox"/> DN		
DN-12			<input type="checkbox"/> Station, <input type="checkbox"/> DN		

PF Key	PF Key Type	Number	DSS Key	DSS Key Type	Number
01			01		
02			02		
03			03		
04			04		
05			05		
06			06		
07			07		
08			08		
09					
10					
11					
12					

EXTENSION-STATION

Station Equipment No.

Item	Set Data
Telephone Type and Model	Type _____ Model _____
OHCA Circuit	<input type="checkbox"/> <input type="checkbox"/> <input type="checkbox"/> <input type="checkbox"/> Nc
Primary Directory Number	- - - -
Intercom Number-	- -
Station Name	- - - - - - - -
ICM Group	- -
Pickup Group	- - c None
Next Hunt Station	<input type="checkbox"/> EXT - - - - <input type="checkbox"/> None
Class of Service	- -
Data Line Security	<input type="checkbox"/> Yes, <input type="checkbox"/>
Automatic Callback-Trunk	<input type="checkbox"/> Yes, <input type="checkbox"/>
Parallel Connect	<input type="checkbox"/> Yes, <input type="checkbox"/>

Key	Key Type	Number	SDN	COS	Day Ring	Night Ring
DN-01	P D	N	<input type="checkbox"/> Station, <input type="checkbox"/> DN			
DN-02			<input type="checkbox"/> Station, <input type="checkbox"/> DN			
DN-03			<input type="checkbox"/> Station, <input type="checkbox"/> DN			
DN-04			<input type="checkbox"/> Station, <input type="checkbox"/> DN			
DN-05			<input type="checkbox"/> Station, <input type="checkbox"/> DN			
DN-06			<input type="checkbox"/> Station, <input type="checkbox"/> DN			
DN-07			<input type="checkbox"/> Station, <input type="checkbox"/> DN			
DN-06			<input type="checkbox"/> Station, <input type="checkbox"/> DN			
DN-09			<input type="checkbox"/> Station, <input type="checkbox"/> DN			
DN-10			<input type="checkbox"/> Station, <input type="checkbox"/> DN			
DN-11			<input type="checkbox"/> Station, <input type="checkbox"/> DN			
DN-12			<input type="checkbox"/> Station, <input type="checkbox"/> DN			

PF Key	PF Key Type	Number	DSS Key	DSS Key Type	Number
01			01		
02			02		
03			03		
04			04		
05			05		
06			06		
07			07		
08			08		
09					
10					
11					
t2					

EXTENSION-STATION

Station Equipment No.

Item	Set Data
Telephone Type and Model	Type _____ Model _____
OHCA Circuit	<input type="checkbox"/> Yes, <input type="checkbox"/> No
Primary Directory Number	_____
Intercom Number	_____
Station Name	_____
ICM Group	_____
Pickup Group	_____ <input type="checkbox"/> None
Next Hunt Station	<input type="checkbox"/> <input type="checkbox"/> <input type="checkbox"/> <input type="checkbox"/> <input type="checkbox"/> None
Class of Service	
Data Line Security	<input type="checkbox"/> Yes, <input type="checkbox"/> No
Automatic Callback-Trunk	<input type="checkbox"/> Yes, <input type="checkbox"/> No
Parallel Connect	<input type="checkbox"/> Yes, <input type="checkbox"/> No

Key	Key Type	Number	SDN COS	Day Ring	Night Ring
DN-01	PDN		<input type="checkbox"/> Station, <input type="checkbox"/> DN		
DN-02			<input type="checkbox"/> Station, <input type="checkbox"/> DN		
DN-03			<input type="checkbox"/> Station, <input type="checkbox"/> DN		
DN-04			<input type="checkbox"/> Station, <input type="checkbox"/> DN		
DN-05			<input type="checkbox"/> Station, <input type="checkbox"/> DN		
DN-06			<input type="checkbox"/> Station, <input type="checkbox"/> DN		
DN-07			<input type="checkbox"/> Station, <input type="checkbox"/> DN		
DN-08			<input type="checkbox"/> Station, <input type="checkbox"/> DN		
DN-09			<input type="checkbox"/> Station, <input type="checkbox"/> DN		
DN-10			<input type="checkbox"/> Station, <input type="checkbox"/> DN		
DN-11			<input type="checkbox"/> Station, <input type="checkbox"/> DN		
DN-12			<input type="checkbox"/> Station, <input type="checkbox"/> DN		

PF Key	PF Key Type	Number	DSS Key	DSS Key Type	Number
01			01		
02			02		
03			03		
04			04		
05			05		
06			06		
07			07		
08			08		
09					
10					
11					
12					

EXTENSION-STATION

Station Equipment No. _____

Item	Set Data
Telephone Type and Model	Type _____ Model _____
OHCA Circuit	<input type="checkbox"/> <input type="checkbox"/> No
Primary Directory Number	_____
Intercom Number	_____
Station Name	_____
ICM Group	
Pickup Group	<input type="checkbox"/> None
Next Hunt Station	<input type="checkbox"/> IEXT _____ <input type="checkbox"/> None
Class of Service	_____
Data Line Security	yes, <input type="checkbox"/> No
Automatic Callback-Trunk	<input type="checkbox"/> Yes, <input type="checkbox"/> No
Parallel Connect	<input type="checkbox"/> <input type="checkbox"/>

Key	Key Type	Number	SDN COS	Day Ring	Night Ring
DN-01	PDN		<input type="checkbox"/> Station, <input type="checkbox"/> DN		
DN-02			<input type="checkbox"/> Station, <input type="checkbox"/> DN		
DN-03			<input type="checkbox"/> Station, <input type="checkbox"/> DN		
DN-04			<input type="checkbox"/> Station, <input type="checkbox"/> DN		
DN-05			<input type="checkbox"/> Station, <input type="checkbox"/> DN		
DN-06			<input type="checkbox"/> Station, <input type="checkbox"/> DN		
DN-07			<input type="checkbox"/> Station, <input type="checkbox"/> DN		
DN-08			<input type="checkbox"/> Station, <input type="checkbox"/> DN		
DN-09			<input type="checkbox"/> Station, <input type="checkbox"/> DN		
DN-10			<input type="checkbox"/> Station, <input type="checkbox"/> DN		
DN-11			<input type="checkbox"/> Station, <input type="checkbox"/> DN		
DN-12			<input type="checkbox"/> Station, <input type="checkbox"/> DN		

PF Key	PF Key Type	Number	DSS Key	DSS Key Type	Number
01			01		
02			02		
03			03		
04			04		
05			05		
06			06		
07			07		
08			08		
09					
10					
11					
12					

EXTENSION-STATION

Station Equipment No.

Item	Set Data
Telephone Type and Model	Type _____ Model _____
OHCA Circuit	<input type="checkbox"/> <input type="checkbox"/> No
Primary Directory Number	- - - -
Intercom Number	- -
Station Name	_____
ICM Group	_____
Pickup Group	- - <input type="checkbox"/> None
Next Hunt Station	<input type="checkbox"/> EXT _____ <input type="checkbox"/> None
Class of Service	- -
Data Line Security	<input type="checkbox"/> Yes, <input type="checkbox"/> No
Automatic Callback-Trunk	<input type="checkbox"/> <input type="checkbox"/> No
Parallel Connect	<input type="checkbox"/> Yes, <input type="checkbox"/> No

Key	Key Type	Number	SDN COS	Day Ring	Night Ring
DN-01	PDN		<input type="checkbox"/> Station, <input type="checkbox"/> DN		
DN-02			<input type="checkbox"/> Station, <input type="checkbox"/> DN		
DN-03			<input type="checkbox"/> Station, <input type="checkbox"/> DN		
DN-04			<input type="checkbox"/> Station, <input type="checkbox"/> DN		
DN-05			<input type="checkbox"/> Station, <input type="checkbox"/> DN		
DN-06			<input type="checkbox"/> Station, <input type="checkbox"/> DN		
DN-07			<input type="checkbox"/> Station, <input type="checkbox"/> DN		
DN-08			<input type="checkbox"/> Station, <input type="checkbox"/> DN		
DN-09			<input type="checkbox"/> Station, <input type="checkbox"/> DN		
DN-10			<input type="checkbox"/> Station, <input type="checkbox"/> DN		
DN-11			<input type="checkbox"/> Station, <input type="checkbox"/> DN		
DN-12			<input type="checkbox"/> Station, <input type="checkbox"/> DN		

PF Key	PF Key Type	Number	DSS Key	DSS Key Type	Number
01			01		
02			02		
03			03		
04			04		
05			05		
08			06		
07			07		
08			08		
09					
10					
11					
72					

EXTENSION-STATION

Station Equipment No.

Item	Set Data
Telephone Type and Model	Type _____ Model _____
OHCA Circuit	<input type="checkbox"/> Yes <input type="checkbox"/>
Primary Directory Number	- - - -
Intercom Number	- -
Station Name	_____
ICM Group	_____
Pickup Group	- - <input type="checkbox"/> None
Next Hunt Station	<input type="checkbox"/> _____ <input type="checkbox"/> None
Class of Service	- -
Data Line Security	<input type="checkbox"/> Yes, <input type="checkbox"/>
Automatic Callback-Trunk	<input type="checkbox"/> Yes, <input type="checkbox"/>
Parallel Connect	<input type="checkbox"/> Yes, <input type="checkbox"/>

Key	Key Type	Number	SDN COS	Day Ring	Night Ring
DN-01	P DN		<input type="checkbox"/> Station, uDN		
DN-02			<input type="checkbox"/> Station, <input type="checkbox"/> DN		
DN-03			<input type="checkbox"/> Station, <input type="checkbox"/> DN		
DN-04			<input type="checkbox"/> Station, <input type="checkbox"/> DN		
DN-05			<input type="checkbox"/> Station, <input type="checkbox"/> DN		
DN-06			<input type="checkbox"/> Station, f-JDN		
DN-07			<input type="checkbox"/> Station, C]DN		
DN-08			<input type="checkbox"/> Station, nDN		
DN-09			<input type="checkbox"/> Station, nDN		
DN-10			<input type="checkbox"/> Station, <input type="checkbox"/> DN		
DN-11			<input type="checkbox"/> Station, <input type="checkbox"/> DN		
DN-12			<input type="checkbox"/> Station, <input type="checkbox"/> DN		

PF Key	PF Key Type	Number
01		
02		
03		
04		
05		
06		
07		
08		
09		
10		
11		
12		

DSS Key	DSS Key Type	Number
01		
02		
03		
04		
05		
06		
07		
08		

EXTENSION-STATION

Station Equipment No.

Item	Set Data
Telephone Type and Model	Type _____ Model _____
OHCA Circuit	<input type="checkbox"/> Yes, <input type="checkbox"/> <input type="checkbox"/>
Primary Directory Number	- - - -
Intercom Number	- -
Station Name	_____
ICM Group	_____
Pickup Group	- - <input type="checkbox"/> None
Next Hunt Station	<input type="checkbox"/> <input type="checkbox"/> _____ <input type="checkbox"/> None
Class of Service	- -
Data Line Security	<input type="checkbox"/> Yes, <input type="checkbox"/> No
Automatic Callback-Trunk	<input type="checkbox"/> Yes, <input type="checkbox"/> No
Parallel Connect	<input type="checkbox"/> <input type="checkbox"/> <input type="checkbox"/>

Key	Key Type	Number	SDN COS	Day Ring	Night Ring
DN-01	PDN		<input type="checkbox"/> Station, <input type="checkbox"/> DN		
DN-02			<input type="checkbox"/> Station, nDN		
ON-03			<input type="checkbox"/> Station, <input type="checkbox"/> DN		
DN-04			<input type="checkbox"/> Station, <input type="checkbox"/> DN		
DN-05			<input type="checkbox"/> Station, <input type="checkbox"/> DN		
DN-06			<input type="checkbox"/> Station, <input type="checkbox"/> DN		
DN-07			<input type="checkbox"/> Station, <input type="checkbox"/> DN		
DN-08			<input type="checkbox"/> Station, <input type="checkbox"/> DN		
DN-09			<input type="checkbox"/> Station, <input type="checkbox"/> DN		
DN-10			<input type="checkbox"/> Station, <input type="checkbox"/> DN		
DN-11			<input type="checkbox"/> Station, <input type="checkbox"/> DN		
DN-12			<input type="checkbox"/> Station, <input type="checkbox"/> DN		

PF Key	PF Key Type	Number	DSS Key	DSS Key Type	Number
01			01		
02			02		
03			03		
04			04		
05			05		
06			06		
07			07		
08			08		
09					
10					
11					
12					

EXTENSION-STATION

Station Equipment No.

Item	Set Data
Telephone Type and Model	Type _____ Model _____
OHCA Circuit	<input type="checkbox"/> <input type="checkbox"/> No
Primary Directory Number	- - - -
Intercom Number	- -
Station Name	- - - - - - - -
ICM Group	-
Pickup Group	- - <input type="checkbox"/> None
Next Hunt Station	<input type="checkbox"/> <input type="checkbox"/> None
Class of Service	- -
Data Line Security	<input type="checkbox"/> Yes, <input type="checkbox"/> <input type="checkbox"/>
Automatic Callback-Trunk	<input type="checkbox"/> Yes, <input type="checkbox"/> No
Parallel Connect	<input type="checkbox"/> <input type="checkbox"/>

Key	Key Type	Number	SDN COS	Day Ring	Night Ring
DN-01	PDN		<input type="checkbox"/> Station, <input type="checkbox"/> DN		
DN-02			<input type="checkbox"/> Station, <input type="checkbox"/> DN		
DN-03			<input type="checkbox"/> Station, <input type="checkbox"/> DN		
DN-04			<input type="checkbox"/> Station, <input type="checkbox"/> DN		
DN-05			<input type="checkbox"/> Station, <input type="checkbox"/> DN		
DN-06			<input type="checkbox"/> Station, <input type="checkbox"/> DN		
DN-07			<input type="checkbox"/> Station, <input type="checkbox"/> DN		
DN-08			<input type="checkbox"/> Station, <input type="checkbox"/> DN		
DN-09			<input type="checkbox"/> Station, <input type="checkbox"/> DN		
DN-10			<input type="checkbox"/> Station, <input type="checkbox"/> DN		
DN-11			<input type="checkbox"/> Station, <input type="checkbox"/> DN		
DN-12			<input type="checkbox"/> Station, <input type="checkbox"/> DN		

PF Key	PF Key Type	Number
01		
02		
03		
04		
05		
06		
07		
08		
09		
10		
11		
12		

DSS Key	DSS Key Type	Number
01		
02		
03		
04		
05		
06		
07		
08		

EXTENSION-STATION

Station Equipment No.

Item	Set Data
Telephone Type and Model	Type _____ Model _____
OHCA Circuit	<input type="checkbox"/> <input type="checkbox"/>
Primary Directory Number	- - - -
Intercom Number	- -
Station Name	_____
ICM Group	---
Pickup Group	- - <input type="checkbox"/> None
Next Hunt Station	<input type="checkbox"/> <input type="checkbox"/> <input type="checkbox"/> <input type="checkbox"/> <input type="checkbox"/> None
Class of Service	- -
Data Line Security	<input type="checkbox"/> Yes, <input type="checkbox"/> No
Automatic Callback-Trunk	<input type="checkbox"/> <input type="checkbox"/> No
Parallel Connect.	<input type="checkbox"/> Yes, <input type="checkbox"/> <input type="checkbox"/>

Key	Key Type	Number	SDN COS	Day Ring	Night Ring
DN-01	PDN		<input type="checkbox"/> Station, <input type="checkbox"/> DN		
DN-02			<input type="checkbox"/> Station, <input type="checkbox"/> DN		
DN-03			<input type="checkbox"/> Station, <input type="checkbox"/> DN		
DN-04			<input type="checkbox"/> Station, <input type="checkbox"/> DN		
DN-05			<input type="checkbox"/> Station, <input type="checkbox"/> DN		
DN-06			<input type="checkbox"/> Station, <input type="checkbox"/> DN		
DN-07			<input type="checkbox"/> Station, <input type="checkbox"/> DN		
DN-08			<input type="checkbox"/> Station, <input type="checkbox"/> DN		
DN-09			<input type="checkbox"/> Station, <input type="checkbox"/> DN		
DN-10			<input type="checkbox"/> Station, <input type="checkbox"/> DN		
DN-11			<input type="checkbox"/> Station, <input type="checkbox"/> DN		
DN-12			<input type="checkbox"/> Station, <input type="checkbox"/> DN		

PF Key	PF Key Type	Number	DSS Key	DSS Key Type	Number
01			01		
02			02		
03			03		
04			04		
05			05		
06			06		
07			07		
08			08		
09					
10					
11					
12	t				

EXTENSION-STATION

Station Equipment No.

Item	Set Data
Telephone Type and Model	Type _____ Model _____
OHCA Circuit	<input type="checkbox"/> Yes, <input type="checkbox"/> <input type="checkbox"/>
Primary Directory Number	- - - - -
Intercom Number	- -
Station Name	- - - - -
ICM Group	_____
Pickup Group	- - <input type="checkbox"/> None
Next Hunt Station	<input type="checkbox"/> _____ <input type="checkbox"/> None
Class of Service	- -
Data Line Security	<input type="checkbox"/> Yes, <input type="checkbox"/> <input type="checkbox"/>
Automatic Callback-Trunk	<input type="checkbox"/> Yes, <input type="checkbox"/> No
Parallel Connect	<input type="checkbox"/> Yes <input type="checkbox"/>





















Key	Key Type	Number	SDN COS	Day Ring	Night Ring
DN-01	PDN		<input type="checkbox"/> Station, <input type="checkbox"/> DN		
DN-02			<input type="checkbox"/> Station, <input type="checkbox"/> DN		
DN-03			<input type="checkbox"/> Station, <input type="checkbox"/> DN		
DN-04			<input type="checkbox"/> Station, <input type="checkbox"/> DN		
DN-05			<input type="checkbox"/> Station, <input type="checkbox"/> DN		
DN-06			<input type="checkbox"/> Station, <input type="checkbox"/> DN		
DN-07			<input type="checkbox"/> Station, <input type="checkbox"/> DN		
DN-08			<input type="checkbox"/> Station, <input type="checkbox"/> DN		
DN-09			<input type="checkbox"/> Station, <input type="checkbox"/> DN		
DN-10			<input type="checkbox"/> Station, <input type="checkbox"/> DN		
DN-11			<input type="checkbox"/> Station, <input type="checkbox"/> DN		
DN-12			<input type="checkbox"/> Station, <input type="checkbox"/> DN		

PF Key	PF Key Type	Number
01		
02		
03		
04		
05		
06		
07		
08		
09		
10		
11		
12		

DSS Key	DSS Key Type	Number
01		
02		
03		
04		
05		
06		
07		
08		

EXTENSION-STATION

Station Equipment No.

Item	Set Data
Telephone Type and Model	Type _____ Model _____
OHCA Circuit	<input type="checkbox"/> Yes, <input type="checkbox"/> No <input type="checkbox"/> 
Primary Directory Number	- - - -
Intercom-Number	- -
Station Name	- - - - - - - - - -
ICM Group	_____
Pickup Group	- - <input type="checkbox"/> None
Next Hunt Station	<input type="checkbox"/>    <input type="checkbox"/>      <input type="checkbox"/>   
Class of Service	- -
Data Line Security	<input type="checkbox"/> Yes, <input type="checkbox"/> No <input type="checkbox"/> 
Automatic Callback-Trunk	<input type="checkbox"/>    <input type="checkbox"/> No
Parallel Connect	<input type="checkbox"/>    <input type="checkbox"/>  

Key	Key Type	Number	SDN COS	Day Ring	Night Ring
DN-01	PDN		<input type="checkbox"/> Station, <input type="checkbox"/> DN		
DN-02			<input type="checkbox"/> Station, <input type="checkbox"/> DN		
DN-03			<input type="checkbox"/> Station, <input type="checkbox"/> DN		
DN-04			<input type="checkbox"/> Station, <input type="checkbox"/> DN		
DN-05			<input type="checkbox"/> Station, <input type="checkbox"/> DN		
DN-06			<input type="checkbox"/> Station, <input type="checkbox"/> DN		
DN-07			<input type="checkbox"/> Station, <input type="checkbox"/> DN		
DN-08			<input type="checkbox"/> Station, <input type="checkbox"/> DN		
DN-09			<input type="checkbox"/> Station, <input type="checkbox"/> DN		
DN-10			<input type="checkbox"/> Station, <input type="checkbox"/> DN		
DN-11			<input type="checkbox"/> Station, <input type="checkbox"/> DN		
DN-12			<input type="checkbox"/> Station, <input type="checkbox"/> DN		

PF Key	PF Key Type	Number	DSS Key	DSS Key Type	Number
01			01		
0			02		
03			03		
04			04		
05			05		
06			06		
07			07		
08			08		
09					
10					
11					
12					1

EXTENSION-STATION

Station Equipment No.

Item	Set Data
Telephone Type and Model	Type _____ Model _____
OHCA Circuit	<input type="checkbox"/> <input type="checkbox"/>
Primary Directory Number	- - - - -
Intercom Number	- -
Station Name	_____
ICM Group	_____
Pickup Group	- - <input type="checkbox"/> None
Next Hunt Station	<input type="checkbox"/> _____ <input type="checkbox"/> None
Class of Service	- -
Data Line Security	<input type="checkbox"/> Yes, <input type="checkbox"/> No
Automatic Callback-Trunk	<input type="checkbox"/> Yes, <input type="checkbox"/> No
Parallel Connect	<input type="checkbox"/> Yes, <input type="checkbox"/> No

Key	Key Type	Number	SDN COS	Day Ring	Night Ring
DN-01	PDN		<input type="checkbox"/> Station, <input type="checkbox"/> DN		
DN-02			<input type="checkbox"/> Station, <input type="checkbox"/> DN		
DN-03			<input type="checkbox"/> Station, <input type="checkbox"/> DN		
DN-04			<input type="checkbox"/> Station, <input type="checkbox"/> DN		
DN-05			<input type="checkbox"/> Station, <input type="checkbox"/> DN		
DN-06			<input type="checkbox"/> Station, <input type="checkbox"/> DN		
DN-07			<input type="checkbox"/> Station, <input type="checkbox"/> DN		
DN-08			<input type="checkbox"/> Station, <input type="checkbox"/> DN		
DN-09			<input type="checkbox"/> Station, <input type="checkbox"/> DN		
DN-10			<input type="checkbox"/> Station, <input type="checkbox"/> DN		
DN-11			<input type="checkbox"/> Station, <input type="checkbox"/> DN		
DN-12			<input type="checkbox"/> Station, <input type="checkbox"/> DN		

PF Key	PF Key Type	Number
01		
02		
03		
04		
05		
06		
07		
08		
09		
10		
11		
12		

DSS Key	DSS Key Type	Number
01		
02		
03		
04		
05		
06		
07		
08		

EXTENSION-STATION

Station Equipment No.

Item	Set Data
Telephone Type and Model	Type _____ Model _____
OHCA Circuit	<input type="checkbox"/> Yes. <input type="checkbox"/> No
Primary Directory Number	_____
Intercom Number	- -
Station Name	_____
ICM Group	_____
Pickup Group	- - <input type="checkbox"/> None
Next Hunt Station	<input type="checkbox"/> <input type="checkbox"/> None
Class of Service	- -
Data Line Security	<input type="checkbox"/> Yes. <input type="checkbox"/> No
Automatic Callback-Trunk	<input type="checkbox"/> Yes. <input type="checkbox"/> No
Parallel Connect	<input type="checkbox"/> <input type="checkbox"/>

Key	Key Type	Number	SDN COS	Day Ring	Night Ring
DN-01	PDN		<input type="checkbox"/> Station, <input type="checkbox"/> DN		
DN-02			<input type="checkbox"/> Station, <input type="checkbox"/> DN		
DN-03			<input type="checkbox"/> Station, <input type="checkbox"/> DN		
DN-04			<input type="checkbox"/> Station, <input type="checkbox"/> DN		
DN-05			<input type="checkbox"/> Station, <input type="checkbox"/> DN		
DN-06			<input type="checkbox"/> Station, ODN		
DN-07			<input type="checkbox"/> Station, <input type="checkbox"/> DN		
DN-08			<input type="checkbox"/> Station, ODN		
DN-09			<input type="checkbox"/> Station, uDN		
DN-10			<input type="checkbox"/> Station, <input type="checkbox"/> DN		
DN-11			<input type="checkbox"/> Station, <input type="checkbox"/> DN		
DN-12			<input type="checkbox"/> Station, <input type="checkbox"/> DN		

PF Key	PF Key Type	Number
01		
02		
03		
04		
05		
06		
07		
08		
09		
10		
11		
12		

DSS Key	DSS Key Type	Number
01		
02		
03		
04		
05		
06		
07		
08		

EXTENSION-STATION

Station Equipment No.

Item	Set Data
Telephone Type and Model	Type _____ Model _____
OHCA Circuit	<input type="checkbox"/> Yes, <input type="checkbox"/> No
Primary Directory Number	- - - - -
Intercom Number	- - -
Station Name	- - - - -
ICM Group	_____
Pickup Group	- - - <input type="checkbox"/> None
Next Hunt Station	<input type="checkbox"/> EXT - - - - - a None
Class of Service	- - -
Data Line Security	<input type="checkbox"/> Yes, <input type="checkbox"/> No
Automatic Callback-Tank	<input type="checkbox"/> Yes, <input type="checkbox"/> No
Parallel Connect	<input type="checkbox"/> Yes, <input type="checkbox"/> No

Key	Key Type	Number	SON COS	Day Ring	Night Ring
DN-01	PDN		<input type="checkbox"/> Station, <input type="checkbox"/> DN		
DN-02			<input type="checkbox"/> Station, <input type="checkbox"/> DN		
DN-03			<input type="checkbox"/> Station, <input type="checkbox"/> DN		
DN-04			<input type="checkbox"/> Station, <input type="checkbox"/> DN		
DN-05			<input type="checkbox"/> Station, <input type="checkbox"/> DN		
DN-06			<input type="checkbox"/> Station, <input type="checkbox"/> DN		
DN-07			<input type="checkbox"/> Station, <input type="checkbox"/> DN		
DN-08			<input type="checkbox"/> Station, nDN		
DN-09			<input type="checkbox"/> Station, <input type="checkbox"/> DN		
DN-10			<input type="checkbox"/> Station, nDN		
DN-11			<input type="checkbox"/> Station, ODN		
DN-12			<input type="checkbox"/> Station, <input type="checkbox"/> DN		

PF Key	PF Key Type	Number	DSS Key	DSS Key Type	Number
01			01		
02			02		
03			03		
04			04		
05			05		
06			06		
07			07		
08			08		
09					
10					
11					
12					

EXTENSION-STATION

Station Equipment No.

Item	Set Data
Telephone Type and Model	Type _____ Model _____
C-CA Circuit	<input type="checkbox"/> Yes, <input type="checkbox"/> No
Primary Directory Number	- - - -
Intercom Number	- -
Station Name	-----
ICM Group	---
Pickup Group	- - <input type="checkbox"/> None
Next Hunt Station	<input type="checkbox"/> EXT <input type="checkbox"/> N o n e
Class of Service	- -
Data Line Security	<input type="checkbox"/> Yes <input type="checkbox"/> <input type="checkbox"/>
Automatic Callback-Trunk	<input type="checkbox"/> Yes, <input type="checkbox"/> No
Parallel Connect	<input type="checkbox"/> Yes, <input type="checkbox"/> No

Key	Key Type	Number	SDN COS	Day Ring	Night Ring
DN-01	PDN		<input type="checkbox"/> Station, <input type="checkbox"/> DN		
Vi-02			<input type="checkbox"/> Station, ODN		
DN-03			<input type="checkbox"/> Station, <input type="checkbox"/> DN		
DN-04			<input type="checkbox"/> Station, <input type="checkbox"/> DN		
DN-05			<input type="checkbox"/> Station, <input type="checkbox"/> DN		
DN-06			<input type="checkbox"/> Station, ODN		
DN-07			<input type="checkbox"/> Station, <input type="checkbox"/> DN		
DN-08			<input type="checkbox"/> Station, <input type="checkbox"/> DN		
Pi-09			<input type="checkbox"/> Station, /-JDN		
DN-10			<input type="checkbox"/> Station, uDN		
DN-11			<input type="checkbox"/> Station, <input type="checkbox"/> DN		
DN-12			<input type="checkbox"/> StatW(7DN)		

PF Key	PF Key Type	Number	DSS Key	DSS Key Type	Number
01			01		
02			02		
03			03		
04			04		
05			05		
06			06		
07			07		
08			08		
09					
10					
11					
12					

EXTENSION-STATION

Station Equipment No.

Item	Set Data
Telephone Type and Model	Type _____ Model _____
OHCA Circuit	<input type="checkbox"/> <input type="checkbox"/> No
Primary Directory Number	_____
Intercom Number	- -
Station Name	_____
ICM Group	_____
Pickup Group	- - <input type="checkbox"/> None
Next Hunt Station	<input type="checkbox"/> _____ <input type="checkbox"/> None
Class of Service	- -
Data Line Security	<input type="checkbox"/> <input type="checkbox"/> No
Automatic Callback-Trunk	<input type="checkbox"/> <input type="checkbox"/> No
Parallel Connect	<input type="checkbox"/> <input type="checkbox"/> No

Key	Key Type	Number	SDN COS	Day Ring	Night Ring
DN-01	PDN		<input type="checkbox"/> Station, f-JDN		
DN-02			<input type="checkbox"/> Station, <input type="checkbox"/> DN		
DN-03			<input type="checkbox"/> Station, <input type="checkbox"/> DN		
DN-04			<input type="checkbox"/> Station, <input type="checkbox"/> DN		
DN-05			<input type="checkbox"/> Station, <input type="checkbox"/> DN		
DN-06			<input type="checkbox"/> Station, nDN		
DN-07			<input type="checkbox"/> Station, <input type="checkbox"/> DN		
DN-08			<input type="checkbox"/> Station, <input type="checkbox"/> DN		
DN-09			<input type="checkbox"/> Station, <input type="checkbox"/> DN		
DN-10			<input type="checkbox"/> Station, nDN		
DN-11			<input type="checkbox"/> Station, <input type="checkbox"/> DN		
DN-12			<input type="checkbox"/> Station, <input type="checkbox"/> DN		

PF Key	PF Key Type	Number	DSS Key	DSS Key Type	Number
01			01		
02			02		
03			03		
04			04		
05			05		
06			06		
07			07		
08			08		
09					
10					
11					
12					

EXTENSION-STATION

Station Equipment No.

Item	Set Data
Telephone Type and Model	Type _____ Model _____
OHCA Circuit	<input type="checkbox"/> Yes, <input type="checkbox"/> No
Primary Directory Number	_____
Intercom Number	_____
Station Name	_____
ICM Group	_____
Pickup Group	_____ <input type="checkbox"/> None
Next Hunt Station	<input type="checkbox"/> _____ <input type="checkbox"/> None
Class of Service	_____
Da?a Line Security	ayes, <input type="checkbox"/> No
Automatic Callback-Trunk	<input type="checkbox"/> <input type="checkbox"/>
Parallel Connect	<input type="checkbox"/> Yes, <input type="checkbox"/>

Key	Key Type	Number	SDN COS	Day Ring	Night Ring
DN-01	PDN		<input type="checkbox"/> Station, <input type="checkbox"/> DN		
DN-02			<input type="checkbox"/> Station, <input type="checkbox"/> DN		
DN-03			<input type="checkbox"/> Station, <input type="checkbox"/> DN		
DN-04			<input type="checkbox"/> Station, <input type="checkbox"/> DN		
DN-05			<input type="checkbox"/> Station, <input type="checkbox"/> DN		
DN-06			<input type="checkbox"/> Station, <input type="checkbox"/> DN		
DN-07			<input type="checkbox"/> Station, <input type="checkbox"/> DN		
DN-08			<input type="checkbox"/> Station, <input type="checkbox"/> DN		
DN-09			<input type="checkbox"/> Station, <input type="checkbox"/> DN		
DN-10			<input type="checkbox"/> Station, <input type="checkbox"/> DN		
DN-11			<input type="checkbox"/> Station, <input type="checkbox"/> DN		
DN-12			<input type="checkbox"/> Station, <input type="checkbox"/> DN		

PF Key	PF Key Type	Number	DSS Key	DSS Key Type	Number
0	1		01		
			02		
			03		
			04		
			05		
			06		
			07		
			08		

EXTENSION-STATION

Station Equipment No.

Item	Set Data
Telephone Type and Model	Type _____ Model _____
OHCA Circuit	<input type="checkbox"/> <input type="checkbox"/> No
Primary Directory Number	_____
Intercom Number	_____
Station Name	_____
ICM Group	_____
Pickup Group	- - <input type="checkbox"/> None
Next Hunt Station	<input type="checkbox"/> _____ <input type="checkbox"/> None
Class of Service	
Data Line Security	
Automatic Callback-Trunk	<input type="checkbox"/> Yes, <input type="checkbox"/>
Parallel Connect	<input type="checkbox"/> Yes, <input type="checkbox"/>

Key	Key Type	Number	SDN COS	Day Ring	Night Ring
DN-01	PDN		<input type="checkbox"/> Station, <input type="checkbox"/> DN		
DN-02			<input type="checkbox"/> Station, nC)N		
DN-03			<input type="checkbox"/> Station, nDN		
DN-04			<input type="checkbox"/> Station, <input type="checkbox"/> C)N		
DN-05			<input type="checkbox"/> Station, <input type="checkbox"/> DN		
DN-06			<input type="checkbox"/> Station, J)C)N		
DN-07			<input type="checkbox"/> Station, <input type="checkbox"/> DN		
DN-08			<input type="checkbox"/> Station, <input type="checkbox"/> DN		
DN-09			<input type="checkbox"/> Station, <input type="checkbox"/> DN		
DN-10			<input type="checkbox"/> Station, <input type="checkbox"/> DN		
DN-11			<input type="checkbox"/>)Station, uDN		
DN-12			<input type="checkbox"/> Station, nDN		

PF Key	PF Key Type	Number
01		
02		
03		
04		
05		
06		
07		
08		
09		
10		
11		
12		

DSS Key	DSS Key Type	Number
01		
02		
03		
04		
05		
06		
07		
08		

EXTENSION-STATION

Station Equipment No.

Item	Set Data
Telephone Type and Model	Type _____ Model _____
OHCA Circuit	<input type="checkbox"/> Yes, <input type="checkbox"/> <input type="checkbox"/>
Primary Directory Number	- - - - -
Intercom Number	- - -
Station Name	_____
ICM Group	_____
Pickup Group	_____ <input type="checkbox"/> None
Next Hunt Station	<input type="checkbox"/> EXT <input type="checkbox"/> None _____
Class of Service	- -
Data Line Security	<input type="checkbox"/> Yes, <input type="checkbox"/> <input type="checkbox"/>
Automatic Callback-Trunk	<input type="checkbox"/> Yes, <input type="checkbox"/> No
Parallel Connect	<input type="checkbox"/> Yes, <input type="checkbox"/> No

Key	Key Type	Number	SDN COS	Day Ring	Night Ring
DN-01	PDN		<input type="checkbox"/> Station, <input type="checkbox"/> DN		
DN-02			<input type="checkbox"/> Station, <input type="checkbox"/> DN		
DN-03			<input type="checkbox"/> Station, <input type="checkbox"/> DN		
DN-04			<input type="checkbox"/> Station, <input type="checkbox"/> DN		
DN-05			<input type="checkbox"/> Station, <input type="checkbox"/> DN		
DN-06			<input type="checkbox"/> Station, <input type="checkbox"/> DN		
DN-07			<input type="checkbox"/> Station, <input type="checkbox"/> DN		
DN-08			<input type="checkbox"/> Station, <input type="checkbox"/> DN		
DN-09			<input type="checkbox"/> Station, <input type="checkbox"/> DN		
DN-10			<input type="checkbox"/> Station, <input type="checkbox"/> DN		
DN-11			<input type="checkbox"/> Station, <input type="checkbox"/> DN		
DN-12			<input type="checkbox"/> Station, <input type="checkbox"/> DN		

PF Key	PF Key Type	Number	DSS Key	DSS Key Type	Number
01			01		
02			02		
03			03		
04			04		
05			05		
06			06		
07			07		
08			08		
09					
10					
11					
12					

EXTENSION-STATION

Station Equipment No.

Item	Set Data
Telephone Type and Model	Type _____ Model _____
OHCA Circuit	<input type="checkbox"/> Yes, <input type="checkbox"/> No
Primary Directory Number	- - - -
Intercom Number	- -
Station Name	-----
ICM Group	---
Pickup Group	- - 0 None
Next Hunt Station	<input type="checkbox"/> EXT - - - - <input type="checkbox"/> None
Class of Service	- -
Data Line Security	<input type="checkbox"/> Yes, <input type="checkbox"/> No
Automatic Callback-Trunk	<input type="checkbox"/> Yes, <input type="checkbox"/> No
Parallel Connect	<input type="checkbox"/> Yes, <input type="checkbox"/> No

Key	Key Type	Number	SDN COS	Day Ring	Night Ring
DN-01	PDN		<input type="checkbox"/> Station, <input type="checkbox"/> DN		
DN-02			<input type="checkbox"/> Station, <input type="checkbox"/> DN		
DN-03			<input checked="" type="checkbox"/> Station, nDN		
DN-04			<input type="checkbox"/> Station, <input type="checkbox"/> DN		
DN-05			<input type="checkbox"/> Station, <input type="checkbox"/> DN		
DN-06			<input type="checkbox"/> Station, <input type="checkbox"/> DN		
DN-07			<input type="checkbox"/> Station, <input type="checkbox"/> DN		
DN-08			<input type="checkbox"/> Station, <input type="checkbox"/> DN		
DN-09			<input type="checkbox"/> Station, <input type="checkbox"/> DN		
DN-10			<input type="checkbox"/> Station, <input type="checkbox"/> DN		
DN-11			<input type="checkbox"/> Station, <input type="checkbox"/> DN		
DN-12			<input type="checkbox"/> Station, <input type="checkbox"/> DN		

PF Key	PF Key Type	Number	DSS Key	DSS Key Type	Number
01			01		
02			02		
03			03		
04			04		
05			05		
06			06		
07			07		
08			08		
09					
10					
11					
12					

EXTENSION-STATION

Station Equipment No.

Item	Set Data
Telephone Type and Model	Type _____ Model _____
OHCA Circuit	<input type="checkbox"/> <input type="checkbox"/>
Primary Directory Number	_____
Intercom Number	_____
Station Name	_____
ICM Group	_____
Pickup Group	_____ <input type="checkbox"/> None
Next Hunt Station	<input type="checkbox"/> IEXT _____ <input type="checkbox"/> None
Class of Service	_____
Data Line Security	<input type="checkbox"/> <input type="checkbox"/>
Automatic Callback-Trunk	<input type="checkbox"/> Yes, <input type="checkbox"/>
Parallel Connect	<input type="checkbox"/> Yes, <input type="checkbox"/> No

Key	Key Type	Number	SDN COS	Day Ring	Night Ring
DN-01	PDN		<input type="checkbox"/> Station, <input type="checkbox"/> DN		
DN-02			<input type="checkbox"/> Station, <input type="checkbox"/> DN		
DN-03			<input type="checkbox"/> Station, <input type="checkbox"/> DN		
DN-04			<input type="checkbox"/> Station, <input type="checkbox"/> DN		
DN-05			<input type="checkbox"/> Station, <input type="checkbox"/> DN		
DN-06			<input type="checkbox"/> Station, <input type="checkbox"/> DN		
DN-07			<input type="checkbox"/> Station, <input type="checkbox"/> DN		
DN-08			<input type="checkbox"/> Station, <input type="checkbox"/> DN		
DN-09			<input type="checkbox"/> Station, <input type="checkbox"/> DN		
DN-10			<input type="checkbox"/> Station, <input type="checkbox"/> DN		
DN-11			<input type="checkbox"/> Station, <input type="checkbox"/> DN		
DN-12			<input type="checkbox"/> Station, <input type="checkbox"/> DN		

PF Key	PF Key Type	Number	DSS Key	DSS Key Type	Number
01			01		
02			02		
03			03		
04			04		
05			05		
06			06		
07			07		
08			08		
09					
10					
11					
12					

EXTENSION-STATION

Station Equipment No.

Item	Set Data
Telephone Type and Model	Type _____ Model _____
OHCA Circuit	<input type="checkbox"/> Yes, <input type="checkbox"/> No
Primary Directory Number	- - - -
Intercom Number	- -
Station Name	_____
ICM Group	_____
Pickup Group	- - <input type="checkbox"/> None
Next Hunt Station	<input type="checkbox"/> _____ <input type="checkbox"/> None
Class of Service	- -
Data Line Security	<input type="checkbox"/> <input type="checkbox"/> No
Automatic Callback-Trunk	<input type="checkbox"/> Yes, <input type="checkbox"/> No
Parallel Connect	<input type="checkbox"/> Yes, <input type="checkbox"/> No

Key	Key Type	Number	SDN COS	Day Ring	Night Ring
DN-01	PDN		<input type="checkbox"/> Station, <input type="checkbox"/> DN		
DN-02			<input type="checkbox"/> Station,ODN		
DN-03			<input type="checkbox"/>]Station,nDN		
DN-04			<input type="checkbox"/> Station, <input type="checkbox"/> DN		
DN-05			<input type="checkbox"/> Station, <input type="checkbox"/> DN		
DN-08			<input type="checkbox"/> Station, <input type="checkbox"/> DN		
DN-07			<input type="checkbox"/> Station,nDN		
DN-08			<input type="checkbox"/> Station,ODN		
DN-09			<input type="checkbox"/> Station, <input type="checkbox"/> DN		
DN-10			<input type="checkbox"/> Station, <input type="checkbox"/> DN		
DN-11			<input type="checkbox"/> Station, <input type="checkbox"/> DN		
DN-12			<input type="checkbox"/>]Station, <input type="checkbox"/> DN		

PF Key	PF Key Type	Number	DSS Key	DSS Key Type	Number
01			01		
02			02		
03			03		
04			04		
05			05		
06			06		
07			07		
08			08		
09					
10					
11					
12					

EXTENSION-STATION

Station Equipment No.

item	Set Data
Telephone Type and Model	Type _____ Model _____
OHCA Circuit	<input type="checkbox"/> <input type="checkbox"/> <input type="checkbox"/> <input type="checkbox"/> <input type="checkbox"/> No
Primary Directory Number	_____
Intercom Number	_____
Station Name	_____
ICM Group	
Pickup Group	_____ J None
Next Hunt Station	<input type="checkbox"/> EXT _____ <input type="checkbox"/> None
Class of Service	_____
Data Line Security	<input type="checkbox"/> <input type="checkbox"/> <input type="checkbox"/> <input type="checkbox"/> No
Automatic Callback-Trunk	<input type="checkbox"/> <input type="checkbox"/> <input type="checkbox"/> <input type="checkbox"/> No
Parallel Connect	<input type="checkbox"/> <input type="checkbox"/> <input type="checkbox"/> <input type="checkbox"/> No

Key	Key Type	Number	SDN	C-OS	Day Ring	Night Ring
DN-01	PDN		<input type="checkbox"/> Station,	<input type="checkbox"/> DN		
DN-02			<input type="checkbox"/> Station,	<input type="checkbox"/> DN		
DN-03			<input type="checkbox"/> Station,	JDN		
DN-04			<input type="checkbox"/> Station,	<input type="checkbox"/> DN		
DN-05			<input type="checkbox"/> Station,	<input type="checkbox"/> DN		
ON-06			<input type="checkbox"/> Station,	<input type="checkbox"/> DN		
DN-07			<input type="checkbox"/> Station,	<input type="checkbox"/> DN		
ON-08			<input type="checkbox"/> Station,	<input type="checkbox"/> DN		
DN-09			<input type="checkbox"/> Station,	JDN		
DN-10			<input type="checkbox"/> Station,	<input type="checkbox"/> DN		
ON-1 1			<input type="checkbox"/> Station,	JDN		
ON-12			<input type="checkbox"/> Station,	<input type="checkbox"/> DN		

PF Key	PF Key Type	Number	DSS Key	DSS Key Type	Number
01			01		
02			02		
03			03		
04			04		
05			05		
06			06		
07			07		
08			08		
09					
10					
11					
12					

EXTENSION-STATION

Station Equipment No.

Item	Set Data
Telephone Type and Model	Type _____ Model _____
OHCA Circuit	<input type="checkbox"/> Yes, <input type="checkbox"/> No
Primary Directory Number..	_____
Intercom Number	- -
Station Name	_____
ICM Group	_____
Pickup Group	- - <input type="checkbox"/> None
Next Hunt Station	<input type="checkbox"/> <input type="checkbox"/> <input type="checkbox"/> <input type="checkbox"/> <input type="checkbox"/> None
Class of Service	- -
Data Line Security	<input type="checkbox"/> Yes, <input type="checkbox"/> No
Automatic Callback-Trunk	<input type="checkbox"/> <input type="checkbox"/> No
Parallel Connect	<input type="checkbox"/> Yes, <input type="checkbox"/> No

Key	Key Type	Number	SDN COS	Day Ring	Night Ring
DN-01	PDN		<input type="checkbox"/> Station, <input type="checkbox"/> DN		
DN-02			<input type="checkbox"/> Station, <input type="checkbox"/> DN		
DN-03			<input type="checkbox"/> Station, <input type="checkbox"/> DN		
DN-04			<input type="checkbox"/> Station, <input type="checkbox"/> DN		
DN-05			<input type="checkbox"/> Station, <input type="checkbox"/> DN		
DN-06			<input type="checkbox"/> Station, <input type="checkbox"/> DN		
DN-07			<input type="checkbox"/> Station, <input type="checkbox"/> DN		
DN-08			<input type="checkbox"/> Station, <input type="checkbox"/> DN		
DN-09			<input type="checkbox"/> Station, <input type="checkbox"/> DN		
DN-10			<input type="checkbox"/> Station, <input type="checkbox"/> DN		
DN-11			<input type="checkbox"/> Station, <input type="checkbox"/> DN		
DN-12			<input type="checkbox"/> Station, <input type="checkbox"/> DN		

PF Key	PF Key Type	Number
01		
02		
03		
04		
05		
06		
07		
08		
09		
10		
11		
12		

DSS Key	DSS Key Type	Number
01		
02		
03		
04		
05		
06		
07		
08		

EXTENSION-STATION

Station Equipment No.

Item	Set Data
Telephone Type and Model	Type _____ Model _____
OHCA Circuit	<input type="checkbox"/> Yes, <input type="checkbox"/> No
Primary Directory Number	- - - - -
Intercom Number	- -
Station Name	_____
ICM Group	_____
Pickup Group	- - <input type="checkbox"/> None
Next Hunt Station	<input type="checkbox"/> <input type="checkbox"/> _____ <input type="checkbox"/> <input type="checkbox"/>
Class of Service	- -
Data Line Security	<input type="checkbox"/> Yes, <input type="checkbox"/> No
Automatic Callback-Trunk	<input type="checkbox"/> Yes, <input type="checkbox"/> No
Parallel Connect	<input type="checkbox"/> Yes, <input type="checkbox"/> No

Key	Key Type	Number	SDN COS	Day Ring	Night Ring
DN-01	PDN		<input type="checkbox"/> Station, <input type="checkbox"/> DN		
DN-02			<input type="checkbox"/> Station, <input type="checkbox"/> DN		
DN-03			<input type="checkbox"/> Station, <input type="checkbox"/> DN		
DN-04			<input type="checkbox"/> Station, <input type="checkbox"/> DN		
DN-05			<input type="checkbox"/> Station, <input type="checkbox"/> DN		
DN-06			<input type="checkbox"/> Station, <input type="checkbox"/> DN		
DN-07			<input type="checkbox"/> Station, <input type="checkbox"/> DN		
DN-08			<input type="checkbox"/> Station, <input type="checkbox"/> DN		
DN-09			<input type="checkbox"/> Station, <input type="checkbox"/> DN		
DN-10			<input type="checkbox"/> Station, <input type="checkbox"/> DN		
DN-11			<input type="checkbox"/> Station, <input type="checkbox"/> DN		
DN-12			<input type="checkbox"/> Station, <input type="checkbox"/> DN		

PF Key	PF Key Type	Number	DSS Key	DSS Key Type	Number
01			01		
02			02		
03			03		
04			04		
05			05		
06			06		
07			07		
08			08		
09					
10					
11					
12					

EXTENSION-STATION

Station Equipment No.

item	Set Data
Telephone Type and Model	Type _____ Model _____
OHCA Circuit	<input type="checkbox"/> <input type="checkbox"/>
Primary Directory Number	- - - - -
Intercom Number	- -
Station Name	_____
ICM Group	_____
Pickup Group	- - <input type="checkbox"/> <input type="checkbox"/>
Next Hunt Station	<input type="checkbox"/> <input type="checkbox"/> _____ <input type="checkbox"/> None
Class of Service	- -
Data Line Security	<input type="checkbox"/> <input type="checkbox"/> <input type="checkbox"/> No
Automatic Callback-Trunk	<input type="checkbox"/> Yes, <input type="checkbox"/> No
Parallel Connect	<input type="checkbox"/> <input type="checkbox"/>

Key	Key Type	Number	SDN COS	Day Ring	Night Ring
DN-01	PDN		<input type="checkbox"/> Station, <input type="checkbox"/> DN		
DN-02			<input type="checkbox"/> Station, <input type="checkbox"/> DN		
DN-03			<input type="checkbox"/> Station, <input type="checkbox"/> DN		
DN-04			<input type="checkbox"/> Station, <input type="checkbox"/> DN		
DN-05			<input type="checkbox"/> Station, <input type="checkbox"/> DN		
DN-06			<input type="checkbox"/> Station, <input type="checkbox"/> DN		
DN-07			<input type="checkbox"/> Station, <input type="checkbox"/> DN		
DN-08			<input type="checkbox"/> Station, <input type="checkbox"/> DN		
DN-09			<input type="checkbox"/> Station, <input type="checkbox"/> DN		
DN-10			<input type="checkbox"/> Station, <input type="checkbox"/> DN		
DN-11			<input type="checkbox"/> Station, <input type="checkbox"/> DN		
DN-12			<input type="checkbox"/> Station, <input type="checkbox"/> DN		

PF Key	PF Key Type	Number
01		
02		
03		
04		
05		
06		
07		
08		
09		
10		
11		
12		

DSS Key	DSS Key Type	Number
01		
02		
03		
04		
05		
06		
07		
08		

EXTENSION-STATION

Station Equipment No.

Item	Set Data
Telephone Type and Model	Type _____ Model _____
OHCA Circuit	<input type="checkbox"/> Yes, <input type="checkbox"/> No
Primary Directory Number	_____
Intercom Number	- -
Station Name	_____
ICMGroup	_____
Pickup Group	- - <input type="checkbox"/> None
Next Hunt Station	<input type="checkbox"/> EXT _____ <input type="checkbox"/> None
Class of Service	- -
Data Line Security	<input type="checkbox"/> Yes, <input type="checkbox"/> No
Automatic Callback-Trunk	<input type="checkbox"/> Yes, <input type="checkbox"/> No
Parallel Connect	<input type="checkbox"/> Yes, <input type="checkbox"/> No

Key	Key Type	Number	SDN COS	Day Ring	Night Ring
DN-01	PDN		<input type="checkbox"/> Station, nDN		
DN-02			<input type="checkbox"/> Station, C]DN		
DN-03			<input type="checkbox"/> Station, <input type="checkbox"/> DN		
DN-04			<input type="checkbox"/> Station, <input type="checkbox"/> DN		
DN-05			<input type="checkbox"/> Station, <input type="checkbox"/> DN		
DN-06			<input type="checkbox"/> Station, <input type="checkbox"/> DN		
DN-07			<input type="checkbox"/> Station, f]DN		
DN-08			<input type="checkbox"/> Station, <input type="checkbox"/> DN		
DN-09			<input type="checkbox"/> Station, <input type="checkbox"/> DN		
DN-10			<input type="checkbox"/> Station, <input type="checkbox"/> DN		
DN-11			<input type="checkbox"/> Station, <input type="checkbox"/> DN		
DN-12			<input type="checkbox"/> Station, <input type="checkbox"/> DN		

PF Key	PF Key Type	Number
01		
02		
03		
04		
05		
06		
07		
08		
09		
10		
11		
12		

DSS Key	DSS Key Type	Number
01		
02		
03		
04		
05		
06		
07		
08		

EXTENSION-STATION

Station Equipment No.

Item	Set Data
Telephone Type and Model	Type _____ Model _____
CHCA Circuit	<input type="checkbox"/> <input type="checkbox"/> No
Primary Directory Number	
Intercom Number	
Station Name	
CM Group	_____
Pickup Group	<input type="checkbox"/> None
Next Hunt Station	<input type="checkbox"/> <input type="checkbox"/> None
Class of Service	
Data Line Security	<input type="checkbox"/> <input type="checkbox"/>
Automatic Callback-Trunk	<input type="checkbox"/> <input type="checkbox"/> No
Parallel Connect	<input type="checkbox"/> <input type="checkbox"/> No

Key	Key Type	Number	SDN COS	Day Ring	Night Ring
DN-01	PDN		<input type="checkbox"/> Station, <input type="checkbox"/> DN		
DN-02			<input type="checkbox"/> Station, <input type="checkbox"/> DN		
DN-03			<input type="checkbox"/> Station, <input type="checkbox"/> DN		
DN-04			<input type="checkbox"/> Station, <input type="checkbox"/> DN		
DN-05			<input type="checkbox"/> Station, <input type="checkbox"/> DN		
DN-06			<input type="checkbox"/> Station, <input type="checkbox"/> DN		
DN-07			<input type="checkbox"/> Station, <input type="checkbox"/> DN		
DN-08			<input type="checkbox"/> Station, <input type="checkbox"/> DN		
DN-09			<input type="checkbox"/> Station, <input type="checkbox"/> DN		
DN-10			<input type="checkbox"/> Station, <input type="checkbox"/> DN		
DN-11			<input type="checkbox"/> Station.ODN		
DN-12			<input type="checkbox"/> Station.ODN		

PF Key	PF Key Type	Number
01		
02		
03		
04		
05		
06		
07		
08		
09		
10		
12		

DSS Key	DSS Key Type	Number
01		
02		
03		
04		
05		
06		
07		
08		

EXTENSION-STATION

Station Equipment No.

Item	Set Data
Telephone Type and Model	Type _____ Model _____
OHCA Circuit	<input type="checkbox"/> Yes, <input type="checkbox"/> Yes
Primary Directory Number	- - - - -
Intercom Number	- -
Station Name	-----
ICM Group	---
Pickup Group	- - 0 None
Next Hunt Station	<input type="checkbox"/> EXT - - - - <input type="checkbox"/> None
Class of Service	- -
Data Line Security	<input type="checkbox"/> Yes, <input type="checkbox"/> Yes
Automatic Callback-Trunk	<input type="checkbox"/> Yes, <input type="checkbox"/> No
Parallel Connect	<input type="checkbox"/> Yes, <input type="checkbox"/> Yes

Key	Key Type	Number	SDN COS	Day Ring	Night Ring
DN-01	PDN		<input type="checkbox"/> Station, <input type="checkbox"/> DN		
DN-02			<input type="checkbox"/> Station, ODN		
DN-03			<input type="checkbox"/> Station, <input type="checkbox"/> DN		
DN-04			<input type="checkbox"/> Station, <input type="checkbox"/> DN		
DN-05			<input type="checkbox"/> Station, <input type="checkbox"/> DN		
DN-06			<input type="checkbox"/> Station, uDN		
DN-07			<input type="checkbox"/> StatioQJDN		
DN-08			<input type="checkbox"/> Station.nDN		
DN-09			<input type="checkbox"/> Station, <input type="checkbox"/> DN		
DN-10			<input type="checkbox"/> Station, <input type="checkbox"/> DN		
DN-11			<input type="checkbox"/> Station.nDN		
DN-12			<input type="checkbox"/> Station, <input type="checkbox"/> DN		

PF Key	PF Key Type	Number
01		
02		
03		
04		
05		
06		
07		
08		
09		
10		
11		
12		

DSS Key	DSS Key Type	Number
01		
02		
03		
04		
05		
06		
07		
08		

EXTENSION-STATION

Station Equipment No.

Item	Set Data
Telephone Type and Model	Type _____ Model _____
OHCA Circuit	<input type="checkbox"/> <input type="checkbox"/> <input type="checkbox"/> <input type="checkbox"/> No
Primary Directory Number	- - - -
Intercom Number	- -
Station Name	_____
ICM Group	_____
Pickup Group	- - <input type="checkbox"/> None
Next Hunt Station	<input type="checkbox"/> <input type="checkbox"/> <input type="checkbox"/> _____ <input type="checkbox"/> None
Class of Service	- -
Data Line Security	<input type="checkbox"/> Yes, <input type="checkbox"/> No
Automatic Callback-Trunk	<input type="checkbox"/> Yes, <input type="checkbox"/> No
Parallel Connect	<input type="checkbox"/> <input type="checkbox"/> <input type="checkbox"/> <input type="checkbox"/> No

Key	Key Type	Number	SDN COS	Day Ring	Night Ring
DN-01	PDN		<input type="checkbox"/> Station, <input type="checkbox"/> DN		
DN-02			<input type="checkbox"/> Station, <input type="checkbox"/> DN		
DN-03			<input type="checkbox"/> Station, <input type="checkbox"/> DN		
DN-04			<input type="checkbox"/> Station, <input type="checkbox"/> DN		
DN-05			<input type="checkbox"/> Station, <input type="checkbox"/> DN		
DN-06			<input type="checkbox"/> Station, <input type="checkbox"/> DN		
DN-07			<input type="checkbox"/> Station, <input type="checkbox"/> DN		
DN-08			<input type="checkbox"/> Station, <input type="checkbox"/> DN		
DN-09			<input type="checkbox"/> Station, <input type="checkbox"/> DN		
DN-10			<input type="checkbox"/> Station, <input type="checkbox"/> DN		
DN-11			<input type="checkbox"/> Station, <input type="checkbox"/> DN		
DN-12			<input type="checkbox"/> Station, <input type="checkbox"/> DN		

PF Key	PF Key Type	Number
01		
02		
03		
04		
05		
06		
07		
08		
09		
10		
11		
12		

DSS Key	DSS Key Type	Number
01		
02		
03		
04		
05		
06		
07		
08		

EXTENSION-STATION

Station Equipment No.

Item	Set Data
Telephone Type and Model	Type _____ Model _____
OHCA Circuit	<input type="checkbox"/> <input type="checkbox"/> No
Primary Directory Number	- - - - -
Intercom Number	- -
Station Name	- - - - -
ICM Group	---
Pickup Group	- - <input type="checkbox"/> None
Next Hunt Station	<input type="checkbox"/> _____ <input type="checkbox"/> None
Class of Service	- -
Data Line Security	<input type="checkbox"/> Yes, <input type="checkbox"/> No
Automatic Callback-Trunk	<input type="checkbox"/> <input type="checkbox"/> No
Parallel Connect	<input type="checkbox"/> Yes, <input type="checkbox"/> No

Key	Key Type	Number	SDN COS	Day Ring	Night Ring
DN-01	PDN		<input type="checkbox"/> Station, <input type="checkbox"/> DN		
DN-02			<input type="checkbox"/> Station, <input type="checkbox"/> DN		
DN-03			<input type="checkbox"/> Station, <input type="checkbox"/> DN		
DN-04			<input type="checkbox"/> Station, <input type="checkbox"/> DN		
DN-05			<input type="checkbox"/> Station, <input type="checkbox"/> DN		
DN-06			<input type="checkbox"/> Station, <input type="checkbox"/> DN		
DN-07			<input type="checkbox"/> Station, <input type="checkbox"/> DN		
DN-08			<input type="checkbox"/> Station, <input type="checkbox"/> DN		
DN-09			<input type="checkbox"/> Station, <input type="checkbox"/> DN		
DN-10			<input type="checkbox"/> Station, <input type="checkbox"/> DN		
DN-11			<input type="checkbox"/> Station, <input type="checkbox"/> DN		
DN-12			<input type="checkbox"/> Station, <input type="checkbox"/> DN		

PF Key	PF Key Type	Number
01		
02		
03		
04		
05		
06		
07		
08		
09		
10		
11		
12		

DSS Key	DSS Key Type	Number
01		
02		
03		
04		
05		
06		
07		
08		

EXTENSION-STATION

Station Equipment No.

Item	Set Data
Telephone Type and Model	Type _____ Model _____
OHCA Circuit	<input type="checkbox"/> Yes, <input type="checkbox"/> No
Primary Directory Number	_____
intercom Number	- -
Station Name	_____
ICM Group	_____
Pickup Group	- - 0 None
Next Hunt Station	<input type="checkbox"/> <input type="checkbox"/> None
Class of Service	- -
Data Line Security	<input type="checkbox"/> Yes, <input type="checkbox"/> No
Automatic Callback-Trunk	<input type="checkbox"/> Yes, <input type="checkbox"/> No
Parallel Connect	<input type="checkbox"/> Yes, <input type="checkbox"/> No

Key	Key Type	Number	SDN COS	Day Ring	Night Ring
DN-01	PDN		<input type="checkbox"/> Station, <input type="checkbox"/> DN		
DN-02			<input type="checkbox"/> Station, <input type="checkbox"/> DN		
DN-03			<input type="checkbox"/> Station, <input type="checkbox"/> DN		
DN-04			<input type="checkbox"/> Station, <input type="checkbox"/> DN		
DN-05			<input type="checkbox"/> Station, <input type="checkbox"/> DN		
DN-06			<input type="checkbox"/> Station, <input type="checkbox"/> DN		
DN-07			<input type="checkbox"/> Station, <input type="checkbox"/> DN		
DN-08			<input type="checkbox"/> Station, <input type="checkbox"/> DN		
DN-09			<input type="checkbox"/> Station, <input type="checkbox"/> DN		
DN-10			<input type="checkbox"/> Station, <input type="checkbox"/> DN		
DN-11			<input type="checkbox"/> Station, <input type="checkbox"/> DN		
DN-12			<input type="checkbox"/> Station, <input type="checkbox"/> DN		

PF Key	PF Key Type	Number	DSS Key	DSS Key Type	Number
01			01		
02			02		
03			03		
04			04		
05			05		
06			06		
07			07		
08			08		
09					
10					
11					
12					

EXTENSION-STATION

Station Equipment No.

Item	Set Data
Telephone Type and Model	Type _____ Model _____
OHCA Circuit	<input type="checkbox"/> Yes, <input type="checkbox"/> No
Primary Directory Number	_____
Intercom Number	_____
Station Name	_____
ICM Group	_____
Pickup Group	_____ C None
Next Hunt Station	<input type="checkbox"/> No <input type="checkbox"/> 1 <input type="checkbox"/> 2 <input type="checkbox"/> 3 <input type="checkbox"/> 4 <input type="checkbox"/> None
Class of Service	_____
Data Line Security	<input type="checkbox"/> No <input type="checkbox"/> Yes
Automatic Callback-Trunk	<input type="checkbox"/> No <input type="checkbox"/> Yes
Parallel Connect	<input type="checkbox"/> Yes, <input type="checkbox"/> No

Key	Key Type	Number	SDN COS	Day Ring	Night Ring
DN-01	PDN		<input type="checkbox"/> Station, <input type="checkbox"/> DN		
DN-02			<input type="checkbox"/> Station, <input type="checkbox"/> DN		
DN-03			<input type="checkbox"/> Station, <input type="checkbox"/> DN		
DN-04			<input type="checkbox"/> Station, <input type="checkbox"/> DN		
DN-05			<input type="checkbox"/> Station, <input type="checkbox"/> DN		
DN-06			<input type="checkbox"/> Station, <input type="checkbox"/> DN		
DN-07			<input type="checkbox"/> Station, <input type="checkbox"/> DN		
DN-08			<input type="checkbox"/> Station, ODN		
DN-09			<input type="checkbox"/> Station, <input type="checkbox"/> DN		
DN-10			<input type="checkbox"/> Station, <input type="checkbox"/> DN		
DN-11			<input type="checkbox"/> Station, <input type="checkbox"/> DN		
DN-12			<input type="checkbox"/> Station, <input type="checkbox"/> DN		

PF Key	PF Key Type	Number	DSS Key	DSS Key Type	Number
01			01		
02			02		
03			03		
04			04		
05			05		
06			06		
07			07		
08			08		
09					
10					
11					
12					

EXTENSION-STATION

Station Equipment No.

Item	Set Data
Telephone Type and Model	Type _____ Model _____
OHCA Circuit	<input type="checkbox"/> Yes <input type="checkbox"/> No
Primary Directory Number	- - - - -
Intercom Number	- - -
Station Name	_____
ICM Group	_____
Pickup Group	- - - 0 None
Next Hunt Station	<input type="checkbox"/> EXT <input type="checkbox"/> None _____
Class of Service	- - -
Data Line Security	<input type="checkbox"/> Yes <input type="checkbox"/> No
Automatic Callback-Trunk	<input type="checkbox"/> Yes <input type="checkbox"/> No
Parallel Connect	<input type="checkbox"/> Yes <input type="checkbox"/> No

Key	Key Type	Number	SDN COS	Day Ring	Night Ring
DN-01	PDN		<input type="checkbox"/> Station, <input type="checkbox"/> DN		
DN-02			<input type="checkbox"/> Station, <input type="checkbox"/> DN		
DN-03			<input type="checkbox"/> Station, <input type="checkbox"/> DN		
DN-04			<input type="checkbox"/> Station, <input type="checkbox"/> DN		
DN-05			<input type="checkbox"/> Station, <input type="checkbox"/> DN		
DN-06			<input type="checkbox"/> Station, <input type="checkbox"/> DN		
DN-07			<input type="checkbox"/> Station, <input type="checkbox"/> DN		
DN-08			<input type="checkbox"/> Station, <input type="checkbox"/> DN		
DN-09			<input type="checkbox"/> Station, <input type="checkbox"/> DN		
DN-10			<input type="checkbox"/> Station, <input type="checkbox"/> DN		
DN-11			<input type="checkbox"/> Station, <input type="checkbox"/> DN		
DN-12			<input type="checkbox"/> Station, <input type="checkbox"/> DN		

PF Key	PF Key Type	Number	DSS Key	DSS Key Type	Number
01			01		
02			02		
03			03		
04			04		
05			05		
06			06		
07			07		
08			06		
09					
10					
11					
12					

EXTENSION-STATION

Station Equipment No.

Item	Set Data
Telephone Type and Model	Type _____ Model _____
OHCA Circuit	<input type="checkbox"/> Yes, <input type="checkbox"/> No
Primary Directory Number	_____
intercom Number	_____
Station Name	_____
ICM Group	_____
Pickup Group	_____ <input type="checkbox"/> None
Next Hunt Station	<input type="checkbox"/> _____ <input type="checkbox"/> None
Class of Service	_____
Data Line Security	D yes, <input type="checkbox"/> No
Automatic Callback-Trunk	<input type="checkbox"/> <input type="checkbox"/> No
Parallel Connect	<input type="checkbox"/> Yes, <input type="checkbox"/> No

Key	Key Type	Number	SDN COS	Day Ring	Night Ring
DN-01	PDN		<input type="checkbox"/> Station, <input type="checkbox"/> DN		
DN-02			<input type="checkbox"/> Station, <input type="checkbox"/> DN		
DN-03			<input type="checkbox"/> Station, <input type="checkbox"/> DN		
DN-04			<input type="checkbox"/> Station, <input type="checkbox"/> DN		
DN-05			<input type="checkbox"/> Station, <input type="checkbox"/> DN		
DN-06			<input type="checkbox"/> Station, <input type="checkbox"/> DN		
DN-07			<input type="checkbox"/> Station, <input type="checkbox"/> DN		
DN-08			<input type="checkbox"/> Station, <input type="checkbox"/> DN		
DN-09			<input type="checkbox"/> Station, <input type="checkbox"/> DN		
DN-10			<input type="checkbox"/> Station, <input type="checkbox"/> DN		
DN-11			<input type="checkbox"/> Station, <input type="checkbox"/> DN		
DN-12			<input type="checkbox"/> Station, <input type="checkbox"/> DN		

PF Key	PF Key Type	Number
01		
02		
03		
04		
05		
06		
07		
08		
09		
10		
11		
12		

DSS Key	DSS Key Type	Number
01		
02		
03		
04		
05		
06		
07		
08		

EXTENSION-STATION

Station Equipment No.

item	Set Data
Telephone Type and Model	Type _____ Model _____
OHCA Circuit	<input type="checkbox"/> <input type="checkbox"/> No
Primary Directory Number	
Intercom Number	
Station Name	
ICM Group	---
Pickup Group	___ <input type="checkbox"/> None
Next Hunt Station	<input type="checkbox"/> _____ <input type="checkbox"/> None
Class of Service	
Data Line Security	<input type="checkbox"/> <input type="checkbox"/>
Automatic Callback-Trunk	<input type="checkbox"/> <input type="checkbox"/>
Parallel Connect	<input type="checkbox"/> Yes, <input type="checkbox"/> <input type="checkbox"/>

Key	Key Type	Number	SDN COS	Day Ring	Night Ring
DN-01	PDN		<input type="checkbox"/> Station, <input type="checkbox"/> DN		
DN-02			<input type="checkbox"/> Station, <input type="checkbox"/> DN		
DN-03			<input type="checkbox"/> Station, <input type="checkbox"/> DN		
DN-04			<input type="checkbox"/> Station, <input type="checkbox"/> DN		
DN-05			<input type="checkbox"/> Station, <input type="checkbox"/> DN		
DN-06			<input type="checkbox"/> Station, <input type="checkbox"/> DN		
DN-07			<input type="checkbox"/> Station, <input type="checkbox"/> DN		
DN-08			<input type="checkbox"/> Station, <input type="checkbox"/> DN		
DN-09			<input type="checkbox"/> Station, <input type="checkbox"/> DN		
DN-10			<input type="checkbox"/> Station, <input type="checkbox"/> DN		
DN-11			<input type="checkbox"/> Station, <input type="checkbox"/> DN		
DN-12			<input type="checkbox"/> Station, <input type="checkbox"/> DN		

PF Key	PF Key Type	Number
01		
02		
03		
04		
05		
06		
07		
08		
09		
10		
11		
12		

DSS Key	DSS Key Type	Number
01		
02		
03		
04		
05		
06		
07		
08		

EXTENSION-STATION

Station Equipment No.

Item	Set Data
Telephone Type and Model	Type _____ Model _____
OHCA Circuit	<input type="checkbox"/> <input type="checkbox"/> No
Primary Directory Number	_____
intercom Number	<input type="checkbox"/> <input type="checkbox"/>
Station Name	<input type="checkbox"/> <input type="checkbox"/> <input type="checkbox"/> <input type="checkbox"/> <input type="checkbox"/> <input type="checkbox"/> <input type="checkbox"/> <input type="checkbox"/> <input type="checkbox"/> <input type="checkbox"/> <input type="checkbox"/>
ICM Group	
Pickup Group	_____ <input type="checkbox"/> None
Next Hunt Station	<input type="checkbox"/> <input type="checkbox"/> <input type="checkbox"/> <input type="checkbox"/> <input type="checkbox"/> <input type="checkbox"/> <input type="checkbox"/>
Class of Service	<input type="checkbox"/> <input type="checkbox"/>
Data Line Security	<input type="checkbox"/> Yes, <input type="checkbox"/>
Automatic Callback-Trunk	<input type="checkbox"/> Yes, <input type="checkbox"/> No
Parallel Connect	<input type="checkbox"/> Yes, <input type="checkbox"/>

Key	Key Type	Number	SDN COS	Day Ring	Night Ring
DN-01	PDN		<input type="checkbox"/> Station.C]DN		
DN-02			<input type="checkbox"/> Station.ODN		
DN-03			<input type="checkbox"/> Station, <input type="checkbox"/> DN		
DN-04			<input type="checkbox"/> Station, <input type="checkbox"/> DN		
DN-05			<input type="checkbox"/> Station, <input type="checkbox"/> DN		
DN-06			<input type="checkbox"/> Station,nDN		
DN-07			<input type="checkbox"/> Station, <input type="checkbox"/> DN		
DN-08			<input type="checkbox"/> Station, <input type="checkbox"/> DN		
DN-09			<input type="checkbox"/> Station, <input type="checkbox"/> DN		
DN-10			<input type="checkbox"/> Station,ODN		
DN-11			<input type="checkbox"/> Station <input type="checkbox"/> DN		
DN-12			<input type="checkbox"/> Station.nDN		

PF Key	PF Key Type	Number	DSS Key	DSS Key Type	Number
01			01		
02			02		
03			03		
04			04		
05			05		
06			06		
07			07		
08			08		
09					
10					
11					
12					

EXTENSION-STATION

Station Equipment No.

item	Set Data
Telephone Type and Model	Type _____ Model _____
OHCA Circuit	<input type="checkbox"/> Yes, <input type="checkbox"/> No
Primary Directory Number	- - - -
Intercom Number	- -
Station Name	-----
ICM Group	---
Pickup Group	- - <input type="checkbox"/> None
Next Hunt Station	<input type="checkbox"/> EXT _____ <input type="checkbox"/> None
Class of Service	- -
Data Line Security	<input type="checkbox"/> Yes, <input type="checkbox"/> No
Automatic Callback-Trunk	<input type="checkbox"/> Yes, <input type="checkbox"/> No
Parallel Connect	<input type="checkbox"/> Yes, <input type="checkbox"/> No

Key	Key Type	Number	SDN COS	Day Ring	Night Ring
DN-01	PDN		<input type="checkbox"/> Station, <input type="checkbox"/> DN		
DN-02			<input type="checkbox"/> Station, <input type="checkbox"/> DN		
DN-03			<input type="checkbox"/> Station, <input type="checkbox"/> DN		
DN-04			<input type="checkbox"/> Station, <input type="checkbox"/> DN		
DN-05			<input type="checkbox"/> Station, <input type="checkbox"/> DN		
DN-06			<input type="checkbox"/> Station, <input type="checkbox"/> DN		
DN-07			<input type="checkbox"/> Station, <input type="checkbox"/> DN		
DN-08			<input type="checkbox"/> Station, <input type="checkbox"/> DN		
DN-09			<input type="checkbox"/> Station, <input type="checkbox"/> DN		
DN-10			<input type="checkbox"/> Station, <input type="checkbox"/> DN		
DN-11			<input type="checkbox"/> Station, <input type="checkbox"/> DN		
DN-12			<input type="checkbox"/> Station, <input type="checkbox"/> DN		

PF Key	PF Key Type	Number
01		
02		
03		
04		
05		
06		
07		
08		
09		
10		
12		

DSS Key	DSS Key Type	Number
01		
02		
03		
04		
05		
06		
07		
08		

EXTENSION-STATION

Station Equipment No.

Item	Set Data
Telephone Type and Model	Type _____ Model _____
OHCA Circuit	<input type="checkbox"/> <input type="checkbox"/> No
Primary Directory Number	- - - -
intercom Number	- -
Station Name	_____
ICM Group	_____
Pickup Group	- - <input type="checkbox"/> None
Next Hunt Station	<input type="checkbox"/> _____ <input type="checkbox"/> None
Class of Service	- -
Data Line Security	<input type="checkbox"/> <input type="checkbox"/> No
Automatic Callback-Trunk	<input type="checkbox"/> Yes, <input type="checkbox"/> No
Parallel Connect	<input type="checkbox"/> <input type="checkbox"/>

Key	Key Type	Number	SDN COS	Day Ring	Night Ring
DN-01	PDN		<input type="checkbox"/> Station, <input type="checkbox"/> DN		
DN-02			<input type="checkbox"/> Station, <input type="checkbox"/> DN		
DN-03			<input type="checkbox"/> Station, <input type="checkbox"/> DN		
DN-04			<input type="checkbox"/> Station, <input type="checkbox"/> DN		
DN-05			<input type="checkbox"/> Station, <input type="checkbox"/> DN		
DN-06			<input type="checkbox"/> Station, <input type="checkbox"/> DN		
DN-07			<input type="checkbox"/> Station, <input type="checkbox"/> DN		
DN-08			<input type="checkbox"/> Station, <input type="checkbox"/> DN		
DN-09			<input type="checkbox"/> Station, <input type="checkbox"/> DN		
DN-10			<input type="checkbox"/> Station, <input type="checkbox"/> DN		
DN-11			<input type="checkbox"/> Station, <input type="checkbox"/> DN		
DN-12			<input type="checkbox"/> Station, <input type="checkbox"/> DN		

PF Key	PF Key Type	Number	DSS Key	DSS Key Type	Number
01	I-		01		
02			02		
03			03		
04			04		
05			05		
06			06		
07			07		
08			08		
09					
10					
11					
12					

EXTENSION-STATION

Station Equipment No.

Item	Set Data
Telephone Type and Model	Type _____ Model _____
OHCA Circuit	<input type="checkbox"/> Yes, <input type="checkbox"/> No
Primary Directory Number	- - - -
Intercom Number	- -
Station Name	- - - - -
ICM Group	_____
Pickup Group	- - <input type="checkbox"/> None
Next Hunt Station	<input type="checkbox"/> EXT - - - - <input type="checkbox"/> None
Class of Service	- -
Data Line Security	<input type="checkbox"/> Yes, <input type="checkbox"/> No
Automatic Callback-Trunk	<input type="checkbox"/> Yes, <input type="checkbox"/> No
Parallel Connect	<input type="checkbox"/> Yes, <input type="checkbox"/> <input type="checkbox"/>

Key	Key Type	Number	SDN COS	Day Ring	Night Ring
DN-01	PDN		<input type="checkbox"/> Station, <input type="checkbox"/> DN		
DN-02			<input type="checkbox"/> Station, ODN		
DN-03			<input type="checkbox"/> Station, <input type="checkbox"/> DN		
DN-04			<input type="checkbox"/> Station, <input type="checkbox"/> DN		
DN-05			<input type="checkbox"/> Station, /JDN		
DN-06			<input type="checkbox"/> Station, <input type="checkbox"/> DN		
DN-07			<input type="checkbox"/> Station, <input type="checkbox"/> DN		
DN-08			<input type="checkbox"/> Station, ODN		
DN-09			<input type="checkbox"/> Station, <input type="checkbox"/> DN		
DN-10			<input type="checkbox"/> Station, <input type="checkbox"/> DN		
DN-11			<input type="checkbox"/> Station, ODN		
DN-12			<input type="checkbox"/> Station.nDN		

PF Key	PF Key Type	Number
01		
02		
03		
04		
05		
06		
07		
08	I.	
09		
10		
11		
12		

DSS Key	DSS Key Type	Number
01		
02		
03		
04		
05		
06		
07		
08		

EXTENSION-STATION

Station Equipment No.

Item	Set Data
Telephone Type and Model	Type _____ Model _____
OHCA Circuit	<input type="checkbox"/> <input type="checkbox"/> No
Primary Directory Number	_____
Intercom Number	_____
Station Name	_____
ICM Group	
Pickup Group	_____ <input type="checkbox"/> None
Next Hunt Station	<input type="checkbox"/> EXT <input type="checkbox"/> None _____
Class of Service	- -
Data Line Security	yes, <input type="checkbox"/> No
Automatic Callback-Trunk	<input type="checkbox"/> <input type="checkbox"/> No
Parallel Connect	<input type="checkbox"/> Yes, <input type="checkbox"/> No

Key	Key Type	Number	SDN COS	Day Ring	Night Ring
DN-01	PDN		<input type="checkbox"/> Station, <input type="checkbox"/> DN		
DN-02			<input type="checkbox"/> Station, <input type="checkbox"/> DN		
DN-03			<input type="checkbox"/> Station, <input type="checkbox"/> DN		
DN-04			<input type="checkbox"/> Station, <input type="checkbox"/> DN		
DN-05			<input type="checkbox"/> Station, <input type="checkbox"/> DN		
DN-06			<input type="checkbox"/> Station, <input type="checkbox"/> DN		
DN-07			<input type="checkbox"/> Station, <input type="checkbox"/> DN		
DN-08			<input type="checkbox"/> Station, <input type="checkbox"/> DN		
DN-09			<input type="checkbox"/> Station, <input type="checkbox"/> DN		
DN-10			<input type="checkbox"/> Station, <input type="checkbox"/> DN		
DN-11			<input type="checkbox"/> Station, <input type="checkbox"/> DN		
DN-12			<input type="checkbox"/> Station, <input type="checkbox"/> DN		

PF Key	PF Key Type	Number
01		
02		
03		
04		
05		
06		
07		
08		
09		
10		
11		
12		

DSS Key	DSS Key Type	Number
01		
02		
03		
04		
05		
06		
07		
08		

EXTENSION-STATION

Station Equipment No.

Item	Set Data
Telephone Type and Model	Type _____ Model _____
OHCA Circuit	<input type="checkbox"/> Yes, <input type="checkbox"/> No
Primary Directory Number	_____
Intercom Number	_____
Station Name	_____
ICM Group	
Pickup Group	_____ <input type="checkbox"/> None
Next Hunt Station	<input type="checkbox"/> EXT _____ <input type="checkbox"/> None
Class of Service	_____
Data Line Security	<input type="checkbox"/> Yes, <input type="checkbox"/> No
Automatic Callback-Trunk	<input type="checkbox"/> Yes, <input type="checkbox"/> No
Parallel Connect	<input type="checkbox"/> Yes, <input type="checkbox"/> No

Key	Key Type	Number	SDN COS	Day Ring	Night Ring
DN-01	PDN		<input type="checkbox"/> Station, <input type="checkbox"/> DN		
DN-02			<input type="checkbox"/> Station, nDN		
ON-03			<input type="checkbox"/> Station, <input type="checkbox"/> DN		
DN-04			<input type="checkbox"/> Station, <input type="checkbox"/> DN		
ON-05			<input type="checkbox"/> Station, <input type="checkbox"/> DN		
DN-06			<input type="checkbox"/> Station, <input type="checkbox"/> DN		
DN-07			<input type="checkbox"/> Station, uDN		
DN-08			<input type="checkbox"/> Station, uDN		
DN-09			<input type="checkbox"/> Station, <input type="checkbox"/> DN		
ON-10			<input type="checkbox"/> Station, <input type="checkbox"/> DN		
ON-11			<input type="checkbox"/> Station, <input type="checkbox"/> DN		
ON-12			<input type="checkbox"/> Station, <input type="checkbox"/> DN		

PF Key	PF Key Type	Number	DSS Key	DSS Key Type	Number
01			01		
02			02		
03			03		
04			04		
05			05		
06			06		
07			07		
08			08		
09					
to					
11					
12					

EXTENSION-STATION

Station Equipment No.

item	Set Data
Telephone Type and Model	Type_____ Model_____
OHCA Circuit	<input type="checkbox"/> <input type="checkbox"/> No
Primary Directory Number	- - - -
Intercom Number	- -
Station Name	_____
ICM Group	_____
Pickup Group	- - <input type="checkbox"/> None
Next Hunt Station	<input type="checkbox"/> _____ <input type="checkbox"/> None
Class of Service	- -
Data Line Security	<input type="checkbox"/> <input type="checkbox"/>
Automatic Callback-Trunk	<input type="checkbox"/> Yes, <input type="checkbox"/> No
Parallel Connect	<input type="checkbox"/> <input type="checkbox"/> No

Key	Key Type	Number	SDN COS	Day Ring	Night Ring
DN-01	PDN		<input type="checkbox"/> Station, <input type="checkbox"/> DN		
DN-02			<input type="checkbox"/> Station, <input type="checkbox"/> DN		
DN-03			<input type="checkbox"/> Station, <input type="checkbox"/> DN		
DN-04			<input type="checkbox"/> Station, <input type="checkbox"/> DN		
DN-05			<input type="checkbox"/> Station, <input type="checkbox"/> DN		
DN-06			<input type="checkbox"/> Station, /JDN		
DN-07			<input type="checkbox"/> Station, nDN		
DN-08			<input type="checkbox"/> Station, <input type="checkbox"/> DN		
DN-09			<input type="checkbox"/> Station, nDN		
DN-10			<input type="checkbox"/>]Station, [7DN		
DN-11			<input type="checkbox"/> Station, <input type="checkbox"/> DN		
DN-12			<input type="checkbox"/> Station.uDN		

PF Key	PF Key Type	Number	DSS Key	DSS Key Type	Number
01			01		
02			02		
03			03		
04			04		
05			05		
06			06		
07			07		
08			08		
09					
10					
11					
12					

EXTENSION-STATION

Station Equipment No.

Item	Set Data
Telephone Type and Model	Type _____ Model _____
OHCA Circuit	<input type="checkbox"/> Yes, <input type="checkbox"/> <input type="checkbox"/>
Primary Directory Number	- - - - -
Intercom Number	- -
Station Name	_____
ICM Group	_____
Pickup Group	- - <input type="checkbox"/> None
Next Hunt Station	<input type="checkbox"/> _____ <input type="checkbox"/> None
Class of Service	- -
Data Line Security	<input type="checkbox"/> <input type="checkbox"/> No
Automatic Callback-Trunk	<input type="checkbox"/> Yes, <input type="checkbox"/> No
Parallel Connect	<input type="checkbox"/> Yes, <input type="checkbox"/> No

Key	Key Type	Number	SDN COS	Day Ring	Night Ring
DN-01	PDN		<input type="checkbox"/> Station, <input type="checkbox"/> DN		
DN-02			<input type="checkbox"/> Station, <input type="checkbox"/> DN		
DN-03			<input type="checkbox"/> Station, <input type="checkbox"/> DN		
DN-04			<input type="checkbox"/> Station, <input type="checkbox"/> DN		
DN-05			<input type="checkbox"/> Station, <input type="checkbox"/> DN		
DN-06			<input type="checkbox"/> Station.C DN		
DN-07			<input type="checkbox"/> Station.nDN		
DN-08			<input type="checkbox"/> Station,ODN		
DN-09			<input type="checkbox"/> Station,nDN		
DN-10			<input type="checkbox"/> Station. <input type="checkbox"/> DN		
DN-11			<input type="checkbox"/> Station./JDN		
DN-12			<input type="checkbox"/> Station, <input type="checkbox"/> DN,		

PF Key	PF Key Type	Number
01		
02		
03		
04		
05		
06		
07		
08		
09		
10		
11		
12		

DSS Key	DSS Key Type	Number
01		
02		
03		
04		
05		
06		
07		
08		

EXTENSION-STATION

Station Equipment No.

item	Set Data
Telephone Type and Model	Type _____ Model _____
OHCA Circuit	<input type="checkbox"/> <input type="checkbox"/>
Primary Directory Number	- - - -
Intercom Number	- -
Station Name	_____
ICM Group	_____
Pickup Group	- - <input type="checkbox"/> None
Next Hunt Station	<input type="checkbox"/> <input type="checkbox"/> _____ <input type="checkbox"/> None
Class of Service	- -
Data Line Security	<input type="checkbox"/> Yes, <input type="checkbox"/> <input type="checkbox"/>
Automatic Callback-Trunk	<input type="checkbox"/> <input type="checkbox"/> No
Parallel Connect	<input type="checkbox"/> Yes, <input type="checkbox"/> No

Key	Key Type	Number	SDN COS	Day Ring	Night Ring
DN-01	PDN		<input type="checkbox"/> Station, <input type="checkbox"/> DN		
DN-02			<input type="checkbox"/> Station, <input type="checkbox"/> DN		
DN-03			<input type="checkbox"/> Station, <input type="checkbox"/> DN		
DN-04			<input type="checkbox"/> Station, <input type="checkbox"/> DN		
DN-05			<input type="checkbox"/> Station, <input type="checkbox"/> DN		
DN-06			<input type="checkbox"/> Station, <input type="checkbox"/> DN		
DN-07			<input type="checkbox"/> Station, <input type="checkbox"/> DN		
DN-08			<input type="checkbox"/> Station, <input type="checkbox"/> DN		
DN-09			<input type="checkbox"/> Station, <input type="checkbox"/> DN		
DN-10			<input type="checkbox"/> Station, <input type="checkbox"/> DN		
DN-11			<input type="checkbox"/> Station, <input type="checkbox"/> DN		
DN-12			<input type="checkbox"/> Station, <input type="checkbox"/> DN		

PF Key	PF Key Type	Number
01		
02		
03		
04		
05		
06		
07		
08		
09		
10		
11		
12		

DSS Key	DSS Key Type	Number
01		
02		
03		
04		
05		
06		
07		
08		

EXTENSION-STATION

Station Equipment No. _____

Item	Set Data
Telephone Type and Model	Type _____ Model _____
OHCA Circuit	<input type="checkbox"/> Yes, <input type="checkbox"/> No
Primary Directory Number	- - - -
Intercom Number	- -
Station Name	-----
ICM Group	---
Pickup Group	- - <input type="checkbox"/> None
Next Hunt Station	<input type="checkbox"/> EXT _____ <input type="checkbox"/> None
Class of Service	- -
Data Line Security	<input type="checkbox"/> <input type="checkbox"/> No
Automatic Callback-Trunk	<input type="checkbox"/> Yes, <input type="checkbox"/> K:
Parallel Connect	<input type="checkbox"/> <input type="checkbox"/> No

Key	Key Type	Number	SDN COS	Day Ring	Night Ring
DN-01	PDN		<input type="checkbox"/> Station, <input type="checkbox"/> DN		
DN-02			<input type="checkbox"/> Station, <input type="checkbox"/> DN		
DN-03			<input type="checkbox"/> Station, <input type="checkbox"/> DN		
DN-04			<input type="checkbox"/> Station, <input type="checkbox"/> DN		
DN-05			<input type="checkbox"/> Station, <input type="checkbox"/> DN		
DN-06			<input type="checkbox"/> Station, <input type="checkbox"/> DN		
DN-07			<input type="checkbox"/> Station, <input type="checkbox"/> DN		
DN-08			<input type="checkbox"/> Station, <input type="checkbox"/> DN		
DN-09			<input type="checkbox"/> Station, <input type="checkbox"/> DN		
DN-10			<input type="checkbox"/> Station, <input type="checkbox"/> DN		
DN-11			<input type="checkbox"/> Station, <input type="checkbox"/> DN		
DN-12			<input type="checkbox"/> Station, <input type="checkbox"/> DN		

PF Key	PF Key Type	Number
01		
02		
03		
04		
05		
06		
07		
08		
09		
10		
11		
12		

DSS Key	DSS Key Type	Number
01		
02		
03		
04		
05		
06		
07		
08		

EXTENSION-STATION

Station Equipment No.

Item	Set Data
Telephone Type and Model	Type _____ Model _____
OHCA Circuit	<input type="checkbox"/> Yes, <input type="checkbox"/> No <input type="checkbox"/> No
Primary Directory Number	_____
intercom Number	- -
Station Name	_____
ICM Group	_____
Pickup Group	- - <input type="checkbox"/> None
Next Hunt Station	<input type="checkbox"/> EXT <input type="checkbox"/> None _____
Class of Service	- -
Data Line Security	<input type="checkbox"/> Yes, <input type="checkbox"/> No <input type="checkbox"/> No
Automatic Callback-Trunk	<input type="checkbox"/> Yes, <input type="checkbox"/> No
Parallel Connect	<input type="checkbox"/> Yes, <input type="checkbox"/> No <input type="checkbox"/> No

Key	Key Type	Number	SDN COS	Day Ring	Night Ring
DN-01	PDN		<input type="checkbox"/> Station, <input type="checkbox"/> DN		
DN-02			<input type="checkbox"/> Station, <input type="checkbox"/> DN		
DN-03			<input type="checkbox"/> Station, <input type="checkbox"/> DN		
DN-04			<input type="checkbox"/> Station, <input type="checkbox"/> DN		
DN-05			<input type="checkbox"/> Station, <input type="checkbox"/> DN		
DN-06			<input type="checkbox"/> Station, <input type="checkbox"/> DN		
DN-07			<input type="checkbox"/> Station, <input type="checkbox"/> DN		
DN-08			<input type="checkbox"/> Station, <input type="checkbox"/> DN		
DN-09			<input type="checkbox"/> Station, <input type="checkbox"/> DN		
DN-10			<input type="checkbox"/> Station, <input type="checkbox"/> DN		
DN-11			<input type="checkbox"/> Station, <input type="checkbox"/> DN		
DN-12			<input type="checkbox"/> Station, <input type="checkbox"/> DN		

PF Key	PF Key Type	Number
01		
02		
03		
04		
05		
06		
07		
08		
09		
10		
11		
12		

DSS Key	DSS Key Type	Number
01		
02		
03		
04		
05		
06		
07		
08		

EXTENSION-STATION

Station Equipment No.

Item	Set Data
Telephone Type and Model	Type _____ Model _____
OHCA Circuit	<input type="checkbox"/> Yes, <input type="checkbox"/>
Primary Directory Number	_____
Intercom Number	_____
Station Name	_____
ICM Group	_____
Pickup Group	_____ <input type="checkbox"/> None
Next Hunt Station	<input type="checkbox"/> EXT _____ <input type="checkbox"/> None
Class of Service	_____
Data Line Security	<input type="checkbox"/> <input type="checkbox"/>
Automatic Callback-Trunk	<input type="checkbox"/> Yes, <input type="checkbox"/>
Parallel Connect	<input type="checkbox"/> <input type="checkbox"/> <input type="checkbox"/> No

Key	Key Type	Number	SDN COS	Dav Rina	Niaht Rina
DN-01	PDN		<input type="checkbox"/> Station, <input type="checkbox"/> DN		
DN-02			<input type="checkbox"/> Station, <input type="checkbox"/> DN		
DN-03			<input type="checkbox"/> Station, ODN		
DN-04			<input type="checkbox"/> Station, <input type="checkbox"/> DN		
DN-05			<input type="checkbox"/> Station, <input type="checkbox"/> DN		
DN-06			<input type="checkbox"/> Station, ODN		
DN-07			<input type="checkbox"/> Station, <input type="checkbox"/> DN		
DN-08			<input type="checkbox"/> Station, ODN		
ON-09			<input type="checkbox"/> Station, <input type="checkbox"/> DN		
DN-10			<input type="checkbox"/> Station, <input type="checkbox"/> DN		
DN-11			<input type="checkbox"/> Station, <input type="checkbox"/> DN		
DN-12			<input type="checkbox"/> Station, <input type="checkbox"/> DN		

PF Key	PF Key Type	Number	DSS Key	DSS Key Type	Number
01			01		
02			02		
03			03		
04			04		
05			05		
06			06		
07			07		
08			08		
09					
10					
11					
12					

EXTENSION-STATION

Station Equipment No.

Item	Set Data
Telephone Type and Model	Type _____ Model _____
OHCA Circuit	<input type="checkbox"/> Yes, <input type="checkbox"/> No
Primary Directory Number	- - - - -
Intercom Number	- -
Station Name	-----
ICM Group	—
Pickup Group	- - j-J None
Next Hunt Station	<input type="checkbox"/> <input type="checkbox"/> None
Class of Service	- -
Data Line Security	<input type="checkbox"/> <input type="checkbox"/>
Automatic Callback-Trunk	<input type="checkbox"/> Yes, <input type="checkbox"/> No
Parallel Connect	<input type="checkbox"/> <input type="checkbox"/>

Key	Key Type	Number	SDN COS	Day Ring	Night Ring
DN-01	PDN		<input type="checkbox"/> Station, <input type="checkbox"/> DN		
DN-02			<input type="checkbox"/> Station, <input type="checkbox"/> DN		
DN-03			<input type="checkbox"/> Station, <input type="checkbox"/> DN		
DN-04			<input type="checkbox"/> Station, <input type="checkbox"/> DN		
DN-05			<input type="checkbox"/> Station, <input type="checkbox"/> DN		
DN-06			<input type="checkbox"/> Station, <input type="checkbox"/> DN		
DN-07			<input type="checkbox"/> Station, <input type="checkbox"/> DN		
DN-08			<input type="checkbox"/> Station, <input type="checkbox"/> DN		
DN-09			<input type="checkbox"/> Station, <input type="checkbox"/> DN		
DN-10			<input type="checkbox"/> Station, <input type="checkbox"/> DN		
DN-11			<input type="checkbox"/> Station, <input type="checkbox"/> DN		
DN-12			<input type="checkbox"/> Station, <input type="checkbox"/> DN		

PF Key	PF Key Type	Number	DSS Key	DSS Key Type	Number
01			01		
02			02		
03			03		
04			04		
05			05		
06			06		
07			07		
08			08		
09					
10					
11					
12					

EXTENSION-STATION

Station Equipment No.

Item	Set Data
Telephone Type and Model	Type _____ Model _____
OHCA Circuit	<input type="checkbox"/> Yes, <input type="checkbox"/> No
Primary Directory Number	- - - -
Intercom Number	- -
Station Name	_____
ICM Group	_____
Pickup Group	- - 0 None
Next Hunt Station	<input type="checkbox"/> <input type="checkbox"/> None
Class of Service	- -
Data Line Security	<input type="checkbox"/> Yes, <input type="checkbox"/> No
Automatic Callback-Trunk	<input type="checkbox"/> Yes, <input type="checkbox"/> No
Parallel Connect	<input type="checkbox"/> Yes <input type="checkbox"/> <input type="checkbox"/>

Key	Key Type	Number	SDN COS	Day Ring	Night Ring
DN-01	PDN		<input type="checkbox"/> Station, <input type="checkbox"/> DN		
DN-02			<input type="checkbox"/> Station, <input type="checkbox"/> DN		
DN-03			<input type="checkbox"/> Station, <input type="checkbox"/> DN		
DN-04			<input type="checkbox"/> Station, <input type="checkbox"/> DN		
DN-05			<input type="checkbox"/> Station, <input type="checkbox"/> DN		
DN-06			<input type="checkbox"/> Station, <input type="checkbox"/> DN		
DN-07			<input type="checkbox"/> Station, <input type="checkbox"/> DN		
DN-08			<input type="checkbox"/> Station, <input type="checkbox"/> DN		
DN-09			<input type="checkbox"/> Station, <input type="checkbox"/> DN		
DN-10			<input type="checkbox"/> Station, <input type="checkbox"/> DN		
DN-11			<input type="checkbox"/> Station, <input type="checkbox"/> DN		
DN-12			<input type="checkbox"/> Station, <input type="checkbox"/> DN		

PF Key	PF Key Type	Number
01		
02		
03		
04		
05		
06		
07		
08		
09		
10		
11		
12		

DSS Key	DSS Key Type	Number
01		
02		
03		
04		
05		
06		
07		
08		

EXTENSION-STATION

Station Equipment No.

Item	Set Data
Telephone Type and Model	Type _____ Model _____
OHCA Circuit	<input type="checkbox"/> <input type="checkbox"/> <input type="checkbox"/> <input type="checkbox"/>
Primary Directory Number	_____
Intercom Number	_____
Station Name	_____
ICM Group	
Pickup Group	_____ <input type="checkbox"/> None
Next Hunt Station	<input type="checkbox"/> <input type="checkbox"/> <input type="checkbox"/> _____ <input type="checkbox"/> None
Class of Service	_____
Data Line Security	<input type="checkbox"/> Yes, <input type="checkbox"/> <input type="checkbox"/>
Automatic Callback-Trunk	<input type="checkbox"/> <input type="checkbox"/> <input type="checkbox"/> <input type="checkbox"/> No
Parallel Connect	<input type="checkbox"/> Yes, <input type="checkbox"/> <input type="checkbox"/>

Key	Key Type	Number	SDN COS	Day Ring	Night Ring
DN-01	PDN		<input type="checkbox"/> Station, <input type="checkbox"/> DN		
DN-02			<input type="checkbox"/> Station, <input type="checkbox"/> DN		
DN-03			<input type="checkbox"/> Station, <input type="checkbox"/> DN		
DN-04			<input type="checkbox"/> Station, <input type="checkbox"/> DN		
DN-05			<input type="checkbox"/> Station, <input type="checkbox"/> DN		
DN-06			<input type="checkbox"/> Station, <input type="checkbox"/> DN		
DN-07			<input type="checkbox"/> Station, <input type="checkbox"/> DN		
DN-08			<input type="checkbox"/> Station, <input type="checkbox"/> DN		
DN-09			<input type="checkbox"/> Station, <input type="checkbox"/> DN		
DN-10			<input type="checkbox"/> Station, <input type="checkbox"/> DN		
DN-11			<input type="checkbox"/> Station, <input type="checkbox"/> DN		
DN-12			<input type="checkbox"/> Station, <input type="checkbox"/> DN		

PF Key	PF Key Type	Number	DSS Key	DSS Key Type	Number
01			01		
02			02		
03			03		
04			04		
05			05		
06			06		
07			07		
08			08		
09					
10					
11					
12					

EXTENSION-STATION

Station Equipment No.

Item	Set Data
Telephone Type and Model	Type _____ Model _____
OHCA Circuit	<input type="checkbox"/> Yes, <input type="checkbox"/> Yes <input type="checkbox"/>
Primary Directory Number	_____
Intercom Number	- -
Station Name	_____
ICM Group	_____
Pickup Group	- - 0 None
Next Hunt Station	<input type="checkbox"/> Yes <input type="checkbox"/> _____ <input type="checkbox"/> None
Class of Service	- -
Data Line Security	<input type="checkbox"/> Yes, <input type="checkbox"/> Yes <input type="checkbox"/>
Automatic Callback-Trunk	<input type="checkbox"/> Yes, <input type="checkbox"/> No
Parallel Connect	<input type="checkbox"/> Yes, <input type="checkbox"/> Yes <input type="checkbox"/>

Key	Key Type	Number	SDN COS	Day Ring	Night Ring
DN-01	PDN		<input type="checkbox"/> Station,ODN		
DN-02			<input type="checkbox"/> Station,ODN		
DN-03			<input type="checkbox"/> Station, <input type="checkbox"/> DN		
DN-04			<input type="checkbox"/> Station,jJDN		
DN-05			<input type="checkbox"/> Station,-JDN		
DN-06			<input type="checkbox"/> Station,CJDN		
DN-07			<input type="checkbox"/> Station, <input type="checkbox"/> DN		
DN-08			<input type="checkbox"/> Station, <input type="checkbox"/> DN		
DN-09			<input type="checkbox"/> Station,aDN		
DN-10			<input type="checkbox"/> Station,ODN		
DN-11			<input type="checkbox"/> Station,/JDN		
DN-12			<input type="checkbox"/> Station, <input type="checkbox"/> DN		

PF Key	PF Key Type	Number
01		
02		
03		
04		
05		
06		
07		
08		
09		
10		
11		
12		

DSS Key	DSS Key Type	Number
01		
02		
03		
04		
05		
06		
07		
08		

EXTENSION-STATION

Station Equipment No.

Item	Set Data
Telephone Type and Model	Type _____ Model _____
OHCA Circuit	<input type="checkbox"/> Yes, <input type="checkbox"/> <input type="checkbox"/>
Primary Directory Number	- - - -
intercom Number	- -
Station Name	_____
ICM Group	---
Pickup Group	- - 0 None
Next Hunt Station	<input type="checkbox"/> EXT _____ <input type="checkbox"/> None
Class of Service	- -
Data Line Security	<input type="checkbox"/> Yes, <input type="checkbox"/> <input type="checkbox"/>
Automatic Callback-Trunk	<input type="checkbox"/> Yes, <input type="checkbox"/> No
Parallel Connect	<input type="checkbox"/> <input type="checkbox"/>

Key	Key Type	Number	SDN COS	Day Ring	Night Ring
DN-01	PDN		<input type="checkbox"/> Station,j-JDN		
DN-02			<input type="checkbox"/> Station,ODN		
DN-03			<input type="checkbox"/> Station, <input type="checkbox"/> DN		
DN-04			<input type="checkbox"/> Station, <input type="checkbox"/> DN		
DN-05			<input type="checkbox"/> Station, <input type="checkbox"/> DN		
DN-06			<input type="checkbox"/> Station, <input type="checkbox"/> DN		
DN-07			<input type="checkbox"/> Station, <input type="checkbox"/> DN		
DN-08			<input type="checkbox"/> Station, <input type="checkbox"/> JDN		
DN-09			<input type="checkbox"/> Station,nDN		
DN-10			<input type="checkbox"/>)Station,ODN		
DN-11			<input type="checkbox"/> Station, <input type="checkbox"/> DN		
DN-12			<input type="checkbox"/> station, <input type="checkbox"/> DN		

PF Key	PF Key Type	Number	DSS Key	DSS Key Type	Number
01			01		
02			02		
03			03		
04			04		
05			05		
06			06		
07			07		
08			08		
09					
10					
11					
t 12					

EXTENSION-STATION

Station Equipment No.

Item	Set Data
Telephone Type and Model	Type _____ Model _____
OHCA Circuit	<input type="checkbox"/> Yes, <input type="checkbox"/> No
Primary Directory Number	- - - - -
Intercom Number	- - -
Station Name	_____
ICM Group	_____
Pickup Group	- - <input type="checkbox"/> None
Next Hunt Station	<input type="checkbox"/> _____ <input type="checkbox"/> None
Class of Service	- -
Data Line Security	<input type="checkbox"/> <input type="checkbox"/> No
Automatic Callback-Trunk	<input type="checkbox"/> Yes, <input type="checkbox"/> No
Parallel Connect	<input type="checkbox"/> Yes, <input type="checkbox"/> <input type="checkbox"/>

Key	Key Type	Number	SDN COS	Day Ring	Night Ring
DN-01	PDN		<input type="checkbox"/> Station, <input type="checkbox"/> DN		
DN-02			<input type="checkbox"/> Station, <input type="checkbox"/> DN		
DN-03			<input type="checkbox"/> Station, <input type="checkbox"/> DN		
DN-04			<input type="checkbox"/> Station, <input type="checkbox"/> DN		
DN-05			<input type="checkbox"/> Station, <input type="checkbox"/> DN		
DN-06			<input type="checkbox"/> Station, <input type="checkbox"/> DN		
DN-07			<input type="checkbox"/> Station, <input type="checkbox"/> DN		
DN-08			<input type="checkbox"/> Station, <input type="checkbox"/> DN		
DN-09			<input type="checkbox"/> Station, <input type="checkbox"/> DN		
DN-10			<input type="checkbox"/> Station, <input type="checkbox"/> DN		
DN-11			<input type="checkbox"/> Station, <input type="checkbox"/> DN		
DN-12			<input type="checkbox"/> Station, <input type="checkbox"/> DN		

PF Key	PF Key Type	Number
01		
02		
03		
04		
05		
06		
07		
08		
09		
10		
11		
12		

DSS Key	DSS Key Type	Number
01		
02		
03		
04		
05		
06		
07		
08		

EXTENSION-STATION

Station Equipment No.

item	Set Data
Telephone Type and Model	Type _____ Model _____
OHCA Circuit	<input type="checkbox"/> Yes <input type="checkbox"/> No
Primary Directory Number	- - - - -
Intercom Number	- -
Station Name	_____
ICM Group	-
Pickup Group	- - <input type="checkbox"/> None
Next Hunt Station	<input type="checkbox"/> <input type="checkbox"/> <input type="checkbox"/> <input type="checkbox"/> <input type="checkbox"/> <input type="checkbox"/> None
Class of Service	- -
Data Line Security	<input type="checkbox"/> <input type="checkbox"/> <input type="checkbox"/> <input type="checkbox"/>
Automatic Callback-Trunk	<input type="checkbox"/> Yes <input type="checkbox"/> <input type="checkbox"/>
Parallel Connect	<input type="checkbox"/> Yes <input type="checkbox"/> <input type="checkbox"/>

Key	Key Type	Number	SDN COS	Day Ring	Night Ring
DN-01	PDN		<input type="checkbox"/> Station, <input type="checkbox"/> DN		
DN-02			<input type="checkbox"/> Station, <input type="checkbox"/> DN		
DN-03			<input type="checkbox"/> Station, <input type="checkbox"/> DN		
DN-04			<input type="checkbox"/> Station, <input type="checkbox"/> DN		
DN-05			<input type="checkbox"/> Station, <input type="checkbox"/> DN		
DN-06			<input type="checkbox"/> Station, <input type="checkbox"/> DN		
DN-07			<input type="checkbox"/> Station, <input type="checkbox"/> DN		
DN-08			<input type="checkbox"/> Station, <input type="checkbox"/> DN		
DN-09			<input type="checkbox"/> Station, <input type="checkbox"/> DN		
DN-10			<input type="checkbox"/> Station, <input type="checkbox"/> DN		
DN-11			<input type="checkbox"/> Station, <input type="checkbox"/> DN		
DN-12			<input type="checkbox"/> Station, <input type="checkbox"/> DN		

PF Key	PF Key Type	Number
01		
02		
03		
04		
05		
06		
07		
08		
09		
10		
11		
12		

DSS Key	DSS Key Type	Number
01		
02		
03		
04		
05		
06		
07		
08		

EXTENSION-STATION

Station Equipment No.

Item	Set Data
Telephone Type and Model	Type _____ Model _____
OHCA Circuit	<input type="checkbox"/> Yes, <input type="checkbox"/> No
Primary Directory Number	_____
Intercom Number	_____
Station Name	_____
ICM Group	
Pickup Group	_____ <input type="checkbox"/> None
Next Hunt Station	<input type="checkbox"/> <input type="checkbox"/> _____ <input type="checkbox"/> None
Class of Service	_____
Data Line Security	<input type="checkbox"/> Yes, <input type="checkbox"/> No
Automatic Callback-Trunk	<input type="checkbox"/> Yes, <input type="checkbox"/> <input type="checkbox"/>
Parallel Connect	<input type="checkbox"/> Yes, <input type="checkbox"/> <input type="checkbox"/>

Key	Key Type	Number	SDN COS	Day Ring	Night Ring
DN-01	PDN		<input type="checkbox"/> Station, <input type="checkbox"/> ODN		
DN-02			<input type="checkbox"/> Station, <input type="checkbox"/> DN		
DN-03			<input type="checkbox"/> Station, <input type="checkbox"/> DN		
DN-04			<input type="checkbox"/> Station, <input type="checkbox"/> DN		
DN-05			<input type="checkbox"/> Station, <input type="checkbox"/> DN		
DN-06			<input type="checkbox"/> Station, <input type="checkbox"/> DN		
DN-07			<input type="checkbox"/> Station, <input type="checkbox"/> DN		
DN-08			<input type="checkbox"/> Station, <input type="checkbox"/> DN		
DN-09			<input type="checkbox"/> Station, <input type="checkbox"/> DN		
DN-10			<input type="checkbox"/> Station, <input type="checkbox"/> DN		
DN-11			<input type="checkbox"/> Station, <input type="checkbox"/> DN		
DN-12			<input type="checkbox"/> Station, <input type="checkbox"/> DN		

PF Key	PF Key Type	Number	DSS Key	DSS Key Type	Number
01			01		
02			02		
03			03		
04			04		
05			05		
06			06		
07			07		
08			08		
0	9				
10					
11					
12					

EXTENSION-STATION

Station Equipment No.

Item	Set Data
Telephone Type and Model	Type _____ Model _____
OHCA Circuit	<input type="checkbox"/> <input type="checkbox"/>
Primary Directory Number	- - - -
Intercom Number	- -
Station Name	_____
ICM Group	_____
Pickup Group	- - <input type="checkbox"/> None
Next Hunt Station	<input type="checkbox"/> _____ <input type="checkbox"/> None
Class of Service	- -
Data Line Security	<input type="checkbox"/> Yes, <input type="checkbox"/> No
Automatic Callback-Trunk	<input type="checkbox"/> Yes, <input type="checkbox"/> No
Parallel Connect	<input type="checkbox"/> <input type="checkbox"/>

Key	Key Type	Number	SDN COS	Day Ring	Night Ring
DN-01	PDN		<input type="checkbox"/> Station, <input type="checkbox"/> DN		
DN-02			<input type="checkbox"/> Station, <input type="checkbox"/> DN		
DN-03			<input type="checkbox"/> Station, <input type="checkbox"/> DN		
DN-04			<input type="checkbox"/> Station, <input type="checkbox"/> DN		
DN-05			<input type="checkbox"/> Station, <input type="checkbox"/> DN		
DN-06			<input type="checkbox"/> Station, <input type="checkbox"/> DN		
DN-07			<input type="checkbox"/> Station, <input type="checkbox"/> DN		
DN-08			<input type="checkbox"/> Station, <input type="checkbox"/> DN		
DN-09			<input type="checkbox"/> Station, <input type="checkbox"/> DN		
DN-10			<input type="checkbox"/> Station, <input type="checkbox"/> DN		
DN-11			<input type="checkbox"/> Station, <input type="checkbox"/> DN		
DN-12			<input type="checkbox"/> Station, <input type="checkbox"/> DN		

PF Key	PF Key Type	Number
01		
02		
03		
04		
05		
06		
07		
08		
09		
10		
11		
12		

DSS Key	DSS Key Type	Number
01		
02		
03		
04		
05		
06		
07		
08		

EXTENSION-STATION

Station Equipment No.

Item	Set Data
Telephone Type and Model	Type _____ Model _____
OHCA Circuit	<input type="checkbox"/> <input type="checkbox"/> No
Primary Directory Number	_____
Intercom Number	- -
Station Name	_____
ICM Group	_____
Pickup Group	- - <input type="checkbox"/> None
Next Hunt Station	<input type="checkbox"/> _____ <input type="checkbox"/> None
Class of Service	- -
Data Line Security	<input type="checkbox"/> <input type="checkbox"/> No
Automatic Callback-Trunk	<input type="checkbox"/> Yes, <input type="checkbox"/> No
Parallel Connect	<input type="checkbox"/> <input type="checkbox"/> No

Key	Key Type	Number	SDN COS	Day Ring	Night Ring
DN-01	PDN		<input type="checkbox"/> Station, <input type="checkbox"/> DN		
DN-02			<input type="checkbox"/> Station, <input type="checkbox"/> DN		
DN-03			<input type="checkbox"/> Station, <input type="checkbox"/> DN		
DN-04			<input type="checkbox"/> Station, <input type="checkbox"/> DN		
DN-05			<input type="checkbox"/> Station, <input type="checkbox"/> DN		
DN-06			<input type="checkbox"/> Station, <input type="checkbox"/> DN		
DN-07			<input type="checkbox"/> Station, <input type="checkbox"/> DN		
DN-08			<input type="checkbox"/> Station, <input type="checkbox"/> DN		
DN-09			<input type="checkbox"/> Station, <input type="checkbox"/> DN		
DN-10			<input type="checkbox"/> Station, <input type="checkbox"/> DN		
DN-11			<input type="checkbox"/> Station, <input type="checkbox"/> DN		
DN-12			<input type="checkbox"/> Station, <input type="checkbox"/> DN		

PF Key	PF Key Type	Number
01		
02		
03		
04		
05		
06		
07		
08		
09		
10		
11		
12		

DSS Key	DSS Key Type	Number
01		
02		
03		
04		
05		
06		
07		
08		

EXTENSION-STATION

Station Equipment No.

Item	Set Data
Telephone Type and Model	Type _____ Model _____
OHCA Circuit	<input type="checkbox"/> Yes, <input type="checkbox"/> <input type="checkbox"/>
Primary Directory Number	- - - -
Intercom Number	- -
Station Name	_____
ICM Group	_____
Pickup Group	- - 0 None
Next Hunt Station	<input type="checkbox"/> _____ <input type="checkbox"/> None
Class of Service	- -
Data Line Security	<input type="checkbox"/> <input type="checkbox"/> No
Automatic Callback-Trunk	<input type="checkbox"/> Yes, <input type="checkbox"/> <input type="checkbox"/>
Parallel Connect	<input type="checkbox"/> <input type="checkbox"/> No

Key	Key Type	Number	SDN COS	Day Ring	Night Ring
DN-01	PDN		<input type="checkbox"/> Station, <input type="checkbox"/> DN		
DN-02			<input type="checkbox"/> Station, <input type="checkbox"/> DN		
DN-03			<input type="checkbox"/> Station, <input type="checkbox"/> DN		
DN-04			<input type="checkbox"/> Station, <input type="checkbox"/> DN		
DN-05			<input type="checkbox"/> Station, <input type="checkbox"/> DN		
DN-06			<input type="checkbox"/> Station, <input type="checkbox"/> DN		
DN-07			<input type="checkbox"/> Station, <input type="checkbox"/> DN		
DN-08			<input type="checkbox"/> Station, <input type="checkbox"/> DN		
DN-09			<input type="checkbox"/> Station, <input type="checkbox"/> DN		
DN-10			<input type="checkbox"/> Station, <input type="checkbox"/> DN		
DN-11			<input type="checkbox"/> Station, <input type="checkbox"/> DN		
DN-12			<input type="checkbox"/> Station, <input type="checkbox"/> DN		

PF Key	PF Key Type	Number	DSS Key	DSS Key Type	Number
01			01		
02			02		
03			C3		
04			04		
05			05		
06			06		
07			07		
08			08		
09					
10					
11					
12					

EXTENSION-STATION

Station Equipment No.

Item	Set Data
Telephone Type and Model	Type _____ Model _____
OHCA Circuit	<input type="checkbox"/> Yes, <input type="checkbox"/> No
Primary Directory Number	_____
Intercom Number	_____
Station Name	_____
ICM Group	_____
Pickup Group	_____ <input type="checkbox"/> None
Next Hunt Station	<input type="checkbox"/> <input type="checkbox"/> <input type="checkbox"/> <input type="checkbox"/> <input type="checkbox"/> <input type="checkbox"/> None
Class of Service	<input type="checkbox"/> Yes, <input type="checkbox"/> <input type="checkbox"/> <input type="checkbox"/>
Data Line Security	<input type="checkbox"/> Yes, <input type="checkbox"/> No
Automatic Callback-Trunk	<input type="checkbox"/> Yes, <input type="checkbox"/> No
Parallel Connect	<input type="checkbox"/> Yes, <input type="checkbox"/> No

Key	Key Type	Number	SDN COS	Day Ring	Night Ring
DN-C1	PDN		<input type="checkbox"/> Station, <input type="checkbox"/> DN		
DN-C2			<input type="checkbox"/> Station, <input type="checkbox"/> DN		
DN-C3			<input type="checkbox"/> Station, <input type="checkbox"/> DN		
DN-C4			<input type="checkbox"/> Station, <input type="checkbox"/> DN		
DN-C5			<input type="checkbox"/> Station, <input type="checkbox"/> DN		
DN-C6			<input type="checkbox"/> Station, <input type="checkbox"/> DN		
DN-C7			<input type="checkbox"/> Station, <input type="checkbox"/> DN		
DN-C8			<input type="checkbox"/> Station, <input type="checkbox"/> DN		
DN-C9			<input type="checkbox"/> Station, <input type="checkbox"/> DN		
DN-10			<input type="checkbox"/> Station, <input type="checkbox"/> DN		
DN-11			<input type="checkbox"/> Station, <input type="checkbox"/> DN		
DN-12			<input type="checkbox"/> Station, <input type="checkbox"/> DN		

PF Key	PF Key Type	Number
01		
02		
03		
04		
05		
06		
07		
08		
09		
10		
11		
12		

DSS Key	DSS Key Type	Number
01		
02		
03		
04		
05		
06		
07		
08		

EXTENSION-STATION

Station Equipment No.

item	Set Data
Telephone Type and Model	Type _____ Model _____
OHCA Circuit	<input type="checkbox"/> <input type="checkbox"/> No
Primary Directory Number	- - - -
Intercom Number	- -
Station Name	_____
ICM Group	_____
Pickup Group	- - <input type="checkbox"/> None
Next Hunt Station	<input type="checkbox"/> _____ <input type="checkbox"/> None
Class of Service	- -
Data Line Security	<input type="checkbox"/> Yes, <input type="checkbox"/> <input type="checkbox"/>
Automatic Callback-Trunk	<input type="checkbox"/> Yes, <input type="checkbox"/> <input type="checkbox"/>
Parallel Connect	<input type="checkbox"/> <input type="checkbox"/> No

Key	Key Type	Number	SDN COS	Day Ring	Night Ring
DN-01	PDN		<input type="checkbox"/> Station, <input type="checkbox"/> DN		
DN-02			<input type="checkbox"/> Station, <input type="checkbox"/> DN		
DN-03			<input type="checkbox"/> Station, <input type="checkbox"/> DN		
DN-04			<input type="checkbox"/> Station, <input type="checkbox"/> DN		
DN-05			<input type="checkbox"/> Station, <input type="checkbox"/> DN		
DN-06			<input type="checkbox"/> Station, <input type="checkbox"/> DN		
DN-07			<input type="checkbox"/> Station, <input type="checkbox"/> DN		
DN-08			<input type="checkbox"/> Station, <input type="checkbox"/> DN		
DN-09			<input type="checkbox"/> Station, <input type="checkbox"/> DN		
DN-10			<input type="checkbox"/> Station, <input type="checkbox"/> DN		
DN-11			<input type="checkbox"/> Station, <input type="checkbox"/> DN		
DN-12			<input type="checkbox"/> Station, <input type="checkbox"/> DN		

PF Key	PF Key Type	Number	DSS Key	DSS Key Type	Number
01			01		
02			02		
03			03		
04			04		
05			05		
06			06		
07			07		
08			08		
09					
10					
11					
12					

EXTENSION-STATION

Station Equipment No.

Item	Set Data
Telephone Type and Model	Type _____ Model _____
OHCA Circuit	<input type="checkbox"/> Yes, <input type="checkbox"/> No
Primary Directory Number	- - - - -
Intercom Number	---
Station Name	-----
ICM Group	
Pickup Group	--- <input type="checkbox"/> None
Next Hunt Station	<input type="checkbox"/> None
Class of Service	
Data Line Security	
Automatic Callback-Trunk	<input type="checkbox"/> Yes, <input type="checkbox"/> <input type="checkbox"/>
Parallel Connect	<input type="checkbox"/> Yes, <input type="checkbox"/> <input type="checkbox"/>

Key	Key Type	Number	SDN COS	Day Ring	Night Ring
DN-01	PDN		<input type="checkbox"/> Station, <input type="checkbox"/> DN		
DN-02			<input type="checkbox"/> Station, <input type="checkbox"/> DN		
DN-03			<input type="checkbox"/> Station, <input type="checkbox"/> DN		
DN-04			<input type="checkbox"/> Station, <input type="checkbox"/> DN		
DN-05			<input type="checkbox"/> Station, <input type="checkbox"/> DN		
DN-06			<input type="checkbox"/> Station, <input type="checkbox"/> DN		
DN-07			<input type="checkbox"/> Station, <input type="checkbox"/> DN		
DN-08			<input type="checkbox"/> Station, <input type="checkbox"/> DN		
DN-09			<input type="checkbox"/> Station, <input type="checkbox"/> DN		
DN-10			<input type="checkbox"/> Station, <input type="checkbox"/> DN		
DN-11			<input type="checkbox"/> Station, <input type="checkbox"/> DN		
DN-12			<input type="checkbox"/> Station, <input type="checkbox"/> DN		

PF Key	PF Key Type	Number	DSS Key	DSS Key Type	Number
01			01		
02			02		
03			03		
04			04		
05			05		
06			06		
07			07		
08			08		
09					
10					
11					
12					

EXTENSION-STATION

Station Equipment No.

item	Set Data
Telephone Type and Model	Type _____ Model _____
OHCA Circuit	<input type="checkbox"/> Yes <input type="checkbox"/> No
Primary Directory Number	- - - -
Intercom Number	- -
Station Name	_____
ICM Group	_____
Pickup Group	- - <input type="checkbox"/> None
Next Hunt Station	<input type="checkbox"/> <input type="checkbox"/> None _____
Class of Service	- -
Data Line Security	<input type="checkbox"/> <input type="checkbox"/>
Automatic Callback-Trunk	<input type="checkbox"/> Yes, <input type="checkbox"/> No
Parallel Connect	<input type="checkbox"/> <input type="checkbox"/> <input type="checkbox"/> No

Key	Key Type	Number	SDN COS	Day Ring	Night Ring
DN-01	PDN		<input type="checkbox"/> Station, <input type="checkbox"/> DN		
DN-02			<input type="checkbox"/> Station, ODN		
DN-03			<input type="checkbox"/> Station, <input type="checkbox"/> DN		
DN-04			<input type="checkbox"/> Station, nDN		
DN-05			<input type="checkbox"/> Station, <input type="checkbox"/> DN		
DN-06			<input type="checkbox"/> Station, <input type="checkbox"/> DN		
DN-07			<input type="checkbox"/> Station, ODN		
DN-08			<input type="checkbox"/> Station, <input type="checkbox"/> DN		
DN-09			<input type="checkbox"/> Station, <input type="checkbox"/> DN		
DN-10			<input type="checkbox"/> Station, <input type="checkbox"/> DN		
DN-11			<input type="checkbox"/> Station, ODN		
DN-12			<input type="checkbox"/> Station, ODN		

PF Key	PF Key Type	Number	DSS Key	DSS Key Type	Number
01			01		
02			02		
03			03		
04			04		
05			05		
06			06		
07			07		
08			08		
09					
10					
11					
12					

EXTENSION-STATION

Station Equipment No.

Item	Set Data
Telephone Type and Model	Type _____ Model _____
OHCA Circuit	<input type="checkbox"/> Yes, <input type="checkbox"/>
Primary Directory Number	_____
intercom Number	- -
Station Name	_____
ICM Group	_____
Pickup Group	- - <input type="checkbox"/> None
Next Hunt Station	<input type="checkbox"/> <input type="checkbox"/> <input type="checkbox"/> <input type="checkbox"/> <input type="checkbox"/> None
Class of Service	- -
Data Line Security	<input type="checkbox"/> <input type="checkbox"/> No
Automatic Callback-Trunk	<input type="checkbox"/> Yes, <input type="checkbox"/> No
Parallel Connect	<input type="checkbox"/> Yes, <input type="checkbox"/>

Key	Key Type	Number	SDN COS	Day Ring	Night Ring
DN-01	PDN		<input type="checkbox"/> Station, ODN		
DN-02			<input type="checkbox"/> Station, <input type="checkbox"/> DN		
DN-03			<input type="checkbox"/> Station, <input type="checkbox"/> DN		
DN-04			<input type="checkbox"/> Station, <input type="checkbox"/> DN		
DN-05			<input type="checkbox"/> Station, <input type="checkbox"/> DN		
DN-06			<input type="checkbox"/> Station, <input type="checkbox"/> DN		
DN-07			<input type="checkbox"/> Station, <input type="checkbox"/> DN		
DN-08			<input type="checkbox"/> Station, <input type="checkbox"/> DN		
DN-09			<input type="checkbox"/> Station, nDN		
DN-10			<input type="checkbox"/> Station, ODN		
DN-11			<input type="checkbox"/> Station, ODN		
DN-12			<input type="checkbox"/> Station, <input type="checkbox"/> DN		

PF Key	PF Key Type	Number
01		
02		
03		
04		
05		
06		
07		
08		
09		
10		
11		
12		

DSS Key	DSS Key Type	Number
01		
02		
03		
04		
05		
06		
07		
08		

EXTENSION-STATION

Station Equipment No.

Hem	Set Data
Telephone Type and Model	Type _____ Model _____
OHCA Circuit	<input type="checkbox"/> Yes, <input type="checkbox"/> No
Primary Directory Number	- - - - -
intercom Number	- - -
Station Name	_____
ICMGroup	_____
Pickup Group	- - <input type="checkbox"/> None
Next Hunt Station	<input type="checkbox"/> _____ <input type="checkbox"/> None
Class of Service	- - -
Data Line Security	<input type="checkbox"/> Yes, <input type="checkbox"/> No
Automatic Callback-Trunk	<input type="checkbox"/> Yes, <input type="checkbox"/> No
Parallel Connect	<input type="checkbox"/> <input type="checkbox"/>

Key	Key Type	Number	SDN COS	Day Ring	Night Ring
DN-01	PDN		<input type="checkbox"/> Station, <input type="checkbox"/> DN		
DN-02			<input type="checkbox"/> Station, <input type="checkbox"/> DN		
DN-03			<input type="checkbox"/> Station, <input type="checkbox"/> DN		
DN-04			<input type="checkbox"/> Station, <input type="checkbox"/> DN		
DN-05			<input type="checkbox"/> Station, <input type="checkbox"/> DN		
DN-08			<input type="checkbox"/> Station, <input type="checkbox"/> DN		
DN-07			<input type="checkbox"/> Station, <input type="checkbox"/> DN		
DN-08			<input type="checkbox"/> Station, <input type="checkbox"/> DN		
DN-09			<input type="checkbox"/> Station, <input type="checkbox"/> DN		
DN-10			<input type="checkbox"/> Station, <input type="checkbox"/> DN		
DN-11			<input type="checkbox"/> Station, <input type="checkbox"/> DN		
DN-12			<input type="checkbox"/> Station, <input type="checkbox"/> DN		

PF Key	PF Key Type	Number
01		
02		
03		
04		
05		
06		
07		
08		
09		
10		
11		
12		

DSS Key	DSS Key Type	Number
01		
02		
03		
04		
05		
06		
07		
08		

EXTENSION-STATION

Station Equipment No.

Item	Set Data
Telephone Type and Model	Type _____ Model _____
OHCA Circuit	<input type="checkbox"/> Yes, <input type="checkbox"/> No
Primary Directory Number	- - - - -
Intercom Number	
Station Name	_____
ICM Group	
Pickup Group	_____ <input type="checkbox"/> None
Next Hunt Station	<input type="checkbox"/> _____ <input type="checkbox"/> None
Class of Service	_____
Data Line Security	<input type="checkbox"/> <input type="checkbox"/> No
Automatic Callback-Trunk	<input type="checkbox"/> Yes, <input type="checkbox"/>
Parallel Connect	<input type="checkbox"/> <input type="checkbox"/>

KeV	KeV Type	Number	SDN COS	Day Ring	Night Ring
DN-01	PDN		<input type="checkbox"/> Station, <input type="checkbox"/> DN		
DN-02			<input type="checkbox"/> Station, ODN		
DN-03			<input type="checkbox"/> Station, ODN		
DN-04			<input type="checkbox"/> Station, <input type="checkbox"/> DN		
DN-05			<input type="checkbox"/> Station, <input type="checkbox"/> DN		
DN-06			<input type="checkbox"/> Station, <input type="checkbox"/> DN		
DN-07			<input type="checkbox"/> Station, <input type="checkbox"/> DN		
DN-08			<input type="checkbox"/> Station, <input type="checkbox"/> DN		
DN-09			<input type="checkbox"/> Station, <input type="checkbox"/> DN		
DN-10			<input type="checkbox"/> Station, <input type="checkbox"/> DN		
DN-11			<input type="checkbox"/> Station, ODN		
DN-12			<input type="checkbox"/> Station, nDN		

PF Key	PF Key Type	Number
01		
02		
03		
04		
05		
06		
07		
08		
09		
10		
11		
12		

DSS Key	DSS Key Type	Number
01		
02		
03		
04		
05		
06		
07		
08		

EXTENSION-STATION

Station Equipment No _____

Item	Set Data
Telephone Type and Model	Type _____ Model _____
OHCA Circuit	<input type="checkbox"/> Yes <input type="checkbox"/> No
Primary Directory Number	<input type="button" value="1"/> <input type="button" value="2"/> <input type="button" value="3"/> <input type="button" value="4"/>
Intercom Number	<input type="button" value="1"/> <input type="button" value="2"/>
Station Name	<input type="button" value="1"/> <input type="button" value="2"/> <input type="button" value="3"/> <input type="button" value="4"/> <input type="button" value="5"/> <input type="button" value="6"/> <input type="button" value="7"/> <input type="button" value="8"/> <input type="button" value="9"/> <input type="button" value="0"/>
ICM Group	_____
Pickup Group	<input type="button" value="1"/> <input type="button" value="2"/> C None
Next Hunt Station	<input type="checkbox"/> EXT <input type="checkbox"/> None _____
Class of Service	_____
Data Line Security	a y e s , <input type="checkbox"/> No
Automatic Callback-Trunk	C/Yes. <input type="checkbox"/> No
Parallel Connect	<input type="checkbox"/> Yes <input type="checkbox"/> No

Key	Key Type	Number	SDN COS	Day Ring	Night Ring
DN-01	PDN		<input type="checkbox"/> Station, <input type="checkbox"/> DN		
DN-02			<input type="checkbox"/> Station,uDN		
DN-03			<input type="checkbox"/> Station.ODN		
DN-04			<input type="checkbox"/> Station,nDN		
DN-05			<input type="checkbox"/> Station, <input type="checkbox"/> DN		
DN-06			<input type="checkbox"/> Station,nDN		
DN-07			<input type="checkbox"/> Station, <input type="checkbox"/> DN		
DN-08			<input type="checkbox"/> Station,nDN		
DN-09			<input type="checkbox"/> Station, <input type="checkbox"/> DN		
DN-10			<input type="checkbox"/> Station, <input type="checkbox"/> DN		
DN-11			<input type="checkbox"/> Station,fJDN		
DN-12			<input type="checkbox"/> Station, <input type="checkbox"/> DN		

PF Key	PF Key Type	Number	DSS Key	DSS Key Type	Number
01			01		
02			02		
03			03		
04			04		
05			05		
06			06		
07			07		
08			08		
09					
10					
11					
12					

EXTENSION-STATION

Station Equipment No.

item	Set Data
Telephone Type and Model	Type _____ Model _____
OHCA Circuit	<input type="checkbox"/> Yes, <input type="checkbox"/> <input type="checkbox"/>
Primary Directory Number	- - - -
Intercom Number	- -
Station Name	_____
ICM Group	_____
Pickup Group	- - <input type="checkbox"/> None
Next Hunt Station	<input type="checkbox"/> <input type="checkbox"/> None
Class of Service	- -
Data Line Security	<input type="checkbox"/> Yes, <input type="checkbox"/> No
Automatic Callback-Trunk	<input type="checkbox"/> Yes, <input type="checkbox"/> No
Parallel Connect	<input type="checkbox"/> Yes, <input type="checkbox"/> <input type="checkbox"/>

Key	Key Type	Number	SDN COS	Day Ring	Night Ring
DN-01	PDN		<input type="checkbox"/> Station, <input type="checkbox"/> DN		
DN-02			<input type="checkbox"/> Station, <input type="checkbox"/> DN		
DN-03			<input type="checkbox"/> Station, <input type="checkbox"/> DN		
DN-04			<input type="checkbox"/> Station, <input type="checkbox"/> DN		
DN-05			<input type="checkbox"/> Station, <input type="checkbox"/> DN		
DN-06			<input type="checkbox"/> Station, <input type="checkbox"/> DN		
DN-07			<input type="checkbox"/> Station, <input type="checkbox"/> DN		
DN-08			<input type="checkbox"/> Station, <input type="checkbox"/> DN		
DN-09			<input type="checkbox"/> Station, ODN		
DN-10			<input type="checkbox"/> Station, <input type="checkbox"/> DN		
DN-11			<input type="checkbox"/> Station, <input type="checkbox"/> DN		
DN-12			<input type="checkbox"/> Station, uDN		

PF Key	PF Key Type	Number
01		
02		
03		
04		
05		
06		
07		
08		
09		
10		
11		
12		

DSS Key	DSS Key Type	Number
01		
02		
03		
04		
05		
06		
07		
08		

EXTENSION-STATION

Station Equipment No.

Item	Set Data
Telephone Type and Model	Type _____ Model _____
OHCA Circuit	<input type="checkbox"/> Yes, <input type="checkbox"/> Yes <input type="checkbox"/>
Primary Directory Number	- - - - -
Intercom Number	- - -
Station Name	_____
ICM Group	_____
Pickup Group	- - - <input type="checkbox"/> None
Next Hunt Station	<input type="checkbox"/> Yes <input type="checkbox"/> _____ <input type="checkbox"/> None
Class of Service	- - -
Data Line Security	<input type="checkbox"/> Yes, <input type="checkbox"/> Yes <input type="checkbox"/>
Automatic Callback-Trunk	<input type="checkbox"/> Yes, <input type="checkbox"/> No
Parallel Connect	<input type="checkbox"/> Yes <input type="checkbox"/> Yes <input type="checkbox"/>

Key	Key Type	Number	SDN COS	Day Ring	Night Ring
DN-01	PDN		<input type="checkbox"/> Station, <input type="checkbox"/> DN		
DN-02			<input type="checkbox"/> Station, <input type="checkbox"/> DN		
DN-03			<input type="checkbox"/> Station, <input type="checkbox"/> DN		
DN-04			<input type="checkbox"/> Station, <input type="checkbox"/> DN		
DN-05			<input type="checkbox"/> Station, <input type="checkbox"/> DN		
DN-06			<input type="checkbox"/> Station, <input type="checkbox"/> DN		
DN-07			<input type="checkbox"/> Station, <input type="checkbox"/> DN		
DN-08			<input type="checkbox"/> Station, <input type="checkbox"/> DN		
DN-09			<input type="checkbox"/> Station, <input type="checkbox"/> DN		
DN-10			<input type="checkbox"/> Station, <input type="checkbox"/> DN		
DN-11			<input type="checkbox"/> Station, <input type="checkbox"/> DN		
DN-12			<input type="checkbox"/> Station, <input type="checkbox"/> DN		

PF Key	PF Key Type	Number
01		
02		
03		
04		
05		
06		
07		
08		
09		
10		
11		
12		

DSS Key	DSS Key Type	Number
01		
02		
03		
04		
05		
06		
07		
08		

EXTENSION-STATION

Station Equipment No.

item	Set Data
Telephone Type and Model	Type _____ Model _____
OHCA Circuit	<input type="checkbox"/> Yes, <input type="checkbox"/> No
Primary Directory Number	- - - - -
Intercom Number	- -
Station Name	-----
ICM Group	---
Pickup Group	- - 0 None
Next Hunt Station	<input type="checkbox"/> _____ <input type="checkbox"/> None
Class of Service	- -
Data Line Security	<input type="checkbox"/> Yes, <input type="checkbox"/> <input type="checkbox"/>
Automatic Callback-Trunk	<input type="checkbox"/> Yes, <input type="checkbox"/> No
Parallel Connect	<input type="checkbox"/> Yes, <input type="checkbox"/> No

Key	Key Type	Number	SDN COS	Day Ring	Night Ring
DN-01	PDN		<input type="checkbox"/> Station.mDN		
DN-02			<input type="checkbox"/> Station, <input type="checkbox"/> DN		
DN-03			<input type="checkbox"/> Station, <input type="checkbox"/> DN		
DN-04			<input type="checkbox"/> Station, <input type="checkbox"/> DN		
DN-05			<input type="checkbox"/> Station, <input type="checkbox"/> DN		
DN-06			<input type="checkbox"/> Station, <input type="checkbox"/> DN		
DN-07			<input type="checkbox"/> Station, <input type="checkbox"/> DN		
DN-08			<input type="checkbox"/> Station, <input type="checkbox"/> DN		
DN-09			<input type="checkbox"/> Station, <input type="checkbox"/> DN		
DN-10			<input type="checkbox"/> Station, <input type="checkbox"/> DN		
DN-11			<input type="checkbox"/> Station, <input type="checkbox"/> DN		
DN-12			<input type="checkbox"/> Station, <input type="checkbox"/> DN		

PF Key	PF Key Type	Number	DSS Key	DSS Key Type	Number
01			01		
02			02		
03			03		
04			04		
05			05		
06			06		
07			07		
08			08		
09					
10					
11					
12					

EXTENSION-STATION

Station Equipment No.

Item	Set Data
Telephone Type and Model	Type _____ Model _____
OHCA Circuit	<input type="checkbox"/> <input type="checkbox"/>
Primary Directory Number	_____
Intercom Number	_____
Station Name	_____
ICM Group	
Pickup Group	<input type="checkbox"/> None
Next Hunt Station	<input type="checkbox"/> _____ <input type="checkbox"/> None
Class of Service	_____
Data Line Security	_____ a y e s . <input type="checkbox"/> No
Automatic Callback-Trunk	<input type="checkbox"/> <input type="checkbox"/>
Parallel Connect	<input type="checkbox"/> Yes, <input type="checkbox"/>

Key	Key Type	Number	SDN COS	Day Ring	Night Ring
DN-01	PDN		<input type="checkbox"/> Station, <input type="checkbox"/> DN		
DN-02			<input type="checkbox"/> Station, <input type="checkbox"/> DN		
DN-03			<input type="checkbox"/> Station, uDN		
DN-04			<input type="checkbox"/> Station, /JDN		
DN-05			<input type="checkbox"/> Station, <input type="checkbox"/> DN		
DN-06			<input type="checkbox"/> Station, <input type="checkbox"/> DN		
DN-07			<input type="checkbox"/> Station, <input type="checkbox"/> DN		
DN-08			<input type="checkbox"/> Station, <input type="checkbox"/> DN		
DN-09			<input type="checkbox"/> Station, <input type="checkbox"/> DN		
DN-10			<input type="checkbox"/> Station, <input type="checkbox"/> DN		
DN-11			<input type="checkbox"/> Station, <input type="checkbox"/> DN		
DN-12			<input type="checkbox"/> Station, <input type="checkbox"/> DN		

PF Key	PF Key Type	Number	DSS Key	DSS Key Type	Number
01			01		
02			02		
03			03		
04			04		
05			05		
06			06		
07			07		
08			08		
09					
10					
11					
12					

EXTENSION-STATION

Station Equipment No.

Item	Set Data
Telephone Type and Model	Type _____ Model _____
OHCA Circuit	<input type="checkbox"/> Yes <input type="checkbox"/> No <input type="checkbox"/>
Primary Directory Number	<input type="checkbox"/> <input type="checkbox"/> <input type="checkbox"/> <input type="checkbox"/>
intercom Number	____
Station Name	_____
ICM Group	
Pickup Group	____ C None
Next Hunt Station	<input type="checkbox"/> EXT <input type="checkbox"/> None
Class of Service	
Data Line Security	<input type="checkbox"/> <input type="checkbox"/> <input type="checkbox"/> <input type="checkbox"/>
Automatic Callback-Trunk	<input type="checkbox"/> <input type="checkbox"/> <input type="checkbox"/> <input type="checkbox"/>
Parallel Connect	<input type="checkbox"/> <input type="checkbox"/> <input type="checkbox"/> <input type="checkbox"/>

Key	Key Type	Number	SDN COS	Day Ring	Night Ring
DN-01	PDN		<input type="checkbox"/> Station, <input type="checkbox"/> DN		
DN-02			<input type="checkbox"/> Station, <input type="checkbox"/> DN		
DN-03			<input type="checkbox"/> Station, <input type="checkbox"/> DN		
DN-04			<input type="checkbox"/> Station, <input type="checkbox"/> DN		
DN-05			<input type="checkbox"/> Station, <input type="checkbox"/> DN		
DN-06			<input type="checkbox"/> Station, <input type="checkbox"/> DN		
DN-07			<input type="checkbox"/> Station, <input type="checkbox"/> DN		
DN-08			<input type="checkbox"/> Station, <input type="checkbox"/> DN		
DN-09			<input type="checkbox"/> Station, <input type="checkbox"/> DN		
DN-10			<input type="checkbox"/> Station, <input type="checkbox"/> DN		
DN-11			<input type="checkbox"/> Station, <input type="checkbox"/> DN		
DN-12			<input type="checkbox"/> Station, <input type="checkbox"/> DN		

PF Key	PF Key Type	Number
01		
02		
03		
04		
05		
06		
07		
08		
09		
10		
11		
12		

DSS Key	DSS Key Type	Number
01		
02		
03		
04		
05		
06		
07		
08		

EXTENSION-STATION

Station Equipment No.

Item	Set Data
Telephone Type and Model	Type _____ Model _____
OHCA Circuit	<input type="checkbox"/> Yes, <input type="checkbox"/> No
Primary Directory Number	_____
Intercom Number	_____
Station Name	_____
ICM Group	_____
Pickup Group	_____ <input type="checkbox"/> None
Next Hunt Station	<input type="checkbox"/> <input type="checkbox"/> _____ <input type="checkbox"/> None
Class of Service	
Data Line Security	<input type="checkbox"/> Yes, <input type="checkbox"/> No
Automatic Callback-Trunk	<input type="checkbox"/> Yes, <input type="checkbox"/> No
Parallel Connect	<input type="checkbox"/> Yes, <input type="checkbox"/> <input type="checkbox"/>

Key	Key Type	Number	SDN COS	Day Ring	Night Ring
DN-01	PDN		<input type="checkbox"/> Station, <input type="checkbox"/> DN		
DN-02			<input type="checkbox"/> Station, ODN		
DN-03			<input type="checkbox"/> Station, nDN		
DN-04			<input type="checkbox"/> Station, <input type="checkbox"/> DN		
DN-05			<input type="checkbox"/> Station, <input type="checkbox"/> DN		
DN-06			<input type="checkbox"/> Station, <input type="checkbox"/> DN		
DN-07			<input type="checkbox"/> Station, <input type="checkbox"/> DN		
DN-08			<input type="checkbox"/> Station, <input type="checkbox"/> DN		
DN-09			<input type="checkbox"/> Station, <input type="checkbox"/> DN		
DN-10			<input type="checkbox"/> Station, <input type="checkbox"/> DN		
DN-11			<input type="checkbox"/> Station, <input type="checkbox"/> DN		
DN-12			<input type="checkbox"/> Station, <input type="checkbox"/> DN		

PF Key	PF Key Type	Number	DSS Key	DSS Key Type	Number
01			01		
02			02		
03			03		
04			04		
05			05		
06			06		
07			07		
08			08		
09					
10					
11					
12					

EXTENSION-STATION

Station Equipment No.

Item	Set Data
Telephone Type and Model	Type _____ Model _____
OHCA Circuit	<input type="checkbox"/> Yes, <input type="checkbox"/> No
Primary Directory Number	- - - - -
Intercom Number	- -
Station Name	- - - - -
ICM Group	-
Pickup Group	- - <input type="checkbox"/> None
Next Hunt Station	<input type="checkbox"/> EXT _____ <input type="checkbox"/> None
Class of Service	- -
Data Line Security	<input type="checkbox"/> Yes, <input type="checkbox"/>
Automatic Callback-Trunk	<input type="checkbox"/> Yes, <input type="checkbox"/> No
Parallel Connect	<input type="checkbox"/> Yes, <input type="checkbox"/>

Key	Key Type	Number	SDN COS	Day Ring	Night Ring
DN-01	PDN		<input type="checkbox"/> Station, <input type="checkbox"/> DN		
DN-02			<input type="checkbox"/> Station, <input type="checkbox"/> DN		
DN-03			<input type="checkbox"/> Station, <input type="checkbox"/> DN		
DN-04			<input type="checkbox"/> Station, <input type="checkbox"/> DN		
DN-05			<input type="checkbox"/> Station, <input type="checkbox"/> DN		
DN-06			<input type="checkbox"/> Station, <input type="checkbox"/> DN		
DN-07			<input type="checkbox"/> Station, <input type="checkbox"/> DN		
DN-08			<input type="checkbox"/> Station, <input type="checkbox"/> DN		
DN-09			<input type="checkbox"/> Station, <input type="checkbox"/> DN		
DN-10			<input type="checkbox"/> Station, <input type="checkbox"/> DN		
DN-11			<input type="checkbox"/> Station, <input type="checkbox"/> DN		
DN-12			<input type="checkbox"/> Station, <input type="checkbox"/> DN		

PF Key	PF Key Type	Number
01		
02		
03		
04		
05		
06		
07		
08		
09		
10		
11		
12		

DSS Key	DSS Key Type	Number
01		
02		
03		
04		
05		
06		
07		
08		

EXTENSION-STATION

Station Equipment No.

Item	Set Data
Telephone Type and Model	Type _____ Model _____
OHCA Circuit	<input type="checkbox"/> <input type="checkbox"/> No
Primacy Directory Number	- - - -
Intercom Number	- -
Station Name	_____
ICM Group	_____
Pickup Group	- - <input type="checkbox"/> None
Next Hunt Station	<input type="checkbox"/> EXT - - - - <input type="checkbox"/> None
Class of Service	- -
Data Line Security	<input type="checkbox"/> <input type="checkbox"/> No
Automatic Callback-Trunk	<input type="checkbox"/> Yes, <input type="checkbox"/> <input type="checkbox"/>
Parallel Connect	<input type="checkbox"/> Yes, <input type="checkbox"/> <input type="checkbox"/>

Key	Key Type	Number	SDN COS	Day Ring	Night Ring
DN-01	PDN		<input type="checkbox"/> Station, <input type="checkbox"/> DN		
DN-02			<input type="checkbox"/> Station, <input type="checkbox"/> DN		
DN-03			<input type="checkbox"/> Station, <input type="checkbox"/> DN		
DN-04			<input type="checkbox"/> Station, <input type="checkbox"/> DN		
DN-05			<input type="checkbox"/> Station, <input type="checkbox"/> DN		
DN-06			<input type="checkbox"/> Station, <input type="checkbox"/> DN		
DN-07			<input type="checkbox"/> Station, <input type="checkbox"/> DN		
DN-08			<input type="checkbox"/> Station, <input type="checkbox"/> DN		
DN-09			<input type="checkbox"/> Station, <input type="checkbox"/> DN		
DN-10			<input type="checkbox"/> Station, <input type="checkbox"/> DN		
DN-11			<input type="checkbox"/> Station, <input type="checkbox"/> DN		
DN-12			<input type="checkbox"/> Station, <input type="checkbox"/> DN		

PF Key	PF Key Type	Number	DSS Key	DSS Key Type	Number
01	I		01		
02			02		
03			03		
04			04		
05			05		
06			06		
07			07		
08			08		
09					
10					
11					
12					

EXTENSION-STATION

Station Equipment No.

Item	Set Data
Telephone Type and Model	Type _____ Model _____
OHCA Circuit	<input type="checkbox"/> <input type="checkbox"/> <input type="checkbox"/> <input type="checkbox"/> <input type="checkbox"/> <input type="checkbox"/>
Primary Directory Number	_____
Intercom Number	_____
Station Name	_____
ICM Group	
Pickup Group	_____ f-J None
Next Hunt Station	<input type="checkbox"/> EXT _____ <input type="checkbox"/> None
Class of Service	- -
Data Line Security	a y e s , <input type="checkbox"/> No
Automatic Callback-Trunk	<input type="checkbox"/> Yes, <input type="checkbox"/> No
Parallel Connect	<input type="checkbox"/> Yes, <input type="checkbox"/> <input type="checkbox"/> <input type="checkbox"/>

Key	Key Type	Number	SDN COS	Day Ring	Night Ring
DN-01	PDN		<input type="checkbox"/> Station, <input type="checkbox"/> DN		
DN-02			<input type="checkbox"/> Station, <input type="checkbox"/> DN		
DN-03			<input type="checkbox"/> Station, <input type="checkbox"/> DN		
DN-04			<input type="checkbox"/> Station, <input type="checkbox"/> DN		
DN-05			<input type="checkbox"/> Station, <input type="checkbox"/> DN		
DN-06			<input type="checkbox"/> Station, <input type="checkbox"/> DN		
DN-07			<input type="checkbox"/> Station, <input type="checkbox"/> DN		
DN-08			<input type="checkbox"/> Station, <input type="checkbox"/> DN		
DN-09			<input type="checkbox"/> Station, <input type="checkbox"/> DN		
DN-10			<input type="checkbox"/> Station, <input type="checkbox"/> DN		
DN-11			<input type="checkbox"/> Station, <input type="checkbox"/> DN		
DN-12			<input type="checkbox"/> Station, <input type="checkbox"/> DN		

PF Key	PF Key Type	Number
01		
02		
03		
04		
05		
06		
07		
08		
09		
10		
11		
12		

DSS Key	DSS Key Type	Number
01		
02		
03		
04		
05		
06		
07		
08		

EXTENSION-STATION

Station Equipment No.

Item	Set Data
Telephone Type and Model	Type _____ Model _____
OHCA Circuit	<input type="checkbox"/> <input type="checkbox"/> No
Primary-Directory Number	
Intercom Number	
Station Name	
ICM Group	
Pickup Group	<input type="checkbox"/> None
Next Hunt Station	<input type="checkbox"/> <input type="checkbox"/> None
Class of Service	
Data Line Security	<input type="checkbox"/> <input type="checkbox"/> No
Automatic Callback-Trunk	<input type="checkbox"/> <input type="checkbox"/>
Parallel Connect	<input type="checkbox"/> Yes, <input type="checkbox"/> No

Key	Key Type	Number	SDN COS	Day Ring	Night Ring
DN-01	PDN		<input type="checkbox"/> Station, <input type="checkbox"/> DN		
DN-02			<input type="checkbox"/> Station, <input type="checkbox"/> DN		
DN-03			<input type="checkbox"/> Station, <input type="checkbox"/> DN		
DN-04			<input type="checkbox"/> Station, <input type="checkbox"/> DN		
DN-05			<input type="checkbox"/> Station, <input type="checkbox"/> DN		
DN-06			<input type="checkbox"/> Station, <input type="checkbox"/> DN		
DN-07			<input type="checkbox"/> Station, <input type="checkbox"/> DN		
DN-08			<input type="checkbox"/> Station, <input type="checkbox"/> DN		
DN-09			<input type="checkbox"/> Station, <input type="checkbox"/> DN		
DN-10			<input type="checkbox"/> Station, <input type="checkbox"/> DN		
DN-11			<input type="checkbox"/> Station, <input type="checkbox"/> DN		
DN-12			<input type="checkbox"/> Station, <input type="checkbox"/> DN		

PF Key	PF Key Type	Number	DSS Key	DSS Key Type	Number
01			01		
02			02		
03			03		
04			04		
05			05		
06			06		
07			07		
08			08		
09					
10					
11					
12					

EXTENSION-STATION

Station Equipment No.

Item	Set Data
Telephone Type and Model	Type _____ Model _____
OHCA Circuit	<input type="checkbox"/> Yes, <input type="checkbox"/> Yes
Primary Directory Number	- - - - -
Intercom Number	- -
Station Name	_____
ICM Group	_____
Pickup Group	- - - <input type="checkbox"/> None
Next Hunt Station	<input type="checkbox"/> Yes _____ <input type="checkbox"/> None
Class of Service	- -
Data Line Security	<input type="checkbox"/> Yes, <input type="checkbox"/> No
Automatic Callback-Trunk	<input type="checkbox"/> Yes, <input type="checkbox"/> No
Parallel Connect	<input type="checkbox"/> Yes, <input type="checkbox"/> No

Key	Key Type	Number	SDN COS	Day Ring	Night Ring
DN-01	PDN		<input type="checkbox"/> Station, <input type="checkbox"/> DN		
DN-02			<input type="checkbox"/> Station, <input type="checkbox"/> DN		
DN-03			<input type="checkbox"/> Station, <input type="checkbox"/> DN		
DN-04			<input type="checkbox"/> Station, <input type="checkbox"/> DN		
DN-05			<input type="checkbox"/> Station, <input type="checkbox"/> DN		
DN-06			<input type="checkbox"/> Station, <input type="checkbox"/> DN		
DN-07			<input type="checkbox"/> Station, <input type="checkbox"/> DN		
DN-08			<input type="checkbox"/> Station, <input type="checkbox"/> DN		
DN-09			<input type="checkbox"/> Station, <input type="checkbox"/> DN		
DN-10			<input type="checkbox"/> Station, <input type="checkbox"/> DN		
DN-11			<input type="checkbox"/> Station, <input type="checkbox"/> DN		
DN-12			<input type="checkbox"/> Station, <input type="checkbox"/> DN		

PF Key	PF Key Type	Number
01		
02		
03		
04		
05		
06		
07		
08		
09		
10		
11		
12		

DSS Key	DSS Key Type	Number
01		
02		
03		
04		
05		
06		
07		
08		

EXTENSION-STATION

Station Equipment No.

Item	Set Data
Telephone Type and Model	Type _____ Model _____
OHCA Circuit	_____
Primary Directory Number	_____
Intercom Number	_____
Station Name	_____
ICM Group	_____
Pickup Group	- - <input type="checkbox"/> None
Next Hunt Station	_____ <input type="checkbox"/> None
Class of Service	_____
Data Line Security	_____
Automatic Callback-Trunk	<input type="checkbox"/> Yes, <input type="checkbox"/> No
Parallel Connect	<input type="checkbox"/> Yes, <input type="checkbox"/>

Key	Key Type	Number	SDN COS	Day Ring	Night Ring
DN-01	P D N		<input type="checkbox"/> Station,C]DN		
DN-02			<input type="checkbox"/> Station, <input type="checkbox"/> DN		
DN-03			<input type="checkbox"/> tation,nDN		
DN-04			<input type="checkbox"/> Station, <input type="checkbox"/> DN		
DN-05			<input type="checkbox"/> Station, <input type="checkbox"/> DN		
DN-06			<input type="checkbox"/> Station, <input type="checkbox"/> DN		
ON-07			<input type="checkbox"/> Station, <input type="checkbox"/> DN		
DN-08			<input type="checkbox"/> Station,nDN		
DN-09			<input type="checkbox"/> Station, <input type="checkbox"/> DN		
DN-10			<input type="checkbox"/> Station, <input type="checkbox"/> DN		
DN-11			<input type="checkbox"/> Station, <input type="checkbox"/> DN		
DN-12			<input type="checkbox"/> Station.ODN		

PF Key	PF Key Type	Number	DSS Key	DSS Key Type	Number
01			01		
02			02		
03			03		
04			04		
05			05		
06			06		
07			07		
08			08		
09					
10					
11					
12					

EXTENSION-STATION

Station Equipment No.

Item	Set Data
Telephone Type and Model	Type _____ Model _____
OHCA Circuit	<input type="checkbox"/> Yes, <input type="checkbox"/> No
Primary Directory Number	_____
Intercom Number	_____
Station Name	_____
ICM Group	
Pickup Group	_____ <input type="checkbox"/> None
Next Hunt Station	<input type="checkbox"/> _____ <input type="checkbox"/> None
Class of Service	
Data Line Security	<input type="checkbox"/> <input type="checkbox"/> No
Automatic Callback-Trunk	<input type="checkbox"/> Yes, <input type="checkbox"/> No
Parallel Connect	<input type="checkbox"/> <input type="checkbox"/> No

Key	Key Type	Number	SDN COS	Day Ring	Night Ring
DN-01	PDN		<input type="checkbox"/> Station, <input type="checkbox"/> DN		
DN-02			<input type="checkbox"/> Station, <input type="checkbox"/> DN		
DN-03			<input type="checkbox"/> Station, <input type="checkbox"/> DN		
DN-04			<input type="checkbox"/> Station, <input type="checkbox"/> DN		
DN-05			<input type="checkbox"/> Station, <input type="checkbox"/> DN		
DN-06			<input type="checkbox"/> Station, <input type="checkbox"/> DN		
DN-07			<input type="checkbox"/> Station, <input type="checkbox"/> DN		
DN-08			<input type="checkbox"/> Station, <input type="checkbox"/> DN		
DN-09			<input type="checkbox"/> Station, <input type="checkbox"/> DN		
DN-10			<input type="checkbox"/> Station, <input type="checkbox"/> DN		
DN-11			<input type="checkbox"/> Station, f-JDN		
DN-12			<input type="checkbox"/> Station, <input type="checkbox"/> DN		

PF Key	PF Key Type	Number	DSS Key	DSS Key Type	Number
01			01		
02			02		
03			03		
04			04		
05			05		
06			06		
07			07		
08			08		
09					
10					
11					
12					

EXTENSION-STATION

Station Equipment No.

Item	Set Data
Telephone Type and Model	Type _____ Model _____
OHCA Circuit	<input type="checkbox"/> Yes, <input type="checkbox"/> No
Primary Directory Number	- - - - -
Intercom Number	- - -
Station Name	_____
ICM Group	---
Pickup Group	- - - <input type="checkbox"/> None
Next Hunt Station	<input type="checkbox"/> EXT _____ <input type="checkbox"/> None
Class of Service	- - -
Data Line Security	<input type="checkbox"/> Yes, <input type="checkbox"/> No
Automatic Callback-Trunk	<input type="checkbox"/> Yes, <input type="checkbox"/> No
Parallel Connect	<input type="checkbox"/> Yes, <input type="checkbox"/> No

Key	Key Type	Number	SDN COS	Day Ring	Night Ring
DN-01	PDN		<input type="checkbox"/> Station, <input type="checkbox"/> DN		
DN-02			<input type="checkbox"/> Station, <input type="checkbox"/> DN		
DN-03			<input type="checkbox"/> Station, <input type="checkbox"/> DN		
DN-04			<input type="checkbox"/> Station, <input type="checkbox"/> DN		
DN-05			<input type="checkbox"/> Station, <input type="checkbox"/> DN		
DN-06			<input type="checkbox"/> Station, <input type="checkbox"/> DN		
DN-07			<input type="checkbox"/> Station, <input type="checkbox"/> DN		
DN-08			<input type="checkbox"/> Station, <input type="checkbox"/> DN		
DN-09			<input type="checkbox"/> Station, <input type="checkbox"/> DN		
DN-10			<input type="checkbox"/> Station, <input type="checkbox"/> DN		
DN-11			<input type="checkbox"/> Station, <input type="checkbox"/> DN		
DN-12			<input type="checkbox"/> Station, <input type="checkbox"/> DN		

PF Key	PF Key Type	Number
01		
02		
03		
04		
05		
06		
07		
08		
09		
10		
11		
12		

DSS Key	DSS Key Type	Number
01		
02		
03		
04		
05		
06		
07		
08		

EXTENSION-STATION

Station Equipment No.

Item	Set Data
Telephone Type and Model	Type _____ Model _____
OHCA Circuit	<input type="checkbox"/> Yes, <input type="checkbox"/> No
Primary Directory Number	- - - -
Intercom Number	- -
Station Name	- - - - -
ICM Group	-
Pickup Group	- - <input type="checkbox"/> None
Next Hunt Station	<input type="checkbox"/> <input type="checkbox"/> None
Class of Service	- -
Data Line Security	<input type="checkbox"/> Yes, <input type="checkbox"/> No
Automatic Callback-Trunk	<input type="checkbox"/> Yes, <input type="checkbox"/> No
Parallel Connect	<input type="checkbox"/> Yes, <input type="checkbox"/> No

Key	Key Type	Number	SDN COS	Day Ring	Night Ring
DN-01	PDN		<input type="checkbox"/> Station, <input type="checkbox"/> DN		
DN-02			<input type="checkbox"/> Station, ODN		
DN-03			<input type="checkbox"/> Station, <input type="checkbox"/> DN		
DN-04			<input type="checkbox"/> Station, <input type="checkbox"/> DN		
DN-05			<input type="checkbox"/> Station, <input type="checkbox"/> DN		
DN-06			<input type="checkbox"/> Station, <input type="checkbox"/> DN		
DN-07			<input type="checkbox"/> Station, jJDN		
DN-08			<input type="checkbox"/> Station, <input type="checkbox"/> DN		
DN-09			<input type="checkbox"/> Station, <input type="checkbox"/> DN		
DN-10			<input type="checkbox"/> <input type="checkbox"/> DN		
DN-11			<input type="checkbox"/> Station, <input type="checkbox"/> DN		
DN-12			<input type="checkbox"/> Station, ODN		

PF Key	PF Key Type	Number
01		
02		
03		
04		
05		
06		
07		
08		
09		
10		
11		
12		

DSS Key	DSS Key Type	Number
01		
02		
03		
04		
05		
06		
07		
08		

EXTENSION-STATION

Station Equipment No.

item	Set Data
Telephone Type and Model	Type _____ Model _____
OHCA Circuit	<input type="checkbox"/> Yes, <input type="checkbox"/> <input type="checkbox"/>
Primary Directory Number	- - - -
Intercom Number	- -
Station Name	_____
ICM Group	_____
Pickup Group	- - <input type="checkbox"/> <input type="checkbox"/>
Next Hunt Station	<input type="checkbox"/> EXT <input type="checkbox"/> None _____
Class of Service	- -
Data Line Security	<input type="checkbox"/> Yes, <input type="checkbox"/> <input type="checkbox"/>
Automatic Callback-Trunk	<input type="checkbox"/> Yes, <input type="checkbox"/> No
Parallel Connect	<input type="checkbox"/> Yes, <input type="checkbox"/> <input type="checkbox"/>

Key	Key Type	Number	SDN COS	Day Ring	Night Ring
DN-01	PDN		<input type="checkbox"/> Station, <input type="checkbox"/> DN		
DN-02			<input type="checkbox"/> Station, <input type="checkbox"/> DN		
DN-03			<input type="checkbox"/> Station, <input type="checkbox"/> DN		
DN-04			<input type="checkbox"/> Station.nDN		
DN-05			<input type="checkbox"/> Station, <input type="checkbox"/> DN		
DN-06			<input type="checkbox"/> Station, <input type="checkbox"/> DN		
DN-07			<input type="checkbox"/> Station, <input type="checkbox"/> DN		
DN-08			<input type="checkbox"/> Station, <input type="checkbox"/> DN		
DN-09			<input type="checkbox"/> Station, <input type="checkbox"/> DN		
DN-10			<input type="checkbox"/> Station, <input type="checkbox"/> DN		
DN-11			<input type="checkbox"/> Station, <input type="checkbox"/> DN		
DN-12			<input type="checkbox"/> Station, <input type="checkbox"/> DN		

PF Key	PF Key Type	Number	DSS Key	DSS Key Type	Number
01			01		
02			02		
03			03		
04			04		
05			05		
06			06		
07			07		
08			08		
09					
10					
11					
12					

EXTENSION-STATION

Station Equipment No.

Item	Set Data
Telephone Type and Model	Type _____ Model _____
OHCA Circuit	<input type="checkbox"/> Yes, <input type="checkbox"/> <input type="checkbox"/>
Primary Directory Number	_____
Intercom Number	_____
Station Name	_____
ICM Group	
Pickup Group	_____ <input type="checkbox"/> None
Next Hunt Station	<input type="checkbox"/> EXT _____ <input type="checkbox"/> None
Class of Service	_____
Data Line Security	ayes, <input type="checkbox"/> No
Automatic Callback-Trunk	<input type="checkbox"/> Yes, <input type="checkbox"/> No
Parallel Connect	<input type="checkbox"/> Yes, <input type="checkbox"/> <input type="checkbox"/>

Key	Key Type	Number	SDN COS	Day Ring	Night Ring
DN-01	PDN		<input type="checkbox"/> Station, <input type="checkbox"/> DN		
DN-02			<input type="checkbox"/> Station, <input type="checkbox"/> DN		
DN-03			<input type="checkbox"/> Station, <input type="checkbox"/> DN		
DN-04			<input type="checkbox"/> Station, <input type="checkbox"/> DN		
DN-05			<input type="checkbox"/> Station, <input type="checkbox"/> DN		
DN-06			<input type="checkbox"/> Station, <input type="checkbox"/> DN		
DN-07			<input type="checkbox"/> Station, <input type="checkbox"/> DN		
DN-08			<input type="checkbox"/> Station, <input type="checkbox"/> DN		
DN-09			<input type="checkbox"/> Station, <input type="checkbox"/> DN		
DN-10			<input type="checkbox"/> Station, <input type="checkbox"/> DN		
DN-11			<input type="checkbox"/> Station, <input type="checkbox"/> DN		
DN-12			<input type="checkbox"/> Station, <input type="checkbox"/> DN		

PF Key	PF Key Type	Number	DSS Key	DSS Key Type	Number
01			01		
02			02		
03			03		
04			04		
05			05		
06			06		
07			07		
08			08		
09					
10					
11					
12					

EXTENSION-STATION

Station Equipment No.

Item	Set Data
Telephone Type and Model	Type _____ Model _____
OHCA Circuit	<input type="checkbox"/> Yes, <input type="checkbox"/> No
Primary Directory Number	- - - -
Intercom Number	- -
Station Name	_____
ICM Group	_____
Pickup Group	- - <input type="checkbox"/> None
Next Hunt Station	<input type="checkbox"/> <input type="checkbox"/> <input type="checkbox"/> <input type="checkbox"/> <input type="checkbox"/> None
Class of Service	- -
Data Line Security	<input type="checkbox"/> Yes, <input type="checkbox"/> <input type="checkbox"/>
Automatic Callback-Trunk	<input type="checkbox"/> Yes, <input type="checkbox"/> <input type="checkbox"/>
Parallel Connect	<input type="checkbox"/> <input type="checkbox"/> <input type="checkbox"/> No

Key	Key Type	Number	SDN COS	Day Ring	Night Ring
DN-01	PDN		<input type="checkbox"/> Station, <input type="checkbox"/> DN		
DN-02			<input type="checkbox"/> Station, QDN		
DN-03			<input type="checkbox"/> Station, ODN		
DN-04			<input type="checkbox"/> Station, uDN		
DN-05			<input type="checkbox"/> Station, <input type="checkbox"/> DN		
DN-06			<input type="checkbox"/> Station, <input type="checkbox"/> DN		
DN-07			<input type="checkbox"/> Station, <input type="checkbox"/> DN		
DN-08			<input type="checkbox"/> Station, <input type="checkbox"/> DN		
DN-09			<input type="checkbox"/> Station, <input type="checkbox"/> DN		
DN-10			<input type="checkbox"/> Station, <input type="checkbox"/> DN		
DN-11			<input type="checkbox"/> Station, <input type="checkbox"/> DN		
DN-12			<input type="checkbox"/> Station, <input type="checkbox"/> DN		

PF Key	PF Key Type	Number
01		
02		
03		
04		
05		
06		
07		
08		
09		
10		
11		
12		

DSS Key	DSS Key Type	Number
01		
02		
03		
04		
05		
06		
07		
08		

EXTENSION-STATION

Station Equipment No.

Item	Set Data
Telephone Type and Model	Type _____ Model _____
OHCA Circuit	<input type="checkbox"/> <input type="checkbox"/>
Primary Directory Number	- - - -
Intercom Number	- -
Station Name	_____
ICM Group	_____
Pickup Group	- - I-J None
Next Hunt Station	<input type="checkbox"/> _____ <input type="checkbox"/> None
Class of Service	- -
Data Line Security	<input type="checkbox"/> <input type="checkbox"/>
Automatic Callback-Trunk	<input type="checkbox"/> Yes, <input type="checkbox"/> No
Parallel Connect	<input type="checkbox"/> <input type="checkbox"/>

Key	Key Type	Number	SDN COS	Day Ring	Night Ring
DN-01	PDN		<input type="checkbox"/> Station, <input type="checkbox"/> DN		
DN-02			<input type="checkbox"/> Station, <input type="checkbox"/> DN		
DN-03			<input type="checkbox"/> Station, <input type="checkbox"/> DN		
DN-04			<input type="checkbox"/> Station, <input type="checkbox"/> DN		
DN-05			<input type="checkbox"/> Station, <input type="checkbox"/> DN		
DN-06			<input type="checkbox"/> Station, <input type="checkbox"/> DN		
DN-07			<input type="checkbox"/> Station, <input type="checkbox"/> DN		
DN-08			<input type="checkbox"/> Station, <input type="checkbox"/> DN		
DN-09			<input type="checkbox"/> Station, <input type="checkbox"/> DN		
DN-10			<input type="checkbox"/> Station, <input type="checkbox"/> DN		
DN-11			<input type="checkbox"/> Station, <input type="checkbox"/> DN		
DN-12			<input type="checkbox"/> Station, <input type="checkbox"/> DN		

PF Key	PF Key Type	Number	DSS Key	DSS Key Type	Number
01			01		
02			02		
03			03		
04			04		
05			05		
06			06		
07			07		
08			08		
09					
10					
11					
t 12 t					

EXTENSION-STATION

Station Equipment No.

Item	Set Data
Telephone Type and Model	Type _____ Model _____
OHCA Circuit	<input type="checkbox"/> Yes, <input type="checkbox"/> No
Primary Directory Number	- - - -
Intercom Number	- -
Station Name	_____
ICM Group	---
Pickup Group	- - 0 None
Next Hunt Station	<input type="checkbox"/> _____ <input type="checkbox"/> None
Class of Service	- -
Data Line Security	<input type="checkbox"/> <input type="checkbox"/> No
Automatic Callback-Trunk	<input type="checkbox"/> Yes, <input type="checkbox"/> No
Parallel Connect	<input type="checkbox"/> Yes, <input type="checkbox"/> No

Key	Key Type	Number	SDN COS	Day Ring	Night Ring
DN-01	PDN		<input type="checkbox"/> Station, <input type="checkbox"/> DN		
DN-02			<input type="checkbox"/> Station, uDN		
DN-03			<input type="checkbox"/> Station, <input type="checkbox"/> DN		
DN-04			<input type="checkbox"/> Station, ODN		
DN-05			<input type="checkbox"/> Station, <input type="checkbox"/> DN		
DN-06			<input type="checkbox"/> Station, <input type="checkbox"/> DN		
DN-07			<input type="checkbox"/> Station, <input type="checkbox"/> DN		
DN-08			<input type="checkbox"/> Station, nDN		
DN-09			<input type="checkbox"/> Station, ODN		
DN-10			<input type="checkbox"/> Station, ODN		
DN-11			<input type="checkbox"/> Station, nDN		
DN-12			<input type="checkbox"/> Station, <input type="checkbox"/> DN		

PF Key	PF Key Type	Number	DSS Key	DSS Key Type	Number
01			01		
02			02		
03			03		
04			04		
05			05		
06			06		
07			07		
08			08		
09					
10					
11					
12					

EXTENSION-STATION

Station Equipment No.

Item	Set Data
Telephone Type and Model	Type _____ Model _____
OHCA Circuit	<input type="checkbox"/> Yes, <input type="checkbox"/> No
Primary Directory Number	- - - -
intercom Number	- -
S t a t i o	n N a m e
ICM Group	—
Pickup Group	- - <input type="checkbox"/> None
Next Hunt Station	<input type="checkbox"/> <input type="checkbox"/> <input type="checkbox"/> None
Class of Service	- -
Data Line Security	<input type="checkbox"/> Yes, <input type="checkbox"/> No
Automatic Callback-Trunk	<input type="checkbox"/> Yes. <input type="checkbox"/> No
Parallel Connect	<input type="checkbox"/> <input type="checkbox"/> No

Key	Key Type	Number	SDN COS	Day Ring	Night Ring
DN-01	PDN		<input type="checkbox"/> Station, <input type="checkbox"/> DN		
DN-02			<input type="checkbox"/> Station, <input type="checkbox"/> DN		
DN-03			<input type="checkbox"/> Station, <input type="checkbox"/> DN		
DN-04			<input type="checkbox"/> Station, <input type="checkbox"/> DN		
DN-05			<input type="checkbox"/> Station, <input type="checkbox"/> DN		
DN-06			<input type="checkbox"/> Station, <input type="checkbox"/> DN		
DN-07			<input type="checkbox"/> Station, <input type="checkbox"/> DN		
DN-08			<input type="checkbox"/> Station, <input type="checkbox"/> DN		
DN-09			<input type="checkbox"/> Station, <input type="checkbox"/> DN		
DN-10			<input type="checkbox"/> Station, <input type="checkbox"/> DN		
DN-11			<input type="checkbox"/> Station, <input type="checkbox"/> DN		
DN-12			<input type="checkbox"/> Station, <input type="checkbox"/> DN		

PF Key	PF Key Type	Number
01		
02		
03		
04		
05		
06		
07		
08		
09		
10		
11		
12		

DSS Key	DSS Key Type	Number
01		
02		
03		
04		
05		
06		
07		
08		

EXTENSION-STATION

Station Equipment No.

item	Set Data
Telephone Type and Model	Type _____ Model _____
OHCA Circuit	<input type="checkbox"/> Yes, <input type="checkbox"/> No
Primary Directory Number	- - - -
intercom Number	- -
Station Name	_____
ICM Group	_____
Pickup Group	- - <input type="checkbox"/> None
Next Hunt Station	<input type="checkbox"/> <input type="checkbox"/> None
Class of Service	- -
Data Line Security	<input type="checkbox"/> <input type="checkbox"/> No
Automatic Callback-Trunk	<input type="checkbox"/> Yes, <input type="checkbox"/> No
Parallel Connect	<input type="checkbox"/> Yes, <input type="checkbox"/> No

Key	Key Type	Number	SDN COS	Day Ring	Night Ring
DN-01	PDN		<input type="checkbox"/> Station, <input type="checkbox"/> DN		
DN-02			<input type="checkbox"/> Station, <input type="checkbox"/> DN		
DN-03			<input type="checkbox"/> Station, <input type="checkbox"/> DN		
DN-04			<input type="checkbox"/> Station, <input type="checkbox"/> DN		
DN-05			<input type="checkbox"/> Station, <input type="checkbox"/> DN		
DN-06			<input type="checkbox"/> Station, <input type="checkbox"/> DN		
DN-07			<input type="checkbox"/> Station, <input type="checkbox"/> DN		
DN-08			<input type="checkbox"/> Station, <input type="checkbox"/> DN		
DN-09			<input type="checkbox"/> Station, <input type="checkbox"/> DN		
DN-10			<input type="checkbox"/> Station, <input type="checkbox"/> DN		
DN-11			<input type="checkbox"/> Station, <input type="checkbox"/> DN		
DN-12			<input type="checkbox"/> Station, <input type="checkbox"/> DN		

PF Key	PF Key Type	Number
01		
02		
03		
04		
05		
06		
07		
08		
09		
10		
11		
12		

DSS Key	DSS Key Type	Number
01		
02		
03		
04		
05		
06		
07		
08		

EXTENSION-STATION

Station Equipment No.

Item	Set Data
Telephone Type and Model	Type _____ Model _____
OHCA Circuit.	<input type="checkbox"/> Yes, <input type="checkbox"/> No <input type="checkbox"/>
Primary Directory Number	- - - - -
Intercom Number	- -
Station Name	- - - - -
ICM Group	-
Pickup Group	- - <input type="checkbox"/> None
Next Hunt Station	<input type="checkbox"/> <input type="checkbox"/> None
Class of Service	- -
Rata Line Security	<input type="checkbox"/> <input type="checkbox"/> <input type="checkbox"/> <input type="checkbox"/>
Automatic Callback-Trunk	<input type="checkbox"/> <input type="checkbox"/> <input type="checkbox"/> <input type="checkbox"/> <input type="checkbox"/> No
Parallel Connect	<input type="checkbox"/> Yes, <input type="checkbox"/> No

Key	Key Type	Number	SDN COS	Day Ring	Night Ring
DN-01	PDN		<input type="checkbox"/> Station, <input type="checkbox"/> DN		
DN-02			<input type="checkbox"/> Station, <input type="checkbox"/> DN		
DN-03			<input type="checkbox"/> Station, <input type="checkbox"/> DN		
DN-04			<input type="checkbox"/> Station, <input type="checkbox"/> DN		
DN-05			<input type="checkbox"/> Station, <input type="checkbox"/> DN		
DN-06			<input type="checkbox"/> Station, <input type="checkbox"/> DN		
DN-07			<input type="checkbox"/> Station, <input type="checkbox"/> DN		
DN-08			<input type="checkbox"/> Station, <input type="checkbox"/> DN		
DN-09			<input type="checkbox"/> Station, <input type="checkbox"/> DN		
DN-10			<input type="checkbox"/> Station, <input type="checkbox"/> DN		
DN-11			<input type="checkbox"/> Station, <input type="checkbox"/> DN		
DN-12			<input type="checkbox"/> Station, <input type="checkbox"/> DN		

PF Key	PF Key Type	Number	DSS Key	DSS Key Type	Number
01			01		
02			02		
03			03		
04			04		
05			05		
06			06		
07			67		
08			08		
09					
10					
11					
12					

EXTENSION-STATION

Station Equipment No.

Item	Set Data
Telephone Type and Model	Type _____ Model _____
QHCA Circuit	<input type="checkbox"/> <input type="checkbox"/> No
Primary Directory Number	- - - -
Intercom Number	- -
Station Name	_____
ICM Group	_____
Pickup Group	- - <input type="checkbox"/> None
Next Hunt Station	<input type="checkbox"/> EXT <input type="checkbox"/> _____ N = n e
Class of Service	- -
Data Line Security	<input type="checkbox"/> <input type="checkbox"/> No
Automatic Callback-Trunk	<input type="checkbox"/> <input type="checkbox"/> No
Parallel Connect	<input type="checkbox"/> <input type="checkbox"/> No

Key	Key Type	Number	SDN COS	Day Ring	Night Ring
DN-01	PDN		<input type="checkbox"/> Station, <input type="checkbox"/> DN		
DN-02			<input type="checkbox"/> Station, <input type="checkbox"/> DN		
DN-03			<input type="checkbox"/> Station, <input type="checkbox"/> DN		
DN-04			<input type="checkbox"/> Station, <input type="checkbox"/> DN		
DN-05			<input type="checkbox"/> Station, <input type="checkbox"/> DN		
DN-06			<input type="checkbox"/> Station, <input type="checkbox"/> DN		
DN-07			<input type="checkbox"/> Station, <input type="checkbox"/> DN		
DN-08			<input type="checkbox"/> Station, <input type="checkbox"/> DN		
DN-09			<input type="checkbox"/> Station, <input type="checkbox"/> DN		
DN-10			<input type="checkbox"/> Station, <input type="checkbox"/> DN		
DN-11			<input type="checkbox"/> Station, <input type="checkbox"/> DN		
DN-12			<input type="checkbox"/> Station, <input type="checkbox"/> DN		

PF Key	PF Key Type	Number
01		
02		
03		
04		
05		
06		
07		
08		
09		
10		
11		
12		

DSS Key	DSS Key Type	Number
01		
02		
03		
04		
05		
06		
07		
08		

EXTENSION-STATION

Station Equipment No.

Item	Set Data
Telephone Type and Model	Type _____ Model _____
OHCA Circuit	<input type="checkbox"/> Yes, <input type="checkbox"/> No
Primary Directory Number	_____
Intercom Number	---
Station Name	-----
ICM Group	
Pickup Group	--- <input type="checkbox"/> None
Next Hunt Station	<input type="checkbox"/> EXT _____ <input type="checkbox"/> None
Class of Service	---
Data Line Security	<input type="checkbox"/> <input type="checkbox"/>
Automatic Callback-Trunk	<input type="checkbox"/> Yes, <input type="checkbox"/> No
Parallel Connect	<input type="checkbox"/> <input type="checkbox"/>

Key	Key Type	Number	SDN COS	Day Ring	Night Ring
DN-01	PDN		<input type="checkbox"/> Station, <input type="checkbox"/> DN		
DN-02			<input type="checkbox"/> Station, <input type="checkbox"/> DN		
DN-03			<input type="checkbox"/> Station, <input type="checkbox"/> DN		
DN-04			<input type="checkbox"/> Station, <input type="checkbox"/> DN		
DN-05			<input type="checkbox"/> Station, <input type="checkbox"/> DN		
DN-06			<input type="checkbox"/> Station, <input type="checkbox"/> DN		
DN-07			<input type="checkbox"/> Station, <input type="checkbox"/> DN		
DN-08			<input type="checkbox"/> Station, <input type="checkbox"/> DN		
DN-09			<input type="checkbox"/> Station, <input type="checkbox"/> DN		
DN-10			<input type="checkbox"/> Station, <input type="checkbox"/> DN		
DN-11			<input type="checkbox"/> Station, <input type="checkbox"/> DN		
DN-12			<input type="checkbox"/> Station, <input type="checkbox"/> DN		

PF Key	PF Key Type	Number
01		
02		
03		
04		
05		
06		
07		
08		
09		
10		
11		
12		

DSS Key	DSS Key Type	Number
01		
02		
03		
04		
05		
06		
07		
08		

EXTENSION-STATION

Station Equipment No.

Item	Set Data
Telephone Type and Model	Type _____ Model _____
OHCA Circuit	<input type="checkbox"/> Yes, <input type="checkbox"/> <input type="checkbox"/>
Primary Directory Number	_____
Intercom Number	- -
Station Name	_____
ICM Group	_____
Pickup Group	- - <input type="checkbox"/> None
Next Hunt Station	<input type="checkbox"/> EXT _____ <input type="checkbox"/> None
Class of Service	- -
Data Line Security	<input type="checkbox"/> <input type="checkbox"/> No
Automatic Callback-Trunk	<input type="checkbox"/> Yes, <input type="checkbox"/> <input type="checkbox"/>
Parallel Connect	<input type="checkbox"/> <input type="checkbox"/>

Key	Key Type	Number	SDN COS	Day Ring	Night Ring
DN-01	PDN		<input type="checkbox"/> Station, <input type="checkbox"/> DN		
DN-02			<input type="checkbox"/> Station, <input type="checkbox"/> DN		
DN-03			<input type="checkbox"/> Station, <input type="checkbox"/> DN		
DN-04			<input type="checkbox"/> Station, <input type="checkbox"/> DN		
DN-05			<input type="checkbox"/> Station, <input type="checkbox"/> DN		
DN-06			<input type="checkbox"/> Station, <input type="checkbox"/> DN		
DN-07			<input type="checkbox"/> Station, <input type="checkbox"/> DN		
DN-08			<input type="checkbox"/> Station, <input type="checkbox"/> DN		
DN-09			<input type="checkbox"/> Station, <input type="checkbox"/> DN		
DN-10			<input type="checkbox"/> Station, <input type="checkbox"/> DN		
DN-11			<input type="checkbox"/> Station, <input type="checkbox"/> DN		
DN-12			<input type="checkbox"/> Station, <input type="checkbox"/> DN		

PF Key	PF Key Type	Number
01		
02		
03		
04		
05		
06		
07		
08		
09		
10		
11		
12		

DSS Key	DSS Key Type	Number
01		
02		
03		
04		
05		
06		
07		
08		

EXTENSION-STATION

Station Equipment No.

Item	Set Data
Telephone Type and Model	Type _____ Model _____
CHCA Circuit	<input type="checkbox"/> Yes, <input type="checkbox"/> No
Primary Directory Number	- - - -
Intercom Number	- -
Station Name	_____
ICM Group	_____
Pickup Group	- - 0 None
Next Hunt Station	<input type="checkbox"/> EXT _____ <input type="checkbox"/> None
Class of Service	- -
Data Line Security	<input type="checkbox"/> Yes, <input type="checkbox"/> No
Automatic Callback-Trunk	<input type="checkbox"/> Yes, <input type="checkbox"/> No
Parallel Connect	<input type="checkbox"/> <input type="checkbox"/> No

Key	Key Type	Numbs	SDN COS	Day Ring	Night Ring
EN-01	PDN		<input type="checkbox"/> Station,nDN		
DN-02			<input type="checkbox"/> Station, <input type="checkbox"/> DN		
DN-03			<input type="checkbox"/> Station,nDN		
DN-04			<input type="checkbox"/> Station,ODN		
DN-05			<input type="checkbox"/> Station, <input type="checkbox"/> DN		
DN-06			<input type="checkbox"/> Station, <input type="checkbox"/> DN		
DN-07			<input type="checkbox"/> Station, <input type="checkbox"/> DN		
DN-08			<input type="checkbox"/> Station, <input type="checkbox"/> DN		
DN-09			<input type="checkbox"/> Station, <input type="checkbox"/> DN		
DN-10			<input type="checkbox"/> Station,ODN		
DN-11			<input type="checkbox"/> jStation, <input type="checkbox"/> DN		
DN-12			<input type="checkbox"/> Station, <input type="checkbox"/> DN		

PF Key	PF Key Type	Number	DSS Key	DSS Key Type	Number
01			01		
02			02		
03			03		
04			04		
05			05		
06			06		
07			07		
08			08		
09					
10					
11					
12					

EXTENSION-STATION

Station Equipmen: No.

Item	Set Data
Telephone Type and Model	Type _____ Model _____
OHCA Circuit	<input type="checkbox"/> Yes, <input type="checkbox"/> <input type="checkbox"/>
Primary Directory Number	_____
Intercom Number	_____
Station Name	_____
ICM Group	_____
Pickup Group	- - <input type="checkbox"/> None
Next Hunt Station	<input type="checkbox"/> <input type="checkbox"/> <input type="checkbox"/> None
Class of Service	- -
Data Line Security	<input type="checkbox"/> Yes, <input type="checkbox"/> No
Automatic Callback-Trunk	<input type="checkbox"/> Yes, <input type="checkbox"/> <input type="checkbox"/>
Parallel Connect	<input type="checkbox"/> Yes, <input type="checkbox"/> <input type="checkbox"/>

Key	Key Type	Number	SDN COS	Day Ring	Night Ring
DN-01	PDN		<input type="checkbox"/> Station, <input type="checkbox"/> DN		
DN-02			<input type="checkbox"/> Station, <input type="checkbox"/> DN		
DN-03			<input type="checkbox"/> Station, <input type="checkbox"/> DN		
DN-04			<input type="checkbox"/> Station, <input type="checkbox"/> DN		
DN-05			<input type="checkbox"/> Station, <input type="checkbox"/> DN		
DN-06			<input type="checkbox"/> Station, <input type="checkbox"/> DN		
DN-07			<input type="checkbox"/> Station, <input type="checkbox"/> DN		
ON-08			<input type="checkbox"/> Station, <input type="checkbox"/> DN		
ON-09			<input type="checkbox"/> Station, <input type="checkbox"/> DN		
ON-10			<input type="checkbox"/> Station, <input type="checkbox"/> DN		
ON-11			<input type="checkbox"/> Station, <input type="checkbox"/> DN		
ON-12			<input type="checkbox"/> Station, <input type="checkbox"/> DN		

PF Key	PF Key Type	Number	DSS Key	DSS Key Type	Number
01			01		
02			02		
03			03		
04			04		
05			05		
06			06		
07			07		
08			08		
09					
10					
11					
12					

EXTENSION-STATION

Station Equipment No.

Item	Set Data
Telephone Type and Model	Type _____ Model _____
OHCA Circuit	<input type="checkbox"/> <input type="checkbox"/> No
Primary Directory Number	
Intercom Number	
Station Name	
ICM Group	_____
Pickup Group	<input type="checkbox"/> None
Next Hunt Station	<input type="checkbox"/> <input type="checkbox"/> None
Class of Service	
Data Line Security	<input type="checkbox"/> <input type="checkbox"/> No
Automatic Callback-Trunk	<input type="checkbox"/> Yes, <input type="checkbox"/> No
Parallel Connect	<input type="checkbox"/> Yes, <input type="checkbox"/> No

Key	Key Type	Number	SDN COS	Day Ring	Night Ring
DN-01	PDN		<input type="checkbox"/> Station, <input type="checkbox"/> DN		
DN-02			<input type="checkbox"/> Station, <input type="checkbox"/> DN		
DN-03			<input type="checkbox"/> Station, <input type="checkbox"/> DN		
DN-04			<input type="checkbox"/> Station, <input type="checkbox"/> DN		
DN-05			<input type="checkbox"/> Station, <input type="checkbox"/> DN		
DN-06			<input type="checkbox"/> Station, <input type="checkbox"/> DN		
DN-07			<input type="checkbox"/> Station, <input type="checkbox"/> DN		
DN-08			<input type="checkbox"/> Station, <input type="checkbox"/> DN		
DN-09			<input type="checkbox"/> Station, <input type="checkbox"/> DN		
DN-10			<input type="checkbox"/> Station, <input type="checkbox"/> DN		
DN-11			<input type="checkbox"/> Station, <input type="checkbox"/> DN		
DN-12			<input type="checkbox"/> Station, <input type="checkbox"/> DN		

PF Key	PF Key Type	Number
01		
02		
03		
04		
05		
06		
07		
08		
09		
10		
11		
12		

DSS Key	DSS Key Type	Number
01		
02		
03		
04		
05		
06		
07		
08		

EXTENSION-STATION

Station Equipment No.

item	Set Data
Telephone Type and Model	Type _____ Model _____
OHCA Circuit	<input type="checkbox"/> Yes, <input type="checkbox"/> No
Primary Directory Number	- - - -
Intercom Number	- -
Station Name	_____
ICM Group	_____
Pickup Group	- - E None
Next Hunt Station	<input type="checkbox"/> <input type="checkbox"/> _____ <input type="checkbox"/> None
Class of Service	- -
Data Line Security	<input type="checkbox"/> <input type="checkbox"/> <input type="checkbox"/> No
Automatic Callback-Trunk	<input type="checkbox"/> Yes, <input type="checkbox"/> No
Parallel Connect	<input type="checkbox"/> Yes, <input type="checkbox"/> <input type="checkbox"/>

Key	Key Type	Number	SDN COS	Day Ring	Night Ring
DN-01	PDN		<input type="checkbox"/> Station, <input type="checkbox"/> DN		
DN-02			<input type="checkbox"/> Station, <input type="checkbox"/> DN		
DN-03			<input type="checkbox"/> Station, <input type="checkbox"/> DN		
DN-04			<input type="checkbox"/> Station, <input type="checkbox"/> DN		
DN-05			<input type="checkbox"/> Station, <input type="checkbox"/> DN		
DN-06			<input type="checkbox"/> Station, <input type="checkbox"/> DN		
DN-07			<input type="checkbox"/> Station, <input type="checkbox"/> DN		
DN-08			<input type="checkbox"/> Station, <input type="checkbox"/> DN		
DN-09			<input type="checkbox"/> Station, <input type="checkbox"/> DN		
DN-10			<input type="checkbox"/> Station, <input type="checkbox"/> DN		
DN-11			<input type="checkbox"/> Station, <input type="checkbox"/> DN		
DN-12			<input type="checkbox"/> Station, <input type="checkbox"/> DN		

PF Key	PF Key Type	Number	DSS Key	DSS Key Type	Number
01			01		
02			02		
I 03 I			03		
04			04		
05			05		
06			06		
07			07		
08			08		
09					
10					
11					
12					

EXTENSION-STATION

Station Equipment No.

Item	Set Data
Telephone Type and Model	Type _____ Model _____
OHCA Circuit	<input type="checkbox"/> <input type="checkbox"/> No
Primary Directory Number	- - - -
Intercom Number	- -
Station Name	- - - - -
ICM Group	----
Pickup Group	- - <input type="checkbox"/> None
Next Hunt Station	<input type="checkbox"/> _____ <input type="checkbox"/> None
Class of Service	- -
Data Line Security	<input type="checkbox"/> Yes, <input type="checkbox"/> No
Automatic Callback-Trunk	<input type="checkbox"/> <input type="checkbox"/> No
Parallel Connect	<input type="checkbox"/> <input type="checkbox"/> No

Key	Key Type	Number	SDN	COS	Day Ring	Night Ring
DN-01	PDN		<input type="checkbox"/>	Station, <input type="checkbox"/> DN		
DN-02			<input type="checkbox"/>	Station, <input type="checkbox"/> DN		
DN-03			<input type="checkbox"/>	Station, <input type="checkbox"/> DN		
DN-04			<input type="checkbox"/>	Station, nDN		
DN-05			<input type="checkbox"/>	Station, <input type="checkbox"/> DN		
DN-06			<input type="checkbox"/>	Station, <input type="checkbox"/> DN		
DN-07			<input type="checkbox"/>	Station, <input type="checkbox"/> DN		
DN-08			<input type="checkbox"/>	Station, uDN		
DN-09			<input type="checkbox"/>	Station, nDN		
DN-10			<input type="checkbox"/>	Station, <input type="checkbox"/> DN		
DN-11			<input type="checkbox"/>	Station, <input type="checkbox"/> DN		
DN-12			<input type="checkbox"/>	Station, ODN		

PF Key	PF Key Type	Number	DSS Key	DSS Key Type	Number
01			01		
02			02		
03			03		
04			04		
05			05		
06			06		
07			07		
08			08		
09					
10					
11					
12					

EXTENSION-STATION

Station Equipment No.

Item	Set Data
Telephone Type and Model	Type _____ Model _____
OHCA Circuit	<input type="checkbox"/> Yes. <input type="checkbox"/> No
Primary Directory Number	_____
Intercom Number	_____
Station Name	_____
ICM Group	
Pickup Group	- - <input type="checkbox"/> None
Next Hunt Station	[I: EXT <input type="checkbox"/> N o n e
Class of Service	- -
Data Line Security	<input type="checkbox"/> Yes. <input type="checkbox"/> No
Automatic Callback-Trunk	<input type="checkbox"/> Yes. <input type="checkbox"/> No
Parallel Connect	<input type="checkbox"/> Yes. <input type="checkbox"/> No

Key	Key Type	Number	SDN COS	Day Ring	Night Ring
DN-01	PDN		<input type="checkbox"/> Station,ODN		
DN-02			<input type="checkbox"/> Station,nDN		
DN-03			<input type="checkbox"/> Station, <input type="checkbox"/> DN		
DN-04			<input type="checkbox"/> Station,nDN		
DN-05			<input type="checkbox"/> Station, <input type="checkbox"/> DN		
DN-06			<input type="checkbox"/> Station,nDN		
DN-07			<input type="checkbox"/> Station, <input type="checkbox"/> DN		
DN-08			<input type="checkbox"/> Station,uDN		
DN-09			<input type="checkbox"/> Station, <input type="checkbox"/> DN		
DN-10			<input type="checkbox"/> Station, <input type="checkbox"/> DN		
DN-11			<input type="checkbox"/> Station, <input type="checkbox"/> DN		
DN-12			<input type="checkbox"/> Station.ODN		

PF Key	PF Key Type	Number
01		
02		
03		
04		
05		
06		
07		
08		
09		
10		
11		
12		

DSS Key	DSS Key Type	Number
01		
02		
03		
04		
05		
06		
07		
08		

EXTENSION-STATION

Station Equipment No.

Item	Set Data
Telephone Type and Model	Type _____ Model _____
OHCA Circuit	<input type="checkbox"/> Yes, <input type="checkbox"/>
Primary Directory Number	
intercom Number	---
Station Name	-----
ICM Group	
Pickup Group	--- <input type="checkbox"/> None
Next Hunt Station	<input type="checkbox"/> EXT - - - - <input type="checkbox"/> None
Class of Service	- -
Data Line Security	a yes, <input type="checkbox"/> No
Automatic Callback-Trunk	<input type="checkbox"/> Yes, <input type="checkbox"/>
Parallel Connect	<input type="checkbox"/> <input type="checkbox"/> No

Key	Key Type	Number	SDN COS	Day Ring	Night Ring
DN-01	PDN		<input type="checkbox"/> Station, <input type="checkbox"/> DN		
DN-02			<input type="checkbox"/> Station, <input type="checkbox"/> DN		
DN-03			<input type="checkbox"/> Station, <input type="checkbox"/> DN		
DN-04			<input type="checkbox"/> Station, <input type="checkbox"/> DN		
DN-05			<input type="checkbox"/> Station, <input type="checkbox"/> DN		
DN-06			<input type="checkbox"/> Station, <input type="checkbox"/> DN		
DN-07			<input type="checkbox"/> Station, <input type="checkbox"/> DN		
DN-08			<input type="checkbox"/> Station, <input type="checkbox"/> DN		
DN-09			<input type="checkbox"/> Station, <input type="checkbox"/> DN		
DN-10			<input type="checkbox"/> Station, <input type="checkbox"/> DN		
DN-11			<input type="checkbox"/> Station, <input type="checkbox"/> DN		
DN-12			<input type="checkbox"/> Station, <input type="checkbox"/> DN		

PF Key	PF Key Type	Number	DSS Key	DSS Key Type	Number
01			01		
02			02		
03			03		
04			04		
05			05		
06			06		
07			07		
08			08		
09					
10					
11					
12					

EXTENSION-STATION

Station Equipment No.

Item	Set Data
Telephone Type and Model	Type _____ Model _____
OHCA Circuit	<input type="checkbox"/> Yes, <input type="checkbox"/> No
Primary Directory Number	- - - -
Intercom Number	- -
Station Name	_____
ICM Group	_____
Pickup Group	- - 0 None
Next Hunt Station	<input type="checkbox"/> EXT <input type="checkbox"/> N o n e
Class of Service	- -
Data Line Security	<input type="checkbox"/> <input type="checkbox"/>
Automatic Callback-Trunk	<input type="checkbox"/> Yes, <input type="checkbox"/> No
Parallel Connect	<input type="checkbox"/> <input type="checkbox"/>

Key	Key Type	Number	SDN COS	Day Ring	Night Ring
DN-01	PDN		<input type="checkbox"/> Station, <input type="checkbox"/> DN		
DN-02			<input type="checkbox"/> Station, <input type="checkbox"/> DN		
DN-03			<input type="checkbox"/> Station, <input type="checkbox"/> DN		
DN-04			<input type="checkbox"/> Station, <input type="checkbox"/> DN		
DN-05			<input type="checkbox"/> Station, <input type="checkbox"/> DN		
DN-06			<input type="checkbox"/> Station, <input type="checkbox"/> DN		
DN-07			<input type="checkbox"/> Station, <input type="checkbox"/> DN		
DN-08			<input type="checkbox"/> Station, <input type="checkbox"/> DN		
DN-09			<input type="checkbox"/> Station, <input type="checkbox"/> DN		
DN-10			<input type="checkbox"/> Station, <input type="checkbox"/> DN		
DN-11			<input type="checkbox"/> Station, <input type="checkbox"/> DN		
DN-12			<input type="checkbox"/> Station, <input type="checkbox"/> DN		

PF Key	PF Key Type	Number
01		
02		
03		
04		
05		
06		
07		
08		
09		
10		
11		
12		

DSS Key	DSS Key Type	Number
01		
02		
03		
04		
05		
06		
07		
08		

EXTENSION-STATION

Station Equipment No.

Item	Set Data
Telephone Type and Model	Type _____ Model _____
OHCA Circuit	<input type="checkbox"/> Yes, <input type="checkbox"/> No
Primary Directory Number	_____
Intercom Number	_____
Station Name	_____
ICM Group	_____
Pickup Group	_____ 0 None
Next Hunt Station	<input type="checkbox"/> <input type="checkbox"/> _____ <input type="checkbox"/> None
Class of Service	_____
Data Line Security	<input type="checkbox"/> Yes, <input type="checkbox"/> <input type="checkbox"/>
Automatic Callback-Trunk	<input type="checkbox"/> Yes, <input type="checkbox"/> <input type="checkbox"/>
Parallel Connect	<input type="checkbox"/> <input type="checkbox"/> <input type="checkbox"/> <input type="checkbox"/>

Key	Key Type	Number	SDN	COS	Day Ring	Night Ring
DN-01	PDN		<input type="checkbox"/> Station,	<input type="checkbox"/> DN		
DN-02			<input type="checkbox"/> Station,	<input type="checkbox"/> DN		
DN-03			<input type="checkbox"/> Station,	<input type="checkbox"/> DN		
DN-04			<input type="checkbox"/> Station,	<input type="checkbox"/> DN		
DN-05			<input type="checkbox"/> Station,	<input type="checkbox"/> DN		
DN-06			<input type="checkbox"/> Station,	<input type="checkbox"/> DN		
DN-07			<input type="checkbox"/> Station,	<input type="checkbox"/> DN		
DN-08			<input type="checkbox"/> Station,	<input type="checkbox"/> DN		
DN-09			<input type="checkbox"/> Station,	<input type="checkbox"/> DN		
DN-10			<input type="checkbox"/> Station,	<input type="checkbox"/> DN		
DN-11			<input type="checkbox"/> Station,	<input type="checkbox"/> DN		
DN-12			<input type="checkbox"/> Station,	<input type="checkbox"/> DN		

PF Key	PF Key Type	Number
01		
02		
03		
04		
05		
06		
07		
08		
09		
10		
11		
12		

DSS Key	DSS Key Type	Number
01		
02		
03		
04		
05		
06		
07		
08		

EXTENSION-STATION

Station Equipment No.

Item	Set Data
Telephone Type and Model	Type _____ Model _____
OHCA Circuit	<input type="checkbox"/> <input type="checkbox"/>
Primary Directory Number	_____
Intercom Number	_____
Station Name	_____
ICM Group	_____
Pickup Group	- - <input type="checkbox"/> None
Next Hunt Station	<input type="checkbox"/> _____ <input type="checkbox"/>
Class of Service	<input type="checkbox"/> <input type="checkbox"/>
Data Line Security	<input type="checkbox"/> Yes, <input type="checkbox"/>
Automatic Callback-Trunk	<input type="checkbox"/> Yes, <input type="checkbox"/>
Parallel Connect	<input type="checkbox"/> Yes, <input type="checkbox"/>

Key	Key Type	Number	SDN COS	Day Ring	Night Ring
DN-01	PDN		<input type="checkbox"/> Station, <input type="checkbox"/> DN		
DN-02			<input type="checkbox"/> Station, <input type="checkbox"/> DN		
DN-03			<input type="checkbox"/> Station, <input type="checkbox"/> DN		
DN-04			<input type="checkbox"/> Station, <input type="checkbox"/> DN		
DN-05			<input type="checkbox"/> Station, <input type="checkbox"/> DN		
DN-06			<input type="checkbox"/> Station, <input type="checkbox"/> DN		
DN-07			<input type="checkbox"/> Station, <input type="checkbox"/> DN		
DN-08			<input type="checkbox"/> Station, <input type="checkbox"/> DN		
DN-09			<input type="checkbox"/> Station, <input type="checkbox"/> DN		
DN-10			<input type="checkbox"/> Station, <input type="checkbox"/> DN		
DN-11			<input type="checkbox"/> Station, <input type="checkbox"/> DN		
DN-12			<input type="checkbox"/> Station, <input type="checkbox"/> DN		

PF Key	PF Key Type	Number
01		
02		
03		
04		
05		
06		
07		
08		
09		
10		
11		
12		

DSS Key	DSS Key Type	Number
01		
02		
03		
04		
05		
06		
07		
08		

EXTENSION-STATION

Station Equipment No.

Item	Set Data
Telephone Type and Model	Type _____ Model _____
OHCA Circuit	<input type="checkbox"/> Yes, <input type="checkbox"/> Yes <input type="checkbox"/>
Primary Directory Number	- - - - -
intercom Number	- -
Station Name	_____
ICM Group	_____
Pickup Group	- - <input type="checkbox"/> None
Next Hunt Station	<input type="checkbox"/> Yes <input type="checkbox"/> No _____ <input type="checkbox"/> None
Class of Service	- -
Data Line Security	<input type="checkbox"/> Yes, <input type="checkbox"/> Yes <input type="checkbox"/>
Automatic Callback-Trunk	<input type="checkbox"/> Yes, <input type="checkbox"/> Yes <input type="checkbox"/>
Parallel Connect	<input type="checkbox"/> Yes, <input type="checkbox"/> No

Key	Key Type	Number	SDN COS	Day Ring	Night Ring
DN-01	PDN		<input type="checkbox"/> Station, <input type="checkbox"/> DN		
DN-02			<input type="checkbox"/> Station, <input type="checkbox"/> DN		
DN-03			<input type="checkbox"/> Station, <input type="checkbox"/> DN		
DN-04			<input type="checkbox"/> Station, <input type="checkbox"/> DN		
DN-05			<input type="checkbox"/> Station, <input type="checkbox"/> DN		
DN-06			<input type="checkbox"/> Station, <input type="checkbox"/> DN		
DN-07			<input type="checkbox"/> Station, <input type="checkbox"/> DN		
DN-08			<input type="checkbox"/> Station, <input type="checkbox"/> DN		
DN-09			<input type="checkbox"/> Station, <input type="checkbox"/> DN		
DN-10			<input type="checkbox"/> Station, <input type="checkbox"/> DN		
DN-11			<input type="checkbox"/> Station, <input type="checkbox"/> DN		
DN-12			<input type="checkbox"/> Station, <input type="checkbox"/> DN		

PF Key	PF Key Type	Number	DSS Key	DSS Key Type	Number
01			01		
I 02 I			02		
I 03 I			03		
04			04		
05			05		
06			06		
I 07 I			07		
08			08		
09					
10					
11					
12					

EXTENSION-STATION

Station Equipment No.

Item	Set Data
Telephone Type and Model	Type _____ Model _____
OHCA Circuit	<input type="checkbox"/> Yes, <input type="checkbox"/> No
Primary Directory Number	- - - -
Intercom Number	- -
Station Name	_____
ICM Group	_____
Pickup Group	- - <input type="checkbox"/> None
Next Hunt Station	<input type="checkbox"/> <input type="checkbox"/> None
Class of Service	- -
Data Line Security	<input type="checkbox"/> <input type="checkbox"/>
Automatic Callback-Trunk	<input type="checkbox"/> Yes, <input type="checkbox"/> No
Parallel Connect	<input type="checkbox"/> <input type="checkbox"/>

Key	Key Type	Number	SDN COS	Day Ring	Night Ring
DN-01	PDN		<input type="checkbox"/> Station, <input type="checkbox"/> DN		
DN-02			<input type="checkbox"/> Station, <input type="checkbox"/> DN		
DN-03			<input type="checkbox"/> Station, <input type="checkbox"/> DN		
DN-04			<input type="checkbox"/> Station, <input type="checkbox"/> DN		
DN-05			<input type="checkbox"/> Station, <input type="checkbox"/> DN		
DN-06			<input type="checkbox"/> Station, <input type="checkbox"/> DN		
DN-07			<input type="checkbox"/> Station, <input type="checkbox"/> DN		
DN-08			<input type="checkbox"/> Station, <input type="checkbox"/> DN		
DN-09			<input type="checkbox"/> Station, <input type="checkbox"/> DN		
DN-10			<input type="checkbox"/> Station, <input type="checkbox"/> DN		
DN-11			<input type="checkbox"/> Station, <input type="checkbox"/> DN		
DN-12			<input type="checkbox"/> Station, <input type="checkbox"/> DN		

PF Key	PF Key Type	Number
01		
02		
03		
04		
05		
06		
07		
08		
09		
10		
11		
12		

DSS Key	DSS Key Type	Number
01		
02		
03		
04		
05		
06		
07		
08		

EXTENSION-STATION

Station Equipment No.

Item	Set Data
Telephone Type and Model	Type _____ Model _____
OHCA Circuit	<input type="checkbox"/> Yes, <input type="checkbox"/> No
Primary Directory Number	- - - -
Intercom Number	- -
Station Name	_____
ICM Group	_____
Pickup Group	- - <input type="checkbox"/> None
Next Hunt Station	<input type="checkbox"/> <input type="checkbox"/> None
Class of Service	- -
Data Line Security	<input type="checkbox"/> Yes, <input type="checkbox"/> <input type="checkbox"/>
Automatic Callback-Trunk	<input type="checkbox"/> Yes, <input type="checkbox"/> No
Parallel Connect	<input type="checkbox"/> Yes, <input type="checkbox"/> No

Key	Key Type	Number	SDNCOS	Day Ring	Night Ring
DN-01	PDN		<input type="checkbox"/> Station, <input type="checkbox"/> DN		
DN-02			<input type="checkbox"/> Station, <input type="checkbox"/> DN		
ON-03			<input type="checkbox"/> Station, <input type="checkbox"/> DN		
DN-04			<input type="checkbox"/> Station, <input type="checkbox"/> DN		
DN-05			<input type="checkbox"/> Station, <input type="checkbox"/> DN		
DN-06			<input type="checkbox"/> Station, <input type="checkbox"/> DN		
DN-07			<input type="checkbox"/> Station, <input type="checkbox"/> DN		
DN-08			<input type="checkbox"/> Station, <input type="checkbox"/> DN		
DN-09			<input type="checkbox"/> Station, <input type="checkbox"/> DN		
DN-10			<input type="checkbox"/> Station, <input type="checkbox"/> DN		
DN-11			<input type="checkbox"/> Station, nDN		
ON-12			<input type="checkbox"/> Station, nDN		

PF Key	PF Key Type	Number	DSS Key	DSS Key Type	Number
01			01		
02			02		
03			03		
04			04		
05			05		
06			06		
07			07		
08			08		
09	9				
10					
11					
12					

EXTENSION-STATION

Station Equipment No.

Item	Set Data
Telephone Type and Model	Type _____ Model _____
OHCA Circuit	<input type="checkbox"/> Yes, <input type="checkbox"/> No
Primary Directory Number	_____
Intercom Number	- - -
Station Name	- - - A - L - - - -
CM Group	_____
Pickup Group	- - <input type="checkbox"/> None
Next Hunt Station	<input type="checkbox"/> EXT _____ <input type="checkbox"/> None
Class of Service	- -
Data Line Security	<input type="checkbox"/> Yes, <input type="checkbox"/> No
Automatic Callback-Trunk	<input type="checkbox"/> Yes, <input type="checkbox"/> No
Parallel Connect	<input type="checkbox"/> Yes, <input type="checkbox"/> No

Key	Key Type	Number	SDN COS	Day Ring	Night Ring
DN-01	PDN		<input type="checkbox"/> Station, <input type="checkbox"/> DN		
DN-02			<input type="checkbox"/> Station, <input type="checkbox"/> DN		
DN-03			<input type="checkbox"/> Station, <input type="checkbox"/> DN		
DN-04			<input type="checkbox"/> Station, <input type="checkbox"/> DN		
DN-05			<input type="checkbox"/> Station, <input type="checkbox"/> DN		
DN-06			<input type="checkbox"/> Station, <input type="checkbox"/> DN		
DN-07			<input type="checkbox"/> Station, <input type="checkbox"/> DN		
DN-08			<input type="checkbox"/> Station, <input type="checkbox"/> DN		
DN-09			<input type="checkbox"/> Station, <input type="checkbox"/> DN		
DN-10			<input type="checkbox"/> Station, <input type="checkbox"/> DN		
DN-11			<input type="checkbox"/> Station, <input type="checkbox"/> DN		
DN-12			<input type="checkbox"/> Station, <input type="checkbox"/> DN		

PF Key	PF Key Type	Number	DSS Key	DSS Key Type	Number
01			01		
02			02		
03			03		
04			04		
05			05		
06			06		
07			07		
08			08		
09					
10					
11					
12					

EXTENSION-STATION

Station Equipment No.

Item	Set Data
Telephone Type and Model	Type _____ Model _____
OHCA Circuit	<input type="checkbox"/> Yes <input type="checkbox"/> No <input type="checkbox"/>
Primary Directory Number	- - - -
Intercom Number	- -
Station Name	_____
ICM Group	_____
Pickup Group	- - <input type="checkbox"/> None
Next Hunt Station	<input type="checkbox"/> EXT <input type="checkbox"/> None _____
Class of Service	- -
Data Line Security	<input type="checkbox"/> Yes, <input type="checkbox"/> No
Automatic Callback-Trunk	<input type="checkbox"/> Yes, <input type="checkbox"/> No
Parallel Connect	<input type="checkbox"/> <input type="checkbox"/> No

Key	Key Type	Number	SDN COS	Day Ring	Night Ring
DN-01	PDN		<input type="checkbox"/> Station, <input type="checkbox"/> DN		
DN-02			<input type="checkbox"/> Station, <input type="checkbox"/> DN		
DN-03			<input type="checkbox"/> Station, <input type="checkbox"/> DN		
DN-04			<input type="checkbox"/> Station, <input type="checkbox"/> DN		
DN-05			<input type="checkbox"/> Station, <input type="checkbox"/> DN		
DN-06			<input type="checkbox"/> Station, <input type="checkbox"/> DN		
DN-07			<input type="checkbox"/> Station, <input type="checkbox"/> DN		
DN-08			<input type="checkbox"/> Station, <input type="checkbox"/> DN		
DN-09			<input type="checkbox"/> Station, <input type="checkbox"/> DN		
DN-10			<input type="checkbox"/> Station, <input type="checkbox"/> DN		
DN-11			<input type="checkbox"/> Station, <input type="checkbox"/> DN		
DN-12			<input type="checkbox"/> Station, <input type="checkbox"/> DN		

PF Key	PF Key Type	Number	DSS Key	DSS Key Type	Number
01			01		
02			02		
03			03		
04			04		
05			05		
06			06		
07			07		
08			08		
09					
10					
11					
12					

EXTENSION-STATION

Station Equipment No.

Item	Set Data
Telephone Type and Model	Type _____ Model _____
OHCA Circuit	<input type="checkbox"/> Yes, <input type="checkbox"/> No
Primary Directory Number	- - - -
Intercom Number	- -
Station Name	_____
ICM Group	_____
Pickup Group	- - C None
Next Hunt Station	<input type="checkbox"/> <input type="checkbox"/> None
Class of Service	- -
Data Line Security	<input type="checkbox"/> Yes, <input type="checkbox"/> No
Automatic Callback-Trunk	<input type="checkbox"/> Yes, <input type="checkbox"/> No
Parallel Connect	<input type="checkbox"/> Yes, <input type="checkbox"/> No

Key	Key Type	Number	SDN COS	Day Ring	Night Ring
DN-01	PDN		<input type="checkbox"/> Station, <input type="checkbox"/> DN		
DN-02			<input type="checkbox"/> Station, <input type="checkbox"/> DN		
DN-03			<input type="checkbox"/> Station, <input type="checkbox"/> DN		
DN-04			<input type="checkbox"/> Station, <input type="checkbox"/> DN		
DN-05			<input type="checkbox"/> Station, <input type="checkbox"/> DN		
DN-06			<input type="checkbox"/> Station, <input type="checkbox"/> DN		
DN-07			<input type="checkbox"/> Station, <input type="checkbox"/> DN		
DN-08			<input type="checkbox"/> Station, <input type="checkbox"/> DN		
DN-09			<input type="checkbox"/> Station, <input type="checkbox"/> DN		
DN-10			<input type="checkbox"/> Station, <input type="checkbox"/> DN		
DN-11			<input type="checkbox"/> Station, <input type="checkbox"/> DN		
DN-12			<input type="checkbox"/> Station, <input type="checkbox"/> DN		

PF Key	PF Key Type	Number
01		
02		
03		
04		
05		
06		
07		
08		
09		
10		
11		
12		

DSS Key	DSS Key Type	Number
01		
02		
03		
04		
05		
06		
07		
08		

EXTENSION-STATION

Station Equipment No.

item	Set Data
Telephone Type and Model	Type _____ Model _____
OHCA Circuit	<input type="checkbox"/> Yes, <input type="checkbox"/> <input type="checkbox"/>
Primary Directory Number	_____
Intercom Number	---
Station Name	-----
ICM Group	_____ <input type="checkbox"/> None
Pickup Group	<input type="checkbox"/> EXT _____ <input type="checkbox"/> NDne
Next Hunt Station	_____
Class of Service	_____ <input type="checkbox"/> <input type="checkbox"/>
Data Line Security	<input type="checkbox"/> Yes, <input type="checkbox"/> <input type="checkbox"/>
Automatic Callback-Trunk	<input type="checkbox"/> Yes, <input type="checkbox"/> <input type="checkbox"/>
Parallel Connect	<input type="checkbox"/> Yes, <input type="checkbox"/> <input type="checkbox"/>

Key	Key Type	Number	SDNCOS	Day Ring	Night Ring
DN-01	PDN		<input type="checkbox"/> Station, <input type="checkbox"/> DN		
DN-02			<input type="checkbox"/> Station, <input type="checkbox"/> DN		
DN-03			<input type="checkbox"/> Station, <input type="checkbox"/> DN		
DN-04			<input type="checkbox"/> Station, <input type="checkbox"/> DN		
DN-05			<input type="checkbox"/> Station, <input type="checkbox"/> DN		
DN-06			<input type="checkbox"/> Station, <input type="checkbox"/> DN		
DN-07			<input type="checkbox"/> Station, <input type="checkbox"/> DN		
DN-08			<input type="checkbox"/> Station, <input type="checkbox"/> DN		
DN-09			<input type="checkbox"/> Station, <input type="checkbox"/> DN		
DN-10			<input type="checkbox"/> Station, <input type="checkbox"/> DN		
DN-11			<input type="checkbox"/> Station, <input type="checkbox"/> DN		
DN-12			<input type="checkbox"/> Station, <input type="checkbox"/> DN		

PF Key	PF Key Type	Number
01		
02		
03		
04		
05		
06		
07		
08		
09		
10		
11		
12		

DSS Key	DSS Key Type	Number
01		
02		
03		
04		
05		
06		
07		
08		

EXTENSION-STATION

Station Equipment No.

Item	Set Data
Telephone Type and Model	Type _____ Model _____
OHCA Circuit	<input type="checkbox"/> Yes <input type="checkbox"/> No <input type="checkbox"/>
Primary Directory Number	<input type="checkbox"/> <input type="checkbox"/> <input type="checkbox"/> <input type="checkbox"/>
intercom Number	_____
Station Name	_____
ICM Group	_____
Pickup Group	_____ <input type="checkbox"/> None
Next Hur: Station	<input type="checkbox"/> EXT _____ <input type="checkbox"/> None
Class of Service	_____
Data Line Security	@Yes, <input type="checkbox"/> No <input type="checkbox"/>
Automat;; Callback-Trunk	<input type="checkbox"/> Yes, <input type="checkbox"/> No <input type="checkbox"/>
Parallel Connect	<input type="checkbox"/> Yes, <input type="checkbox"/> No <input type="checkbox"/>

Key	Key Type	Number	SDN COS	Day Ring	Night Ring
DN-01	PDN		<input type="checkbox"/> Station, <input type="checkbox"/> DN		
DN-02			<input type="checkbox"/> Station, <input type="checkbox"/> DN		
DN-03			<input type="checkbox"/> Station, <input type="checkbox"/> DN		
DN-04			<input type="checkbox"/> Station, <input type="checkbox"/> DN		
DN-05			<input type="checkbox"/> Station, <input type="checkbox"/> DN		
DN-06			<input type="checkbox"/> Station, <input type="checkbox"/> DN		
DN-07			<input type="checkbox"/> Station, <input type="checkbox"/> DN		
DN-08			<input type="checkbox"/> Station, <input type="checkbox"/> DN		
DN-09			<input type="checkbox"/> Station, <input type="checkbox"/> DN		
DN-10			<input type="checkbox"/> Station, <input type="checkbox"/> DN		
DN-11			<input type="checkbox"/> Station, <input type="checkbox"/> DN		
DN-12			<input type="checkbox"/> Station, <input type="checkbox"/> DN		

PF Key	PF Key Type	Number	DSS Key	DSS Key Type	Number
01			01		
02			02		
03			03		
04			04		
05			05		
06			06		
07			07		
08			08		
09					
10					
11					
12					

EXTENSION-STATION

Station Equipment No.

Item	Set Data
Telephone Type and Model	Type _____ Model _____
OHCA Circuit	<input type="checkbox"/> <input type="checkbox"/>
Primary Directory Number	_____
Intercom Number	- -
Station Name	_____
ICM Group	_____
Pickup Group	- - <input type="checkbox"/> None
Next Hunt Station	<input type="checkbox"/> _____ <input type="checkbox"/> None
Class of Service	- -
Data Line Security	<input type="checkbox"/> <input type="checkbox"/>
Automatic Callback-Trunk	<input type="checkbox"/> Yes, <input type="checkbox"/> NO
Parallel Connect	<input type="checkbox"/> <input type="checkbox"/>

Key	Key Type	Number	SDN COS	Day Ring	Night Ring
DN-01	PDN		<input type="checkbox"/> Station, <input type="checkbox"/> DN		
DN-02			<input type="checkbox"/> Station, <input type="checkbox"/> DN		
DN-03			<input type="checkbox"/> Station, <input type="checkbox"/> DN		
DN-04			<input type="checkbox"/> Station, <input type="checkbox"/> DN		
DN-05			<input type="checkbox"/> Station, <input type="checkbox"/> DN		
DN-06			<input type="checkbox"/> Station, <input type="checkbox"/> DN		
DN-07			<input type="checkbox"/> Station, <input type="checkbox"/> DN		
DN-08			<input type="checkbox"/> Station, <input type="checkbox"/> DN		
DN-09			<input type="checkbox"/> Station, <input type="checkbox"/> DN		
DN-10			<input type="checkbox"/> Station, <input type="checkbox"/> DN		
DN-11			<input type="checkbox"/> Station, <input type="checkbox"/> DN		
DN-12			<input type="checkbox"/> Station, <input type="checkbox"/> DN		

PF Key	PF Key Type	Number	DSS Key	DSS Key Type	Number
01			01		
02			02		
03			03		
04			04		
05			05		
06			06		
07			07		
08			08		
09					
10					
11					
12					

EXTENSION-STATION

Station Equipment No.

Item	Set Data
Telephone Type and Model	Type _____ Model _____
OHCA Circuit	<input type="checkbox"/> Yes, <input type="checkbox"/> No
Primary Directory Number	- - - - -
Intercom Number	- -
Station Name	- - - - -
ICM Group	—
Pickup Group	- - <input type="checkbox"/> None
Next Hunt Station	<input type="checkbox"/> IEXT _____ <input type="checkbox"/> None
Class of Service	- -
Data Line Security	<input type="checkbox"/> Yes, <input type="checkbox"/> No
Automatic Callback-Trunk	<input type="checkbox"/> Yes, <input type="checkbox"/> No
Parallel Connect	<input type="checkbox"/> Yes, <input type="checkbox"/> No

Key	Key Type	Number	SDN COS	Day Ring	Night Ring
DN-01	PDN		<input type="checkbox"/> Station, CDN		
DN-02			<input type="checkbox"/> Station, EDN		
DN-03			<input type="checkbox"/> Station, <input type="checkbox"/> DN		
DN-04			<input type="checkbox"/> Station, CDN		
DN-05			<input type="checkbox"/> Station, <input type="checkbox"/> DN		
DN-06			<input type="checkbox"/> Station, <input type="checkbox"/> DN		
DN - 07			<input type="checkbox"/> Station, <input type="checkbox"/> DN		
DN-08			<input type="checkbox"/> Station, CDN		
DN-09			<input type="checkbox"/> Station, <input type="checkbox"/> DN		
DN-10			<input type="checkbox"/> Station, <input type="checkbox"/> DN		
DN-11			<input type="checkbox"/> Station, <input type="checkbox"/> DN		
DN-12			<input type="checkbox"/> Station, <input type="checkbox"/> DN		

PF Key	PF Key Type	Number	DSS Key	DSS Key Type	Number
01			01		
02			02		
03			03		
04			04		
05			05		
06			06		
07			07		
08			08		
09					
10					
11					
12					

EXTENSION-STATION

Station Equipment No.

Item	Set Data
Telephone Type and Model	Type _____ Model _____
OHCA Circuit	<input type="checkbox"/> <input type="checkbox"/> <input type="checkbox"/> <input type="checkbox"/> <input type="checkbox"/> No
Primary Directory Number	- - - - -
Intercom Number	- -
Station Name	_____
ICM Group	_____
Pickup Group	- - <input type="checkbox"/> None
Next Hunt Station	<input type="checkbox"/> <input type="checkbox"/> <input type="checkbox"/> <input type="checkbox"/> <input type="checkbox"/> 0 None
Class of Service	- -
Data Line Security	<input type="checkbox"/> <input type="checkbox"/> <input type="checkbox"/> <input type="checkbox"/> No
Automatic Callback-Trunk	<input type="checkbox"/> Yes, <input type="checkbox"/> No
Parallel Connect	<input type="checkbox"/> <input type="checkbox"/> <input type="checkbox"/> <input type="checkbox"/>

Key	Key Type	Number	SDN COS	Day Ring	Night Ring
DN-01	PDN		<input type="checkbox"/> Station, <input type="checkbox"/> DN		
DN-02			<input type="checkbox"/> station, <input type="checkbox"/> DN		
DN-03			<input type="checkbox"/> Station, <input type="checkbox"/> DN		
DN-04			<input type="checkbox"/> Station, <input type="checkbox"/> DN		
DN-05			<input type="checkbox"/> Station, <input type="checkbox"/> DN		
DN-06			<input type="checkbox"/> Station, <input type="checkbox"/> DN		
DN-07			<input type="checkbox"/> Station, <input type="checkbox"/> DN		
DN-08			<input type="checkbox"/> Station, <input type="checkbox"/> DN		
DN-09			<input type="checkbox"/> Station, <input type="checkbox"/> DN		
DN-10			<input type="checkbox"/> Station, <input type="checkbox"/> DN		
DN-11			<input type="checkbox"/> Station, <input type="checkbox"/> DN		
DN-12			<input type="checkbox"/> Station, <input type="checkbox"/> DN		

PF Key	PF Key Type	Number
01		
02		
03		
04		
05		
06		
07		
08		
09		
10		
11		
12		

DSS Key	DSS Key Type	Number
01		
02		
03		
04		
05		
06		
07		
08		

EXTENSION-STATION

Station Equipment No.

Item	Set Data
Telephone Type and Model	Type _____ Model _____
OHCA Circuit	<input type="checkbox"/> Yes. <input type="checkbox"/> <input type="checkbox"/> <input type="checkbox"/>
Primary Directory Number	- - - - -
Intercom Number	- -
Station Name	_____
ICM Group	_____
Pickup Group	- - <input type="checkbox"/> None
Next Hunt Station	<input type="checkbox"/> <input type="checkbox"/> <input type="checkbox"/> <input type="checkbox"/> _____ <input type="checkbox"/> None
Class of Service	- -
Data Line Security	<input type="checkbox"/> <input type="checkbox"/> <input type="checkbox"/> <input type="checkbox"/> <input type="checkbox"/> No
Automatic Callback-Trunk	<input type="checkbox"/> Yes. <input type="checkbox"/> No
Parallel Connect	<input type="checkbox"/> Yes. <input type="checkbox"/> No

Key	Key Type	Number	SDN COS	Day Ring	Night Ring
DN-01	PDN		<input type="checkbox"/> Station, <input type="checkbox"/> DN		
DN-02			<input type="checkbox"/> Station, <input type="checkbox"/> DN		
DN-03			<input type="checkbox"/> Station, <input type="checkbox"/> DN		
DN-04			<input type="checkbox"/> Station, <input type="checkbox"/> DN		
DN-05			<input type="checkbox"/> Station, <input type="checkbox"/> DN		
DN-06			<input type="checkbox"/> Station, <input type="checkbox"/> DN		
DN-07			<input type="checkbox"/> Station, <input type="checkbox"/> DN		
DN-08			<input type="checkbox"/> Station, <input type="checkbox"/> DN		
DN-09			<input type="checkbox"/> Station, <input type="checkbox"/> DN		
DN-10			<input type="checkbox"/> Station, <input type="checkbox"/> DN		
DN-11			<input type="checkbox"/> Station, <input type="checkbox"/> DN		
DN-12			<input type="checkbox"/> Station, <input type="checkbox"/> DN		

PF Key	PF Key Type	Number
01		
02		
03		
04		
05		
06		
07		
08		
09		
10		
11		
12		

DSS Key	DSS Key Type	Number
01		
02		
03		
04		
05		
06		
07		
08		

EXTENSION-STATION

Station Equipment No.

Item	Set Data
Telephone Type and Model	Type _____ Mode _____
OHCA Circuit	<input type="checkbox"/> Yes <input type="checkbox"/> <input type="checkbox"/> <input type="checkbox"/>
Primary Directory Number	- - - - -
Intercom Number	- -
Station Name	- - - - -
ICM Group	_____
Pickup Group	- - <input type="checkbox"/> None
Next Hunt Station	<input type="checkbox"/> EXT - - - - <input type="checkbox"/> None
Class of Service	- -
Data Line Security	<input type="checkbox"/> Yes. <input type="checkbox"/> <input type="checkbox"/> <input type="checkbox"/>
Automatic Callback-Trunk	<input type="checkbox"/> Yes. <input type="checkbox"/> <input type="checkbox"/> <input type="checkbox"/>
Parallel Connect	<input type="checkbox"/> Yes. <input type="checkbox"/> <input type="checkbox"/> <input type="checkbox"/>

Key	Key Type	Number	SDN COS	Day Ring	Night Ring
DN-01	PDN		<input type="checkbox"/> Station, <input type="checkbox"/> DN		
DN-02			<input type="checkbox"/> Station, <input type="checkbox"/> DN		
DN-03			<input type="checkbox"/> Station, <input type="checkbox"/> DN		
DN-04			<input type="checkbox"/> Station, <input type="checkbox"/> DN		
DN-05			<input type="checkbox"/> Station, <input type="checkbox"/> DN		
DN-06			<input type="checkbox"/> Station, <input type="checkbox"/> DN		
DN-07			<input type="checkbox"/> Station, <input type="checkbox"/> DN		
DN-08			<input type="checkbox"/> Station, <input type="checkbox"/> DN		
DN-09			<input type="checkbox"/> Station, <input type="checkbox"/> DN		
DN-10			<input type="checkbox"/> Station, <input type="checkbox"/> DN		
DN-11			<input type="checkbox"/> Station, <input type="checkbox"/> DN		
DN-12			<input type="checkbox"/> Station, <input type="checkbox"/> DN		

PF Key	PF Key Type	Number
01		
02		
03		
04		
05		
06		
07		
08		
09		
10		
11		
12		

DSS Key	DSS Key Type	Number
01		
02		
03		
04		
05		
06		
07		
08		

EXTENSION-STATION

Station Equipment No.

Item	Set Data
Telephone Type and Model	Type _____ Model _____
OHCA Circuit	<input type="checkbox"/> Yes, <input type="checkbox"/> <input type="checkbox"/>
Primary Directory Number	- - - -
Intercom Number	- -
Station Name	-----
ICM Group	---
Pickup Group	- - 0 None
Next Hunt Station	<input type="checkbox"/> <input type="checkbox"/> None
Class of Service	- -
Data Line Security	<input type="checkbox"/> Yes, <input type="checkbox"/> <input type="checkbox"/>
Automatic Callback-Trunk	<input type="checkbox"/> Yes, <input type="checkbox"/> No
Parallel Connect	<input type="checkbox"/> Yes, <input type="checkbox"/> <input type="checkbox"/>

Key	Key Type	Number	SDN COS	Day Ring	Night Ring
DN-01	PDN		<input type="checkbox"/> Station, ODN		
DN-02			<input type="checkbox"/> Station, <input type="checkbox"/> DN		
DN-03			<input type="checkbox"/> Station, <input type="checkbox"/> DN		
DN-04			<input type="checkbox"/> Station, <input type="checkbox"/> DN		
DN-05			<input type="checkbox"/> Station, ODN		
-DN-06			<input type="checkbox"/> Station, j-JDN		
DN-07			<input type="checkbox"/> Station, <input type="checkbox"/> DN		
DN-08			<input type="checkbox"/> Station, <input type="checkbox"/> DN		
DN-09			<input type="checkbox"/> Station, ODN		
DN-10			<input type="checkbox"/> Station, <input type="checkbox"/> DN		
DN-11			<input type="checkbox"/> Station, <input type="checkbox"/> DN		
DN-12			<input type="checkbox"/> Station, <input type="checkbox"/> DN		

PF Key	PF Key Type	Number	DSS Key	DSS Key Type	Number
01			01		
02			02		
03			03		
04			04		
05			05		
06			06		
07			07		
08			08		
09					
10					
11					
12					

EXTENSION-STATION

Station Equipment No.

Item	Set Data
Telephone Type and Model	Type _____ Model _____
OHCA Circuit	<input type="checkbox"/> Yes, <input type="checkbox"/> No
Primary Directory Number	- - - -
Intercom Number	- -
Station Name	_____
ICM Group	_____
Pickup Group	- - <input type="checkbox"/> None
Next Hunt Station	<input type="checkbox"/> _____ <input type="checkbox"/> None
Class of Service	- -
Data Line Security	<input type="checkbox"/> <input type="checkbox"/> No
Automatic Callback-Trunk	<input type="checkbox"/> Yes, <input type="checkbox"/> No
Parallel Connect	<input type="checkbox"/> Yes, <input type="checkbox"/> No

Key	Key Type	Number	SDN COS	Day Ring	Night Ring
DN-01	PDN		<input type="checkbox"/> Station, <input type="checkbox"/> DN		
DN-02			<input type="checkbox"/> Station, <input type="checkbox"/> DN		
DN-03			<input type="checkbox"/> Station, ODN		
DN-04			<input type="checkbox"/> Station, <input type="checkbox"/> DN		
DN-05			<input type="checkbox"/> Station, <input type="checkbox"/> DN		
DN-06			<input type="checkbox"/> Station, ODN		
DN-07			<input type="checkbox"/> Station, <input type="checkbox"/> DN		
DN-08			<input type="checkbox"/> Station, <input type="checkbox"/> DN		
DN-09			<input type="checkbox"/> Station, <input type="checkbox"/> DN		
DN-10			<input type="checkbox"/> Station, nDN		
DN-11			<input type="checkbox"/> Station, <input type="checkbox"/> DN		
DN-12			<input type="checkbox"/> Station, ODN		

PF Key	PF Key Type	Number	DSS Key	DSS Key Type	Number
01			01		
02			02		
03			03		
04			04		
05			05		
06			06		
07			07		
08			08		
09					
10					
11					
12					

EXTENSION-STATION

Station Equipment No.

Item	Set Data
Telephone Type and Model	Type _____ Model _____
OHCA Circuit	<input type="checkbox"/> Yes, <input type="checkbox"/> No
Primary Directory Number	- - - - -
Intercom Number	- -
Station Name	_____
ICM Group	_____
Pickup Group	- - 0 None
Next Hunt Station	<input type="checkbox"/> _____ <input type="checkbox"/> None
Class of Service	- -
Data Line Security	<input type="checkbox"/> <input type="checkbox"/>
Automatic Callback-Trunk	<input type="checkbox"/> Yes. <input type="checkbox"/> No
Parallel Connect	<input type="checkbox"/> <input type="checkbox"/> No

Key	Key Type	Number	SDN COS	Day Ring	Night Ring
DN-01	PDN		<input type="checkbox"/> Station, <input type="checkbox"/> DN		
DN-02			<input type="checkbox"/> Station, <input type="checkbox"/> DN		
DN-03			<input type="checkbox"/> Station, <input type="checkbox"/> DN		
DN-04			<input type="checkbox"/> Station, <input type="checkbox"/> DN		
DN-05			<input type="checkbox"/> Station, <input type="checkbox"/> DN		
DN-06			<input type="checkbox"/> Station, <input type="checkbox"/> DN		
DN-07			<input type="checkbox"/> Station, <input type="checkbox"/> DN		
DN-08			<input type="checkbox"/> Station, <input type="checkbox"/> DN		
DN-09			<input type="checkbox"/> Station, ODN		
DN-10			<input type="checkbox"/> Station, nDN		
DN-11			<input type="checkbox"/> Station, <input type="checkbox"/> DN		
DN-12			<input type="checkbox"/> Station, ODN		

PF Key	PF Key Type	Number	DSS Key	DSS Key Type	Number
01			01		
02			02		
03			03		
04			04		
05			05		
06			06		
07			07		
08			08		
09					
10					
11					
12					

EXTENSION-STATION

Station Equipment No.

Item	Set Data
Telephone Type and Model	Type _____ Model _____
OHCA Circuit	<input type="checkbox"/> <input type="checkbox"/>
Primary Directory Number	- - - -
Intercom Number	- -
Station Name	_____
ICM Group	_____
Pickup Group	- - <input type="checkbox"/> None
Next Hunt Station	<input type="checkbox"/> _____ <input type="checkbox"/> None
Class of Service	- -
Data Line Security	<input type="checkbox"/> Yes, <input type="checkbox"/> No
Automatic Callback-Trunk	<input type="checkbox"/> Yes, <input type="checkbox"/> No
Parallel Connect	<input type="checkbox"/> <input type="checkbox"/>

Key	Key Type	Number	SDN COS	Day Ring	Night Ring
DN-01	PDN		<input type="checkbox"/> Station, <input type="checkbox"/> DN		
DN-02			<input type="checkbox"/> Station, <input type="checkbox"/> DN		
DN-03			<input type="checkbox"/> Station, <input type="checkbox"/> DN		
DN-04			<input type="checkbox"/> Station, <input type="checkbox"/> DN		
DN-05			<input type="checkbox"/> Station, <input type="checkbox"/> DN		
DN-06			<input type="checkbox"/> Station, <input type="checkbox"/> DN		
DN-07			<input type="checkbox"/> Station, <input type="checkbox"/> DN		
DN-08			<input type="checkbox"/> Station, <input type="checkbox"/> DN		
DN-09			<input type="checkbox"/> Station, ODN		
DN-10			<input type="checkbox"/> Station, ODN		
DN-11			<input type="checkbox"/> Station, <input type="checkbox"/> DN		
DN-12			<input type="checkbox"/> Station, nDN		

PF Key	PF Key Type	Number
01		
02		
03		
04		
05		
06		
07		
08		
09		
10		
11		
12		

DSS Key	DSS Key Type	Number
01		
02		
03		
04		
05		
06		
07		
08		

EXTENSION-STATION

Station Equipment No.

Item	Set Data
Telephone Type and Model	Type _____ Model _____
OHCA Circuit	<input type="checkbox"/> Yes, <input type="checkbox"/> X <input type="checkbox"/>
Primary Directory Number	- - - - -
Intercom Number	- -
Station Name	_____
ICM Group	_____
Pickup Group	- - - - - 0 None
Next Hunt Station	<input type="checkbox"/> X <input type="checkbox"/> _____ <input type="checkbox"/> None
Class of Service	- -
Data Line Security	<input type="checkbox"/> Yes, <input type="checkbox"/> No
Automatic Callback-Trunk	<input type="checkbox"/> Yes, <input type="checkbox"/> No
Parallel Connect	<input type="checkbox"/> Yes, <input type="checkbox"/> X <input type="checkbox"/>

Key	Key Type	Number	SDN	COS	Day Ring	Night Ring
DN-01	PDN		<input type="checkbox"/> Station,	<input type="checkbox"/> DN		
DN-02			<input type="checkbox"/> Station,	<input type="checkbox"/> DN		
DN-03			<input checked="" type="checkbox"/> Station,	<input type="checkbox"/> DN		
DN-04			<input type="checkbox"/> Station,	<input type="checkbox"/> DN		
DN-06			<input type="checkbox"/> Station,	CDN		
DN-06			<input checked="" type="checkbox"/> Station,	<input type="checkbox"/> DN		
DN-07			<input type="checkbox"/> Station,	<input type="checkbox"/> DN		
DN-08			<input checked="" type="checkbox"/> Station,	LDN		
DN-09			<input checked="" type="checkbox"/> Station,	CDN		
DN-10			<input checked="" type="checkbox"/> Station,	CjDN		
DN-11			<input checked="" type="checkbox"/> Station,	<input type="checkbox"/> DN		
DN-12			<input type="checkbox"/> Station,	<input type="checkbox"/> DN		

PF Key	PF Key Type	Number	DSS Key	DSS Key Type	Number
01			01		
02			02		
03			03		
04			04		
05			05		
06			06		
07			07		
08			08		
09					
10					
11					
12					

EXTENSION-STATION

Station Equipment No.

Item	Set Data
Telephone Type and Model	Type _____ Model _____
OHCA Circuit	<input type="checkbox"/> Yes, <input type="checkbox"/> No
Primary Directory Number	_____
Intercom Number	_____
Station Name	_____
ICM Group	_____
Pickup Group	_____ <input type="checkbox"/> None
Next Hunt Station	<input type="checkbox"/> EXT _____ <input type="checkbox"/> None
Class of Service	_____
Data Line Security	<input type="checkbox"/> <input type="checkbox"/> <input type="checkbox"/> <input type="checkbox"/> <input type="checkbox"/> <input type="checkbox"/>
Automatic Callback-Trunk	<input type="checkbox"/> Yes, <input type="checkbox"/> No
Parallel Connect	<input type="checkbox"/> Yes, <input type="checkbox"/> No

Key	Key Type	Number	SDN COS	Day Ring	Night Ring
DN-01	PDN		<input type="checkbox"/> Station, <input type="checkbox"/> DN		
DN-02			<input type="checkbox"/> Station, <input type="checkbox"/> DN		
DN-03			<input type="checkbox"/> Station, <input type="checkbox"/> DN		
DN-04			<input type="checkbox"/> Station, <input type="checkbox"/> DN		
DN-05			<input type="checkbox"/> Station, <input type="checkbox"/> DN		
DN-06			<input type="checkbox"/> Station, <input type="checkbox"/> DN		
DN-07			<input type="checkbox"/> Station, <input type="checkbox"/> DN		
DN-08			<input type="checkbox"/> Station, <input type="checkbox"/> DN		
DN-09			<input type="checkbox"/> Station, <input type="checkbox"/> DN		
DN-10			<input type="checkbox"/> Station, <input type="checkbox"/> DN		
DN-11			<input type="checkbox"/> Station, <input type="checkbox"/> DN		
DN-12			<input type="checkbox"/> Station, <input type="checkbox"/> DN		

PF Key	PF Key Type	Number	DSS Key	DSS Key Type	Number
01			01		
02			02		
03			03		
04			04		
05			05		
06			06		
07			07		
08			08		
09					
10					
11					
12					

EXTENSION-STATION

Station Equipment No.

item	Set Data
Telephone Type and Model	Type _____ Model _____
OHCA Circuit	<input type="checkbox"/> <input type="checkbox"/> No
Primary Directory Number	<input type="checkbox"/> <input type="checkbox"/> <input type="checkbox"/> <input type="checkbox"/>
Intercom Number	____
Station Name	_____
ICM Group	____
Pickup Group	____ <input type="checkbox"/> None
Next Hunt Station	<input type="checkbox"/> <input type="checkbox"/> None
Class of Service	<input type="checkbox"/> <input type="checkbox"/>
Data Line Security	<input type="checkbox"/> <input type="checkbox"/> No
Automatic Callback-Trunk	<input type="checkbox"/> Yes, <input type="checkbox"/> No
Parallel Connect	<input type="checkbox"/> <input type="checkbox"/> No

Key	Key Type	Number	SDN COS	Day Ring	Night Ring
DN-01	PDN		<input type="checkbox"/> Station, <input type="checkbox"/> DN		
DN-02			<input type="checkbox"/> Station, <input type="checkbox"/> DN		
DN-03			<input type="checkbox"/> Station, <input type="checkbox"/> DN		
DN-04			<input type="checkbox"/> Station, <input type="checkbox"/> DN		
DN-05			<input type="checkbox"/> Station, <input type="checkbox"/> DN		
DN-06			<input type="checkbox"/> Station, <input type="checkbox"/> DN		
DN-07			<input type="checkbox"/> Station, <input type="checkbox"/> DN		
DN-08			<input type="checkbox"/> Station, <input type="checkbox"/> DN		
DN-09			<input type="checkbox"/> Station, <input type="checkbox"/> DN		
DN-10			<input type="checkbox"/> Station, <input type="checkbox"/> DN		
DN-11			<input type="checkbox"/> Station, <input type="checkbox"/> DN		
DN-12			<input type="checkbox"/> Station, <input type="checkbox"/> DN		

PF Key	PF Key Type	Number
01		
02		
03		
04		
05		
06		
07		
08		
09		
10		
11		
12		

DSS Key	DSS Key Type	Number
01		
02		
03		
04		
05		
06		
07		
08		

EXTENSION-STATION

Station Equipment No.

Item	Set Data
Telephone Type and Model	Type _____ Model _____
OHCA Circuit	<input type="checkbox"/> Yes, <input type="checkbox"/> No
Primary Directory Number	- - - - -
Intercom Number	- -
Station Name	_____
ICM Group	_____
Pickup Group	- - <input type="checkbox"/> None
Next Hunt Station	<input type="checkbox"/> EXT _____ <input type="checkbox"/> None
Class of Service	- -
Data Line Security	<input type="checkbox"/> Yes, <input type="checkbox"/> No
Automatic Callback-Trunk	<input type="checkbox"/> Yes, <input type="checkbox"/> No
Parallel Connect	<input type="checkbox"/> Yes, <input type="checkbox"/> No

Key	Key Type	Number	SDN	COS	Day Ring	Night Ring
DN-01	PDN		<input type="checkbox"/> Station	<input type="checkbox"/> DN		
DN-02			<input type="checkbox"/> Station	<input type="checkbox"/> DN		
DN-03			<input type="checkbox"/> Station	<input type="checkbox"/> DN		
DN-04			<input type="checkbox"/> Station	<input type="checkbox"/> DN		
DN-05			<input type="checkbox"/> Station	<input type="checkbox"/> DN		
DN-06			<input type="checkbox"/> Station	<input type="checkbox"/> DN		
DN-07			<input type="checkbox"/> Station	<input type="checkbox"/> DN		
DN-08			<input type="checkbox"/> Station	<input type="checkbox"/> DN		
DN-09			<input type="checkbox"/> Station	<input type="checkbox"/> DN		
DN-10			<input type="checkbox"/> Station	<input type="checkbox"/> DN		
DN-11			<input type="checkbox"/> Station	JDN		
DN-12			<input type="checkbox"/> Station	JDN		

PF Key	PF Key Type	Number
01		
02		
03		
04		
05		
06		
07		
08		
09		
10		
11		
12		

DSS Key	DSS Key Type	Number
01		
02		
03		
04		
05		
06		
07		
08		

EXTENSION-STATION

Station Equipment No.

Item	Set Data
Telephone Type and Model	Type _____ Model _____
OHCA Circuit	<input type="checkbox"/> Yes, <input type="checkbox"/> No
Primary Directory Number	- - - - -
Intercom Number	- - -
Station Name	_____
ICM Group	_____
Pickup Group	- - <input type="checkbox"/> None
Next Hunt Station	<input type="checkbox"/> <input type="checkbox"/> None
Class of Service	- -
Data Line Security	<input type="checkbox"/> Yes, <input type="checkbox"/> <input type="checkbox"/>
Automatic Callback-Trunk	<input type="checkbox"/> Yes, <input type="checkbox"/> No
Parallel Connect	<input type="checkbox"/> <input type="checkbox"/>

Key	Key Type	Number	SDN COS	Day Rinf	Night Ring
DN-01	PDN		<input type="checkbox"/> Station, <input type="checkbox"/> DN		
DN-02			<input type="checkbox"/> Station, <input type="checkbox"/> DN		
DN-03			<input type="checkbox"/> Station, <input type="checkbox"/> DN		
DN-04			<input type="checkbox"/> Station, <input type="checkbox"/> DN		
DN-05			<input type="checkbox"/> Station, <input type="checkbox"/> DN		
DN-06			<input type="checkbox"/> Station, <input type="checkbox"/> DN		
DN-07			<input type="checkbox"/> Station, <input type="checkbox"/> DN		
DN-08			<input type="checkbox"/> Station, <input type="checkbox"/> DN		
DN-09			<input type="checkbox"/> Station, <input type="checkbox"/> DN		
DN-10			<input type="checkbox"/> Station, <input type="checkbox"/> DN		
DN-11			<input type="checkbox"/> Station, <input type="checkbox"/> DN		
DN-12			<input type="checkbox"/> Station, <input type="checkbox"/> DN		

PF Key	PF Key Type	Number
01		
02		
03		
04		
05		
06		
07		
08		
09		
10		
11		
12		

DSS Key	DSS Key Type	Number
01		
02		
03		
04		
05		
06		
07		
08		

EXTENSION-STATION

Station Equipment No. _____

Item	Set Data
Telephone Type and Model	Type _____ Model _____
OHCA Circuit	<input type="checkbox"/> <input type="checkbox"/>
Primary Directory Number	_____
Intercom Number	- -
Station Name	- - - - -
ICM Group	---
Pickup Group	- - 0 None
Next Hunt Station	<input type="checkbox"/> _____ <input type="checkbox"/> None
Class of Set-vice	- -
Data Line Security	<input type="checkbox"/> Yes, <input type="checkbox"/> No
Automatic Callback-Trunk	<input type="checkbox"/> Yes, <input type="checkbox"/> No
Parallel Connect	<input type="checkbox"/> <input type="checkbox"/>

Key	Key Type	Number	SDN COS	Day Ring	Night Ring
DN-01	PDN		<input type="checkbox"/> Station, <input type="checkbox"/> DN		
DN-02			<input type="checkbox"/> Station, <input type="checkbox"/> DN		
DN-03			<input type="checkbox"/> Station, <input type="checkbox"/> DN		
DN-04			<input type="checkbox"/> Station, <input type="checkbox"/> DN		
DN-05			<input type="checkbox"/> Station, <input type="checkbox"/> DN		
DN-06			<input type="checkbox"/> Station, <input type="checkbox"/> DN		
DN-07			<input type="checkbox"/> Station, <input type="checkbox"/> DN		
DN-08			<input type="checkbox"/> Station, <input type="checkbox"/> DN		
DN-09			<input type="checkbox"/> Station, <input type="checkbox"/> DN		
DN-10			<input type="checkbox"/> Station, <input type="checkbox"/> DN		
DN-11			<input type="checkbox"/> Station, <input type="checkbox"/> DN		
DN-12			<input type="checkbox"/> Station, <input type="checkbox"/> DN		

PF Key	PF Key Type	Number
01		
02		
03		
04		
05		
06		
07		
08		
09		
10		
11		
12		

DSS Key	DSS Key Type	Number
01		
02		
03		
04		
05		
06		
07		
08		

EXTENSION-STATION

Station Equipment No.

Item	Set Data
Telephone Type and Model	Type _____ Model _____
OHCA Circuit	<input type="checkbox"/> Yes <input type="checkbox"/>
Primary Directory Number	- - - -
Intercom Number	- -
Station Name	- - - - -
ICM Group	-
Pickup Group	- - <input type="checkbox"/> None
Next Hunt Station	<input type="checkbox"/> <input type="checkbox"/> <input type="checkbox"/> <input type="checkbox"/> E None
Class of Service	- -
Data Line Security	<input type="checkbox"/> <input type="checkbox"/>
Automatic Callback-Trunk	<input type="checkbox"/> <input type="checkbox"/>
Parallel Connect	<input type="checkbox"/> <input type="checkbox"/>

Key	Key Type	Number	SDN	COS	Day Ring	Night Ring
DN-01	P D N		<input type="checkbox"/> Station,	<input type="checkbox"/> DN		
DN-02			<input type="checkbox"/> Station,	<input type="checkbox"/> DN		
DN-03			<input type="checkbox"/> Station,	<input type="checkbox"/> DN		
DN-04			<input type="checkbox"/> Station,	<input type="checkbox"/> DN		
DN-05			<input type="checkbox"/> Station,	<input type="checkbox"/> DN		
DN-06			<input type="checkbox"/> Station,	<input type="checkbox"/> DN		
DN-07			<input type="checkbox"/> Station,	<input type="checkbox"/> DN		
DN-08			<input type="checkbox"/> Station,	<input checked="" type="checkbox"/> DN		
DN-09			<input type="checkbox"/> Station,	<input type="checkbox"/> DN		
DN-10			<input type="checkbox"/> Station,	<input type="checkbox"/> DN		
DN-11			<input type="checkbox"/> Station,	<input type="checkbox"/> DN		
DN-12			<input type="checkbox"/> Station,	<input checked="" type="checkbox"/> DN		

PF Key	PF Key Type	Number
01		
02		
03		
04		
05		
08		
07		
08		
09		
10		
11		
12		

DSS Key	DSS Key Type	Number
01		
02		
03		
04		
05		
06		
07		
08		

EXTENSION-STATION

Station Equipment No.

Item	Set Data
Telephone Type and Model	Type _____ Model _____
OHCA Circuit	<input type="checkbox"/> Yes <input type="checkbox"/> No <input type="checkbox"/>
Primary Directory Number	- - - -
Intercom Number	- -
Station Name	_____
ICM Group	_____
Pickup Group	- - <input type="checkbox"/> None
Next Hunt Station	<input type="checkbox"/> <input type="checkbox"/> None
Class of Service	- -
Data Line Security	<input type="checkbox"/> Yes <input type="checkbox"/> No <input type="checkbox"/>
Automatic Callback-Trunk	<input type="checkbox"/> Yes, <input type="checkbox"/> No
Parallel Connect	<input type="checkbox"/> <input type="checkbox"/> No

Key	Key Type	Number	SDN COS	Day Ring	Night Ring
DN-01	PDN		<input type="checkbox"/> Station, <input type="checkbox"/> DN		
DN-02			<input type="checkbox"/> Station, <input type="checkbox"/> DN		
DN-03			<input type="checkbox"/> Station, <input type="checkbox"/> DN		
DN-04			<input type="checkbox"/> Station, <input type="checkbox"/> DN		
DN-05			<input type="checkbox"/> Station, <input type="checkbox"/> DN		
DN-06			<input type="checkbox"/> Station, <input type="checkbox"/> DN		
DN-07			<input type="checkbox"/> Station, <input type="checkbox"/> DN		
DN-08			<input type="checkbox"/> Station, <input type="checkbox"/> DN		
DN-09			<input type="checkbox"/> Station, <input type="checkbox"/> DN		
DN-10			<input type="checkbox"/> Station, <input type="checkbox"/> DN		
DN-11			<input type="checkbox"/> Station, <input type="checkbox"/> DN		
DN-12			<input type="checkbox"/> Station, <input type="checkbox"/> DN		

PF Key	PF Key Type	Number
01		
02		
03		
04		
05		
06		
07		
08		
09		
10		
11		
12		

DSS Key	DSS Key Type	Number
01		
02		
03		
04		
05		
06		
07		
08		

EXTENSION-STATION

Station Equipment No

item	Set Data
Telephone Type and Model	Type _____ Model _____
OHCA Circuit	<input type="checkbox"/> <input type="checkbox"/> No
Primary Directory Number	- - - -
intercom Number	- -
Station Name	-----
ICM Group	---
Pickup Group	- - C None
Next Hunt Station	<input type="checkbox"/> <input type="checkbox"/>
Class of Service	- -
Data Line Security.	<input type="checkbox"/> <input type="checkbox"/> No
Automatic Callback-Trunk	<input type="checkbox"/> <input type="checkbox"/> No
Parallel Connect	<input type="checkbox"/> <input type="checkbox"/> No

Key	Key Type	Number	SDN COS	Day Ring	Night Ring
DN-01	PDN		<input type="checkbox"/> Station, <input type="checkbox"/> DN		
DN-02			<input type="checkbox"/> Station, <input type="checkbox"/> DN		
DN-03			<input type="checkbox"/> Station, <input type="checkbox"/> DN		
DN-04			<input type="checkbox"/> Station, <input type="checkbox"/> DN		
DN-05			<input type="checkbox"/> Station, <input type="checkbox"/> DN		
DN-06			<input type="checkbox"/> Station, <input type="checkbox"/> DN		
DN-07			<input type="checkbox"/> Station, <input type="checkbox"/> DN		
DN-08			<input type="checkbox"/> Station, <input type="checkbox"/> DN		
DN-09			<input type="checkbox"/> Station, <input type="checkbox"/> DN		
DN-10			<input type="checkbox"/> Station, <input type="checkbox"/> DN		
DN-11			<input type="checkbox"/> Station, <input type="checkbox"/> DN		
DN-12			<input type="checkbox"/> Station, <input type="checkbox"/> DN		

PF Key	PF Key Type	Number
01		
02		
03		
04		
05		
06		
07		
08		
09		
10		
11		
12		

DSS Key	DSS Key Type	Number
01		
02		
03		
04		
05		
06		
07		
08		

EXTENSION-STATION

Station Equipment No.

Item	Set Data
Telephone Type and Model	Type _____ Model _____
OHCA Circuit	<input type="checkbox"/> <input type="checkbox"/> No
Primary Directory Number	_____
Intercom Number	- -
Station Name	_____
ICM Group	_____
Pickup Group	- - <input type="checkbox"/> None
Next Hunt Station	<input type="checkbox"/> _____ <input type="checkbox"/> None
Class of Service	- -
Data Line Security-	<input type="checkbox"/> <input type="checkbox"/>
Automatic Callback-Trunk	<input type="checkbox"/> Yes, <input type="checkbox"/> No
Parallel Connect	<input type="checkbox"/> Yes, <input type="checkbox"/>

Key	Key Type	Number	SDN COS	Day Ring	Night Ring
DN-01	PDN		<input type="checkbox"/> Station, <input type="checkbox"/> DN		
DN-02			<input type="checkbox"/> Station, <input type="checkbox"/> DN		
DN-03			<input type="checkbox"/> Station, <input type="checkbox"/> DN		
DN-04			<input type="checkbox"/> Station, <input type="checkbox"/> DN		
DN-05			<input type="checkbox"/> Station, <input type="checkbox"/> DN		
DN-06			<input type="checkbox"/> Station, <input type="checkbox"/> DN		
DN-07			<input type="checkbox"/> Station, <input type="checkbox"/> DN		
DN-08			<input type="checkbox"/> Station, <input type="checkbox"/> DN		
DN-09			<input type="checkbox"/> Station, <input type="checkbox"/> DN		
DN-10			<input type="checkbox"/> Station, <input type="checkbox"/> DN		
DN-11			<input type="checkbox"/> Station, <input type="checkbox"/> DN		
DN-12			<input type="checkbox"/> Station, <input type="checkbox"/> DN		

PF Key	PF Key Type	Number
01		
02		
03		
04		
05		
06		
07		
08		
09		
10		
11		
12		

DSS Key	DSS Key Type	Number
01		
02		
03		
04		
05		
06		
07		
08		

EXTENSION-STATION

Station Equipment No.

item	Set Data
Telephone Type and Model	Type _____ Model _____
OHCA Circuit	<input type="checkbox"/> Yes, <input type="checkbox"/> <input type="checkbox"/>
Primary Directory Number	- - - - -
Intercom Number	- -
Station Name	- - - - -
ICM Group	---
Pickup Group	- - 0 None
Next Hunt Station	<input type="checkbox"/> _____ <input type="checkbox"/>
Class of Service	- -
Da& Line Security	<input type="checkbox"/> <input type="checkbox"/> No
Automatic Callback-Trunk	<input type="checkbox"/> Yes, <input type="checkbox"/> No
Parallel Connect	<input type="checkbox"/> <input type="checkbox"/> No

Key	Key Type	Number	SDN COS	Day Ring	Night Ring
DN-01	PDN		<input type="checkbox"/> Station, <input type="checkbox"/> DN		
DN-02			<input type="checkbox"/> Station, <input type="checkbox"/> DN		
DN-03			<input type="checkbox"/> Station, <input type="checkbox"/> DN		
DN-04			<input type="checkbox"/> Station, <input type="checkbox"/> DN		
DN-05			<input type="checkbox"/> Station, <input type="checkbox"/> DN		
DN-06			<input type="checkbox"/> Station, <input type="checkbox"/> DN		
DN-07			<input type="checkbox"/> Station, <input type="checkbox"/> DN		
DN-08			<input type="checkbox"/> Station, <input type="checkbox"/> DN		
DN-09			<input type="checkbox"/> Station, <input type="checkbox"/> DN		
DN-10			<input type="checkbox"/> Station, <input type="checkbox"/> DN		
DN-11			<input type="checkbox"/> Station, <input type="checkbox"/> DN		
DN-12			<input type="checkbox"/> Station, <input type="checkbox"/> DN		

PF Key	PF Key Type	Number	DSS Key	DSS Key Type	Number
01			01		
02			02		
03			03		
04			04		
05			05		
06			06		
07			07		
08			08		
09					
10					
11					
12					

EXTENSION-STATION

Station Equipment No

Item	Set Data
Telephone Type and Mode	Type _____ Model _____
C-DA Circuit	<input type="checkbox"/> Yes <input type="checkbox"/> No
Primary Directory Number	-----
Inter-Office Number	-----
Station Name	-----
ICM Group	---
FIDUC Group	----- <input type="checkbox"/> None
Next Hunt Station	<input type="checkbox"/> EXT ----- <input type="checkbox"/> None
Class of Service	-----
COT Line Security	<input type="checkbox"/> Yes <input type="checkbox"/> No
Automatic Call Back-Trunk	<input type="checkbox"/> Yes, <input type="checkbox"/> No
Parallel Connect	<input type="checkbox"/> Yes, <input type="checkbox"/> No

Key	Key Type	Number	SDN	COS	Day Ring	Night Ring
DN-01	PDN		<input type="checkbox"/> Station,	<input type="checkbox"/> DN		
DN-02			<input type="checkbox"/> Station,	<input type="checkbox"/> DN		
DN-03			<input type="checkbox"/> Station,	<input type="checkbox"/> DN		
DN-04			<input type="checkbox"/> Station,	nDN		
DN-05			<input type="checkbox"/> Station,	ODN		
DN-06			<input type="checkbox"/> Station,	<input type="checkbox"/> DN		
DN-07			<input type="checkbox"/> Station,	uDN		
DN-08			<input type="checkbox"/> Station,	<input type="checkbox"/> DN		
DN-09			<input type="checkbox"/> Station,	<input type="checkbox"/> DN		
DN-10			<input type="checkbox"/> Station,	<input type="checkbox"/> DN		
DN-11			<input type="checkbox"/> Station,	<input type="checkbox"/> DN		
DN-12			<input type="checkbox"/> Station,	<input type="checkbox"/> DN		

PF Key	PF Key Type	Number	DSS Key	DSS Key Type	Number
01			01		
02			02		
03			03		
04			04		
05			05		
06			06		
07			07		
08			08		
09					
10					

EXTENSION-STATION

Station Equipment No.

item	Set Data
Telephone Type and Model	Type _____ Model _____
OHCA Circuit	<input type="checkbox"/> Yes, <input type="checkbox"/> No
Primary Directory Number	_____
Intercom Number	_____
Station Name	_____
ICM Group	_____
Pickup Group	- - <input type="checkbox"/> None
Next Hunt Station	<input type="checkbox"/> EXT <input type="checkbox"/> N o n e
Class of Service	- -
Data Line Security	<input type="checkbox"/> <input type="checkbox"/>
Automatic Callback-Trunk	<input type="checkbox"/> <input type="checkbox"/> No
Parallel Connect	<input type="checkbox"/> Yes, <input type="checkbox"/> No

Key	Key Type	Number	SDN	COS	Day Ring	Night Ring
DN-01	PDN		<input type="checkbox"/> Station, <input type="checkbox"/> DN			
DN-02			<input type="checkbox"/> Station, <input type="checkbox"/> DN			
DN-03			<input type="checkbox"/> Station, <input type="checkbox"/> DN			
DN-04			<input type="checkbox"/> Station, <input type="checkbox"/> DN			
DN-05			<input type="checkbox"/> Station, <input type="checkbox"/> DN			
DN-06			<input type="checkbox"/> Station, <input type="checkbox"/> DN			
DN-07			<input type="checkbox"/> Station, <input type="checkbox"/> DN			
DN-08			<input type="checkbox"/> Station, <input type="checkbox"/> DN			
DN-09			<input type="checkbox"/> Station, <input type="checkbox"/> DN			
DN-10			<input type="checkbox"/> Station, <input type="checkbox"/> DN			
DN-11			<input type="checkbox"/> Station, <input type="checkbox"/> DN			
DN-12			<input type="checkbox"/> Station, <input type="checkbox"/> DN			

PF Key	PF Key Type	Number
01		
02		
03		
04		
05		
06		
07		
08		
09		
10		
11		
12		

DSS Key	DSS Key Type	Number
01		
02		
03		
04		
05		
06		
07		
08		

EXTENSION-STATION

Station Equipment No.

Item	Set Data
Telephone Type and Model	Type _____ Model _____
OHCA Circuit	<input type="checkbox"/> Yes, <input type="checkbox"/> No <input type="checkbox"/>
Primary Directory Number	_____
Intercom Number	_____
Station Name	_____
ICM Group	_____
Pickup Group	_____ <input type="checkbox"/> None
Next Hunt Station	<input type="checkbox"/> EXT <input type="checkbox"/> None _____
Class of Service	_____
Data Line Security	<input type="checkbox"/> <input type="checkbox"/>
Automatic Callback-Trunk	<input type="checkbox"/> <input type="checkbox"/>
Parallel Connect	<input type="checkbox"/> <input type="checkbox"/>

Key	Key Type	Number	SDN	COS	Day Ring	Night Ring
DN-01	PDN		<input type="checkbox"/> Station	<input type="checkbox"/> DN		
DN-02			<input type="checkbox"/> Station	<input type="checkbox"/> DN		
DN-03			<input type="checkbox"/> Station	<input type="checkbox"/> DN		
DN-04			<input type="checkbox"/> Station	<input type="checkbox"/> DN		
DN-05			<input type="checkbox"/> Station	<input type="checkbox"/> DN		
DN-06			<input type="checkbox"/> Station	<input type="checkbox"/> DN		
DN-07			<input type="checkbox"/> Station	<input type="checkbox"/> DN		
DN-08			<input type="checkbox"/> Station	<input type="checkbox"/> DN		
DN-09			<input type="checkbox"/> Station	<input type="checkbox"/> DN		
DN-10			<input type="checkbox"/> Station	<input type="checkbox"/> DN		
DN-11			<input type="checkbox"/> Station	<input type="checkbox"/> DN		
DN-12			<input type="checkbox"/> Station	<input type="checkbox"/> DN		

PF Key	PF Key Type	Number
01		
02		
03		
04		
05		
06		
07		
08		
09		
10		
11		
12		

DSS Key	DSS Key Type	Number
01		
02		
03		
04		
05		
06		
07		
08		

EXTENSION-STATION

Station Equipment No.

Item	Set Data
Telephone Type and Model	Type _____ Model _____
OHCA Circuit	<input type="checkbox"/> <input type="checkbox"/> <input type="checkbox"/> <input type="checkbox"/> No
Primary Directory Number	- - - -
Intercom Number	- -
Station Name	_____
ICM Group	_____
Pickup Group	- - <input type="checkbox"/> None
Next Hunt Station	<input type="checkbox"/> <input type="checkbox"/> <input type="checkbox"/> _____ <input type="checkbox"/> None
Class of Service	- -
Data Line Security	<input type="checkbox"/> <input type="checkbox"/> <input type="checkbox"/> No
Automatic Callback-Trunk	<input type="checkbox"/> Yes, <input type="checkbox"/> No
Parallel Connect	<input type="checkbox"/> Yes, <input type="checkbox"/> No

Key	Key Type	Number	SDN COS	Day Ring	Night Ring
DN-01	PDN		<input type="checkbox"/> Station, <input type="checkbox"/> DN		
DN-02			<input type="checkbox"/> Station,ODN		
DN-03			<input type="checkbox"/> Station <input type="checkbox"/> DN		
DN-04			<input type="checkbox"/> Station,nDN		
DN-05			<input type="checkbox"/> Station, <input type="checkbox"/> DN		
DN-06			<input type="checkbox"/> Station.nDN		
DN-07			<input type="checkbox"/> Station, <input type="checkbox"/> DN		
DN-08'			<input type="checkbox"/> Station,mDN		
DN-09			<input type="checkbox"/> Station,uDN		
DN-10			<input type="checkbox"/> Station,nDN		
DN-11			<input type="checkbox"/> Station, <input type="checkbox"/> DN		
DN-12			<input type="checkbox"/> Station, <input type="checkbox"/> JDN		

PF Key	PF Key Type	Number	DSS Key	DSS Key Type	Number
01			01		
02			02		
03			03		
04			04		
05			05		
06			06		
07			07		
08			08		
09					
10					
11					
12					

EXTENSION-STATION

Station Equipment No.

Item	Set Data
Telephone Type and Model	Type _____ Model _____
OHCA Circuit	<input type="checkbox"/> Yes, <input type="checkbox"/> No
Primary Directory Number	_____
Intercom Number	- -
Station Name	_____
ICM Group	_____
Pickup Group	- - <input type="checkbox"/> None
Next Hunt Station	<input type="checkbox"/> EXT <input type="checkbox"/> _____ None
Class of Service	- -
Data- Line Security	<input type="checkbox"/> <input type="checkbox"/> No
Automatic Callback-Trunk	<input type="checkbox"/> Yes, <input type="checkbox"/> No
Parallel Connect	<input type="checkbox"/> Yes, <input type="checkbox"/> No

Key	Key Type	Number	SDN COS	Day Ring	Night Ring
DN-01	PDN		<input type="checkbox"/> Station, <input type="checkbox"/> DN		
DN-02			<input type="checkbox"/> Station, <input type="checkbox"/> DN		
DN-03			<input type="checkbox"/> Station, <input type="checkbox"/> DN		
DN-04			<input type="checkbox"/> Station, <input type="checkbox"/> DN		
DN-05			<input type="checkbox"/> Station, <input type="checkbox"/> DN		
DN-06			<input type="checkbox"/> Station, <input type="checkbox"/> DN		
DN-07			<input type="checkbox"/> Station, <input type="checkbox"/> DN		
DN-08			<input type="checkbox"/> Station, <input type="checkbox"/> DN		
DN-09			<input type="checkbox"/> Station, <input type="checkbox"/> DN		
DN-10			<input type="checkbox"/> Station, <input type="checkbox"/> DN		
DN-11			<input type="checkbox"/> Station, <input type="checkbox"/> DN		
DN-12			<input type="checkbox"/> Station, <input type="checkbox"/> DN		

PF Key	PF Key Type	Number
01		
02		
03		
04		
05		
06		
07		
08		
09		
10		
11		
12		

DSS Key	DSS Key Type	Number
01		
02		
03		
04		
05		
06		
07		
08		

EXTENSION-STATION

Station Equipment No.

Item	Set Data
Telephone Type and Model	Type _____ Model _____
OHCA Circuit	<input type="checkbox"/> Yes, <input type="checkbox"/> No
Primary Directory Number	_____
Intercom Number	_____
Station Name	_____
ICM Group	_____
Pickup Group	_____ <input type="checkbox"/> None
Next Hunt Station	<input type="checkbox"/> <input type="checkbox"/> <input type="checkbox"/> _____ <input type="checkbox"/> None
Class of Service	_____
Data Line Security	<input type="checkbox"/> <input type="checkbox"/> <input type="checkbox"/> <input type="checkbox"/>
Automatic Callback-Trunk	<input type="checkbox"/> Yes, <input type="checkbox"/> <input type="checkbox"/>
Parallel Connect	<input type="checkbox"/> Yes, <input type="checkbox"/> No

Key	Key Type	Number	SDN	COS	Day Ring	Night Ring
DN-01	PDN		<input type="checkbox"/> Station	<input type="checkbox"/> DN		
DN-02			<input type="checkbox"/> Station,	<input type="checkbox"/> DN		
DN-03			<input type="checkbox"/> Station,	<input type="checkbox"/> DN		
DN-04			<input type="checkbox"/> Station.n	DN		
DN-05			<input type="checkbox"/> Station,	ODN		
DN-06			<input type="checkbox"/> Station,-/	JDN		
DN-07			<input type="checkbox"/> Station,	<input type="checkbox"/> DN		
DN-08			<input type="checkbox"/> Station	<input type="checkbox"/> DN		
DN-09			<input type="checkbox"/> Station,	<input type="checkbox"/> DN		
DN-10			<input type="checkbox"/> Station,	<input type="checkbox"/> DN		
DN-11			<input type="checkbox"/> Station,	<input type="checkbox"/> DN		
DN-12			<input type="checkbox"/> Station	<input type="checkbox"/> DN		
PF Key	PF Key Type	Number	DSS Key	DSS Key Type	Number	
01			01			
02			02			
03			03			
04			04			
05			05			
06			06			
07			07			
08			08			
09						
10						
11						
12						

EXTENSION-STATION

Station Equipment No.

Item	Set Data
Telephone Type and Model	Type _____ Model _____
OHCA Circuit	<input type="checkbox"/> Yes, <input type="checkbox"/> No
Primary Directory Number	<input style="width: 100px;" type="text"/> .
Intercom Number	<input style="width: 50px;" type="text"/>
Station Name	<input style="width: 100px;" type="text"/>
ICM Group	
Pickup Group	_____ <input type="checkbox"/> None
Next Hunt Station	<input type="checkbox"/> <input type="checkbox"/> <input type="checkbox"/> <input type="checkbox"/> _____ <input type="checkbox"/> None
Class of Service	
Data-Line Security	<input type="checkbox"/> <input type="checkbox"/> <input type="checkbox"/> <input type="checkbox"/>
Automatic Callback-Trunk	<input type="checkbox"/> <input type="checkbox"/> <input type="checkbox"/> <input type="checkbox"/>
Parallel Connect	<input type="checkbox"/> <input type="checkbox"/> <input type="checkbox"/> <input type="checkbox"/>

Key	Key Type	Number	SDN COS	Day Ring	Night Ring
DN-01	PDN		<input type="checkbox"/> Station, <input type="checkbox"/> DN		
DN-02			<input type="checkbox"/> Station, <input type="checkbox"/> DN		
DN-03			<input type="checkbox"/> Station, <input type="checkbox"/> DN		
DN-04			<input type="checkbox"/> Station, <input type="checkbox"/> DN		
DN-05			<input type="checkbox"/> Station, <input type="checkbox"/> DN		
DN-06			<input type="checkbox"/> Station, <input type="checkbox"/> DN		
DN-07			<input type="checkbox"/> Station, <input type="checkbox"/> DN		
DN-08			<input type="checkbox"/> Station, <input type="checkbox"/> DN		
DN-09			<input type="checkbox"/> Station, <input type="checkbox"/> DN		
DN-10			<input type="checkbox"/> Station, <input type="checkbox"/> DN		
DN-11			<input type="checkbox"/> Station, <input type="checkbox"/> DN		
DN-12			<input type="checkbox"/> Station, <input type="checkbox"/> DN		

PF Key	PF Key Type	Number	DSS Key	DSS Key Type	Number
01			01		
02			02		
03			03		
04			04		
05			05		
06			06		
07			07		
08			08		
09					
10					
11					
12					

EXTENSION-STATION

Station Equipment No.

Item	Set Data
Telephone Type and Model	Type _____ Model _____
OHCA Circuit	<input type="checkbox"/> Yes. <input type="checkbox"/> No
Primary Directory Number	- - - -
Intercom Number	- -
! Station Name	_____
ICM Group	_____
Pickup Group	- - <input type="checkbox"/> None
Next Hunt Station	<input type="checkbox"/> EXT <input type="checkbox"/> None
Class of Service	- -
j Data Line Security	<input type="checkbox"/> Yes. <input type="checkbox"/> No
Automatic Callback-Trunk	<input type="checkbox"/> Yes. <input type="checkbox"/> <input checked="" type="checkbox"/> <input type="checkbox"/>
Parallel Connect	<input type="checkbox"/> Yes. <input type="checkbox"/> No

Key	Key Type	Number	SDN	COS	Day Ring	Night Ring
DN-01	PDN		<input type="checkbox"/>	Station,uDN		
DN-02			<input type="checkbox"/>	Station,CJDN		
DN-03			<input type="checkbox"/>	Station,nDN		
DN-04			<input type="checkbox"/>	Station, <input type="checkbox"/> DN		
DN-05			<input type="checkbox"/>	Station,ODN		
DN-06			<input type="checkbox"/>	Station,aDN		
DN-07			<input type="checkbox"/>	Station,nDN		
DN-08			<input type="checkbox"/>	tation,aDN		
DN-09			<input type="checkbox"/>	StationJJDN		
DN-10			<input type="checkbox"/>	Station,JJDN		
DN-11			<input type="checkbox"/>	Station.ODN		
DN-12			<input type="checkbox"/>	Station, <input type="checkbox"/> DN		

3

PF Key	PF Key Type	Number	DSS Key	DSS Key Type	Number
01			01		
02			02		
03			03		
04			04		
05			05		
06			06		
07			07		
08			08		
09					
10					
11					
12					

EXTENSION-STATION

Station Equipment No.

Item	Set Data
Telephone Type and Model	Type _____ Model _____
OHCA Circuit	<input type="checkbox"/> Yes, <input type="checkbox"/>
Primary Directory Number	_____
Intercom Number	- -
Station Name	_____
ICM Group	_____
Pickup Group	- - <input type="checkbox"/> None
Next Hunt Station	<input type="checkbox"/> EXT _____ <input type="checkbox"/> None
Class of Service	- -
Data Line Security	<input type="checkbox"/> Yes, <input type="checkbox"/>
Automatic Callback-Trunk	<input type="checkbox"/> Yes, <input type="checkbox"/> NO
Parallel Connect	<input type="checkbox"/> Yes, <input type="checkbox"/>

Key	Key Type	Number	SDN COS	Day Ring	Night Ring
DN-01	PDN		<input type="checkbox"/> Station, <input type="checkbox"/> DN		
DN-02			<input type="checkbox"/> Station, <input type="checkbox"/> DN		
DN-03			<input type="checkbox"/> Station, DDN		
DN-04			<input type="checkbox"/> Station, <input type="checkbox"/> DN		
DN-05			<input type="checkbox"/> Station, <input type="checkbox"/> DN		
DN-08			<input type="checkbox"/> Station, <input type="checkbox"/> DN		
DN-07			<input type="checkbox"/> Station, <input type="checkbox"/> DN		
DN-08			<input type="checkbox"/> Station, nDN		
DN-09			<input type="checkbox"/> Station, <input type="checkbox"/> DN		
DN-10			<input type="checkbox"/> Station, ODN		
DN-11			<input type="checkbox"/> Station, <input type="checkbox"/> DN		
DN-12			<input type="checkbox"/> Station, nDN		

PF Key	PF Key Type	Number	DSS Key	DSS Key Type	Number
01			01		
02			02		
03			03		
04			04		
05			05		
06			06		
07			07		
08			08		
09					
10					
11					
12					

EXTENSION-STATION

Station Equipment No.

Item	Set Data
Telephone Type and Model	Type _____ Mode _____
OHCA Circuit	<input type="checkbox"/> Yes, <input type="checkbox"/> No
Primary Directory Number	- - - -
Intercom Number	- -
Station Name	_____
ICM Group	_____
Pickup Group	- - <input type="checkbox"/> None
Next Hunt Station	<input type="checkbox"/> EXT <input type="checkbox"/> None _____
Class of Service	- -
Data Line Security	<input type="checkbox"/> No
Automatic Callback-Trunk	<input type="checkbox"/> Yes, <input type="checkbox"/> No
Parallel Connect	<input type="checkbox"/> <input type="checkbox"/> <input type="checkbox"/> <input type="checkbox"/>

Key	Key Type	Number	SDN COS	Day Ring	Night Ring
DN-01	PDN		<input type="checkbox"/> Station, <input type="checkbox"/> DN		
DN-02			<input type="checkbox"/> Station, <input type="checkbox"/> DN		
DN-03			<input type="checkbox"/> Station, <input type="checkbox"/> DN		
DN-04			<input type="checkbox"/> Station, <input type="checkbox"/> DN		
DN-05			<input type="checkbox"/> Station, <input type="checkbox"/> DN		
DN-06			<input type="checkbox"/> Station, <input type="checkbox"/> DN		
DN-07			<input type="checkbox"/> Station, <input type="checkbox"/> DN		
DN-08			<input type="checkbox"/> Station, <input type="checkbox"/> DN		
DN-09			<input type="checkbox"/> Station, <input type="checkbox"/> DN		
DN-10			<input type="checkbox"/> Station, <input type="checkbox"/> DN		
DN-11			<input type="checkbox"/> Station, <input type="checkbox"/> DN		
DN-12			<input type="checkbox"/> Station, <input type="checkbox"/> DN		

PF Key	PF Key Type	Number	DSS Key	DSS Key Type	Number
01			01		
02			02		
03			03		
04			04		
05			05		
06			06		
07			07		
08			08		
09					
10					
11					
12					

EXTENSION-STATION

Station Equipment No.

Item	Set Data
Telephone Type and Model	Type _____ Model _____
OHCA Circuit	<input type="checkbox"/> Yes, <input type="checkbox"/>
Primary Directory Number	_____
Intercom Number	_____
Station Name	_____
ICM Group	_____
Pickup Group	- - <input type="checkbox"/> None
Next Hunt Station	<input type="checkbox"/> <input type="checkbox"/> <input type="checkbox"/> <input type="checkbox"/> <input type="checkbox"/> None
Class of Service	_____
Data Line Security	<input type="checkbox"/> <input type="checkbox"/> <input type="checkbox"/>
Automatic Callback-Trunk	<input type="checkbox"/> Yes, <input type="checkbox"/>
Parallel Connect	<input type="checkbox"/> Yes, <input type="checkbox"/>

Key	Key Type	Number	SDN	COS	Day Ring	Night Ring
DN-01	PDN		<input type="checkbox"/> Station,	<input type="checkbox"/> DN		
DN-02			<input type="checkbox"/> Station,	<input type="checkbox"/> DN		
DN-03			<input type="checkbox"/> Station,	ODN		
DN-04			<input type="checkbox"/> Station,	<input type="checkbox"/> DN		
DN-05			<input type="checkbox"/> Station,	[7]DN		
DN-06			<input type="checkbox"/> Station,	<input type="checkbox"/> DN		
DN-07			<input type="checkbox"/> Station,	<input type="checkbox"/> DN		
DN-08			<input type="checkbox"/> Station,	<input type="checkbox"/> DN		
DN-09			<input type="checkbox"/> Station,	ODN		
DN-10			<input type="checkbox"/> Station,	<input type="checkbox"/> DN		
DN-11			<input type="checkbox"/> Station,	<input type="checkbox"/> DN		
DN-12			<input type="checkbox"/> Station,	[r]DN		

PF Key	PF Key Type	Number	DSS Key	DSS Key Type	Number
01			01		
02			02		
03			03		
04			04		
05			05		
06			06		
07			07		
08			08		
09					
10					
11					
12					

EXTENSION-STATION

Station Equipment No.

Item	Set Data
Telephone Type and Model	Type _____ Model _____ - -
OHCA Circuit	<input type="checkbox"/> Yes <input type="checkbox"/> No <input type="checkbox"/>
Primary Directory Number	_____
Intercom Number	- -
Station Name	_____
ICM Group	_____
Pickup Group	- - C None
Next Hunt Station	<input type="checkbox"/> <input type="checkbox"/> _____ <input type="checkbox"/> None
Class of Service	- -
Data-Line Security	<input type="checkbox"/> Yes, <input type="checkbox"/> No
Automatic Callback-Trunk	<input type="checkbox"/> Yes, <input type="checkbox"/> No
Parallel Connect	<input type="checkbox"/> <input type="checkbox"/>

Key	Key Type	Number	SDN COS	Day Ring	Night Ring
DN-01	PDN		<input type="checkbox"/> Station, <input type="checkbox"/> DN		
DN-02			<input type="checkbox"/> Station, <input type="checkbox"/> DN		
DN-03			<input type="checkbox"/> Station, <input type="checkbox"/> DN		
DN-04			<input type="checkbox"/> Station, <input type="checkbox"/> DN		
DN-05			<input type="checkbox"/> Station, <input type="checkbox"/> iJDN		
DN-06			<input type="checkbox"/> Station, <input type="checkbox"/> ODN		
DN-07			<input type="checkbox"/> Station, <input type="checkbox"/> DN		
DN-08			<input type="checkbox"/> Station, <input type="checkbox"/> DN		
DN-09			<input type="checkbox"/> Station, <input type="checkbox"/> nDN		
DN-10			<input type="checkbox"/> Station, <input type="checkbox"/> DN		
DN-11			<input type="checkbox"/> Station, <input type="checkbox"/> DN		
DN-12			<input type="checkbox"/> Station, <input type="checkbox"/> jDN		

PF Key	PF Key Type	Number	DSS Key	DSS Key Type	Number
01			01		
02			02		
03			03		
04			04		
05			05		
06			06		
07			07		
08			08		
09					
10					
11					
12					

EXTENSION-STATION

Station Equipment No.

Item	Set Data
Telephone Type and Model	Type _____ Model _____
OHCA Circuit	<input type="checkbox"/> Yes, <input type="checkbox"/> No
Primary Directory Number	- - - -
Intercom Number	---
Station Name	-----
ICM Group	---
Pickup Group	- - <input type="checkbox"/> None
Next Hunt Station	<input type="checkbox"/> EXT <input type="checkbox"/> None
Class of Service	- -
Data Line Security	<input type="checkbox"/> Yes, <input type="checkbox"/> No
Automatic Callback-Trunk	<input type="checkbox"/> Yes, <input type="checkbox"/> No
Parallel Connect	<input type="checkbox"/> Yes, <input type="checkbox"/> No

Key	Key Type	Number	SDNCOS	Day Ring	Night Ring
ON-01	PDN		<input type="checkbox"/> Station, <input type="checkbox"/> DN		
DN-02			<input type="checkbox"/> Station, <input type="checkbox"/> DN		
DN-03			<input type="checkbox"/> Station, <input type="checkbox"/> DN		
DN-04			<input type="checkbox"/> Station, <input type="checkbox"/> DN		
DN-05			<input type="checkbox"/> Station, <input type="checkbox"/> DN		
DN-06			<input type="checkbox"/> Station, <input type="checkbox"/> DN		
DN-07			<input type="checkbox"/> Station, <input type="checkbox"/> DN		
DN-08			<input type="checkbox"/> Station, <input type="checkbox"/> DN		
DN-09			<input type="checkbox"/> Station, ODN		
DN-10			<input type="checkbox"/> Station, <input type="checkbox"/> DN		
DN-11			<input type="checkbox"/> Station, <input type="checkbox"/> DN		
DN-12			<input type="checkbox"/> Station, <input type="checkbox"/> DN		

PF Key	PF Key Type	Number	DSS Key	DSS Key Type	Number
01			01		
02			02		
03			I 03 I		
04			04		
05			05		
06			06		
07			07		
08			08		
09					
10					
11					
12					

EXTENSION-STATION

Station Equipment No. _____

Item	Set Data
Telephone Type and Model	Type _____ Model _____
OHCA Circuit	<input type="checkbox"/> Yes, <input type="checkbox"/> No
Primary Directory Number	_____
Intercom Number	_____
Station Name	-----
ICM Group	---
Pickup Group	_____ <input type="checkbox"/> None
Next Hunt Station	<input type="checkbox"/> EXT _____ <input type="checkbox"/> None
Class of Service	---
Data-Line -Security	<input type="checkbox"/> Yes, <input type="checkbox"/> No
Automatic Callback-Trunk	<input type="checkbox"/> Yes, <input type="checkbox"/> No
Parallel Connect	<input type="checkbox"/> Yes, <input type="checkbox"/> No

Key	Key Type	Number	SDN COS	Day Ring	Night Ring
DN-01	PDN		<input type="checkbox"/> Station, <input type="checkbox"/> DN		
DN-02			<input type="checkbox"/> Station, <input type="checkbox"/> DN		
DN-03			<input type="checkbox"/> Station, <input type="checkbox"/> DN		
DN-04			<input type="checkbox"/> Station, <input type="checkbox"/> DN		
DN-05			<input type="checkbox"/> Station, <input type="checkbox"/> DN		
DN-06			<input type="checkbox"/> Station, <input type="checkbox"/> DN		
DN-07			<input type="checkbox"/> Station, <input type="checkbox"/> DN		
DN-08			<input type="checkbox"/> Station, <input type="checkbox"/> DN		
DN-09			<input type="checkbox"/> Station, <input type="checkbox"/> DN		
DN-10			<input type="checkbox"/> Station, <input type="checkbox"/> DN		
DN-11			<input type="checkbox"/> Station, <input type="checkbox"/> DN		
DN-12			<input type="checkbox"/> Station, <input type="checkbox"/> DN		

PF Key	PF Key Type	Number	DSS Key	DSS Key Type	Number
01			01		
02			02		
03			03		
04			04		
05			05		
06			06		
07			07		
08			08		
09					
10					
11					
12					

EXTENSION-STATION

Station Equipment No

Item	Set Data
Telephone Type and Model	Type _____ Model _____
OHCA Circuit	<input type="checkbox"/> Yes, <input type="checkbox"/> Yes
Primary Directory Number	_____
Intercom Number	_____
Station Name	_____
ICM Group	_____
Pickup Group	_____ <input type="checkbox"/> None
Next Hunt Station	<input type="checkbox"/> EXT _____ <input type="checkbox"/> None
Class of Service	_____
Data Line Security	<input type="checkbox"/> Yes, <input type="checkbox"/> No
Automatic Callback-Trunk	<input type="checkbox"/> Yes, <input type="checkbox"/> No
Parallel Connect	<input type="checkbox"/> Yes, <input type="checkbox"/> Yes

Key	Key Type	Number	SDN COS	Day Ring	Night Ring
DN-01	PDN		<input type="checkbox"/> Station, <input type="checkbox"/> DN		
DN-02			<input type="checkbox"/> Station, <input type="checkbox"/> DN		
DN-03			<input type="checkbox"/> Station, <input type="checkbox"/> DN		
DN-04			<input type="checkbox"/> Station, <input type="checkbox"/> DN		
DN-05			<input type="checkbox"/> Station, <input type="checkbox"/> DN		
DN-06			<input type="checkbox"/> Station, <input type="checkbox"/> DN		
DN-07			<input type="checkbox"/> Station, <input type="checkbox"/> DN		
DN-08			<input type="checkbox"/> Station, <input type="checkbox"/> DN		
DN-09			<input type="checkbox"/> Station, <input type="checkbox"/> DN		
DN-10			<input type="checkbox"/> Station, <input type="checkbox"/> DN		
DN-11			<input type="checkbox"/> Station, <input type="checkbox"/> DN		
DN-12			<input type="checkbox"/> Station, <input type="checkbox"/> DN		

PF Key	PF Key Type	Number	DSS Key	DSS Key Type	Number
01			01		
02			02		
03			03		
04			04		
05			05		
06			06		
07			07		
08			.08		
09					
10					
11					
12					

EXTENSION-STATION

Extension No.

	Set Data
Extension and Model	Type _____ Model _____
Extension Number	<input type="checkbox"/> Yes, <input type="checkbox"/> No _____ _____ _____
Extension	_____ <input type="checkbox"/> None ☎ ☎ ☎ ☎ ☎ ☎ ☎ ☎ ☎ ☎ <input type="checkbox"/> None
Extension	☎ ☎ ☎ ☎ ☎ ☎ ☎ ☎ ☎ ☎
Extension	☎ ☎ ☎ ☎ ☎ ☎ ☎ ☎ ☎ ☎
Extension	<input type="checkbox"/> Yes, ☎ ☎ ☎ ☎ ☎ ☎ ☎ ☎ ☎ ☎

Extension No.	Number	SDN COS	Day Ring	Night Ring
		<input type="checkbox"/> Station, <input type="checkbox"/> DN		
		<input type="checkbox"/> Station, <input type="checkbox"/> DN		
		<input type="checkbox"/> Station, <input type="checkbox"/> DN		
		<input type="checkbox"/> Station, <input type="checkbox"/> DN		
		<input type="checkbox"/> Station, <input type="checkbox"/> DN		
		<input type="checkbox"/> Station, <input type="checkbox"/> DN		
		<input type="checkbox"/> Station, <input type="checkbox"/> DN		
		<input type="checkbox"/> Station, <input type="checkbox"/> DN		
		<input type="checkbox"/> Station, <input type="checkbox"/> DN		
		<input type="checkbox"/> Station, <input type="checkbox"/> DN		
		<input type="checkbox"/> Station, <input type="checkbox"/> DN		
		<input type="checkbox"/> Station, <input type="checkbox"/> DN		

Night Ring

Extension No.	Number

DSS Key	DSS Key Type	Number
01		
02		
03		
04		
05		
06		
07		
08		

Number

EXTENSION-STATION

Station Equipment No.

Item	Set Data
Telephone Type and Model	Type _____ Model _____
OHCA Circuit	<input type="checkbox"/> Yes, <input type="checkbox"/> No
Primary Directory Number	- - - - -
Intercom Number	- -
Station Name	-----
ICM Group	---
Pickup Group	- - 0 None
Next Hunt Station	<input type="checkbox"/> <input type="checkbox"/> <input type="checkbox"/> <input type="checkbox"/> <input type="checkbox"/> <input type="checkbox"/> <input type="checkbox"/> None
Class of Service	- -
Data Line Security	<input type="checkbox"/> <input type="checkbox"/> <input type="checkbox"/> <input type="checkbox"/> <input type="checkbox"/> No
Automatic Callback-Trunk	<input type="checkbox"/> Yes, <input type="checkbox"/> NO
Parallel Connect	<input type="checkbox"/> <input type="checkbox"/> <input type="checkbox"/> <input type="checkbox"/> <input type="checkbox"/> No

Key	Key Type	Number	SDN COS	Day Ring	Night Ring
DN-01	PDN		<input type="checkbox"/> Station, <input type="checkbox"/> DN		
DN-02			<input type="checkbox"/> Station, <input type="checkbox"/> DN		
DN-03			<input type="checkbox"/> Station, <input type="checkbox"/> DN		
DN-04			<input type="checkbox"/> Station, <input type="checkbox"/> DN		
DN-05			<input type="checkbox"/> Station, <input type="checkbox"/> DN		
DN-06			<input type="checkbox"/> Station, <input type="checkbox"/> DN		
DN-07			<input type="checkbox"/> Station, <input type="checkbox"/> DN		
DN-08			<input type="checkbox"/> Station, <input type="checkbox"/> DN		
DN-09			<input type="checkbox"/> Station, <input type="checkbox"/> DN		
DN-10			<input type="checkbox"/> Station, <input type="checkbox"/> DN		
DN-11			<input type="checkbox"/> Station, <input type="checkbox"/> DN		
DN-12			<input type="checkbox"/> Station, nDN		

PF Key	PF Key Type	Number	DSS Key	DSS Key Type	Number
01			01		
02			02		
03			03		
04			04		
05			05		
06			06		
07			07		
08			08		
09					
10					
12					

EXTENSION-STATION

Station Equipment No.

Item	Set Data
Telephone Type and Model	Type _____ Model _____
OHCA Circuit	<input type="checkbox"/> <input type="checkbox"/>
Primary Directory Number	_____
Intercom Number	---
Station Name	-----
ICM Group	
Pickup Group	_____ <input type="checkbox"/> None
Next Hunt Station	<input type="checkbox"/> _____ <input type="checkbox"/> None
Class of Service	
Data Line Security	<input type="checkbox"/>
Automatic Callback-Trunk	<input type="checkbox"/> Yes, <input type="checkbox"/> <input type="checkbox"/>
Parallel Connect	<input type="checkbox"/> Yes, <input type="checkbox"/> <input type="checkbox"/>

Key	Key Type	Number	SDN COS	Day Ring	Night Ring
DN-01	PDN		<input type="checkbox"/> Station, <input type="checkbox"/> DN		
DN-02			<input type="checkbox"/> Station, <input type="checkbox"/> DN		
DN-03			<input type="checkbox"/> Station, <input type="checkbox"/> DN		
DN-04			<input type="checkbox"/> Station, <input type="checkbox"/> DN		
DN-05			<input type="checkbox"/> Station, <input type="checkbox"/> DN		
DN-06			<input type="checkbox"/> Station, <input type="checkbox"/> DN		
DN-07			<input type="checkbox"/> Station, <input type="checkbox"/> DN		
DN-08			<input type="checkbox"/> Station, <input type="checkbox"/> DN		
DN-09			<input type="checkbox"/> Station, <input type="checkbox"/> DN		
DN-10			<input type="checkbox"/> Station, <input type="checkbox"/> DN		
DN-11			<input type="checkbox"/> Station, <input type="checkbox"/> DN		
DN-12			<input type="checkbox"/> Station, <input type="checkbox"/> DN		

PF Key	PF Key Type	Number	DSS Key	DSS Key Type	Number
01			01		
02			02		
03			03		
04			04		
05			05		
06			06		
07			07		
08			08		
09					
10					
11					
I 12 I					

EXTENSION-STATION

Station Equipment No.

Item	Set Data
Telephone Type and Model	Type _____ Model _____
OHCA Circuit	<input type="checkbox"/> <input type="checkbox"/> No
Primary Directory Number	_____
Intercom Number	_____
Station Name	_____
ICM Group	_____
Pickup Group	_____ <input type="checkbox"/> None
Next Hunt Station	<input type="checkbox"/> _____ <input type="checkbox"/> None
Class of Service	_____
Data Line Security	_____ a y e s , <input type="checkbox"/> No
Automatic Callback-Trunk	<input type="checkbox"/> <input type="checkbox"/>
Parallel Connect	<input type="checkbox"/> <input type="checkbox"/> No

Key	Key Type	Number	SDN COS	Day Ring	Night Ring
DN-01	PDN		<input type="checkbox"/> Station, <input type="checkbox"/> DN		
DN-02			<input type="checkbox"/> Station, <input type="checkbox"/> DN		
DN-03			<input type="checkbox"/> Station, <input type="checkbox"/> DN		
DN-04			<input type="checkbox"/> Station, <input type="checkbox"/> DN		
DN-05			<input type="checkbox"/> Station, <input type="checkbox"/> DN		
DN-06			<input type="checkbox"/> Station, <input type="checkbox"/> DN		
DN-07			<input type="checkbox"/> Station, <input type="checkbox"/> DN		
DN-08			<input type="checkbox"/> Station, <input type="checkbox"/> DN		
DN-09			<input type="checkbox"/> Station, <input type="checkbox"/> DN		
DN-10			<input type="checkbox"/> Station, <input type="checkbox"/> DN		
DN-11			<input type="checkbox"/> Station, nDN		
DN-12			<input type="checkbox"/> Station, nDN		

PF Key	PF Key Type	Number	DSS Key	DSS Key Type	Number
01			01		
02			02		
03			03		
04			04		
05			05		
06			06		
07			07		
08			08		
09					
10					
11					
12					

EXTENSION-STATION

Station Equipment No.







Item	Set Data
Telephone Type and Model	Type _____ Model _____
OHCA Circuit	<input type="checkbox"/> Yes, <input type="checkbox"/> No
Primary Directory Number	_____
Intercom Number	_____
Station Name	_____
ICM Group	_____
Pickup Group	_____ <input type="checkbox"/> None
Next Hunt Station	<input type="checkbox"/> <input type="checkbox"/> None _____
Class of Service	_____
Data Line Security	<input type="checkbox"/> Yes, <input type="checkbox"/> No
Automatic Callback-Trunk	<input type="checkbox"/> <input type="checkbox"/> <input type="checkbox"/> <input type="checkbox"/> No
Parallel Connect	<input type="checkbox"/> Yes, <input type="checkbox"/> No

Key	Key Type	Number	SDN COS	Day Ring	Night Ring
DN-01	PDN		<input type="checkbox"/> Station, <input type="checkbox"/> DN		
DN-02			<input type="checkbox"/> Station, <input type="checkbox"/> DN		
DN-03			<input type="checkbox"/> Station, <input type="checkbox"/> DN		
DN-04			<input type="checkbox"/> Station, <input type="checkbox"/> DN		
DN-05			<input type="checkbox"/> Station, <input type="checkbox"/> DN		
DN-06			<input type="checkbox"/> Station, <input type="checkbox"/> DN		
DN-07			<input type="checkbox"/> Station, <input type="checkbox"/> DN		
DN-08			<input type="checkbox"/> Station, <input type="checkbox"/> DN		
DN-09			<input type="checkbox"/> Station, <input type="checkbox"/> DN		
DN-10			<input type="checkbox"/> Station, <input type="checkbox"/> DN		
DN-11			<input type="checkbox"/> Station, <input type="checkbox"/> DN		
DN-12			<input type="checkbox"/> Station, <input type="checkbox"/> DN		

PF Key	PF Key Type	Number	DSS Key	DSS Key Type	Number
01			01		
02			02		
03			03		
04			04		
05			05		
06			06		
07			07		
08			98		
09					
10					
11					
12					

EXTENSION-STATION

Station Equipment No

Item	Set Data
Telephone Type and Model	Type _____ Model _____
OHCA Circuit ~	<input type="checkbox"/> Yes, <input type="checkbox"/> NO
Primary Directory Number	_____
Intercom Number	_____
Station Name	_____
ICM Group	_____
Pickup Group	<input type="checkbox"/> None
Next Hunt Station	
Class of Service	_____
Data Line Security	<input type="checkbox"/> Yes, <input type="checkbox"/> 
Automatic Callback-Trunk	<input type="checkbox"/>  <input type="checkbox"/> 
Parallel Connect	<input type="checkbox"/>  <input type="checkbox"/> 

Key	Key Type	Number	SDN COS	Day Ring	Night Ring
DN-01	PDN		<input type="checkbox"/> Station, <input type="checkbox"/> DN		
DN-02			<input type="checkbox"/> Station, <input type="checkbox"/> DN		
DN-03			<input type="checkbox"/> Station, <input type="checkbox"/> DN		
DN-04			<input type="checkbox"/> Station, nDN		
w - 0 5			<input type="checkbox"/> Station, <input type="checkbox"/> DN		
DN-06			<input type="checkbox"/> Station, <input type="checkbox"/> DN		
DN-07			<input type="checkbox"/> Station, <input type="checkbox"/> DN		
DN-08			<input type="checkbox"/> Station, DDN		
DN-09			<input type="checkbox"/> Station, <input type="checkbox"/> DN		
DN-10			<input type="checkbox"/> Station, <input type="checkbox"/> DN		
DN-11			<input type="checkbox"/> Station, ODN		
DN-12			<input type="checkbox"/> Station, <input type="checkbox"/> DN		

PF Key	PF Key Type	Number	DSS Key	DSS Key Type	Number
01			01		
0	2		02		
03			03		
04			04		
05			05		
06			06		
07			07		
08			08		
09					
10					
11					
12					

EXTENSION-STATION

Station Equipment No.

Item	Set Data
Telephone Type and Model	Type _____ Model _____
OHCA Circuit	<input type="checkbox"/> <input type="checkbox"/> No
Primary Directory Number	- - - -
Intercom Number	- -
Station Name	_____
ICM Group	_____
Pickup Group	- - <input type="checkbox"/> None
Next Hunt Station	<input type="checkbox"/> _____ <input type="checkbox"/>
Class of Service	- -
Data Line Security	<input type="checkbox"/> Yes, <input type="checkbox"/> No
Automatic Callback-Trunk	<input type="checkbox"/> Yes, <input type="checkbox"/> No
Parallel Connect	<input type="checkbox"/> Yes, <input type="checkbox"/> No

Key	Key Type	Number	SDN COS	Day Ring	Night Ring
DN-01	PDN		<input type="checkbox"/> Station, <input type="checkbox"/> DN		
DN-02			<input type="checkbox"/> Station, <input type="checkbox"/> DN		
DN-03			<input type="checkbox"/> Station, <input type="checkbox"/> DN		
DN-04			<input type="checkbox"/> Station, <input type="checkbox"/> DN		
DN-05			<input type="checkbox"/> Station, <input type="checkbox"/> DN		
DN-06			<input type="checkbox"/> Station, <input type="checkbox"/> DN		
DN-07			<input type="checkbox"/> Station, <input type="checkbox"/> DN		
DN-08			<input type="checkbox"/> Station, <input type="checkbox"/> DN		
DN-09			<input type="checkbox"/> Station, <input type="checkbox"/> DN		
DN-10			<input type="checkbox"/> Station, <input type="checkbox"/> DN		
DN-11			<input type="checkbox"/> Station, <input type="checkbox"/> DN		
DN-12			<input type="checkbox"/> Station, <input type="checkbox"/> DN		

PF Key	PF Key Type	Number
01		
02		
03		
04		
05		
06		
07		
08		
09		
10		
11		
12		

DSS Key	DSS Key Type	Number
01		
02		
03		
04		
05		
06		
07		
08		

EXTENSION-STATION

Station Equipment No.

hem	Set Data
Telephone Type and Model	Type _____ Model _____
OHCA Circuit	<input type="checkbox"/> Yes, <input type="checkbox"/> No
Primary Directory Number	- - - - -
Intercom Number	- -
Station Name	A - - - - -
CM Group	-
Pickup Group	- - - <input type="checkbox"/> None
Next Hun: Station	<input type="checkbox"/> EXT <input type="checkbox"/> None__
Class of Service	- - -
Data Line Security	<input type="checkbox"/> Yes, <input type="checkbox"/> No
Automatic Callback-Trunk	<input type="checkbox"/> Yes, <input type="checkbox"/> No
Parallel Connect	<input type="checkbox"/> Yes, <input type="checkbox"/> No

Key	Key Type	Number	SDN COS	Day Ring	Night Ring
DN-01	PDN		<input type="checkbox"/> Station, <input type="checkbox"/> DN		
DN-02			<input type="checkbox"/> Station, <input type="checkbox"/> DN		
DN-03			<input type="checkbox"/> Station, <input type="checkbox"/> DN		
DN-04			<input type="checkbox"/> Station, <input type="checkbox"/> DN		
DN-05			<input type="checkbox"/> Station, <input type="checkbox"/> DN		
DN-06			<input type="checkbox"/> Station, <input type="checkbox"/> DN		
DN-07			<input type="checkbox"/> Station, <input type="checkbox"/> DN		
DN-08			<input type="checkbox"/> Station, <input type="checkbox"/> DN		
DN-09			<input type="checkbox"/> Station, <input type="checkbox"/> DN		
DN-10			<input type="checkbox"/> Station, <input type="checkbox"/> DN		
DN-11			<input type="checkbox"/> Station, <input type="checkbox"/> DN		
DN-12			<input type="checkbox"/> Station, <input type="checkbox"/> DN		

PF Key	PF Key Type	Number	DSS Key	DSS Key Type	Number
01			01		
02			02		
03			03		
04			04		
05			05		
06			06		
07			07		
08			08		
09					
10					
11					
12					

EXTENSION-STATION

Station Equipment No.

Item	Set Data
Telephone Type and Model	Type _____ Model _____
OHCA Circuit	<input type="checkbox"/> <input type="checkbox"/>
Primary Directory Number	- - - -
Intercom Number	- -
Station Name	_____
ICM Group	_____
Pickup Group	- - <input type="checkbox"/> None
Next Hunt Station	<input type="checkbox"/> <input type="checkbox"/> <input type="checkbox"/> <input type="checkbox"/> <input type="checkbox"/> None
Class of Service	- -
Data Line Security	<input type="checkbox"/> Yes, <input type="checkbox"/> No
Automatic Callback-Trunk	<input type="checkbox"/> Yes, <input type="checkbox"/> No
Parallel Connect	<input type="checkbox"/> <input type="checkbox"/>

Key	Key Type	Number	SDN COS	Day Ring	Night Ring
DN-01	PDN		<input type="checkbox"/> Station, <input type="checkbox"/> DN		
DN-02			<input type="checkbox"/> Station, <input type="checkbox"/> DN		
DN-03			<input type="checkbox"/> Station, <input type="checkbox"/> DN		
DN-04			<input type="checkbox"/> Station, <input type="checkbox"/> DN		
DN-05			<input type="checkbox"/> Station, <input type="checkbox"/> DN		
DN-06			<input type="checkbox"/> Station, <input type="checkbox"/> DN		
DN-07			<input type="checkbox"/> Station, <input type="checkbox"/> DN		
DN-08			<input type="checkbox"/> Station, <input type="checkbox"/> DN		
DN-09			<input type="checkbox"/> Station, <input type="checkbox"/> DN		
DN-10			<input type="checkbox"/> Station, <input type="checkbox"/> DN		
DN-11			<input type="checkbox"/> Station, <input type="checkbox"/> DN		
DN-12			<input type="checkbox"/> Station, <input type="checkbox"/> DN		

PF Key	PF Key Type	Number
01		
02		
03		
04		
05		
06		
07		
08		
09		
10		
11		
12		

DSS Key	DSS Key Type	Number
01		
02		
03		
04		
05		
06		
07		
08		

EXTENSION-STATION

Station Equipment No.

Item	Set Data
T&phone Type and Model	Type _____ Model _____
OHCA Circuit	<input type="checkbox"/> Yes, <input type="checkbox"/> No
Primary Directory Number	_____
Intercom Number	- -
Station Name	_____
ICI! Group	_____
Pickup Group	- - 0 None
Next Hunt Station	<input type="checkbox"/> _____ <input type="checkbox"/> None
Class of Service	- -
Data Line Security	<input type="checkbox"/> <input type="checkbox"/> No
Automatic Callback-Trunk	<input type="checkbox"/> Yes, <input type="checkbox"/> No
Parallel Connect	<input type="checkbox"/> Yes, <input type="checkbox"/> No

Key	Key Type	Number	SDN COS	Day Ring	Night Ring
DN-01	PDN		<input type="checkbox"/> Station, <input type="checkbox"/> DN		
DN-02			<input type="checkbox"/> Station, <input type="checkbox"/> DN		
DN-03			<input type="checkbox"/> Station, <input type="checkbox"/> DN		
DN-04			<input type="checkbox"/> Station, <input type="checkbox"/> DN		
DN-05			<input type="checkbox"/> Station, <input type="checkbox"/> DN		
DN-06			<input type="checkbox"/> Station, <input type="checkbox"/> DN		
DN-07			<input type="checkbox"/> Station, <input type="checkbox"/> DN		
DN-08			<input type="checkbox"/> Station, <input type="checkbox"/> DN		
DN-09			<input type="checkbox"/> Station, <input type="checkbox"/> DN		
DN-10			<input type="checkbox"/> Station, <input type="checkbox"/> DN		
DN-11			<input type="checkbox"/> Station, <input type="checkbox"/> DN		
DN-12			<input type="checkbox"/> Station, <input type="checkbox"/> DN		

PF Key	PF Key Type	Number	DSS Key	DSS Key Type	Number
01			01		
02			02		
03			03		
04			04		
05			05		
06			06		
07			07		
08			08		
09					
10					
11					
12					

EXTENSION-STATION

Station Equipment No.

Item	Set Data
Telephone Type and Model	Type _____ Model _____
OHCA Circuit	<input type="checkbox"/> <input type="checkbox"/> <input type="checkbox"/> <input type="checkbox"/> No
Primary Directory Number	_____
Intercom Number	_____
Station Name	-----
ICM Group	_____
Pickup Group	- - <input type="checkbox"/> None
Next Hunt Station	<input type="checkbox"/> EXT <input type="checkbox"/> N o n e
Class of Service	- -
Data-Line Security	a y e s , <input type="checkbox"/> No
Automatic Callback-Trunk	<input type="checkbox"/> Yes, <input type="checkbox"/> No
Parallel Connect	<input type="checkbox"/> <input type="checkbox"/> <input type="checkbox"/> No

Key	Key Type	Number	SDN COS	Day Ring	Night Ring
DN-01	PDN		<input type="checkbox"/> Station, <input type="checkbox"/> DN		
DN-02			<input type="checkbox"/> Station, <input type="checkbox"/> DN		
DN-03			<input type="checkbox"/> Station, <input type="checkbox"/> DN		
DN-04			<input type="checkbox"/> Station, <input type="checkbox"/> DN		
DN-05			<input type="checkbox"/> Station, <input type="checkbox"/> DN		
DN-06			<input type="checkbox"/> Station, <input type="checkbox"/> DN		
DN-07			<input type="checkbox"/> Station, <input type="checkbox"/> DN		
DN-08			<input type="checkbox"/> Station, <input type="checkbox"/> DN		
DN-09			<input type="checkbox"/> Station, <input type="checkbox"/> DN		
DN-10			<input type="checkbox"/> Station, <input type="checkbox"/> DN		
DN-11			<input type="checkbox"/> Station, <input type="checkbox"/> DN		
DN-12			<input type="checkbox"/> Station, <input type="checkbox"/> DN		

PF Key	PF Key Type	Number	DSS Key	DSS Key Type	Number
01			01		
02			02		
I 03 I			03		
04			04		
05			05		
0 6			06		
07			07		
08			08		
09					
10					
1 1					
12					

EXTENSION-STATION

Station Equipment No.

Item	Set Data
Telephone Type and Model	Type _____ Model _____
OHCA Circuit	<input type="checkbox"/> Yes, <input type="checkbox"/> No
Primary Directory Number	_____
Intercom Number	_____
Station Name	-----
ICMGroup	_____
Pickup Group	- - - <input type="checkbox"/> None
Next Hunt Station	<input type="checkbox"/> EXT _____ <input type="checkbox"/> None
Class of Service	- - -
Data Line Security	<input type="checkbox"/> Yes, <input type="checkbox"/> No
Automatic Callback-Trunk	<input type="checkbox"/> Yes, <input type="checkbox"/> No
Parallel Connect	<input type="checkbox"/> <input type="checkbox"/> <input type="checkbox"/> <input type="checkbox"/>

Key	Key Type	Number	SDN COS	Day Ring	Night Ring
DN-01	PDN		<input type="checkbox"/> Station, <input type="checkbox"/> DN		
DN-02			<input type="checkbox"/> Station, <input type="checkbox"/> DN		
DN-03			<input type="checkbox"/> Station, <input type="checkbox"/> DN		
DN-04			<input type="checkbox"/> Station, <input type="checkbox"/> DN		
DN-05			<input type="checkbox"/> Station, <input type="checkbox"/> DN		
DN-06			<input type="checkbox"/> Station, <input type="checkbox"/> DN		
DN-07			<input type="checkbox"/> Station, <input type="checkbox"/> DN		
DN-08			<input type="checkbox"/> Station, <input type="checkbox"/> DN		
DN-09			<input type="checkbox"/> Station, <input type="checkbox"/> DN		
DN-10			<input type="checkbox"/> Station, <input type="checkbox"/> DN		
DN-11			<input type="checkbox"/> Station, <input type="checkbox"/> DN		
DN-12			<input type="checkbox"/> Station, <input type="checkbox"/> DN		

PF Key	PF Key Type	Number
01		
02		
03		
04		
05		
06		
07		
08		
09		
10		
11		
12		

DSS Key	DSS Key Type	Number
01		
02		
03		
04		
05		
06		
07		
08		

EXTENSION-STATION

Station Equipment No.

Item	Set Data
Telephone Type and Model	Type _____ Model _____
OHCA Circuit	<input type="checkbox"/> Yes, <input type="checkbox"/> No
Primary Directory Number	_____
Intercom Number	_____
Station Name	_____
ICM Group	_____
Pickup Group	- - <input type="checkbox"/> None
Next Hunt Station	<input type="checkbox"/> _____ <input type="checkbox"/> None
Class of Service	_____
Data Line Security	<input type="checkbox"/> <input type="checkbox"/> No
Automatic Callback-Trunk	<input type="checkbox"/> Yes, <input type="checkbox"/> No
Parallel Connect	<input type="checkbox"/> Yes, <input type="checkbox"/> <input type="checkbox"/>

Key	Key Type	Number	SDN COS	Day Ring	Night Ring
DN-01	PDN		<input type="checkbox"/> Station, <input type="checkbox"/> DN		
DN-02			<input type="checkbox"/> Station, <input type="checkbox"/> DN		
DN-03			<input type="checkbox"/> Station, <input type="checkbox"/> DN		
DN-04			<input type="checkbox"/> Station, <input type="checkbox"/> DN		
DN-05			<input type="checkbox"/> Station, <input type="checkbox"/> DN		
DN-06			<input type="checkbox"/> Station, <input type="checkbox"/> DN		
DN-07			<input type="checkbox"/> Station, <input type="checkbox"/> DN		
DN-08			<input type="checkbox"/> Station, <input type="checkbox"/> DN		
DN-09			<input type="checkbox"/> Station, <input type="checkbox"/> DN		
DN-10			<input type="checkbox"/> Station, <input type="checkbox"/> DN		
DN-11			<input type="checkbox"/> Station, <input type="checkbox"/> DN		
DN-12			<input type="checkbox"/> Station, <input type="checkbox"/> DN		

PF Key	PF Key Type	Number	DSS Key	DSS Key Type	Number
01			01		
02			02		
03			03		
04			04		
05			05		
06			06		
07			07		
08			08		
09					
10					
11					
12					

EXTENSION-STATION

Station Equipment No.

Item	Set Data
Telephone Type and Model	Type _____ Model _____
OHCA Circuit	<input type="checkbox"/> <input type="checkbox"/> No
Primary Directory Number	_____
Intercom Number	_____
Station Name	_____
ICM Group	_____
Pickup Group	- - <input type="checkbox"/> None
Next Hunt Station	<input type="checkbox"/> _____ <input type="checkbox"/> None
Class of Service	_____
Data Line Security	<input type="checkbox"/> <input type="checkbox"/>
Automatic Callback-Trunk	<input type="checkbox"/> Yes, <input type="checkbox"/> No
Parallel Connect	<input type="checkbox"/> Yes, <input type="checkbox"/>

Key	Key Type	Number	SDN COS	Day Ring	Night Ring
DN-01	PDN		<input type="checkbox"/> Station, <input type="checkbox"/> DN		
ON-02			<input type="checkbox"/> Station.nDN		
DN-03			<input type="checkbox"/> Station, <input type="checkbox"/> DN		
DN-04			<input type="checkbox"/> Station, <input type="checkbox"/> DN		
DN-05			<input type="checkbox"/> Station, <input type="checkbox"/> DN		
ON-06			<input type="checkbox"/> Station, <input type="checkbox"/> DN		
DN-07			<input type="checkbox"/> Station, <input type="checkbox"/> DN		
DN-08			<input type="checkbox"/> Station.qDN		
DN-09			<input type="checkbox"/> Station, <input type="checkbox"/> DN		
DN-10			<input type="checkbox"/> Station, <input type="checkbox"/> DN		
ON-1 1			<input type="checkbox"/> Stator, <input type="checkbox"/> DN		
DN-12			<input type="checkbox"/> Stator.l]DN		

PF Key	PF Key Type	Number	DSS Key	DSS Key Type	Number
01			01		
02			02		
03			03		
04			04		
05			05		
06			06		
07			07		
08			08		
09					
10					
11					
12					

EXTENSION-STATION

Station Equipment No.

Item	Set Data
Telephone Type and Model	Type _____ Model _____
OHCA Circuit	<input type="checkbox"/> Yes, <input type="checkbox"/> &
Primary Directory Number	- - - -
Intercom Number	- -
Station Name	- - - - - - - - - -
ICM Group	---
Pickup Group	- - <input type="checkbox"/> None
Next Hunt Station	<input type="checkbox"/> <input type="checkbox"/> None
Class of Service	- -
Data Line Security	<input type="checkbox"/> Yes, <input type="checkbox"/> No
Automatic Callback-Trunk	<input type="checkbox"/> Yes, <input type="checkbox"/> No
Parallel Connect	<input type="checkbox"/> Yes, <input type="checkbox"/> No

Key	Key Type	Number	SDN COS	Day Ring	Night Ring
DN-01	PDN		<input type="checkbox"/> Station, <input type="checkbox"/> DN		
DN-02			<input type="checkbox"/> Station, <input type="checkbox"/> DN		
DN-03			<input type="checkbox"/> Station, <input type="checkbox"/> DN		
DN-04			<input type="checkbox"/> Station, <input type="checkbox"/> DN		
DN-05			<input type="checkbox"/> Station, <input type="checkbox"/> DN		
DN-06			<input type="checkbox"/> Station, <input type="checkbox"/> DN		
DN-07			<input type="checkbox"/> Station, <input type="checkbox"/> DN		
DN-08			<input type="checkbox"/> Station, <input type="checkbox"/> DN		
DN-09			<input type="checkbox"/> Station, <input type="checkbox"/> DN		
DN-10			<input type="checkbox"/> Station, <input type="checkbox"/> DN		
DN-11			<input type="checkbox"/> Station, <input type="checkbox"/> DN		
DN-12			<input type="checkbox"/> Station, <input type="checkbox"/> DN		

PF Key	PF Key Type	Number
01		
02		
03		
04		
05		
06		
07		
08		
09		
10		
11		
12		

DSS Key	DSS Key Type	Number
01		
02		
03		
04		
05		
06		
07		
08		

EXTENSION-STATION

Station Equipment No.

Item	Set Data
Telephone Type and Model	Type _____ Model _____
OHCA Circuit	<input type="checkbox"/> Yes, <input type="checkbox"/> No
Primary Directory Number	_____
Intercom Number	_____
Station Name	_____
ICM Group	_____
Pickup Group	_____ <input type="checkbox"/> None
Next Hunt Station	<input type="checkbox"/> _____ <input type="checkbox"/> None
Class of Service	_____
Data Line Security	_____ a y e s , <input type="checkbox"/> No
Automatic Callback-Trunk	<input type="checkbox"/> Yes, <input type="checkbox"/> <input type="checkbox"/>
Parallel Connect	<input type="checkbox"/> <input type="checkbox"/> <input type="checkbox"/>

Key	Key Type	Number	SDN COS	Day Ring	Night Ring
DN-01	PDN		<input type="checkbox"/> Station, <input type="checkbox"/> ODN		
DN-02			<input type="checkbox"/> Station, <input type="checkbox"/> DN		
DN-03			<input type="checkbox"/> Station, <input type="checkbox"/> DN		
DN-04			<input type="checkbox"/> Station, <input type="checkbox"/> DN		
DN-05			<input type="checkbox"/> Station, <input type="checkbox"/> DN		
DN-06			<input type="checkbox"/> Station, <input type="checkbox"/> DN		
DN-07			<input type="checkbox"/> Station, <input type="checkbox"/> DN		
DN-08			<input type="checkbox"/> Station, <input type="checkbox"/> ODN		
DN-09			<input type="checkbox"/> Station, <input type="checkbox"/> DN		
DN-10			<input type="checkbox"/> Station, <input type="checkbox"/> DN		
DN-11			<input type="checkbox"/> Station, <input type="checkbox"/> DN		
DN-12			<input type="checkbox"/> Station, <input type="checkbox"/> DN		

PF Key	PF Key Type	Number	DSS Key	DSS Key Type	Number
01			01		
02			02		
03			03		
04			04		
05			05		
06			06		
07			07		
08			08		
09					
10					
11					
12					

EXTENSION-STATION

Station Equipment No.

Item	Set Data
Telephone Type and Model	Type _____ Model _____
OHCA Circuit-	<input type="checkbox"/> Yes, <input type="checkbox"/> X <input type="checkbox"/>
Primary Directory Number	_____
Intercom Number	_____
Station Name	_____
ICM Group	_____
Pickup Group	_____ <input type="checkbox"/> None
Next Hunt Station	<input type="checkbox"/> EXT <input type="checkbox"/> None _____
Class of Service	_____
Data Line Security	<input type="checkbox"/> Yes, <input type="checkbox"/> X <input type="checkbox"/>
Automatic Callback-Trunk	<input type="checkbox"/> Yes, <input type="checkbox"/> No
Parallel Connect	<input type="checkbox"/> Yes, <input type="checkbox"/> No

Key	Key Type	Number	SDN COS	Day Ring	Night Ring
DN-01	PDN		<input type="checkbox"/> Station, <input type="checkbox"/> DN		
DN-02			<input type="checkbox"/> Station, <input type="checkbox"/> DN		
DN-03			<input type="checkbox"/> Station, <input type="checkbox"/> DN		
DN-04			<input type="checkbox"/> Station, <input type="checkbox"/> DN		
DN-05			<input type="checkbox"/> Station, <input type="checkbox"/> DN		
DN-06			<input type="checkbox"/> Station, <input type="checkbox"/> DN		
DN-07			<input type="checkbox"/> Station, <input type="checkbox"/> DN		
DN-08			<input type="checkbox"/> Station, <input type="checkbox"/> DN		
DN-09			<input type="checkbox"/> Station, <input type="checkbox"/> DN		
DN-10			<input type="checkbox"/> Station, <input type="checkbox"/> DN		
DN-11			<input type="checkbox"/> Station, <input type="checkbox"/> DN		
DN-12			<input type="checkbox"/> Station, <input type="checkbox"/> DN		

PF Key	PF Key Type	Number	DSS Key	DSS Key Type	Number
01			01		
02			02		
03			03		
04			04		
05			05		
06			06		
07			07		
08			08		
09					
10					
11					
12					

EXTENSION—STATION

Station Equipment No.

Item	Set Data
Telephone Type and Model	Type _____ Model _____
OHCA Circuit	<input type="checkbox"/> Yes, <input type="checkbox"/> No
Primary Directory Number	_____
Intercom Number	---
Station Name	_____
ICM Group	—
Pickup Group	___ <input type="checkbox"/> None
Next Hunt Station	<input type="checkbox"/> EXT _____ <input type="checkbox"/> None
Class of Service	---
Data Line Security	<input type="checkbox"/> Yes, <input type="checkbox"/> No
Automatic Callback-Trunk	<input type="checkbox"/> Yes, <input type="checkbox"/> No
Parallel Connect	<input type="checkbox"/> Yes, <input type="checkbox"/> No

Key	Key Type	Number	SDN COS	Day Ring	Night Ring
DN-01	PDN		<input type="checkbox"/> Station, <input type="checkbox"/> DN		
DN-02			<input type="checkbox"/> Station, <input type="checkbox"/> DN		
DN-03			<input type="checkbox"/> Station, <input type="checkbox"/> DN		
DN-04			<input type="checkbox"/> Station, <input type="checkbox"/> DN		
DN-05			<input type="checkbox"/> Station, <input type="checkbox"/> DN		
DN-06			<input type="checkbox"/> Station, <input type="checkbox"/> DN		
DN-07			<input type="checkbox"/> Station, <input type="checkbox"/> DN		
DN-08			<input type="checkbox"/> Station, <input type="checkbox"/> DN		
DN-09			<input type="checkbox"/> Station, <input type="checkbox"/> DN		
DN-10			<input type="checkbox"/> Station, <input type="checkbox"/> DN		
DN-11			<input type="checkbox"/> Station, <input type="checkbox"/> DN		
DN-12			<input type="checkbox"/> Station, <input type="checkbox"/> DN		

PF Key	PF Key Type	Number
01		
02		
03		
04		
05		
06		
07		
08		
09		
10		
11		
12		

DSS Key	DSS Key Type	Number
01		
02		
03		
04		
05		
06		
07		
08		

EXTENSION—STATION

Station Equipment No.

Item	Set Data
Telephone Type and Model	Type _____ Model _____
OHCA Circuit	<input type="checkbox"/> Yes, <input type="checkbox"/> No
Primary Directory Number	_____
Intercom Number	---
Station Name	_____
ICM Group	---
Pickup Group	_____ <input type="checkbox"/> None
Next Hunt Station	<input type="checkbox"/> EXT _____ <input type="checkbox"/> None
Class of Service	---
Data Line Security	<input type="checkbox"/> Yes, <input type="checkbox"/> No
Automatic Callback—Trunk	<input type="checkbox"/> Yes, <input type="checkbox"/> No
Parallel Connect	<input type="checkbox"/> Yes, <input type="checkbox"/> No

Key	Key Type	Number	SDN COS	Day Ring	Night Ring
DN-01	PDN		<input type="checkbox"/> Station, <input type="checkbox"/> DN		
DN-02			<input type="checkbox"/> Station, <input type="checkbox"/> DN		
DN-03			<input type="checkbox"/> Station, <input type="checkbox"/> DN		
DN-04			<input type="checkbox"/> Station, <input type="checkbox"/> DN		
DN-05			<input type="checkbox"/> Station, <input type="checkbox"/> DN		
DN-06			<input type="checkbox"/> Station, <input type="checkbox"/> DN		
DN-07			<input type="checkbox"/> Station, <input type="checkbox"/> DN		
DN-08			<input type="checkbox"/> Station, <input type="checkbox"/> DN		
DN-09			<input type="checkbox"/> Station, <input type="checkbox"/> DN		
DN-10			<input type="checkbox"/> Station, <input type="checkbox"/> DN		
DN-11			<input type="checkbox"/> Station, <input type="checkbox"/> DN		
DN-12			<input type="checkbox"/> Station, <input type="checkbox"/> DN		

PF Key	PF Key Type	Number
01		
02		
03		
04		
05		
06		
07		
08		
09		
10		
11		
12		

DSS Key	DSS Key Type	Number
01		
02		
03		
04		
05		
06		
07		
08		

EXTENSION-STATION

Station Equipment No.

Item	Set Data
Telephone Type and Model	Type _____ Model _____
OHCA Circuit-	<input type="checkbox"/> Yes, <input type="checkbox"/> No
Primary Directory Number	- - - -
Intercom Number	- -
Station Name	- - - - - - - - - -
ICM Group	-
Pickup Group	- - <input type="checkbox"/> None
Next Hunt Station	<input type="checkbox"/> _____ <input type="checkbox"/> None
Class of Service	- -
Data Line Security	<input type="checkbox"/> Yes, <input type="checkbox"/> <input type="checkbox"/>
Automatic Callback-Trunk	<input type="checkbox"/> Yes, <input type="checkbox"/> No
Parallel Connect	<input type="checkbox"/> Yes, <input type="checkbox"/> No

Key	Key Type	Number	SDN COS	Day Ring	Night Ring
DN-01	PDN		<input type="checkbox"/> Station, <input type="checkbox"/> DN		
DN-02			<input type="checkbox"/> Station, <input type="checkbox"/> DN		
DN-03			<input type="checkbox"/> Station, <input type="checkbox"/> DN		
DN-04			<input type="checkbox"/> Station, <input type="checkbox"/> DN		
DN-05			<input type="checkbox"/> Station, <input type="checkbox"/> DN		
DN-06			<input type="checkbox"/> Station, <input type="checkbox"/> DN		
DN-07			<input type="checkbox"/> Station, <input type="checkbox"/> DN		
DN-08			<input type="checkbox"/> Station, <input type="checkbox"/> DN		
DN-09			<input type="checkbox"/> Station, <input type="checkbox"/> DN		
DN-10			<input type="checkbox"/> Station, <input type="checkbox"/> DN		
DN-11			<input type="checkbox"/> Station, <input type="checkbox"/> DN		
DN-12			<input type="checkbox"/> Station, <input type="checkbox"/> DN		

PF Key	PF Key Type	Number
01		
02		
03		
04		
05		
06		
07		
08		
09		
10		
11		
12		

DSS Key	DSS Key Type	Number
01		
02		
03		
04		
05		
06		
07		
08		

EXTENSION-STATION

Station Equipment No.

Item	Set Data
Telephone Type and Model	Type _____ Model _____
OHCA Circuit	<input type="checkbox"/> <input type="checkbox"/> No
Primary Director-j Number	_____
Intercom Number	_____
Station Name	_____
ICM Group	_____
Pickup Group	_____ <input type="checkbox"/> None
Next Hunt Station	<input type="checkbox"/> _____ <input type="checkbox"/> None
Class of Service	_____
Data Line Security	<input type="checkbox"/> Yes, <input type="checkbox"/> No
Automatic Callback-Trunk	<input type="checkbox"/> Yes, <input type="checkbox"/> No
Parallel Connect	<input type="checkbox"/> Yes, <input type="checkbox"/> No

Key	Key Type	Number	SDN COS	Day Ring	Night Ring
DN-01	PDN		<input type="checkbox"/> Station, <input type="checkbox"/> DN		
DN-02			<input type="checkbox"/> Station, <input type="checkbox"/> DN		
DN-03			<input type="checkbox"/> Station, <input type="checkbox"/> DN		
DN-04			<input type="checkbox"/> Station, <input type="checkbox"/> DN		
DN-05			<input type="checkbox"/> Station, <input type="checkbox"/> DN		
DN-06			<input type="checkbox"/> Station, <input type="checkbox"/> DN		
DN-07			<input type="checkbox"/> Station, <input type="checkbox"/> DN		
DN-08			<input type="checkbox"/> Station, <input type="checkbox"/> DN		
DN-09			<input type="checkbox"/> Station, <input type="checkbox"/> DN		
DN-10			<input type="checkbox"/> Station, <input type="checkbox"/> DN		
DN-11			<input type="checkbox"/> Station, <input type="checkbox"/> DN		
DN-12			<input type="checkbox"/> Station, <input type="checkbox"/> DN		

PF Key	PF Key Type	Number
01		
02		
03		
04		
05		
06		
07		
08		
09		
10		
11		
12		

DSS Key	DSS Key Type	Number
01		
02		
03		
04		
05		
06		
07		
08		

EXTENSION-STATION

Station Equipment No.

Item	Set Data
Telephone Type and Model	Type _____ Model _____
OHCA Circuit	<input type="checkbox"/> Yes, <input type="checkbox"/> No
Primary Directory Number	_____
Intercom Number	- -
Station Name	_____
ICM Group	_____
Pickup Group	- - <input type="checkbox"/> None
Next Hunt Station	<input type="checkbox"/> _____ <input type="checkbox"/> None
Class of Service	- -
Data Line Security	<input type="checkbox"/> <input type="checkbox"/> <input type="checkbox"/> <input type="checkbox"/>
Automatic Callback-Trunk	<input type="checkbox"/> Yes, <input type="checkbox"/> No
Parallel Connect	<input type="checkbox"/> Yes, <input type="checkbox"/> <input type="checkbox"/>

Key	Key Type	Number	SDNCOS	Day Ring	Night Ring
DN-01	PDN		<input type="checkbox"/> Station, <input type="checkbox"/> DN		
DN-02			<input type="checkbox"/> Station, <input type="checkbox"/> DN		
DN-03			<input type="checkbox"/> Station, <input type="checkbox"/> DN		
DN-04			<input type="checkbox"/> Station, <input type="checkbox"/> DN		
DN-05			<input type="checkbox"/> Station.nDN		
DN-06			<input type="checkbox"/> Station, <input type="checkbox"/> DN		
DN-07			<input type="checkbox"/> StationJJDN		
DN-08			<input type="checkbox"/> JStationJJDN		
DN-09			<input type="checkbox"/> Station, <input type="checkbox"/> DN		
DN-10			<input type="checkbox"/> Station, <input type="checkbox"/> DN		
DN-11			<input type="checkbox"/> Station, <input type="checkbox"/> DN		
DN-12			<input type="checkbox"/> Station,ODN		

PF Key	PF Key Type	Number
01		
02		
03		
04		
05		
06		
07		
08		
09		
10		
11		
12		

DSS Key	DSS Key Type	Number
01		
02		
03		
04		
05		
06		
07		
08		

EXTENSION-STATION

Station Equipment No.

Item	Set Data
Telephone Type and Model	Type _____ Model _____
OHCA circuit	<input type="checkbox"/> <input type="checkbox"/> No
Primary Directory Number	_____
Intercom Number	_____
Station Name	_____
ICM Group	_____
Pickup Group	- - <input type="checkbox"/> None
Next Hunt Station	<input type="checkbox"/> <input type="checkbox"/> None
Class of Service	- -
Data Line Security	<input type="checkbox"/> Yes, <input type="checkbox"/> No
Automatic Callback-Trunk	<input type="checkbox"/> <input type="checkbox"/> No
Parallel Connect	<input type="checkbox"/> <input type="checkbox"/> No

Key	Key Type	Number	SDN COS	Day Ring	Night Ring
DN-01	PDN		<input type="checkbox"/> Station,ODN		
DN-02			<input type="checkbox"/> Station,nDN		
ON-03			<input type="checkbox"/> Station, <input type="checkbox"/> DN		
DN-04			<input type="checkbox"/> Station,C DN		
DN-05			<input type="checkbox"/> Station, <input type="checkbox"/> DN		
DN-06			<input type="checkbox"/> Station, <input type="checkbox"/> DN		
DN-07			<input type="checkbox"/> Station, <input type="checkbox"/> DN		
DN-08			<input type="checkbox"/> Station, <input type="checkbox"/> DN		
DN-09			<input type="checkbox"/> Station, <input type="checkbox"/> DN		
DN-10			<input type="checkbox"/> Station, <input type="checkbox"/> DN		
DN-11			<input type="checkbox"/> Station, <input type="checkbox"/> DN		
DN-12			<input type="checkbox"/> Station, <input type="checkbox"/> DN		

PF Key	PF Key Type	Number	DSS Key	DSS Key Type	Number
01			01		
02			02		
03			03		
04			04		
05			05		
06			06		
07			07		
08			08		
09					
10					
11					
12					

EXTENSION-STATION

Station Equipment No.

Item	Set Data
Telephone Type and Model	Type _____ Model _____
QHCA Circuit ..	<input type="checkbox"/> Yes, <input type="checkbox"/> No
Primary Directory Number	_____
Intercom Number	_____
Station Name	_____
ICM Group	_____
Pickup Group	_____ <input type="checkbox"/> None
Next Hunt Station	<input type="checkbox"/> EXT <input type="checkbox"/> None _____
Class of Service	_____
Data Line Security	<input type="checkbox"/> Yes, <input type="checkbox"/> No
Automatic Callback-Trunk	<input type="checkbox"/> Yes, <input type="checkbox"/> No
Parallel Connect	<input type="checkbox"/> Yes, <input type="checkbox"/> No

Key	Key Type	Number	SDNCOS	Day Ring	Night Ring
DN-01	PDN		<input type="checkbox"/> Station, <input type="checkbox"/> DN		
DN-02			<input type="checkbox"/> Station, <input checked="" type="checkbox"/> DN		
DN-03			<input type="checkbox"/> Station, <input type="checkbox"/> DN		
ON-04			<input type="checkbox"/> Station, <input type="checkbox"/> DN		
ON-05			<input type="checkbox"/> Station, <input checked="" type="checkbox"/> DN		
ON-06			<input type="checkbox"/> Station, <input type="checkbox"/> DN		
ON-07			<input type="checkbox"/> Station, <input type="checkbox"/> DN		
ON-08			<input type="checkbox"/> Station, <input checked="" type="checkbox"/> DN		
DN-09			<input type="checkbox"/> Station, <input type="checkbox"/> DN		
DN-10			<input type="checkbox"/> Station, <input type="checkbox"/> DN		
ON-11			<input checked="" type="checkbox"/> Station, <input type="checkbox"/> DN		
ON-12			<input checked="" type="checkbox"/> Station, <input type="checkbox"/> DN		

PF Key	PF Key Type	Number	DSS Key	DSS Key Type	Number
01			01		
02			02		
03			03		
04			04		
05			05		
06			06		
07			07		
08			08		
09					
10					
11					
12					

EXTENSION-STATION

Station Equipment No.

Item	Set Data
Telephone Type and Model	Type _____ Model _____
OHCA Circuit	<input type="checkbox"/> Yes, <input type="checkbox"/> No
Primary Directory Number	_____
Intercom Number	_____
Station Name	_____
ICM Group	_____
Pickup Group	_____ <input type="checkbox"/> None
Next Hunt Station	<input type="checkbox"/> EXT _____ <input type="checkbox"/> None
Class of Service	_____
Data Line Security	<input type="checkbox"/> Yes, <input type="checkbox"/> No
Automatic Callback-Trunk	<input type="checkbox"/> Yes, <input type="checkbox"/> No
Parallel Connect	<input type="checkbox"/> Yes, <input type="checkbox"/> No

Key	Key Type	Number	SDN COS	Day Ring	Night Ring
DN-01	PDN		<input type="checkbox"/> Station, <input type="checkbox"/> DN		
DN-02			<input type="checkbox"/> Station, <input type="checkbox"/> DN		
DN-03			<input type="checkbox"/> Station, <input type="checkbox"/> DN		
DN-04			<input type="checkbox"/> Station, <input type="checkbox"/> DN		
DN-05			<input type="checkbox"/> Station, <input type="checkbox"/> DN		
DN-06			<input type="checkbox"/> Station, <input type="checkbox"/> DN		
DN-07			<input type="checkbox"/> Station, <input type="checkbox"/> DN		
DN-08			<input type="checkbox"/> Station, <input type="checkbox"/> DN		
DN-09			<input type="checkbox"/> Station, <input type="checkbox"/> DN		
DN-10			<input type="checkbox"/> Station, <input type="checkbox"/> DN		
DN-11			<input type="checkbox"/> Station, <input type="checkbox"/> DN		
DN-12			<input type="checkbox"/> Station, <input type="checkbox"/> DN		

PF Key	PF Key Type	Number
01		
02		
03		
04		
05		
06		
07		
08		
09		
10		
11		
12		

DSS Key	DSS Key Type	Number
01		
02		
03		
04		
05		
06		
07		
08		

EXTENSION-STATION

Station Equipment No.

Item	Set Data
Telephone Type and Model	Type _____ Model _____
OHCA Circuit	<input type="checkbox"/> <input type="checkbox"/> <input type="checkbox"/> <input type="checkbox"/> <input type="checkbox"/> No
Primary Directory Number	_____
Intercom Number	_____
Station Name	_____
ICM Group	
Pickup Group	_____ <input type="checkbox"/> None
Next Hunt Station	<input type="checkbox"/> EXT <input type="checkbox"/> None
Class of Service	_____
Data Line Security	Yes, <input type="checkbox"/> No
Automatic Callback-Trunk	<input type="checkbox"/> <input type="checkbox"/> <input type="checkbox"/> <input type="checkbox"/> No
Parallel Connect	<input type="checkbox"/> Yes, <input type="checkbox"/> No

Key	Key Type	Number	SDN COS	Day Ring	Night Ring
DN-01	PDN		<input type="checkbox"/> Station, <input type="checkbox"/> DN		
DN-02			<input type="checkbox"/> Station, <input type="checkbox"/> DN		
DN-03			<input type="checkbox"/> Station, <input type="checkbox"/> DN		
DN-04			<input type="checkbox"/> Station, <input type="checkbox"/> DN		
DN-05			<input type="checkbox"/> Station, <input type="checkbox"/> DN		
DN-06			<input type="checkbox"/> Station, <input type="checkbox"/> DN		
DN-07			<input type="checkbox"/> Station, <input type="checkbox"/> DN		
DN-08			<input type="checkbox"/> Station, <input type="checkbox"/> DN		
DN-09			<input type="checkbox"/> Station, <input type="checkbox"/> DN		
DN-10			<input type="checkbox"/> Station, <input type="checkbox"/> DN		
DN-11			<input type="checkbox"/> Station, <input type="checkbox"/> DN		
DN-12			<input type="checkbox"/> Station, <input type="checkbox"/> DN		

PF Key	PF Key Type	Number
01		
02		
03		
04		
05		
06		
07		
08		
09		
10		
11		
12		

DSS Key	DSS Key Type	Number
01		
02		
03		
04		
05		
06		
07		
08		

EXTENSION-STATION

Station Equipment No.

Item	Set Data
Telephone Type and Model	Type _____ Model _____
OHCA Circuit	<input type="checkbox"/> Yes, <input type="checkbox"/> No
Primary Directory Number	- - - - -
Intercom Number	- -
Station Name	- - - - -
ICM Group	-
Pickup Group	- - - <input type="checkbox"/> None
Next Hunt Station	<input type="checkbox"/> EXT <input type="checkbox"/> None _____
Class of Service	- -
Data Line Security	<input type="checkbox"/> Yes, <input type="checkbox"/> No
Automatic Callback-Trunk	<input type="checkbox"/> Yes, <input type="checkbox"/> No
Parallel Connect	<input type="checkbox"/> Yes, <input type="checkbox"/> No

Key	Key Type	Number	SDN COS	Day Ring	Night Ring
DN-01	PDN		<input type="checkbox"/> Station, <input type="checkbox"/> DN		
DN-02			<input type="checkbox"/> Station, <input type="checkbox"/> DN		
DN-03			<input type="checkbox"/> Station, <input type="checkbox"/> DN		
DN-04			<input type="checkbox"/> Station, <input type="checkbox"/> DN		
DN-05			<input type="checkbox"/> Station, <input type="checkbox"/> DN		
DN-06			<input type="checkbox"/> Station, <input type="checkbox"/> DN		
DN-07			<input type="checkbox"/> Station, <input type="checkbox"/> DN		
DN-08			<input type="checkbox"/> Station, <input type="checkbox"/> DN		
DN-09			<input type="checkbox"/> Station, <input type="checkbox"/> DN		
DN-10			<input type="checkbox"/> Station, <input type="checkbox"/> DN		
DN-11			<input type="checkbox"/> Station, <input type="checkbox"/> DN		
DN-12			<input type="checkbox"/> Station, <input type="checkbox"/> DN		

PF Key	PF Key Type	Number	DSS Key	DSS Key Type	Number
01			01		
02			02		
03			03		
04			04		
05			05		
06			06		
07			07		
08			08		
09					
10					
11					
12					

EXTENSION-STATION

Station Equipment No.

Item	Set Data
Telephone Type and Model	Type _____ Model _____
OHCA Circuit	<input type="checkbox"/> Yes, <input type="checkbox"/> No
Primary Director Number	_____
Intercom Number	_____
Station Name	_____
ICM Group	_____
Pickup Group	_____ 0 None
Next Hunt Station	<input type="checkbox"/> EXT _____ <input type="checkbox"/> None
Class of Service	_____
Data Line Security	<input type="checkbox"/> Yes, <input type="checkbox"/> No
Automatic Callback-Trunk	<input type="checkbox"/> Yes, <input type="checkbox"/> No
Parallel Connect	<input type="checkbox"/> Yes, <input type="checkbox"/> No

Key	Key Type	Number	SDN COS	Day Ring	Night Ring
DN-01	PDN		<input type="checkbox"/> Station, <input type="checkbox"/> DN		
DN-02			<input type="checkbox"/> Station, <input type="checkbox"/> DN		
DN-03			<input type="checkbox"/> Station, <input type="checkbox"/> DN		
DN-04			<input type="checkbox"/> Station, <input type="checkbox"/> DN		
DN-05			<input type="checkbox"/> Station, <input type="checkbox"/> DN		
DN-06			<input type="checkbox"/> Station, <input type="checkbox"/> DN		
DN-07			<input type="checkbox"/> Station, <input type="checkbox"/> DN		
DN-08			<input type="checkbox"/> Station, <input type="checkbox"/> DN		
DN-09			<input type="checkbox"/> Station, <input type="checkbox"/> DN		
DN-10			<input type="checkbox"/> Station, <input type="checkbox"/> DN		
DN-11			<input type="checkbox"/> Station, <input type="checkbox"/> DN		
DN-12			<input type="checkbox"/> Station, <input type="checkbox"/> DN		

PF Key	PF Key Type	Number
01		
02		
03		
04		
05		
06		
07		
08		
09		
10		
11		
12		

DSS Key	DSS Key Type	Number
01		
02		
03		
04		
05		
06		
07		
08		

EXTENSION-STATION

Station Equipment No. _____

Item	Set Data
Telephone Type and Model	Type _____ Model _____
OHCA C-suit	<input type="checkbox"/> Yes, <input type="checkbox"/> No
Primary Director Number	_____
Intercom Number	_____
Station Name	_____
ICM Group	_____
Pickup Group	_____ <input type="checkbox"/> None
Next Hur. Station	<input type="checkbox"/> EXT _____ <input type="checkbox"/> None
Class of Service	_____
Data Line Security	<input type="checkbox"/> Yes, <input type="checkbox"/> No
Automatic Callback-Trunk	<input type="checkbox"/> Yes, <input type="checkbox"/> No
Parallel Connect	<input type="checkbox"/> Yes, <input type="checkbox"/> No

Key	Key Type	Number	SDN COS	Day Ring	Night Ring
DN-01	PDN		<input type="checkbox"/> Station, <input type="checkbox"/> DN		
DN-02			<input type="checkbox"/> Station, <input type="checkbox"/> DN		
DN-03			<input type="checkbox"/> Station, <input type="checkbox"/> DN		
DN-04			<input type="checkbox"/> Station, <input type="checkbox"/> DN		
DN-05			<input type="checkbox"/> Station, <input type="checkbox"/> DN		
DN-06			<input type="checkbox"/> Station, <input type="checkbox"/> DN		
DN-07			<input type="checkbox"/> Station, <input type="checkbox"/> DN		
DN-08			<input type="checkbox"/> Station, <input type="checkbox"/> DN		
DN-09			<input type="checkbox"/> Station, <input type="checkbox"/> DN		
DN-10			<input type="checkbox"/> Station, <input type="checkbox"/> DN		
DN-11			<input type="checkbox"/> Station, <input type="checkbox"/> DN		
DN-12			<input type="checkbox"/> Station, <input type="checkbox"/> DN		

PF Key	PF Key Type	Number
01		
02		
03		
04		
05		
06		
07		
08		
09		
10		
11		
12		

DSS Key	DSS Key Type	Number
01		
02		
03		
04		
05		
06		
07		
08		

EXTENSION-STATION

Station Equipment No.

Item	Set Data
Telephone Type and Model	Type _____ Model _____
OHCA Circuit	<input type="checkbox"/> Yes, <input type="checkbox"/> No
Primary Directory Number	- - - - -
Intercom Number	- - -
Station Name	- - - - -
ICM Group	_____
Pickup Group	- - - <input type="checkbox"/> None
Next Hunt Station	<input type="checkbox"/> <input type="checkbox"/> _____ <input type="checkbox"/> None
Class of Service	
Data Line Security	
Automatic Callback-Trunk	<input type="checkbox"/> Yes, <input type="checkbox"/> <input type="checkbox"/>
Parallel Connect	<input type="checkbox"/> Yes, <input type="checkbox"/> <input type="checkbox"/>

Key	Key Type	Number	SDN COS	Day Ring	Night Ring
DN-01	PDN		<input type="checkbox"/> Station, <input type="checkbox"/> DN		
DN-02			<input type="checkbox"/> Station, <input type="checkbox"/> DN		
DN-03			<input type="checkbox"/> Station, <input type="checkbox"/> DN		
DN-04			<input type="checkbox"/> Station, <input type="checkbox"/> DN		
DN-05			<input type="checkbox"/> Station, <input type="checkbox"/> DN		
DN-06			<input type="checkbox"/> Station, <input type="checkbox"/> DN		
DN-07			<input type="checkbox"/> Station, <input type="checkbox"/> DN		
DN-08			<input type="checkbox"/> Station, <input type="checkbox"/> DN		
DN-09			<input type="checkbox"/> Station, <input type="checkbox"/> DN		
DN-10			<input type="checkbox"/> Station, <input type="checkbox"/> DN		
DN-11			<input type="checkbox"/> Station, <input type="checkbox"/> DN		
DN-12			<input type="checkbox"/> Station, <input type="checkbox"/> DN		

PF Key	PF Key Type	Number
01		
02		
03		
04		
05		
06		
07		
08		
09		
10		
11		
12		

DSS Key	DSS Key Type	Number
01		
02		
03		
04		
05		
06		
07		
08		

EXTENSION—STATION

Station Equipment No. _____

Telephone Type and Model _____ OHCA Circuit <input type="checkbox"/> Yes, <input type="checkbox"/> No _____ Primary Directory Number _____ Intercom Number _____ Station Name _____ ICM Group _____ Pickup Group _____ Next Hunt Station _____ Class of Service _____ Data Line Security: <input type="checkbox"/> Yes, <input type="checkbox"/> No _____ Automatic Callback—Trunk <input type="checkbox"/> Yes, <input type="checkbox"/> No _____ Parallel Connect <input type="checkbox"/> Yes, <input type="checkbox"/> No _____	Se Data Type _____ Model _____ <input type="checkbox"/> EXT _____ <input type="checkbox"/> None <input type="checkbox"/> None <input type="checkbox"/> Yes, <input type="checkbox"/> No _____ <input type="checkbox"/> Yes, <input type="checkbox"/> No _____ <input type="checkbox"/> Yes, <input type="checkbox"/> No _____
--	---

Key	Key Type	Number	SDN COS	Day Ring	Night Ring
DN-01	PDN		<input type="checkbox"/> Static- <input type="checkbox"/> DN		
DN-02			<input type="checkbox"/> Static- <input type="checkbox"/> DN		
DN-03			<input type="checkbox"/> Static- <input type="checkbox"/> DN		
DN-04			<input type="checkbox"/> Static- <input type="checkbox"/> DN		
DN-05			<input type="checkbox"/> Static- <input type="checkbox"/> DN		
DN-06			<input type="checkbox"/> Static- <input type="checkbox"/> DN		
DN-07			<input type="checkbox"/> Static- <input type="checkbox"/> DN		
DN-08			<input type="checkbox"/> Static- <input type="checkbox"/> DN		
DN-09			<input type="checkbox"/> Static- <input type="checkbox"/> DN		
DN-10			<input type="checkbox"/> Static- <input type="checkbox"/> DN		
DN-11			<input type="checkbox"/> Static- <input type="checkbox"/> DN		
DN-12			<input type="checkbox"/> Static- <input type="checkbox"/> DN		

PF Key	PF Key Type	Number	DSS Key	DSS Key Type	Number
01			C1		
02			C2		
03			C3		
04			C4		
05			C5		
06			C6		
07			C7		
08			C8		
09					
10					
11					
12					

EXTENSION-STATION

Station Equipment No.

Item	Set Data
Telephone Type and Model	Type _____ Model _____
OHCA Circuit	<input type="checkbox"/> Yes, <input type="checkbox"/> No
Primary Directory Number	_____
intercom Number	_____
Station Name	_____
ICM Group	_____
Pickup Group	_____ <input type="checkbox"/> None
Next Hunt Station	<input type="checkbox"/> EXT _____ <input type="checkbox"/> None
Class of Service	_____
Data Line Security	<input type="checkbox"/> Yes, <input type="checkbox"/> No
Automatic Callback-Trunk	<input type="checkbox"/> Yes, <input type="checkbox"/> X <input type="checkbox"/>
Parallel Connect	<input type="checkbox"/> Yes, <input type="checkbox"/> X <input type="checkbox"/>

Key	Key Type	Number	SDN COS	Day Ring	Night Ring
DN-01	PDN		<input type="checkbox"/> Station, <input type="checkbox"/> DN		
DN-02			<input type="checkbox"/> Station, <input type="checkbox"/> DN		
DN-03			<input type="checkbox"/> Station, <input type="checkbox"/> DN		
DN-04			<input type="checkbox"/> Station, <input type="checkbox"/> DN		
DN-05			<input type="checkbox"/> Station, <input type="checkbox"/> DN		
DN-06			<input type="checkbox"/> Station, <input type="checkbox"/> DN		
DN-07			<input type="checkbox"/> Station, <input type="checkbox"/> DN		
DN-08			<input type="checkbox"/> Station, <input type="checkbox"/> DN		
DN-09			<input type="checkbox"/> Station, <input type="checkbox"/> DN		
DN-10			<input type="checkbox"/> Station, <input type="checkbox"/> DN		
DN-11			<input type="checkbox"/> Station, <input type="checkbox"/> DN		
DN-12			<input type="checkbox"/> Station, <input type="checkbox"/> DN		

PF Key	PF Key Type	Number	DSS Key	DSS Key Type	Number
01			01		
02			02		
03			03		
04			04		
05			05		
06			06		
07			07		
08			08		
09					
10					
11					
12					

EXTENSION-STATION

Station Equipment No.

Item	Set Data
Telephone Type and Model	Type _____ Model _____
OHCA Circuit	<input type="checkbox"/> <input type="checkbox"/> No
Primary Directory Number	- - - -
Intercom Number	- -
Station Name	_____
ICM Group	_____
Pickup Group	- - 2 None
Next Hunt Station	<input type="checkbox"/> _____ <input type="checkbox"/> None
Class of Service	- -
Data Line Security.	<input type="checkbox"/> <input type="checkbox"/> No
Automatic Callback-Trunk	<input type="checkbox"/> Yes, <input type="checkbox"/> No
Parallel Connect	<input type="checkbox"/> <input type="checkbox"/> No

Key	Key Type	Number	SDN COS	Day Ring	Night Ring
DN-01	PDN		<input type="checkbox"/> Station, <input type="checkbox"/> DN		
DN-02			<input type="checkbox"/> Station, <input type="checkbox"/> DN		
DN-03			<input type="checkbox"/> Station, <input type="checkbox"/> DN		
DN-04			<input type="checkbox"/> Station, <input type="checkbox"/> DN		
DN-05			<input type="checkbox"/> Station, <input type="checkbox"/> DN		
DN-06			<input type="checkbox"/> Station, <input type="checkbox"/> DN		
DN-07			<input type="checkbox"/> Station, <input type="checkbox"/> DN		
DN-08			<input type="checkbox"/> Station, <input type="checkbox"/> DN		
DN-09			<input type="checkbox"/> Station, <input type="checkbox"/> DN		
DN-10			<input type="checkbox"/> Station, <input type="checkbox"/> DN		
DN-11			<input type="checkbox"/> Station, <input type="checkbox"/> DN		
DN-12			<input type="checkbox"/> Station, <input type="checkbox"/> DN		

PF Key	PF Key Type	Number
01		
02		
03		
04		
05		
06		
07		
08		
09		
10		
11		
12		

DSS Key	DSS Key Type	Number
01		
02		
03		
04		
05		
06		
07		
08		

EXTENSION-STATION

Station Equipment No.

item	Set Data
Telephone Type and Model	Type _____ Model _____
OHCA Circuit	<input type="checkbox"/> Yes, <input type="checkbox"/> No
Primary Directory Number	- - - - -
Intercom Number	- -
Station Name	_____
ICM Group	_____
Pickup Group	- - - <input type="checkbox"/> None
Next Hunt Station	<input type="checkbox"/> EXT <input type="checkbox"/> None _____
Class of Service	- - -
Data Line Security	<input type="checkbox"/> Yes, <input type="checkbox"/> No
Automatic Callback-Trunk	<input type="checkbox"/> Yes, <input type="checkbox"/> No
Parallel Connect	<input type="checkbox"/> Yes, <input type="checkbox"/> No

Key	Key Type	Number	SDN COS	Day Ring	Night Ring
DN-01	PDN		<input checked="" type="checkbox"/> Station <input type="checkbox"/> DN		
DN-02			<input type="checkbox"/> Station <input type="checkbox"/> DN		
DN-03			<input type="checkbox"/> Station <input type="checkbox"/> DN		
DN-04			<input type="checkbox"/> Station <input type="checkbox"/> DN		
DN-05			<input type="checkbox"/> Station <input type="checkbox"/> DN		
DN-06			<input type="checkbox"/> Station <input type="checkbox"/> DN		
DN-07			<input type="checkbox"/> Station <input type="checkbox"/> DN		
DN-08			<input type="checkbox"/> Station <input type="checkbox"/> DN		
DN-09			<input checked="" type="checkbox"/> Station <input type="checkbox"/> DN		
DN-10			<input type="checkbox"/> Station <input type="checkbox"/> DN		
DN-11			<input type="checkbox"/> Station <input type="checkbox"/> DN		
DN-12			<input type="checkbox"/> Station <input type="checkbox"/> DN		

PF Key	PF Key Type	Number	DSS Key	DSS Key Type	Number
01			01		
02			02		
03			03		
04			04		
05			05		
06			06		
07			07		
08			08		
09					
10					
11					
12					

EXTENSION-STATION

Station Equipment No.

Item	Set Data
Telephone Type and Model	Type _____ Model _____
OHCA Circuit	<input type="checkbox"/> Yes, <input type="checkbox"/> <input type="checkbox"/>
Primary Directory Number	
Intercom Number	_____
Station Name	-----
ICM Group	_____
Pickup Group	_____ 0 None
Next Hunt Station	<input type="checkbox"/> <input type="checkbox"/> None
Class of Service	
Data Line Security.	<input type="checkbox"/> <input type="checkbox"/>
Automatic Callback-Trunk	<input type="checkbox"/> Yes, <input type="checkbox"/> <input type="checkbox"/>
Parallel Connect	<input type="checkbox"/> Yes, <input type="checkbox"/> <input type="checkbox"/>

Key	Key Type	Number	SDN COS	Day Ring	Night Ring
DN-01	PDN		<input type="checkbox"/> Station, <input type="checkbox"/> DN		
DN-02			<input type="checkbox"/> Station, <input type="checkbox"/> DN		
DN-03			<input type="checkbox"/> Station, <input type="checkbox"/> DN		
DN-04			<input type="checkbox"/> Station, <input type="checkbox"/> DN		
DN-05			<input type="checkbox"/> Station, <input type="checkbox"/> DN		
DN-06			<input type="checkbox"/> Station, <input type="checkbox"/> DN		
DN-07			<input type="checkbox"/> Station, <input type="checkbox"/> DN		
DN-08			<input type="checkbox"/> Station, <input type="checkbox"/> DN		
DN-09			<input type="checkbox"/> Station, <input type="checkbox"/> DN		
DN-10			<input type="checkbox"/> Station, <input type="checkbox"/> DN		
DN-11			<input type="checkbox"/> Station, <input type="checkbox"/> DN		
DN-12			<input type="checkbox"/> Station, <input type="checkbox"/> DN		

PF Key	PF Key Type	Number	DSS Key	DSS Key Type	Number
01			01		
02			02		
03			03		
04			04		
05			05		
06			06		
07			07		
08			08		
09					
10					
11					
12					

EXTENSION-STATION

Station Equipment No.

Item	Set Data
Telephone Type and Model	Type _____ Model _____
OHCA Circuit	<input type="checkbox"/> Yes, <input type="checkbox"/> No
Primary Directory Number	- - - - -
Intercom Number	- - -
Station Name	- - - - -
ICM Group	-
Pickup Group	- - - - - ¹ None
Next Hunt Station	<input type="checkbox"/> <input type="checkbox"/> _____ <input type="checkbox"/> None
Class of Service	- - -
Data Line Security	<input type="checkbox"/> Yes, <input type="checkbox"/> No
Automatic Callback-Trunk	<input type="checkbox"/> Yes, <input type="checkbox"/> No
Parallel Connect	<input type="checkbox"/> <input type="checkbox"/> <input type="checkbox"/> <input type="checkbox"/> No

Key	Key Type	Number	SDN COS	Day Ring	Night Ring
DN-01	PDN		<input type="checkbox"/> Station, <input type="checkbox"/> DN		
DN-02			<input type="checkbox"/> Station, <input type="checkbox"/> DN		
DN-03			<input type="checkbox"/> Station, <input type="checkbox"/> DN		
DN-04			<input type="checkbox"/> Station, <input type="checkbox"/> DN		
DN-05			<input type="checkbox"/> Station, <input type="checkbox"/> DN		
DN-06			<input type="checkbox"/> Station, <input type="checkbox"/> DN		
DN-07			<input type="checkbox"/> Station, <input type="checkbox"/> DN		
DN-08			<input type="checkbox"/> Station, <input type="checkbox"/> DN		
DN-09			<input type="checkbox"/> Station, <input type="checkbox"/> DN		
DN-10			<input type="checkbox"/> Station, <input type="checkbox"/> DN		
DN-11			<input type="checkbox"/> Station, <input type="checkbox"/> DN		
DN-12			<input type="checkbox"/> Station, <input type="checkbox"/> DN		

PF Key	PF Key Type	Number
01		
02		
03		
04		
05		
06		
07		
08		
09		
10		
11		
12		

DSS Key	DSS Key Type	Number
01		
02		
03		
04		
05		
06		
07		
08		

EXTENSION-STATION

Station Equipment No.

Item	Set Data
Telephone Type and Model	Type _____ Model _____
OHCA Circuit	<input type="checkbox"/> Yes. <input type="checkbox"/> No
Primary Directory Number	_____
Intercom Number	_____
Station Name	_____
ICM Group	_____
Pickup Group	_____ <input type="checkbox"/> None
Next Hunt Station	<input type="checkbox"/> EXT <input type="checkbox"/> None _____
Class of Service	_____
Data Line Security	<input type="checkbox"/> Yes <input type="checkbox"/> <input type="checkbox"/>
Automatic Callback-Trunk	<input type="checkbox"/> Yes. <input type="checkbox"/> No
Parallel Connect	<input type="checkbox"/> Yes <input type="checkbox"/> <input type="checkbox"/>

Key	Key Type	Number	SDN COS	Day Ring	Night Ring
DN-01	PDN		<input type="checkbox"/> Station, <input type="checkbox"/> DN		
DN-02			<input type="checkbox"/> Station, nDN		
DN-03			<input type="checkbox"/> Station, nDN		
DN-04			<input type="checkbox"/> Station, <input type="checkbox"/> DN		
DN-05			<input type="checkbox"/> Station, nDN		
DN-06			<input type="checkbox"/> Station, [7DN		
DN-07			<input type="checkbox"/> jStation, <input type="checkbox"/> DN		
DN-08			<input type="checkbox"/> jStation, uDN		
DN-09			<input type="checkbox"/> Station, <input type="checkbox"/> DN		
DN-10			<input type="checkbox"/> Station, <input type="checkbox"/> DN		
DN-11			<input type="checkbox"/> Station <input type="checkbox"/> DN		
DN-12			<input type="checkbox"/> Station, <input type="checkbox"/> DN		

PF Key	PF Key Type	Number
01		
02		
03		
04		
05		
06		
07		
08		
09		
10		
11		
12		

DSS Key	DSS Key Type	Number
01		
02		
03		
04		
05		
06		
07		
08		

EXTENSION-STATION

Station Equipment No.

Item	Set Data
Telephone Type and Model	Type _____ Model _____
OHCA Circuit	<input type="checkbox"/> Yes, <input type="checkbox"/> X <input type="checkbox"/>
Primary Directory Number	_____
intercom Number	- -
Station Name	_____
ICM Group	_____
Pickup Group	- - <input type="checkbox"/> None
Next Hunt Station	<input type="checkbox"/> X <input type="checkbox"/> _____ <input type="checkbox"/> None
Class of Service	- -
Data Line Security	<input type="checkbox"/> Yes, <input type="checkbox"/> No
Automatic Callback-Trunk	<input type="checkbox"/> Yes, <input type="checkbox"/> No
Parallel Connect	<input type="checkbox"/> Yes, <input type="checkbox"/> X <input type="checkbox"/>

Key	Key Type	Number	SDN COS	Day Ring	Night Ring
DN-01	PDN		<input type="checkbox"/> Station, ODN		
DN-02			<input type="checkbox"/> Station, nDN		
DN-03			<input type="checkbox"/> Station, ODN		
DN-04			<input type="checkbox"/> Station, <input type="checkbox"/> DN		
DN-05			<input type="checkbox"/> Station, <input type="checkbox"/> DN		
DN-06			<input type="checkbox"/> Station, <input type="checkbox"/> DN		
DN-07			<input type="checkbox"/> Station, <input type="checkbox"/> DN		
DN-08			<input type="checkbox"/> Station, <input type="checkbox"/> DN		
DN-09			<input type="checkbox"/> Station, <input type="checkbox"/> DN		
DN-10			<input type="checkbox"/> Station, <input type="checkbox"/> DN		
DN-11			<input type="checkbox"/> Station, <input type="checkbox"/> DN		
DN-12			<input type="checkbox"/> Station, <input type="checkbox"/> DN		

PF Key	PF Key Type	Number	DSS Key	DSS Key Type	Number
01			01		
02			02		
03			03		
04			04		
05			05		
06			06		
07			07		
08			08		
09					
10					
11					
12					

EXTENSION-STATION

Station Equipment No.

Item	Set Data
Telephone Type and Model	Type _____ Model _____
OHCA Circuit	<input type="checkbox"/> Yes, <input type="checkbox"/> No
Primary Directory Number	- - - -
Intercom Number	- -
Station Name	_____
ICM Group	_____
Pickup Group	- - <input type="checkbox"/> None
Next Hunt Station	<input type="checkbox"/> EXT _____ <input type="checkbox"/> None
Class of Service	- -
Data Line Security	<input type="checkbox"/> Yes, <input type="checkbox"/> No
Automatic Callback-Trunk	<input type="checkbox"/> Yes, <input type="checkbox"/> No
Parallel Connect	<input type="checkbox"/> Yes, <input type="checkbox"/> No

Key	Key Type	Numbs-	/ SDN COS	Day Ring	Night Ring
DN-01	PDN		<input type="checkbox"/> Station, <input type="checkbox"/> DN		
DN-02			<input type="checkbox"/> Station, <input type="checkbox"/> DN		
DN-03			<input type="checkbox"/> Station, nDN		
DN-04			<input type="checkbox"/>]Station, CjDN		
DN-05			<input type="checkbox"/> Station, <input type="checkbox"/> DN		
DN-06			<input type="checkbox"/> Station, <input type="checkbox"/> DN		
DN-07			<input type="checkbox"/> Station, nDN		
DN-08			<input type="checkbox"/> Station, <input type="checkbox"/> DN		
DN-09			<input type="checkbox"/> Station, <input type="checkbox"/> DN		
DN-10			<input type="checkbox"/> Station, ODN		
DN-11			<input type="checkbox"/> Station, [7DN		
DN-12			<input type="checkbox"/>]Station, <input type="checkbox"/> DN		

PF Key	PF Key Type	Number
01		
02		
03		
04		
05		
06		
07		
08		
09		
10		
11		
12		

DSS Key	DSS Key Type	Number
01		
02		
03		
04		
05		
06		
07		
08		

EXTENSION-STATION

Station Equipment No.

Item	Set Data
Telephone Type and Model	Type _____ Model _____
OHCA Circuit	<input type="checkbox"/> <input type="checkbox"/>
Primary Directory Number	_____
Intercom Number	- -
Station Name	_____
ICM Group	_____
Pickup Group	- - <input type="checkbox"/> None
Next Hunt Station	<input type="checkbox"/> _____ <input type="checkbox"/> None
Class of Service	- -
Data Line Security	<input type="checkbox"/> Yes, <input type="checkbox"/> No
Automatic Catlback-Trunk	<input type="checkbox"/> <input type="checkbox"/> No
Parallel Connect	<input type="checkbox"/> <input type="checkbox"/> No

Key	Key Type	Number	SDN COS	Day Ring	Night Ring
DN-01	PDN		<input type="checkbox"/> Station, <input type="checkbox"/> DN		
DN-02			<input type="checkbox"/> Station, <input type="checkbox"/> DN		
DN-03			<input type="checkbox"/> Station, <input type="checkbox"/> DN		
DN-04			<input type="checkbox"/> Station, <input type="checkbox"/> DN		
DN-05			<input type="checkbox"/> Station, <input type="checkbox"/> DN		
DN-06			<input type="checkbox"/> Station, <input type="checkbox"/> DN		
DN-07			<input type="checkbox"/> Station, <input type="checkbox"/> DN		
DN-08			<input type="checkbox"/> Station, <input type="checkbox"/> DN		
DN-09			<input type="checkbox"/> Station, <input type="checkbox"/> DN		
DN-10			<input type="checkbox"/> Station, <input type="checkbox"/> DN		
DN-11			<input type="checkbox"/> Station, <input type="checkbox"/> DN		
DN-12			<input type="checkbox"/> Station, <input type="checkbox"/> DN		

PF Key	PF Key Type	Number	DSS Key	DSS Key Type	Number
01			01		
02			02		
03			03		
04			04		
05			05		
06			06		
07			07		
08			08		
09					
10					
11					
12					

EXTENSION-STATION

Station Equipment No.

Item	Set Data
Telephone Type and Model	Type _____ Model _____
OHCA Circuit	<input type="checkbox"/> Yes <input type="checkbox"/> No
Primary Directory Number	_____
intercom Number	_____
Station Name	_____
ICM Group	_____
Pickup Group	_____ <input type="checkbox"/> None
Next Hunt Station	<input type="checkbox"/> EXT _____ <input type="checkbox"/> None
Class of Service	- -
Data. Line Security	a y e s , <input type="checkbox"/> No
Automatic Callback-Trunk	<input type="checkbox"/> Yes, <input type="checkbox"/> No
Parallel Connect	<input type="checkbox"/> # <input type="checkbox"/> <input type="checkbox"/> <input type="checkbox"/>

Key	Key Type	Number	SDN	COS	Day Ring	Night Ring
DN-01	PDN		<input type="checkbox"/>	Station,mDN		
DN-02			<input type="checkbox"/>	Station,]DN		
DN-03			<input type="checkbox"/>	Station,]DN		
DN-04			<input type="checkbox"/>	Station,]DN		
DN-05			<input type="checkbox"/>	Station,]DN		
DN-06			<input type="checkbox"/>	Station,]DN		
DN-07			<input type="checkbox"/>	Station,]DN		
DN-08			<input type="checkbox"/>	Station,[7DN		
DN-09			<input type="checkbox"/>	Station,nDN		
DN-10			<input type="checkbox"/>	Station,nDN		
DN-11			<input type="checkbox"/>	Station.nDN		
DN-12			<input type="checkbox"/>	Station.C]DN		

PF Key	PF Key Type	Number
01		
02		
03		
04		
05		
06		
07		
08		
09		
10		
11		
12		

DSS Key	DSS Key Type	Number
01		
02		
03		
04		
05		
06		
07		
08		

EXTENSION-STATION

Station Equipment No.

item	Set Data
Telephone Type and Model	Type_____ Model_____
OHCA Circuit	<input type="checkbox"/> Yes, <input type="checkbox"/> No
Primary Directory Number	- - - -
intercom Number	- -
Station Name	_____
ICM Group	_____
Pickup Group	- - <input type="checkbox"/> None
Next Hunt Station	<input type="checkbox"/> <input type="checkbox"/> _____ <input type="checkbox"/> None
Class of Service	- -
Data Line Security	<input type="checkbox"/> <input type="checkbox"/> <input type="checkbox"/> No
Automatic Callback-Trunk	<input type="checkbox"/> Yes, <input type="checkbox"/> No
Parallel Connect	<input type="checkbox"/> Yes, <input type="checkbox"/> No

Key	Key Type	Number	SDN COS	Day Ring	Night Ring
DN-01	PDN		<input type="checkbox"/> Station, <input type="checkbox"/> DN		
DN-02			<input type="checkbox"/> Station, <input type="checkbox"/> DN		
DN-03			<input type="checkbox"/> Station, <input type="checkbox"/> DN		
DN-04			<input type="checkbox"/> Station, <input type="checkbox"/> DN		
DN-05			<input type="checkbox"/> Station, <input type="checkbox"/> DN		
DN-06			<input type="checkbox"/> Station, <input type="checkbox"/> DN		
DN-07			<input type="checkbox"/> Station, nDN		
DN-08			<input type="checkbox"/> Station, <input type="checkbox"/> DN		
DN-09			<input type="checkbox"/> Station, nDN		
DN-10			<input type="checkbox"/> Station, <input type="checkbox"/> DN		
DN-11			<input type="checkbox"/> Station, <input type="checkbox"/> DN		
DN-12			<input type="checkbox"/>]Station, nDN		

PF Key	PF Key Type	Number	DSS Key	DSS Key Type	Number
01			01		
02			02		
03			03		
04			04		
05			05		
06			06		
07			07		
08			08		
09					
10					
11					

I 12 |

EXTENSION-STATION

Station Equipment No.

Item	Set Data
Telephone Type and Model	Type _____ Model _____
OHCA Circuit	<input type="checkbox"/> Yes, <input type="checkbox"/> No
Primary Directory Number	- - - -
Intercom Number	- -
Station Name	_____
ICM Group	_____
Pickup Group	- - <input type="checkbox"/> None
Next Hunt Station	<input type="checkbox"/> EXT _____ <input type="checkbox"/> None
Class of Service	- -
Data-tine Security	<input type="checkbox"/> Yes, <input type="checkbox"/>
Automatic Callback-Trunk	<input type="checkbox"/> Yes, <input type="checkbox"/> No
Parallel Connect	<input type="checkbox"/> Yes, <input type="checkbox"/> No

Key	Key Type	Number	SDN COS	Day Ring	Night Ring
DN-01	PDN		<input type="checkbox"/> Station, <input type="checkbox"/> DN		
DN-02			<input type="checkbox"/> Station, <input type="checkbox"/> DN		
DN-03			<input type="checkbox"/> Station, <input type="checkbox"/> DN		
DN-04			<input type="checkbox"/> Station, <input type="checkbox"/> DN		
DN-05			<input type="checkbox"/> Station, <input type="checkbox"/> DN		
DN-06			<input type="checkbox"/> Station, <input type="checkbox"/> DN		
DN-07			<input type="checkbox"/> Station, <input type="checkbox"/> DN		
DN-08			<input type="checkbox"/> Station, <input type="checkbox"/> DN		
DN-09			<input type="checkbox"/> Station, <input type="checkbox"/> DN		
DN-10			<input type="checkbox"/> Station, <input type="checkbox"/> DN		
DN-11			<input type="checkbox"/> Station, <input type="checkbox"/> DN		
DN-12			<input type="checkbox"/> Station, <input type="checkbox"/> DN		

PF Key	PF Key Type	Number
01		
02		
03		
04		
05		
06		
07		
08		
09		
10		
11		
12		

DSS Key	DSS Key Type	Number
01		
02		
03		
04		
05		
06		
07		
08		

EXTENSION-STATION

Station Equipment No.

Item	Set Data
Telephone Type and Model	Type _____ Model _____
OHCA Circuit	<input type="checkbox"/> <input type="checkbox"/> <input type="checkbox"/> <input type="checkbox"/> <input type="checkbox"/> No
Primary Directory Number	- - - - -
intercom Number	- -
Station Name	_____
ICM Group	_____
Pickup Group	- - J None
Next Hunt Station	<input type="checkbox"/> EXT <input type="checkbox"/> N o n e
Class of Service	- -
Data Line Security	<input type="checkbox"/> <input type="checkbox"/> <input type="checkbox"/> <input type="checkbox"/> <input type="checkbox"/> No
Automatic Callback-Trunk	<input type="checkbox"/> Yes, <input type="checkbox"/> No
Parallel Connect	<input type="checkbox"/> Yes, <input type="checkbox"/> No

Key	Key Type	Number	SDN COS	Day Ring	Night Ring
DN-01	PDN		<input type="checkbox"/> Station, <input type="checkbox"/> DN		
DN-02			<input type="checkbox"/> Station, <input type="checkbox"/> DN		
DN-03			<input type="checkbox"/> Station, <input type="checkbox"/> DN		
DN-04			<input type="checkbox"/> Station, <input type="checkbox"/> DN		
DN-05			<input type="checkbox"/> Station, <input type="checkbox"/> DN		
DN-06			<input type="checkbox"/> Station, <input type="checkbox"/> DN		
DN-07			<input type="checkbox"/> Station, <input type="checkbox"/> DN		
DN-08			<input type="checkbox"/> Station, <input type="checkbox"/> DN		
DN-09			<input type="checkbox"/> Station, <input type="checkbox"/> DN		
DN-10			<input type="checkbox"/> Station, <input type="checkbox"/> DN		
DN-11			<input type="checkbox"/> Station, <input type="checkbox"/> DN		
DN-12			<input type="checkbox"/> Station, <input type="checkbox"/> DN		

PF Key	PF Key Type	Number
01		
02		
03		
04		
05		
06		
07		
08		
09		
10		
11		
12		

DSS Key	DSS Key Type	Number
01		
02		
03		
04		
05		
06		
07		
08		

EXTENSION-STATION

Station Equipment No. _____

her--	Set Data
Telephone Type and Model	Type _____ Model _____
OHCA Circuit	<input type="checkbox"/> Yes, <input type="checkbox"/> No
Primary Directory Number	- - - - -
Intercom Number	- - -
Station Name	_____
ICM Group	_____
Pickup Group	- - - <input type="checkbox"/> None
Next Hunt Station	<input type="checkbox"/> IEXT _____ <input type="checkbox"/> None
Class of Service	- - -
Data Line Security	<input type="checkbox"/> Yes, <input type="checkbox"/> No
Automatic Callback-Trunk	<input type="checkbox"/> Yes, <input type="checkbox"/> No
Parallel Connect	<input type="checkbox"/> Yes, <input type="checkbox"/> No

Key	Key Type	Number	SDN	COS	Day Ring	Night Ring
DN-01	PDN		<input type="checkbox"/> Station,	<input type="checkbox"/> DN		
DN-02			<input type="checkbox"/> Station,	<input type="checkbox"/> DN		
DN-03			<input type="checkbox"/> Station,	<input type="checkbox"/> DN		
DN-04			<input type="checkbox"/> Station,	<input type="checkbox"/> DN		
DN-05			<input type="checkbox"/> Station,	<input type="checkbox"/> DN		
DN-06			<input type="checkbox"/> Station,	<input type="checkbox"/> DN		
DN-07			<input type="checkbox"/> Station,	<input type="checkbox"/> DN		
DN-08			<input type="checkbox"/> Station,	<input type="checkbox"/> DN		
DN-09			<input type="checkbox"/> Station,	<input type="checkbox"/> DN		
DN-10			<input type="checkbox"/> Station,	<input type="checkbox"/> DN		
DN-11			<input type="checkbox"/> Station,	JDN		
DN-12			<input type="checkbox"/> Station,	nDN		

PF Key	PF Key Type	Number	DSS Key	DSS Key Type	Number
01			01		
02			02		
03			03		
04			04		
05			05		
06			06		
07			07		
08			08		
09					
10					
11					
12					

EXTENSION-STATION

Station Equipment No.

Item	Set Data
Telephone Type and Model	Type _____ Model _____
OHCA Circuit	<input type="checkbox"/> Yes, <input type="checkbox"/> No
Primary Directory Number	- - - -
Intercom Number	- -
Station Name	- - - - -
ICM Group	—
Pickup Group	- - <input type="checkbox"/> None
Next Hunt Station	<input type="checkbox"/> EXT _____ <input type="checkbox"/> None
Class of Service	- -
Data Line Security	<input type="checkbox"/> Yes, <input type="checkbox"/> No
Automatic Callback-Trunk	<input type="checkbox"/> Yes, <input type="checkbox"/> No
Parallel Connect	<input type="checkbox"/> <input type="checkbox"/> <input type="checkbox"/> <input type="checkbox"/> <input type="checkbox"/> <input type="checkbox"/>

Key	Key Type	Number	SDN COS	Day Ring	Night Ring
DN-01	PDN		<input type="checkbox"/> Station, <input type="checkbox"/> DN		
DN-02			<input type="checkbox"/> Station, <input type="checkbox"/> DN		
DN-03			<input type="checkbox"/> Station, <input type="checkbox"/> DN		
DN-04			<input type="checkbox"/> Station, <input type="checkbox"/> DN		
DN-05			<input type="checkbox"/> Station, <input type="checkbox"/> DN		
DN-06			<input type="checkbox"/> Station, <input type="checkbox"/> DN		
DN-07			<input type="checkbox"/> Station, <input type="checkbox"/> DN		
DN-08			<input type="checkbox"/> Station, <input type="checkbox"/> DN		
DN-09			<input type="checkbox"/> Station, <input type="checkbox"/> DN		
DN-10			<input type="checkbox"/> Station, <input type="checkbox"/> DN		
DN-11			<input type="checkbox"/> Station, ODN		
DN-12			<input type="checkbox"/> Station, C)DN		

PF Key	PF Key Type	Number
01		
02		
03		
04		
05		
06		
07		
08		
09		
10		
11		
12		

DSS Key	DSS Key Type	Number
01		
02		
03		
04		
05		
06		
07		
08		

EXTENSION-STATION

Station Equipment No

item	Set Data
Telephone Type and Model	Type _____ Model _____
OHCA Circuit	<input type="checkbox"/> Yes. <input type="checkbox"/> No
Primary Directory Number	- - - -
intercom Number	- -
Station Name	- - - - -
ICM Group	-
Pickup Group	- - <input type="checkbox"/> None
Next Hunt Station	<input type="checkbox"/> EXT <input type="checkbox"/> _____ N o n e
Class of Service	- -
Data Line Security	<input type="checkbox"/> Yes. <input type="checkbox"/> No
Automatic Callback-Trunk	<input type="checkbox"/> Yes. <input type="checkbox"/> No
Parallel Connect	<input type="checkbox"/> Yes. <input type="checkbox"/> No

Key	Key Type	Number	SDN COS	Day Rina	Nbht Rina
DN-01	PDN		<input type="checkbox"/> Station, <input type="checkbox"/> DN		
DN-02			<input type="checkbox"/> Station, nDN		
DN-03			<input type="checkbox"/> Station, <input type="checkbox"/> DN		
DN-04			<input type="checkbox"/>]Station, nDN		
DN-05			<input type="checkbox"/> Station, <input type="checkbox"/> DN		
DN-06			<input type="checkbox"/> Station, <input type="checkbox"/>]DN		
DN-07			<input type="checkbox"/> Station, <input type="checkbox"/> DN		
DN-08			<input type="checkbox"/>]Station, <input type="checkbox"/> DN		
DN-09			<input type="checkbox"/> Station, nDN		
DN-10			<input type="checkbox"/> Station, <input type="checkbox"/> DN		
DN-11			<input type="checkbox"/> Station, (-JDN		
DN-12			<input type="checkbox"/> Station, ODN		

PF Key	PF Key Type	Number
01		
02		
03		
04		
05		
06		
07		
08		
09		
10		
11		
12		

DSS Key	DSS Key Type	Number
01		
02		
03		
04		
05		
06		
07		
08		

EXTENSION-STATION

Station Equipment No.

Item	Set Data
Telephone Type and Model	Type _____ Model _____
OHCA Circuit	<input type="checkbox"/> Yes, <input type="checkbox"/> <input type="checkbox"/>
Primary Directory Number	
Intercom Number	---
Station Name	-----
ICM Group	
Pickup Group	--- <input type="checkbox"/> None
Next Hunt Station	<input type="checkbox"/> ----- <input type="checkbox"/> None
Class of Service	
Data Line Security	<input type="checkbox"/> Yes, <input type="checkbox"/> No
Automatic Callback-Trunk	<input type="checkbox"/> Yes, <input type="checkbox"/>
Parallel Connect	<input type="checkbox"/> Yes, <input type="checkbox"/> No

Key	Key Type	Number	SDN COS	Day Ring	Night Ring
DN-01	PDN		<input type="checkbox"/> Station, <input type="checkbox"/> DN		
DN-02			<input type="checkbox"/> Station, <input type="checkbox"/> DN		
DN-03			<input type="checkbox"/> Station, <input type="checkbox"/> DN		
DN-04			<input type="checkbox"/> Station, <input type="checkbox"/> DN		
DN-05			<input type="checkbox"/> Station, <input type="checkbox"/> DN		
DN-06			<input type="checkbox"/> Station, <input type="checkbox"/> DN		
DN-07			<input type="checkbox"/> Station, <input type="checkbox"/> DN		
DN-08			<input type="checkbox"/> Station, <input type="checkbox"/> DN		
DN-09			<input type="checkbox"/> Station, <input type="checkbox"/> DN		
DN-10			<input type="checkbox"/> Station, <input type="checkbox"/> DN		
DN-11			<input type="checkbox"/> Station, <input type="checkbox"/> DN		
DN-12			<input type="checkbox"/> Station, <input type="checkbox"/> DN		

PF Key	PF Key Type	Number	DSS Key	DSS Key Type	Number
01			01		
02			02		
03			03		
04			04		
05			05		
06			06		
07			07		
08			08		
09					
10					
11					
12					

EXTENSION-STATION

Station Equipment No.

Item	Set Data
Telephone Type and Model	Type _____ Model _____
OHCA Circuit	<input type="checkbox"/> Yes, <input type="checkbox"/> No
Primary Directory Number	_____
Intercom Number	_____
Station Name	_____
ICM Group	_____
Pickup Group	_____ <input type="checkbox"/> None
Next Hunt Station	<input type="checkbox"/> XXXX _____ <input type="checkbox"/> None
Class of Service	_____
Data Line Security	<input type="checkbox"/> Yes, <input type="checkbox"/> No
Automatic Callback-Trunk	<input type="checkbox"/> Yes, <input type="checkbox"/> No
Parallel Connect	<input type="checkbox"/> Yes, <input type="checkbox"/> No

Key	Key Type	Number	SDN COS	Day Ring	Night Ring
DN-01	PDN		<input type="checkbox"/> Station, <input type="checkbox"/> DN		
DN-02			<input type="checkbox"/> Station, <input type="checkbox"/> DN		
DN-03			<input type="checkbox"/> Station, <input type="checkbox"/> DN		
DN-04			<input type="checkbox"/> Station, <input type="checkbox"/> DN		
DN-05			<input type="checkbox"/> Station, <input type="checkbox"/> DN		
DN-06			<input type="checkbox"/> Station, <input type="checkbox"/> DN		
DN-07			<input type="checkbox"/> Station, <input type="checkbox"/> DN		
DN-08			<input type="checkbox"/> Station, <input type="checkbox"/> DN		
DN-09			<input type="checkbox"/> Station, <input type="checkbox"/> DN		
DN-10			<input type="checkbox"/> Station, <input type="checkbox"/> DN		
DN-11			<input type="checkbox"/> Station, <input type="checkbox"/> DN		
DN-12			<input type="checkbox"/> Station, <input type="checkbox"/> DN		

PF Key	PF Key Type	Number
01		
02		
03		
04		
05		
06		
07		
08		
09		
10		
11		
12		

DSS Key	DSS Key Type	Number
01		
02		
03		
04		
05		
06		
07		
08		

EXTENSION-STATION

Station Equipment No.

Item	Set Data
Telephone Type and Model	Type _____ Model _____
OHCA Circuit	<input type="checkbox"/> Yes, <input type="checkbox"/> No
Primary Directory Number	_____
Intercom Number	_____
Station Name	_____
ICM Group	_____
Pickup Group	_____ None
Next Hunt Station	<input type="checkbox"/> 8888 <input type="checkbox"/> None
Class of Service	_____
Data Line Security	<input type="checkbox"/> <input type="checkbox"/> No
Automatic Callback-Trunk	<input type="checkbox"/> Yes, <input type="checkbox"/> No
Parallel Connect	<input type="checkbox"/> Yes, <input type="checkbox"/> No

Key	Key Type	Number	SDN	COS	Dav Fiina	Night Rina
DN-01	PDN		<input type="checkbox"/> Station.	<input type="checkbox"/> DN		
DN-02			<input type="checkbox"/> Station,ODN			
DN-03			<input type="checkbox"/> Station,ODN			
DN-04			<input type="checkbox"/> Station.	<input type="checkbox"/> DN		
DN-05			<input type="checkbox"/> Station,	<input type="checkbox"/> DN		
DN-06			<input type="checkbox"/> Station,	<input type="checkbox"/> DN		
DN-07			<input type="checkbox"/> Station,	<input type="checkbox"/> DN		
DN-08			<input type="checkbox"/> Station,	<input type="checkbox"/> DN		
DN-09			<input type="checkbox"/> Station,	<input type="checkbox"/> DN		
DN-10			<input type="checkbox"/> Station,	<input type="checkbox"/> DN		
DN-11			<input type="checkbox"/> Station,	<input type="checkbox"/> DN		
DN-12			<input type="checkbox"/> Station,	<input type="checkbox"/> DN		

PF Key	PF Key Type	Number
01		
02		
03		
04		
05		
06		
07		
08		
09		
10		
11		
12		

DSS Key	DSS Key Type	Number
01		
02		
03		
04		
05		
06		
07		
08		

EXTENSION-STATION

Station Equipment No.

Item	Set Data
Telephone Type and Model	Type _____ Model _____
OHCA Circuit	_____
Primary Directory Number	_____
Intercom Number	_____
Station Name	_____
ICM Group	_____
Pickup Group	_____ <input type="checkbox"/> None
Next Hunt Station	<input type="checkbox"/> EXT _____ <input type="checkbox"/> None
Class of Service	_____
Data Line Security	_____
Automatic Callback-Trunk	<input type="checkbox"/> Yes, _____
Parallel Connect	<input type="checkbox"/> Yes, _____

Key	Key Type	Number	SDN COS	Day Ring	Night Ring
DN-01	PDN		<input type="checkbox"/> Station, nDN		
DN-02			<input type="checkbox"/> Station, <input type="checkbox"/> DN		
DN-03			<input type="checkbox"/> Station, ODN		
DN-04			<input type="checkbox"/> Station, nDN		
DN-05			<input type="checkbox"/> Station, <input type="checkbox"/> DN		
DN-06			<input type="checkbox"/> Station, <input type="checkbox"/> DN		
DN-07			<input type="checkbox"/> Station, <input type="checkbox"/> DN		
DN-08			<input type="checkbox"/> Station, ODN		
DN-09			<input type="checkbox"/> Station, <input type="checkbox"/> DN		
DN-10			<input type="checkbox"/> Station, CJDN		
DN-11			<input type="checkbox"/> Station, nDN		
DN-12			<input type="checkbox"/> Station, <input type="checkbox"/> DN		

PF Key	PF Key Type	Number	DSS Key	DSS Key Type	Number
01			01		
02			02		
03			03		
04			04		
05			05		
06			06		
07			07		
08			08		
09					
10					
11					
12					

EXTENSION-STATION

Station Equipment No

Item	Set Data
Telephone Type and Model	Type _____ Model _____
OHCA Circuit	<input type="checkbox"/> Yes <input type="checkbox"/> No
Primary Directory Number	_____
Intercom Number	- -
Station Name	_____
ICM Group	_____
Pickup Group	- - u None
Next Hunt Station	<input type="checkbox"/> EXT _____ <input type="checkbox"/> None
Class of Service	- -
Data Line Security	<input type="checkbox"/> Yes <input type="checkbox"/> No
Automatic Callback-Trunk	<input type="checkbox"/> Yes <input type="checkbox"/> <input type="checkbox"/>
Parallel Connect	<input type="checkbox"/> Yes <input type="checkbox"/> <input type="checkbox"/>

Key	Key Type	Number	SDN	COS	Day Ring	Night Ring
DN-01	PDN		<input type="checkbox"/> Station	<input type="checkbox"/> DN		
DN-02			<input type="checkbox"/> Station,	<input type="checkbox"/> DN		
DN-03			<input type="checkbox"/> Station,n	DN		
DN-04			<input type="checkbox"/> Station,ODN			
DN-06			<input type="checkbox"/> Station,	<input type="checkbox"/> DN		
DN-06			<input type="checkbox"/> Station,	<input type="checkbox"/> DN		
DN-07			<input type="checkbox"/> Station,	<input type="checkbox"/> DN		
DN-08			<input type="checkbox"/> Station,n	DN		
DN-09			<input type="checkbox"/> Station,	<input type="checkbox"/> DN		
DN-10			<input type="checkbox"/> Station,n	DN		
DN-11			<input type="checkbox"/> Station,	<input type="checkbox"/> DN		
DN-12			<input type="checkbox"/> Station,	<input type="checkbox"/> DN		

PF Key	PF Key Type	Number	DSS Key	DSS Key Type	Number
01			01		
02			02		
03			03		
04			04		
05			05		
06			06		
07			07		
08			08		
09					
10					
11					
12					

EXTENSION-STATION

Station Equipment No.

Item	Set Data
Telephone Type and Model	Type _____ Model _____
OHCA Circuit	<input type="checkbox"/> Yes, <input type="checkbox"/> No
Primary Directory Number	- - - -
Intercom Number	- -
Station Name	_____
ICM Group	__
Pickup Group	- - <input type="checkbox"/> None
Next Hunt Station	<input type="checkbox"/> EXT <input type="checkbox"/> None__
Class of Service	- -
Data Line Security	<input type="checkbox"/> <input type="checkbox"/> No
Automatic-Callback-Trunk	<input type="checkbox"/> Yes, <input type="checkbox"/> No
Parallel Connect	<input type="checkbox"/> Yes, <input type="checkbox"/> No

Key	Key Type	Number	SDN COS	Day Ring	Night Ring
DN-01	PDN		<input type="checkbox"/> Station, <input type="checkbox"/> DN		
DN-02			<input type="checkbox"/> Station, <input type="checkbox"/> DN		
DN-03			<input type="checkbox"/> Station, <input type="checkbox"/> DN		
DN-04			<input type="checkbox"/> Station, <input type="checkbox"/> DN		
DN-05			<input type="checkbox"/> Station, <input type="checkbox"/> DN		
DN-06			<input type="checkbox"/> Station, <input type="checkbox"/> DN		
DN-07			<input type="checkbox"/> Station, <input type="checkbox"/> DN		
DN-08			<input type="checkbox"/> Station, <input type="checkbox"/> DN		
DN-09			<input type="checkbox"/> Station, <input type="checkbox"/> DN		
DN-10			<input type="checkbox"/> Station, <input type="checkbox"/> DN		
DN-11			<input type="checkbox"/> Station, <input type="checkbox"/> DN		
DN-12			<input type="checkbox"/> Station, <input type="checkbox"/> DN		

PF Key	PF Key Type	Number
01		
02		
03		
04		
05		
06		
07		
08		
09		
10		
11		
12		

DSS Key	DSS Key Type	Number
01		
02		
03		
04		
05		
06		
07		
08		

EXTENSION-STATION

Station Equipment No

Item	Set Data
Telephone Type and Model	Type _____ Model _____
OHCA Circuit	<input type="checkbox"/> Yes, <input type="checkbox"/> No
Primary Directory Number	_____
Intercom Number	_____
Station Name	_____
ICM Group	_____
Pickup Group	_____ <input type="checkbox"/> None
Next Hunt Station	<input type="checkbox"/> _____ <input type="checkbox"/> None
Class of Service	_____
Data Line Security	<input type="checkbox"/> a y e s , <input type="checkbox"/> No
Automatic Callback-Trunk	<input type="checkbox"/> <input type="checkbox"/>
Parallel Connect	<input type="checkbox"/> Yes, <input type="checkbox"/> No

Key	Key Type	Number	SDN COS	Day Ring	Night Ring
DN-01	PDN		<input type="checkbox"/> Station, <input type="checkbox"/> DN		
DN-02			<input type="checkbox"/> Station, <input type="checkbox"/> DN		
DN-03			<input type="checkbox"/> Station, <input type="checkbox"/> DN		
DN-04			<input type="checkbox"/> Station, <input type="checkbox"/> DN		
DN-05			<input type="checkbox"/> Station, <input type="checkbox"/> DN		
DN-06			<input type="checkbox"/> Station, <input type="checkbox"/> DN		
DN-07			<input type="checkbox"/> Station, <input type="checkbox"/> DN		
DN-08			<input type="checkbox"/> Station, <input type="checkbox"/> DN		
DN-09			<input type="checkbox"/> Station, <input type="checkbox"/> DN		
DN-10			<input type="checkbox"/> Station, <input type="checkbox"/> DN		
DN-11			<input type="checkbox"/> Station, <input type="checkbox"/> DN		
DN-12			<input type="checkbox"/> Station, <input type="checkbox"/> DN		

PF Key	PF Key Type	Number
01		
02		
03		
04		
05		
06		
07		
08		
09		
10		
11		
12		

DSS Key	DSS Key Type	Number
01		
02		
03		
04		
05		
06		
07		
08		

EXTENSION-STATION

Station Equipment No.

Item	Set Data
Telephone Type and Model	Type _____ Model _____
OHCA Circuit	<input type="checkbox"/> <input type="checkbox"/> No
Primary Directory Number	- - - -
Intercom Number	- -
Station Name	- - - - -
ICM Group	-
Pickup Group	- - <input type="checkbox"/> None
Next Hunt Station	<input type="checkbox"/> _____ <input type="checkbox"/> None
Class of Service	- -
Data Line Security	<input type="checkbox"/> <input type="checkbox"/> No
Automatic Callback-Trunk	<input type="checkbox"/> Yes, <input type="checkbox"/> No
Parallel Connect	<input type="checkbox"/> <input type="checkbox"/> No

Key	Key Type	Number	SDN COS	Day Ring	Night Ring
DN-01	PDN		<input type="checkbox"/> Station, <input type="checkbox"/> DN		
DN-02			<input type="checkbox"/> Station, <input type="checkbox"/> DN		
DN-03			<input type="checkbox"/> Station, <input type="checkbox"/> DN		
DN-04			<input type="checkbox"/> Station, <input type="checkbox"/> DN		
DN-05			<input type="checkbox"/> Station, <input type="checkbox"/> DN		
DN-06			<input type="checkbox"/> Station, <input type="checkbox"/> DN		
DN-07			<input type="checkbox"/> Station, <input type="checkbox"/> DN		
DN-08			<input type="checkbox"/> Station, <input type="checkbox"/> DN		
DN-09			<input type="checkbox"/> fStation, ODN		
DN-10			<input type="checkbox"/> Station, nDN		
DN-11			<input type="checkbox"/> Station, <input type="checkbox"/> DN		
DN-12			<input type="checkbox"/> Station, <input type="checkbox"/> DN		

PF Key	PF Key Type	Number
01		
02		
03		
04		
05		
06		
07		
08		
09		
10		
11		
12		

DSS Key	DSS Key Type	Number
01		
02		
03		
04		
05		
06		
07		
08		



EXTENSION-STATION

Station Equipment No.

Item	Set Data
Telephone Type and Model	Type _____ Model _____
OHCA Circuit	<input type="checkbox"/> Yes, <input type="checkbox"/> <input type="checkbox"/>
Primary Directory Number	_____
Intercom Number	- - -
Station Name	_____
ICM Group	_____
Pickup Group	- - - <input type="checkbox"/> None
Next Hunt Station	<input type="checkbox"/> _____ <input type="checkbox"/> None
Class of Service	- - -
Data Line Security	<input type="checkbox"/> <input type="checkbox"/>
Automatic Callback-Trunk	<input type="checkbox"/> Yes, <input type="checkbox"/> No
Parallel Connect	<input type="checkbox"/> Yes, <input type="checkbox"/> <input type="checkbox"/>

Key	Key Type	Number	SDN COS	Day Ring	Night Ring
DN-01	PDN		<input type="checkbox"/> Station, <input type="checkbox"/> DN		
DN-02			<input type="checkbox"/> Station, <input type="checkbox"/> DN		
DN-03			<input type="checkbox"/> Station, <input type="checkbox"/> DN		
DN-04			<input type="checkbox"/> Station, <input type="checkbox"/> DN		
DN-05			<input type="checkbox"/> Station, <input type="checkbox"/> DN		
DN-06			<input type="checkbox"/> Station, <input type="checkbox"/> DN		
DN-07			<input type="checkbox"/> Station.[7DN		
DN-08			<input type="checkbox"/> StationJJDN		
DN-09			<input type="checkbox"/>]Station,nDN		
DN-10			<input type="checkbox"/> Station, <input type="checkbox"/> DN		
DN-11			<input type="checkbox"/> Station,ODN		
DN-12			<input type="checkbox"/> Station.C]DN		

PF Key	PF Key Type	Number	DSS Key	DSS Key Type	Number
01			01		
02			02		
03			03		
04			04		
05			05		
06			06		
07			07		
08			08		
09					
10					
11					
12					

EXTENSION-STATION

Station Equipment: No.

Item	Set Data
Telephone Type and Model	Type _____ Model _____
OHCA Circuit	<input type="checkbox"/> <input type="checkbox"/> No
Primary Directory Number	_____
Intercom Number	____
Station Name	_____
ICM Group	_____
Pickup Group	_____ <input type="checkbox"/> None
Next Hunt Station	<input type="checkbox"/> _____ <input type="checkbox"/> None
Class of Service	_____
Data Line Security	<input type="checkbox"/> Yes, <input type="checkbox"/>
Automatic Callback-Trunk	<input type="checkbox"/> Yes, <input type="checkbox"/>
Parallel Connect	<input type="checkbox"/> Yes, <input type="checkbox"/>

Key	Key Type	Number	SDN COS	Day Ring	Night Ring
DN-01	PDN		<input type="checkbox"/> Station, C DN		
DN-02			<input type="checkbox"/> Station, <input type="checkbox"/> DN		
DN-03			<input type="checkbox"/> Station, nDN		
DN-04			<input type="checkbox"/> Station, <input type="checkbox"/> DN		
DN-05			<input type="checkbox"/> Station, <input type="checkbox"/> DN		
DN-06			<input type="checkbox"/> Station, <input type="checkbox"/> DN		
DN-07			<input type="checkbox"/> Station, <input type="checkbox"/> DN		
DN-08			<input type="checkbox"/> Station, <input type="checkbox"/> DN		
DN-09			<input type="checkbox"/> Station, nDN		
DN-10			<input type="checkbox"/> Station, <input type="checkbox"/> DN		
DN-11			<input type="checkbox"/> Station, <input type="checkbox"/> DN		
DN-12			<input type="checkbox"/> Station, f DN		

PF Key	PF Key-Type	Number
01		
02		
03		
04		
05		
06		
07		
08		
09		
10		
11		
12		

DSS Key	DSS Key Type	Number
01		
02		
03		
04		
05		
06		
07		
08		

EXTENSION-STATION

Station Equipment No.

item	Set Data
Telephone Type and Model	Type _____ Model _____
OHCA Circuit	<input type="checkbox"/> <input type="checkbox"/>
Primary Directory Number	- - - - -
intercom Number	- -
Station Name	- - - - -
ICM Group	—
Pickup Group	- - <input type="checkbox"/> None
Next Hunt Station	<input type="checkbox"/> _____ <input type="checkbox"/> None
Class of Service	- -
Data Line Security	<input type="checkbox"/> Yes, <input type="checkbox"/> No
Automatic Callback-Trunk	<input type="checkbox"/> Yes, <input type="checkbox"/> No
Parallel Connect	<input type="checkbox"/> <input type="checkbox"/>

Key	Key Type	Number	SDN COS	Day Ring	Night Ring
DN-01	PDN		<input type="checkbox"/> Station, <input type="checkbox"/> DN		
DN-02			<input type="checkbox"/> Station, <input type="checkbox"/> DN		
DN-03			<input type="checkbox"/> Station, <input type="checkbox"/> DN		
DN-04			<input type="checkbox"/> Station, <input type="checkbox"/> DN		
DN-05			<input type="checkbox"/> Station, <input type="checkbox"/> DN		
DN-06			<input type="checkbox"/> Station, <input type="checkbox"/> DN		
DN-07			<input type="checkbox"/> Station, <input type="checkbox"/> DN		
DN-08			<input type="checkbox"/> Station, <input type="checkbox"/> DN		
DN-09			<input type="checkbox"/> Station, <input type="checkbox"/> DN		
DN-10			<input type="checkbox"/> Station, <input type="checkbox"/> DN		
DN-11			<input type="checkbox"/> Station, <input type="checkbox"/> DN		
DN-12			<input type="checkbox"/> Station, <input type="checkbox"/> DN		

PF Key	PF Key Type	Number	DSS Key	DSS Key Type	Number
01			01		
02			02		
03			03		
04			04		
05			05		
06			06		
07			07		
08			08		
09					
10					
11					
12					

EXTENSION-STATION

Station Equipment No.

Item	Se? Data
Telephone Type and Model	Type _____ Model _____
OHCA Circuit.	<input type="checkbox"/> Yes, <input type="checkbox"/> Yes <input type="checkbox"/>
Primary Directory Number	_____
Intercom Number	- -
Station Name	_____
ICM Group	_____
Pickup Group	- - 0 None
Next Hunt Station	<input type="checkbox"/> EXT _____ None
Class of Service	- -
Data Line Security	<input type="checkbox"/> Yes, <input type="checkbox"/> No
Automatic Callback-Trunk	<input type="checkbox"/> Yes, <input type="checkbox"/> Yes <input type="checkbox"/>
Parallel Connect	<input type="checkbox"/> Parallel <input type="checkbox"/> Parallel

Key	Key Type	Number	SDN COS	Day Ring	Night Ring
DN-01	PDN		<input type="checkbox"/> Station, <input type="checkbox"/> DN		
DN-02			<input type="checkbox"/> Station, <input type="checkbox"/> DN		
DN-03			<input type="checkbox"/> Station, <input type="checkbox"/> DN		
DN-04			<input type="checkbox"/> Station, <input type="checkbox"/> DN		
DN-05			<input type="checkbox"/> Station, <input type="checkbox"/> DN		
DN-06			<input type="checkbox"/> Station, <input type="checkbox"/> DN		
DN-07			<input type="checkbox"/> Station, <input type="checkbox"/> DN		
DN-08			<input type="checkbox"/> Station, <input type="checkbox"/> DN		
DN-09			<input type="checkbox"/> Station, <input type="checkbox"/> DN		
DN-10			<input type="checkbox"/> Station, <input type="checkbox"/> DN		
DN-11			<input type="checkbox"/> Station, <input type="checkbox"/> DN		
DN-12			<input type="checkbox"/> Station, <input type="checkbox"/> DN		

PF Key	PF Key Type	Number	DSS Key	DSS Key Type	Number
01			01		
02			02		
03			03		
04			04		
05			05		
06			06		
07			07		
08			08		
09					
10					
11					
12					

EXTENSION-STATION

Station Equipment No.

Item	Set Data
Telephone Type and Model	Type _____ Model _____
OHCA Circuit	<input type="checkbox"/> <input type="checkbox"/> No
Primary Directory Number	_____
intercom Number	- -
Station Name	- - - - -
ICM Group	_____
Pickup Group	- - <input type="checkbox"/> None
Next Hunt Station	<input type="checkbox"/> _____ <input type="checkbox"/> None
Class of Service	- -
Data Line Security	<input type="checkbox"/> Yes, <input type="checkbox"/> No
Automatic Callback-Trunk	<input type="checkbox"/> Yes, <input type="checkbox"/> No
Parallel Connect	<input type="checkbox"/> Yes, <input type="checkbox"/> No

Key	Key Type	Number	SDN COS	Day Ring	Night Ring
DN-01	PDN		<input type="checkbox"/> Station, <input type="checkbox"/> DN		
DN-02			<input type="checkbox"/> Station, <input type="checkbox"/> DN		
DN-03			<input type="checkbox"/> Station, <input type="checkbox"/> DN		
DN-04			<input type="checkbox"/> Station, <input type="checkbox"/> DN		
DN-05			<input type="checkbox"/> Station, <input type="checkbox"/> DN		
DN-06			<input type="checkbox"/> Station, <input type="checkbox"/> DN		
DN-07			<input type="checkbox"/> Station, <input type="checkbox"/> DN		
DN-08			<input type="checkbox"/> Station, <input type="checkbox"/> DN		
DN-09			<input type="checkbox"/> Station, <input type="checkbox"/> DN		
DN-10			<input type="checkbox"/> Station, <input type="checkbox"/> DN		
DN-11			<input type="checkbox"/> Station, <input type="checkbox"/> DN		
DN-12			<input type="checkbox"/> Station, <input type="checkbox"/> DN		

PF Key	PF Key Type	Number
01		
02		
03		
04		
05		
06		
07		
08		
09		
10		
11		
12		

DSS Key	DSS Key Type	Number
01		
02		
03		
04		
05		
06		
07		
08		

EXTENSION-STATION

Station Equipment No.

Item	Set Data
Telephone Type and Model	Type _____ Model _____
OHCA Circuit.	<input type="checkbox"/> Yes, <input type="checkbox"/> No
Primary Directory Number	_____
Intercom Number	_____
Station Name	-----
ICM Group	_____
Pickup Group	_____ 0 None
Next Hunt Station	<input type="checkbox"/> EXT <input type="checkbox"/> N o n e
Class of Service	_____
Data Line Security	<input type="checkbox"/> Yes, <input type="checkbox"/> No
Automatic Callback-Trunk	<input type="checkbox"/> Yes, <input type="checkbox"/> No
Parallel Connect	<input type="checkbox"/> Yes, <input type="checkbox"/> No

Key	Key Type	Number	SDN	COS	Day Ring	Night Ring
DN-01	PDN		<input type="checkbox"/> Station, <input type="checkbox"/> DN			
DN-02			<input type="checkbox"/> Station, ODN			
DN-03			<input type="checkbox"/> Station, <input type="checkbox"/> DN			
DN-04			<input type="checkbox"/> Station, <input type="checkbox"/> DN			
DN-05			<input type="checkbox"/> Station, <input type="checkbox"/> DN			
DN-06			<input type="checkbox"/> Station, <input type="checkbox"/> DN			
DN-07			<input type="checkbox"/> Station, <input type="checkbox"/> DN			
DN-08			<input type="checkbox"/> Station, <input type="checkbox"/> DN			
DN-09			<input type="checkbox"/> Station, <input type="checkbox"/> DN			
DN-10			<input type="checkbox"/> Station, ODN			
DN-11			<input type="checkbox"/> Station, <input type="checkbox"/> DN			
DN-12			<input type="checkbox"/> Station, ODN			

PF Key	PF Key Type	Number	DSS Key	DSS Key Type	Number
01			01		
02			02		
03			03		
04			04		
05			05		
06			06		
07			07		
08			08		
09					
10					
11					
12					

EXTENSION-STATION

Station Equipment No.

Item	Set Data
Telephone Type and Model	Type _____ Model _____
OHCA Circuit	<input type="checkbox"/> Yes, <input type="checkbox"/> No
Primary Directory Number	- - - -
Intercom Number	- -
Station Name	_____
ICM Group	_____
Pickup Group	- - <input type="checkbox"/> None
Next Hunt Station	<input type="checkbox"/> <input type="checkbox"/> _____ <input type="checkbox"/> None
Class of Service	- -
Data Line Security	<input type="checkbox"/> Yes <input type="checkbox"/> <input type="checkbox"/>
Automatic Callback-Trunk	<input type="checkbox"/> Yes, <input type="checkbox"/> No
Parallel Connect	<input type="checkbox"/> Yes <input type="checkbox"/>

Key	Key Type	Number	SDN COS	Day Ring	Night Ring
DN-01	PDN		<input type="checkbox"/> Station, <input type="checkbox"/> DN		
DN-02			<input type="checkbox"/> Station, <input type="checkbox"/> DN		
DN-03			<input type="checkbox"/> Station, <input type="checkbox"/> DN		
DN-04			<input type="checkbox"/> Station, <input type="checkbox"/> DN		
DN-05			<input type="checkbox"/> Station, <input type="checkbox"/> DN		
DN-06			<input type="checkbox"/> Station, <input type="checkbox"/> DN		
DN-07			<input type="checkbox"/> Station, <input type="checkbox"/> DN		
DN-08			<input type="checkbox"/> Station, <input type="checkbox"/> DN		
DN-09			<input type="checkbox"/> Station, <input type="checkbox"/> DN		
DN-10			<input type="checkbox"/> Station, nDN		
DN-11			<input type="checkbox"/> Station, <input type="checkbox"/> DN		
DN-12			<input type="checkbox"/> Station, C]DN		

PF Key	PF Key Type	Number	DSS Key	DSS Key Type	Number
01			01		
02			02		
03			03		
04			04		
05			05		
06			06		
07			07		
08			08		
09					
10					
11					
12					

EXTENSION-STATION

Station Equipment No.

Item	Set Data
Telephone Type and Model	Type _____ Model _____
OHCA Circuit	<input type="checkbox"/> <input type="checkbox"/> No
Primary Directory Number	- - - - -
Intercom Number	- -
Station Name	_____
ICM Group	_____
Pickup Group	- - - <input type="checkbox"/> None
Next Hunt Station	<input type="checkbox"/> EXT <input type="checkbox"/> <input type="checkbox"/> <input type="checkbox"/>
Class of Service	- -
Data Line Security	<input type="checkbox"/> <input type="checkbox"/> No
Automatic Callback-Trunk	<input type="checkbox"/> Yes, <input type="checkbox"/> No
Parallel Connect	<input type="checkbox"/> <input type="checkbox"/> No

Key	Key Type	Number	SDN COS	Day Ring	Night Ring
DN-01	PDN		<input type="checkbox"/> Station, <input type="checkbox"/> DN		
DN-02			<input type="checkbox"/> Station, <input type="checkbox"/> DN		
DN-03			<input type="checkbox"/> Station, <input type="checkbox"/> DN		
DN-04			<input type="checkbox"/> Station, <input type="checkbox"/> DN		
DN-05			<input type="checkbox"/> Station, <input type="checkbox"/> DN		
DN-06			<input type="checkbox"/> Station, <input type="checkbox"/> DN		
DN-07			<input type="checkbox"/> Station, <input type="checkbox"/> DN		
DN-08			<input type="checkbox"/> Station, <input type="checkbox"/> DN		
DN-09			<input type="checkbox"/> Station, <input type="checkbox"/> DN		
DN-10			<input type="checkbox"/> Station, <input type="checkbox"/> DN		
DN-11			<input type="checkbox"/> Station, <input type="checkbox"/> DN		
DN-12			<input type="checkbox"/> Station, <input type="checkbox"/> DN		

PF Key	PF Key Type	Number
01		
02		
03		
04		
05		
06		
07		
08		
09		
10		
11		
12		

DSS Key	DSS Key Type	Number
C1		
C2		
C3		
C4		
C5		
C6		
C7		
C8		

EXTENSION-STATION

Station Equipment No.

Item	SE: Data
Telephone Type and Model	Type _____ Model _____
OHCA Circuit	<input type="checkbox"/> <input type="checkbox"/> <input type="checkbox"/> <input type="checkbox"/> <input type="checkbox"/> <input type="checkbox"/>
Primary Directory Number	- - - - -
Intercom Number	- - -
Station Name	_____
ICM Group	---
Pickup Group	- - - 0 None
Next Hunt Station	<input type="checkbox"/> <input type="checkbox"/> <input type="checkbox"/> <input type="checkbox"/> _____ <input type="checkbox"/> None
Class of Service	- - -
Data Line Security	<input type="checkbox"/> Yes, <input type="checkbox"/> No
Automatic Callback-Trunk	<input type="checkbox"/> Yes, <input type="checkbox"/> No
Parallel Connect	<input type="checkbox"/> Yes, <input type="checkbox"/> <input type="checkbox"/> <input type="checkbox"/>

Key	Key Type	Number	SDN	COS	Day Ring	Night Ring
DN-01	PDN		<input type="checkbox"/> Station, <input type="checkbox"/> DN			
DN-02			<input type="checkbox"/> Station, <input type="checkbox"/> DN			
DN-03			<input type="checkbox"/> Station, <input type="checkbox"/> DN			
DN-04			<input type="checkbox"/> Station, <input type="checkbox"/> DN			
DN-05			<input type="checkbox"/> Station, <input type="checkbox"/> DN			
DN-06			<input type="checkbox"/> Station, <input type="checkbox"/> DN			
DN-07			<input type="checkbox"/> Station, <input type="checkbox"/> DN			
DN-08			<input type="checkbox"/> Station, <input type="checkbox"/> DN			
DN-09			<input type="checkbox"/> Station, <input type="checkbox"/> DN			
DN-10			<input type="checkbox"/> Station, <input type="checkbox"/> DN			
DN-11			<input type="checkbox"/> Station, <input type="checkbox"/> DN			
DN-12			<input type="checkbox"/> Station, <input type="checkbox"/> DN			

PF Key	PF Key Type	Number	DSS Key	DSS Key Type	Number
01			01		
02			02		
03			03		
04			04		
05			05		
06			06		
07			07		
08			08		
09					
10					
11					
12					

EXTENSION-STATION

Station Equipment No.

Item	Set Data
Telephone Type and Model	Type _____ Model _____
OHCA Circuit	<input type="checkbox"/> Yes <input type="checkbox"/> No <input type="checkbox"/>
Primary Directory Number	- - - - -
intercom Number	- -
Station Name	_____
ICM Group	_____
Pickup Group	- - <input type="checkbox"/> None
Next Hunt Station	<input type="checkbox"/> _____ <input type="checkbox"/> None
Class of Service	- -
Data- Line Security	<input type="checkbox"/> Yes <input type="checkbox"/> No <input type="checkbox"/>
Automatic Callback-Trunk	<input type="checkbox"/> Yes <input type="checkbox"/> No
Parallel Connect	<input type="checkbox"/> Yes, <input type="checkbox"/> No

Key	Key Type	Number	SDN	COS	Day Ring	Night Ring
DN-01	PDN		<input type="checkbox"/> Station,	<input type="checkbox"/> Db		
DN-02			<input type="checkbox"/> Station,	<input type="checkbox"/> DN		
DN-03			<input type="checkbox"/> Station,	<input type="checkbox"/> DN		
DN-04			<input type="checkbox"/> Station,	<input type="checkbox"/> DN		
DN-05			<input type="checkbox"/> Station,	<input type="checkbox"/> DN		
DN-06			<input type="checkbox"/> Station.Odb			
DN-07			<input type="checkbox"/> Station,[7DN			
DN-08			<input type="checkbox"/> Station,	<input type="checkbox"/> DN		
DN-09			<input type="checkbox"/> Station,	<input type="checkbox"/> DN		
DN-10			<input type="checkbox"/> Station,	<input type="checkbox"/> DN		
DN-11			<input type="checkbox"/> Station,nDN			
DN-12			<input type="checkbox"/> Station,	<input type="checkbox"/> DN		

PF Key	PF Key Type	Number	DSS Key	DSS Kay Type	Number
01			01		
02			02		
03			03		
04			04		
05			05		
06			06		
- 07			07		
08			08		
09					
10					
11					
12					

EXTENSION-STATION

Station Equipment No.

item	Set Data
Telephone Type and Model	Type _____ Model _____
OHCA Circuit	<input type="checkbox"/> <input type="checkbox"/> No
Primary Directory Number	_____
intercom Number	_____
Station Name	_____
ICM Group	_____
Pickup Group	_____ <input type="checkbox"/> None
Next Hunt Station	<input type="checkbox"/> EXT _____ N o n e
Class of Service	_____
Data Line Security	<input type="checkbox"/> <input type="checkbox"/> No
Automatic Callback-Trunk	<input type="checkbox"/> <input type="checkbox"/> No
Parallel Connect	<input type="checkbox"/> Yes, <input type="checkbox"/> No

Key	Key Type	Number	SDN COS	Day Ring	Night Ring
DN-01	PDN		<input type="checkbox"/> Strcn, <input type="checkbox"/> DN		
DN-02			<input type="checkbox"/> Stint, <input type="checkbox"/> DN		
DN-03			<input type="checkbox"/> st=cn, <input type="checkbox"/> DN		
DN-04			<input type="checkbox"/> <input type="checkbox"/> DN		
DN-05			<input type="checkbox"/> Stacon, <input type="checkbox"/> DN		
DN-06			<input type="checkbox"/> S?zazn, <input type="checkbox"/> DN		
DN-07			<input type="checkbox"/> S:3xn, <input type="checkbox"/> DN		
DN-08			<input type="checkbox"/> Stacon, <input type="checkbox"/> DN		
DN-09			<input type="checkbox"/> St3:on, mDN		
DN-10			<input type="checkbox"/> Stdon, <input type="checkbox"/> DN		
DN-11			<input type="checkbox"/> Stacon, <input type="checkbox"/> DN		
DN-12			<input type="checkbox"/> Stacon, <input type="checkbox"/> DN		

PF Key	PF Key Type	Number	DSS Key	DSS Key Type	Number
01			01		
02			02		
03			03		
04			04		
05			05		
06			06		
07			07		
08			08		
09					
10					
11					
12					

EXTENSION-STATION

Station Equipment No.

Item	Set Data
Telephone Type and Model	Type _____ Model _____
OHCACircuit	<input type="checkbox"/> Yes, <input type="checkbox"/> No
Primary Directory Number	-----
Intercom Number	---
Station Name	-----
ICM Group	
Pickup Group	_____ <input type="checkbox"/> None
Next Hunt Station	<input type="checkbox"/> _____ <input type="checkbox"/> None
Class of Service	<input type="checkbox"/> No
Data Line Security	<input type="checkbox"/> No
Automatic Callback-Trunk	<input type="checkbox"/> Yes, <input type="checkbox"/> No
Parallel Connect	<input type="checkbox"/> <input type="checkbox"/> No

Key	Key Type	Number	SDN COS	Day Ring	Night Ring
DN-01	PDN		<input type="checkbox"/> Station, <input type="checkbox"/> JDN		
DN-02			<input type="checkbox"/> Station, <input type="checkbox"/> nDN		
DN-03			<input type="checkbox"/> Station, <input type="checkbox"/> DN		
DN-04			<input type="checkbox"/> Station, <input type="checkbox"/> DN		
DN-05			<input type="checkbox"/> Station, <input type="checkbox"/> DN		
DN-06			<input type="checkbox"/> Station, <input type="checkbox"/> DN		
DN-07			<input type="checkbox"/> Station, <input type="checkbox"/> DN		
DN-08			<input type="checkbox"/> Station, <input type="checkbox"/> DN		
DN-09			<input type="checkbox"/> Station, <input type="checkbox"/> DN		
DN-10			<input type="checkbox"/> Station, <input type="checkbox"/> DN		
DN-11			<input type="checkbox"/> Station, <input type="checkbox"/> DN		
DN-12			<input type="checkbox"/> Station, <input type="checkbox"/> DN		

PF Key	PF Key Type	Number	DSS Key	DSS Key Type	Number
01			01		
02			02		
03			03		
04			04		
05			05		
06			06		
07			07		
08			08		
09					
10					
11					
12					

EXTENSION-STATION

Station Equipment No.

item	Set Data
Telephone Type and Model	Type _____ Model _____
OHCA Circuit	<input type="checkbox"/> <input type="checkbox"/> <input type="checkbox"/> <input type="checkbox"/> NO
Primary Directory Number	- - - -
Intercom Number	- -
Station Name	_____
ICM Group	_____
Pickup Group	- - <input type="checkbox"/> None
Next Hunt Station	<input type="checkbox"/> <input type="checkbox"/> <input type="checkbox"/> _____ <input type="checkbox"/> None
Class of Service	- -
Data Line Security	<input type="checkbox"/> Yes, <input type="checkbox"/> <input type="checkbox"/>
Automatic Callback-Trunk	<input type="checkbox"/> Yes, <input type="checkbox"/> No
Parallel Connect	<input type="checkbox"/> Yes, <input type="checkbox"/> No

Key	Key Type	Number	SDNCOS	Day Ring	Night Ring
DN-01	PDN		<input type="checkbox"/> Station, <input type="checkbox"/> DN		
DN-02			<input type="checkbox"/> Station, <input type="checkbox"/> DN		
DN-03			<input type="checkbox"/> Station, <input type="checkbox"/> DN		
DN-04			<input type="checkbox"/> Station, <input type="checkbox"/> DN		
DN-05			<input type="checkbox"/> Station, <input type="checkbox"/> DN		
DN-06			<input type="checkbox"/> Station, <input type="checkbox"/> DN		
DN-07			<input type="checkbox"/> Station, CDN		
DN-08			<input type="checkbox"/> Station, <input type="checkbox"/> DN		
DN-09			<input type="checkbox"/> Station, CDN		
DN-10			<input type="checkbox"/> Station, <input type="checkbox"/> DN		
DN-11			<input type="checkbox"/> Station, <input type="checkbox"/> DN		
DN-12			<input type="checkbox"/> Station, <input type="checkbox"/> DN		

PF Key	PF Key Type	Number	DSS Key	DSS Key Type	Number
01			01		
02			02		
03			03		
04			04		
05			05		
06			06		
07			07		
08			08		
09					
10					
11					
12					

EXTENSION-STATION

Station Equipment No.

Item	Set Data
Telephone Type and Model	Type _____ Model _____
OHCA Circuit	<input type="checkbox"/> <input type="checkbox"/> No
Primary Directory Number	- - - -
Intercom Number	- -
Station Name	_____
ICM Group	_____
Pickup Group	- - <input type="checkbox"/> None
Next Hunt Station	<input type="checkbox"/> _____ <input type="checkbox"/> None
Class of Service	- -
Data Line Security	<input type="checkbox"/> Yes, <input type="checkbox"/> No
Automatic Callback-Trunk	<input type="checkbox"/> <input type="checkbox"/> No
Parallel Connect	<input type="checkbox"/> Yes, <input type="checkbox"/> No

Key	Key Type	Number	SDN COS	Day Ring	Night Ring
DN-01	PDN		<input type="checkbox"/> Station, <input type="checkbox"/> DN		
DN-02			<input type="checkbox"/> Station, <input type="checkbox"/> DN		
DN-03			<input type="checkbox"/> Station, <input type="checkbox"/> DN		
DN-04			<input type="checkbox"/> Station, <input type="checkbox"/> DN		
DN-05			<input type="checkbox"/> Station, <input type="checkbox"/> DN		
DN-06			<input type="checkbox"/> Station, <input type="checkbox"/> DN		
DN-07			<input type="checkbox"/> Station, <input type="checkbox"/> ODN		
DN-08			<input type="checkbox"/> Station, <input type="checkbox"/> ODN		
DN-09			<input type="checkbox"/> Station, <input type="checkbox"/> DN		
DN-10			<input type="checkbox"/> Station, <input type="checkbox"/> DN		
DN-11			<input type="checkbox"/> Station, <input type="checkbox"/> DN		
DN-12			<input type="checkbox"/> Station, <input type="checkbox"/> uDN		

PF Key	PF Key Type	Number	DSS Key	DSS Key Type	Number
01			01		
02			02		
03			03		
04			04		
05			05		
06			06		
07			07		
08			08		
09					
10					
11					
12					

EXTENSION-STATION

Station Equipment No.

Item	Set Data
Telephone Type and Model	Type _____ Model _____
OHCA Circuit	<input type="checkbox"/> Yes, <input type="checkbox"/> No
Primary Directory Number	- - - - -
Intercom Number	- - -
Station Name	_____
ICM Group	_____
Pickup Group	_____ 7 None
Next Hunt Station	<input type="checkbox"/> _____ <input type="checkbox"/> None
Class of Service	
Data Line Security	<input type="checkbox"/> <input type="checkbox"/> No
Automatic Callback-Trunk	<input type="checkbox"/> Yes, <input type="checkbox"/> No
Parallel Connect	<input type="checkbox"/> <input type="checkbox"/> No

Key	Key Type	Numbs-	SDN COS	Day Ring	Night Ring
DN-01	PDN		<input type="checkbox"/> Station, <input type="checkbox"/> nDN		
DN-02			<input type="checkbox"/> Station, <input type="checkbox"/> DN		
DN-03			<input type="checkbox"/> Station, <input type="checkbox"/> DN		
DN-04			<input type="checkbox"/> Station, <input type="checkbox"/> DN		
DN-05			<input type="checkbox"/> Station, <input type="checkbox"/> nDN		
DN-06			<input type="checkbox"/> Station, <input type="checkbox"/> DN		
DN-07			<input type="checkbox"/> Station, <input type="checkbox"/> DN		
DN-08			<input type="checkbox"/> Station, <input type="checkbox"/> DN		
DN-09			<input type="checkbox"/> Station, <input type="checkbox"/> DN		
DN-10			<input type="checkbox"/> Station, <input type="checkbox"/> DN		
DN-11			<input type="checkbox"/> Station, <input type="checkbox"/> DN		
DN-12			<input type="checkbox"/> Station, <input type="checkbox"/> DN		

PF Key	PF Key Type	Number	DSS Key	DSS Key Type	Number
01			01		
02			02		
03			03		
04			04		
05			05		
06			06		
07			07		
08			08		
09					
10					
11					
12					

EXTENSION-STATION

Station Equipment No.

Item	Set Data
Telephone Type and Model	Type _____ Model _____
OHCA Circuit	<input type="checkbox"/> Yes, <input type="checkbox"/> No
Primary Directory Number	_____
Intercom Number	_____
Station Name	_____
ICM Group	_____
Pickup Group	_____ <input type="checkbox"/> None
Next Hunt Station	<input type="checkbox"/> EXT _____ <input type="checkbox"/> None
Class of Service	_____
Data Line Security	<input type="checkbox"/> Yes, <input type="checkbox"/> No
Automatic Callback-Trunk	<input type="checkbox"/> Yes, <input type="checkbox"/> No
Parallel Connect	<input type="checkbox"/> Yes, <input type="checkbox"/> No

Key	Key Type	Number	SDN	COS	Day Ring	Night Ring
DN-01	PDN		<input type="checkbox"/> Station	<input type="checkbox"/> DN		
DN-02			<input type="checkbox"/> Station	<input type="checkbox"/> DN		
DN-03			<input type="checkbox"/> Station	<input type="checkbox"/> DN		
DN-04			<input type="checkbox"/> Station	<input type="checkbox"/> DN		
DN-05			<input type="checkbox"/> Station	<input type="checkbox"/> DN		
DN-06			<input type="checkbox"/> Station	<input type="checkbox"/> DN		
DN-07			<input type="checkbox"/> Station	<input type="checkbox"/> DN		
DN-08			<input type="checkbox"/> Station	<input type="checkbox"/> DN		
DN-09			<input type="checkbox"/> Station	<input type="checkbox"/> DN		
DN-10			<input type="checkbox"/> Station	<input type="checkbox"/> DN		
DN-11			<input type="checkbox"/> Station	<input type="checkbox"/> DN		
DN-12			<input type="checkbox"/> Station	<input type="checkbox"/> DN		

PF Key	PF Key Type	Number	DSS Key	DSS Key Type	Number
01			01		
02			02		
03			03		
04			04		
05			05		
06			06		
07			07		
08			08		
09					
10					
11					
12					

EXTENSION-STATION

Station Equipment No.

Item	Set Data
Telephone Type and Model	Type _____ Model _____
OHCA Circuit	<input type="checkbox"/> Yes, <input type="checkbox"/> No
Primary Directory Number	- - - - -
Intercom Number	- -
Station Name	_____
ICM Group	_____
Pickup Group	- - <input type="checkbox"/> None
Next Hunt Station	<input type="checkbox"/> EXT <input type="checkbox"/> N o n e
Class of Service	- -
Data Line Security	<input type="checkbox"/> Yes, <input type="checkbox"/> No
Automatic Callback-Trunk	<input type="checkbox"/> Yes, <input type="checkbox"/> No
Parallel Connect	<input type="checkbox"/> Yes, <input type="checkbox"/> No

Key	Key Type	Number	SDN	COS	Day Ring	Night Ring
DN-01	PDN		<input type="checkbox"/>	Station,nDN		
DN-02			<input type="checkbox"/>	Station, <input type="checkbox"/> DN,		
DN-03			<input type="checkbox"/>	Station,CjDN		
DN-04			<input type="checkbox"/>]Station, <input type="checkbox"/> DN		
DN-05			<input type="checkbox"/>	Station, <input type="checkbox"/> DN		
DN-06			<input type="checkbox"/>	Station, <input type="checkbox"/> DN		
DN-07			<input type="checkbox"/>	Station,nDN		
DN-08			<input type="checkbox"/>]Station,CjDN		
DN-09			<input type="checkbox"/>	Station, <input type="checkbox"/> DN		
DN-10			<input type="checkbox"/>	Station, <input type="checkbox"/> DN		
DN-11			<input type="checkbox"/>	Station, <input type="checkbox"/> DN		
DK12			<input type="checkbox"/>	ation,nDN		

PF Key	PF Key Type	Number	DSS Key	DSS Key Type	Number
01			01		
02			02		
03			03		
04			04		
05			05		
06			06		
07			07		
08			08		
09					
10					
11					
12					

EXTENSION-STATION

Station Equipment No. _____

Item	Set Data
Telephone Type and Model	Type _____ Model _____
OHCA Circuit	<input type="checkbox"/> Yes, <input type="checkbox"/> No
Primary Directory Number	_____
Intercom Number	_____
Station Name	_____
ICM Group	_____
Pickup Group	_____ <input type="checkbox"/> None
Next Hunt Station	<input type="checkbox"/> EXT _____ <input type="checkbox"/> None
Class of Service	_____
Data Line Security	<input type="checkbox"/> Yes, <input type="checkbox"/> No
Automatic Callback - Trunk	<input type="checkbox"/> Yes, <input type="checkbox"/> <input type="checkbox"/>
Parallel Connect	<input type="checkbox"/> Yes, <input type="checkbox"/> <input type="checkbox"/>

Key	Key Type	Number	SDN COS	Day Ring	Night Ring
DN-01	PDN		<input type="checkbox"/> Station, <input type="checkbox"/> DN		
DN-02			<input type="checkbox"/> Station, <input type="checkbox"/> DN		
DN-03			<input type="checkbox"/> Station, <input type="checkbox"/> DN		
DN-04			<input type="checkbox"/> Station, <input type="checkbox"/> DN		
DN-05			<input type="checkbox"/> Station, <input type="checkbox"/> DN		
DN-06			<input type="checkbox"/> Station, <input type="checkbox"/> DN		
DN-07			<input type="checkbox"/> Station, <input type="checkbox"/> DN		
DN-08			<input type="checkbox"/> Station, <input type="checkbox"/> DN		
DN-09			<input type="checkbox"/> Station, <input type="checkbox"/> DN		
DN-10			<input type="checkbox"/> Station, <input type="checkbox"/> DN		
DN-11			<input type="checkbox"/> Station, <input type="checkbox"/> DN		
DN-12			<input type="checkbox"/> Station, <input type="checkbox"/> DN		

PF Key	PF Key Type	Number
01		
02		
03		
04		
05		
06		
07		
08		
09		
10		
11		
12		

DSS Key	DSS Key Type	Number
01		
02		
03		
04		
05		
06		
07		
08		

EXTENSION-STATION

Station Equipment No.

Item	Set Data
Telephone Type and Model	Type _____ Model _____
OHCA Circuit	<input type="checkbox"/> Yes, <input type="checkbox"/> <input type="checkbox"/>
Primary Directory Number	_____
Intercom Number	_____
Station Name	_____
ICM Group	_____
Pickup Group	_____ 0 None
Next Hunt Station	<input type="checkbox"/> _____ <input type="checkbox"/> None
Class of Service	_____
Data Line Security	<input type="checkbox"/> <input type="checkbox"/> <input type="checkbox"/>
Automatic Callback-Trunk	<input type="checkbox"/> Yes, <input type="checkbox"/> <input type="checkbox"/>
Parallel Connect	<input type="checkbox"/> Yes, <input type="checkbox"/> <input type="checkbox"/>

Key	Key Type	Number	SDN COS	Day Ring	Night Ring
DN-01	PDN		<input type="checkbox"/> Station, <input type="checkbox"/> DN		
DN-02			<input type="checkbox"/> Station, <input type="checkbox"/> DN		
DN-03			<input type="checkbox"/> Station, <input type="checkbox"/> DN		
DN-04			<input type="checkbox"/> Station, <input type="checkbox"/> DN		
DN-05			<input type="checkbox"/> Station, <input type="checkbox"/> DN		
DN-06			<input type="checkbox"/> Station, <input type="checkbox"/> DN		
DN-07			<input type="checkbox"/> Station, <input type="checkbox"/> DN		
DN-08			<input type="checkbox"/> Station, <input type="checkbox"/> DN		
DN-09			<input type="checkbox"/> Station, <input type="checkbox"/> DN		
DN-10			<input type="checkbox"/> Station, <input type="checkbox"/> DN		
DN-11			<input type="checkbox"/> Station, <input type="checkbox"/> DN		
DN-12			<input type="checkbox"/> Station, <input type="checkbox"/> DN		

PF Key	PF Key Type	Number	DSS Key	DSS Key Type	Number
01			01		
02			02		
03			03		
04			04		
05			05		
06			06		
07			07		
08			08		
09					
10					
11					
12					

EXTENSION-STATION

Station Equipment No.

item	Set Data
Telephone Type and Model	Type _____ Model _____
OHCA Circuit	<input type="checkbox"/> Yes <input type="checkbox"/> No
Primary Directory Number	- - - -
Intercom Number	- -
Station Name	- - - - - - - - - -
ICM Group	-
Pickup Group	- - <input type="checkbox"/> None
Next Hunt Station	<input type="checkbox"/> E: - - - - - <input type="checkbox"/> None
Class of Service	- -
Data Line Security	<input type="checkbox"/> Yes <input type="checkbox"/> No
Automatic Callback-Trunk	<input type="checkbox"/> Yes <input type="checkbox"/> No
Parallel Connect	<input type="checkbox"/> Yes <input type="checkbox"/> No

Key	Key Type	Number	SDN COS	Day Ring	Night Ring
DN-01	PDN		<input type="checkbox"/> Station, <input type="checkbox"/> DN		
DN-02			<input type="checkbox"/> Station, <input type="checkbox"/> DN		
DN-03			<input type="checkbox"/> Station, <input type="checkbox"/> DN		
DN-04			<input type="checkbox"/> Station, <input type="checkbox"/> DN		
DN-05			<input type="checkbox"/> Station, <input type="checkbox"/> DN		
DN-06			<input type="checkbox"/> Station, <input type="checkbox"/> DN		
DN-07			<input type="checkbox"/> Station, <input type="checkbox"/> DN		
DN-08			<input type="checkbox"/> Station, nDN		
DN-09			<input type="checkbox"/> Station, ODN		
DN-10			<input type="checkbox"/> Station, <input type="checkbox"/> DN		
DN-11			<input type="checkbox"/> Station, ODN		
DN-12			<input type="checkbox"/> Station, <input type="checkbox"/> DN		

PF Key	PF Key Type	Number	DSS Key	DSS Key Type	Number
01			01		
02			02		
03			03		
04			04		
05			05		
06			06		
07			07		
08			08		
09					
10					
11					
12					

EXTENSION-STATION

Station Equipment No.

Item	Set Data
Telephone Type and Model	Type _____ Model _____
OHCA Circuit	<input type="checkbox"/> Yes, <input type="checkbox"/> No
Primary Directory Number	- - - - -
Intercom Number	- -
Station Name	-----
ICM Group	---
Pickup Group	- - 0 None
Next Hunt Station	<input type="checkbox"/> <input type="checkbox"/> <input type="checkbox"/> <input type="checkbox"/> <input type="checkbox"/> <input type="checkbox"/> None
Class of Service	- -
Data Line Security	<input type="checkbox"/> <input type="checkbox"/> <input type="checkbox"/>
Automat:& Callback-Trunk	<input type="checkbox"/> Yes, <input type="checkbox"/> No
Parallel Connect	<input type="checkbox"/> Yes, <input type="checkbox"/> <input type="checkbox"/>

Key	Key Type	Number	SDN COS	Day Ring	Night Ring
DN-01	PDN		<input type="checkbox"/> Station, <input type="checkbox"/> DN		
DN-02			<input type="checkbox"/> Station, <input type="checkbox"/> DN		
DN-03			<input type="checkbox"/> Station, <input type="checkbox"/> DN		
DN-04			<input type="checkbox"/> Station, <input type="checkbox"/> DN		
DN-05			<input type="checkbox"/> Station, <input type="checkbox"/> DN		
DN-06			<input type="checkbox"/> Station, <input type="checkbox"/> DN		
DN-07			<input type="checkbox"/> Station, <input type="checkbox"/> DN		
DN-08			<input type="checkbox"/> Station, <input type="checkbox"/> DN		
DN-09			<input type="checkbox"/> Station, <input type="checkbox"/> DN		
DN-10			<input type="checkbox"/> Station, <input type="checkbox"/> DN		
DN-11			<input type="checkbox"/> Station, <input type="checkbox"/> DN		
DN-12			<input type="checkbox"/> Station, <input type="checkbox"/> DN		

PF Key	PF Key Type	Number
01		
02		
03		
04		
05		
06		
07		
08		
09		
10		
11		
12		

DSS Key	DSS Key Type	Number
01		
02		
03		
04		
05		
06		
07		
08		

EXTENSION-STATION

Station Equipment No.

Item	Set Data
Telephone Type and Model	Type _____ Model _____
OHCA Circuit	<input type="checkbox"/> <input type="checkbox"/> No
Primary Directory Number	- - - -
Intercom Number	- -
Station Name	_____
ICM Group	_____
Pickup Group	- - <input type="checkbox"/> None
Next Hunt Station	<input type="checkbox"/> <input type="checkbox"/> <input type="checkbox"/> <input type="checkbox"/> <input type="checkbox"/> None
Class of Service	- -
Data Line Security	<input type="checkbox"/> Yes, <input type="checkbox"/> <input type="checkbox"/>
Automatic Callback-Trunk	<input type="checkbox"/> Yes, <input type="checkbox"/> No
Parallel Connect	<input type="checkbox"/> Yes, <input type="checkbox"/> <input type="checkbox"/>

Key	Key Type	Number	SDN COS	Day Ring	Night Ring
DN-01	P DN		<input type="checkbox"/> Station,uDN		
DN-02			<input type="checkbox"/> Station, <input type="checkbox"/> DN		
DN-03			<input type="checkbox"/> Station, <input type="checkbox"/> DN		
DN-04			<input type="checkbox"/> Station, <input type="checkbox"/> DN		
DN-06			<input type="checkbox"/> Station.ODN		
DN-06			<input type="checkbox"/> Station,C]DN		
DN-07			<input type="checkbox"/> Station,nDN		
DN-08			<input type="checkbox"/> Station, <input type="checkbox"/> DN		
DN-09			<input type="checkbox"/> Station, <input type="checkbox"/> DN		
DN-10			<input type="checkbox"/> Station, <input type="checkbox"/> DN		
DN-11			<input type="checkbox"/> Station,ODN		
DN-12			<input type="checkbox"/> Station. <input type="checkbox"/> DN		

PF Key	PF Key Type	Number
01		
02		
03		
04		
05		
06		
07		
08		
09		
10		
11		
12		

DSS Key	DSS Key Type	Number
01		
02		
03		
04		
05		
06		
07		
08		

EXTENSION-STATION

Station Equipment No.

Item	Set Data
Telephone Type and Model	Type _____ Model _____
CHCA Circuit	<input type="checkbox"/> Yes, <input type="checkbox"/> No
Primary Directory Number	_____
Intercom Number	- -
Station Name	- - - - -
ICM Group	_____
Pickup Group	- - <input type="checkbox"/> None
*Ext Hunt Station	<input type="checkbox"/> EXT - - - - <input type="checkbox"/> None
Class of Service	- -
Data Line Security	<input type="checkbox"/> Yes, <input type="checkbox"/> No
Automatic Callback-Trunk	<input type="checkbox"/> Yes, <input type="checkbox"/> No
Parallel Connect	<input type="checkbox"/> Yes, <input type="checkbox"/> No

Key	Key Type	Number	SDN COS	Day Ring	Night Ring
DN-01	PDN		<input type="checkbox"/> Station, <input type="checkbox"/> DN		
DN-02			<input type="checkbox"/> Station, <input type="checkbox"/> DN		
DN-03			<input type="checkbox"/> Station, <input type="checkbox"/> DN		
DN-04			<input type="checkbox"/> Station, <input type="checkbox"/> DN		
DN-05			<input type="checkbox"/> Station, <input type="checkbox"/> DN		
DN-06			<input type="checkbox"/> Station, <input type="checkbox"/> DN		
DN-07			<input type="checkbox"/> Station, <input type="checkbox"/> DN		
DN-08			<input type="checkbox"/> Station, <input type="checkbox"/> DN		
DN-09			<input type="checkbox"/> Station, <input type="checkbox"/> DN		
DN-10			<input type="checkbox"/> Station, <input type="checkbox"/> DN		
DN-11			<input type="checkbox"/> Station, <input type="checkbox"/> DN		
DN-12			<input type="checkbox"/> Station, <input type="checkbox"/> DN		

PF Key	PF Key Type	Number
01		
02		
03		
04		
05		
06		
07		
08		
09		
10		
11		
12		

DSS Key	DSS Key Type	Number
01		
02		
03		
04		
05		
06		
07		
08		

EXTENSION-STATION

Station Equipment No.

Item	Set Data
Telephone Type and Model	Type _____ Model _____
OHCA Circuit	<input type="checkbox"/> Yes, <input type="checkbox"/> No
Primary Directory Number	- - - -
Intercom Number	- -
Station Name	_____
ICM Group	_____
Pickup Group	- - <input type="checkbox"/> None
Next Hunt Station	<input type="checkbox"/> <input type="checkbox"/> None
Class of Service	- -
Data Line Security	<input type="checkbox"/> Yes, <input type="checkbox"/> No
Automatic Callback-Trunk	<input type="checkbox"/> Yes, <input type="checkbox"/> No
Parallel Connect	<input type="checkbox"/> Yes, <input type="checkbox"/> No

Key	Key Type	Number	SDN COS	Day Ring	Night Ring
DN-01	PDN		<input type="checkbox"/> Station, <input type="checkbox"/> DN		
DN-02			<input type="checkbox"/> Station, <input type="checkbox"/> DN		
DN-03			<input type="checkbox"/> Station, <input type="checkbox"/> DN		
DN-04			<input type="checkbox"/> Station, ODN		
DN-06			<input type="checkbox"/> Station, ODN		
DN-06			<input type="checkbox"/> Station, <input type="checkbox"/> DN		
DN-07			<input type="checkbox"/> Station, <input type="checkbox"/> DN		
DN-08			<input type="checkbox"/> Station, <input type="checkbox"/> DN		
DN-09			<input type="checkbox"/> Station, <input type="checkbox"/> DN		
DN-10			<input type="checkbox"/> Station, <input type="checkbox"/> DN		
DN-11			<input type="checkbox"/> Station, <input type="checkbox"/> DN		
DN-12			<input type="checkbox"/> Station, ODN		

PF Key	PF Key Type	Number	DSS Key	DSS Key Type	Number
01			01		
02			02		
03			03		
04			04		
05			05		
06			06		
07			07		
08			08		
09					
10					
11					
12					

EXTENSION-STATION

Station Equipment No.

Item	Set Data
Telephone Type and Model	Type _____ Model _____
OHCA Circuit	<input type="checkbox"/> Yes, <input type="checkbox"/> No
Primary Directory Number	_____
Intercom Number	_____
Station Name	_____
ICM Group	_____
Pickup Group	- - ON>-;
Next Hunt Station	<input type="checkbox"/> <input type="checkbox"/> None
Class of Service	_____
Data Line Security	<input type="checkbox"/> <input type="checkbox"/> No
Automatic Callback-Trunk	<input type="checkbox"/> <input type="checkbox"/> No
Parallel Connect	<input type="checkbox"/> Yes, <input type="checkbox"/>

Key	Key Type	Number	SDN COS	Day Ring	Night Ring
DN-01	PDN		<input type="checkbox"/> Station, <input type="checkbox"/> DN		
DN-02			<input type="checkbox"/> Station, <input type="checkbox"/> DN		
DN-03			<input type="checkbox"/> Station, <input type="checkbox"/> DN		
DN-04			<input type="checkbox"/> Station, <input type="checkbox"/> DN		
DN-05			<input type="checkbox"/> Station, <input type="checkbox"/> DN		
DN-06			<input type="checkbox"/> Station, <input type="checkbox"/> DN		
DN-07			<input type="checkbox"/> Station, <input type="checkbox"/> DN		
DN-08			<input type="checkbox"/> Station, <input type="checkbox"/> DN		
DN-09			<input type="checkbox"/> Station, <input type="checkbox"/> DN		
DN-10			<input type="checkbox"/> Station, <input type="checkbox"/> DN		
DN-11			<input type="checkbox"/> Station, <input type="checkbox"/> DN		
DN-12			<input type="checkbox"/> Station, <input type="checkbox"/> DN		

PF Key	PF Key Type	Number
01		
02		
03		
04		
05		
06		
07		
08		
09		
10		
11		
12		

DSS Key	DSS Key Type	Number
01		
02		
03		
04		
05		
06		
07		
08		

EXTENSION-STATION

Station Equipment No.

Item	Set Data
Telephone Type and Model	Type _____ Model _____
OHCA Circuit	<input type="checkbox"/> <input type="checkbox"/> <input type="checkbox"/> <input type="checkbox"/> <input type="checkbox"/> No
Primary Directory Number	- - - -
Intercom Number	- -
Station Name	_____
ICM Group	---
Pickup Group	- - 0 None
Next Hunt Station	<input type="checkbox"/> <input type="checkbox"/> <input type="checkbox"/> _____ <input type="checkbox"/> None
Class of Service	- -
Data Line Security	<input type="checkbox"/> Yes, <input type="checkbox"/> No
Automatic Callback-Trunk	<input type="checkbox"/> Yes, <input type="checkbox"/> No
Parallel Connect	<input type="checkbox"/> Yes, <input type="checkbox"/> No

Key	Key Type	Number	SDN COS	Day Ring	Night Ring
DN-01	PDN		<input type="checkbox"/> Station, <input type="checkbox"/> DN		
DN-02			<input type="checkbox"/> Station, <input type="checkbox"/> DN		
DN-03			<input type="checkbox"/> Station, <input type="checkbox"/> DN		
DN-04			<input type="checkbox"/> Station, <input type="checkbox"/> DN		
DN-05			<input type="checkbox"/> Station, <input type="checkbox"/> DN		
DN-06			<input type="checkbox"/> Station, <input type="checkbox"/> DN		
DN-07			<input type="checkbox"/> Station, <input type="checkbox"/> DN		
DN-08			<input type="checkbox"/> Station, <input type="checkbox"/> DN		
DN-09			<input type="checkbox"/> Station, <input type="checkbox"/> DN		
DN-10			<input type="checkbox"/> Station, <input type="checkbox"/> DN		
DN-11			<input type="checkbox"/> Station, <input type="checkbox"/> DN		
DN-12			<input type="checkbox"/> Station, <input type="checkbox"/> DN		

PF Key	PF Key Type	Number	DSS Key	DSS Key Type	Number
01			01		
02			02		
03			03		
04			04		
05			05		
06			06		
07			07		
08			08		
09					
10					
11					
12					

EXTENSION-STATION

Station Equipment No.

Item	Set Data
Telephone Type and Model	Type _____ Model _____
OHCA Circuit	<input type="checkbox"/> <input type="checkbox"/> No
Primary Directory Number	- - - - -
Intercom Number	- -
Station Name	_____
ICM Group	_____
Pickup Group	- - <input type="checkbox"/> None
Next Hunt Station	<input type="checkbox"/> _____ <input type="checkbox"/> None
Class of Service	- -
Data Line Security	<input type="checkbox"/> <input type="checkbox"/> No
Automatic Callback-Trunk	<input type="checkbox"/> <input type="checkbox"/> No
Parallel Connect	<input type="checkbox"/> <input type="checkbox"/> No

Key	Key Type	Number	SDN COS	Day Ring	Night Ring
DN-01	PDN		<input type="checkbox"/> Station, <input type="checkbox"/> DN		
DN-02			<input type="checkbox"/> Station, <input type="checkbox"/> DN		
DN-03			<input type="checkbox"/> Station, <input type="checkbox"/> DN		
DN-04			<input type="checkbox"/> Station, <input type="checkbox"/> DN		
DN-05			<input type="checkbox"/> Station, <input type="checkbox"/> DN		
DN-06			<input type="checkbox"/> Station, <input type="checkbox"/> DN		
DN-07			<input type="checkbox"/> Station, <input type="checkbox"/> DN		
DN-08			<input type="checkbox"/> Station, <input type="checkbox"/> DN		
DN-09			<input type="checkbox"/> Station, <input type="checkbox"/> DN		
DN-10			<input type="checkbox"/> Station, <input type="checkbox"/> DN		
DN-11			<input type="checkbox"/> Station, <input type="checkbox"/> DN		
DN-12			<input type="checkbox"/> Station, <input type="checkbox"/> DN		

PF Key	PF Key-Type	Number	DSS Key	DSS Key Type	Number
01			01		
02			02		
03			03		
04			04		
05			05		
06			06		
07			07		
08			08		
09					
10					
1 1					
12					

EXTENSION-STATION

Station Equipment No.

Item	Set Data
Telephone Type and Model	Type _____ Model _____
OHCA Circuit	<input type="checkbox"/> Yes, <input type="checkbox"/> No
Primary Directory Number	- - - -
intercom Number	- -
Station Name	_____
ICM Group	-
Pickup Group	- - <input type="checkbox"/> None
Next Hunt Station	<input type="checkbox"/> EXT _____ <input type="checkbox"/> None
Class of Service	- -
Data Line Security	<input type="checkbox"/> Yes, <input type="checkbox"/> No
Automatic Callback-Trunk	<input type="checkbox"/> Yes, <input type="checkbox"/> No
Parallel Connect	<input type="checkbox"/> Yes, <input type="checkbox"/> No

Key	Key Type	Number	SDN COS	Day Ring	Night Ring
DN-01	PDN		<input type="checkbox"/> Station, <input type="checkbox"/> DN		
DN-02			<input type="checkbox"/> Station, <input type="checkbox"/> DN		
DN-03			<input type="checkbox"/> Station, <input type="checkbox"/> DN		
DN-04			<input type="checkbox"/> Station, <input type="checkbox"/> DN		
DN-05			<input type="checkbox"/> Station, <input type="checkbox"/> DN		
DN-06			<input type="checkbox"/> Station, <input type="checkbox"/> DN		
DN-07			<input type="checkbox"/> Station, <input type="checkbox"/> DN		
DN-08			<input type="checkbox"/> Station, <input type="checkbox"/> DN		
DN-09			<input type="checkbox"/> Station, <input type="checkbox"/> DN		
DN-10			<input type="checkbox"/> Station, <input type="checkbox"/> DN		
DN-11			<input type="checkbox"/> Station, <input type="checkbox"/> DN		
DN-12			<input type="checkbox"/> Station, <input type="checkbox"/> DN		

PF Key	PF Key Type	Number
01		
02		
03		
04		
05		
06		
07		
08		
09		
10		
11		
12		

DSS Key	DSS Key Type	Number
01		
02		
03		
04		
05		
06		
07		
08		

EXTENSION-STATION

Station Equipment No.

Item	Set Data
Telephone Type and Model	Type _____ Mode _____
OHCA Circuit	<input type="checkbox"/> <input type="checkbox"/> <input type="checkbox"/> <input type="checkbox"/> No
Primary Directory Number	- - - -
Intercom Number	- -
Station Name	- - - - -
ICM Group	—
Pickup Group	- - [? None
Next Hunt Station	<input type="checkbox"/> EXT <input type="checkbox"/> None
Class of Service	- -
Data Line Security	<input type="checkbox"/> <input type="checkbox"/> <input type="checkbox"/> <input type="checkbox"/>
Automatic Callback-Trunk	<input type="checkbox"/> <input type="checkbox"/> <input type="checkbox"/> No
Parallel Connect	<input type="checkbox"/> Yes, <input type="checkbox"/> <input type="checkbox"/>

Key	Key Type	Number	SDN	CCS	Day Ring	Night Ring
DN-01	PDN		<input type="checkbox"/> Station,	<input type="checkbox"/> DN		
DN-02			<input type="checkbox"/> Station,	<input type="checkbox"/> DN		
DN-03			<input type="checkbox"/> Station,	<input type="checkbox"/> DN		
DN-04			<input type="checkbox"/> Station,	<input type="checkbox"/> DN		
DN-05			<input type="checkbox"/> Station,	<input type="checkbox"/> DN		
DN-06			<input type="checkbox"/> Station,	<input type="checkbox"/> DN		
DN-07			<input type="checkbox"/> Station,	<input type="checkbox"/> DN		
DN-08			<input type="checkbox"/> Station,	<input type="checkbox"/> DN		
DN-09			<input type="checkbox"/> Station,	<input type="checkbox"/> DN		
DN-10			<input type="checkbox"/> Station,	<input type="checkbox"/> DN		
DN-11			<input type="checkbox"/> Station,	<input type="checkbox"/> DN		
DN-12			<input type="checkbox"/> Station,	<input type="checkbox"/> DN		

PF Key	PF Key Type	Number	DSS Key	DSS Key Type	Number
01			01		
02			02		
03			03		
04			04		
05			05		
06			06		
07			07		
08			08		
09					
10					
11					
12					

EXTENSION-STATION

Station Equipment No.

Item	Set Data
Telephone Type and Model	Type _____ Model _____
OHCA Circuit	<input type="checkbox"/> Yes, <input type="checkbox"/> No
Primary Directory Number	_____
Intercom Number	_____
Station Name	_____
ICM Group	_____
Pickup Group	_____ or None
Next Hunt: Station	<input type="checkbox"/> <input type="checkbox"/> _____ <input type="checkbox"/> None
Class of Service	_____
Data Line Security	<input type="checkbox"/> Yes, <input type="checkbox"/> <input type="checkbox"/>
Automatic Callback-Trunk	<input type="checkbox"/> Yes, <input type="checkbox"/> <input type="checkbox"/>
Parallel Connect	<input type="checkbox"/> Yes, <input type="checkbox"/> <input type="checkbox"/>

Key	Key Type	Number	SDN	COS	Day Ring	Night Ring
DN-01	PDN		<input type="checkbox"/> Station, <input type="checkbox"/> DN			
DN-02			<input type="checkbox"/> Station, <input type="checkbox"/> DN			
DN-03			<input type="checkbox"/> Station, <input type="checkbox"/> DN			
DN-04			<input type="checkbox"/> Station, <input type="checkbox"/> DN			
DN-05			<input type="checkbox"/> Station, <input type="checkbox"/> DN			
DN-06			<input type="checkbox"/> Station, <input type="checkbox"/> DN			
DN-07			<input type="checkbox"/> Station, <input type="checkbox"/> DN			
DN-08			<input type="checkbox"/> Station, <input type="checkbox"/> DN			
DN-09			<input type="checkbox"/> Station, <input type="checkbox"/> DN			
DN-10			<input type="checkbox"/> Station, <input type="checkbox"/> DN			
DN-11			<input type="checkbox"/> Station, <input type="checkbox"/> DN			
DN-12			<input type="checkbox"/> Station, <input type="checkbox"/> DN			

PF Key	PF Key Type	Number	DSS Key	DSS Key Type	Number
01			01		
02			02		
03			03		
04			04		
05			05		
06	1		06		
07			07		
08			08		
09					
10					
11					
12					

EXTENSION-STATION

Station Equipmen; No.

Item	Set Data
Telephone Type and Model	Type _____ Model _____
OHCA Circuit	<input type="checkbox"/> <input type="checkbox"/> No
Primary Directory N-umber	- - - -
Intercom Number	- -
Station Name	- - - - -
CM Group	-
Pickup Group	- - <input type="checkbox"/> None
Next Hunt Station	<input type="checkbox"/> <input type="checkbox"/> <input type="checkbox"/> <input type="checkbox"/> <input type="checkbox"/> None
Class of Service	- -
Data Lint Security	<input type="checkbox"/> Yes, <input type="checkbox"/> No
Automatic Callback-Trunk	<input type="checkbox"/> Yes, <input type="checkbox"/> No
Parallel Connect	<input type="checkbox"/> <input type="checkbox"/> No

Key	Key Type	Number	SDN COS	Day Ring	Night Ring
DN-01	PDN		<input type="checkbox"/> Station, <input type="checkbox"/> DN		
DN-02			<input type="checkbox"/> Station, <input type="checkbox"/> DN		
DN-03			<input type="checkbox"/> Station, <input type="checkbox"/> DN		
DN-04			<input type="checkbox"/> Station, ODN		
DN-05			<input type="checkbox"/> Station, <input type="checkbox"/> DN		
DN-06			<input type="checkbox"/> Station, <input type="checkbox"/> DN		
DN-07			<input type="checkbox"/> Station, <input type="checkbox"/> DN		
DN-08			<input type="checkbox"/> Station, ODN		
DN-09			<input type="checkbox"/> Station, ODN		
DN-10			<input type="checkbox"/> Station, <input type="checkbox"/> DN		
DN-11			<input type="checkbox"/> Station, <input type="checkbox"/> DN		
DN-12			<input type="checkbox"/> Station, ODN		

PF Key	PF Key Type	Number	DSS Key	DSS Key Type	Number
01			01		
02			02		
03			03		
04			04		
05			05		
06			06		
07			07		
08			08		
09					
10					
11					
12					

EXTENSION-DSS CONSOLE

Item	Selection of Value	Default Value
Model	-X-T61 640 -X-T123240 (7040)	KX-T123240 (7040)
Pair Extension	3 or 4 digits: directory number	blank
PF Key Type	3 SS (ICM), ONE TOUCH EXT FEAT, CALL PAR, CALL STA, RGN TRAN. SPLIT, TONE-BRK, or blank	Mank
PF Key Number	1 or 2 digits: intercom number for "DSS (ICM)" maximum 16 digits of dialing number: destination number for "ONETOUCH"	blank
DSS Key Type	MW, LOGIN, ALARM, DSS (DN), DSS (ICM), ONE TOUCH, PFV-CHG EXT FEAT, CALL PAR, CALL STA, RGN TRAN. SPLIT, TONE-BRK, or blank	blank
DSS Key Number	3 or 4 digits: directory number for "DSS (DN)" 1 or 2 digits: intercom number for "DSS (ICM)" maximum 16 digits: destination number for "ONE TOUCH"	blank

EXTENSION-DSS CONSOLE

Station Equipment No.

item	Set Data
Model	<input type="checkbox"/> KX-T123240 (7040) <input type="checkbox"/> KX-T61640
Pair Extension	- - - - (3 or 4-digit DN)

PF Key	Set Data		PF Key	Set Data	
	PF Key Type	PF Key Number		PF Key Type	PF Key Number
01			09		
02			10		
03			11		
04			12		
05			13		
06			14		
07			15		
08			16		

DSS Key	Set Data		DSS Key	Set Data	
	DSS Key Type	DSS Key Number		DSS Key Type	DSS Key Number
01			17		
02			18		
03			19		
04			20		
05			21		
06			22		
07			23		
08			24		
09			25		
10			26		
11			27		
12			28		
13			29		
14			30		
15			31		
16			32		

EXTENSION-DSS CONSOLE

Station Equipment No.

Item	Set Data
Model	<input type="checkbox"/> KX-T123240(7040) <input type="checkbox"/> KX-T51540
Pair Extension	- - - - (3 or 4-digit DN)

PF Key	Set Data		PF Key	Set Data	
	PF Key Type	PF Key Number		PF Key Type	PF Key Number
01			09		
02					
03			11		
04			12		
05			13		
06			14		
07			15		
08			16		

DSS Key	Set Data		DSS Key	Set Data	
	DSS Key Type	DSS Key Number		DSS Key Type	DSS Key Number
01			17		
02			18		
03			19		
04			20		
05			21		
06			22		
07			23		
08			24		
09			25		
10			26		
11			27		
12			28		
13			29		
14			30		
15			31		
16			32		

EXTENSION-DSS CONSOLE

Station Equipment No.

Item	Set Data
Model	<input type="checkbox"/> KX-T123240 (7040) <input type="checkbox"/> KX-T61640
Pair Extension	- - - - (3 or 4-digit DN)

PF Key	Set Data		PF Key	Set Data	
	PF Key Type	PF Key Number		PF Key Type	PF Key Number
01			09		
02			10		
03			11		
04			12		
05			13		
06			14		
07			15		
08			16		

DSS Key	Set Data		DSS Key	Set Data	
	DSS Key Type	DSS Key Number		DSS Key Type	DSS Key Number
01			17		
02			18		
03			19		
04			20		
05			21		
06			22		
07			23		
08			24		
09			25		
10			26		
11			27		
12			28		
13			29		
14			30		
15			31		
16			32		

EXTENSION-DSS CONSOLE

Station Equipment No. _____

item	Set Data
Model	<input type="checkbox"/> KX-T12324(7040) <input type="checkbox"/> KX-T61640
Pair Extension	- - - - (3 or 4-digit DN)

PF Key	Set Data		PF Key	Set Data	
	PF Key Type	PF Key Number		PF Key Type	PF Key Number
01			09		
02			10		
03			11		
04			12		
05			13		
06			14		
07			15		
08			16		

DSS Key	Set Data		DSS Key	Set Data	
	DSS Key Type	DSS Key Number		DSS Key Type	DSS Key Number
01			17		
02			18		
03			19		
04			20		
05			21		
06			22		
07			23		
08			24		
09			25		
10			26		
11			27		
12			28		
13			29		
14			30		
15			31		
16			32		

EXTENSION-DSS CONSOLE

Station Equipment No.

Item	Set Data
Model	<input type="checkbox"/> KX-T123240 (7040) <input type="checkbox"/> KX-T61640
Pair Extension	- - - - (3 or 4-digit DN)

PF Key	Set Data		PF Key	Set Data	
	PF Key Type	PF Key Number		PF Key Type	PF Key Number
01			09		
02			10		
03			11		
04			12		
05			13		
06			14		
07			15		
08			16		

DSS Key	Set Data		DSS Key	Set Data	
	DSS Key Type	DSS Key Number		DSS Key Type	DSS Key Number
01			17		
02			18		
03			19		
04			20		
05			21		
06			22		
07			23		
08			24		
09			25		
10			26		
11			27		
12			28		
13			29		
14			30		
15			31		
16			32		

EXTENSION-DSS CONSOLE

Station Equipment No.

Item	Set Data
Model	<input type="checkbox"/> KX-T12324(0140) <input type="checkbox"/> KX-T61640
Pair Extension	_ _ _ _ (for 4-digit DN)

PF Key	Set Data		PF Key	Set Data	
	PF Key Type	PF Key Number		PF Key Type	PF Key Number
01			09		
02			10		
03			11		
04			12		
05			13		
06			14		
07			15		
08			16		

DSS Key	Set Data		DSS Key	Set Data	
	DSS Key Type	DSS Key Number		DSS Key Type	DSS Key Number
01			17		
02			18		
03			19		
04			20		
05			21		
06			22		
07			23		
08			24		
09			25		
10			26		
11			27		
12			28		
13			29		
14			30		
15			31		
16			32		

EXTENSION-DSS CONSOLE

Station Equipment No. _____

Item	Set Data
Model	<input type="checkbox"/> KX-T123240 (7040) <input type="checkbox"/> KX-T61640
Pair Extension	- - - - - (3 or 4-digit DN)

PF Key	Set Data		PF Key	Set Data	
	PF Key Type	PF Key Number		PF Key Type	PF Key Number
01			09		
02			10		
03			11		
04			12		
05			13		
06			14		
07			15		
08			16		

DSS Key	Set Data		DSS Key	Set Data	
	DSS Key Type	DSS Key Number		DSS Key Type	DSS Key Number
01			17		
02			18		
03			19		
04			20		
05			21		
06			22		
07			23		
08			24		
09			25		
10			26		
11			27		
12			28		
13			29		
14			30		
15			31		
16			32		

EXTENSION-DSS CONSOLE

Station Equipment No.

Item	Set Data
Model	<input type="checkbox"/> KX-T123240 (7040) <input type="checkbox"/> KX-T61640
Pair Extension	- - - - (3 or 4-digit DN)

PF Key	Set Data		P F Key	Set Data	
	PF Key Type	PF Key Number		PF Key Type	PF Key Number
01			09		
02			10		
03			11		
04			12		
05			13		
06			14		
07			15		
08			16		

DSS Key	Set Data		DSS Key	Set Data	
	DSS Key Type	DSS Key Number		DSS Key Type	DSS Key Number
01			17		
02			18		
03			19		
04			20 I		
05			21		
06			22		
07			23		
08			24		
09			25		
10			26		
11			27		
12			28		
13			29		
14			30		
15			31		
16			32		

EXTENSION-DSS CONSOLE

Station Equipment No. _____

Item	Set Data
Model	<input type="checkbox"/> KX-T123240 (7040) <input type="checkbox"/> KX-T61640
Pair Extension	- - - - (3 or 4-digit DN)

PF Key	Set Data		PF Key	Set Data	
	PF Key Type	PF Key Number		PF Key Type	PF Key Number
01			09		
02			10		
03			11		
04			12		
05			13		
06			14		
07			15		
08			16		

DSS Key	Set Data		DSS Key	Set Data	
	DSS Key Type	DSS Key Number		DSS Key Type	DSS Key Number
01			17		
02			18		
03			19		
04			20		
05			21		
06			22		
07			23		
08			24		
09			25		
10			26		
11			27		
12			28		
13			29		
14			30		
15			31		
16			32		

EXTENSION-DSS CONSOLE

Station Equipment No.

Item	Set Data
Model	<input type="checkbox"/> KX-T123240 (7040) <input type="checkbox"/> KX-T61640
Pair Extension	_ _ _ _ (3 or 4-digit CN)

PF		Set Data	PF	Set Data	
Key	PF Key Type	PF Key Number	Key	PF Key Type	PF Key Number
01			09		
02			10		
03			11		
04			12		
05			1 3		
06			14		
07			15		
08	I		16		

DSS Key	Set Data		DSS Key	Set Data	
	DSS Key Type	DSS Key Number		DSS Key Type	DSS Key Number
01			17		
02			18		
03			19		
04			20		
05			21		
06			22		
07			23		
08			24		
09			25		
10			26		
11			27		
12			28		
13			29		
14			30		
15			31		
16			32		

EXTENSION—DSS CONSOLE

Station Equipment No.

Item	Set Data
Model	<input type="checkbox"/> KX-T123240 (7040) <input type="checkbox"/> KX-T61640
Pair Extension	- - - - (3 or 4-digit DN)

PF Key	Set Data		PF Key	Set Data	
	PF Key Type	PF Key Number		PF Key Type	PF Key Number
01			09		
02			10		
03			11		
04			12		
05			13		
06			14		
07			15		
08			16		

DSS Key	Set Data		DSS Key	Set Data	
	DSS Key Type	DSS Key Number		DSS Key Type	DSS Key Number
01			17		
02			18		
03			19		
04			20		
05			21		
06			22		
07			23		
08			24		
09			25		
10			26		
11			27		
12			28		
13			29		
14			30		
15			31		
16			32		

EXTENSION-DSSCONSOLE

Station Equipment No.

item	Set Data
Model	<input type="checkbox"/> KX-T23240(140) <input type="checkbox"/> KX-T61640
Pair Extension	- - - - (3 or 4-digit DN)

PF Key	Set Data		PF Key	Set Data	
	PF Key Type	PF Key Number		PF Key Type	PF Key Number
01			09		
02			10		
03			11		
04			12		
05			13		
06			14		
07			15		
08			16		

DSS Key	Set Data		DSS Key	Set Data	
	DSS Key Type	DSS Key Number		DSS Key Type	DSS Key Number
01			17		
02			18		
03			19		
04			20		
05			21		
06			22		
07			23		
08			24		
09			25		
10			26		
11			27		
12			28		
13			29		
14			30		
15			31		
16			32		

EXTENSION-DSS CONSOLE

Station Equipment No.

Item	Set Data
Model	<input type="checkbox"/> KX-T123240 (7040) <input type="checkbox"/> KX-T61640
Pair Extension	- - - - (3 or 4-digit DN)

PF Key	Set Data		PF Key	Set Data	
	PF Key Type	PF Key Number		PF Key Type	PF Key Number
01			09		
02			10		
03			11		
04			12		
05			13		
06			14		
07			15		
08			16		

DSS Key	Set Data		DSS Key	Set Data	
	DSS Key Type	DSS Key Number		DSS Key Type	DSS Key Number
01			17		
02			18		
03			19		
04			20		
05			21		
06			22		
07			23		
08			24		
09			25		
10			26		
11			27		
12			28		
13			29		
14			30		
15			31		
16			32		

EXTENSION-DSS CONSOLE

Station Equipment No. _____

Item	Set Data
Model	<input type="checkbox"/> KX-T123240 (7040) <input type="checkbox"/> KX-T61640
Pair Extension	- - - - (3 or 4-digit DN)

PF Key	Set Data		PF Key	Set Data	
	PF Key Type	PF Key Number		PF Key Type	PF Key Number
01			09		
02			10		
03			11		
04			12	I	
05			13		
06			14		
07			15		
08			16		

DSS Key	Set Data		DSS Key	Set Data	
	DSS Key Type	DSS Key Number		DSS Key Type	DSS Key Number
01			17		
02			18		
03			19		
04			20		
05			21		
06			22		
07			23		
08			24		
09			25		
10			26		
11			27		
12			28		
13			29		
14			30		
15			31		
16			32		

EXTENSION-DSS CONSOLE

Station Equipment No.

Item	Set Data
Model	<input type="checkbox"/> KX-T123240 (7040) <input type="checkbox"/> KX-T61640
Pair Extension	- - - - (3 or 4-digit DN)

PF Key	Set Data		PF Key	Set Data	
	PF Key Type	PF Key Number		PF Key Type	PF Key Number
01			09		
02			10		
03			11		
04			12		
05			13		
06			14		
07			15		
08			16		

DSS Key	Set Data		DSS Key	Set Data	
	DSS Key Type	DSS Key Number		DSS Key Type	DSS Key Number
01			17		
02			18		
03			19		
04			20		
05			21		
06			22		
07			23		
08			24		
09			25		
10			26		
11			27		
12			28		
13			29		
14			30		
1s			31		
16			32		

EXTENSION-DSS CONSOLE

Station Equipment No.

Item	Set Data
Model	<input type="checkbox"/> KX-T1232 (7040) <input type="checkbox"/> KX-T61640
Pair Extension	____ (3 or 4digit DN)

PF Key	Set Data		PF Key	Set Data	
	PF Key Type	PF Key Number		PF Key Type	PF Key Number
01			09		
02			10		
03			11		
04			12		
05			13		
06			14		
07			15		
08			16		

DSS Key	Set Data		DSS Key	Set Data	
	DSS Key Type	DSS Key Number		DSS Key Type	DSS Key Number
01			17		
02			18		
03			19		
04			20		
05			21		
06			22		
07			23		
08			24		
09			25		
10			26		
11			27		
12			28		
13			29		
14			30		
15			31		
16			32		

EXTENSION-DOORPHONE

Door- phone No.	Tenant		Open Duration		Doorphone Call Assignment		
	Set Data	Default Value	Set Data	Default Value	set Data	Default Value	
1	<input type="checkbox"/> Tenant 1 <input type="checkbox"/> Tenant 2	Tenant 1	<u>second(s)</u> 1 or 2 digits 0: Door cannot be opened. 1 to 10: Door opening duration in second(s)	0	<input type="checkbox"/> ICM <input type="checkbox"/> PICKUP _____ 1 digit (1 to 11) <input type="checkbox"/> EXT - - - - - 2 digits (01 to 32) <input type="checkbox"/> ATT <input type="checkbox"/> Blank 3 or 4 digits (UN)	ATT for "with ATLC" EXT 100 : for "without ATLC"	
2	<input type="checkbox"/> Tenant 1 <input type="checkbox"/> Tenant 2	Tenant 1	<u>second(s)</u> 1 or 2 digits 0: Door cannot be opened. 1 to 10: Door opening duration in second(s)	0	<input type="checkbox"/> ICM <input type="checkbox"/> PICKUP <input type="checkbox"/> EXT <input type="checkbox"/> ATT <input type="checkbox"/> Blank	1 digit (1 to 8) 2 digits (01 to 32) 3 or 4 digits (DN)	ATT: for "with ATLC" EXT 100 : for "without ATLC"
3	<input type="checkbox"/> Tenant 1 <input type="checkbox"/> Tenant 2	Tenant 1	<u>second(s)</u> 1 or 2 digits 0: Door cannot be opened. 1 to 10: Door opening duration in second(s)	0	<input type="checkbox"/> _____ 1 digit (1 to 8) <input type="checkbox"/> PICKUP <input type="checkbox"/> EXT _____ 2 digits (01 to 32) <input type="checkbox"/> _____ 3 or 4 digits (DN) <input type="checkbox"/> Blank	ATT: for "with ATLC" EXT 100 : for "without ATLC"	
4	<input type="checkbox"/> Tenant 1 <input type="checkbox"/> Tenant 2	Tenant 1	<u>second(s)</u> 1 or 2 digits 0: Door cannot be opened. 1 to 10: Door opening duration in second(s)	0	<input type="checkbox"/> _____ 1 digit (1 to 8) <input type="checkbox"/> PICKUP _____ 2 digits (01 to 32) <input type="checkbox"/> _____ 3 or 4 digits (DN) <input type="checkbox"/> ATT <input type="checkbox"/> Blank	ATT: for "with ATLC" EXT 100 : for "without ATLC"	

6-308

Remark: If DPH card was not set beforehand, this screen is not available.

EXTENSION-ATTENDANT CONSOLE

	DN		TRS LV		PAG	
	Data	Default	Data	Default	Data	Default
ATT 1	_____ (3 or 4 digits) <input type="checkbox"/> blank	blank	-	01	<input type="checkbox"/> E1 <input type="checkbox"/> E2 <input type="checkbox"/> ALL	E1 & E2
ATT 2	_____ (3 or 4 digits) <input type="checkbox"/> blank	blank	-	01	<input type="checkbox"/> E1 <input type="checkbox"/> E2 <input type="checkbox"/> ALL	E1 & E2

Alt Position	Tenant 1		Tenant 2	
	Data	Default	Data	Default
Overflow	_____ (3 or 4 digits) <input type="checkbox"/> blank	blank	_____ (3 or 4 digits) <input type="checkbox"/> blank	blank
Night	_____ (3 or 4 digits) <input type="checkbox"/> blank	blank	(3 or 4 digits) <input type="checkbox"/> blank	blank

G No.	Busv-out Extension	
	data	Default
01	_____	blank
02	_____	blank
03	_____	blank
04	_____	blank
05	_____	blank
06	_____	blank
07	_____	blank
08	_____	blank
09	_____	blank
10	_____	blank
11	_____	blank
12	_____	blank
13	_____	blank
14	_____	blank
15	_____	blank
16	_____	blank

Call Priority			
Item	Data	item	Data
Internal Calling Station	__	External Calling TG5	__
Internal Calling Doorphone	__	TG6	__
Console Calling	__	TG7	__
Transfer Recall	__	TG8	__
Serial Calling Recall	__	TG9	__
Call Park Recall	__	TG10	__
Intercept Routing	__	TG11	__
Held Call Reminder	__	TG12	__
External Calling TG1	__	TG13	__
TG2	__	TG14	__
TG3	__	TG15	__
TG4	__	TG16	__

Note:

	Selection of value	Default
Busy-out Extension	3 or 4 digits of Extension number	blank
Call Priority	2 digits (01 to 24)	01

7. Special Carrier Access

]

SPECIAL CARRIER ACCESS-EQUAL ACCESS

Item	Set Data				Default Value
	Equal Access No.1	Equal Access No.2	Equal Access No.3	Equal Access No.4	
Service (Equal Access Set)	<input type="checkbox"/> Yes, <input type="checkbox"/> No	<input type="checkbox"/> Yes, <input type="checkbox"/> No	<input type="checkbox"/> Yes, <input type="checkbox"/> No	<input type="checkbox"/> Yes, <input type="checkbox"/> No	No
Name (Equal Access Name)	_____	- - -	- - -	_____	blank
Equal Access Carrier Code	_____	- - -	- - -	_____	blank
Toll Restriction Level	(0 1 t o 1)	(0 1 t o 1)	(0 1 t o 1 6)	(0 1 t o 1 6)	blank
Toll Restriction Table	_____ (1 to 8)	_____ (1 to 8)	_____ (1 to 8)	_____ (1 to 8)	blank
Digit Modification					
Long Distance (Delete)	_____ (0 to 4)	_____ (0 to 4)	_____ (0 to 4)	_____ (0 to 4)	blank
Long Distance (Insert)	- - - -	- - - -	_____	- - - -	blank
Local Toll (Delete)	_____ (0 to 4)	_____ (0 to 4)	_____ (0 to 4)	_____ (0 to 4)	blank
Local Toll (Insert)	- - - -	- - - -	_____	- - - -	blank
Local (Delete;)	_____ (0 to 4)	_____ (0 to 4)	_____ (0 to 4)	_____ (0 to 4)	blank
Local (Insert)	- - - -	- - - -	- - - -	- - - -	blank
Trunk Group No. 01	<input type="checkbox"/> Yes, <input type="checkbox"/> No	<input type="checkbox"/> Yes, <input type="checkbox"/> No	<input type="checkbox"/> Yes, <input type="checkbox"/> No	<input type="checkbox"/> Yes, <input type="checkbox"/> No	blank
02	<input type="checkbox"/> Yes, <input type="checkbox"/> No	<input type="checkbox"/> Yes, <input type="checkbox"/> No	<input type="checkbox"/> Yes, <input type="checkbox"/> No	<input type="checkbox"/> Yes, <input type="checkbox"/> No	blank
03	<input type="checkbox"/> Yes, <input type="checkbox"/> No	<input type="checkbox"/> Yes, <input type="checkbox"/> No	<input type="checkbox"/> Yes, <input type="checkbox"/> No	<input type="checkbox"/> Yes, <input type="checkbox"/> No	blank
04	<input type="checkbox"/> Yes, <input type="checkbox"/> No	<input type="checkbox"/> Yes, <input type="checkbox"/> No	<input type="checkbox"/> Yes, <input type="checkbox"/> No	<input type="checkbox"/> Yes, <input type="checkbox"/> No	blank
05	<input type="checkbox"/> Yes, <input type="checkbox"/> No	<input type="checkbox"/> Yes, <input type="checkbox"/> No	<input type="checkbox"/> Yes, <input type="checkbox"/> No	<input type="checkbox"/> Yes, <input type="checkbox"/> No	blank
06	<input type="checkbox"/> Yes, <input type="checkbox"/> No	<input type="checkbox"/> Yes, <input type="checkbox"/> No	<input type="checkbox"/> Yes, <input type="checkbox"/> No	<input type="checkbox"/> Yes, <input type="checkbox"/> No	blank
07	<input type="checkbox"/> Yes, <input type="checkbox"/> No	<input type="checkbox"/> Yes, <input type="checkbox"/> No	<input type="checkbox"/> Yes, <input type="checkbox"/> No	<input type="checkbox"/> Yes, <input type="checkbox"/> No	blank
06	<input type="checkbox"/> Yes, <input type="checkbox"/> No	<input type="checkbox"/> Yes, <input type="checkbox"/> No	<input type="checkbox"/> Yes, <input type="checkbox"/> No	<input type="checkbox"/> Yes, <input type="checkbox"/> No	blank
09	<input type="checkbox"/> Yes, <input type="checkbox"/> No	<input type="checkbox"/> Yes, <input type="checkbox"/> No	<input type="checkbox"/> Yes, <input type="checkbox"/> No	<input type="checkbox"/> Yes, <input type="checkbox"/> No	blank
10	<input type="checkbox"/> Yes, <input type="checkbox"/> No	<input type="checkbox"/> Yes, <input type="checkbox"/> No	<input type="checkbox"/> Yes, <input type="checkbox"/> No	<input type="checkbox"/> Yes, <input type="checkbox"/> No	blank
11	<input type="checkbox"/> Yes, <input type="checkbox"/> No	<input type="checkbox"/> Yes, <input type="checkbox"/> No	<input type="checkbox"/> Yes, <input type="checkbox"/> No	<input type="checkbox"/> Yes, <input type="checkbox"/> No	blank
12	<input type="checkbox"/> Yes, <input type="checkbox"/> No	<input type="checkbox"/> Yes, <input type="checkbox"/> No	<input type="checkbox"/> Yes, <input type="checkbox"/> No	<input type="checkbox"/> Yes, <input type="checkbox"/> No	blank
13	<input type="checkbox"/> Yes, <input type="checkbox"/> No	<input type="checkbox"/> Yes, <input type="checkbox"/> No	<input type="checkbox"/> Yes, <input type="checkbox"/> No	<input type="checkbox"/> Yes, <input type="checkbox"/> No	blank
14	<input type="checkbox"/> Yes, <input type="checkbox"/> No	<input type="checkbox"/> Yes, <input type="checkbox"/> No	<input type="checkbox"/> Yes, <input type="checkbox"/> No	<input type="checkbox"/> Yes, <input type="checkbox"/> No	blank
15	<input type="checkbox"/> Yes, <input type="checkbox"/> No	<input type="checkbox"/> Yes, <input type="checkbox"/> No	<input type="checkbox"/> Yes, <input type="checkbox"/> No	<input type="checkbox"/> Yes, <input type="checkbox"/> No	blank
16	<input type="checkbox"/> Yes, <input type="checkbox"/> No	<input type="checkbox"/> Yes, <input type="checkbox"/> No	<input type="checkbox"/> Yes, <input type="checkbox"/> No	<input type="checkbox"/> Yes, <input type="checkbox"/> No	blank

Note:

Item	Selection of value
Name	letters, numbers, marks within 3 digits blank: not assigning
Equal Access Carrier Code	3 digits number
Long Distance (Insert) Local Toll (Insert) Local (Insert)	maximum 4 digits number

SPECIAL CARRIER ACCESS-OCC ACCESS (1/2)

Item	Set Data		Default Value
	OCC Access No.1	OCC Access No.2	
Service	<input type="checkbox"/> Yes, <input type="checkbox"/> No	<input type="checkbox"/> Yes, <input type="checkbox"/> No	No
Name	_ _ _ _	_ _ _ _	blank
Local Access Code	_ _ _ _ _ (Max. 8 digits)	_ _ _ _ _ (Max. 8 digits)	blank
Toll Restriction Level	_ _ (01 to 16)	_ _ (01 to 16)	blank
Toll Restriction Table	_ _ (1 to 8)	_ _ (1 to 8)	blank
Digit Modification			blank
Long Distance (Delete:)	_ (0 to 4)	_ (0 to 4)	blank
Long Distance (Insert)	_ _ _ _ _ (Max. 20 digits)	_ _ _ _ _ (Max. 20 digits)	blank
Local Toll (Delete)	_ (0 to 4)	_ (0 to 4)	blank
Local Toll (Insert)	_ _ _ _ _ (Max. 20 digits)	_ _ _ _ _ (Max. 20 digits)	blank
Local (Delete)	_ (0 to 4)	_ (0 to 4)	blank
Local (insert)	_ _ _ _ _ (Max. 20 digits)	_ _ _ _ _ (Max. 20 digits)	blank
Trunk Group No. 01	<input type="checkbox"/> Yes, <input type="checkbox"/> Yes , <input type="checkbox"/> No	<input type="checkbox"/> Yes, <input type="checkbox"/> Yes , <input type="checkbox"/> No	blank
02	<input type="checkbox"/> Yes, <input type="checkbox"/> Yes , <input type="checkbox"/> No	<input type="checkbox"/> Yes, <input type="checkbox"/> Yes , <input type="checkbox"/> No	blank
03	<input type="checkbox"/> Yes, <input type="checkbox"/> Yes , <input type="checkbox"/> No	<input type="checkbox"/> Yes, <input type="checkbox"/> Yes , <input type="checkbox"/> No	blank
04	<input type="checkbox"/> Yes, <input type="checkbox"/> Yes , <input type="checkbox"/> No	<input type="checkbox"/> Yes, <input type="checkbox"/> Yes , <input type="checkbox"/> No	blank
05	<input type="checkbox"/> Yes, <input type="checkbox"/> Yes , <input type="checkbox"/> No	<input type="checkbox"/> Yes, <input type="checkbox"/> Yes , <input type="checkbox"/> No	blank
06	<input type="checkbox"/> Yes, <input type="checkbox"/> No	<input type="checkbox"/> Yes, <input type="checkbox"/> No	blank
07	<input type="checkbox"/> Yes, <input type="checkbox"/> No	<input type="checkbox"/> Yes, <input type="checkbox"/> No	blank
08	<input type="checkbox"/> Yes, <input type="checkbox"/> Yes , <input type="checkbox"/> No	<input type="checkbox"/> Yes, <input type="checkbox"/> Yes , <input type="checkbox"/> No	blank
09	<input type="checkbox"/> Yes, <input type="checkbox"/> Yes , <input type="checkbox"/> No	<input type="checkbox"/> Yes, <input type="checkbox"/> Yes , <input type="checkbox"/> No	blank
10	<input type="checkbox"/> Yes, <input type="checkbox"/> Yes , <input type="checkbox"/> No	<input type="checkbox"/> Yes, <input type="checkbox"/> No	blank
11	<input type="checkbox"/> Yes, <input type="checkbox"/> Yes , <input type="checkbox"/> No	<input type="checkbox"/> Yes, <input type="checkbox"/> Yes , <input type="checkbox"/> No	blank
12	<input type="checkbox"/> Yes, <input type="checkbox"/> No	<input type="checkbox"/> Yes, <input type="checkbox"/> No	blank
13	<input type="checkbox"/> Yes, <input type="checkbox"/> Yes , <input type="checkbox"/> No	<input type="checkbox"/> Yes, <input type="checkbox"/> Yes , <input type="checkbox"/> No	blank
14	<input type="checkbox"/> Yes, <input type="checkbox"/> Yes , <input type="checkbox"/> No	<input type="checkbox"/> Yes, <input type="checkbox"/> Yes , <input type="checkbox"/> No	blank
15	<input type="checkbox"/> Yes, <input type="checkbox"/> No	<input type="checkbox"/> Yes, <input type="checkbox"/> No	blank
16	<input type="checkbox"/> Yes, <input type="checkbox"/> Yes , <input type="checkbox"/> No	<input type="checkbox"/> Yes, <input type="checkbox"/> No	blank

Note:

Long Distance (Insert) : Max. 20 digits consisting of numbers, ●, # and marks below
 Local Toll (Insert) : H : Home position P : Pause D : Switch to DTMF
 Local (Insert) : [: start of secret numbers] : end of secret numbers (enter **secret** marks in a pair)
 . : Hyphen

SPECIAL CARRIER ACCESS-OCC ACCESS (2/2)

Item	Set Data		Default Value
	OCC Access No.3	OCC Access No.4	
Set-vice	<input type="checkbox"/> <input type="checkbox"/> <input type="checkbox"/> <input type="checkbox"/> No	<input type="checkbox"/> <input type="checkbox"/> <input type="checkbox"/> <input type="checkbox"/> No	<input type="checkbox"/> <input type="checkbox"/>
Name	- - - - -	- - - - -	blank
Local Access Code	- - - - - (Max 8 digits)	(Max. 8 d i g i t s)	blank
Toll Restriction Lev	- - (01 to 16)	- - (01 to 16)	blank
Toll Restriction Table	- (1 to 8)	- (1 to 8)	blank
Digit Modification			blank
Long Cistance (Delete)	- (0 to 4)	- (0 to 4)	blank
Long Distance (Insert)	- - - - - - - - - - (Max. 20 digits)	- - - - - (Max. 20 digits)	blank
Local Toll (Delete)	- (0 to 4)	- (0 to 4)	blank
Local Toll (Insert)	- - - - - - - - - - (Max. 20 digits)	- - - - - (Max. 20 digits)	blank
Local (Delete)	- (0 to 4)	- (0 to 4)	blank
Local (Insert)	- - - - - (Max. 20 digits)	- - - - - (Max. 20 digits)	blank
Trunk Group No.			
01	<input type="checkbox"/> Yes, <input type="checkbox"/> No	<input type="checkbox"/> Yes, <input type="checkbox"/> No	blank
02	<input type="checkbox"/> Yes, <input type="checkbox"/> No	<input type="checkbox"/> Yes, <input type="checkbox"/> No	blank
03	<input type="checkbox"/> Yes, <input type="checkbox"/> No	<input type="checkbox"/> Yes, <input type="checkbox"/> <input type="checkbox"/>	blank
04	<input type="checkbox"/> <input type="checkbox"/> <input type="checkbox"/> <input type="checkbox"/> No	<input type="checkbox"/> Yes, <input type="checkbox"/> No	blank
05	<input type="checkbox"/> Yes, <input type="checkbox"/> No	<input type="checkbox"/> Yes, <input type="checkbox"/> No	blank
06	<input type="checkbox"/> <input type="checkbox"/> <input type="checkbox"/> <input type="checkbox"/>	<input type="checkbox"/> <input type="checkbox"/> <input type="checkbox"/> <input type="checkbox"/>	blank
07	<input type="checkbox"/> Yes, <input type="checkbox"/> No	<input type="checkbox"/> Yes, <input type="checkbox"/> No	blank
08	<input type="checkbox"/> Yes, <input type="checkbox"/> <input type="checkbox"/>	<input type="checkbox"/> <input type="checkbox"/> <input type="checkbox"/> <input type="checkbox"/> No	blank
09	<input type="checkbox"/> Yes, <input type="checkbox"/> No	<input type="checkbox"/> Yes, <input type="checkbox"/> No	blank
10	<input type="checkbox"/> Yes, <input type="checkbox"/> No	<input type="checkbox"/> <input type="checkbox"/> <input type="checkbox"/> <input type="checkbox"/> No	blank
11	<input type="checkbox"/> <input type="checkbox"/> <input type="checkbox"/> <input type="checkbox"/>	<input type="checkbox"/> Yes, <input type="checkbox"/> No	blank
12	<input type="checkbox"/> Yes, <input type="checkbox"/> <input type="checkbox"/>	<input type="checkbox"/> Yes, <input type="checkbox"/> <input type="checkbox"/>	blank
13	<input type="checkbox"/> Yes, <input type="checkbox"/> No	<input type="checkbox"/> Yes, <input type="checkbox"/> No	blank
14	<input type="checkbox"/> <input type="checkbox"/> <input type="checkbox"/> <input type="checkbox"/>	<input type="checkbox"/> Yes, <input type="checkbox"/> No	blank
15	<input type="checkbox"/> <input type="checkbox"/> <input type="checkbox"/> <input type="checkbox"/> No	<input type="checkbox"/> Yes, <input type="checkbox"/> No	blank
16	<input type="checkbox"/> <input type="checkbox"/> <input type="checkbox"/> <input type="checkbox"/> No	<input type="checkbox"/> Yes, <input type="checkbox"/> No	blank

8. Toll Restriction

)

TOLL RESTRICTION-AREA/OFFICE CODE TABLE

Item	Selection of Value	Default Value
Local Call Access (L)	Yes/No	No
Restriction Level (RL)	2 digits (01 to 16)	16: for 411,800, 911, NNX 01: NPA except the above codes
Office Code Table Number (OC)	blank : for 3 digits Toll Restriction 01 to 64 : for 6 digits Toll Restriction	blank

TOLL RESTRICTION-AREA/OFFICE CODE TABLE (1/8)

Area/Office Code Table No. 1

Code No.	Local Call Access	Restriction Level	Office Code	Code No.	Local Call Access	Restriction Level	Office Code
200	<input type="checkbox"/> Yes, <input type="checkbox"/> No			250	<input type="checkbox"/> Yes, <input type="checkbox"/> No		
201	<input type="checkbox"/> Yes, <input type="checkbox"/> No			251	<input type="checkbox"/> Yes, <input type="checkbox"/> No		
202	<input type="checkbox"/> Yes, <input type="checkbox"/> No			252	<input type="checkbox"/> Yes, <input type="checkbox"/> No		
203	<input type="checkbox"/> Yes, <input type="checkbox"/> No			253	<input type="checkbox"/> Yes, <input type="checkbox"/> No		
204	<input type="checkbox"/> Yes, <input type="checkbox"/> No			254	<input type="checkbox"/> Yes, <input type="checkbox"/> No		
205	<input type="checkbox"/> Yes, <input type="checkbox"/> No			255	<input type="checkbox"/> Yes, <input type="checkbox"/> No		
206	<input type="checkbox"/> Yes, <input type="checkbox"/> No			256	<input type="checkbox"/> Yes, <input type="checkbox"/> No		
207	<input type="checkbox"/> Yes, <input type="checkbox"/> No			257	<input type="checkbox"/> Yes, <input type="checkbox"/> No		
208	<input type="checkbox"/> Yes, <input type="checkbox"/> No			258	<input type="checkbox"/> Yes, <input type="checkbox"/> No		
209	<input type="checkbox"/> Yes, <input type="checkbox"/> No			259	<input type="checkbox"/> Yes, <input type="checkbox"/> No		
210	<input type="checkbox"/> Yes, <input type="checkbox"/> No			260	<input type="checkbox"/> Yes, <input type="checkbox"/> No		
211	<input type="checkbox"/> Yes, <input type="checkbox"/> No			261	<input type="checkbox"/> Yes, <input type="checkbox"/> No		
212	<input type="checkbox"/> Yes, <input type="checkbox"/> No			262	<input type="checkbox"/> Yes, <input type="checkbox"/> No		
213	<input type="checkbox"/> Yes, <input type="checkbox"/> No			263	<input type="checkbox"/> Yes, <input type="checkbox"/> No		
214	<input type="checkbox"/> Yes, <input type="checkbox"/> No			264	<input type="checkbox"/> Yes, <input type="checkbox"/> No		
215	<input type="checkbox"/> Yes, <input type="checkbox"/> No			265	<input type="checkbox"/> Yes, <input type="checkbox"/> No		
216	<input type="checkbox"/> Yes, <input type="checkbox"/> No			266	<input type="checkbox"/> Yes, <input type="checkbox"/> No		
217	<input type="checkbox"/> Yes, <input type="checkbox"/> No			267	<input type="checkbox"/> Yes, <input type="checkbox"/> No		
218	<input type="checkbox"/> Yes, <input type="checkbox"/> No			268	<input type="checkbox"/> Yes, <input type="checkbox"/> No		
219	<input type="checkbox"/> Yes, <input type="checkbox"/> No			269	<input type="checkbox"/> Yes, <input type="checkbox"/> No		
220	<input type="checkbox"/> Yes, <input type="checkbox"/> No			270	<input type="checkbox"/> Yes, <input type="checkbox"/> No		
221	<input type="checkbox"/> Yes, <input type="checkbox"/> No			271	<input type="checkbox"/> Yes, <input type="checkbox"/> No		
222	<input type="checkbox"/> Yes, <input type="checkbox"/> No			272	<input type="checkbox"/> Yes, <input type="checkbox"/> No		
223	<input type="checkbox"/> Yes, <input type="checkbox"/> No			273	<input type="checkbox"/> Yes, <input type="checkbox"/> No		
224	<input type="checkbox"/> Yes, <input type="checkbox"/> No			274	<input type="checkbox"/> Yes, <input type="checkbox"/> No		
225	<input type="checkbox"/> Yes, <input type="checkbox"/> No			275	<input type="checkbox"/> Yes, <input type="checkbox"/> No		
226	<input type="checkbox"/> Yes, <input type="checkbox"/> No			276	<input type="checkbox"/> Yes, <input type="checkbox"/> No		
227	<input type="checkbox"/> Yes, <input type="checkbox"/> No			277	<input type="checkbox"/> Yes, <input type="checkbox"/> No		
228	<input type="checkbox"/> Yes, <input type="checkbox"/> No			278	<input type="checkbox"/> Yes, <input type="checkbox"/> No		
229	<input type="checkbox"/> Yes, <input type="checkbox"/> No			279	<input type="checkbox"/> Yes, <input type="checkbox"/> No		
230	<input type="checkbox"/> Yes, <input type="checkbox"/> No			280	<input type="checkbox"/> Yes, <input type="checkbox"/> No		1
231	<input type="checkbox"/> Yes, <input type="checkbox"/> No			281	<input type="checkbox"/> Yes, <input type="checkbox"/> No		
232	<input type="checkbox"/> Yes, <input type="checkbox"/> No			282	<input type="checkbox"/> Yes, <input type="checkbox"/> No		
233	<input type="checkbox"/> Yes, <input type="checkbox"/> No			283	<input type="checkbox"/> Yes, <input type="checkbox"/> No		
234	<input type="checkbox"/> Yes, <input type="checkbox"/> No			284	<input type="checkbox"/> Yes, <input type="checkbox"/> No		
235	<input type="checkbox"/> Yes, <input type="checkbox"/> No			285	<input type="checkbox"/> Yes, <input type="checkbox"/> No		
236	<input type="checkbox"/> Yes, <input type="checkbox"/> No			286	<input type="checkbox"/> Yes, <input type="checkbox"/> No		
237	<input type="checkbox"/> Yes, <input type="checkbox"/> No			287	<input type="checkbox"/> Yes, <input type="checkbox"/> No		
238	<input type="checkbox"/> Yes, <input type="checkbox"/> No			288	<input type="checkbox"/> Yes, <input type="checkbox"/> No		
239	<input type="checkbox"/> Yes, <input type="checkbox"/> No			289	<input type="checkbox"/> Yes, <input type="checkbox"/> No		
240	<input type="checkbox"/> Yes, <input type="checkbox"/> No			290	<input type="checkbox"/> Yes, <input type="checkbox"/> No		
241	<input type="checkbox"/> Yes, <input type="checkbox"/> No			291	<input type="checkbox"/> Yes, <input type="checkbox"/> No		
242	<input type="checkbox"/> Yes, <input type="checkbox"/> No			292	<input type="checkbox"/> Yes, <input type="checkbox"/> No		
243	<input type="checkbox"/> Yes, <input type="checkbox"/> No			293	<input type="checkbox"/> Yes, <input type="checkbox"/> No		
244	<input type="checkbox"/> Yes, <input type="checkbox"/> No			294	<input type="checkbox"/> Yes, <input type="checkbox"/> No		
245	<input type="checkbox"/> Yes, <input type="checkbox"/> No			295	<input type="checkbox"/> Yes, <input type="checkbox"/> No		
246	<input type="checkbox"/> Yes, <input type="checkbox"/> No			296	<input type="checkbox"/> Yes, <input type="checkbox"/> No		
247	<input type="checkbox"/> Yes, <input type="checkbox"/> No			297	<input type="checkbox"/> Yes, <input type="checkbox"/> No		
248	<input type="checkbox"/> Yes, <input type="checkbox"/> No			298	<input type="checkbox"/> Yes, <input type="checkbox"/> No		
249	<input type="checkbox"/> Yes, <input type="checkbox"/> No			299	<input type="checkbox"/> Yes, <input type="checkbox"/> No		

TOLL RESTRICTION-AREA/OFFICE CODE TABLE (2/8)

Area/Office Code Table No. 1

Code No.	Local Call Access	Restriction Level	Office Code	Code No.	Local Call Access	Restriction Level	Office Code
300	<input type="checkbox"/> Yes, <input type="checkbox"/> No			350	<input type="checkbox"/> Yes, <input type="checkbox"/> No		
301	<input type="checkbox"/> Yes, <input type="checkbox"/> No			351	<input type="checkbox"/> Yes, <input type="checkbox"/> No		
302	<input type="checkbox"/> Yes, <input type="checkbox"/> No			352	<input type="checkbox"/> Yes, <input type="checkbox"/> No		
303	<input type="checkbox"/> Yes, <input type="checkbox"/> No			353	<input type="checkbox"/> Yes, <input type="checkbox"/> No		
304	<input type="checkbox"/> Yes, <input type="checkbox"/> No			354	<input type="checkbox"/> Yes, <input type="checkbox"/> No		
305	<input type="checkbox"/> Yes, <input type="checkbox"/> No			355	<input type="checkbox"/> Yes, <input type="checkbox"/> No		
306	<input type="checkbox"/> Yes, <input type="checkbox"/> No			356	<input type="checkbox"/> Yes, <input type="checkbox"/> No		
307	<input type="checkbox"/> Yes, <input type="checkbox"/> No			357	<input type="checkbox"/> Yes, <input type="checkbox"/> No		
308	<input type="checkbox"/> Yes, <input type="checkbox"/> No			360	<input type="checkbox"/> Yes, <input type="checkbox"/> No		
310	<input type="checkbox"/> Yes, <input type="checkbox"/> No			361	<input type="checkbox"/> Yes, <input type="checkbox"/> No		
311	<input type="checkbox"/> Yes, <input type="checkbox"/> No			362	<input type="checkbox"/> Yes, <input type="checkbox"/> No		
312	<input type="checkbox"/> Yes, <input type="checkbox"/> No			363	<input type="checkbox"/> Yes, <input type="checkbox"/> No		
313	<input type="checkbox"/> Yes, <input type="checkbox"/> No			364	<input type="checkbox"/> Yes, <input type="checkbox"/> No		
314	<input type="checkbox"/> Yes, <input type="checkbox"/> No			365	<input type="checkbox"/> Yes, <input type="checkbox"/> No		
315	<input type="checkbox"/> Yes, <input type="checkbox"/> No			366	<input type="checkbox"/> Yes, <input type="checkbox"/> No		
316	<input type="checkbox"/> Yes, <input type="checkbox"/> No			367	<input type="checkbox"/> Yes, <input type="checkbox"/> No		
317	<input type="checkbox"/> Yes, <input type="checkbox"/> No			368	<input type="checkbox"/> Yes, <input type="checkbox"/> No		
318	<input type="checkbox"/> Yes, <input type="checkbox"/> No			369	<input type="checkbox"/> Yes, <input type="checkbox"/> No		
319	<input type="checkbox"/> Yes, <input type="checkbox"/> No			370	<input type="checkbox"/> Yes, <input type="checkbox"/> No		
320	<input type="checkbox"/> Yes, <input type="checkbox"/> No			371	<input type="checkbox"/> Yes, <input type="checkbox"/> No		
321	<input type="checkbox"/> Yes, <input type="checkbox"/> No			372	<input type="checkbox"/> Yes, <input type="checkbox"/> No		
322	<input type="checkbox"/> Yes, <input type="checkbox"/> No			373	<input type="checkbox"/> Yes, <input type="checkbox"/> No		
323	<input type="checkbox"/> Yes, <input type="checkbox"/> No			374	<input type="checkbox"/> Yes, <input type="checkbox"/> No		
324	<input type="checkbox"/> Yes, <input type="checkbox"/> No			375	<input type="checkbox"/> Yes, <input type="checkbox"/> No		
325	<input type="checkbox"/> Yes, <input type="checkbox"/> No			376	<input type="checkbox"/> Yes, <input type="checkbox"/> No		
326	<input type="checkbox"/> Yes, <input type="checkbox"/> No			377	<input type="checkbox"/> Yes, <input type="checkbox"/> No		
327	<input type="checkbox"/> Yes, <input type="checkbox"/> No			378	<input type="checkbox"/> Yes, <input type="checkbox"/> No		
328	<input type="checkbox"/> Yes, <input type="checkbox"/> No			379	<input type="checkbox"/> Yes, <input type="checkbox"/> No		
329	<input type="checkbox"/> Yes, <input type="checkbox"/> No			380	<input type="checkbox"/> Yes, <input type="checkbox"/> No		
330	<input type="checkbox"/> Yes, <input type="checkbox"/> No			381	<input type="checkbox"/> Yes, <input type="checkbox"/> No		
331	<input type="checkbox"/> Yes, <input type="checkbox"/> No			382	<input type="checkbox"/> Yes, <input type="checkbox"/> No		
332	<input type="checkbox"/> Yes, <input type="checkbox"/> No			383	<input type="checkbox"/> Yes, <input type="checkbox"/> No		
333	<input type="checkbox"/> Yes, <input type="checkbox"/> No			384	<input type="checkbox"/> Yes, <input type="checkbox"/> No		
334	<input type="checkbox"/> Yes, <input type="checkbox"/> No			385	<input type="checkbox"/> Yes, <input type="checkbox"/> No		
335	<input type="checkbox"/> Yes, <input type="checkbox"/> No			386	<input type="checkbox"/> Yes, <input type="checkbox"/> No		
336	<input type="checkbox"/> Yes, <input type="checkbox"/> No			387	<input type="checkbox"/> Yes, <input type="checkbox"/> No		
337	<input type="checkbox"/> Yes, <input type="checkbox"/> No			388	<input type="checkbox"/> Yes, <input type="checkbox"/> No		
338	<input type="checkbox"/> Yes, <input type="checkbox"/> No			389	<input type="checkbox"/> Yes, <input type="checkbox"/> No		
339	<input type="checkbox"/> Yes, <input type="checkbox"/> No			390	<input type="checkbox"/> Yes, <input type="checkbox"/> No		
340	<input type="checkbox"/> Yes, <input type="checkbox"/> No			391	<input type="checkbox"/> Yes, <input type="checkbox"/> No		
341	<input type="checkbox"/> Yes, <input type="checkbox"/> No			392	<input type="checkbox"/> Yes, <input type="checkbox"/> No		
342	<input type="checkbox"/> Yes, <input type="checkbox"/> No			393	<input type="checkbox"/> Yes, <input type="checkbox"/> No		
343	<input type="checkbox"/> Yes, <input type="checkbox"/> No			394	<input type="checkbox"/> Yes, <input type="checkbox"/> No		
344	<input type="checkbox"/> Yes, <input type="checkbox"/> No			395	<input type="checkbox"/> Yes, <input type="checkbox"/> No		
345	<input type="checkbox"/> Yes, <input type="checkbox"/> No			396	<input type="checkbox"/> Yes, <input type="checkbox"/> No		
346	<input type="checkbox"/> Yes, <input type="checkbox"/> No			397	<input type="checkbox"/> Yes, <input type="checkbox"/> No		
347	<input type="checkbox"/> Yes, <input type="checkbox"/> No			398	<input type="checkbox"/> Yes, <input type="checkbox"/> No		
348	<input type="checkbox"/> Yes, <input type="checkbox"/> No			399	<input type="checkbox"/> Yes, <input type="checkbox"/> No		
349	<input type="checkbox"/> Yes, <input type="checkbox"/> No						

TOLL RESTRICTION-AREA/OFFICE CODE TABLE (3/8)

Area/Office Code Table No. 1

Code No.	Local Call Access	Restriction Level	Office Code	Code No.	Local Call Access	Restriction Level	Office Code
400	<input type="checkbox"/> Yes, <input checked="" type="checkbox"/> No			450	<input type="checkbox"/> Yes, <input checked="" type="checkbox"/> No		
401	<input type="checkbox"/> Yes, <input checked="" type="checkbox"/> No			45.1	<input type="checkbox"/> Yes, <input checked="" type="checkbox"/> No		
402	<input type="checkbox"/> Yes, <input checked="" type="checkbox"/> No			452	<input type="checkbox"/> Yes, <input checked="" type="checkbox"/> No		
403	<input type="checkbox"/> Yes, <input checked="" type="checkbox"/> No			453	<input type="checkbox"/> Yes, <input checked="" type="checkbox"/> No		
404	<input type="checkbox"/> Yes, <input checked="" type="checkbox"/> No			454	<input type="checkbox"/> Yes, <input checked="" type="checkbox"/> No		
405	<input type="checkbox"/> Yes, <input checked="" type="checkbox"/> No			455	<input type="checkbox"/> Yes, <input checked="" type="checkbox"/> No		
406	<input type="checkbox"/> Yes, <input checked="" type="checkbox"/> No			456	<input type="checkbox"/> Yes, <input checked="" type="checkbox"/> No		
407	<input type="checkbox"/> Yes, <input checked="" type="checkbox"/> No			457	<input type="checkbox"/> Yes, <input checked="" type="checkbox"/> No		
408	<input type="checkbox"/> Yes, <input checked="" type="checkbox"/> No			458	<input type="checkbox"/> Yes, <input checked="" type="checkbox"/> No		
409	<input type="checkbox"/> Yes, <input checked="" type="checkbox"/> No			459	<input type="checkbox"/> Yes, <input checked="" type="checkbox"/> No		
410	<input type="checkbox"/> Yes, <input checked="" type="checkbox"/> No			460	<input type="checkbox"/> Yes, <input checked="" type="checkbox"/> No		
411	<input type="checkbox"/> Yes, <input checked="" type="checkbox"/> No			461	<input type="checkbox"/> Yes, <input checked="" type="checkbox"/> No		
412	<input type="checkbox"/> Yes, <input checked="" type="checkbox"/> No			462	<input type="checkbox"/> Yes, <input checked="" type="checkbox"/> No		
413	<input type="checkbox"/> Yes, <input checked="" type="checkbox"/> No			463	<input type="checkbox"/> Yes, <input checked="" type="checkbox"/> No		
414	<input type="checkbox"/> Yes, <input checked="" type="checkbox"/> No			464	<input type="checkbox"/> Yes, <input checked="" type="checkbox"/> No		
415	<input type="checkbox"/> Yes, <input checked="" type="checkbox"/> No			465	<input type="checkbox"/> Yes, <input checked="" type="checkbox"/> No		
416	<input type="checkbox"/> Yes, <input checked="" type="checkbox"/> No			466	<input type="checkbox"/> Yes, <input checked="" type="checkbox"/> No		
417	<input type="checkbox"/> Yes, <input checked="" type="checkbox"/> No			467	<input type="checkbox"/> Yes, <input checked="" type="checkbox"/> No		
418	<input type="checkbox"/> Yes, <input checked="" type="checkbox"/> No			468	<input type="checkbox"/> Yes, <input checked="" type="checkbox"/> No		
419	<input type="checkbox"/> Yes, <input checked="" type="checkbox"/> No			469	<input type="checkbox"/> Yes, <input checked="" type="checkbox"/> No		
420	<input type="checkbox"/> Yes, <input checked="" type="checkbox"/> No			470	<input type="checkbox"/> Yes, <input checked="" type="checkbox"/> No		
421	<input type="checkbox"/> Yes, <input checked="" type="checkbox"/> No			471	<input type="checkbox"/> Yes, <input checked="" type="checkbox"/> No		
422	<input type="checkbox"/> Yes, <input checked="" type="checkbox"/> No			472	<input type="checkbox"/> Yes, <input checked="" type="checkbox"/> No		
423	<input type="checkbox"/> Yes, <input checked="" type="checkbox"/> No			473	<input type="checkbox"/> Yes, <input checked="" type="checkbox"/> No		
424	<input type="checkbox"/> Yes, <input checked="" type="checkbox"/> No			474	<input type="checkbox"/> Yes, <input checked="" type="checkbox"/> No		
425	<input type="checkbox"/> Yes, <input checked="" type="checkbox"/> No			475	<input type="checkbox"/> Yes, <input checked="" type="checkbox"/> No		
426	<input type="checkbox"/> Yes, <input checked="" type="checkbox"/> No			476	<input type="checkbox"/> Yes, <input checked="" type="checkbox"/> No		
427	<input type="checkbox"/> Yes, <input checked="" type="checkbox"/> No			477	<input type="checkbox"/> Yes, <input checked="" type="checkbox"/> No		
428	<input type="checkbox"/> Yes, <input checked="" type="checkbox"/> No			478	<input type="checkbox"/> Yes, <input checked="" type="checkbox"/> No		
429	<input type="checkbox"/> Yes, <input checked="" type="checkbox"/> No			479	<input type="checkbox"/> Yes, <input checked="" type="checkbox"/> No		
430	<input type="checkbox"/> Yes, <input checked="" type="checkbox"/> No			480	<input type="checkbox"/> Yes, <input checked="" type="checkbox"/> No		
431	<input type="checkbox"/> Yes, <input checked="" type="checkbox"/> No			481	<input type="checkbox"/> Yes, <input checked="" type="checkbox"/> No		
432	<input type="checkbox"/> Yes, <input checked="" type="checkbox"/> No			482	<input type="checkbox"/> Yes, <input checked="" type="checkbox"/> No		
433	<input type="checkbox"/> Yes, <input checked="" type="checkbox"/> No			483	<input type="checkbox"/> Yes, <input checked="" type="checkbox"/> No		
434	<input type="checkbox"/> Yes, <input checked="" type="checkbox"/> No			484	<input type="checkbox"/> Yes, <input checked="" type="checkbox"/> No		
435	<input type="checkbox"/> Yes, <input checked="" type="checkbox"/> No			485	<input type="checkbox"/> Yes, <input checked="" type="checkbox"/> No		
436	<input type="checkbox"/> Yes, <input checked="" type="checkbox"/> No			486	<input type="checkbox"/> Yes, <input checked="" type="checkbox"/> No		
437	<input type="checkbox"/> Yes, <input checked="" type="checkbox"/> No			487	<input type="checkbox"/> Yes, <input checked="" type="checkbox"/> No		
438	<input type="checkbox"/> Yes, <input checked="" type="checkbox"/> No			488	<input type="checkbox"/> Yes, <input checked="" type="checkbox"/> No		
439	<input type="checkbox"/> Yes, <input checked="" type="checkbox"/> No			489	<input type="checkbox"/> Yes, <input checked="" type="checkbox"/> No		
440	<input type="checkbox"/> Yes, <input checked="" type="checkbox"/> No			490	<input type="checkbox"/> Yes, <input checked="" type="checkbox"/> No		
441	<input type="checkbox"/> Yes, <input checked="" type="checkbox"/> No			491	<input type="checkbox"/> Yes, <input checked="" type="checkbox"/> No		
442	<input type="checkbox"/> Yes, <input checked="" type="checkbox"/> No			492	<input type="checkbox"/> Yes, <input checked="" type="checkbox"/> No		
443	<input type="checkbox"/> Yes, <input checked="" type="checkbox"/> No			493	<input type="checkbox"/> Yes, <input checked="" type="checkbox"/> No		
444	<input type="checkbox"/> Yes, <input checked="" type="checkbox"/> No			494	<input type="checkbox"/> Yes, <input checked="" type="checkbox"/> No		
445	<input type="checkbox"/> Yes, <input checked="" type="checkbox"/> No			495	<input type="checkbox"/> Yes, <input checked="" type="checkbox"/> No		
446	<input type="checkbox"/> Yes, <input checked="" type="checkbox"/> No			496	<input type="checkbox"/> Yes, <input checked="" type="checkbox"/> No		
447	<input type="checkbox"/> Yes, <input checked="" type="checkbox"/> No			497	<input type="checkbox"/> Yes, <input checked="" type="checkbox"/> No		
448	<input type="checkbox"/> Yes, <input checked="" type="checkbox"/> No			498	<input type="checkbox"/> Yes, <input checked="" type="checkbox"/> No		
449	<input type="checkbox"/> Yes, <input checked="" type="checkbox"/> No			499	<input type="checkbox"/> Yes, <input checked="" type="checkbox"/> No		

TOLL RESTRICTION-AREA/OFFICE CODE TABLE (4/8)

Area/Office Code Table No. 1

Code No.	Local Call Access	Restriction Level	Office Code	Code No.	Local Call Access	Restriction Level	Office Code
500	<input type="checkbox"/> Yes, <input type="checkbox"/> No			550	<input type="checkbox"/> Yes, <input type="checkbox"/> No		
501	<input type="checkbox"/> Yes, <input type="checkbox"/> No			551	<input type="checkbox"/> Yes, <input type="checkbox"/> No		
502	<input type="checkbox"/> Yes, <input type="checkbox"/> No			552	<input type="checkbox"/> Yes, <input type="checkbox"/> No		
503	<input type="checkbox"/> Yes, <input type="checkbox"/> No			553	<input type="checkbox"/> Yes, <input type="checkbox"/> No		
504	<input type="checkbox"/> Yes, <input type="checkbox"/> No			554	<input type="checkbox"/> Yes, <input type="checkbox"/> No		
505	<input type="checkbox"/> Yes, <input type="checkbox"/> No			555	<input type="checkbox"/> Yes, <input type="checkbox"/> No		
506	<input type="checkbox"/> Yes, <input type="checkbox"/> No			556	<input type="checkbox"/> Yes, <input type="checkbox"/> No		
507	<input type="checkbox"/> Yes, <input type="checkbox"/> No			557	<input type="checkbox"/> Yes, <input type="checkbox"/> No		
508	<input type="checkbox"/> Yes, <input type="checkbox"/> No			558	<input type="checkbox"/> Yes, <input type="checkbox"/> No		
509	<input type="checkbox"/> Yes, <input type="checkbox"/> No			559	<input type="checkbox"/> Yes, <input type="checkbox"/> No		
510	<input type="checkbox"/> Yes, <input type="checkbox"/> No			560	<input type="checkbox"/> Yes, <input type="checkbox"/> No		
511	<input type="checkbox"/> Yes, <input type="checkbox"/> No			561	<input type="checkbox"/> Yes, <input type="checkbox"/> No		
512	<input type="checkbox"/> Yes, <input type="checkbox"/> No			562	<input type="checkbox"/> Yes, <input type="checkbox"/> No		
513	<input type="checkbox"/> Yes, <input type="checkbox"/> No			563	<input type="checkbox"/> Yes, <input type="checkbox"/> No		
514	<input type="checkbox"/> Yes, <input type="checkbox"/> No			564	<input type="checkbox"/> Yes, <input type="checkbox"/> No		
515	<input type="checkbox"/> Yes, <input type="checkbox"/> No			565	<input type="checkbox"/> Yes, <input type="checkbox"/> No		
516	<input type="checkbox"/> Yes, <input type="checkbox"/> No			566	<input type="checkbox"/> Yes, <input type="checkbox"/> No		
517	<input type="checkbox"/> Yes, <input type="checkbox"/> No			567	<input type="checkbox"/> Yes, <input type="checkbox"/> No		
518	<input type="checkbox"/> Yes, <input type="checkbox"/> No			568	<input type="checkbox"/> Yes, <input type="checkbox"/> No		
519	<input type="checkbox"/> Yes, <input type="checkbox"/> No			569	<input type="checkbox"/> Yes, <input type="checkbox"/> No		
520	<input type="checkbox"/> Yes, <input type="checkbox"/> No			570	<input type="checkbox"/> Yes, <input type="checkbox"/> No		
521	<input type="checkbox"/> Yes, <input type="checkbox"/> No			571	<input type="checkbox"/> Yes, <input type="checkbox"/> No		
522	<input type="checkbox"/> Yes, <input type="checkbox"/> No			572	<input type="checkbox"/> Yes, <input type="checkbox"/> No		
523	<input type="checkbox"/> Yes, <input type="checkbox"/> No			573	<input type="checkbox"/> Yes, <input type="checkbox"/> No		
524	<input type="checkbox"/> Yes, <input type="checkbox"/> No			574	<input type="checkbox"/> Yes, <input type="checkbox"/> No		
525	<input type="checkbox"/> Yes, <input type="checkbox"/> No			575	<input type="checkbox"/> Yes, <input type="checkbox"/> No		
526	<input type="checkbox"/> Yes, <input type="checkbox"/> No			576	<input type="checkbox"/> Yes, <input type="checkbox"/> No		
527	<input type="checkbox"/> Yes, <input type="checkbox"/> No			577	<input type="checkbox"/> Yes, <input type="checkbox"/> No		
528	<input type="checkbox"/> Yes, <input type="checkbox"/> No			578	<input type="checkbox"/> Yes, <input type="checkbox"/> No		
529	<input type="checkbox"/> Yes, <input type="checkbox"/> No			579	<input type="checkbox"/> Yes, <input type="checkbox"/> No		
530	<input type="checkbox"/> Yes, <input type="checkbox"/> No			580	<input type="checkbox"/> Yes, <input type="checkbox"/> No		
531	<input type="checkbox"/> Yes, <input type="checkbox"/> No			581	<input type="checkbox"/> Yes, <input type="checkbox"/> No		
532	<input type="checkbox"/> Yes, <input type="checkbox"/> No			582	<input type="checkbox"/> Yes, <input type="checkbox"/> No		
533	<input type="checkbox"/> Yes, <input type="checkbox"/> No			583	<input type="checkbox"/> Yes, <input type="checkbox"/> No		
534	<input type="checkbox"/> Yes, <input type="checkbox"/> No			584	<input type="checkbox"/> Yes, <input type="checkbox"/> No		
535	<input type="checkbox"/> Yes, <input type="checkbox"/> No			585	<input type="checkbox"/> Yes, <input type="checkbox"/> No		
536	<input type="checkbox"/> Yes, <input type="checkbox"/> No			586	<input type="checkbox"/> Yes, <input type="checkbox"/> No		
537	<input type="checkbox"/> Yes, <input type="checkbox"/> No			587	<input type="checkbox"/> Yes, <input type="checkbox"/> No		
538	<input type="checkbox"/> Yes, <input type="checkbox"/> No			588	<input type="checkbox"/> Yes, <input type="checkbox"/> No		
539	<input type="checkbox"/> Yes, <input type="checkbox"/> No			589	<input type="checkbox"/> Yes, <input type="checkbox"/> No		
540	<input type="checkbox"/> Yes, <input type="checkbox"/> No			590	<input type="checkbox"/> Yes, <input type="checkbox"/> No		
541	<input type="checkbox"/> Yes, <input type="checkbox"/> No			591	<input type="checkbox"/> Yes, <input type="checkbox"/> No		
542	<input type="checkbox"/> Yes, <input type="checkbox"/> No			592	<input type="checkbox"/> Yes, <input type="checkbox"/> No		
543	<input type="checkbox"/> Yes, <input type="checkbox"/> No			593	<input type="checkbox"/> Yes, <input type="checkbox"/> No		
544	<input type="checkbox"/> Yes, <input type="checkbox"/> No			594	<input type="checkbox"/> Yes, <input type="checkbox"/> No		
545	<input type="checkbox"/> Yes, <input type="checkbox"/> No			595	<input type="checkbox"/> Yes, <input type="checkbox"/> No		
546	<input type="checkbox"/> Yes, <input type="checkbox"/> No			596	<input type="checkbox"/> Yes, <input type="checkbox"/> No		
547	<input type="checkbox"/> Yes, <input type="checkbox"/> No			597	<input type="checkbox"/> Yes, <input type="checkbox"/> No		
548	<input type="checkbox"/> Yes, <input type="checkbox"/> No			598	<input type="checkbox"/> Yes, <input type="checkbox"/> No		
549	<input type="checkbox"/> Yes, <input type="checkbox"/> No			599	<input type="checkbox"/> Yes, <input type="checkbox"/> No		

TOLL RESTRICTION-AREA/OFFICE CODE TABLE (5/8)

Area/Office Code Table No. 1

Code No.	Local Call Access	Restriction Level	Office Code	Code No.	Local Call Access	Restriction Level	Office Code
601	<input type="checkbox"/> Yes, <input type="checkbox"/> No			650	<input type="checkbox"/> Yes, <input type="checkbox"/> No		
602	<input type="checkbox"/> Yes, <input type="checkbox"/> No			651	<input type="checkbox"/> Yes, <input type="checkbox"/> No		
603	<input type="checkbox"/> Yes, <input type="checkbox"/> No			652	<input type="checkbox"/> Yes, <input type="checkbox"/> No		
604	<input type="checkbox"/> Yes, <input type="checkbox"/> No			653	<input type="checkbox"/> Yes, <input type="checkbox"/> No		
605	<input type="checkbox"/> Yes, <input type="checkbox"/> No			654	<input type="checkbox"/> Yes, <input type="checkbox"/> No		
606	<input type="checkbox"/> Yes, <input type="checkbox"/> No			655	<input type="checkbox"/> Yes, <input type="checkbox"/> No		
607	<input type="checkbox"/> Yes, <input type="checkbox"/> No			656	<input type="checkbox"/> Yes, <input type="checkbox"/> No		
608	<input type="checkbox"/> Yes, <input type="checkbox"/> No			657	<input type="checkbox"/> Yes, <input type="checkbox"/> No		
609	<input type="checkbox"/> Yes, <input type="checkbox"/> No			658	<input type="checkbox"/> Yes, <input type="checkbox"/> No		
610	<input type="checkbox"/> Yes, <input type="checkbox"/> No			659	<input type="checkbox"/> Yes, <input type="checkbox"/> No		
611	<input type="checkbox"/> Yes, <input type="checkbox"/> No			660	<input type="checkbox"/> Yes, <input type="checkbox"/> No		
612	<input type="checkbox"/> Yes, <input type="checkbox"/> No			661	<input type="checkbox"/> Yes, <input type="checkbox"/> No		
613	<input type="checkbox"/> Yes, <input type="checkbox"/> No			662	<input type="checkbox"/> Yes, <input type="checkbox"/> No		
614	<input type="checkbox"/> Yes, <input type="checkbox"/> No			663	<input type="checkbox"/> Yes, <input type="checkbox"/> No		
615	<input type="checkbox"/> Yes, <input type="checkbox"/> No			664	<input type="checkbox"/> Yes, <input type="checkbox"/> No		
616	<input type="checkbox"/> Yes, <input type="checkbox"/> No			665	<input type="checkbox"/> Yes, <input type="checkbox"/> No		
617	<input type="checkbox"/> Yes, <input type="checkbox"/> No			666	<input type="checkbox"/> Yes, <input type="checkbox"/> No		
618	<input type="checkbox"/> Yes, <input type="checkbox"/> No			667	<input type="checkbox"/> Yes, <input type="checkbox"/> No		
619	<input type="checkbox"/> Yes, <input type="checkbox"/> No			668	<input type="checkbox"/> Yes, <input type="checkbox"/> No		
620	<input type="checkbox"/> Yes, <input type="checkbox"/> No			669	<input type="checkbox"/> Yes, <input type="checkbox"/> No		
621	<input type="checkbox"/> Yes, <input type="checkbox"/> No			670	<input type="checkbox"/> Yes, <input type="checkbox"/> No		
622	<input type="checkbox"/> Yes, <input type="checkbox"/> No			671	<input type="checkbox"/> Yes, <input type="checkbox"/> No		
623	<input type="checkbox"/> Yes, <input type="checkbox"/> No			672	<input type="checkbox"/> Yes, <input type="checkbox"/> No		
624	<input type="checkbox"/> Yes, <input type="checkbox"/> No			673	<input type="checkbox"/> Yes, <input type="checkbox"/> No		
625	<input type="checkbox"/> Yes, <input type="checkbox"/> No			674	<input type="checkbox"/> Yes, <input type="checkbox"/> No		
626	<input type="checkbox"/> Yes, <input type="checkbox"/> No			675	<input type="checkbox"/> Yes, <input type="checkbox"/> No		
627	<input type="checkbox"/> Yes, <input type="checkbox"/> No			676	<input type="checkbox"/> Yes, <input type="checkbox"/> No		
628	<input type="checkbox"/> Yes, <input type="checkbox"/> No			677	<input type="checkbox"/> Yes, <input type="checkbox"/> No		
629	<input type="checkbox"/> Yes, <input type="checkbox"/> No			678	<input type="checkbox"/> Yes, <input type="checkbox"/> No		
630	<input type="checkbox"/> Yes, <input type="checkbox"/> No			679	<input type="checkbox"/> Yes, <input type="checkbox"/> No		
631	<input type="checkbox"/> Yes, <input type="checkbox"/> No			680	<input type="checkbox"/> Yes, <input type="checkbox"/> No		
632	<input type="checkbox"/> Yes, <input type="checkbox"/> No			681	<input type="checkbox"/> Yes, <input type="checkbox"/> No		
633	<input type="checkbox"/> Yes, <input type="checkbox"/> No			682	<input type="checkbox"/> Yes, <input type="checkbox"/> No		
634	<input type="checkbox"/> Yes, <input type="checkbox"/> No			683	<input type="checkbox"/> Yes, <input type="checkbox"/> No		
635	<input type="checkbox"/> Yes, <input type="checkbox"/> No			684	<input type="checkbox"/> Yes, <input type="checkbox"/> No		
636	<input type="checkbox"/> Yes, <input type="checkbox"/> No			685	<input type="checkbox"/> Yes, <input type="checkbox"/> No		
637	<input type="checkbox"/> Yes, <input type="checkbox"/> No			686	<input type="checkbox"/> Yes, <input type="checkbox"/> No		
638	<input type="checkbox"/> Yes, <input type="checkbox"/> No			687	<input type="checkbox"/> Yes, <input type="checkbox"/> No		
639	<input type="checkbox"/> Yes, <input type="checkbox"/> No			688	<input type="checkbox"/> Yes, <input type="checkbox"/> No		
640	<input type="checkbox"/> Yes, <input type="checkbox"/> No			689	<input type="checkbox"/> Yes, <input type="checkbox"/> No		
641	<input type="checkbox"/> Yes, <input type="checkbox"/> No						
642	<input type="checkbox"/> Yes, <input type="checkbox"/> No						
643	<input type="checkbox"/> Yes, <input type="checkbox"/> No						
644	<input type="checkbox"/> Yes, <input type="checkbox"/> No						
645	<input type="checkbox"/> Yes, <input type="checkbox"/> No						
646	<input type="checkbox"/> Yes, <input type="checkbox"/> No						
647	<input type="checkbox"/> Yes, <input type="checkbox"/> No						
648	<input type="checkbox"/> Yes, <input type="checkbox"/> No						
649	<input type="checkbox"/> Yes, <input type="checkbox"/> No						

TOLL RESTRICTION-AREA/OFFICE CODE TABLE (6/8)

Area/Office Code Table No. 1

Code No.	Local Call Access	Restriction Level	Office Code	Code No.	Local Call Access	Restriction Level	Office Code
700	<input type="checkbox"/> Yes, <input type="checkbox"/> No			750	<input type="checkbox"/> Yes, <input type="checkbox"/> No		
701	<input type="checkbox"/> Yes, <input type="checkbox"/> No			751	<input type="checkbox"/> Yes, <input type="checkbox"/> No		
702	<input type="checkbox"/> Yes, <input type="checkbox"/> No			752	<input type="checkbox"/> Yes, <input type="checkbox"/> No		
703	<input type="checkbox"/> Yes, <input type="checkbox"/> No			753	<input type="checkbox"/> Yes, <input type="checkbox"/> No		
704	<input type="checkbox"/> Yes, <input type="checkbox"/> No			754	<input type="checkbox"/> Yes, <input type="checkbox"/> No		
705	<input type="checkbox"/> Yes, <input type="checkbox"/> No			755	<input type="checkbox"/> Yes, <input type="checkbox"/> No		
706	<input type="checkbox"/> Yes, <input type="checkbox"/> No			756	<input type="checkbox"/> Yes, <input type="checkbox"/> No		
707	<input type="checkbox"/> Yes, <input type="checkbox"/> No			757	<input type="checkbox"/> Yes, <input type="checkbox"/> No		
708	<input type="checkbox"/> Yes, <input type="checkbox"/> No			758	<input type="checkbox"/> Yes, <input type="checkbox"/> No		
709	<input type="checkbox"/> Yes, <input type="checkbox"/> No			759	<input type="checkbox"/> Yes, <input type="checkbox"/> No		
710	<input type="checkbox"/> Yes, <input type="checkbox"/> No			760	<input type="checkbox"/> Yes, <input type="checkbox"/> No		
711	<input type="checkbox"/> Yes, <input type="checkbox"/> No			761	<input type="checkbox"/> Yes, <input type="checkbox"/> No		
712	<input type="checkbox"/> Yes, <input type="checkbox"/> No			762	<input type="checkbox"/> Yes, <input type="checkbox"/> No		
713	<input type="checkbox"/> Yes, <input type="checkbox"/> No			763	<input type="checkbox"/> Yes, <input type="checkbox"/> No		
714	<input type="checkbox"/> Yes, <input type="checkbox"/> No			764	<input type="checkbox"/> Yes, <input type="checkbox"/> No		
715	<input type="checkbox"/> Yes, <input type="checkbox"/> No			765	<input type="checkbox"/> Yes, <input type="checkbox"/> No		
716	<input type="checkbox"/> Yes, <input type="checkbox"/> No			766	<input type="checkbox"/> Yes, <input type="checkbox"/> No		
717	<input type="checkbox"/> Yes, <input type="checkbox"/> No			767	<input type="checkbox"/> Yes, <input type="checkbox"/> No		
718	<input type="checkbox"/> Yes, <input type="checkbox"/> No			768	<input type="checkbox"/> Yes, <input type="checkbox"/> No		
719	<input type="checkbox"/> Yes, <input type="checkbox"/> No			769	<input type="checkbox"/> Yes, <input type="checkbox"/> No		
720	<input type="checkbox"/> Yes, <input type="checkbox"/> No			770	<input type="checkbox"/> Yes, <input type="checkbox"/> No		
721	<input type="checkbox"/> Yes, <input type="checkbox"/> No			771	<input type="checkbox"/> Yes, <input type="checkbox"/> No		
722	<input type="checkbox"/> Yes, <input type="checkbox"/> No			772	<input type="checkbox"/> Yes, <input type="checkbox"/> No		
723	<input type="checkbox"/> Yes, <input type="checkbox"/> No			773	<input type="checkbox"/> Yes, <input type="checkbox"/> No		
724	<input type="checkbox"/> Yes, <input type="checkbox"/> No			774	<input type="checkbox"/> Yes, <input type="checkbox"/> No		
725	<input type="checkbox"/> Yes, <input type="checkbox"/> No			775	<input type="checkbox"/> Yes, <input type="checkbox"/> No		
726	<input type="checkbox"/> Yes, <input type="checkbox"/> No			776	<input type="checkbox"/> Yes, <input type="checkbox"/> No		
727	<input type="checkbox"/> Yes, <input type="checkbox"/> No			777	<input type="checkbox"/> Yes, <input type="checkbox"/> No		
728	<input type="checkbox"/> Yes, <input type="checkbox"/> No			778	<input type="checkbox"/> Yes, <input type="checkbox"/> No		
729	<input type="checkbox"/> Yes, <input type="checkbox"/> No			779	<input type="checkbox"/> Yes, <input type="checkbox"/> No		
730	<input type="checkbox"/> Yes, <input type="checkbox"/> No			780	<input type="checkbox"/> Yes, <input type="checkbox"/> No		
731	<input type="checkbox"/> Yes, <input type="checkbox"/> No			781	<input type="checkbox"/> Yes, <input type="checkbox"/> No		
732	<input type="checkbox"/> Yes, <input type="checkbox"/> No			782	<input type="checkbox"/> Yes, <input type="checkbox"/> No		
733	<input type="checkbox"/> Yes, <input type="checkbox"/> No			783	<input type="checkbox"/> Yes, <input type="checkbox"/> No		
734	<input type="checkbox"/> Yes, <input type="checkbox"/> No			784	<input type="checkbox"/> Yes, <input type="checkbox"/> No		
735	<input type="checkbox"/> Yes, <input type="checkbox"/> No			785	<input type="checkbox"/> Yes, <input type="checkbox"/> No		
736	<input type="checkbox"/> Yes, <input type="checkbox"/> No			786	<input type="checkbox"/> Yes, <input type="checkbox"/> No		
737	<input type="checkbox"/> Yes, <input type="checkbox"/> No			787	<input type="checkbox"/> Yes, <input type="checkbox"/> No		
738	<input type="checkbox"/> Yes, <input type="checkbox"/> No			788	<input type="checkbox"/> Yes, <input type="checkbox"/> No		
739	<input type="checkbox"/> Yes, <input type="checkbox"/> No			789	<input type="checkbox"/> Yes, <input type="checkbox"/> No		
740	<input type="checkbox"/> Yes, <input type="checkbox"/> No			790	<input type="checkbox"/> Yes, <input type="checkbox"/> No		
741	<input type="checkbox"/> Yes, <input type="checkbox"/> No			791	<input type="checkbox"/> Yes, <input type="checkbox"/> No		
742	<input type="checkbox"/> Yes, <input type="checkbox"/> No			792	<input type="checkbox"/> Yes, <input type="checkbox"/> No		
743	<input type="checkbox"/> Yes, <input type="checkbox"/> No			793	<input type="checkbox"/> Yes, <input type="checkbox"/> No		
744	<input type="checkbox"/> Yes, <input type="checkbox"/> No			794	<input type="checkbox"/> Yes, <input type="checkbox"/> No		
745	<input type="checkbox"/> Yes, <input type="checkbox"/> No			795	<input type="checkbox"/> Yes, <input type="checkbox"/> No		
746	<input type="checkbox"/> Yes, <input type="checkbox"/> No			796	<input type="checkbox"/> Yes, <input type="checkbox"/> No		
747	<input type="checkbox"/> Yes, <input type="checkbox"/> No			797	<input type="checkbox"/> Yes, <input type="checkbox"/> No		
748	<input type="checkbox"/> Yes, <input type="checkbox"/> No			798	<input type="checkbox"/> Yes, <input type="checkbox"/> No		
749	<input type="checkbox"/> Yes, <input type="checkbox"/> No			799	<input type="checkbox"/> Yes, <input type="checkbox"/> No		

TOLL RESTRICTION—AREA/OFFICE CODE TABLE (7/8)

Area/Office Code Table No. 1

Code No.	Local Call Access	Restriction Level	Office Code	Code No.	Local Call Access	Restriction Level	Office Code
800	<input type="checkbox"/> Yes, <input type="checkbox"/> No			850	<input type="checkbox"/> Yes, <input type="checkbox"/> No		
801	<input type="checkbox"/> Yes, <input type="checkbox"/> No			851	<input type="checkbox"/> Yes, <input type="checkbox"/> No		
802	<input type="checkbox"/> Yes, <input type="checkbox"/> No			852	<input type="checkbox"/> Yes, <input type="checkbox"/> No		
803	<input type="checkbox"/> Yes, <input type="checkbox"/> No			853	<input type="checkbox"/> Yes, <input type="checkbox"/> No		
804	<input type="checkbox"/> Yes, <input type="checkbox"/> No			854	<input type="checkbox"/> Yes, <input type="checkbox"/> No		
805	<input type="checkbox"/> Yes, <input type="checkbox"/> No			855	<input type="checkbox"/> Yes, <input type="checkbox"/> No		
806	<input type="checkbox"/> Yes, <input type="checkbox"/> No			856	<input type="checkbox"/> Yes, <input type="checkbox"/> No		
807	<input type="checkbox"/> Yes, <input type="checkbox"/> No			857	<input type="checkbox"/> Yes, <input type="checkbox"/> No		
808	<input type="checkbox"/> Yes, <input type="checkbox"/> No			858	<input type="checkbox"/> Yes, <input type="checkbox"/> No		
809	<input type="checkbox"/> Yes, <input type="checkbox"/> No			859	<input type="checkbox"/> Yes, <input type="checkbox"/> No		
810	<input type="checkbox"/> Yes, <input type="checkbox"/> No			860	<input type="checkbox"/> Yes, <input type="checkbox"/> No		
811	<input type="checkbox"/> Yes, <input type="checkbox"/> No			861	<input type="checkbox"/> Yes, <input type="checkbox"/> No		
812	<input type="checkbox"/> Yes, <input type="checkbox"/> No			862	<input type="checkbox"/> Yes, <input type="checkbox"/> No		
813	<input type="checkbox"/> Yes, <input type="checkbox"/> No			863	<input type="checkbox"/> Yes, <input type="checkbox"/> No		
814	<input type="checkbox"/> Yes, <input type="checkbox"/> No			864	<input type="checkbox"/> Yes, <input type="checkbox"/> No		
815	<input type="checkbox"/> Yes, <input type="checkbox"/> No			865	<input type="checkbox"/> Yes, <input type="checkbox"/> No		
816	<input type="checkbox"/> Yes, <input type="checkbox"/> No			866	<input type="checkbox"/> Yes, <input type="checkbox"/> No		
817	<input type="checkbox"/> Yes, <input type="checkbox"/> No			867	<input type="checkbox"/> Yes, <input type="checkbox"/> No		
818	<input type="checkbox"/> Yes, <input type="checkbox"/> No			868	<input type="checkbox"/> Yes, <input type="checkbox"/> No		
819	<input type="checkbox"/> Yes, <input type="checkbox"/> No			869	<input type="checkbox"/> Yes, <input type="checkbox"/> No		
820	<input type="checkbox"/> Yes, <input type="checkbox"/> No			870	<input type="checkbox"/> Yes, <input type="checkbox"/> No		
821	<input type="checkbox"/> Yes, <input type="checkbox"/> No			871	<input type="checkbox"/> Yes, <input type="checkbox"/> No		
822	<input type="checkbox"/> Yes, <input type="checkbox"/> No			872	<input type="checkbox"/> Yes, <input type="checkbox"/> No		
823	<input type="checkbox"/> Yes, <input type="checkbox"/> No			873	<input type="checkbox"/> Yes, <input type="checkbox"/> No		
824	<input type="checkbox"/> Yes, <input type="checkbox"/> No			874	<input type="checkbox"/> Yes, <input type="checkbox"/> No		
825	<input type="checkbox"/> Yes, <input type="checkbox"/> No			875	<input type="checkbox"/> Yes, <input type="checkbox"/> No		
826	<input type="checkbox"/> Yes, <input type="checkbox"/> No			876	<input type="checkbox"/> Yes, <input type="checkbox"/> No		
827	<input type="checkbox"/> Yes, <input type="checkbox"/> No			877	<input type="checkbox"/> Yes, <input type="checkbox"/> No		
828	<input type="checkbox"/> Yes, <input type="checkbox"/> No			878	<input type="checkbox"/> Yes, <input type="checkbox"/> No		
829	<input type="checkbox"/> Yes, <input type="checkbox"/> No			879	<input type="checkbox"/> Yes, <input type="checkbox"/> No		
830	<input type="checkbox"/> Yes, <input type="checkbox"/> No			880	<input type="checkbox"/> Yes, <input type="checkbox"/> No		
831	<input type="checkbox"/> Yes, <input type="checkbox"/> No			881	<input type="checkbox"/> Yes, <input type="checkbox"/> No		
832	<input type="checkbox"/> Yes, <input type="checkbox"/> No			882	<input type="checkbox"/> Yes, <input type="checkbox"/> No		
833	<input type="checkbox"/> Yes, <input type="checkbox"/> No			883	<input type="checkbox"/> Yes, <input type="checkbox"/> No		
834	<input type="checkbox"/> Yes, <input type="checkbox"/> No			884	<input type="checkbox"/> Yes, <input type="checkbox"/> No		
835	<input type="checkbox"/> Yes, <input type="checkbox"/> No			885	<input type="checkbox"/> Yes, <input type="checkbox"/> No		
836	<input type="checkbox"/> Yes, <input type="checkbox"/> No			886	<input type="checkbox"/> Yes, <input type="checkbox"/> No		
837	<input type="checkbox"/> Yes, <input type="checkbox"/> No			887	<input type="checkbox"/> Yes, <input type="checkbox"/> No		
838	<input type="checkbox"/> Yes, <input type="checkbox"/> No			888	<input type="checkbox"/> Yes, <input type="checkbox"/> No		
839	<input type="checkbox"/> Yes, <input type="checkbox"/> No			889	<input type="checkbox"/> Yes, <input type="checkbox"/> No		
840	<input type="checkbox"/> Yes, <input type="checkbox"/> No			890	<input type="checkbox"/> Yes, <input type="checkbox"/> No		
841	<input type="checkbox"/> Yes, <input type="checkbox"/> No			891	<input type="checkbox"/> Yes, <input type="checkbox"/> No		
842	<input type="checkbox"/> Yes, <input type="checkbox"/> No			892	<input type="checkbox"/> Yes, <input type="checkbox"/> No		
843	<input type="checkbox"/> Yes, <input type="checkbox"/> No			893	<input type="checkbox"/> Yes, <input type="checkbox"/> No		
844	<input type="checkbox"/> Yes, <input type="checkbox"/> No			894	<input type="checkbox"/> Yes, <input type="checkbox"/> No		
845	<input type="checkbox"/> Yes, <input type="checkbox"/> No			895	<input type="checkbox"/> Yes, <input type="checkbox"/> No		
846	<input type="checkbox"/> Yes, <input type="checkbox"/> No			896	<input type="checkbox"/> Yes, <input type="checkbox"/> No		
847	<input type="checkbox"/> Yes, <input type="checkbox"/> No			897	<input type="checkbox"/> Yes, <input type="checkbox"/> No		
848	<input type="checkbox"/> Yes, <input type="checkbox"/> No			898	<input type="checkbox"/> Yes, <input type="checkbox"/> No		
849	<input type="checkbox"/> Yes, <input type="checkbox"/> No			899	<input type="checkbox"/> Yes, <input type="checkbox"/> No		

TOLL RESTRICTION-AREA/OFFICE CODE TABLE (8/8)

Area Office Code Table No. 1

Code No.	Local Call Access	Restriction Level	Office Code	Code No.	Local Call Access	Restriction Level	Office Code
900	<input type="checkbox"/> Yes, <input type="checkbox"/> No			950	<input type="checkbox"/> Yes, <input type="checkbox"/> No		
301	<input type="checkbox"/> Yes, <input type="checkbox"/> No			951	<input type="checkbox"/> Yes, <input type="checkbox"/> No		
302	<input type="checkbox"/> Yes, <input type="checkbox"/> No			952	<input type="checkbox"/> Yes, <input type="checkbox"/> No		
903	<input type="checkbox"/> Yes, <input type="checkbox"/> No			953	<input type="checkbox"/> Yes, <input type="checkbox"/> No		
904	<input type="checkbox"/> Yes, <input type="checkbox"/> No			954	<input type="checkbox"/> Yes, <input type="checkbox"/> No		
905	<input type="checkbox"/> Yes, <input type="checkbox"/> No			955	<input type="checkbox"/> Yes, <input type="checkbox"/> No		
906	<input type="checkbox"/> Yes, <input type="checkbox"/> No			956	<input type="checkbox"/> Yes, <input type="checkbox"/> No		
907	<input type="checkbox"/> Yes, <input type="checkbox"/> No			957	<input type="checkbox"/> Yes, <input type="checkbox"/> No		
908	<input type="checkbox"/> Yes, <input type="checkbox"/> No			958	<input type="checkbox"/> Yes, <input type="checkbox"/> No		
909	<input type="checkbox"/> Yes, <input type="checkbox"/> No			959	<input type="checkbox"/> Yes, <input type="checkbox"/> No		
910	<input type="checkbox"/> Yes, <input type="checkbox"/> No			960	<input type="checkbox"/> Yes, <input type="checkbox"/> No		
911	<input type="checkbox"/> Yes, <input type="checkbox"/> No			961	<input type="checkbox"/> Yes, <input type="checkbox"/> No		
912	<input type="checkbox"/> Yes, <input type="checkbox"/> No			962	<input type="checkbox"/> Yes, <input type="checkbox"/> No		
913	<input type="checkbox"/> Yes, <input type="checkbox"/> No			963	<input type="checkbox"/> Yes, <input type="checkbox"/> No		
914	<input type="checkbox"/> Yes, <input type="checkbox"/> No			964	<input type="checkbox"/> Yes, <input type="checkbox"/> No		
915	<input type="checkbox"/> Yes, <input type="checkbox"/> No			965	<input type="checkbox"/> Yes, <input type="checkbox"/> No		
916	<input type="checkbox"/> Yes, <input type="checkbox"/> No			966	<input type="checkbox"/> Yes, <input type="checkbox"/> No		
917	<input type="checkbox"/> Yes, <input type="checkbox"/> No			967	<input type="checkbox"/> Yes, <input type="checkbox"/> No		
918	<input type="checkbox"/> Yes, <input type="checkbox"/> No			968	<input type="checkbox"/> Yes, <input type="checkbox"/> No		
919	<input type="checkbox"/> Yes, <input type="checkbox"/> No			969	<input type="checkbox"/> Yes, <input type="checkbox"/> No		
920	<input type="checkbox"/> Yes, <input type="checkbox"/> No			970	<input type="checkbox"/> Yes, <input type="checkbox"/> No		
921	<input type="checkbox"/> Yes, <input type="checkbox"/> No			971	<input type="checkbox"/> Yes, <input type="checkbox"/> No		
922	<input type="checkbox"/> Yes, <input type="checkbox"/> No			972	<input type="checkbox"/> Yes, <input type="checkbox"/> No		
923	<input type="checkbox"/> Yes, <input type="checkbox"/> No			973	<input type="checkbox"/> Yes, <input type="checkbox"/> No		
924	<input type="checkbox"/> Yes, <input type="checkbox"/> No			974	<input type="checkbox"/> Yes, <input type="checkbox"/> No		
925	<input type="checkbox"/> Yes, <input type="checkbox"/> No			975	<input type="checkbox"/> Yes, <input type="checkbox"/> No		
926	<input type="checkbox"/> Yes, <input type="checkbox"/> No			976	<input type="checkbox"/> Yes, <input type="checkbox"/> No		
927	<input type="checkbox"/> Yes, <input type="checkbox"/> No			977	<input type="checkbox"/> Yes, <input type="checkbox"/> No		
928	<input type="checkbox"/> Yes, <input type="checkbox"/> No			978	<input type="checkbox"/> Yes, <input type="checkbox"/> No		
929	<input type="checkbox"/> Yes, <input type="checkbox"/> No			979	<input type="checkbox"/> Yes, <input type="checkbox"/> No		
930	<input type="checkbox"/> Yes, <input type="checkbox"/> No			980	<input type="checkbox"/> Yes, <input type="checkbox"/> No		
931	<input type="checkbox"/> Yes, <input type="checkbox"/> No			981	<input type="checkbox"/> Yes, <input type="checkbox"/> No		
932	<input type="checkbox"/> Yes, <input type="checkbox"/> No			982	<input type="checkbox"/> Yes, <input type="checkbox"/> No		
933	<input type="checkbox"/> Yes, <input type="checkbox"/> No			983	<input type="checkbox"/> Yes, <input type="checkbox"/> No		
934	<input type="checkbox"/> Yes, <input type="checkbox"/> No			984	<input type="checkbox"/> Yes, <input type="checkbox"/> No		
935	<input type="checkbox"/> Yes, <input type="checkbox"/> No			985	<input type="checkbox"/> Yes, <input type="checkbox"/> No		
936	<input type="checkbox"/> Yes, <input type="checkbox"/> No			986	<input type="checkbox"/> Yes, <input type="checkbox"/> No		
937	<input type="checkbox"/> Yes, <input type="checkbox"/> No			987	<input type="checkbox"/> Yes, <input type="checkbox"/> No		
938	<input type="checkbox"/> Yes, <input type="checkbox"/> No			988	<input type="checkbox"/> Yes, <input type="checkbox"/> No		
939	<input type="checkbox"/> Yes, <input type="checkbox"/> No			989	<input type="checkbox"/> Yes, <input type="checkbox"/> No		
940	<input type="checkbox"/> Yes, <input type="checkbox"/> No			990	<input type="checkbox"/> Yes, <input type="checkbox"/> No		
941	<input type="checkbox"/> Yes, <input type="checkbox"/> No			991	<input type="checkbox"/> Yes, <input type="checkbox"/> No		
942	<input type="checkbox"/> Yes, <input type="checkbox"/> No			992	<input type="checkbox"/> Yes, <input type="checkbox"/> No		
943	<input type="checkbox"/> Yes, <input type="checkbox"/> No			993	<input type="checkbox"/> Yes, <input type="checkbox"/> No		
944	<input type="checkbox"/> Yes, <input type="checkbox"/> No			994	<input type="checkbox"/> Yes, <input type="checkbox"/> No		
945	<input type="checkbox"/> Yes, <input type="checkbox"/> No			995	<input type="checkbox"/> Yes, <input type="checkbox"/> No		
946	<input type="checkbox"/> Yes, <input type="checkbox"/> No			996	<input type="checkbox"/> Yes, <input type="checkbox"/> No		
947	<input type="checkbox"/> Yes, <input type="checkbox"/> No			997	<input type="checkbox"/> Yes, <input type="checkbox"/> No		
948	<input type="checkbox"/> Yes, <input type="checkbox"/> No			998	<input type="checkbox"/> Yes, <input type="checkbox"/> No		
949	<input type="checkbox"/> Yes, <input type="checkbox"/> No			999	<input type="checkbox"/> Yes, <input type="checkbox"/> No		

TOLL RESTRICTION-AREA/OFFICE CODE TABLE (1/8)

Area Office Code Table No. 2

Code No.	Local Call Access	Restriction Level	Office Code	Code No.	Local Call Access	Restriction Level	Office Code
200	<input type="checkbox"/> Yes, <input type="checkbox"/> No			25c	<input type="checkbox"/> Yes, <input type="checkbox"/> No		
201	<input type="checkbox"/> Yes, <input type="checkbox"/> No			251	<input type="checkbox"/> Yes, <input type="checkbox"/> No		
202	<input type="checkbox"/> Yes, <input type="checkbox"/> No			252	<input type="checkbox"/> Yes, <input type="checkbox"/> No		
203	<input type="checkbox"/> Yes, <input type="checkbox"/> No			253	<input type="checkbox"/> Yes, <input type="checkbox"/> No		
204	<input type="checkbox"/> Yes, <input type="checkbox"/> No			254	<input type="checkbox"/> Yes, <input type="checkbox"/> No		
205	<input type="checkbox"/> Yes, <input type="checkbox"/> No			255	<input type="checkbox"/> Yes, <input type="checkbox"/> No		
206	<input type="checkbox"/> Yes, <input type="checkbox"/> No			256	<input type="checkbox"/> Yes, <input type="checkbox"/> No		
207	<input type="checkbox"/> Yes, <input type="checkbox"/> No			257	<input type="checkbox"/> Yes, <input type="checkbox"/> No		
208	<input type="checkbox"/> Yes, <input type="checkbox"/> No			258	<input type="checkbox"/> Yes, <input type="checkbox"/> No		
209	<input type="checkbox"/> Yes, <input type="checkbox"/> No			260	<input type="checkbox"/> Yes, <input type="checkbox"/> No		
210	<input type="checkbox"/> Yes, <input type="checkbox"/> No			261	<input type="checkbox"/> Yes, <input type="checkbox"/> No		
211	<input type="checkbox"/> Yes, <input type="checkbox"/> No			262	<input type="checkbox"/> Yes, <input type="checkbox"/> No		
212	<input type="checkbox"/> Yes, <input type="checkbox"/> No			263	<input type="checkbox"/> Yes, <input type="checkbox"/> No		
213	<input type="checkbox"/> Yes, <input type="checkbox"/> No						
215	<input type="checkbox"/> Yes, <input type="checkbox"/> No			265	<input type="checkbox"/> Yes, <input type="checkbox"/> No		
216	<input type="checkbox"/> Yes, <input type="checkbox"/> No			266	<input type="checkbox"/> Yes, <input type="checkbox"/> No		
217	<input type="checkbox"/> Yes, <input type="checkbox"/> No			267	<input type="checkbox"/> Yes, <input type="checkbox"/> No		
218	<input type="checkbox"/> Yes, <input type="checkbox"/> No			268	<input type="checkbox"/> Yes, <input type="checkbox"/> No		
219	<input type="checkbox"/> Yes, <input type="checkbox"/> No			269	<input type="checkbox"/> Yes, <input type="checkbox"/> No		
220	<input type="checkbox"/> Yes, <input type="checkbox"/> No			270	<input type="checkbox"/> Yes, <input type="checkbox"/> No		
221	<input type="checkbox"/> Yes, <input type="checkbox"/> No			271	<input type="checkbox"/> Yes, <input type="checkbox"/> No		
222	<input type="checkbox"/> Yes, <input type="checkbox"/> No			272	<input type="checkbox"/> Yes, <input type="checkbox"/> No		
223	<input type="checkbox"/> Yes, <input type="checkbox"/> No			273	<input type="checkbox"/> Yes, <input type="checkbox"/> No		
224	<input type="checkbox"/> Yes, <input type="checkbox"/> No			274	<input type="checkbox"/> Yes, <input type="checkbox"/> No		
225	<input type="checkbox"/> Yes, <input type="checkbox"/> No			275	<input type="checkbox"/> Yes, <input type="checkbox"/> No		
226	<input type="checkbox"/> Yes, <input type="checkbox"/> No			276	<input type="checkbox"/> Yes, <input type="checkbox"/> No		
227	<input type="checkbox"/> Yes, <input type="checkbox"/> No			277	<input type="checkbox"/> Yes, <input type="checkbox"/> No		
228	<input type="checkbox"/> Yes, <input type="checkbox"/> No			278	<input type="checkbox"/> Yes, <input type="checkbox"/> No		
229	<input type="checkbox"/> Yes, <input type="checkbox"/> No			279	<input type="checkbox"/> Yes, <input type="checkbox"/> No		
230	<input type="checkbox"/> Yes, <input type="checkbox"/> No			280	<input type="checkbox"/> Yes, <input type="checkbox"/> No		
231	<input type="checkbox"/> Yes, <input type="checkbox"/> No			281	<input type="checkbox"/> Yes, <input type="checkbox"/> No		
232	<input type="checkbox"/> Yes, <input type="checkbox"/> No			282	<input type="checkbox"/> Yes, <input type="checkbox"/> No		
233	<input type="checkbox"/> Yes, <input type="checkbox"/> No			283	<input type="checkbox"/> Yes, <input type="checkbox"/> No		
234	<input type="checkbox"/> Yes, <input type="checkbox"/> No			284	<input type="checkbox"/> Yes, <input type="checkbox"/> No		
235	<input type="checkbox"/> Yes, <input type="checkbox"/> No			285	<input type="checkbox"/> Yes, <input type="checkbox"/> No		
236	<input type="checkbox"/> Yes, <input type="checkbox"/> No			286	<input type="checkbox"/> Yes, <input type="checkbox"/> No		
237	<input type="checkbox"/> Yes, <input type="checkbox"/> No			287	<input type="checkbox"/> Yes, <input type="checkbox"/> No		
238	<input type="checkbox"/> Yes, <input type="checkbox"/> No			288	<input type="checkbox"/> Yes, <input type="checkbox"/> No		
239	<input type="checkbox"/> Yes, <input type="checkbox"/> No			289	<input type="checkbox"/> Yes, <input type="checkbox"/> No		
240	<input type="checkbox"/> Yes, <input type="checkbox"/> No			290	<input type="checkbox"/> Yes, <input type="checkbox"/> No		
241	<input type="checkbox"/> Yes, <input type="checkbox"/> No			291	<input type="checkbox"/> Yes, <input type="checkbox"/> No		
242	<input type="checkbox"/> Yes, <input type="checkbox"/> No			292	<input type="checkbox"/> Yes, <input type="checkbox"/> No		
243	<input type="checkbox"/> Yes, <input type="checkbox"/> No			293	<input type="checkbox"/> Yes, <input type="checkbox"/> No		
244	<input type="checkbox"/> Yes, <input type="checkbox"/> No			294	<input type="checkbox"/> Yes, <input type="checkbox"/> No		
245	<input type="checkbox"/> Yes, <input type="checkbox"/> No			295	<input type="checkbox"/> Yes, <input type="checkbox"/> No		
246	<input type="checkbox"/> Yes, <input type="checkbox"/> No			296	<input type="checkbox"/> Yes, <input type="checkbox"/> No		
247	<input type="checkbox"/> Yes, <input type="checkbox"/> No			297	<input type="checkbox"/> Yes, <input type="checkbox"/> No		
248	<input type="checkbox"/> Yes, <input type="checkbox"/> No			298	<input type="checkbox"/> Yes, <input type="checkbox"/> No		
249	<input type="checkbox"/> Yes, <input type="checkbox"/> No			299	<input type="checkbox"/> Yes, <input type="checkbox"/> No		

TOLL RESTRICTION-AREA/OFFICE CODE TABLE (2/8)

Area/Office Code Table No. 2

Code No.	Local Call Access	Restriction Level	Office Code	Code No.	Local Call Access	Restriction Level	Office Code
300	<input type="checkbox"/> Yes, <input type="checkbox"/> No			350	<input type="checkbox"/> Yes, <input type="checkbox"/> No		
301	<input type="checkbox"/> Yes, <input type="checkbox"/> No			351	<input type="checkbox"/> Yes, <input type="checkbox"/> No		
302	<input type="checkbox"/> Yes, <input type="checkbox"/> No			352	<input type="checkbox"/> Yes, <input type="checkbox"/> No		
303	<input type="checkbox"/> Yes, <input type="checkbox"/> No			353	<input type="checkbox"/> Yes, <input type="checkbox"/> No		
304	<input type="checkbox"/> Yes, <input type="checkbox"/> No			354	<input type="checkbox"/> Yes, <input type="checkbox"/> No		
305	<input type="checkbox"/> Yes, <input type="checkbox"/> No			355	<input type="checkbox"/> Yes, <input type="checkbox"/> No		
306	<input type="checkbox"/> Yes, <input type="checkbox"/> No			356	<input type="checkbox"/> Yes, <input type="checkbox"/> No		
307	<input type="checkbox"/> Yes, <input type="checkbox"/> No			357	<input type="checkbox"/> Yes, <input type="checkbox"/> No		
308	<input type="checkbox"/> Yes, <input type="checkbox"/> No			358	<input type="checkbox"/> Yes, <input type="checkbox"/> No		
309	<input type="checkbox"/> Yes, <input type="checkbox"/> No			359	<input type="checkbox"/> Yes, <input type="checkbox"/> No		
310	<input type="checkbox"/> Yes, <input type="checkbox"/> No			360	<input type="checkbox"/> Yes, <input type="checkbox"/> No		
311	<input type="checkbox"/> Yes, <input type="checkbox"/> No			361	<input type="checkbox"/> Yes, <input type="checkbox"/> No		
312	<input type="checkbox"/> Yes, <input type="checkbox"/> No			362	<input type="checkbox"/> Yes, <input type="checkbox"/> No		
313	<input type="checkbox"/> Yes, <input type="checkbox"/> No			363	<input type="checkbox"/> Yes, <input type="checkbox"/> No		
314	<input type="checkbox"/> Yes, <input type="checkbox"/> No			364	<input type="checkbox"/> Yes, <input type="checkbox"/> No		
315	<input type="checkbox"/> Yes, <input type="checkbox"/> No			365	<input type="checkbox"/> Yes, <input type="checkbox"/> No		
316	<input type="checkbox"/> Yes, <input type="checkbox"/> No			366	<input type="checkbox"/> Yes, <input type="checkbox"/> No		
317	<input type="checkbox"/> Yes, <input type="checkbox"/> No			367	<input type="checkbox"/> Yes, <input type="checkbox"/> No		
318	<input type="checkbox"/> Yes, <input type="checkbox"/> No			368	<input type="checkbox"/> Yes, <input type="checkbox"/> No		
319	<input type="checkbox"/> Yes, <input type="checkbox"/> No			369	<input type="checkbox"/> Yes, <input type="checkbox"/> No		
320	<input type="checkbox"/> Yes, <input type="checkbox"/> No			370	<input type="checkbox"/> Yes, <input type="checkbox"/> No		
321	<input type="checkbox"/> Yes, <input type="checkbox"/> No			371	<input type="checkbox"/> Yes, <input type="checkbox"/> No		
322	<input type="checkbox"/> Yes, <input type="checkbox"/> No			372	<input type="checkbox"/> Yes, <input type="checkbox"/> No		
323	<input type="checkbox"/> Yes, <input type="checkbox"/> No			373	<input type="checkbox"/> Yes, <input type="checkbox"/> No		
324	<input type="checkbox"/> Yes, <input type="checkbox"/> No			374	<input type="checkbox"/> Yes, <input type="checkbox"/> No		
325	<input type="checkbox"/> Yes, <input type="checkbox"/> No			375	<input type="checkbox"/> Yes, <input type="checkbox"/> No		
326	<input type="checkbox"/> Yes, <input type="checkbox"/> No			376	<input type="checkbox"/> Yes, <input type="checkbox"/> No		
327	<input type="checkbox"/> Yes, <input type="checkbox"/> No			377	<input type="checkbox"/> Yes, <input type="checkbox"/> No		
328	<input type="checkbox"/> Yes, <input type="checkbox"/> No			378	<input type="checkbox"/> Yes, <input type="checkbox"/> No		
329	<input type="checkbox"/> Yes, <input type="checkbox"/> No			379	<input type="checkbox"/> Yes, <input type="checkbox"/> No		
330	<input type="checkbox"/> Yes, <input type="checkbox"/> No			380	<input type="checkbox"/> Yes, <input type="checkbox"/> No		
331	<input type="checkbox"/> Yes, <input type="checkbox"/> No			381	<input type="checkbox"/> Yes, <input type="checkbox"/> No		
332	<input type="checkbox"/> Yes, <input type="checkbox"/> No			382	<input type="checkbox"/> Yes, <input type="checkbox"/> No		
333	<input type="checkbox"/> Yes, <input type="checkbox"/> No			383	<input type="checkbox"/> Yes, <input type="checkbox"/> No		
334	<input type="checkbox"/> Yes, <input type="checkbox"/> No			384	<input type="checkbox"/> Yes, <input type="checkbox"/> No		
335	<input type="checkbox"/> Yes, <input type="checkbox"/> No			385	<input type="checkbox"/> Yes, <input type="checkbox"/> No		
336	<input type="checkbox"/> Yes, <input type="checkbox"/> No			386	<input type="checkbox"/> Yes, <input type="checkbox"/> No		
337	<input type="checkbox"/> Yes, <input type="checkbox"/> No			387	<input type="checkbox"/> Yes, <input type="checkbox"/> No		
338	<input type="checkbox"/> Yes, <input type="checkbox"/> No			388	<input type="checkbox"/> Yes, <input type="checkbox"/> No		
339	<input type="checkbox"/> Yes, <input type="checkbox"/> No			389	<input type="checkbox"/> Yes, <input type="checkbox"/> No		
340	<input type="checkbox"/> Yes, <input type="checkbox"/> No			390	<input type="checkbox"/> Yes, <input type="checkbox"/> No		
341	<input type="checkbox"/> Yes, <input type="checkbox"/> No			391	<input type="checkbox"/> Yes, <input type="checkbox"/> No		
342	<input type="checkbox"/> Yes, <input type="checkbox"/> No			392	<input type="checkbox"/> Yes, <input type="checkbox"/> No		
343	<input type="checkbox"/> Yes, <input type="checkbox"/> No			393	<input type="checkbox"/> Yes, <input type="checkbox"/> No		
344	<input type="checkbox"/> Yes, <input type="checkbox"/> No			394	<input type="checkbox"/> Yes, <input type="checkbox"/> No		
345	<input type="checkbox"/> Yes, <input type="checkbox"/> No			395	<input type="checkbox"/> Yes, <input type="checkbox"/> No		
346	<input type="checkbox"/> Yes, <input type="checkbox"/> No			396	<input type="checkbox"/> Yes, <input type="checkbox"/> No		
347	<input type="checkbox"/> Yes, <input type="checkbox"/> No			397	<input type="checkbox"/> Yes, <input type="checkbox"/> No		
348	<input type="checkbox"/> Yes, <input type="checkbox"/> No			398	<input type="checkbox"/> Yes, <input type="checkbox"/> No		
349	<input type="checkbox"/> Yes, <input type="checkbox"/> No			399	<input type="checkbox"/> Yes, <input type="checkbox"/> No		

TOLL RESTRICTION-AREA/OFFICE CODE TABLE (3/8)

Area/Office Code Table No. 2

Code No.	Local Call Access	Restriction Level	Office Code	Code No.	Local Call Access	Restriction Level	Office Code
400	<input type="checkbox"/> Yes, <input type="checkbox"/> No			450	<input type="checkbox"/> Yes, <input type="checkbox"/> No		
401	<input type="checkbox"/> Yes, <input type="checkbox"/> No			451	<input type="checkbox"/> Yes, <input type="checkbox"/> No		
402	<input type="checkbox"/> Yes, <input type="checkbox"/> No			452	<input type="checkbox"/> Yes, <input type="checkbox"/> No		
403	<input type="checkbox"/> Yes, <input type="checkbox"/> No			453	<input type="checkbox"/> Yes, <input type="checkbox"/> No		
404	<input type="checkbox"/> Yes, <input type="checkbox"/> No			454	<input type="checkbox"/> Yes, <input type="checkbox"/> No		
405	<input type="checkbox"/> Yes, <input type="checkbox"/> No			455	<input type="checkbox"/> Yes, <input type="checkbox"/> No		
406	<input type="checkbox"/> Yes, <input type="checkbox"/> No			456	<input type="checkbox"/> Yes, <input type="checkbox"/> No		
407	<input type="checkbox"/> Yes, <input type="checkbox"/> No			457	<input type="checkbox"/> Yes, <input type="checkbox"/> No		
408	<input type="checkbox"/> Yes, <input type="checkbox"/> No			458	<input type="checkbox"/> Yes, <input type="checkbox"/> No		
409	<input type="checkbox"/> Yes, <input type="checkbox"/> No			459	<input type="checkbox"/> Yes, <input type="checkbox"/> No		
410	<input type="checkbox"/> Yes, <input type="checkbox"/> No			460	<input type="checkbox"/> Yes, <input type="checkbox"/> No		
411	<input type="checkbox"/> Yes, <input type="checkbox"/> No			461	<input type="checkbox"/> Yes, <input type="checkbox"/> No		
412	<input type="checkbox"/> Yes, <input type="checkbox"/> No			462	<input type="checkbox"/> Yes, <input type="checkbox"/> No		
413	<input type="checkbox"/> Yes, <input type="checkbox"/> No			463	<input type="checkbox"/> Yes, <input type="checkbox"/> No		
414	<input type="checkbox"/> Yes, <input type="checkbox"/> No			464	<input type="checkbox"/> Yes, <input type="checkbox"/> No		
415	<input type="checkbox"/> Yes, <input type="checkbox"/> No			465	<input type="checkbox"/> Yes, <input type="checkbox"/> No		
416	<input type="checkbox"/> Yes, <input type="checkbox"/> No			466	<input type="checkbox"/> Yes, <input type="checkbox"/> No		
417	<input type="checkbox"/> Yes, <input type="checkbox"/> No			467	<input type="checkbox"/> Yes, <input type="checkbox"/> No		
418	<input type="checkbox"/> Yes, <input type="checkbox"/> No			468	<input type="checkbox"/> Yes, <input type="checkbox"/> No		
419	<input type="checkbox"/> Yes, <input type="checkbox"/> No			469	<input type="checkbox"/> Yes, <input type="checkbox"/> No		
420	<input type="checkbox"/> Yes, <input type="checkbox"/> No			470	<input type="checkbox"/> Yes, <input type="checkbox"/> No		
421	<input type="checkbox"/> Yes, <input type="checkbox"/> No			471	<input type="checkbox"/> Yes, <input type="checkbox"/> No		
422	<input type="checkbox"/> Yes, <input type="checkbox"/> No			472	<input type="checkbox"/> Yes, <input type="checkbox"/> No		
423	<input type="checkbox"/> Yes, <input type="checkbox"/> No			473	<input type="checkbox"/> Yes, <input type="checkbox"/> No		
424	<input type="checkbox"/> Yes, <input type="checkbox"/> No			474	<input type="checkbox"/> Yes, <input type="checkbox"/> No		
425	<input type="checkbox"/> Yes, <input type="checkbox"/> No			475	<input type="checkbox"/> Yes, <input type="checkbox"/> No		
426	<input type="checkbox"/> Yes, <input type="checkbox"/> No			476	<input type="checkbox"/> Yes, <input type="checkbox"/> No		
427	<input type="checkbox"/> Yes, <input type="checkbox"/> No			477	<input type="checkbox"/> Yes, <input type="checkbox"/> No		
428	<input type="checkbox"/> Yes, <input type="checkbox"/> No			478	<input type="checkbox"/> Yes, <input type="checkbox"/> No		
429	<input type="checkbox"/> Yes, <input type="checkbox"/> No			479	<input type="checkbox"/> Yes, <input type="checkbox"/> No		
430	<input type="checkbox"/> Yes, <input type="checkbox"/> No			480	<input type="checkbox"/> Yes, <input type="checkbox"/> No		
431	<input type="checkbox"/> Yes, <input type="checkbox"/> No			481	<input type="checkbox"/> Yes, <input type="checkbox"/> No		
432	<input type="checkbox"/> Yes, <input type="checkbox"/> No			482	<input type="checkbox"/> Yes, <input type="checkbox"/> No		
433	<input type="checkbox"/> Yes, <input type="checkbox"/> No			483	<input type="checkbox"/> Yes, <input type="checkbox"/> No		
434	<input type="checkbox"/> Yes, <input type="checkbox"/> No			484	<input type="checkbox"/> Yes, <input type="checkbox"/> No		
435	<input type="checkbox"/> Yes, <input type="checkbox"/> No			485	<input type="checkbox"/> Yes, <input type="checkbox"/> No		
436	<input type="checkbox"/> Yes, <input type="checkbox"/> No			486	<input type="checkbox"/> Yes, <input type="checkbox"/> No		
437	<input type="checkbox"/> Yes, <input type="checkbox"/> No			487	<input type="checkbox"/> Yes, <input type="checkbox"/> No		
438	<input type="checkbox"/> Yes, <input type="checkbox"/> No			488	<input type="checkbox"/> Yes, <input type="checkbox"/> No		
439	<input type="checkbox"/> Yes, <input type="checkbox"/> No			489	<input type="checkbox"/> Yes, <input type="checkbox"/> No		
440	<input type="checkbox"/> Yes, <input type="checkbox"/> No			490	<input type="checkbox"/> Yes, <input type="checkbox"/> No		
441	<input type="checkbox"/> Yes, <input type="checkbox"/> No			491	<input type="checkbox"/> Yes, <input type="checkbox"/> No		
442	<input type="checkbox"/> Yes, <input type="checkbox"/> No			492	<input type="checkbox"/> Yes, <input type="checkbox"/> No		
443	<input type="checkbox"/> Yes, <input type="checkbox"/> No			493	<input type="checkbox"/> Yes, <input type="checkbox"/> No		
444	<input type="checkbox"/> Yes, <input type="checkbox"/> No			494	<input type="checkbox"/> Yes, <input type="checkbox"/> No		
445	<input type="checkbox"/> Yes, <input type="checkbox"/> No			495	<input type="checkbox"/> Yes, <input type="checkbox"/> No		
446	<input type="checkbox"/> Yes, <input type="checkbox"/> No			496	<input type="checkbox"/> Yes, <input type="checkbox"/> No		
447	<input type="checkbox"/> Yes, <input type="checkbox"/> No			497	<input type="checkbox"/> Yes, <input type="checkbox"/> No		
448	<input type="checkbox"/> Yes, <input type="checkbox"/> No			498	<input type="checkbox"/> Yes, <input type="checkbox"/> No		
449	<input type="checkbox"/> Yes, <input type="checkbox"/> No			499	<input type="checkbox"/> Yes, <input type="checkbox"/> No		

TOLL RESTRICTION-AREA/OFFICE CODE TABLE (4/8)

Area Office Code Table No. 2

Code No.	Local Call Access	Restriction Level	Office Code	Code No.	Local Call Access	Restriction Level	Office Code
500	<input type="checkbox"/> Yes, <input type="checkbox"/> No			550	<input type="checkbox"/> Yes, <input type="checkbox"/> No		
501	<input type="checkbox"/> Yes, <input type="checkbox"/> No			551	<input type="checkbox"/> Yes, <input type="checkbox"/> No		
502	<input type="checkbox"/> Yes, <input type="checkbox"/> No			552	<input type="checkbox"/> Yes, <input type="checkbox"/> No		
503	<input type="checkbox"/> Yes, <input type="checkbox"/> No			553	<input type="checkbox"/> Yes, <input type="checkbox"/> No		
504	<input type="checkbox"/> Yes, <input type="checkbox"/> No			554	<input type="checkbox"/> Yes, <input type="checkbox"/> No		
505	<input type="checkbox"/> Yes, <input type="checkbox"/> No			555	<input type="checkbox"/> Yes, <input type="checkbox"/> No		
506	<input type="checkbox"/> Yes, <input type="checkbox"/> No			556	<input type="checkbox"/> Yes, <input type="checkbox"/> No		
507	<input type="checkbox"/> Yes, <input type="checkbox"/> No			557	<input type="checkbox"/> Yes, <input type="checkbox"/> No		
508	<input type="checkbox"/> Yes, <input type="checkbox"/> No			558	<input type="checkbox"/> Yes, <input type="checkbox"/> No		
509	<input type="checkbox"/> Yes, <input type="checkbox"/> No			559	<input type="checkbox"/> Yes, <input type="checkbox"/> No		
510	<input type="checkbox"/> Yes, <input type="checkbox"/> No			560	<input type="checkbox"/> Yes, <input type="checkbox"/> No		
511	<input type="checkbox"/> Yes, <input type="checkbox"/> No			561	<input type="checkbox"/> Yes, <input type="checkbox"/> No		
512	<input type="checkbox"/> Yes, <input type="checkbox"/> No			562	<input type="checkbox"/> Yes, <input type="checkbox"/> No		
513	<input type="checkbox"/> Yes, <input type="checkbox"/> No			563	<input type="checkbox"/> Yes, <input type="checkbox"/> No		
514	<input type="checkbox"/> Yes, <input type="checkbox"/> No			564	<input type="checkbox"/> Yes, <input type="checkbox"/> No		
515	<input type="checkbox"/> Yes, <input type="checkbox"/> No			565	<input type="checkbox"/> Yes, <input type="checkbox"/> No		
516	<input type="checkbox"/> Yes, <input type="checkbox"/> No			566	<input type="checkbox"/> Yes, <input type="checkbox"/> No		
517	<input type="checkbox"/> Yes, <input type="checkbox"/> No			567	<input type="checkbox"/> Yes, <input type="checkbox"/> No		
518	<input type="checkbox"/> Yes, <input type="checkbox"/> No			568	<input type="checkbox"/> Yes, <input type="checkbox"/> No		
519	<input type="checkbox"/> Yes, <input type="checkbox"/> No			569	<input type="checkbox"/> Yes, <input type="checkbox"/> No		
520	<input type="checkbox"/> Yes, <input type="checkbox"/> No			570	<input type="checkbox"/> Yes, <input type="checkbox"/> No		
521	<input type="checkbox"/> Yes, <input type="checkbox"/> No			571	<input type="checkbox"/> Yes, <input type="checkbox"/> No		
522	<input type="checkbox"/> Yes, <input type="checkbox"/> No			572	<input type="checkbox"/> Yes, <input type="checkbox"/> No		
523	<input type="checkbox"/> Yes, <input type="checkbox"/> No			573	<input type="checkbox"/> Yes, <input type="checkbox"/> No		
524	<input type="checkbox"/> Yes, <input type="checkbox"/> No			574	<input type="checkbox"/> Yes, <input type="checkbox"/> No		
525	<input type="checkbox"/> Yes, <input type="checkbox"/> No			575	<input type="checkbox"/> Yes, <input type="checkbox"/> No		
526	<input type="checkbox"/> Yes, <input type="checkbox"/> No			576	<input type="checkbox"/> Yes, <input type="checkbox"/> No		
527	<input type="checkbox"/> Yes, <input type="checkbox"/> No			577	<input type="checkbox"/> Yes, <input type="checkbox"/> No		
528	<input type="checkbox"/> Yes, <input type="checkbox"/> No			578	<input type="checkbox"/> Yes, <input type="checkbox"/> No		
529	<input type="checkbox"/> Yes, <input type="checkbox"/> No			579	<input type="checkbox"/> Yes, <input type="checkbox"/> No		
530	<input type="checkbox"/> Yes, <input type="checkbox"/> No			580	<input type="checkbox"/> Yes, <input type="checkbox"/> No		
531	<input type="checkbox"/> Yes, <input type="checkbox"/> No			581	<input type="checkbox"/> Yes, <input type="checkbox"/> No		
532	<input type="checkbox"/> Yes, <input type="checkbox"/> No			582	<input type="checkbox"/> Yes, <input type="checkbox"/> No		
533	<input type="checkbox"/> Yes, <input type="checkbox"/> No			583	<input type="checkbox"/> Yes, <input type="checkbox"/> No		
534	<input type="checkbox"/> Yes, <input type="checkbox"/> No			584	<input type="checkbox"/> Yes, <input type="checkbox"/> No		
535	<input type="checkbox"/> Yes, <input type="checkbox"/> No			585	<input type="checkbox"/> Yes, <input type="checkbox"/> No		
536	<input type="checkbox"/> Yes, <input type="checkbox"/> No			586	<input type="checkbox"/> Yes, <input type="checkbox"/> No		
537	<input type="checkbox"/> Yes, <input type="checkbox"/> No			587	<input type="checkbox"/> Yes, <input type="checkbox"/> No		
538	<input type="checkbox"/> Yes, <input type="checkbox"/> No			588	<input type="checkbox"/> Yes, <input type="checkbox"/> No		
539	<input type="checkbox"/> Yes, <input type="checkbox"/> No			589	<input type="checkbox"/> Yes, <input type="checkbox"/> No		
540	<input type="checkbox"/> Yes, <input type="checkbox"/> No			590	<input type="checkbox"/> Yes, <input type="checkbox"/> No		
541	<input type="checkbox"/> Yes, <input type="checkbox"/> No			591	<input type="checkbox"/> Yes, <input type="checkbox"/> No		
542	<input type="checkbox"/> Yes, <input type="checkbox"/> No			592	<input type="checkbox"/> Yes, <input type="checkbox"/> No		
543	<input type="checkbox"/> Yes, <input type="checkbox"/> No			593	<input type="checkbox"/> Yes, <input type="checkbox"/> No		
544	<input type="checkbox"/> Yes, <input type="checkbox"/> No			594	<input type="checkbox"/> Yes, <input type="checkbox"/> No		
545	<input type="checkbox"/> Yes, <input type="checkbox"/> No			595	<input type="checkbox"/> Yes, <input type="checkbox"/> No		
546	<input type="checkbox"/> Yes, <input type="checkbox"/> No			596	<input type="checkbox"/> Yes, <input type="checkbox"/> No		
547	<input type="checkbox"/> Yes, <input type="checkbox"/> No			597	<input type="checkbox"/> Yes, <input type="checkbox"/> No		
548	<input type="checkbox"/> Yes, <input type="checkbox"/> No			598	<input type="checkbox"/> Yes, <input type="checkbox"/> No		
549	<input type="checkbox"/> Yes, <input type="checkbox"/> No			599	<input type="checkbox"/> Yes, <input type="checkbox"/> No		

TOLL RESTRICTION—AREA/OFFICE CODE TABLE (5/8)

Area/Office Code Table No. 2

Code No.	Local Call Access	Restriction Level	Office Code	Code No.	Local Call Access	Restriction Level	Office Code
600	<input type="checkbox"/> Yes <input type="checkbox"/> No			650	<input type="checkbox"/> Yes, <input type="checkbox"/> No		
601	<input type="checkbox"/> Yes <input type="checkbox"/> No			651	<input type="checkbox"/> Yes, <input type="checkbox"/> No		
602	<input type="checkbox"/> Yes <input type="checkbox"/> No			652	<input type="checkbox"/> Yes, <input type="checkbox"/> No		
603	<input type="checkbox"/> Yes <input type="checkbox"/> No			653	<input type="checkbox"/> Yes, <input type="checkbox"/> No		
604	<input type="checkbox"/> Yes <input type="checkbox"/> No			654	<input type="checkbox"/> Yes, <input type="checkbox"/> No		
605	<input type="checkbox"/> Yes <input type="checkbox"/> No			655	<input type="checkbox"/> Yes, <input type="checkbox"/> No		
606	<input type="checkbox"/> Yes <input type="checkbox"/> No			656	<input type="checkbox"/> Yes, <input type="checkbox"/> No		
607	<input type="checkbox"/> Yes <input type="checkbox"/> No			657	<input type="checkbox"/> Yes, <input type="checkbox"/> No		
608	<input type="checkbox"/> Yes <input type="checkbox"/> No			658	<input type="checkbox"/> Yes, <input type="checkbox"/> No		
609	<input type="checkbox"/> Yes <input type="checkbox"/> No			659	<input type="checkbox"/> Yes, <input type="checkbox"/> No		
610	<input type="checkbox"/> Yes <input type="checkbox"/> No			660	<input type="checkbox"/> Yes, <input type="checkbox"/> No		
611	<input type="checkbox"/> Yes <input type="checkbox"/> No			661	<input type="checkbox"/> Yes, <input type="checkbox"/> No		
612	<input type="checkbox"/> Yes <input type="checkbox"/> No			662	<input type="checkbox"/> Yes, <input type="checkbox"/> No		
613	<input type="checkbox"/> Yes <input type="checkbox"/> No			663	<input type="checkbox"/> Yes, <input type="checkbox"/> No		
614	<input type="checkbox"/> Yes <input type="checkbox"/> No			664	<input type="checkbox"/> Yes, <input type="checkbox"/> No		
615	<input type="checkbox"/> Yes <input type="checkbox"/> No			665	<input type="checkbox"/> Yes, <input type="checkbox"/> No		
616	<input type="checkbox"/> Yes <input type="checkbox"/> No			666	<input type="checkbox"/> Yes, <input type="checkbox"/> No		
617	<input type="checkbox"/> Yes <input type="checkbox"/> No			667	<input type="checkbox"/> Yes, <input type="checkbox"/> No		
618	<input type="checkbox"/> Yes <input type="checkbox"/> No			668	<input type="checkbox"/> Yes, <input type="checkbox"/> No		
619	<input type="checkbox"/> Yes <input type="checkbox"/> No			669	<input type="checkbox"/> Yes, <input type="checkbox"/> No		
620	<input type="checkbox"/> Yes <input type="checkbox"/> No			670	<input type="checkbox"/> Yes, <input type="checkbox"/> No		
621	<input type="checkbox"/> Yes <input type="checkbox"/> No			671	<input type="checkbox"/> Yes, <input type="checkbox"/> No		
622	<input type="checkbox"/> Yes <input type="checkbox"/> No			672	<input type="checkbox"/> Yes, <input type="checkbox"/> No		
623	<input type="checkbox"/> Yes <input type="checkbox"/> No			673	<input type="checkbox"/> Yes, <input type="checkbox"/> No		
624	<input type="checkbox"/> Yes <input type="checkbox"/> No			674	<input type="checkbox"/> Yes, <input type="checkbox"/> No		
625	<input type="checkbox"/> Yes <input type="checkbox"/> No			675	<input type="checkbox"/> Yes, <input type="checkbox"/> No		
626	<input type="checkbox"/> Yes <input type="checkbox"/> No			676	<input type="checkbox"/> Yes, <input type="checkbox"/> No		
627	<input type="checkbox"/> Yes <input type="checkbox"/> No			677	<input type="checkbox"/> Yes, <input type="checkbox"/> No		
628	<input type="checkbox"/> Yes <input type="checkbox"/> No			678	<input type="checkbox"/> Yes, <input type="checkbox"/> No		
629	<input type="checkbox"/> Yes <input type="checkbox"/> No			679	<input type="checkbox"/> Yes, <input type="checkbox"/> No		
630	<input type="checkbox"/> Yes <input type="checkbox"/> No			680	<input type="checkbox"/> Yes, <input type="checkbox"/> No		
631	<input type="checkbox"/> Yes <input type="checkbox"/> No			681	<input type="checkbox"/> Yes, <input type="checkbox"/> No		
632	<input type="checkbox"/> Yes <input type="checkbox"/> No			682	<input type="checkbox"/> Yes, <input type="checkbox"/> No		
633	<input type="checkbox"/> Yes <input type="checkbox"/> No			683	<input type="checkbox"/> Yes, <input type="checkbox"/> No		
634	<input type="checkbox"/> Yes <input type="checkbox"/> No			684	<input type="checkbox"/> Yes, <input type="checkbox"/> No		
635	<input type="checkbox"/> Yes <input type="checkbox"/> No			685	<input type="checkbox"/> Yes, <input type="checkbox"/> No		
636	<input type="checkbox"/> Yes <input type="checkbox"/> No			686	<input type="checkbox"/> Yes, <input type="checkbox"/> No		
637	<input type="checkbox"/> Yes <input type="checkbox"/> No			687	<input type="checkbox"/> Yes, <input type="checkbox"/> No		
638	<input type="checkbox"/> Yes <input type="checkbox"/> No			688	<input type="checkbox"/> Yes, <input type="checkbox"/> No		
639	<input type="checkbox"/> Yes <input type="checkbox"/> No			689	<input type="checkbox"/> Yes, <input type="checkbox"/> No		
640	<input type="checkbox"/> Yes <input type="checkbox"/> No			690	<input type="checkbox"/> Yes, <input type="checkbox"/> No		
641	<input type="checkbox"/> Yes <input type="checkbox"/> No			691	<input type="checkbox"/> Yes, <input type="checkbox"/> No		
642	<input type="checkbox"/> Yes <input type="checkbox"/> No			692	<input type="checkbox"/> Yes, <input type="checkbox"/> No		
643	<input type="checkbox"/> Yes <input type="checkbox"/> No			693	<input type="checkbox"/> Yes, <input type="checkbox"/> No		
644	<input type="checkbox"/> Yes <input type="checkbox"/> No			694	<input type="checkbox"/> Yes, <input type="checkbox"/> No		
645	<input type="checkbox"/> Yes <input type="checkbox"/> No			695	<input type="checkbox"/> Yes, <input type="checkbox"/> No		
646	<input type="checkbox"/> Yes <input type="checkbox"/> No			696	<input type="checkbox"/> Yes, <input type="checkbox"/> No		
647	<input type="checkbox"/> Yes <input type="checkbox"/> No			697	<input type="checkbox"/> Yes, <input type="checkbox"/> No		
648	<input type="checkbox"/> Yes <input type="checkbox"/> No			698	<input type="checkbox"/> Yes, <input type="checkbox"/> No		
649	<input type="checkbox"/> Yes <input type="checkbox"/> No			699	<input type="checkbox"/> Yes, <input type="checkbox"/> No		

TOLL RESTRICTION-AREA/OFFICE CODE TABLE (6/8)

At-ea/Office Code Table No. 2

Code No.	Local Call Access	Restriction Level	Office Code	Code No.	Local Call Access	Restriction Level	Office Code
700	<input type="checkbox"/> Yes, <input type="checkbox"/> No			750	<input type="checkbox"/> Yes, <input type="checkbox"/> No		
701	<input type="checkbox"/> Yes, <input type="checkbox"/> No			751	<input type="checkbox"/> Yes, <input type="checkbox"/> No		
702	<input type="checkbox"/> Yes, <input type="checkbox"/> No			752	<input type="checkbox"/> Yes, <input type="checkbox"/> No		
703	<input type="checkbox"/> Yes, <input type="checkbox"/> No			753	<input type="checkbox"/> Yes, <input type="checkbox"/> No		
704	<input type="checkbox"/> Yes, <input type="checkbox"/> No			754	<input type="checkbox"/> Yes, <input type="checkbox"/> No		
705	<input type="checkbox"/> Yes, <input type="checkbox"/> No			755	<input type="checkbox"/> Yes, <input type="checkbox"/> No		
706	<input type="checkbox"/> Yes, <input type="checkbox"/> No			756	<input type="checkbox"/> Yes, <input type="checkbox"/> No		
707	<input type="checkbox"/> Yes, <input type="checkbox"/> No			757	<input type="checkbox"/> Yes, <input type="checkbox"/> No		
708	<input type="checkbox"/> Yes, <input type="checkbox"/> No			758	<input type="checkbox"/> Yes, <input type="checkbox"/> No		
709	<input type="checkbox"/> Yes, <input type="checkbox"/> No			759	<input type="checkbox"/> Yes, <input type="checkbox"/> No		
710	<input type="checkbox"/> Yes, <input type="checkbox"/> No			760	<input type="checkbox"/> Yes, <input type="checkbox"/> No		
711	<input type="checkbox"/> Yes, <input type="checkbox"/> No			761	<input type="checkbox"/> Yes, <input type="checkbox"/> No		
712	<input type="checkbox"/> Yes, <input type="checkbox"/> No			762	<input type="checkbox"/> Yes, <input type="checkbox"/> No		
713	<input type="checkbox"/> Yes, <input type="checkbox"/> No			763	<input type="checkbox"/> Yes, <input type="checkbox"/> No		
714	<input type="checkbox"/> Yes, <input type="checkbox"/> No			764	<input type="checkbox"/> Yes, <input type="checkbox"/> No		
715	<input type="checkbox"/> Yes, <input type="checkbox"/> No			765	<input type="checkbox"/> Yes, <input type="checkbox"/> No		
716	<input type="checkbox"/> Yes, <input type="checkbox"/> No			766	<input type="checkbox"/> Yes, <input type="checkbox"/> No		
717	<input type="checkbox"/> Yes, <input type="checkbox"/> No			767	<input type="checkbox"/> Yes, <input type="checkbox"/> No		
718	<input type="checkbox"/> Yes, <input type="checkbox"/> No			768	<input type="checkbox"/> Yes, <input type="checkbox"/> No		
719	<input type="checkbox"/> Yes, <input type="checkbox"/> No			769	<input type="checkbox"/> Yes, <input type="checkbox"/> No		
720	<input type="checkbox"/> Yes, <input type="checkbox"/> No			770	<input type="checkbox"/> Yes, <input type="checkbox"/> No		
721	<input type="checkbox"/> Yes, <input type="checkbox"/> No			771	<input type="checkbox"/> Yes, <input type="checkbox"/> No		
722	<input type="checkbox"/> Yes, <input type="checkbox"/> No			772	<input type="checkbox"/> Yes, <input type="checkbox"/> No		
723	<input type="checkbox"/> Yes, <input type="checkbox"/> No			773	<input type="checkbox"/> Yes, <input type="checkbox"/> No		
724	<input type="checkbox"/> Yes, <input type="checkbox"/> No			774	<input type="checkbox"/> Yes, <input type="checkbox"/> No		
725	<input type="checkbox"/> Yes, <input type="checkbox"/> No			775	<input type="checkbox"/> Yes, <input type="checkbox"/> No		
726	<input type="checkbox"/> Yes, <input type="checkbox"/> No			776	<input type="checkbox"/> Yes, <input type="checkbox"/> No		
727	<input type="checkbox"/> Yes, <input type="checkbox"/> No			777	<input type="checkbox"/> Yes, <input type="checkbox"/> No		
728	<input type="checkbox"/> Yes, <input type="checkbox"/> No			778	<input type="checkbox"/> Yes, <input type="checkbox"/> No		
729	<input type="checkbox"/> Yes, <input type="checkbox"/> No			779	<input type="checkbox"/> Yes, <input type="checkbox"/> No		
730	<input type="checkbox"/> Yes, <input type="checkbox"/> No			780	<input type="checkbox"/> Yes, <input type="checkbox"/> No		
731	<input type="checkbox"/> Yes, <input type="checkbox"/> No			781	<input type="checkbox"/> Yes, <input type="checkbox"/> No		
732	<input type="checkbox"/> Yes, <input type="checkbox"/> No			782	<input type="checkbox"/> Yes, <input type="checkbox"/> No		
733	<input type="checkbox"/> Yes, <input type="checkbox"/> No			783	<input type="checkbox"/> Yes, <input type="checkbox"/> No		
734	<input type="checkbox"/> Yes, <input type="checkbox"/> No			784	<input type="checkbox"/> Yes, <input type="checkbox"/> No		
735	<input type="checkbox"/> Yes, <input type="checkbox"/> No			785	<input type="checkbox"/> Yes, <input type="checkbox"/> No		
736	<input type="checkbox"/> Yes, <input type="checkbox"/> No			786	<input type="checkbox"/> Yes, <input type="checkbox"/> No		
737	<input type="checkbox"/> Yes, <input type="checkbox"/> No			787	<input type="checkbox"/> Yes, <input type="checkbox"/> No		
738	<input type="checkbox"/> Yes, <input type="checkbox"/> No			788	<input type="checkbox"/> Yes, <input type="checkbox"/> No		
739	<input type="checkbox"/> Yes, <input type="checkbox"/> No			789	<input type="checkbox"/> Yes, <input type="checkbox"/> No		
740	<input type="checkbox"/> Yes, <input type="checkbox"/> No			790	<input type="checkbox"/> Yes, <input type="checkbox"/> No		
741	<input type="checkbox"/> Yes, <input type="checkbox"/> No			791	<input type="checkbox"/> Yes, <input type="checkbox"/> No		
742	<input type="checkbox"/> Yes, <input type="checkbox"/> No			792	<input type="checkbox"/> Yes, <input type="checkbox"/> No		
743	<input type="checkbox"/> Yes, <input type="checkbox"/> No			793	<input type="checkbox"/> Yes, <input type="checkbox"/> No		
744	<input type="checkbox"/> Yes, <input type="checkbox"/> No			794	<input type="checkbox"/> Yes, <input type="checkbox"/> No		
745	<input type="checkbox"/> Yes, <input type="checkbox"/> No			795	<input type="checkbox"/> Yes, <input type="checkbox"/> No		
746	<input type="checkbox"/> Yes, <input type="checkbox"/> No			796	<input type="checkbox"/> Yes, <input type="checkbox"/> No		
747	<input type="checkbox"/> Yes, <input type="checkbox"/> No			797	<input type="checkbox"/> Yes, <input type="checkbox"/> No		
748	<input type="checkbox"/> Yes, <input type="checkbox"/> No			798	<input type="checkbox"/> Yes, <input type="checkbox"/> No		
749	<input type="checkbox"/> Yes, <input type="checkbox"/> No			799	<input type="checkbox"/> Yes, <input type="checkbox"/> No		

TOLL RESTRICTION-AREA/OFFICE CODE TABLE (7/8)

Area/Office Code Table No. 2

Code No.	Local Call Access	Restriction Level	Office Code	Code No.	Local Call Access	Restriction Level	Office Code
800	<input type="checkbox"/> Yes, <input type="checkbox"/> No			850	<input type="checkbox"/> Yes, <input type="checkbox"/> No		
801	<input type="checkbox"/> Yes, <input type="checkbox"/> No			851	<input type="checkbox"/> Yes, <input type="checkbox"/> No		
802	<input type="checkbox"/> Yes, <input type="checkbox"/> No			852	<input type="checkbox"/> Yes, <input type="checkbox"/> No		
803	<input type="checkbox"/> Yes, <input type="checkbox"/> No			853	<input type="checkbox"/> Yes, <input type="checkbox"/> No		
804	<input type="checkbox"/> Yes, <input type="checkbox"/> No			854	<input type="checkbox"/> Yes, <input type="checkbox"/> No		
805	<input type="checkbox"/> Yes, <input type="checkbox"/> No			855	<input type="checkbox"/> Yes, <input type="checkbox"/> No		
806	<input type="checkbox"/> Yes, <input type="checkbox"/> No			856	<input type="checkbox"/> Yes, <input type="checkbox"/> No		
807	<input type="checkbox"/> Yes, <input type="checkbox"/> No			857	<input type="checkbox"/> Yes, <input type="checkbox"/> No		
808	<input type="checkbox"/> Yes, <input type="checkbox"/> No			858	<input type="checkbox"/> Yes, <input type="checkbox"/> No		
809	<input type="checkbox"/> Yes, <input type="checkbox"/> No			859	<input type="checkbox"/> Yes, <input type="checkbox"/> No		
810	<input type="checkbox"/> Yes, <input type="checkbox"/> No			860	<input type="checkbox"/> Yes, <input type="checkbox"/> No		
811	<input type="checkbox"/> Yes, <input type="checkbox"/> No			861	<input type="checkbox"/> Yes, <input type="checkbox"/> No		
812	<input type="checkbox"/> Yes, <input type="checkbox"/> No			862	<input type="checkbox"/> Yes, <input type="checkbox"/> No		
813	<input type="checkbox"/> Yes, <input type="checkbox"/> No			863	<input type="checkbox"/> Yes, <input type="checkbox"/> No		
814	<input type="checkbox"/> Yes, <input type="checkbox"/> No			864	<input type="checkbox"/> Yes, <input type="checkbox"/> No		
815	<input type="checkbox"/> Yes, <input type="checkbox"/> No			865	<input type="checkbox"/> Yes, <input type="checkbox"/> No		
816	<input type="checkbox"/> Yes, <input type="checkbox"/> No			866	<input type="checkbox"/> Yes, <input type="checkbox"/> No		
817	<input type="checkbox"/> Yes, <input type="checkbox"/> No			867	<input type="checkbox"/> Yes, <input type="checkbox"/> No		
818	<input type="checkbox"/> Yes, <input type="checkbox"/> No			868	<input type="checkbox"/> Yes, <input type="checkbox"/> No		
819	<input type="checkbox"/> Yes, <input type="checkbox"/> No			869	<input type="checkbox"/> Yes, <input type="checkbox"/> No		
820	<input type="checkbox"/> Yes, <input type="checkbox"/> No			870	<input type="checkbox"/> Yes, <input type="checkbox"/> No		
821	<input type="checkbox"/> Yes, <input type="checkbox"/> No			871	<input type="checkbox"/> Yes, <input type="checkbox"/> No		
822	<input type="checkbox"/> Yes, <input type="checkbox"/> No			872	<input type="checkbox"/> Yes, <input type="checkbox"/> No		
823	<input type="checkbox"/> Yes, <input type="checkbox"/> No			873	<input type="checkbox"/> Yes, <input type="checkbox"/> No		
824	<input type="checkbox"/> Yes, <input type="checkbox"/> No			874	<input type="checkbox"/> Yes, <input type="checkbox"/> No		
825	<input type="checkbox"/> Yes, <input type="checkbox"/> No			875	<input type="checkbox"/> Yes, <input type="checkbox"/> No		
826	<input type="checkbox"/> Yes, <input type="checkbox"/> No			876	<input type="checkbox"/> Yes, <input type="checkbox"/> No		
827	<input type="checkbox"/> Yes, <input type="checkbox"/> No			877	<input type="checkbox"/> Yes, <input type="checkbox"/> No		
828	<input type="checkbox"/> Yes, <input type="checkbox"/> No			878	<input type="checkbox"/> Yes, <input type="checkbox"/> No		
829	<input type="checkbox"/> Yes, <input type="checkbox"/> No			879	<input type="checkbox"/> Yes, <input type="checkbox"/> No		
830	<input type="checkbox"/> Yes, <input type="checkbox"/> No			880	<input type="checkbox"/> Yes, <input type="checkbox"/> No		
831	<input type="checkbox"/> Yes, <input type="checkbox"/> No			881	<input type="checkbox"/> Yes, <input type="checkbox"/> No		
832	<input type="checkbox"/> Yes, <input type="checkbox"/> No			882	<input type="checkbox"/> Yes, <input type="checkbox"/> No		
833	<input type="checkbox"/> Yes, <input type="checkbox"/> No			883	<input type="checkbox"/> Yes, <input type="checkbox"/> No		
834	<input type="checkbox"/> Yes, <input type="checkbox"/> No			884	<input type="checkbox"/> Yes, <input type="checkbox"/> No		
835	<input type="checkbox"/> Yes, <input type="checkbox"/> No			885	<input type="checkbox"/> Yes, <input type="checkbox"/> No		
836	<input type="checkbox"/> Yes, <input type="checkbox"/> No			886	<input type="checkbox"/> Yes, <input type="checkbox"/> No		
837	<input type="checkbox"/> Yes, <input type="checkbox"/> No			887	<input type="checkbox"/> Yes, <input type="checkbox"/> No		
838	<input type="checkbox"/> Yes, <input type="checkbox"/> No			888	<input type="checkbox"/> Yes, <input type="checkbox"/> No		
839	<input type="checkbox"/> Yes, <input type="checkbox"/> No			889	<input type="checkbox"/> Yes, <input type="checkbox"/> No		
840	<input type="checkbox"/> Yes, <input type="checkbox"/> No			890	<input type="checkbox"/> Yes, <input type="checkbox"/> No		
841	<input type="checkbox"/> Yes, <input type="checkbox"/> No			891	<input type="checkbox"/> Yes, <input type="checkbox"/> No		
842	<input type="checkbox"/> Yes, <input type="checkbox"/> No			892	<input type="checkbox"/> Yes, <input type="checkbox"/> No		
843	<input type="checkbox"/> Yes, <input type="checkbox"/> No			893	<input type="checkbox"/> Yes, <input type="checkbox"/> No		
844	<input type="checkbox"/> Yes, <input type="checkbox"/> No			894	<input type="checkbox"/> Yes, <input type="checkbox"/> No		
845	<input type="checkbox"/> Yes, <input type="checkbox"/> No			895	<input type="checkbox"/> Yes, <input type="checkbox"/> No		
846	<input type="checkbox"/> Yes, <input type="checkbox"/> No			896	<input type="checkbox"/> Yes, <input type="checkbox"/> No		
847	<input type="checkbox"/> Yes, <input type="checkbox"/> No			897	<input type="checkbox"/> Yes, <input type="checkbox"/> No		
848	<input type="checkbox"/> Yes, <input type="checkbox"/> No			898	<input type="checkbox"/> Yes, <input type="checkbox"/> No		
849	<input type="checkbox"/> Yes, <input type="checkbox"/> No			899	<input type="checkbox"/> Yes, <input type="checkbox"/> No		

TOLL RESTRICTION-AREA/OFFICE CODE TABLE (8/8)

Area/Office Code Table No. 2

Code No.	Local Call Access	Restriction Level	Office Code	Code No.	Local Call Access	Restriction Level	Office Code
900	<input type="checkbox"/> Yes, <input type="checkbox"/> No			953	<input type="checkbox"/> Yes, <input type="checkbox"/> No		
901	<input type="checkbox"/> Yes, <input type="checkbox"/> No			954	<input type="checkbox"/> Yes, <input type="checkbox"/> No		
902	<input type="checkbox"/> Yes, <input type="checkbox"/> No			955	<input type="checkbox"/> Yes, <input type="checkbox"/> No		
903	<input type="checkbox"/> Yes, <input type="checkbox"/> No			956	<input type="checkbox"/> Yes, <input type="checkbox"/> No		
904	<input type="checkbox"/> Yes, <input type="checkbox"/> No			957	<input type="checkbox"/> Yes, <input type="checkbox"/> No		
905	<input type="checkbox"/> Yes, <input type="checkbox"/> No			958	<input type="checkbox"/> Yes, <input type="checkbox"/> No		
906	<input type="checkbox"/> Yes, <input type="checkbox"/> No			959	<input type="checkbox"/> Yes, <input type="checkbox"/> No		
907	<input type="checkbox"/> Yes, <input type="checkbox"/> No			960	<input type="checkbox"/> Yes, <input type="checkbox"/> No		
908	<input type="checkbox"/> Yes, <input type="checkbox"/> No			961	<input type="checkbox"/> Yes, <input type="checkbox"/> No		
909	<input type="checkbox"/> Yes, <input type="checkbox"/> No			962	<input type="checkbox"/> Yes, <input type="checkbox"/> No		
910	<input type="checkbox"/> Yes, <input type="checkbox"/> No			963	<input type="checkbox"/> Yes, <input type="checkbox"/> No		
911	<input type="checkbox"/> Yes, <input type="checkbox"/> No			964	<input type="checkbox"/> Yes, <input type="checkbox"/> No		
912	<input type="checkbox"/> Yes, <input type="checkbox"/> No			965	<input type="checkbox"/> Yes, <input type="checkbox"/> No		
913	<input type="checkbox"/> Yes, <input type="checkbox"/> No			966	<input type="checkbox"/> Yes, <input type="checkbox"/> No		
914	<input type="checkbox"/> Yes, <input type="checkbox"/> No			967	<input type="checkbox"/> Yes, <input type="checkbox"/> No		
915	<input type="checkbox"/> Yes, <input type="checkbox"/> No			968	<input type="checkbox"/> Yes, <input type="checkbox"/> No		
916	<input type="checkbox"/> Yes, <input type="checkbox"/> No			969	<input type="checkbox"/> Yes, <input type="checkbox"/> No		
917	<input type="checkbox"/> Yes, <input type="checkbox"/> No			970	<input type="checkbox"/> Yes, <input type="checkbox"/> No		
918	<input type="checkbox"/> Yes, <input type="checkbox"/> No			971	<input type="checkbox"/> Yes, <input type="checkbox"/> No		
919	<input type="checkbox"/> Yes, <input type="checkbox"/> No			972	<input type="checkbox"/> Yes, <input type="checkbox"/> No		
920	<input type="checkbox"/> Yes, <input type="checkbox"/> No			973	<input type="checkbox"/> Yes, <input type="checkbox"/> No		
921	<input type="checkbox"/> Yes, <input type="checkbox"/> No			974	<input type="checkbox"/> Yes, <input type="checkbox"/> No		
922	<input type="checkbox"/> Yes, <input type="checkbox"/> No			975	<input type="checkbox"/> Yes, <input type="checkbox"/> No		
923	<input type="checkbox"/> Yes, <input type="checkbox"/> No			976	<input type="checkbox"/> Yes, <input type="checkbox"/> No		
924	<input type="checkbox"/> Yes, <input type="checkbox"/> No			977	<input type="checkbox"/> Yes, <input type="checkbox"/> No		
925	<input type="checkbox"/> Yes, <input type="checkbox"/> No			978	<input type="checkbox"/> Yes, <input type="checkbox"/> No		
926	<input type="checkbox"/> Yes, <input type="checkbox"/> No			979	<input type="checkbox"/> Yes, <input type="checkbox"/> No		
927	<input type="checkbox"/> Yes, <input type="checkbox"/> No			980	<input type="checkbox"/> Yes, <input type="checkbox"/> No		
928	<input type="checkbox"/> Yes, <input type="checkbox"/> No			981	<input type="checkbox"/> Yes, <input type="checkbox"/> No		
929	<input type="checkbox"/> Yes, <input type="checkbox"/> No			982	<input type="checkbox"/> Yes, <input type="checkbox"/> No		
930	<input type="checkbox"/> Yes, <input type="checkbox"/> No			983	<input type="checkbox"/> Yes, <input type="checkbox"/> No		
931	<input type="checkbox"/> Yes, <input type="checkbox"/> No			984	<input type="checkbox"/> Yes, <input type="checkbox"/> No		
932	<input type="checkbox"/> Yes, <input type="checkbox"/> No			985	<input type="checkbox"/> Yes, <input type="checkbox"/> No		
933	<input type="checkbox"/> Yes, <input type="checkbox"/> No			986	<input type="checkbox"/> Yes, <input type="checkbox"/> No		
934	<input type="checkbox"/> Yes, <input type="checkbox"/> No			987	<input type="checkbox"/> Yes, <input type="checkbox"/> No		
935	<input type="checkbox"/> Yes, <input type="checkbox"/> No			988	<input type="checkbox"/> Yes, <input type="checkbox"/> No		
936	<input type="checkbox"/> Yes, <input type="checkbox"/> No			989	<input type="checkbox"/> Yes, <input type="checkbox"/> No		
937	<input type="checkbox"/> Yes, <input type="checkbox"/> No			990	<input type="checkbox"/> Yes, <input type="checkbox"/> No		
938	<input type="checkbox"/> Yes, <input type="checkbox"/> No			991	<input type="checkbox"/> Yes, <input type="checkbox"/> No		
939	<input type="checkbox"/> Yes, <input type="checkbox"/> No			992	<input type="checkbox"/> Yes, <input type="checkbox"/> No		
940	<input type="checkbox"/> Yes, <input type="checkbox"/> No			993	<input type="checkbox"/> Yes, <input type="checkbox"/> No		
941	<input type="checkbox"/> Yes, <input type="checkbox"/> No			994	<input type="checkbox"/> Yes, <input type="checkbox"/> No		
942	<input type="checkbox"/> Yes, <input type="checkbox"/> No			995	<input type="checkbox"/> Yes, <input type="checkbox"/> No		
943	<input type="checkbox"/> Yes, <input type="checkbox"/> No			996	<input type="checkbox"/> Yes, <input type="checkbox"/> No		
944	<input type="checkbox"/> Yes, <input type="checkbox"/> No			997	<input type="checkbox"/> Yes, <input type="checkbox"/> No		
945	<input type="checkbox"/> Yes, <input type="checkbox"/> No			998	<input type="checkbox"/> Yes, <input type="checkbox"/> No		
946	<input type="checkbox"/> Yes, <input type="checkbox"/> No			999	<input type="checkbox"/> Yes, <input type="checkbox"/> No		
947	<input type="checkbox"/> Yes, <input type="checkbox"/> No						
948	<input type="checkbox"/> Yes, <input type="checkbox"/> No						
949	<input type="checkbox"/> Yes, <input type="checkbox"/> No						

TOLL RESTRICTION-AREA/OFFICE CODE TABLE (1/8)

Area/Office Code Table No. 3

Code No.	Local Call Access	Restriction Level	Office Code	Code No.	Local Call Access	Restriction Level	Office Code
200	<input type="checkbox"/> Yes, <input type="checkbox"/> No			250	<input type="checkbox"/> Yes, <input type="checkbox"/> No		
201	<input type="checkbox"/> Yes, <input type="checkbox"/> No			251	<input type="checkbox"/> Yes, <input type="checkbox"/> No		
202	<input type="checkbox"/> Yes, <input type="checkbox"/> No			252	<input type="checkbox"/> Yes, <input type="checkbox"/> No		
203	<input type="checkbox"/> Yes, <input type="checkbox"/> No			253	<input type="checkbox"/> Yes, <input type="checkbox"/> No		
204	<input type="checkbox"/> Yes, <input type="checkbox"/> No			254	<input type="checkbox"/> Yes, <input type="checkbox"/> No		
205	<input type="checkbox"/> Yes, <input type="checkbox"/> No			255	<input type="checkbox"/> Yes, <input type="checkbox"/> No		
206	<input type="checkbox"/> Yes, <input type="checkbox"/> No			256	<input type="checkbox"/> Yes, <input type="checkbox"/> No		
207	<input type="checkbox"/> Yes, <input type="checkbox"/> No			257	<input type="checkbox"/> Yes, <input type="checkbox"/> No		
208	<input type="checkbox"/> Yes, <input type="checkbox"/> No			258	<input type="checkbox"/> Yes, <input type="checkbox"/> No		
209	<input type="checkbox"/> Yes, <input type="checkbox"/> No			259	<input type="checkbox"/> Yes, <input type="checkbox"/> No		
210	<input type="checkbox"/> Yes, <input type="checkbox"/> No			260	<input type="checkbox"/> Yes, <input type="checkbox"/> No		
211	<input type="checkbox"/> Yes, <input type="checkbox"/> No			261	<input type="checkbox"/> Yes, <input type="checkbox"/> No		
212	<input type="checkbox"/> Yes, <input type="checkbox"/> No			262	<input type="checkbox"/> Yes, <input type="checkbox"/> No		
213	<input type="checkbox"/> Yes, <input type="checkbox"/> No			263	<input type="checkbox"/> Yes, <input type="checkbox"/> No		
214	<input type="checkbox"/> Yes, <input type="checkbox"/> No			264	<input type="checkbox"/> Yes, <input type="checkbox"/> No		
215	<input type="checkbox"/> Yes, <input type="checkbox"/> No			265	<input type="checkbox"/> Yes, <input type="checkbox"/> No		
216	<input type="checkbox"/> Yes, <input type="checkbox"/> No			266	<input type="checkbox"/> Yes, <input type="checkbox"/> No		
217	<input type="checkbox"/> Yes, <input type="checkbox"/> No			267	<input type="checkbox"/> Yes, <input type="checkbox"/> No		
218	<input type="checkbox"/> Yes, <input type="checkbox"/> No			268	<input type="checkbox"/> Yes, <input type="checkbox"/> No		
219	<input type="checkbox"/> Yes, <input type="checkbox"/> No			269	<input type="checkbox"/> Yes, <input type="checkbox"/> No		
220	<input type="checkbox"/> Yes, <input type="checkbox"/> No			270	<input type="checkbox"/> Yes, <input type="checkbox"/> No		
221	<input type="checkbox"/> Yes, <input type="checkbox"/> No			271	<input type="checkbox"/> Yes, <input type="checkbox"/> No		
222	<input type="checkbox"/> Yes, <input type="checkbox"/> No			272	<input type="checkbox"/> Yes, <input type="checkbox"/> No		
223	<input type="checkbox"/> Yes, <input type="checkbox"/> No			273	<input type="checkbox"/> Yes, <input type="checkbox"/> No		
224	<input type="checkbox"/> Yes, <input type="checkbox"/> No			274	<input type="checkbox"/> Yes, <input type="checkbox"/> No		
225	<input type="checkbox"/> Yes, <input type="checkbox"/> No			275	<input type="checkbox"/> Yes, <input type="checkbox"/> No		
226	<input type="checkbox"/> Yes, <input type="checkbox"/> No			276	<input type="checkbox"/> Yes, <input type="checkbox"/> No		
227	<input type="checkbox"/> Yes, <input type="checkbox"/> No			277	<input type="checkbox"/> Yes, <input type="checkbox"/> No		
228	<input type="checkbox"/> Yes, <input type="checkbox"/> No			278	<input type="checkbox"/> Yes, <input type="checkbox"/> No		
229	<input type="checkbox"/> Yes, <input type="checkbox"/> No			279	<input type="checkbox"/> Yes, <input type="checkbox"/> No		
230	<input type="checkbox"/> Yes, <input type="checkbox"/> No			280	<input type="checkbox"/> Yes, <input type="checkbox"/> No		
231	<input type="checkbox"/> Yes, <input type="checkbox"/> No			281	<input type="checkbox"/> Yes, <input type="checkbox"/> No		
232	<input type="checkbox"/> Yes, <input type="checkbox"/> No			282	<input type="checkbox"/> Yes, <input type="checkbox"/> No		
233	<input type="checkbox"/> Yes, <input type="checkbox"/> No			283	<input type="checkbox"/> Yes, <input type="checkbox"/> No		
234	<input type="checkbox"/> Yes, <input type="checkbox"/> No			284	<input type="checkbox"/> Yes, <input type="checkbox"/> No		
235	<input type="checkbox"/> Yes, <input type="checkbox"/> No			285	<input type="checkbox"/> Yes, <input type="checkbox"/> No		
236	<input type="checkbox"/> Yes, <input type="checkbox"/> No			286	<input type="checkbox"/> Yes, <input type="checkbox"/> No		
237	<input type="checkbox"/> Yes, <input type="checkbox"/> No			287	<input type="checkbox"/> Yes, <input type="checkbox"/> No		
238	<input type="checkbox"/> Yes, <input type="checkbox"/> No			288	<input type="checkbox"/> Yes, <input type="checkbox"/> No		
239	<input type="checkbox"/> Yes, <input type="checkbox"/> No			289	<input type="checkbox"/> Yes, <input type="checkbox"/> No		
240	<input type="checkbox"/> Yes, <input type="checkbox"/> No			290	<input type="checkbox"/> Yes, <input type="checkbox"/> No		
241	<input type="checkbox"/> Yes, <input type="checkbox"/> No			291	<input type="checkbox"/> Yes, <input type="checkbox"/> No		
242	<input type="checkbox"/> Yes, <input type="checkbox"/> No			292	<input type="checkbox"/> Yes, <input type="checkbox"/> No		
243	<input type="checkbox"/> Yes, <input type="checkbox"/> No			293	<input type="checkbox"/> Yes, <input type="checkbox"/> No		
244	<input type="checkbox"/> Yes, <input type="checkbox"/> No			294	<input type="checkbox"/> Yes, <input type="checkbox"/> No		
245	<input type="checkbox"/> Yes, <input type="checkbox"/> No			295	<input type="checkbox"/> Yes, <input type="checkbox"/> No		
246	<input type="checkbox"/> Yes, <input type="checkbox"/> No			296	<input type="checkbox"/> Yes, <input type="checkbox"/> No		
247	<input type="checkbox"/> Yes, <input type="checkbox"/> No			297	<input type="checkbox"/> Yes, <input type="checkbox"/> No		
248	<input type="checkbox"/> Yes, <input type="checkbox"/> No			298	<input type="checkbox"/> Yes, <input type="checkbox"/> No		
249	<input type="checkbox"/> Yes, <input type="checkbox"/> No			299	<input type="checkbox"/> Yes, <input type="checkbox"/> No		

TOLL RESTRICTION-AREA/OFFICE CODE TABLE (218)

Area/Office Code Table No. 3

Code No.	Local Access	Call	Restriction Level	NIT- m-2- Office Code	Code No.	Local Access	Call	Restriction Level	Office Code
300	<input type="checkbox"/> Yes, <input type="checkbox"/> No				350	<input type="checkbox"/> Yes, <input type="checkbox"/> No			
301	<input type="checkbox"/> Yes, <input type="checkbox"/> No				351	<input type="checkbox"/> Yes, <input type="checkbox"/> No			
302	<input type="checkbox"/> Yes, <input type="checkbox"/> No				352	<input type="checkbox"/> Yes, <input type="checkbox"/> No			
303	<input type="checkbox"/> Yes, <input type="checkbox"/> No				353	<input type="checkbox"/> Yes, <input type="checkbox"/> No			
304	<input type="checkbox"/> Yes, <input type="checkbox"/> No				354	<input type="checkbox"/> Yes, <input type="checkbox"/> No			
305	<input type="checkbox"/> Yes, <input type="checkbox"/> No				355	<input type="checkbox"/> Yes, <input type="checkbox"/> No			
306	<input type="checkbox"/> Yes, <input type="checkbox"/> No				356	<input type="checkbox"/> Yes, <input type="checkbox"/> No			
307	<input type="checkbox"/> Yes, <input type="checkbox"/> No				357	<input type="checkbox"/> Yes, <input type="checkbox"/> No			
308	<input type="checkbox"/> Yes, <input type="checkbox"/> No				358	<input type="checkbox"/> Yes, <input type="checkbox"/> No			
309	<input type="checkbox"/> Yes, <input type="checkbox"/> No				359	<input type="checkbox"/> Yes, <input type="checkbox"/> No			
310	<input type="checkbox"/> Yes, <input type="checkbox"/> No				360	<input type="checkbox"/> Yes, <input type="checkbox"/> No			
311	<input type="checkbox"/> Yes, <input type="checkbox"/> No				361	<input type="checkbox"/> Yes, <input type="checkbox"/> No			
312	<input type="checkbox"/> Yes, <input type="checkbox"/> No				362	<input type="checkbox"/> Yes, <input type="checkbox"/> No			
313	<input type="checkbox"/> Yes, <input type="checkbox"/> No				363	<input type="checkbox"/> Yes, <input type="checkbox"/> No			
314	<input type="checkbox"/> Yes, <input type="checkbox"/> No				364	<input type="checkbox"/> Yes, <input type="checkbox"/> No			
315	<input type="checkbox"/> Yes, <input type="checkbox"/> No				365	<input type="checkbox"/> Yes, <input type="checkbox"/> No			
316	<input type="checkbox"/> Yes, <input type="checkbox"/> No				366	<input type="checkbox"/> Yes, <input type="checkbox"/> No			
317	<input type="checkbox"/> Yes, <input type="checkbox"/> No				367	<input type="checkbox"/> Yes, <input type="checkbox"/> No			
318	<input type="checkbox"/> Yes, <input type="checkbox"/> No				368	<input type="checkbox"/> Yes, <input type="checkbox"/> No			
319	<input type="checkbox"/> Yes, <input type="checkbox"/> No				369	<input type="checkbox"/> Yes, <input type="checkbox"/> No			
320	<input type="checkbox"/> Yes, <input type="checkbox"/> No				370	<input type="checkbox"/> Yes, <input type="checkbox"/> No			
321	<input type="checkbox"/> Yes, <input type="checkbox"/> No				371	<input type="checkbox"/> Yes, <input type="checkbox"/> No			
322	<input type="checkbox"/> Yes, <input type="checkbox"/> No				372	<input type="checkbox"/> Yes, <input type="checkbox"/> No			
323	<input type="checkbox"/> Yes, <input type="checkbox"/> No				373	<input type="checkbox"/> Yes, <input type="checkbox"/> No			
324	<input type="checkbox"/> Yes, <input type="checkbox"/> No				374	<input type="checkbox"/> Yes, <input type="checkbox"/> No			
325	<input type="checkbox"/> Yes, <input type="checkbox"/> No				375	<input type="checkbox"/> Yes, <input type="checkbox"/> No			
326	<input type="checkbox"/> Yes, <input type="checkbox"/> No				376	<input type="checkbox"/> Yes, <input type="checkbox"/> No			
327	<input type="checkbox"/> Yes, <input type="checkbox"/> No				377	<input type="checkbox"/> Yes, <input type="checkbox"/> No			
328	<input type="checkbox"/> Yes, <input type="checkbox"/> No				378	<input type="checkbox"/> Yes, <input type="checkbox"/> No			
329	<input type="checkbox"/> Yes, <input type="checkbox"/> No				379	<input type="checkbox"/> Yes, <input type="checkbox"/> No			
330	<input type="checkbox"/> Yes, <input type="checkbox"/> No				380	<input type="checkbox"/> Yes, <input type="checkbox"/> No			
331	<input type="checkbox"/> Yes, <input type="checkbox"/> No				381	<input type="checkbox"/> Yes, <input type="checkbox"/> No			
332	<input type="checkbox"/> Yes, <input type="checkbox"/> No				382	<input type="checkbox"/> Yes, <input type="checkbox"/> No			
333	<input type="checkbox"/> Yes, <input type="checkbox"/> No				383	<input type="checkbox"/> Yes, <input type="checkbox"/> No			
334	<input type="checkbox"/> Yes, <input type="checkbox"/> No				384	<input type="checkbox"/> Yes, <input type="checkbox"/> No			
335	<input type="checkbox"/> Yes, <input type="checkbox"/> No				385	<input type="checkbox"/> Yes, <input type="checkbox"/> No			
336	<input type="checkbox"/> Yes, <input type="checkbox"/> No				386	<input type="checkbox"/> Yes, <input type="checkbox"/> No			
337	<input type="checkbox"/> Yes, <input type="checkbox"/> No				387	<input type="checkbox"/> Yes, <input type="checkbox"/> No			
338	<input type="checkbox"/> Yes, <input type="checkbox"/> No				388	<input type="checkbox"/> Yes, <input type="checkbox"/> No			
339	<input type="checkbox"/> Yes, <input type="checkbox"/> No				389	<input type="checkbox"/> Yes, <input type="checkbox"/> No			
340	<input type="checkbox"/> Yes, <input type="checkbox"/> No				390	<input type="checkbox"/> Yes, <input type="checkbox"/> No			
341	<input type="checkbox"/> Yes, <input type="checkbox"/> No				391	<input type="checkbox"/> Yes, <input type="checkbox"/> No			
342	<input type="checkbox"/> Yes, <input type="checkbox"/> No				392	<input type="checkbox"/> Yes, <input type="checkbox"/> No			
343	<input type="checkbox"/> Yes, <input type="checkbox"/> No				393	<input type="checkbox"/> Yes, <input type="checkbox"/> No			
344	<input type="checkbox"/> Yes, <input type="checkbox"/> No				394	<input type="checkbox"/> Yes, <input type="checkbox"/> No			
345	<input type="checkbox"/> Yes, <input type="checkbox"/> No				395	<input type="checkbox"/> Yes, <input type="checkbox"/> No			
346	<input type="checkbox"/> Yes, <input type="checkbox"/> No				396	<input type="checkbox"/> Yes, <input type="checkbox"/> No			
347	<input type="checkbox"/> Yes, <input type="checkbox"/> No				397	<input type="checkbox"/> Yes, <input type="checkbox"/> No			
348	<input type="checkbox"/> Yes, <input type="checkbox"/> No				398	<input type="checkbox"/> Yes, <input type="checkbox"/> No			
349	<input type="checkbox"/> Yes, <input type="checkbox"/> No				399	<input type="checkbox"/> Yes, <input type="checkbox"/> No			

TOLL RESTRICTION—AREA/OFFICE CODE TABLE (3/8)

Area/Office Code Table No. 3

Code No.	Local Call Access	Restriction Level	Office Code	Code No.	Local Call Access	Restriction Level	Office Code
400	<input type="checkbox"/> Yes, <input type="checkbox"/> No			450	<input type="checkbox"/> Yes, <input type="checkbox"/> No		
401	<input type="checkbox"/> Yes, <input type="checkbox"/> No			451	<input type="checkbox"/> Yes, <input type="checkbox"/> No		
402	<input type="checkbox"/> Yes, <input type="checkbox"/> No			452	<input type="checkbox"/> Yes, <input type="checkbox"/> No		
403	<input type="checkbox"/> Yes, <input type="checkbox"/> No			453	<input type="checkbox"/> Yes, <input type="checkbox"/> No		
404	<input type="checkbox"/> Yes, <input type="checkbox"/> No			454	<input type="checkbox"/> Yes, <input type="checkbox"/> No		
405	<input type="checkbox"/> Yes, <input type="checkbox"/> No			455	<input type="checkbox"/> Yes, <input type="checkbox"/> No		
406	<input type="checkbox"/> Yes, <input type="checkbox"/> No			456	<input type="checkbox"/> Yes, <input type="checkbox"/> No		
407	<input type="checkbox"/> Yes, <input type="checkbox"/> No			457	<input type="checkbox"/> Yes, <input type="checkbox"/> No		
408	<input type="checkbox"/> Yes, <input type="checkbox"/> No			458	<input type="checkbox"/> Yes, <input type="checkbox"/> No		
409	<input type="checkbox"/> Yes, <input type="checkbox"/> No			459	<input type="checkbox"/> Yes, <input type="checkbox"/> No		
410	<input type="checkbox"/> Yes, <input type="checkbox"/> No			460	<input type="checkbox"/> Yes, <input type="checkbox"/> No		
411	<input type="checkbox"/> Yes, <input type="checkbox"/> No			461	<input type="checkbox"/> Yes, <input type="checkbox"/> No		
412	<input type="checkbox"/> Yes, <input type="checkbox"/> No			462	<input type="checkbox"/> Yes, <input type="checkbox"/> No		
413	<input type="checkbox"/> Yes, <input type="checkbox"/> No			463	<input type="checkbox"/> Yes, <input type="checkbox"/> No		
414	<input type="checkbox"/> Yes, <input type="checkbox"/> No			464	<input type="checkbox"/> Yes, <input type="checkbox"/> No		
415	<input type="checkbox"/> Yes, <input type="checkbox"/> No			465	<input type="checkbox"/> Yes, <input type="checkbox"/> No		
416	<input type="checkbox"/> Yes, <input type="checkbox"/> No			466	<input type="checkbox"/> Yes, <input type="checkbox"/> No		
417	<input type="checkbox"/> Yes, <input type="checkbox"/> No			467	<input type="checkbox"/> Yes, <input type="checkbox"/> No		
418	<input type="checkbox"/> Yes, <input type="checkbox"/> No			468	<input type="checkbox"/> Yes, <input type="checkbox"/> No		
419	<input type="checkbox"/> Yes, <input type="checkbox"/> No			469	<input type="checkbox"/> Yes, <input type="checkbox"/> No		
420	<input type="checkbox"/> Yes, <input type="checkbox"/> No			470	<input type="checkbox"/> Yes, <input type="checkbox"/> No		
421	<input type="checkbox"/> Yes, <input type="checkbox"/> No			471	<input type="checkbox"/> Yes, <input type="checkbox"/> No		
422	<input type="checkbox"/> Yes, <input type="checkbox"/> No			472	<input type="checkbox"/> Yes, <input type="checkbox"/> No		
423	<input type="checkbox"/> Yes, <input type="checkbox"/> No			473	<input type="checkbox"/> Yes, <input type="checkbox"/> No		
424	<input type="checkbox"/> Yes, <input type="checkbox"/> No			474	<input type="checkbox"/> Yes, <input type="checkbox"/> No		
425	<input type="checkbox"/> Yes, <input type="checkbox"/> No			475	<input type="checkbox"/> Yes, <input type="checkbox"/> No		
426	<input type="checkbox"/> Yes, <input type="checkbox"/> No			476	<input type="checkbox"/> Yes, <input type="checkbox"/> No		
427	<input type="checkbox"/> Yes, <input type="checkbox"/> No			477	<input type="checkbox"/> Yes, <input type="checkbox"/> No		
428	<input type="checkbox"/> Yes, <input type="checkbox"/> No			478	<input type="checkbox"/> Yes, <input type="checkbox"/> No		
429	<input type="checkbox"/> Yes, <input type="checkbox"/> No			479	<input type="checkbox"/> Yes, <input type="checkbox"/> No		
430	<input type="checkbox"/> Yes, <input type="checkbox"/> No			480	<input type="checkbox"/> Yes, <input type="checkbox"/> No		
431	<input type="checkbox"/> Yes, <input type="checkbox"/> No			481	<input type="checkbox"/> Yes, <input type="checkbox"/> No		
432	<input type="checkbox"/> Yes, <input type="checkbox"/> No			482	<input type="checkbox"/> Yes, <input type="checkbox"/> No		
433	<input type="checkbox"/> Yes, <input type="checkbox"/> No			483	<input type="checkbox"/> Yes, <input type="checkbox"/> No		
434	<input type="checkbox"/> Yes, <input type="checkbox"/> No			484	<input type="checkbox"/> Yes, <input type="checkbox"/> No		
435	<input type="checkbox"/> Yes, <input type="checkbox"/> No			485	<input type="checkbox"/> Yes, <input type="checkbox"/> No		
436	<input type="checkbox"/> Yes, <input type="checkbox"/> No			486	<input type="checkbox"/> Yes, <input type="checkbox"/> No		
437	<input type="checkbox"/> Yes, <input type="checkbox"/> No			487	<input type="checkbox"/> Yes, <input type="checkbox"/> No		
438	<input type="checkbox"/> Yes, <input type="checkbox"/> No			488	<input type="checkbox"/> Yes, <input type="checkbox"/> No		
439	<input type="checkbox"/> Yes, <input type="checkbox"/> No			489	<input type="checkbox"/> Yes, <input type="checkbox"/> No		
440	<input type="checkbox"/> Yes, <input type="checkbox"/> No			490	<input type="checkbox"/> Yes, <input type="checkbox"/> No		
441	<input type="checkbox"/> Yes, <input type="checkbox"/> No			491	<input type="checkbox"/> Yes, <input type="checkbox"/> No		
442	<input type="checkbox"/> Yes, <input type="checkbox"/> No			492	<input type="checkbox"/> Yes, <input type="checkbox"/> No		
443	<input type="checkbox"/> Yes, <input type="checkbox"/> No			493	<input type="checkbox"/> Yes, <input type="checkbox"/> No		
444	<input type="checkbox"/> Yes, <input type="checkbox"/> No			494	<input type="checkbox"/> Yes, <input type="checkbox"/> No		
445	<input type="checkbox"/> Yes, <input type="checkbox"/> No			495	<input type="checkbox"/> Yes, <input type="checkbox"/> No		
446	<input type="checkbox"/> Yes, <input type="checkbox"/> No			496	<input type="checkbox"/> Yes, <input type="checkbox"/> No		
447	<input type="checkbox"/> Yes, <input type="checkbox"/> No			497	<input type="checkbox"/> Yes, <input type="checkbox"/> No		
448	<input type="checkbox"/> Yes, <input type="checkbox"/> No			498	<input type="checkbox"/> Yes, <input type="checkbox"/> No		
449	<input type="checkbox"/> Yes, <input type="checkbox"/> No			499	<input type="checkbox"/> Yes, <input type="checkbox"/> No		

TOLL RESTRICTION-AREA/OFFICE CODE TABLE (418)

Area/Office Code Table No. 3

Code No.	Local Call Access	Restriction Level	Office Code	Code No.	Local Call Access	Restriction Level	Office Code
500	<input type="checkbox"/> Yes, <input checked="" type="checkbox"/> No			550	<input type="checkbox"/> Yes, <input checked="" type="checkbox"/> No		
501	<input type="checkbox"/> Yes, <input checked="" type="checkbox"/> No			551	<input type="checkbox"/> Yes, <input checked="" type="checkbox"/> No		
502	<input type="checkbox"/> Yes, <input checked="" type="checkbox"/> No			552	<input type="checkbox"/> Yes, <input checked="" type="checkbox"/> No		
503	<input type="checkbox"/> Yes, <input checked="" type="checkbox"/> No			553	<input type="checkbox"/> Yes, <input checked="" type="checkbox"/> No		
504	<input type="checkbox"/> Yes, <input checked="" type="checkbox"/> No			554	<input type="checkbox"/> Yes, <input checked="" type="checkbox"/> No		
505	<input type="checkbox"/> Yes, <input checked="" type="checkbox"/> No			555	<input type="checkbox"/> Yes, <input checked="" type="checkbox"/> No		
506	<input type="checkbox"/> Yes, <input checked="" type="checkbox"/> No			556	<input type="checkbox"/> Yes, <input checked="" type="checkbox"/> No		
507	<input type="checkbox"/> Yes, <input checked="" type="checkbox"/> No			557	<input type="checkbox"/> Yes, <input checked="" type="checkbox"/> No		
508	<input type="checkbox"/> Yes, <input checked="" type="checkbox"/> No			558	<input type="checkbox"/> Yes, <input checked="" type="checkbox"/> No		
510	<input type="checkbox"/> Yes, <input checked="" type="checkbox"/> No			560	<input type="checkbox"/> Yes, <input checked="" type="checkbox"/> No		
511	<input type="checkbox"/> Yes, <input checked="" type="checkbox"/> No			561	<input type="checkbox"/> Yes, <input checked="" type="checkbox"/> No		
512	<input type="checkbox"/> Yes, <input checked="" type="checkbox"/> No			562	<input type="checkbox"/> Yes, <input checked="" type="checkbox"/> No		
513	<input type="checkbox"/> Yes, <input checked="" type="checkbox"/> No		I	563	<input type="checkbox"/> Yes, <input checked="" type="checkbox"/> No		I
514	<input type="checkbox"/> Yes, <input checked="" type="checkbox"/> No			564	<input type="checkbox"/> Yes, <input checked="" type="checkbox"/> No		
515	<input type="checkbox"/> Yes, <input checked="" type="checkbox"/> No			565	<input type="checkbox"/> Yes, <input checked="" type="checkbox"/> No		
516	<input type="checkbox"/> Yes, <input checked="" type="checkbox"/> No			566	<input type="checkbox"/> Yes, <input checked="" type="checkbox"/> No		
517	<input type="checkbox"/> Yes, <input checked="" type="checkbox"/> No			567	<input type="checkbox"/> Yes, <input checked="" type="checkbox"/> No		
518	<input type="checkbox"/> Yes, <input checked="" type="checkbox"/> No			568	<input type="checkbox"/> Yes, <input checked="" type="checkbox"/> No		
519	<input type="checkbox"/> Yes, <input checked="" type="checkbox"/> No			569	<input type="checkbox"/> Yes, <input checked="" type="checkbox"/> No		
520	<input type="checkbox"/> Yes, <input checked="" type="checkbox"/> No			570	<input type="checkbox"/> Yes, <input checked="" type="checkbox"/> No		
521	<input type="checkbox"/> Yes, <input checked="" type="checkbox"/> No			571	<input type="checkbox"/> Yes, <input checked="" type="checkbox"/> No		
522	<input type="checkbox"/> Yes, <input checked="" type="checkbox"/> No			572	<input type="checkbox"/> Yes, <input checked="" type="checkbox"/> No		
523	<input type="checkbox"/> Yes, <input checked="" type="checkbox"/> No			573	<input type="checkbox"/> Yes, <input checked="" type="checkbox"/> No		
524	<input type="checkbox"/> Yes, <input checked="" type="checkbox"/> No			574	<input type="checkbox"/> Yes, <input checked="" type="checkbox"/> No		
525	<input type="checkbox"/> Yes, <input checked="" type="checkbox"/> No			575	<input type="checkbox"/> Yes, <input checked="" type="checkbox"/> No		
526	<input type="checkbox"/> Yes, <input checked="" type="checkbox"/> No			576	<input type="checkbox"/> Yes, <input checked="" type="checkbox"/> No		
527	<input type="checkbox"/> Yes, <input checked="" type="checkbox"/> No			577	<input type="checkbox"/> Yes, <input checked="" type="checkbox"/> No		
528	<input type="checkbox"/> Yes, <input checked="" type="checkbox"/> No			578	<input type="checkbox"/> Yes, <input checked="" type="checkbox"/> No		
529	<input type="checkbox"/> Yes, <input checked="" type="checkbox"/> No			579	<input type="checkbox"/> Yes, <input checked="" type="checkbox"/> No		
530	<input type="checkbox"/> Yes, <input checked="" type="checkbox"/> No			580	<input type="checkbox"/> Yes, <input checked="" type="checkbox"/> No		
531	<input type="checkbox"/> Yes, <input checked="" type="checkbox"/> No			581	<input type="checkbox"/> Yes, <input checked="" type="checkbox"/> No		
532	<input type="checkbox"/> Yes, <input checked="" type="checkbox"/> No			582	<input type="checkbox"/> Yes, <input checked="" type="checkbox"/> No		
533	<input type="checkbox"/> Yes, <input checked="" type="checkbox"/> No			583	<input type="checkbox"/> Yes, <input checked="" type="checkbox"/> No		
534	<input type="checkbox"/> Yes, <input checked="" type="checkbox"/> No			584	<input type="checkbox"/> Yes, <input checked="" type="checkbox"/> No		
535	<input type="checkbox"/> Yes, <input checked="" type="checkbox"/> No			585	<input type="checkbox"/> Yes, <input checked="" type="checkbox"/> No		
536	<input type="checkbox"/> Yes, <input checked="" type="checkbox"/> No			586	<input type="checkbox"/> Yes, <input checked="" type="checkbox"/> No		
537	<input type="checkbox"/> Yes, <input checked="" type="checkbox"/> No			587	<input type="checkbox"/> Yes, <input checked="" type="checkbox"/> No		
538	<input type="checkbox"/> Yes, <input checked="" type="checkbox"/> No			588	<input type="checkbox"/> Yes, <input checked="" type="checkbox"/> No		
539	<input type="checkbox"/> Yes, <input checked="" type="checkbox"/> No			589	<input type="checkbox"/> Yes, <input checked="" type="checkbox"/> No		
540	<input type="checkbox"/> Yes, <input checked="" type="checkbox"/> No			590	<input type="checkbox"/> Yes, <input checked="" type="checkbox"/> No		
541	<input type="checkbox"/> Yes, <input checked="" type="checkbox"/> No			591	<input type="checkbox"/> Yes, <input checked="" type="checkbox"/> No		
542	<input type="checkbox"/> Yes, <input checked="" type="checkbox"/> No			592	<input type="checkbox"/> Yes, <input checked="" type="checkbox"/> No		
543	<input type="checkbox"/> Yes, <input checked="" type="checkbox"/> No			593	<input type="checkbox"/> Yes, <input checked="" type="checkbox"/> No		
544	<input type="checkbox"/> Yes, <input checked="" type="checkbox"/> No			594	<input type="checkbox"/> Yes, <input checked="" type="checkbox"/> No		
545	<input type="checkbox"/> Yes, <input checked="" type="checkbox"/> No			595	<input type="checkbox"/> Yes, <input checked="" type="checkbox"/> No		
546	<input type="checkbox"/> Yes, <input checked="" type="checkbox"/> No			596	<input type="checkbox"/> Yes, <input checked="" type="checkbox"/> No		
547	<input type="checkbox"/> Yes, <input checked="" type="checkbox"/> No			597	<input type="checkbox"/> Yes, <input checked="" type="checkbox"/> No		
548	<input type="checkbox"/> Yes, <input checked="" type="checkbox"/> No			598	<input type="checkbox"/> Yes, <input checked="" type="checkbox"/> No		
549	<input type="checkbox"/> Yes, <input checked="" type="checkbox"/> No			599	<input type="checkbox"/> Yes, <input checked="" type="checkbox"/> No		

TOLL RESTRICTION-AREA/OFFICE CODE TABLE (5/8)

Area/Office Code Table No. 3

Code No.	Local Call Access	Restriction Level	Office Code	Code No.	Local Call Access	Restriction Level	Office Code
600	<input type="checkbox"/> Yes, <input type="checkbox"/> No			600	<input type="checkbox"/> Yes, <input type="checkbox"/> No		
601	<input type="checkbox"/> Yes, <input type="checkbox"/> No			601	<input type="checkbox"/> Yes, <input type="checkbox"/> No		
602	<input type="checkbox"/> Yes, <input type="checkbox"/> No			602	<input type="checkbox"/> Yes, <input type="checkbox"/> No		
603	<input type="checkbox"/> Yes, <input type="checkbox"/> No			603	<input type="checkbox"/> Yes, <input type="checkbox"/> No		
604	<input type="checkbox"/> Yes, <input type="checkbox"/> No			604	<input type="checkbox"/> Yes, <input type="checkbox"/> No		
605	<input type="checkbox"/> Yes, <input type="checkbox"/> No			605	<input type="checkbox"/> Yes, <input type="checkbox"/> No		
606	<input type="checkbox"/> Yes, <input type="checkbox"/> No			606	<input type="checkbox"/> Yes, <input type="checkbox"/> No		
607	<input type="checkbox"/> Yes, <input type="checkbox"/> No			607	<input type="checkbox"/> Yes, <input type="checkbox"/> No		
608	<input type="checkbox"/> Yes, <input type="checkbox"/> No			608	<input type="checkbox"/> Yes, <input type="checkbox"/> No		
609	<input type="checkbox"/> Yes, <input type="checkbox"/> No			609	<input type="checkbox"/> Yes, <input type="checkbox"/> No		
610	<input type="checkbox"/> Yes, <input type="checkbox"/> No			610	<input type="checkbox"/> Yes, <input type="checkbox"/> No		
611	<input type="checkbox"/> Yes, <input type="checkbox"/> No			611	<input type="checkbox"/> Yes, <input type="checkbox"/> No		
612	<input type="checkbox"/> Yes, <input type="checkbox"/> No			612	<input type="checkbox"/> Yes, <input type="checkbox"/> No		
613	<input type="checkbox"/> Yes, <input type="checkbox"/> No			613	<input type="checkbox"/> Yes, <input type="checkbox"/> No		
614	<input type="checkbox"/> Yes, <input type="checkbox"/> No			614	<input type="checkbox"/> Yes, <input type="checkbox"/> No		
615	<input type="checkbox"/> Yes, <input type="checkbox"/> No			615	<input type="checkbox"/> Yes, <input type="checkbox"/> No		
616	<input type="checkbox"/> Yes, <input type="checkbox"/> No			616	<input type="checkbox"/> Yes, <input type="checkbox"/> No		
617	<input type="checkbox"/> Yes, <input type="checkbox"/> No			617	<input type="checkbox"/> Yes, <input type="checkbox"/> No		
618	<input type="checkbox"/> Yes, <input type="checkbox"/> No			618	<input type="checkbox"/> Yes, <input type="checkbox"/> No		
619	<input type="checkbox"/> Yes, <input type="checkbox"/> No			619	<input type="checkbox"/> Yes, <input type="checkbox"/> No		
620	<input type="checkbox"/> Yes, <input type="checkbox"/> No			620	<input type="checkbox"/> Yes, <input type="checkbox"/> No		
621	<input type="checkbox"/> Yes, <input type="checkbox"/> No			621	<input type="checkbox"/> Yes, <input type="checkbox"/> No		
622	<input type="checkbox"/> Yes, <input type="checkbox"/> No			622	<input type="checkbox"/> Yes, <input type="checkbox"/> No		
623	<input type="checkbox"/> Yes, <input type="checkbox"/> No			623	<input type="checkbox"/> Yes, <input type="checkbox"/> No		
624	<input type="checkbox"/> Yes, <input type="checkbox"/> No			624	<input type="checkbox"/> Yes, <input type="checkbox"/> No		
625	<input type="checkbox"/> Yes, <input type="checkbox"/> No			625	<input type="checkbox"/> Yes, <input type="checkbox"/> No		
626	<input type="checkbox"/> Yes, <input type="checkbox"/> No			626	<input type="checkbox"/> Yes, <input type="checkbox"/> No		
627	<input type="checkbox"/> Yes, <input type="checkbox"/> No			627	<input type="checkbox"/> Yes, <input type="checkbox"/> No		
628	<input type="checkbox"/> Yes, <input type="checkbox"/> No			628	<input type="checkbox"/> Yes, <input type="checkbox"/> No		
629	<input type="checkbox"/> Yes, <input type="checkbox"/> No			629	<input type="checkbox"/> Yes, <input type="checkbox"/> No		
630	<input type="checkbox"/> Yes, <input type="checkbox"/> No			630	<input type="checkbox"/> Yes, <input type="checkbox"/> No		
631	<input type="checkbox"/> Yes, <input type="checkbox"/> No			631	<input type="checkbox"/> Yes, <input type="checkbox"/> No		
632	<input type="checkbox"/> Yes, <input type="checkbox"/> No			632	<input type="checkbox"/> Yes, <input type="checkbox"/> No		
633	<input type="checkbox"/> Yes, <input type="checkbox"/> No			633	<input type="checkbox"/> Yes, <input type="checkbox"/> No		
634	<input type="checkbox"/> Yes, <input type="checkbox"/> No			634	<input type="checkbox"/> Yes, <input type="checkbox"/> No		
635	<input type="checkbox"/> Yes, <input type="checkbox"/> No			635	<input type="checkbox"/> Yes, <input type="checkbox"/> No		
636	<input type="checkbox"/> Yes, <input type="checkbox"/> No			636	<input type="checkbox"/> Yes, <input type="checkbox"/> No		
637	<input type="checkbox"/> Yes, <input type="checkbox"/> No			637	<input type="checkbox"/> Yes, <input type="checkbox"/> No		
638	<input type="checkbox"/> Yes, <input type="checkbox"/> No			638	<input type="checkbox"/> Yes, <input type="checkbox"/> No		
639	<input type="checkbox"/> Yes, <input type="checkbox"/> No			639	<input type="checkbox"/> Yes, <input type="checkbox"/> No		
640	<input type="checkbox"/> Yes, <input type="checkbox"/> No			640	<input type="checkbox"/> Yes, <input type="checkbox"/> No		
641	<input type="checkbox"/> Yes, <input type="checkbox"/> No			641	<input type="checkbox"/> Yes, <input type="checkbox"/> No		
642	<input type="checkbox"/> Yes, <input type="checkbox"/> No			642	<input type="checkbox"/> Yes, <input type="checkbox"/> No		
643	<input type="checkbox"/> Yes, <input type="checkbox"/> No			643	<input type="checkbox"/> Yes, <input type="checkbox"/> No		
644	<input type="checkbox"/> Yes, <input type="checkbox"/> No			644	<input type="checkbox"/> Yes, <input type="checkbox"/> No		
645	<input type="checkbox"/> Yes, <input type="checkbox"/> No			645	<input type="checkbox"/> Yes, <input type="checkbox"/> No		
646	<input type="checkbox"/> Yes, <input type="checkbox"/> No			646	<input type="checkbox"/> Yes, <input type="checkbox"/> No		
647	<input type="checkbox"/> Yes, <input type="checkbox"/> No			647	<input type="checkbox"/> Yes, <input type="checkbox"/> No		
648	<input type="checkbox"/> Yes, <input type="checkbox"/> No			648	<input type="checkbox"/> Yes, <input type="checkbox"/> No		
649	<input type="checkbox"/> Yes, <input type="checkbox"/> No			649	<input type="checkbox"/> Yes, <input type="checkbox"/> No		

TOLL RESTRICTION-AREA/OFFICE CODE TABLE (6/8)

Area/Office Code Table No. 3

Code No.	Local Call Access	Restriction Level	Office Code		Code No.	Local Call Access	Restriction Level	Office Code
700	<input type="checkbox"/> Yes, <input type="checkbox"/> No				750	<input type="checkbox"/> Yes, <input type="checkbox"/> No		
701	<input type="checkbox"/> Yes, <input type="checkbox"/> No				751	<input type="checkbox"/> Yes, <input type="checkbox"/> No		
702	<input type="checkbox"/> Yes, <input type="checkbox"/> No				752	<input type="checkbox"/> Yes, <input type="checkbox"/> No		
703	<input type="checkbox"/> Yes, <input type="checkbox"/> No				753	<input type="checkbox"/> Yes, <input type="checkbox"/> No		
704	<input type="checkbox"/> Yes, <input type="checkbox"/> No				754	<input type="checkbox"/> Yes, <input type="checkbox"/> No		
705	<input type="checkbox"/> Yes, <input type="checkbox"/> No				755	<input type="checkbox"/> Yes, <input type="checkbox"/> No		
706	<input type="checkbox"/> Yes, <input type="checkbox"/> No				756	<input type="checkbox"/> Yes, <input type="checkbox"/> No		
707	<input type="checkbox"/> Yes, <input type="checkbox"/> No				757	<input type="checkbox"/> Yes, <input type="checkbox"/> No		
708	<input type="checkbox"/> Yes, <input type="checkbox"/> No				758	<input type="checkbox"/> Yes, <input type="checkbox"/> No		
709	<input type="checkbox"/> Yes, <input type="checkbox"/> No				759	<input type="checkbox"/> Yes, <input type="checkbox"/> No		
710	<input type="checkbox"/> Yes, <input type="checkbox"/> No				760	<input type="checkbox"/> Yes, <input type="checkbox"/> No		
711	<input type="checkbox"/> Yes, <input type="checkbox"/> No				761	<input type="checkbox"/> Yes, <input type="checkbox"/> No		
712	<input type="checkbox"/> Yes, <input type="checkbox"/> No				762	<input type="checkbox"/> Yes, <input type="checkbox"/> No		
713	<input type="checkbox"/> Yes, <input type="checkbox"/> No				763	<input type="checkbox"/> Yes, <input type="checkbox"/> No		
714	<input type="checkbox"/> Yes, <input type="checkbox"/> No				764	<input type="checkbox"/> Yes, <input type="checkbox"/> No		
715	<input type="checkbox"/> Yes, <input type="checkbox"/> No				765	<input type="checkbox"/> Yes, <input type="checkbox"/> No		
716	<input type="checkbox"/> Yes, <input type="checkbox"/> No				766	<input type="checkbox"/> Yes, <input type="checkbox"/> No		
717	<input type="checkbox"/> Yes, <input type="checkbox"/> No				767	<input type="checkbox"/> Yes, <input type="checkbox"/> No		
718	<input type="checkbox"/> Yes, <input type="checkbox"/> No				768	<input type="checkbox"/> Yes, <input type="checkbox"/> No		
719	<input type="checkbox"/> Yes, <input type="checkbox"/> No				769	<input type="checkbox"/> Yes, <input type="checkbox"/> No		
720	<input type="checkbox"/> Yes, <input type="checkbox"/> No				770	<input type="checkbox"/> Yes, <input type="checkbox"/> No		
721	<input type="checkbox"/> Yes, <input type="checkbox"/> No				771	<input type="checkbox"/> Yes, <input type="checkbox"/> No		
722	<input type="checkbox"/> Yes, <input type="checkbox"/> No				772	<input type="checkbox"/> Yes, <input type="checkbox"/> No		
723	<input type="checkbox"/> Yes, <input type="checkbox"/> No				773	<input type="checkbox"/> Yes, <input type="checkbox"/> No		
724	<input type="checkbox"/> Yes, <input type="checkbox"/> No				774	<input type="checkbox"/> Yes, <input type="checkbox"/> No		
725	<input type="checkbox"/> Yes, <input type="checkbox"/> No				775	<input type="checkbox"/> Yes, <input type="checkbox"/> No		
726	<input type="checkbox"/> Yes, <input type="checkbox"/> No				776	<input type="checkbox"/> Yes, <input type="checkbox"/> No		
727	<input type="checkbox"/> Yes, <input type="checkbox"/> No				777	<input type="checkbox"/> Yes, <input type="checkbox"/> No		
728	<input type="checkbox"/> Yes, <input type="checkbox"/> No				778	<input type="checkbox"/> Yes, <input type="checkbox"/> No		
729	<input type="checkbox"/> Yes, <input type="checkbox"/> No				779	<input type="checkbox"/> Yes, <input type="checkbox"/> No		
730	<input type="checkbox"/> Yes, <input type="checkbox"/> No				780	<input type="checkbox"/> Yes, <input type="checkbox"/> No		
731	<input type="checkbox"/> Yes, <input type="checkbox"/> No				781	<input type="checkbox"/> Yes, <input type="checkbox"/> No		
732	<input type="checkbox"/> Yes, <input type="checkbox"/> No				782	<input type="checkbox"/> Yes, <input type="checkbox"/> No		
733	<input type="checkbox"/> Yes, <input type="checkbox"/> No				783	<input type="checkbox"/> Yes, <input type="checkbox"/> No		
734	<input type="checkbox"/> Yes, <input type="checkbox"/> No				784	<input type="checkbox"/> Yes, <input type="checkbox"/> No		
735	<input type="checkbox"/> Yes, <input type="checkbox"/> No				785	<input type="checkbox"/> Yes, <input type="checkbox"/> No		
736	<input type="checkbox"/> Yes, <input type="checkbox"/> No				786	<input type="checkbox"/> Yes, <input type="checkbox"/> No		
737	<input type="checkbox"/> Yes, <input type="checkbox"/> No				787	<input type="checkbox"/> Yes, <input type="checkbox"/> No		
738	<input type="checkbox"/> Yes, <input type="checkbox"/> No				788	<input type="checkbox"/> Yes, <input type="checkbox"/> No		
739	<input type="checkbox"/> Yes, <input type="checkbox"/> No				789	<input type="checkbox"/> Yes, <input type="checkbox"/> No		
740	<input type="checkbox"/> Yes, <input type="checkbox"/> No				790	<input type="checkbox"/> Yes, <input type="checkbox"/> No		
741	<input type="checkbox"/> Yes, <input type="checkbox"/> No				791	<input type="checkbox"/> Yes, <input type="checkbox"/> No		
742	<input type="checkbox"/> Yes, <input type="checkbox"/> No				792	<input type="checkbox"/> Yes, <input type="checkbox"/> No		
743	<input type="checkbox"/> Yes, <input type="checkbox"/> No				793	<input type="checkbox"/> Yes, <input type="checkbox"/> No		
744	<input type="checkbox"/> Yes, <input type="checkbox"/> No				794	<input type="checkbox"/> Yes, <input type="checkbox"/> No		
745	<input type="checkbox"/> Yes, <input type="checkbox"/> No				795	<input type="checkbox"/> Yes, <input type="checkbox"/> No		
746	<input type="checkbox"/> Yes, <input type="checkbox"/> No				796	<input type="checkbox"/> Yes, <input type="checkbox"/> No		
747	<input type="checkbox"/> Yes, <input type="checkbox"/> No				797	<input type="checkbox"/> Yes, <input type="checkbox"/> No		
748	<input type="checkbox"/> Yes, <input type="checkbox"/> No				798	<input type="checkbox"/> Yes, <input type="checkbox"/> No		
749	<input type="checkbox"/> Yes, <input type="checkbox"/> No				799	<input type="checkbox"/> Yes, <input type="checkbox"/> No		

TOLL RESTRICTION-AREA/OFFICE CODE TABLE (718)

Area Office Code Table No. 3

Code No.	Local Call Access	Restriction Level	Office Code	Code No.	Local Call Access	Restriction Level	Office Code
800	<input type="checkbox"/> Yes, <input type="checkbox"/> No			850	<input type="checkbox"/> Yes, <input type="checkbox"/> No		
801	<input type="checkbox"/> Yes, <input type="checkbox"/> No			851	<input type="checkbox"/> Yes, <input type="checkbox"/> No		
802	<input type="checkbox"/> Yes, <input type="checkbox"/> No			852	<input type="checkbox"/> Yes, <input type="checkbox"/> No		
803	<input type="checkbox"/> Yes, <input type="checkbox"/> No			853	<input type="checkbox"/> Yes, <input type="checkbox"/> No		
804	<input type="checkbox"/> Yes, <input type="checkbox"/> No			854	<input type="checkbox"/> Yes, <input type="checkbox"/> No		
805	<input type="checkbox"/> Yes, <input type="checkbox"/> No			855	<input type="checkbox"/> Yes, <input type="checkbox"/> No		
806	<input type="checkbox"/> Yes, <input type="checkbox"/> No			856	<input type="checkbox"/> Yes, <input type="checkbox"/> No		
807	<input type="checkbox"/> Yes, <input type="checkbox"/> No			857	<input type="checkbox"/> Yes, <input type="checkbox"/> No		
808	<input type="checkbox"/> Yes, <input type="checkbox"/> No			858	<input type="checkbox"/> Yes, <input type="checkbox"/> No		
809	<input type="checkbox"/> Yes, <input type="checkbox"/> No			859	<input type="checkbox"/> Yes, <input type="checkbox"/> No		
810	<input type="checkbox"/> Yes, <input type="checkbox"/> No			860	<input type="checkbox"/> Yes, <input type="checkbox"/> No		
811	<input type="checkbox"/> Yes, <input type="checkbox"/> No			861	<input type="checkbox"/> Yes, <input type="checkbox"/> No		
812	<input type="checkbox"/> Yes, <input type="checkbox"/> No			862	<input type="checkbox"/> Yes, <input type="checkbox"/> No		
813	<input type="checkbox"/> Yes, <input type="checkbox"/> No			863	<input type="checkbox"/> Yes, <input type="checkbox"/> No		
814	<input type="checkbox"/> Yes, <input type="checkbox"/> No			864	<input type="checkbox"/> Yes, <input type="checkbox"/> No		
815	<input type="checkbox"/> Yes, <input type="checkbox"/> No			865	<input type="checkbox"/> Yes, <input type="checkbox"/> No		
816	<input type="checkbox"/> Yes, <input type="checkbox"/> No			866	<input type="checkbox"/> Yes, <input type="checkbox"/> No		
817	<input type="checkbox"/> Yes, <input type="checkbox"/> No			867	<input type="checkbox"/> Yes, <input type="checkbox"/> No		
818	<input type="checkbox"/> Yes, <input type="checkbox"/> No			868	<input type="checkbox"/> Yes, <input type="checkbox"/> No		
819	<input type="checkbox"/> Yes, <input type="checkbox"/> No			869	<input type="checkbox"/> Yes, <input type="checkbox"/> No		
820	<input type="checkbox"/> Yes, <input type="checkbox"/> No			870	<input type="checkbox"/> Yes, <input type="checkbox"/> No		
821	<input type="checkbox"/> Yes, <input type="checkbox"/> No			871	<input type="checkbox"/> Yes, <input type="checkbox"/> No		
822	<input type="checkbox"/> Yes, <input type="checkbox"/> No			872	<input type="checkbox"/> Yes, <input type="checkbox"/> No		
823	<input type="checkbox"/> Yes, <input type="checkbox"/> No			873	<input type="checkbox"/> Yes, <input type="checkbox"/> No		
824	<input type="checkbox"/> Yes, <input type="checkbox"/> No			874	<input type="checkbox"/> Yes, <input type="checkbox"/> No		
825	<input type="checkbox"/> Yes, <input type="checkbox"/> No			875	<input type="checkbox"/> Yes, <input type="checkbox"/> No		
826	<input type="checkbox"/> Yes, <input type="checkbox"/> No			876	<input type="checkbox"/> Yes, <input type="checkbox"/> No		
827	<input type="checkbox"/> Yes, <input type="checkbox"/> No			877	<input type="checkbox"/> Yes, <input type="checkbox"/> No		
828	<input type="checkbox"/> Yes, <input type="checkbox"/> No			878	<input type="checkbox"/> Yes, <input type="checkbox"/> No		
829	<input type="checkbox"/> Yes, <input type="checkbox"/> No			879	<input type="checkbox"/> Yes, <input type="checkbox"/> No		
830	<input type="checkbox"/> Yes, <input type="checkbox"/> No			880	<input type="checkbox"/> Yes, <input type="checkbox"/> No		
831	<input type="checkbox"/> Yes, <input type="checkbox"/> No			881	<input type="checkbox"/> Yes, <input type="checkbox"/> No		
832	<input type="checkbox"/> Yes, <input type="checkbox"/> No			882	<input type="checkbox"/> Yes, <input type="checkbox"/> No		
833	<input type="checkbox"/> Yes, <input type="checkbox"/> No			883	<input type="checkbox"/> Yes, <input type="checkbox"/> No		
834	<input type="checkbox"/> Yes, <input type="checkbox"/> No			884	<input type="checkbox"/> Yes, <input type="checkbox"/> No		
835	<input type="checkbox"/> Yes, <input type="checkbox"/> No			885	<input type="checkbox"/> Yes, <input type="checkbox"/> No		
836	<input type="checkbox"/> Yes, <input type="checkbox"/> No			886	<input type="checkbox"/> Yes, <input type="checkbox"/> No		
837	<input type="checkbox"/> Yes, <input type="checkbox"/> No			887	<input type="checkbox"/> Yes, <input type="checkbox"/> No		
838	<input type="checkbox"/> Yes, <input type="checkbox"/> No			888	<input type="checkbox"/> Yes, <input type="checkbox"/> No		
839	<input type="checkbox"/> Yes, <input type="checkbox"/> No			889	<input type="checkbox"/> Yes, <input type="checkbox"/> No		
840	<input type="checkbox"/> Yes, <input type="checkbox"/> No			890	<input type="checkbox"/> Yes, <input type="checkbox"/> No		
841	<input type="checkbox"/> Yes, <input type="checkbox"/> No			891	<input type="checkbox"/> Yes, <input type="checkbox"/> No		
842	<input type="checkbox"/> Yes, <input type="checkbox"/> No			892	<input type="checkbox"/> Yes, <input type="checkbox"/> No		
843	<input type="checkbox"/> Yes, <input type="checkbox"/> No			893	<input type="checkbox"/> Yes, <input type="checkbox"/> No		
844	<input type="checkbox"/> Yes, <input type="checkbox"/> No			894	<input type="checkbox"/> Yes, <input type="checkbox"/> No		
845	<input type="checkbox"/> Yes, <input type="checkbox"/> No			895	<input type="checkbox"/> Yes, <input type="checkbox"/> No		
846	<input type="checkbox"/> Yes, <input type="checkbox"/> No			896	<input type="checkbox"/> Yes, <input type="checkbox"/> No		
847	<input type="checkbox"/> Yes, <input type="checkbox"/> No			897	<input type="checkbox"/> Yes, <input type="checkbox"/> No		
848	<input type="checkbox"/> Yes, <input type="checkbox"/> No			898	<input type="checkbox"/> Yes, <input type="checkbox"/> No		
849	<input type="checkbox"/> Yes, <input type="checkbox"/> No			899	<input type="checkbox"/> Yes, <input type="checkbox"/> No		

TOLL RESTRICTION-AREA/OFFICE CODE TABLE (8/8)

Area/Office Code Table No. 3

Code No.	Local Call Access	Restriction Level	Office Code	Code No.	Local Call Access	Restriction Level	Office Code
900	<input type="checkbox"/> Yes, <input type="checkbox"/> No			950	<input type="checkbox"/> Yes, <input type="checkbox"/> No		
901	<input type="checkbox"/> Yes, <input type="checkbox"/> No			951	<input type="checkbox"/> Yes, <input type="checkbox"/> No		
902	<input type="checkbox"/> Yes, <input type="checkbox"/> No			952	<input type="checkbox"/> Yes, <input type="checkbox"/> No		
903	<input type="checkbox"/> Yes, <input type="checkbox"/> No			953	<input type="checkbox"/> Yes, <input type="checkbox"/> No		
904	<input type="checkbox"/> Yes, <input type="checkbox"/> No			954	<input type="checkbox"/> Yes, <input type="checkbox"/> No		
905	<input type="checkbox"/> Yes, <input type="checkbox"/> No			955	<input type="checkbox"/> Yes, <input type="checkbox"/> No		
906	<input type="checkbox"/> Yes, <input type="checkbox"/> No			956	<input type="checkbox"/> Yes, <input type="checkbox"/> No		
907	<input type="checkbox"/> Yes, <input type="checkbox"/> No			957	<input type="checkbox"/> Yes, <input type="checkbox"/> No		
908	<input type="checkbox"/> Yes, <input type="checkbox"/> No			958	<input type="checkbox"/> Yes, <input type="checkbox"/> No		
909	<input type="checkbox"/> Yes, <input type="checkbox"/> No			959	<input type="checkbox"/> Yes, <input type="checkbox"/> No		
910	<input type="checkbox"/> Yes, <input type="checkbox"/> No			960	<input type="checkbox"/> Yes, <input type="checkbox"/> No		
911	<input type="checkbox"/> Yes, <input type="checkbox"/> No			961	<input type="checkbox"/> Yes, <input type="checkbox"/> No		
912	<input type="checkbox"/> Yes, <input type="checkbox"/> No			962	<input type="checkbox"/> Yes, <input type="checkbox"/> No		
913	<input type="checkbox"/> Yes, <input type="checkbox"/> No			963	<input type="checkbox"/> Yes, <input type="checkbox"/> No		
914	<input type="checkbox"/> Yes, <input type="checkbox"/> No			964	<input type="checkbox"/> Yes, <input type="checkbox"/> No		
915	<input type="checkbox"/> Yes, <input type="checkbox"/> No			965	<input type="checkbox"/> Yes, <input type="checkbox"/> No		
916	<input type="checkbox"/> Yes, <input type="checkbox"/> No			966	<input type="checkbox"/> Yes, <input type="checkbox"/> No		
917	<input type="checkbox"/> Yes, <input type="checkbox"/> No			967	<input type="checkbox"/> Yes, <input type="checkbox"/> No		
918	<input type="checkbox"/> Yes, <input type="checkbox"/> No			968	<input type="checkbox"/> Yes, <input type="checkbox"/> No		
919	<input type="checkbox"/> Yes, <input type="checkbox"/> No			969	<input type="checkbox"/> Yes, <input type="checkbox"/> No		
920	<input type="checkbox"/> Yes, <input type="checkbox"/> No			970	<input type="checkbox"/> Yes, <input type="checkbox"/> No		
921	<input type="checkbox"/> Yes, <input type="checkbox"/> No			971	<input type="checkbox"/> Yes, <input type="checkbox"/> No		
922	<input type="checkbox"/> Yes, <input type="checkbox"/> No			972	<input type="checkbox"/> Yes, <input type="checkbox"/> No		
923	<input type="checkbox"/> Yes, <input type="checkbox"/> No			973	<input type="checkbox"/> Yes, <input type="checkbox"/> No		
924	<input type="checkbox"/> Yes, <input type="checkbox"/> No			974	<input type="checkbox"/> Yes, <input type="checkbox"/> No		
925	<input type="checkbox"/> Yes, <input type="checkbox"/> No			975	<input type="checkbox"/> Yes, <input type="checkbox"/> No		
926	<input type="checkbox"/> Yes, <input type="checkbox"/> No			976	<input type="checkbox"/> Yes, <input type="checkbox"/> No		
927	<input type="checkbox"/> Yes, <input type="checkbox"/> No			977	<input type="checkbox"/> Yes, <input type="checkbox"/> No		
928	<input type="checkbox"/> Yes, <input type="checkbox"/> No			978	<input type="checkbox"/> Yes, <input type="checkbox"/> No		
929	<input type="checkbox"/> Yes, <input type="checkbox"/> No			979	<input type="checkbox"/> Yes, <input type="checkbox"/> No		
930	<input type="checkbox"/> Yes, <input type="checkbox"/> No			980	<input type="checkbox"/> Yes, <input type="checkbox"/> No		
931	<input type="checkbox"/> Yes, <input type="checkbox"/> No			981	<input type="checkbox"/> Yes, <input type="checkbox"/> No		
932	<input type="checkbox"/> Yes, <input type="checkbox"/> No			982	<input type="checkbox"/> Yes, <input type="checkbox"/> No		
933	<input type="checkbox"/> Yes, <input type="checkbox"/> No			983	<input type="checkbox"/> Yes, <input type="checkbox"/> No		
934	<input type="checkbox"/> Yes, <input type="checkbox"/> No			984	<input type="checkbox"/> Yes, <input type="checkbox"/> No		
935	<input type="checkbox"/> Yes, <input type="checkbox"/> No			985	<input type="checkbox"/> Yes, <input type="checkbox"/> No		
936	<input type="checkbox"/> Yes, <input type="checkbox"/> No			986	<input type="checkbox"/> Yes, <input type="checkbox"/> No		
937	<input type="checkbox"/> Yes, <input type="checkbox"/> No			987	<input type="checkbox"/> Yes, <input type="checkbox"/> No		
938	<input type="checkbox"/> Yes, <input type="checkbox"/> No			988	<input type="checkbox"/> Yes, <input type="checkbox"/> No		
939	<input type="checkbox"/> Yes, <input type="checkbox"/> No			989	<input type="checkbox"/> Yes, <input type="checkbox"/> No		
940	<input type="checkbox"/> Yes, <input type="checkbox"/> No			990	<input type="checkbox"/> Yes, <input type="checkbox"/> No		
941	<input type="checkbox"/> Yes, <input type="checkbox"/> No			991	<input type="checkbox"/> Yes, <input type="checkbox"/> No		
942	<input type="checkbox"/> Yes, <input type="checkbox"/> No			992	<input type="checkbox"/> Yes, <input type="checkbox"/> No		
943	<input type="checkbox"/> Yes, <input type="checkbox"/> No			993	<input type="checkbox"/> Yes, <input type="checkbox"/> No		
944	<input type="checkbox"/> Yes, <input type="checkbox"/> No			994	<input type="checkbox"/> Yes, <input type="checkbox"/> No		
946	<input type="checkbox"/> Yes, <input type="checkbox"/> No			996	<input type="checkbox"/> Yes, <input type="checkbox"/> No		
947	<input type="checkbox"/> Yes, <input type="checkbox"/> No			997	<input type="checkbox"/> Yes, <input type="checkbox"/> No		
	<input type="checkbox"/> Yes, <input type="checkbox"/> No				<input type="checkbox"/> Yes, <input type="checkbox"/> No		
	<input type="checkbox"/> Yes, <input type="checkbox"/> No				<input type="checkbox"/> Yes, <input type="checkbox"/> No		

TOLL RESTRICTION-AREA/OFFICE CODE TABLE (1/8)

Area/Office Code Table No. 4

Code No.	Local Call Access	Restriction Level	Office Code	Code No.	Local Call Access	Restriction Level	Office Code
200	<input type="checkbox"/> Yes, <input type="checkbox"/> No			250	<input type="checkbox"/> Yes, <input type="checkbox"/> No		
201	<input type="checkbox"/> Yes, <input type="checkbox"/> No			251	<input type="checkbox"/> Yes, <input type="checkbox"/> No		
202	<input type="checkbox"/> Yes, <input type="checkbox"/> No			252	<input type="checkbox"/> Yes, <input type="checkbox"/> No		
203	<input type="checkbox"/> Yes, <input type="checkbox"/> No			253	<input type="checkbox"/> Yes, <input type="checkbox"/> No		
204	<input type="checkbox"/> Yes, <input type="checkbox"/> No			254	<input type="checkbox"/> Yes, <input type="checkbox"/> No		
205	<input type="checkbox"/> Yes, <input type="checkbox"/> No			255	<input type="checkbox"/> Yes, <input type="checkbox"/> No		
206	<input type="checkbox"/> Yes, <input type="checkbox"/> No			256	<input type="checkbox"/> Yes, <input type="checkbox"/> No		
207	<input type="checkbox"/> Yes, <input type="checkbox"/> No			257	<input type="checkbox"/> Yes, <input type="checkbox"/> No		
208	<input type="checkbox"/> Yes, <input type="checkbox"/> No			258	<input type="checkbox"/> Yes, <input type="checkbox"/> No		
209	<input type="checkbox"/> Yes, <input type="checkbox"/> No			259	<input type="checkbox"/> Yes, <input type="checkbox"/> No		
210	<input type="checkbox"/> Yes, <input type="checkbox"/> No			260	<input type="checkbox"/> Yes, <input type="checkbox"/> No		
211	<input type="checkbox"/> Yes, <input type="checkbox"/> No			261	<input type="checkbox"/> Yes, <input type="checkbox"/> No		
212	<input type="checkbox"/> Yes, <input type="checkbox"/> No			262	<input type="checkbox"/> Yes, <input type="checkbox"/> No		
213	<input type="checkbox"/> Yes, <input type="checkbox"/> No			263	<input type="checkbox"/> Yes, <input type="checkbox"/> No		
214	<input type="checkbox"/> Yes, <input type="checkbox"/> No			264	<input type="checkbox"/> Yes, <input type="checkbox"/> No		
215	<input type="checkbox"/> Yes, <input type="checkbox"/> No			265	<input type="checkbox"/> Yes, <input type="checkbox"/> No		
216	<input type="checkbox"/> Yes, <input type="checkbox"/> No			266	<input type="checkbox"/> Yes, <input type="checkbox"/> No		
217	<input type="checkbox"/> Yes, <input type="checkbox"/> No			267	<input type="checkbox"/> Yes, <input type="checkbox"/> No		
218	<input type="checkbox"/> Yes, <input type="checkbox"/> No			268	<input type="checkbox"/> Yes, <input type="checkbox"/> No		
219	<input type="checkbox"/> Yes, <input type="checkbox"/> No			269	<input type="checkbox"/> Yes, <input type="checkbox"/> No		
220	<input type="checkbox"/> Yes, <input type="checkbox"/> No			270	<input type="checkbox"/> Yes, <input type="checkbox"/> No		
221	<input type="checkbox"/> Yes, <input type="checkbox"/> No			271	<input type="checkbox"/> Yes, <input type="checkbox"/> No		
222	<input type="checkbox"/> Yes, <input type="checkbox"/> No			272	<input type="checkbox"/> Yes, <input type="checkbox"/> No		
223	<input type="checkbox"/> Yes, <input type="checkbox"/> No			273	<input type="checkbox"/> Yes, <input type="checkbox"/> No		
224	<input type="checkbox"/> Yes, <input type="checkbox"/> No			274	<input type="checkbox"/> Yes, <input type="checkbox"/> No		
225	<input type="checkbox"/> Yes, <input type="checkbox"/> No			275	<input type="checkbox"/> Yes, <input type="checkbox"/> No		
226	<input type="checkbox"/> Yes, <input type="checkbox"/> No			276	<input type="checkbox"/> Yes, <input type="checkbox"/> No		
227	<input type="checkbox"/> Yes, <input type="checkbox"/> No			277	<input type="checkbox"/> Yes, <input type="checkbox"/> No		
228	<input type="checkbox"/> Yes, <input type="checkbox"/> No			278	<input type="checkbox"/> Yes, <input type="checkbox"/> No		
229	<input type="checkbox"/> Yes, <input type="checkbox"/> No			279	<input type="checkbox"/> Yes, <input type="checkbox"/> No		
230	<input type="checkbox"/> Yes, <input type="checkbox"/> No			280	<input type="checkbox"/> Yes, <input type="checkbox"/> No		
231	<input type="checkbox"/> Yes, <input type="checkbox"/> No			281	<input type="checkbox"/> Yes, <input type="checkbox"/> No		
232	<input type="checkbox"/> Yes, <input type="checkbox"/> No			282	<input type="checkbox"/> Yes, <input type="checkbox"/> No		
233	<input type="checkbox"/> Yes, <input type="checkbox"/> No			283	<input type="checkbox"/> Yes, <input type="checkbox"/> No		
234	<input type="checkbox"/> Yes, <input type="checkbox"/> No			284	<input type="checkbox"/> Yes, <input type="checkbox"/> No		
235	<input type="checkbox"/> Yes, <input type="checkbox"/> No			285	<input type="checkbox"/> Yes, <input type="checkbox"/> No		
236	<input type="checkbox"/> Yes, <input type="checkbox"/> No			286	<input type="checkbox"/> Yes, <input type="checkbox"/> No		
237	<input type="checkbox"/> Yes, <input type="checkbox"/> No			287	<input type="checkbox"/> Yes, <input type="checkbox"/> No		
238	<input type="checkbox"/> Yes, <input type="checkbox"/> No			288	<input type="checkbox"/> Yes, <input type="checkbox"/> No		
239	<input type="checkbox"/> Yes, <input type="checkbox"/> No			289	<input type="checkbox"/> Yes, <input type="checkbox"/> No		
240	<input type="checkbox"/> Yes, <input type="checkbox"/> No			290	<input type="checkbox"/> Yes, <input type="checkbox"/> No		
241	<input type="checkbox"/> Yes, <input type="checkbox"/> No			291	<input type="checkbox"/> Yes, <input type="checkbox"/> No		
242	<input type="checkbox"/> Yes, <input type="checkbox"/> No			292	<input type="checkbox"/> Yes, <input type="checkbox"/> No		
243	<input type="checkbox"/> Yes, <input type="checkbox"/> No			293	<input type="checkbox"/> Yes, <input type="checkbox"/> No		
244	<input type="checkbox"/> Yes, <input type="checkbox"/> No			294	<input type="checkbox"/> Yes, <input type="checkbox"/> No		
245	<input type="checkbox"/> Yes, <input type="checkbox"/> No			295	<input type="checkbox"/> Yes, <input type="checkbox"/> No		
246	<input type="checkbox"/> Yes, <input type="checkbox"/> No			296	<input type="checkbox"/> Yes, <input type="checkbox"/> No		
247	<input type="checkbox"/> Yes, <input type="checkbox"/> No				<input type="checkbox"/> Yes, <input type="checkbox"/> No		
248	<input type="checkbox"/> Yes, <input type="checkbox"/> No				<input type="checkbox"/> Yes, <input type="checkbox"/> No		
	<input type="checkbox"/> Yes, <input type="checkbox"/> No				<input type="checkbox"/> Yes, <input type="checkbox"/> No		

TOLL RESTRICTION-AREA/OFFICE CODE TABLE (218)

Area/Office Code Table No. 4

Code No.	Local Call Access	Restriction Level	Office Code	Code No.	Local Call Access	Restriction Level	Office Code
300	<input type="checkbox"/> Yes, <input type="checkbox"/> No			350	<input type="checkbox"/> Yes, <input type="checkbox"/> No		
301	<input type="checkbox"/> Yes, <input type="checkbox"/> No			351	<input type="checkbox"/> Yes, <input type="checkbox"/> No		
302	<input type="checkbox"/> Yes, <input type="checkbox"/> No			352	<input type="checkbox"/> Yes, <input type="checkbox"/> No		
303	<input type="checkbox"/> Yes, <input type="checkbox"/> No			353	<input type="checkbox"/> Yes, <input type="checkbox"/> No		
304	<input type="checkbox"/> Yes, <input type="checkbox"/> No			354	<input type="checkbox"/> Yes, <input type="checkbox"/> No		
305	<input type="checkbox"/> Yes, <input type="checkbox"/> No			355	<input type="checkbox"/> Yes, <input type="checkbox"/> No		
306	<input type="checkbox"/> Yes, <input type="checkbox"/> No			356	<input type="checkbox"/> Yes, <input type="checkbox"/> No		
307	<input type="checkbox"/> Yes, <input type="checkbox"/> No			357	<input type="checkbox"/> Yes, <input type="checkbox"/> No		
308	<input type="checkbox"/> Yes, <input type="checkbox"/> No			358	<input type="checkbox"/> Yes, <input type="checkbox"/> No		
309	<input type="checkbox"/> Yes, <input type="checkbox"/> No			359	<input type="checkbox"/> Yes, <input type="checkbox"/> No		
310	<input type="checkbox"/> Yes, <input type="checkbox"/> No			360	<input type="checkbox"/> Yes, <input type="checkbox"/> No		
311	<input type="checkbox"/> Yes, <input type="checkbox"/> No			361	<input type="checkbox"/> Yes, <input type="checkbox"/> No		
312	<input type="checkbox"/> Yes, <input type="checkbox"/> No			362	<input type="checkbox"/> Yes, <input type="checkbox"/> No		
313	<input type="checkbox"/> Yes, <input type="checkbox"/> No			363	<input type="checkbox"/> Yes, <input type="checkbox"/> No		
314	<input type="checkbox"/> Yes, <input type="checkbox"/> No			364	<input type="checkbox"/> Yes, <input type="checkbox"/> No		
315	<input type="checkbox"/> Yes, <input type="checkbox"/> No			365	<input type="checkbox"/> Yes, <input type="checkbox"/> No		
316	<input type="checkbox"/> Yes, <input type="checkbox"/> No			366	<input type="checkbox"/> Yes, <input type="checkbox"/> No		
317	<input type="checkbox"/> Yes, <input type="checkbox"/> No			367	<input type="checkbox"/> Yes, <input type="checkbox"/> No		
318	<input type="checkbox"/> Yes, <input type="checkbox"/> No			368	<input type="checkbox"/> Yes, <input type="checkbox"/> No		
319	<input type="checkbox"/> Yes, <input type="checkbox"/> No			369	<input type="checkbox"/> Yes, <input type="checkbox"/> No		
320	<input type="checkbox"/> Yes, <input type="checkbox"/> No			370	<input type="checkbox"/> Yes, <input type="checkbox"/> No		
321	<input type="checkbox"/> Yes, <input type="checkbox"/> No			371	<input type="checkbox"/> Yes, <input type="checkbox"/> No		
322	<input type="checkbox"/> Yes, <input type="checkbox"/> No			372	<input type="checkbox"/> Yes, <input type="checkbox"/> No		
323	<input type="checkbox"/> Yes, <input type="checkbox"/> No			373	<input type="checkbox"/> Yes, <input type="checkbox"/> No		
324	<input type="checkbox"/> Yes, <input type="checkbox"/> No			374	<input type="checkbox"/> Yes, <input type="checkbox"/> No		
325	<input type="checkbox"/> Yes, <input type="checkbox"/> No			375	<input type="checkbox"/> Yes, <input type="checkbox"/> No		
326	<input type="checkbox"/> Yes, <input type="checkbox"/> No			376	<input type="checkbox"/> Yes, <input type="checkbox"/> No		
327	<input type="checkbox"/> Yes, <input type="checkbox"/> No			377	<input type="checkbox"/> Yes, <input type="checkbox"/> No		
328	<input type="checkbox"/> Yes, <input type="checkbox"/> No			378	<input type="checkbox"/> Yes, <input type="checkbox"/> No		
329	<input type="checkbox"/> Yes, <input type="checkbox"/> No			379	<input type="checkbox"/> Yes, <input type="checkbox"/> No		
330	<input type="checkbox"/> Yes, <input type="checkbox"/> No			380	<input type="checkbox"/> Yes, <input type="checkbox"/> No		
331	<input type="checkbox"/> Yes, <input type="checkbox"/> No			381	<input type="checkbox"/> Yes, <input type="checkbox"/> No		
332	<input type="checkbox"/> Yes, <input type="checkbox"/> No			382	<input type="checkbox"/> Yes, <input type="checkbox"/> No		
333	<input type="checkbox"/> Yes, <input type="checkbox"/> No			383	<input type="checkbox"/> Yes, <input type="checkbox"/> No		
334	<input type="checkbox"/> Yes, <input type="checkbox"/> No			384	<input type="checkbox"/> Yes, <input type="checkbox"/> No		
335	<input type="checkbox"/> Yes, <input type="checkbox"/> No			385	<input type="checkbox"/> Yes, <input type="checkbox"/> No		
336	<input type="checkbox"/> Yes, <input type="checkbox"/> No			386	<input type="checkbox"/> Yes, <input type="checkbox"/> No		
337	<input type="checkbox"/> Yes, <input type="checkbox"/> No			387	<input type="checkbox"/> Yes, <input type="checkbox"/> No		
338	<input type="checkbox"/> Yes, <input type="checkbox"/> No			388	<input type="checkbox"/> Yes, <input type="checkbox"/> No		
339	<input type="checkbox"/> Yes, <input type="checkbox"/> No			389	<input type="checkbox"/> Yes, <input type="checkbox"/> No		
340	<input type="checkbox"/> Yes, <input type="checkbox"/> No			390	<input type="checkbox"/> Yes, <input type="checkbox"/> No		
341	<input type="checkbox"/> Yes, <input type="checkbox"/> No			391	<input type="checkbox"/> Yes, <input type="checkbox"/> No		
342	<input type="checkbox"/> Yes, <input type="checkbox"/> No			392	<input type="checkbox"/> Yes, <input type="checkbox"/> No		
343	<input type="checkbox"/> Yes, <input type="checkbox"/> No			393	<input type="checkbox"/> Yes, <input type="checkbox"/> No		
344	<input type="checkbox"/> Yes, <input type="checkbox"/> No			394	<input type="checkbox"/> Yes, <input type="checkbox"/> No		
345	<input type="checkbox"/> Yes, <input type="checkbox"/> No			395	<input type="checkbox"/> Yes, <input type="checkbox"/> No		
346	<input type="checkbox"/> Yes, <input type="checkbox"/> No			396	<input type="checkbox"/> Yes, <input type="checkbox"/> No		
347	<input type="checkbox"/> Yes, <input type="checkbox"/> No			397	<input type="checkbox"/> Yes, <input type="checkbox"/> No		
348	<input type="checkbox"/> Yes, <input type="checkbox"/> No			398	<input type="checkbox"/> Yes, <input type="checkbox"/> No		
349	<input type="checkbox"/> Yes, <input type="checkbox"/> No			399	<input type="checkbox"/> Yes, <input type="checkbox"/> No		

TOLL RESTRICTION-AREA/OFFICE CODE TABLE (3/8)

Area/Office Code Table No. 4

Code No.	Local Call Access	Restriction Level	Office Code	Code No.	Local Call Access	Restriction Level	Office Code
400	<input type="checkbox"/> Yes, <input type="checkbox"/> No			450	<input type="checkbox"/> Yes, <input type="checkbox"/> No		
401	<input type="checkbox"/> Yes, <input type="checkbox"/> No			451	<input type="checkbox"/> Yes, <input type="checkbox"/> No		
402	<input type="checkbox"/> Yes, <input type="checkbox"/> No			452	<input type="checkbox"/> Yes, <input type="checkbox"/> No		
403	<input type="checkbox"/> Yes, <input type="checkbox"/> No			453	<input type="checkbox"/> Yes, <input type="checkbox"/> No		
404	<input type="checkbox"/> Yes, <input type="checkbox"/> No			454	<input type="checkbox"/> Yes, <input type="checkbox"/> No		
405	<input type="checkbox"/> Yes, <input type="checkbox"/> No			455	<input type="checkbox"/> Yes, <input type="checkbox"/> No		
406	<input type="checkbox"/> Yes, <input type="checkbox"/> No			456	<input type="checkbox"/> Yes, <input type="checkbox"/> No		
407	<input type="checkbox"/> Yes, <input type="checkbox"/> No			457	<input type="checkbox"/> Yes, <input type="checkbox"/> No		
408	<input type="checkbox"/> Yes, <input type="checkbox"/> No			458	<input type="checkbox"/> Yes, <input type="checkbox"/> No		
409	<input type="checkbox"/> Yes, <input type="checkbox"/> No			459	<input type="checkbox"/> Yes, <input type="checkbox"/> No		
410	<input type="checkbox"/> Yes, <input type="checkbox"/> No			460	<input type="checkbox"/> Yes, <input type="checkbox"/> No		
411	<input type="checkbox"/> Yes, <input type="checkbox"/> No			461	<input type="checkbox"/> Yes, <input type="checkbox"/> No		
412	<input type="checkbox"/> Yes, <input type="checkbox"/> No			462	<input type="checkbox"/> Yes, <input type="checkbox"/> No		
413	<input type="checkbox"/> Yes, <input type="checkbox"/> No			463	<input type="checkbox"/> Yes, <input type="checkbox"/> No		
414	<input type="checkbox"/> Yes, <input type="checkbox"/> No			464	<input type="checkbox"/> Yes, <input type="checkbox"/> No		
415	<input type="checkbox"/> Yes, <input type="checkbox"/> No			465	<input type="checkbox"/> Yes, <input type="checkbox"/> No		
416	<input type="checkbox"/> Yes, <input type="checkbox"/> No			466	<input type="checkbox"/> Yes, <input type="checkbox"/> No		
417	<input type="checkbox"/> Yes, <input type="checkbox"/> No			467	<input type="checkbox"/> Yes, <input type="checkbox"/> No		
418	<input type="checkbox"/> Yes, <input type="checkbox"/> No			468	<input type="checkbox"/> Yes, <input type="checkbox"/> No		
419	<input type="checkbox"/> Yes, <input type="checkbox"/> No			469	<input type="checkbox"/> Yes, <input type="checkbox"/> No		
420	<input type="checkbox"/> Yes, <input type="checkbox"/> No			470	<input type="checkbox"/> Yes, <input type="checkbox"/> No		
421	<input type="checkbox"/> Yes, <input type="checkbox"/> No			471	<input type="checkbox"/> Yes, <input type="checkbox"/> No		
422	<input type="checkbox"/> Yes, <input type="checkbox"/> No			472	<input type="checkbox"/> Yes, <input type="checkbox"/> No		
423	<input type="checkbox"/> Yes, <input type="checkbox"/> No			473	<input type="checkbox"/> Yes, <input type="checkbox"/> No		
424	<input type="checkbox"/> Yes, <input type="checkbox"/> No			474	<input type="checkbox"/> Yes, <input type="checkbox"/> No		
425	<input type="checkbox"/> Yes, <input type="checkbox"/> No			475	<input type="checkbox"/> Yes, <input type="checkbox"/> No		
426	<input type="checkbox"/> Yes, <input type="checkbox"/> No			476	<input type="checkbox"/> Yes, <input type="checkbox"/> No		
427	<input type="checkbox"/> Yes, <input type="checkbox"/> No			477	<input type="checkbox"/> Yes, <input type="checkbox"/> No		
428	<input type="checkbox"/> Yes, <input type="checkbox"/> No			478	<input type="checkbox"/> Yes, <input type="checkbox"/> No		
429	<input type="checkbox"/> Yes, <input type="checkbox"/> No			479	<input type="checkbox"/> Yes, <input type="checkbox"/> No		
430	<input type="checkbox"/> Yes, <input type="checkbox"/> No			480	<input type="checkbox"/> Yes, <input type="checkbox"/> No		
431	<input type="checkbox"/> Yes, <input type="checkbox"/> No			481	<input type="checkbox"/> Yes, <input type="checkbox"/> No		
432	<input type="checkbox"/> Yes, <input type="checkbox"/> No			482	<input type="checkbox"/> Yes, <input type="checkbox"/> No		
433	<input type="checkbox"/> Yes, <input type="checkbox"/> No			483	<input type="checkbox"/> Yes, <input type="checkbox"/> No		
434	<input type="checkbox"/> Yes, <input type="checkbox"/> No			484	<input type="checkbox"/> Yes, <input type="checkbox"/> No		
435	<input type="checkbox"/> Yes, <input type="checkbox"/> No			485	<input type="checkbox"/> Yes, <input type="checkbox"/> No		
436	<input type="checkbox"/> Yes, <input type="checkbox"/> No			486	<input type="checkbox"/> Yes, <input type="checkbox"/> No		
437	<input type="checkbox"/> Yes, <input type="checkbox"/> No			487	<input type="checkbox"/> Yes, <input type="checkbox"/> No		
438	<input type="checkbox"/> Yes, <input type="checkbox"/> No			488	<input type="checkbox"/> Yes, <input type="checkbox"/> No		
439	<input type="checkbox"/> Yes, <input type="checkbox"/> No			489	<input type="checkbox"/> Yes, <input type="checkbox"/> No		
440	<input type="checkbox"/> Yes, <input type="checkbox"/> No			490	<input type="checkbox"/> Yes, <input type="checkbox"/> No		
441	<input type="checkbox"/> Yes, <input type="checkbox"/> No			491	<input type="checkbox"/> Yes, <input type="checkbox"/> No		
442	<input type="checkbox"/> Yes, <input type="checkbox"/> No			492	<input type="checkbox"/> Yes, <input type="checkbox"/> No		
443	<input type="checkbox"/> Yes, <input type="checkbox"/> No			493	<input type="checkbox"/> Yes, <input type="checkbox"/> No		
444	<input type="checkbox"/> Yes, <input type="checkbox"/> No			494	<input type="checkbox"/> Yes, <input type="checkbox"/> No		
445	<input type="checkbox"/> Yes, <input type="checkbox"/> No			495	<input type="checkbox"/> Yes, <input type="checkbox"/> No		
446	<input type="checkbox"/> Yes, <input type="checkbox"/> No			496	<input type="checkbox"/> Yes, <input type="checkbox"/> No		
447	<input type="checkbox"/> Yes, <input type="checkbox"/> No			497	<input type="checkbox"/> Yes, <input type="checkbox"/> No		
448	<input type="checkbox"/> Yes, <input type="checkbox"/> No			498	<input type="checkbox"/> Yes, <input type="checkbox"/> No		
449	<input type="checkbox"/> Yes, <input type="checkbox"/> No			499	<input type="checkbox"/> Yes, <input type="checkbox"/> No		

TOLL RESTRICTION-AREA/OFFICE CODE TABLE (418)

Area/Office Code Table No. 4

Code No.	Local Call Access	Restriction Level	Office Code	Code No.	Local Call Access	Restriction Level	Office Code
500	<input type="checkbox"/> Yes, <input type="checkbox"/> No			550	<input type="checkbox"/> Yes, <input type="checkbox"/> No		
501	<input type="checkbox"/> Yes, <input type="checkbox"/> No			551	<input type="checkbox"/> Yes, <input type="checkbox"/> No		
502	<input type="checkbox"/> Yes, <input type="checkbox"/> No			552	<input type="checkbox"/> Yes, <input type="checkbox"/> No		
503	<input type="checkbox"/> Yes, <input type="checkbox"/> No			553	<input type="checkbox"/> Yes, <input type="checkbox"/> No		
504	<input type="checkbox"/> Yes, <input type="checkbox"/> No			554	<input type="checkbox"/> Yes, <input type="checkbox"/> No		
505	<input type="checkbox"/> Yes, <input type="checkbox"/> No			555	<input type="checkbox"/> Yes, <input type="checkbox"/> No		
506	<input type="checkbox"/> Yes, <input type="checkbox"/> No			556	<input type="checkbox"/> Yes, <input type="checkbox"/> No		
507	<input type="checkbox"/> Yes, <input type="checkbox"/> No			557	<input type="checkbox"/> Yes, <input type="checkbox"/> No		
508	<input type="checkbox"/> Yes, <input type="checkbox"/> No			558	<input type="checkbox"/> Yes, <input type="checkbox"/> No		
509	<input type="checkbox"/> Yes, <input type="checkbox"/> No			559	<input type="checkbox"/> Yes, <input type="checkbox"/> No		
510	<input type="checkbox"/> Yes, <input type="checkbox"/> No			560	<input type="checkbox"/> Yes, <input type="checkbox"/> No		
511	<input type="checkbox"/> Yes, <input type="checkbox"/> No			561	<input type="checkbox"/> Yes, <input type="checkbox"/> No		
512	<input type="checkbox"/> Yes, <input type="checkbox"/> No			562	<input type="checkbox"/> Yes, <input type="checkbox"/> No		
513	<input type="checkbox"/> Yes, <input type="checkbox"/> No			563	<input type="checkbox"/> Yes, <input type="checkbox"/> No		
514	<input type="checkbox"/> Yes, <input type="checkbox"/> No			564	<input type="checkbox"/> Yes, <input type="checkbox"/> No		
515	<input type="checkbox"/> Yes, <input type="checkbox"/> No			565	<input type="checkbox"/> Yes, <input type="checkbox"/> No		
516	<input type="checkbox"/> Yes, <input type="checkbox"/> No			566	<input type="checkbox"/> Yes, <input type="checkbox"/> No		
517	<input type="checkbox"/> Yes, <input type="checkbox"/> No			567	<input type="checkbox"/> Yes, <input type="checkbox"/> No		
518	<input type="checkbox"/> Yes, <input type="checkbox"/> No			568	<input type="checkbox"/> Yes, <input type="checkbox"/> No		
519	<input type="checkbox"/> Yes, <input type="checkbox"/> No			569	<input type="checkbox"/> Yes, <input type="checkbox"/> No		
520	<input type="checkbox"/> Yes, <input type="checkbox"/> No			570	<input type="checkbox"/> Yes, <input type="checkbox"/> No		
521	<input type="checkbox"/> Yes, <input type="checkbox"/> No			571	<input type="checkbox"/> Yes, <input type="checkbox"/> No		
522	<input type="checkbox"/> Yes, <input type="checkbox"/> No			572	<input type="checkbox"/> Yes, <input type="checkbox"/> No		
523	<input type="checkbox"/> Yes, <input type="checkbox"/> No			573	<input type="checkbox"/> Yes, <input type="checkbox"/> No		
524	<input type="checkbox"/> Yes, <input type="checkbox"/> No			574	<input type="checkbox"/> Yes, <input type="checkbox"/> No		
525	<input type="checkbox"/> Yes, <input type="checkbox"/> No			575	<input type="checkbox"/> Yes, <input type="checkbox"/> No		
526	<input type="checkbox"/> Yes, <input type="checkbox"/> No			576	<input type="checkbox"/> Yes, <input type="checkbox"/> No		
527	<input type="checkbox"/> Yes, <input type="checkbox"/> No			577	<input type="checkbox"/> Yes, <input type="checkbox"/> No		
528	<input type="checkbox"/> Yes, <input type="checkbox"/> No			578	<input type="checkbox"/> Yes, <input type="checkbox"/> No		
529	<input type="checkbox"/> Yes, <input type="checkbox"/> No			579	<input type="checkbox"/> Yes, <input type="checkbox"/> No		
530	<input type="checkbox"/> Yes, <input type="checkbox"/> No			580	<input type="checkbox"/> Yes, <input type="checkbox"/> No		
531	<input type="checkbox"/> Yes, <input type="checkbox"/> No			581	<input type="checkbox"/> Yes, <input type="checkbox"/> No		
532	<input type="checkbox"/> Yes, <input type="checkbox"/> No			582	<input type="checkbox"/> Yes, <input type="checkbox"/> No		
533	<input type="checkbox"/> Yes, <input type="checkbox"/> No			583	<input type="checkbox"/> Yes, <input type="checkbox"/> No		
534	<input type="checkbox"/> Yes, <input type="checkbox"/> No			584	<input type="checkbox"/> Yes, <input type="checkbox"/> No		
535	<input type="checkbox"/> Yes, <input type="checkbox"/> No			585	<input type="checkbox"/> Yes, <input type="checkbox"/> No		
536	<input type="checkbox"/> Yes, <input type="checkbox"/> No			586	<input type="checkbox"/> Yes, <input type="checkbox"/> No		
537	<input type="checkbox"/> Yes, <input type="checkbox"/> No			587	<input type="checkbox"/> Yes, <input type="checkbox"/> No		
538	<input type="checkbox"/> Yes, <input type="checkbox"/> No			588	<input type="checkbox"/> Yes, <input type="checkbox"/> No		
539	<input type="checkbox"/> Yes, <input type="checkbox"/> No			589	<input type="checkbox"/> Yes, <input type="checkbox"/> No		
540	<input type="checkbox"/> Yes, <input type="checkbox"/> No			590	<input type="checkbox"/> Yes, <input type="checkbox"/> No		
541	<input type="checkbox"/> Yes, <input type="checkbox"/> No			591	<input type="checkbox"/> Yes, <input type="checkbox"/> No		
542	<input type="checkbox"/> Yes, <input type="checkbox"/> No			592	<input type="checkbox"/> Yes, <input type="checkbox"/> No		
543	<input type="checkbox"/> Yes, <input type="checkbox"/> No			593	<input type="checkbox"/> Yes, <input type="checkbox"/> No		
544	<input type="checkbox"/> Yes, <input type="checkbox"/> No			594	<input type="checkbox"/> Yes, <input type="checkbox"/> No		
545	<input type="checkbox"/> Yes, <input type="checkbox"/> No			595	<input type="checkbox"/> Yes, <input type="checkbox"/> No		
546	<input type="checkbox"/> Yes, <input type="checkbox"/> No			596	<input type="checkbox"/> Yes, <input type="checkbox"/> No		
547	<input type="checkbox"/> Yes, <input type="checkbox"/> No			597	<input type="checkbox"/> Yes, <input type="checkbox"/> No		
548	<input type="checkbox"/> Yes, <input type="checkbox"/> No			598	<input type="checkbox"/> Yes, <input type="checkbox"/> No		
549	<input type="checkbox"/> Yes, <input type="checkbox"/> No			599	<input type="checkbox"/> Yes, <input type="checkbox"/> No		

TOLL RESTRICTION-AREA/OFFICE CODE TABLE (5/8)

Area/Office Code Table No. 4

Code No.	Local Call Access	Restriction Level	Office Code	Code No.	Local Call Access	Restriction Level	Office Code
600	<input type="checkbox"/> Yes, <input type="checkbox"/> No			650	<input type="checkbox"/> Yes, <input type="checkbox"/> No		
601	<input type="checkbox"/> Yes, <input type="checkbox"/> No			651	<input type="checkbox"/> Yes, <input type="checkbox"/> No		
602	<input type="checkbox"/> Yes, <input type="checkbox"/> No			652	<input type="checkbox"/> Yes, <input type="checkbox"/> No		
603	<input type="checkbox"/> Yes, <input type="checkbox"/> No			653	<input type="checkbox"/> Yes, <input type="checkbox"/> No		
604	<input type="checkbox"/> Yes, <input type="checkbox"/> No			654	<input type="checkbox"/> Yes, <input type="checkbox"/> No		
605	<input type="checkbox"/> Yes, <input type="checkbox"/> No			655	<input type="checkbox"/> Yes, <input type="checkbox"/> No		
606	<input type="checkbox"/> Yes, <input type="checkbox"/> No			656	<input type="checkbox"/> Yes, <input type="checkbox"/> No		
607	<input type="checkbox"/> Yes, <input type="checkbox"/> No			657	<input type="checkbox"/> Yes, <input type="checkbox"/> No		
608	<input type="checkbox"/> Yes, <input type="checkbox"/> No			658	<input type="checkbox"/> Yes, <input type="checkbox"/> No		
609	<input type="checkbox"/> Yes, <input type="checkbox"/> No			659	<input type="checkbox"/> Yes, <input type="checkbox"/> No		
610	<input type="checkbox"/> Yes, <input type="checkbox"/> No			660	<input type="checkbox"/> Yes, <input type="checkbox"/> No		
611	<input type="checkbox"/> Yes, <input type="checkbox"/> No			661	<input type="checkbox"/> Yes, <input type="checkbox"/> No		
612	<input type="checkbox"/> Yes, <input type="checkbox"/> No			662	<input type="checkbox"/> Yes, <input type="checkbox"/> No		
613	<input type="checkbox"/> Yes, <input type="checkbox"/> No			663	<input type="checkbox"/> Yes, <input type="checkbox"/> No		
614	<input type="checkbox"/> Yes, <input type="checkbox"/> No			664	<input type="checkbox"/> Yes, <input type="checkbox"/> No		
615	<input type="checkbox"/> Yes, <input type="checkbox"/> No			665	<input type="checkbox"/> Yes, <input type="checkbox"/> No		
616	<input type="checkbox"/> Yes, <input type="checkbox"/> No			666	<input type="checkbox"/> Yes, <input type="checkbox"/> No		
617	<input type="checkbox"/> Yes, <input type="checkbox"/> No			667	<input type="checkbox"/> Yes, <input type="checkbox"/> No		
618	<input type="checkbox"/> Yes, <input type="checkbox"/> No			668	<input type="checkbox"/> Yes, <input type="checkbox"/> No		
619	<input type="checkbox"/> Yes, <input type="checkbox"/> No			669	<input type="checkbox"/> Yes, <input type="checkbox"/> No		
620	<input type="checkbox"/> Yes, <input type="checkbox"/> No			670	<input type="checkbox"/> Yes, <input type="checkbox"/> No		
621	<input type="checkbox"/> Yes, <input type="checkbox"/> No			671	<input type="checkbox"/> Yes, <input type="checkbox"/> No		
622	<input type="checkbox"/> Yes, <input type="checkbox"/> No			672	<input type="checkbox"/> Yes, <input type="checkbox"/> No		
623	<input type="checkbox"/> Yes, <input type="checkbox"/> No			673	<input type="checkbox"/> Yes, <input type="checkbox"/> No		
624	<input type="checkbox"/> Yes, <input type="checkbox"/> No			674	<input type="checkbox"/> Yes, <input type="checkbox"/> No		
625	<input type="checkbox"/> Yes, <input type="checkbox"/> No			675	<input type="checkbox"/> Yes, <input type="checkbox"/> No		
626	<input type="checkbox"/> Yes, <input type="checkbox"/> No			676	<input type="checkbox"/> Yes, <input type="checkbox"/> No		
627	<input type="checkbox"/> Yes, <input type="checkbox"/> No			677	<input type="checkbox"/> Yes, <input type="checkbox"/> No		
628	<input type="checkbox"/> Yes, <input type="checkbox"/> No			678	<input type="checkbox"/> Yes, <input type="checkbox"/> No		
629	<input type="checkbox"/> Yes, <input type="checkbox"/> No			679	<input type="checkbox"/> Yes, <input type="checkbox"/> No		
630	<input type="checkbox"/> Yes, <input type="checkbox"/> No			680	<input type="checkbox"/> Yes, <input type="checkbox"/> No		
631	<input type="checkbox"/> Yes, <input type="checkbox"/> No			681	<input type="checkbox"/> Yes, <input type="checkbox"/> No		
632	<input type="checkbox"/> Yes, <input type="checkbox"/> No			682	<input type="checkbox"/> Yes, <input type="checkbox"/> No		
633	<input type="checkbox"/> Yes, <input type="checkbox"/> No			683	<input type="checkbox"/> Yes, <input type="checkbox"/> No		
634	<input type="checkbox"/> Yes, <input type="checkbox"/> No			684	<input type="checkbox"/> Yes, <input type="checkbox"/> No		
635	<input type="checkbox"/> Yes, <input type="checkbox"/> No			685	<input type="checkbox"/> Yes, <input type="checkbox"/> No		
636	<input type="checkbox"/> Yes, <input type="checkbox"/> No			686	<input type="checkbox"/> Yes, <input type="checkbox"/> No		
637	<input type="checkbox"/> Yes, <input type="checkbox"/> No			687	<input type="checkbox"/> Yes, <input type="checkbox"/> No		
638	<input type="checkbox"/> Yes, <input type="checkbox"/> No			688	<input type="checkbox"/> Yes, <input type="checkbox"/> No		
639	<input type="checkbox"/> Yes, <input type="checkbox"/> No			689	<input type="checkbox"/> Yes, <input type="checkbox"/> No		
640	<input type="checkbox"/> Yes, <input type="checkbox"/> No			690	<input type="checkbox"/> Yes, <input type="checkbox"/> No		
641	<input type="checkbox"/> Yes, <input type="checkbox"/> No			691	<input type="checkbox"/> Yes, <input type="checkbox"/> No		
642	<input type="checkbox"/> Yes, <input type="checkbox"/> No			692	<input type="checkbox"/> Yes, <input type="checkbox"/> No		
643	<input type="checkbox"/> Yes, <input type="checkbox"/> No			693	<input type="checkbox"/> Yes, <input type="checkbox"/> No		
644	<input type="checkbox"/> Yes, <input type="checkbox"/> No			694	<input type="checkbox"/> Yes, <input type="checkbox"/> No		
645	<input type="checkbox"/> Yes, <input type="checkbox"/> No			695	<input type="checkbox"/> Yes, <input type="checkbox"/> No		
646	<input type="checkbox"/> Yes, <input type="checkbox"/> No			696	<input type="checkbox"/> Yes, <input type="checkbox"/> No		
647	<input type="checkbox"/> Yes, <input type="checkbox"/> No			697	<input type="checkbox"/> Yes, <input type="checkbox"/> No		
648	<input type="checkbox"/> Yes, <input type="checkbox"/> No			698	<input type="checkbox"/> Yes, <input type="checkbox"/> No		
649	<input type="checkbox"/> Yes, <input type="checkbox"/> No			699	<input type="checkbox"/> Yes, <input type="checkbox"/> No		

TOLL RESTRICTION-AREA/OFFICE CODE TABLE (6/8)

Area/Office Code Table No. 4

Code No.	Local Call Access	Restriction Level	Office Code	Code No.	Local Call Access	Restriction Level	Office Code
700	<input type="checkbox"/> Yes, <input type="checkbox"/> No			750	<input type="checkbox"/> Yes, <input type="checkbox"/> No		
701	<input type="checkbox"/> Yes, <input type="checkbox"/> No			751	<input type="checkbox"/> Yes, <input type="checkbox"/> No		
702	<input type="checkbox"/> Yes, <input type="checkbox"/> No			752	<input type="checkbox"/> Yes, <input type="checkbox"/> No		
703	<input type="checkbox"/> Yes, <input type="checkbox"/> No			753	<input type="checkbox"/> Yes, <input type="checkbox"/> No		
704	<input type="checkbox"/> Yes, <input type="checkbox"/> No			754	<input type="checkbox"/> Yes, <input type="checkbox"/> No		
705	<input type="checkbox"/> Yes, <input type="checkbox"/> No			755	<input type="checkbox"/> Yes, <input type="checkbox"/> No		
706	<input type="checkbox"/> Yes, <input type="checkbox"/> No			756	<input type="checkbox"/> Yes, <input type="checkbox"/> No		
707	<input type="checkbox"/> Yes, <input type="checkbox"/> No			757	<input type="checkbox"/> Yes, <input type="checkbox"/> No		
708	<input type="checkbox"/> Yes, <input type="checkbox"/> No			758	<input type="checkbox"/> Yes, <input type="checkbox"/> No		
709	<input type="checkbox"/> Yes, <input type="checkbox"/> No			759	<input type="checkbox"/> Yes, <input type="checkbox"/> No		
710	<input type="checkbox"/> Yes, <input type="checkbox"/> No			760	<input type="checkbox"/> Yes, <input type="checkbox"/> No		
711	<input type="checkbox"/> Yes, <input type="checkbox"/> No			761	<input type="checkbox"/> Yes, <input type="checkbox"/> No		
712	<input type="checkbox"/> Yes, <input type="checkbox"/> No			762	<input type="checkbox"/> Yes, <input type="checkbox"/> No		
713	<input type="checkbox"/> Yes, <input type="checkbox"/> No			763	<input type="checkbox"/> Yes, <input type="checkbox"/> No		
714	<input type="checkbox"/> Yes, <input type="checkbox"/> No			764	<input type="checkbox"/> Yes, <input type="checkbox"/> No		
715	<input type="checkbox"/> Yes, <input type="checkbox"/> No			765	<input type="checkbox"/> Yes, <input type="checkbox"/> No		
716	<input type="checkbox"/> Yes, <input type="checkbox"/> No			766	<input type="checkbox"/> Yes, <input type="checkbox"/> No		
717	<input type="checkbox"/> Yes, <input type="checkbox"/> No			767	<input type="checkbox"/> Yes, <input type="checkbox"/> No		
718	<input type="checkbox"/> Yes, <input type="checkbox"/> No			768	<input type="checkbox"/> Yes, <input type="checkbox"/> No		
719	<input type="checkbox"/> Yes, <input type="checkbox"/> No			769	<input type="checkbox"/> Yes, <input type="checkbox"/> No		
720	<input type="checkbox"/> Yes, <input type="checkbox"/> No			770	<input type="checkbox"/> Yes, <input type="checkbox"/> No		
721	<input type="checkbox"/> Yes, <input type="checkbox"/> No			771	<input type="checkbox"/> Yes, <input type="checkbox"/> No		
722	<input type="checkbox"/> Yes, <input type="checkbox"/> No			772	<input type="checkbox"/> Yes, <input type="checkbox"/> No		
723	<input type="checkbox"/> Yes, <input type="checkbox"/> No			773	<input type="checkbox"/> Yes, <input type="checkbox"/> No		
724	<input type="checkbox"/> Yes, <input type="checkbox"/> No			774	<input type="checkbox"/> Yes, <input type="checkbox"/> No		
725	<input type="checkbox"/> Yes, <input type="checkbox"/> No			775	<input type="checkbox"/> Yes, <input type="checkbox"/> No		
726	<input type="checkbox"/> Yes, <input type="checkbox"/> No			776	<input type="checkbox"/> Yes, <input type="checkbox"/> No		
727	<input type="checkbox"/> Yes, <input type="checkbox"/> No			777	<input type="checkbox"/> Yes, <input type="checkbox"/> No		
728	<input type="checkbox"/> Yes, <input type="checkbox"/> No			778	<input type="checkbox"/> Yes, <input type="checkbox"/> No		
729	<input type="checkbox"/> Yes, <input type="checkbox"/> No			779	<input type="checkbox"/> Yes, <input type="checkbox"/> No		
730	<input type="checkbox"/> Yes, <input type="checkbox"/> No			780	<input type="checkbox"/> Yes, <input type="checkbox"/> No		
731	<input type="checkbox"/> Yes, <input type="checkbox"/> No			781	<input type="checkbox"/> Yes, <input type="checkbox"/> No		
732	<input type="checkbox"/> Yes, <input type="checkbox"/> No			782	<input type="checkbox"/> Yes, <input type="checkbox"/> No		
733	<input type="checkbox"/> Yes, <input type="checkbox"/> No			783	<input type="checkbox"/> Yes, <input type="checkbox"/> No		
734	<input type="checkbox"/> Yes, <input type="checkbox"/> No			784	<input type="checkbox"/> Yes, <input type="checkbox"/> No		
735	<input type="checkbox"/> Yes, <input type="checkbox"/> No			785	<input type="checkbox"/> Yes, <input type="checkbox"/> No		
736	<input type="checkbox"/> Yes, <input type="checkbox"/> No			786	<input type="checkbox"/> Yes, <input type="checkbox"/> No		
737	<input type="checkbox"/> Yes, <input type="checkbox"/> No			787	<input type="checkbox"/> Yes, <input type="checkbox"/> No		
738	<input type="checkbox"/> Yes, <input type="checkbox"/> No			788	<input type="checkbox"/> Yes, <input type="checkbox"/> No		
739	<input type="checkbox"/> Yes, <input type="checkbox"/> No			789	<input type="checkbox"/> Yes, <input type="checkbox"/> No		
740	<input type="checkbox"/> Yes, <input type="checkbox"/> No			790	<input type="checkbox"/> Yes, <input type="checkbox"/> No		
741	<input type="checkbox"/> Yes, <input type="checkbox"/> No			791	<input type="checkbox"/> Yes, <input type="checkbox"/> No		
742	<input type="checkbox"/> Yes, <input type="checkbox"/> No			792	<input type="checkbox"/> Yes, <input type="checkbox"/> No		
743	<input type="checkbox"/> Yes, <input type="checkbox"/> No			793	<input type="checkbox"/> Yes, <input type="checkbox"/> No		
744	<input type="checkbox"/> Yes, <input type="checkbox"/> No			794	<input type="checkbox"/> Yes, <input type="checkbox"/> No		
745	<input type="checkbox"/> Yes, <input type="checkbox"/> No			795	<input type="checkbox"/> Yes, <input type="checkbox"/> No		
746	<input type="checkbox"/> Yes, <input type="checkbox"/> No			796	<input type="checkbox"/> Yes, <input type="checkbox"/> No		
747	<input type="checkbox"/> Yes, <input type="checkbox"/> No			797	<input type="checkbox"/> Yes, <input type="checkbox"/> No		
748	<input type="checkbox"/> Yes, <input type="checkbox"/> No			798	<input type="checkbox"/> Yes, <input type="checkbox"/> No		

TOLL RESTRICTION-AREA/OFFICE CODE TABLE (7/8)

Area/Office Code Table No. 4

Code No.	Local Call Access	Restriction Level	Office Code	Code No.	Local Call Access	Restriction Level	Office Code
800	<input type="checkbox"/> Yes, <input type="checkbox"/> No			850	<input type="checkbox"/> Yes, <input type="checkbox"/> No		
801	<input type="checkbox"/> Yes, <input type="checkbox"/> No			851	<input type="checkbox"/> Yes, <input type="checkbox"/> No		
802	<input type="checkbox"/> Yes, <input type="checkbox"/> No			852	<input type="checkbox"/> Yes, <input type="checkbox"/> No		
803	<input type="checkbox"/> Yes, <input type="checkbox"/> No			653	@ Yes, <input type="checkbox"/> No		
804	<input type="checkbox"/> Yes, <input type="checkbox"/> No			854	<input type="checkbox"/> Yes, <input type="checkbox"/> No		
805	<input type="checkbox"/> Yes, <input type="checkbox"/> No			855	<input type="checkbox"/> Yes, <input type="checkbox"/> No		
806	<input type="checkbox"/> Yes, <input type="checkbox"/> No			856	<input type="checkbox"/> Yes, <input type="checkbox"/> No		
807	<input type="checkbox"/> Yes, <input type="checkbox"/> No			857	<input type="checkbox"/> Yes, <input type="checkbox"/> No		
808	<input type="checkbox"/> Yes, <input type="checkbox"/> No			858	<input type="checkbox"/> Yes, <input type="checkbox"/> No		
809	<input type="checkbox"/> Yes, <input type="checkbox"/> No			859	<input type="checkbox"/> Yes, <input type="checkbox"/> No		
810	<input type="checkbox"/> Yes, <input type="checkbox"/> No			860	<input type="checkbox"/> Yes, <input type="checkbox"/> No		
811	<input type="checkbox"/> Yes, <input type="checkbox"/> No			861	<input type="checkbox"/> Yes, <input type="checkbox"/> No		
812	<input type="checkbox"/> Yes, <input type="checkbox"/> No			862	<input type="checkbox"/> Yes, <input type="checkbox"/> No		
813	<input type="checkbox"/> Yes, <input type="checkbox"/> No			863	<input type="checkbox"/> Yes, <input type="checkbox"/> No		
814	<input type="checkbox"/> Yes, <input type="checkbox"/> No			864	<input type="checkbox"/> Yes, <input type="checkbox"/> No		
815	<input type="checkbox"/> Yes, <input type="checkbox"/> No			865	<input type="checkbox"/> Yes, <input type="checkbox"/> No		
816	<input type="checkbox"/> Yes, <input type="checkbox"/> No			866	<input type="checkbox"/> Yes, <input type="checkbox"/> No		
817	<input type="checkbox"/> Yes, <input type="checkbox"/> No			867	<input type="checkbox"/> Yes, <input type="checkbox"/> No		
818	<input type="checkbox"/> Yes, <input type="checkbox"/> No			868	<input type="checkbox"/> Yes, <input type="checkbox"/> No		
819	<input type="checkbox"/> Yes, <input type="checkbox"/> No			869	<input type="checkbox"/> Yes, <input type="checkbox"/> No		
820	<input type="checkbox"/> Yes, <input type="checkbox"/> No			870	<input type="checkbox"/> Yes, <input type="checkbox"/> No		
821	<input type="checkbox"/> Yes, <input type="checkbox"/> No			871	<input type="checkbox"/> Yes, <input type="checkbox"/> No		
822	<input type="checkbox"/> Yes, <input type="checkbox"/> No			872	<input type="checkbox"/> Yes, <input type="checkbox"/> No		
8 2 3	<input type="checkbox"/> Yes, <input type="checkbox"/> No			873	<input type="checkbox"/> Yes, <input type="checkbox"/> No		
8 2 4	<input type="checkbox"/> Yes, <input type="checkbox"/> No			874	<input type="checkbox"/> Yes, <input type="checkbox"/> No		
8 2 5	<input type="checkbox"/> Yes, <input type="checkbox"/> No			a75	<input type="checkbox"/> Yes, <input type="checkbox"/> No		
8 2 6	<input type="checkbox"/> Yes, <input type="checkbox"/> No			876	<input type="checkbox"/> Yes, <input type="checkbox"/> No		
8 2 7	<input type="checkbox"/> Yes, <input type="checkbox"/> No			877	<input type="checkbox"/> Yes, <input type="checkbox"/> No		
828	<input type="checkbox"/> Yes, <input type="checkbox"/> No			878	<input type="checkbox"/> Yes, <input type="checkbox"/> No		
829	<input type="checkbox"/> Yes, <input type="checkbox"/> No			879	<input type="checkbox"/> Yes, <input type="checkbox"/> No		
830	<input type="checkbox"/> Yes, <input type="checkbox"/> No			880	<input type="checkbox"/> Yes, <input type="checkbox"/> No		
831	<input type="checkbox"/> Yes, <input type="checkbox"/> No			881	<input type="checkbox"/> Yes, <input type="checkbox"/> No		
832	<input type="checkbox"/> Yes, <input type="checkbox"/> No			882	<input type="checkbox"/> Yes, <input type="checkbox"/> No		
833	<input type="checkbox"/> Yes, <input type="checkbox"/> No			883	<input type="checkbox"/> Yes, <input type="checkbox"/> No		
834	<input type="checkbox"/> Yes, <input type="checkbox"/> No			884	<input type="checkbox"/> Yes, <input type="checkbox"/> No		
835	<input type="checkbox"/> Yes, <input type="checkbox"/> No			885	<input type="checkbox"/> Yes, <input type="checkbox"/> No		
836	<input type="checkbox"/> Yes, <input type="checkbox"/> No			886	<input type="checkbox"/> Yes, <input type="checkbox"/> No		
837	<input type="checkbox"/> Yes, <input type="checkbox"/> No			887	<input type="checkbox"/> Yes, <input type="checkbox"/> No		
838	<input type="checkbox"/> Yes, <input type="checkbox"/> No			888	<input type="checkbox"/> Yes, <input type="checkbox"/> No		
839	<input type="checkbox"/> Yes, <input type="checkbox"/> No			889	<input type="checkbox"/> Yes, <input type="checkbox"/> No		
840	<input type="checkbox"/> Yes, <input type="checkbox"/> No			890	<input type="checkbox"/> Yes, <input type="checkbox"/> No		
841	<input type="checkbox"/> Yes, <input type="checkbox"/> No			8 9 1	<input type="checkbox"/> Yes, <input type="checkbox"/> No		
842	<input type="checkbox"/> Yes, <input type="checkbox"/> No			892	<input type="checkbox"/> Yes, <input type="checkbox"/> No		
843	<input type="checkbox"/> Yes, <input type="checkbox"/> No			893	<input type="checkbox"/> Yes, <input type="checkbox"/> No		
844	<input type="checkbox"/> Yes, <input type="checkbox"/> No			894	<input type="checkbox"/> Yes, <input type="checkbox"/> No		
845	<input type="checkbox"/> Yes, <input type="checkbox"/> No			895	<input type="checkbox"/> Yes, <input type="checkbox"/> No		
846	<input type="checkbox"/> Yes, <input type="checkbox"/> No			896	<input type="checkbox"/> Yes, <input type="checkbox"/> No		
847	<input type="checkbox"/> Yes, <input type="checkbox"/> No			897	<input type="checkbox"/> Yes, <input type="checkbox"/> No		
848	<input type="checkbox"/> Yes, <input type="checkbox"/> No			898	<input type="checkbox"/> Yes, <input type="checkbox"/> No		
849	<input type="checkbox"/> Yes, <input type="checkbox"/> No			a 9 9	<input type="checkbox"/> Yes, <input type="checkbox"/> No		

TOLL RESTRICTION—AREA/OFFICE CODE TABLE (8/8)

Area Office Code Table No. 4

Code NC	Local Call Access	Restriction level	Office Code	Code No.	Local Call Access	Restriction Level	Office Code
900	<input type="checkbox"/> Yes, <input type="checkbox"/> No			950	<input type="checkbox"/> Yes, <input type="checkbox"/> No		
901	<input type="checkbox"/> Yes, <input type="checkbox"/> No			951	<input type="checkbox"/> Yes, <input type="checkbox"/> No		
902	<input type="checkbox"/> Yes, <input type="checkbox"/> No			952	<input type="checkbox"/> Yes, <input type="checkbox"/> No		
903	<input type="checkbox"/> Yes, <input type="checkbox"/> No			953	<input type="checkbox"/> Yes, <input type="checkbox"/> No		
904	<input type="checkbox"/> Yes, <input type="checkbox"/> No			954	<input type="checkbox"/> Yes, <input type="checkbox"/> No		
905	<input type="checkbox"/> Yes, <input type="checkbox"/> No			955	<input type="checkbox"/> Yes, <input type="checkbox"/> No		
906	<input type="checkbox"/> Yes, <input type="checkbox"/> No			956	<input type="checkbox"/> Yes, <input type="checkbox"/> No		
907	<input type="checkbox"/> Yes, <input type="checkbox"/> No			957	<input type="checkbox"/> Yes, <input type="checkbox"/> No		
908	<input type="checkbox"/> Yes, <input type="checkbox"/> No			958	<input type="checkbox"/> Yes, <input type="checkbox"/> No		
909	<input type="checkbox"/> Yes, <input type="checkbox"/> No			959	<input type="checkbox"/> Yes, <input type="checkbox"/> No		
910	<input type="checkbox"/> Yes, <input type="checkbox"/> No			960	<input type="checkbox"/> Yes, <input type="checkbox"/> No		
911	<input type="checkbox"/> Yes, <input type="checkbox"/> No			961	<input type="checkbox"/> Yes, <input type="checkbox"/> No		
912	<input type="checkbox"/> Yes, <input type="checkbox"/> No			962	<input type="checkbox"/> Yes, <input type="checkbox"/> No		
913	<input type="checkbox"/> Yes, <input type="checkbox"/> No			963	<input type="checkbox"/> Yes, <input type="checkbox"/> No		
914	<input type="checkbox"/> Yes, <input type="checkbox"/> No			964	<input type="checkbox"/> Yes, <input type="checkbox"/> No		
915	<input type="checkbox"/> Yes, <input type="checkbox"/> No			965	<input type="checkbox"/> Yes, <input type="checkbox"/> No		
916	<input type="checkbox"/> Yes, <input type="checkbox"/> No			966	<input type="checkbox"/> Yes, <input type="checkbox"/> No		
917	<input type="checkbox"/> Yes, <input type="checkbox"/> No			967	<input type="checkbox"/> Yes, <input type="checkbox"/> No		
918	<input type="checkbox"/> Yes, <input type="checkbox"/> No			968	<input type="checkbox"/> Yes, <input type="checkbox"/> No		
919	<input type="checkbox"/> Yes, <input type="checkbox"/> No			969	<input type="checkbox"/> Yes, <input type="checkbox"/> No		
920	<input type="checkbox"/> Yes, <input type="checkbox"/> No			970	<input type="checkbox"/> Yes, <input type="checkbox"/> No		
921	<input type="checkbox"/> Yes, <input type="checkbox"/> No			971	<input type="checkbox"/> Yes, <input type="checkbox"/> No		
922	<input type="checkbox"/> Yes, <input type="checkbox"/> No			972	<input type="checkbox"/> Yes, <input type="checkbox"/> No		
923	<input type="checkbox"/> Yes, <input type="checkbox"/> No			973	<input type="checkbox"/> Yes, <input type="checkbox"/> No		
924	<input type="checkbox"/> Yes, <input type="checkbox"/> No			974	<input type="checkbox"/> Yes, <input type="checkbox"/> No		
925	<input type="checkbox"/> Yes, <input type="checkbox"/> No			975	<input type="checkbox"/> Yes, <input type="checkbox"/> No		
926	<input type="checkbox"/> Yes, <input type="checkbox"/> No			976	<input type="checkbox"/> Yes, <input type="checkbox"/> No		
927	<input type="checkbox"/> Yes, <input type="checkbox"/> No			977	<input type="checkbox"/> Yes, <input type="checkbox"/> No		
928	<input type="checkbox"/> Yes, <input type="checkbox"/> No			978	<input type="checkbox"/> Yes, <input type="checkbox"/> No		
929	<input type="checkbox"/> Yes, <input type="checkbox"/> No			979	<input type="checkbox"/> Yes, <input type="checkbox"/> No		
930	<input type="checkbox"/> Yes, <input type="checkbox"/> No			980	<input type="checkbox"/> Yes, <input type="checkbox"/> No		
931	<input type="checkbox"/> Yes, <input type="checkbox"/> No			981	<input type="checkbox"/> Yes, <input type="checkbox"/> No		
932	<input type="checkbox"/> Yes, <input type="checkbox"/> No			982	<input type="checkbox"/> Yes, <input type="checkbox"/> No		
933	<input type="checkbox"/> Yes, <input type="checkbox"/> No			983	<input type="checkbox"/> Yes, <input type="checkbox"/> No		
934	<input type="checkbox"/> Yes, <input type="checkbox"/> No			984	<input type="checkbox"/> Yes, <input type="checkbox"/> No		
935	<input type="checkbox"/> Yes, <input type="checkbox"/> No			985	<input type="checkbox"/> Yes, <input type="checkbox"/> No		
936	<input type="checkbox"/> Yes, <input type="checkbox"/> No			986	<input type="checkbox"/> Yes, <input type="checkbox"/> No		
937	<input type="checkbox"/> Yes, <input type="checkbox"/> No			987	<input type="checkbox"/> Yes, <input type="checkbox"/> No		
938	<input type="checkbox"/> Yes, <input type="checkbox"/> No			988	<input type="checkbox"/> Yes, <input type="checkbox"/> No		
939	<input type="checkbox"/> Yes, <input type="checkbox"/> No			989	<input type="checkbox"/> Yes, <input type="checkbox"/> No		
940	<input type="checkbox"/> Yes, <input type="checkbox"/> No			990	<input type="checkbox"/> Yes, <input type="checkbox"/> No		
941	<input type="checkbox"/> Yes, <input type="checkbox"/> No			991	<input type="checkbox"/> Yes, <input type="checkbox"/> No		
942	<input type="checkbox"/> Yes, <input type="checkbox"/> No			992	<input type="checkbox"/> Yes, <input type="checkbox"/> No		
943	<input type="checkbox"/> Yes, <input type="checkbox"/> No			993	<input type="checkbox"/> Yes, <input type="checkbox"/> No		
944	<input type="checkbox"/> Yes, <input type="checkbox"/> No			994	<input type="checkbox"/> Yes, <input type="checkbox"/> No		
945	<input type="checkbox"/> Yes, <input type="checkbox"/> No			995	<input type="checkbox"/> Yes, <input type="checkbox"/> No		
946	<input type="checkbox"/> Yes, <input type="checkbox"/> No			996	<input type="checkbox"/> Yes, <input type="checkbox"/> No		
947	<input type="checkbox"/> Yes, <input type="checkbox"/> No			997	<input type="checkbox"/> Yes, <input type="checkbox"/> No		
948	<input type="checkbox"/> Yes, <input type="checkbox"/> No			998	<input type="checkbox"/> Yes, <input type="checkbox"/> No		
949	<input type="checkbox"/> Yes, <input type="checkbox"/> No			999	<input type="checkbox"/> Yes, <input type="checkbox"/> No		

TOLL RESTRICTION-AREA/OFFICE CODE TABLE (1/8)

Area/Office Code Table No. 5

Code No.	Local Call Access	Restriction Level	Office Code	Code No.	Local Call Access	Restriction Level	Office Code
200	<input type="checkbox"/> Yes, <input type="checkbox"/> No			250	<input type="checkbox"/> Yes, <input checked="" type="checkbox"/> No		
201	<input type="checkbox"/> Yes, <input type="checkbox"/> No			251	<input type="checkbox"/> Yes, <input type="checkbox"/> No		
202	<input type="checkbox"/> Yes, <input type="checkbox"/> No			252	<input type="checkbox"/> Yes, <input type="checkbox"/> No		
203	<input type="checkbox"/> Yes, <input type="checkbox"/> No			253	<input type="checkbox"/> Yes, <input type="checkbox"/> No		
204	<input type="checkbox"/> Yes, <input type="checkbox"/> No			254	<input type="checkbox"/> Yes, <input type="checkbox"/> No		
205	<input type="checkbox"/> Yes, <input type="checkbox"/> No			255	<input type="checkbox"/> Yes, <input type="checkbox"/> No		
206	<input type="checkbox"/> Yes, <input type="checkbox"/> No			256	<input type="checkbox"/> Yes, <input type="checkbox"/> No		
207	<input type="checkbox"/> Yes, <input type="checkbox"/> No			257	<input type="checkbox"/> Yes, <input type="checkbox"/> No		
208	<input type="checkbox"/> Yes, <input checked="" type="checkbox"/> No			258	<input checked="" type="checkbox"/> Yes, <input checked="" type="checkbox"/> No		
209	<input type="checkbox"/> Yes, <input type="checkbox"/> No			259	<input type="checkbox"/> Yes, <input type="checkbox"/> No		
210	<input type="checkbox"/> Yes, <input type="checkbox"/> No			260	<input type="checkbox"/> Yes, <input type="checkbox"/> No		
211	<input type="checkbox"/> Yes, <input type="checkbox"/> No			261	<input type="checkbox"/> Yes, <input type="checkbox"/> No		
212	<input type="checkbox"/> Yes, <input type="checkbox"/> No			262	<input type="checkbox"/> Yes, <input type="checkbox"/> No		
213	<input type="checkbox"/> Yes, <input type="checkbox"/> No			263	<input type="checkbox"/> Yes, <input type="checkbox"/> No		
214	<input checked="" type="checkbox"/> Yes, <input checked="" type="checkbox"/> No			264	<input type="checkbox"/> Yes, <input type="checkbox"/> No		
215	<input type="checkbox"/> Yes, <input type="checkbox"/> No			265	<input type="checkbox"/> Yes, <input type="checkbox"/> No		
216	<input type="checkbox"/> Yes, <input type="checkbox"/> No			266	<input type="checkbox"/> Yes, <input type="checkbox"/> No		
217	<input type="checkbox"/> Yes, <input type="checkbox"/> No			267	<input type="checkbox"/> Yes, <input type="checkbox"/> No		
218	<input type="checkbox"/> Yes, <input type="checkbox"/> No			268	<input type="checkbox"/> Yes, <input type="checkbox"/> No		
219	<input type="checkbox"/> Yes, <input type="checkbox"/> No			269	<input type="checkbox"/> Yes, <input type="checkbox"/> No		
220	<input type="checkbox"/> Yes, <input type="checkbox"/> No			270	<input type="checkbox"/> Yes, <input type="checkbox"/> No		
221	<input type="checkbox"/> Yes, <input type="checkbox"/> No			271	<input type="checkbox"/> Yes, <input type="checkbox"/> No		
222	<input type="checkbox"/> Yes, <input type="checkbox"/> No			272	<input type="checkbox"/> Yes, <input type="checkbox"/> No		
223	<input type="checkbox"/> Yes, <input type="checkbox"/> No			273	<input type="checkbox"/> Yes, <input type="checkbox"/> No		
224	<input type="checkbox"/> Yes, <input type="checkbox"/> No			274	<input type="checkbox"/> Yes, <input type="checkbox"/> No		
225	<input type="checkbox"/> Yes, <input type="checkbox"/> No			275	<input type="checkbox"/> Yes, <input type="checkbox"/> No		
226	<input type="checkbox"/> Yes, <input type="checkbox"/> No			276	<input type="checkbox"/> Yes, <input type="checkbox"/> No		
227	<input type="checkbox"/> Yes, <input type="checkbox"/> No			277	<input type="checkbox"/> Yes, <input type="checkbox"/> No		
228	<input type="checkbox"/> Yes, <input type="checkbox"/> No			278	<input type="checkbox"/> Yes, <input type="checkbox"/> No		
229	<input type="checkbox"/> Yes, <input type="checkbox"/> No			279	<input type="checkbox"/> Yes, <input type="checkbox"/> No		
230	<input type="checkbox"/> Yes, <input type="checkbox"/> No			280	<input type="checkbox"/> Yes, <input type="checkbox"/> No		
231	<input type="checkbox"/> Yes, <input type="checkbox"/> No			281	<input type="checkbox"/> Yes, <input type="checkbox"/> No		
232	<input type="checkbox"/> Yes, <input type="checkbox"/> No			282	<input type="checkbox"/> Yes, <input type="checkbox"/> No		
233	<input type="checkbox"/> Yes, <input type="checkbox"/> No			283	<input type="checkbox"/> Yes, <input type="checkbox"/> No		
234	<input type="checkbox"/> Yes, <input type="checkbox"/> No			284	<input type="checkbox"/> Yes, <input type="checkbox"/> No		
235	<input type="checkbox"/> Yes, <input type="checkbox"/> No			285	<input type="checkbox"/> Yes, <input type="checkbox"/> No		
236	<input type="checkbox"/> Yes, <input type="checkbox"/> No			286	<input type="checkbox"/> Yes, <input type="checkbox"/> No		
237	<input type="checkbox"/> Yes, <input type="checkbox"/> No			287	<input type="checkbox"/> Yes, <input type="checkbox"/> No		
238	<input type="checkbox"/> Yes, <input type="checkbox"/> No			288	<input type="checkbox"/> Yes, <input type="checkbox"/> No		
239	<input type="checkbox"/> Yes, <input type="checkbox"/> No			289	<input type="checkbox"/> Yes, <input type="checkbox"/> No		
240	<input type="checkbox"/> Yes, <input type="checkbox"/> No			290	<input type="checkbox"/> Yes, <input type="checkbox"/> No		
241	<input type="checkbox"/> Yes, <input type="checkbox"/> No			291	<input type="checkbox"/> Yes, <input type="checkbox"/> No		
242	<input type="checkbox"/> Yes, <input type="checkbox"/> No			292	<input type="checkbox"/> Yes, <input type="checkbox"/> No		
243	<input type="checkbox"/> Yes, <input type="checkbox"/> No			293	<input type="checkbox"/> Yes, <input type="checkbox"/> No		
244	<input type="checkbox"/> Yes, <input type="checkbox"/> No			294	<input type="checkbox"/> Yes, <input type="checkbox"/> No		
245	<input type="checkbox"/> Yes, <input type="checkbox"/> No			295	<input type="checkbox"/> Yes, <input type="checkbox"/> No		
246	<input type="checkbox"/> Yes, <input type="checkbox"/> No			296	<input type="checkbox"/> Yes, <input type="checkbox"/> No		
247	<input type="checkbox"/> Yes, <input type="checkbox"/> No			297	<input type="checkbox"/> Yes, <input type="checkbox"/> No		
248	<input type="checkbox"/> Yes, <input type="checkbox"/> No			298	<input type="checkbox"/> Yes, <input type="checkbox"/> No		
249	<input type="checkbox"/> Yes, <input type="checkbox"/> No			299	<input type="checkbox"/> Yes, <input type="checkbox"/> No		

TOLL RESTRICTION—AREA/OFFICE CODE TABLE (2/8)

Area/Office Code Table No. 5

Code No.	Local Call Access	Restriction Level	Office Code	Code No.	Local Call Access	Restriction Level	Office Code
300	<input type="checkbox"/> Yes, <input type="checkbox"/> No			350	<input type="checkbox"/> Yes, <input type="checkbox"/> No		
301	<input type="checkbox"/> Yes, <input type="checkbox"/> No			351	<input type="checkbox"/> Yes, <input type="checkbox"/> No		
302	<input type="checkbox"/> Yes, <input type="checkbox"/> No			352	<input type="checkbox"/> Yes, <input type="checkbox"/> No		
303	<input type="checkbox"/> Yes, <input type="checkbox"/> No			353	<input type="checkbox"/> Yes, <input type="checkbox"/> No		
304	<input type="checkbox"/> Yes, <input type="checkbox"/> No			354	<input type="checkbox"/> Yes, <input type="checkbox"/> No		
305	<input type="checkbox"/> Yes, <input type="checkbox"/> No			355	<input type="checkbox"/> Yes, <input type="checkbox"/> No		
306	<input type="checkbox"/> Yes, <input type="checkbox"/> No			356	<input type="checkbox"/> Yes, <input type="checkbox"/> No		
307	<input type="checkbox"/> Yes, <input type="checkbox"/> No			357	<input type="checkbox"/> Yes, <input type="checkbox"/> No		
308	<input type="checkbox"/> Yes, <input type="checkbox"/> No			358	<input type="checkbox"/> Yes, <input type="checkbox"/> No		
309	<input type="checkbox"/> Yes, <input type="checkbox"/> No			359	<input type="checkbox"/> Yes, <input type="checkbox"/> No		
310	<input type="checkbox"/> Yes, <input type="checkbox"/> No			360	<input type="checkbox"/> Yes, <input type="checkbox"/> No		
311	<input type="checkbox"/> Yes, <input type="checkbox"/> No			361	<input type="checkbox"/> Yes, <input type="checkbox"/> No		
312	<input type="checkbox"/> Yes, <input type="checkbox"/> No			362	<input type="checkbox"/> Yes, <input type="checkbox"/> No		
313	<input type="checkbox"/> Yes, <input type="checkbox"/> No			363	<input type="checkbox"/> Yes, <input type="checkbox"/> No		
314	<input type="checkbox"/> Yes, <input type="checkbox"/> No			364	<input type="checkbox"/> Yes, <input type="checkbox"/> No		
315	<input type="checkbox"/> Yes, <input type="checkbox"/> No			365	<input type="checkbox"/> Yes, <input type="checkbox"/> No		
316	<input type="checkbox"/> Yes, <input type="checkbox"/> No			366	<input type="checkbox"/> Yes, <input type="checkbox"/> No		
317	<input type="checkbox"/> Yes, <input type="checkbox"/> No			367	<input type="checkbox"/> Yes, <input type="checkbox"/> No		
318	<input type="checkbox"/> Yes, <input type="checkbox"/> No			368	<input type="checkbox"/> Yes, <input type="checkbox"/> No		
319	<input type="checkbox"/> Yes, <input type="checkbox"/> No			369	<input type="checkbox"/> Yes, <input type="checkbox"/> No		
320	<input type="checkbox"/> Yes, <input type="checkbox"/> No			370	<input type="checkbox"/> Yes, <input type="checkbox"/> No		
321	<input type="checkbox"/> Yes, <input type="checkbox"/> No			371	<input type="checkbox"/> Yes, <input type="checkbox"/> No		
322	<input type="checkbox"/> Yes, <input type="checkbox"/> No			372	<input type="checkbox"/> Yes, <input type="checkbox"/> No		
323	<input type="checkbox"/> Yes, <input type="checkbox"/> No			373	<input type="checkbox"/> Yes, <input type="checkbox"/> No		
324	<input type="checkbox"/> Yes, <input type="checkbox"/> No			374	<input type="checkbox"/> Yes, <input type="checkbox"/> No		
325	<input type="checkbox"/> Yes, <input type="checkbox"/> No			375	<input type="checkbox"/> Yes, <input type="checkbox"/> No		
326	<input type="checkbox"/> Yes, <input type="checkbox"/> No			376	<input type="checkbox"/> Yes, <input type="checkbox"/> No		
327	<input type="checkbox"/> Yes, <input type="checkbox"/> No			377	<input type="checkbox"/> Yes, <input type="checkbox"/> No		
328	<input type="checkbox"/> Yes, <input type="checkbox"/> No			378	<input type="checkbox"/> Yes, <input type="checkbox"/> No		
329	<input type="checkbox"/> Yes, <input type="checkbox"/> No			379	<input type="checkbox"/> Yes, <input type="checkbox"/> No		
330	<input type="checkbox"/> Yes, <input type="checkbox"/> No			380	<input type="checkbox"/> Yes, <input type="checkbox"/> No		
331	<input type="checkbox"/> Yes, <input type="checkbox"/> No			381	<input type="checkbox"/> Yes, <input type="checkbox"/> No		
332	<input type="checkbox"/> Yes, <input type="checkbox"/> No			382	<input type="checkbox"/> Yes, <input type="checkbox"/> No		
333	<input type="checkbox"/> Yes, <input type="checkbox"/> No			383	<input type="checkbox"/> Yes, <input type="checkbox"/> No		
334	<input type="checkbox"/> Yes, <input type="checkbox"/> No			384	<input type="checkbox"/> Yes, <input type="checkbox"/> No		
335	<input type="checkbox"/> Yes, <input type="checkbox"/> No			385	<input type="checkbox"/> Yes, <input type="checkbox"/> No		
336	<input type="checkbox"/> Yes, <input type="checkbox"/> No			386	<input type="checkbox"/> Yes, <input type="checkbox"/> No		
337	<input type="checkbox"/> Yes, <input type="checkbox"/> No			387	<input type="checkbox"/> Yes, <input type="checkbox"/> No		
338	<input type="checkbox"/> Yes, <input type="checkbox"/> No			388	<input type="checkbox"/> Yes, <input type="checkbox"/> No		
339	<input type="checkbox"/> Yes, <input type="checkbox"/> No			389	<input type="checkbox"/> Yes, <input type="checkbox"/> No		
340	<input type="checkbox"/> Yes, <input type="checkbox"/> No			390	<input type="checkbox"/> Yes, <input type="checkbox"/> No		
341	<input type="checkbox"/> Yes, <input type="checkbox"/> No			391	<input type="checkbox"/> Yes, <input type="checkbox"/> No		
342	<input type="checkbox"/> Yes, <input type="checkbox"/> No			392	<input type="checkbox"/> Yes, <input type="checkbox"/> No		
343	<input type="checkbox"/> Yes, <input type="checkbox"/> No			393	<input type="checkbox"/> Yes, <input type="checkbox"/> No		
344	<input type="checkbox"/> Yes, <input type="checkbox"/> No			394	<input type="checkbox"/> Yes, <input type="checkbox"/> No		
345	<input type="checkbox"/> Yes, <input type="checkbox"/> No			395	<input type="checkbox"/> Yes, <input type="checkbox"/> No		
346	<input type="checkbox"/> Yes, <input type="checkbox"/> No			396	<input type="checkbox"/> Yes, <input type="checkbox"/> No		
347	<input type="checkbox"/> Yes, <input type="checkbox"/> No			397	<input type="checkbox"/> Yes, <input type="checkbox"/> No		
348	<input type="checkbox"/> Yes, <input type="checkbox"/> No			398	<input type="checkbox"/> Yes, <input type="checkbox"/> No		
349	<input type="checkbox"/> Yes, <input type="checkbox"/> No			399	<input type="checkbox"/> Yes, <input type="checkbox"/> No		

TOLL RESTRICTION—AREA/OFFICE CODE TABLE (3/8)

Area/Office Code Table No. 5

Code No.	Local Call Access	Restriction Level	Office Code	Code No.	Local Call Access	Restriction Level	Office Code
400	<input type="checkbox"/> Yes <input type="checkbox"/> No			450			
401	<input type="checkbox"/> Yes <input type="checkbox"/> No			451			
402	<input type="checkbox"/> Yes <input type="checkbox"/> No			452	<input type="checkbox"/> Yes, <input type="checkbox"/> No		
403	<input type="checkbox"/> Yes <input type="checkbox"/> No			453	<input type="checkbox"/> Yes, <input type="checkbox"/> No		
404	<input type="checkbox"/> Yes <input type="checkbox"/> No			454	<input type="checkbox"/> Yes, <input type="checkbox"/> No		
405	<input type="checkbox"/> Yes <input type="checkbox"/> No			455	<input type="checkbox"/> Yes, <input type="checkbox"/> No		
406	<input type="checkbox"/> Yes <input type="checkbox"/> No			456	<input type="checkbox"/> Yes, <input type="checkbox"/> No		
407	<input type="checkbox"/> Yes <input type="checkbox"/> No			457	<input type="checkbox"/> Yes, <input type="checkbox"/> No		
408	<input type="checkbox"/> Yes <input type="checkbox"/> No			458	<input type="checkbox"/> Yes, <input type="checkbox"/> No		
409	<input type="checkbox"/> Yes <input type="checkbox"/> No			459	<input type="checkbox"/> Yes, <input type="checkbox"/> No		
410	<input type="checkbox"/> Yes <input type="checkbox"/> No			460	<input type="checkbox"/> Yes, <input type="checkbox"/> No		
411	<input type="checkbox"/> Yes <input type="checkbox"/> No			461	<input type="checkbox"/> Yes, <input type="checkbox"/> No		
412	<input type="checkbox"/> Yes <input type="checkbox"/> No			462	<input type="checkbox"/> Yes, <input type="checkbox"/> No		
413	<input type="checkbox"/> Yes <input type="checkbox"/> No			463	<input type="checkbox"/> Yes, <input type="checkbox"/> No		
414	<input type="checkbox"/> Yes <input type="checkbox"/> No			464	<input type="checkbox"/> Yes, <input type="checkbox"/> No		
415	<input type="checkbox"/> Yes <input type="checkbox"/> No			465	<input type="checkbox"/> Yes, <input type="checkbox"/> No		
416	<input type="checkbox"/> Yes <input type="checkbox"/> No			466	<input type="checkbox"/> Yes, <input type="checkbox"/> No		
417	<input type="checkbox"/> Yes <input type="checkbox"/> No			467	<input type="checkbox"/> Yes, <input type="checkbox"/> No		
418	<input type="checkbox"/> Yes <input type="checkbox"/> No			468	<input type="checkbox"/> Yes, <input type="checkbox"/> No		
419	<input type="checkbox"/> Yes <input type="checkbox"/> No			469	<input type="checkbox"/> Yes, <input type="checkbox"/> No		
420	<input type="checkbox"/> Yes <input type="checkbox"/> No			470	<input type="checkbox"/> Yes, <input type="checkbox"/> No		
421	<input type="checkbox"/> Yes <input type="checkbox"/> No			471	<input type="checkbox"/> Yes, <input type="checkbox"/> No		
422	<input type="checkbox"/> Yes <input type="checkbox"/> No			472	<input type="checkbox"/> Yes, <input type="checkbox"/> No		
423	<input type="checkbox"/> Yes <input type="checkbox"/> No			473	<input type="checkbox"/> Yes, <input type="checkbox"/> No		
424	<input type="checkbox"/> Yes <input type="checkbox"/> No			474	<input type="checkbox"/> Yes, <input type="checkbox"/> No		
425	<input type="checkbox"/> Yes <input type="checkbox"/> No			475	<input type="checkbox"/> Yes, <input type="checkbox"/> No		
426	<input type="checkbox"/> Yes <input type="checkbox"/> No			476	<input type="checkbox"/> Yes, <input type="checkbox"/> No		
427	<input type="checkbox"/> Yes <input type="checkbox"/> No			477	<input type="checkbox"/> Yes, <input type="checkbox"/> No		
428	<input type="checkbox"/> Yes <input type="checkbox"/> No			478	<input type="checkbox"/> Yes, <input type="checkbox"/> No		
429	<input type="checkbox"/> Yes <input type="checkbox"/> No			479	<input type="checkbox"/> Yes, <input type="checkbox"/> No		
430	<input type="checkbox"/> Yes <input type="checkbox"/> No			480	<input type="checkbox"/> Yes, <input type="checkbox"/> No		
431	<input type="checkbox"/> Yes <input type="checkbox"/> No			481	<input type="checkbox"/> Yes, <input type="checkbox"/> No		
432	<input type="checkbox"/> Yes <input type="checkbox"/> No			482	<input type="checkbox"/> Yes, <input type="checkbox"/> No		
433	<input type="checkbox"/> Yes <input type="checkbox"/> No			483	<input type="checkbox"/> Yes, <input type="checkbox"/> No		
434	<input type="checkbox"/> Yes <input type="checkbox"/> No			484	<input type="checkbox"/> Yes, <input type="checkbox"/> No		
435	<input type="checkbox"/> Yes <input type="checkbox"/> No			485	<input type="checkbox"/> Yes, <input type="checkbox"/> No		
436	<input type="checkbox"/> Yes <input type="checkbox"/> No			486	<input type="checkbox"/> Yes, <input type="checkbox"/> No		
437	<input type="checkbox"/> Yes <input type="checkbox"/> No			487	<input type="checkbox"/> Yes, <input type="checkbox"/> No		
438	<input type="checkbox"/> Yes <input type="checkbox"/> No			488	<input type="checkbox"/> Yes, <input type="checkbox"/> No		
439	<input type="checkbox"/> Yes <input type="checkbox"/> No			489	<input type="checkbox"/> Yes, <input type="checkbox"/> No		
440	<input type="checkbox"/> Yes <input type="checkbox"/> No			490	<input type="checkbox"/> Yes, <input type="checkbox"/> No		
441	<input type="checkbox"/> Yes <input type="checkbox"/> No			491	<input type="checkbox"/> Yes, <input type="checkbox"/> No		
442	<input type="checkbox"/> Yes <input type="checkbox"/> No			492	<input type="checkbox"/> Yes, <input type="checkbox"/> No		
443	<input type="checkbox"/> Yes <input type="checkbox"/> No			493	<input type="checkbox"/> Yes, <input type="checkbox"/> No		
444	<input type="checkbox"/> Yes <input type="checkbox"/> No			494	<input type="checkbox"/> Yes, <input type="checkbox"/> No		
445	<input type="checkbox"/> Yes <input type="checkbox"/> No			495	<input type="checkbox"/> Yes, <input type="checkbox"/> No		
446	<input type="checkbox"/> Yes <input type="checkbox"/> No			496	<input type="checkbox"/> Yes, <input type="checkbox"/> No		
447	<input type="checkbox"/> Yes <input type="checkbox"/> No			497	<input type="checkbox"/> Yes, <input type="checkbox"/> No		
448	<input type="checkbox"/> Yes <input type="checkbox"/> No			498	<input type="checkbox"/> Yes, <input type="checkbox"/> No		
449	<input type="checkbox"/> Yes <input type="checkbox"/> No			499	<input type="checkbox"/> Yes, <input type="checkbox"/> No		

TOLL RESTRICTION—AREA/OFFICE CODE TABLE (4/8)

Area/Office Code Table No. 5

Code No.	Local Call Access	Restriction Level	Office Code	Code No.	Local Call Access	Restriction Level	Office Code
500	<input type="checkbox"/> Yes, <input type="checkbox"/> No			550	<input type="checkbox"/> Yes, <input type="checkbox"/> No		
501	<input type="checkbox"/> Yes, <input type="checkbox"/> No			551	<input type="checkbox"/> Yes, <input type="checkbox"/> No		
502	<input type="checkbox"/> Yes, <input type="checkbox"/> No			552	<input type="checkbox"/> Yes, <input type="checkbox"/> No		
503	<input type="checkbox"/> Yes, <input type="checkbox"/> No			553	<input type="checkbox"/> Yes, <input type="checkbox"/> No		
504	<input type="checkbox"/> Yes, <input type="checkbox"/> No			554	<input type="checkbox"/> Yes, <input type="checkbox"/> No		
505	<input type="checkbox"/> Yes, <input type="checkbox"/> No			555	<input type="checkbox"/> Yes, <input type="checkbox"/> No		
506	<input type="checkbox"/> Yes, <input type="checkbox"/> No			556	<input type="checkbox"/> Yes, <input type="checkbox"/> No		
507	<input type="checkbox"/> Yes, <input type="checkbox"/> No			557	<input type="checkbox"/> Yes, <input type="checkbox"/> No		
508	<input type="checkbox"/> Yes, <input type="checkbox"/> No			558	<input type="checkbox"/> Yes, <input type="checkbox"/> No		
509	<input type="checkbox"/> Yes, <input type="checkbox"/> No			559	<input type="checkbox"/> Yes, <input type="checkbox"/> No		
510	<input type="checkbox"/> Yes, <input type="checkbox"/> No			560	<input type="checkbox"/> Yes, <input type="checkbox"/> No		
511	<input type="checkbox"/> Yes, <input type="checkbox"/> No			561	<input type="checkbox"/> Yes, <input type="checkbox"/> No		
512	<input type="checkbox"/> Yes, <input type="checkbox"/> No			562	<input type="checkbox"/> Yes, <input type="checkbox"/> No		
513	<input type="checkbox"/> Yes, <input type="checkbox"/> No			563	<input type="checkbox"/> Yes, <input type="checkbox"/> No		
514	<input type="checkbox"/> Yes, <input type="checkbox"/> No			564	<input type="checkbox"/> Yes, <input type="checkbox"/> No		
515	<input type="checkbox"/> Yes, <input type="checkbox"/> No			565	<input type="checkbox"/> Yes, <input type="checkbox"/> No		
516	<input type="checkbox"/> Yes, <input type="checkbox"/> No			566	<input type="checkbox"/> Yes, <input type="checkbox"/> No		
517	<input type="checkbox"/> Yes, <input type="checkbox"/> No			567	<input type="checkbox"/> Yes, <input type="checkbox"/> No		
518	<input type="checkbox"/> Yes, <input type="checkbox"/> No			568	<input type="checkbox"/> Yes, <input type="checkbox"/> No		
519	<input type="checkbox"/> Yes, <input type="checkbox"/> No			569	<input type="checkbox"/> Yes, <input type="checkbox"/> No		
520	<input type="checkbox"/> Yes, <input type="checkbox"/> No			570	<input type="checkbox"/> Yes, <input type="checkbox"/> No		
521	<input type="checkbox"/> Yes, <input type="checkbox"/> No			571	<input type="checkbox"/> Yes, <input type="checkbox"/> No		
522	<input type="checkbox"/> Yes, <input type="checkbox"/> No			572	<input type="checkbox"/> Yes, <input type="checkbox"/> No		
523	<input type="checkbox"/> Yes, <input type="checkbox"/> No			573	<input type="checkbox"/> Yes, <input type="checkbox"/> No		
524	<input type="checkbox"/> Yes, <input type="checkbox"/> No			574	<input type="checkbox"/> Yes, <input type="checkbox"/> No		
525	<input type="checkbox"/> Yes, <input type="checkbox"/> No			575	<input type="checkbox"/> Yes, <input type="checkbox"/> No		
526	<input type="checkbox"/> Yes, <input type="checkbox"/> No			576	<input type="checkbox"/> Yes, <input type="checkbox"/> No		
527	<input type="checkbox"/> Yes, <input type="checkbox"/> No			577	<input type="checkbox"/> Yes, <input type="checkbox"/> No		
528	<input type="checkbox"/> Yes, <input type="checkbox"/> No			578	<input type="checkbox"/> Yes, <input type="checkbox"/> No		
529	<input type="checkbox"/> Yes, <input type="checkbox"/> No			579	<input type="checkbox"/> Yes, <input type="checkbox"/> No		
530	<input type="checkbox"/> Yes, <input type="checkbox"/> No			580	<input type="checkbox"/> Yes, <input type="checkbox"/> No		
531	<input type="checkbox"/> Yes, <input type="checkbox"/> No			581	<input type="checkbox"/> Yes, <input type="checkbox"/> No		
532	<input type="checkbox"/> Yes, <input type="checkbox"/> No			582	<input type="checkbox"/> Yes, <input type="checkbox"/> No		
533	<input type="checkbox"/> Yes, <input type="checkbox"/> No			583	<input type="checkbox"/> Yes, <input type="checkbox"/> No		
534	<input type="checkbox"/> Yes, <input type="checkbox"/> No			584	<input type="checkbox"/> Yes, <input type="checkbox"/> No		
535	<input type="checkbox"/> Yes, <input type="checkbox"/> No			585	<input type="checkbox"/> Yes, <input type="checkbox"/> No		
536	<input type="checkbox"/> Yes, <input type="checkbox"/> No			586	<input type="checkbox"/> Yes, <input type="checkbox"/> No		
537	<input type="checkbox"/> Yes, <input type="checkbox"/> No			587	<input type="checkbox"/> Yes, <input type="checkbox"/> No		
538	<input type="checkbox"/> Yes, <input type="checkbox"/> No			588	<input type="checkbox"/> Yes, <input type="checkbox"/> No		
539	<input type="checkbox"/> Yes, <input type="checkbox"/> No			589	<input type="checkbox"/> Yes, <input type="checkbox"/> No		
540	<input type="checkbox"/> Yes, <input type="checkbox"/> No			590	<input type="checkbox"/> Yes, <input type="checkbox"/> No		
541	<input type="checkbox"/> Yes, <input type="checkbox"/> No			591	<input type="checkbox"/> Yes, <input type="checkbox"/> No		
542	<input type="checkbox"/> Yes, <input type="checkbox"/> No			592	<input type="checkbox"/> Yes, <input type="checkbox"/> No		
543	<input type="checkbox"/> Yes, <input type="checkbox"/> No			593	<input type="checkbox"/> Yes, <input type="checkbox"/> No		
544	<input type="checkbox"/> Yes, <input type="checkbox"/> No			594	<input type="checkbox"/> Yes, <input type="checkbox"/> No		
545	<input type="checkbox"/> Yes, <input type="checkbox"/> No			595	<input type="checkbox"/> Yes, <input type="checkbox"/> No		
546	<input type="checkbox"/> Yes, <input type="checkbox"/> No			596	<input type="checkbox"/> Yes, <input type="checkbox"/> No		
547	<input type="checkbox"/> Yes, <input type="checkbox"/> No			597	<input type="checkbox"/> Yes, <input type="checkbox"/> No		
548	<input type="checkbox"/> Yes, <input type="checkbox"/> No			598	<input type="checkbox"/> Yes, <input type="checkbox"/> No		
549	<input type="checkbox"/> Yes, <input type="checkbox"/> No			599	<input type="checkbox"/> Yes, <input type="checkbox"/> No		

TOLL RESTRICTION-AREA/OFFICE CODE TABLE (5/8)

Area/Office Code Table No. 5

Code No.	Local Call Access	Restriction Level	Office Code	Code No.	Local Call Access	Restriction Level	Office Code
600	<input type="checkbox"/> Yes, <input type="checkbox"/> No			650	<input type="checkbox"/> Yes, <input type="checkbox"/> No		
601	<input type="checkbox"/> Yes, <input type="checkbox"/> No			651	<input type="checkbox"/> Yes, <input type="checkbox"/> No		
602	<input type="checkbox"/> Yes, <input type="checkbox"/> No			652	<input type="checkbox"/> Yes, <input type="checkbox"/> No		
603	<input type="checkbox"/> Yes, <input type="checkbox"/> No			653	<input type="checkbox"/> Yes, <input type="checkbox"/> No		
604	<input type="checkbox"/> Yes, <input type="checkbox"/> No			654	<input type="checkbox"/> Yes, <input type="checkbox"/> No		
605	<input type="checkbox"/> Yes, <input type="checkbox"/> No			655	<input type="checkbox"/> Yes, <input type="checkbox"/> No		
606	<input type="checkbox"/> Yes, <input type="checkbox"/> No			656	<input type="checkbox"/> Yes, <input type="checkbox"/> No		
607	<input type="checkbox"/> Yes, <input type="checkbox"/> No			657	<input type="checkbox"/> Yes, <input type="checkbox"/> No		
608	<input type="checkbox"/> Yes, <input type="checkbox"/> No			658	<input type="checkbox"/> Yes, <input type="checkbox"/> No		
609	<input type="checkbox"/> Yes, <input type="checkbox"/> No			659	<input type="checkbox"/> Yes, <input type="checkbox"/> No		
610	<input type="checkbox"/> Yes, <input type="checkbox"/> No			660	<input type="checkbox"/> Yes, <input type="checkbox"/> No		
611	<input type="checkbox"/> Yes, <input type="checkbox"/> No			661	<input type="checkbox"/> Yes, <input type="checkbox"/> No		
612	<input type="checkbox"/> Yes, <input type="checkbox"/> No			662	<input type="checkbox"/> Yes, <input type="checkbox"/> No		
613	<input type="checkbox"/> Yes, <input type="checkbox"/> No			663	<input type="checkbox"/> Yes, <input type="checkbox"/> No		
614	<input type="checkbox"/> Yes, <input type="checkbox"/> No			664	<input type="checkbox"/> Yes, <input type="checkbox"/> No		
615	<input type="checkbox"/> Yes, <input type="checkbox"/> No			665	<input type="checkbox"/> Yes, <input type="checkbox"/> No		
616	<input type="checkbox"/> Yes, <input type="checkbox"/> No			666	<input type="checkbox"/> Yes, <input type="checkbox"/> No		
617	<input type="checkbox"/> Yes, <input type="checkbox"/> No			667	<input type="checkbox"/> Yes, <input type="checkbox"/> No		
618	<input type="checkbox"/> Yes, <input type="checkbox"/> No			668	<input type="checkbox"/> Yes, <input type="checkbox"/> No		
619	<input type="checkbox"/> Yes, <input type="checkbox"/> No			669	<input type="checkbox"/> Yes, <input type="checkbox"/> No		
620	<input type="checkbox"/> Yes, <input type="checkbox"/> No			670	<input type="checkbox"/> Yes, <input type="checkbox"/> No		
621	<input type="checkbox"/> Yes, <input type="checkbox"/> No			671	<input type="checkbox"/> Yes, <input type="checkbox"/> No		
622	<input type="checkbox"/> Yes, <input type="checkbox"/> No			672	<input type="checkbox"/> Yes, <input type="checkbox"/> No		
623	<input type="checkbox"/> Yes, <input type="checkbox"/> No			673	<input type="checkbox"/> Yes, <input type="checkbox"/> No		
624	<input type="checkbox"/> Yes, <input type="checkbox"/> No			674	<input type="checkbox"/> Yes, <input type="checkbox"/> No		
625	<input type="checkbox"/> Yes, <input type="checkbox"/> No			675	<input type="checkbox"/> Yes, <input type="checkbox"/> No		
626	<input type="checkbox"/> Yes, <input type="checkbox"/> No			676	<input type="checkbox"/> Yes, <input type="checkbox"/> No		
627	<input type="checkbox"/> Yes, <input type="checkbox"/> No			677	<input type="checkbox"/> Yes, <input type="checkbox"/> No		
628	<input type="checkbox"/> Yes, <input type="checkbox"/> No			678	<input type="checkbox"/> Yes, <input type="checkbox"/> No		
629	<input type="checkbox"/> Yes, <input type="checkbox"/> No			679	<input type="checkbox"/> Yes, <input type="checkbox"/> No		
630	<input type="checkbox"/> Yes, <input type="checkbox"/> No			680	<input type="checkbox"/> Yes, <input type="checkbox"/> No		
631	<input type="checkbox"/> Yes, <input type="checkbox"/> No			681	<input type="checkbox"/> Yes, <input type="checkbox"/> No		
632	<input type="checkbox"/> Yes, <input type="checkbox"/> No			682	<input type="checkbox"/> Yes, <input type="checkbox"/> No		
633	<input type="checkbox"/> Yes, <input type="checkbox"/> No			683	<input type="checkbox"/> Yes, <input type="checkbox"/> No		
634	<input type="checkbox"/> Yes, <input type="checkbox"/> No			684	<input type="checkbox"/> Yes, <input type="checkbox"/> No		
635	<input type="checkbox"/> Yes, <input type="checkbox"/> No			685	<input type="checkbox"/> Yes, <input type="checkbox"/> No		
636	<input type="checkbox"/> Yes, <input type="checkbox"/> No			686	<input type="checkbox"/> Yes, <input type="checkbox"/> No		
637	<input type="checkbox"/> Yes, <input type="checkbox"/> No			687	<input type="checkbox"/> Yes, <input type="checkbox"/> No		
638	<input type="checkbox"/> Yes, <input type="checkbox"/> No			688	<input type="checkbox"/> Yes, <input type="checkbox"/> No		
639	<input type="checkbox"/> Yes, <input type="checkbox"/> No			689	<input type="checkbox"/> Yes, <input type="checkbox"/> No		
640	<input type="checkbox"/> Yes, <input type="checkbox"/> No			690	<input type="checkbox"/> Yes, <input type="checkbox"/> No		
641	<input type="checkbox"/> Yes, <input type="checkbox"/> No			691	<input type="checkbox"/> Yes, <input type="checkbox"/> No		
642	<input type="checkbox"/> Yes, <input type="checkbox"/> No			692	<input type="checkbox"/> Yes, <input type="checkbox"/> No		
643	<input type="checkbox"/> Yes, <input type="checkbox"/> No			693	<input type="checkbox"/> Yes, <input type="checkbox"/> No		
644	<input type="checkbox"/> Yes, <input type="checkbox"/> No			694	<input type="checkbox"/> Yes, <input type="checkbox"/> No		
645	<input type="checkbox"/> Yes, <input type="checkbox"/> No			695	<input type="checkbox"/> Yes, <input type="checkbox"/> No		
646	<input type="checkbox"/> Yes, <input type="checkbox"/> No			696	<input type="checkbox"/> Yes, <input type="checkbox"/> No		
647	<input type="checkbox"/> Yes, <input type="checkbox"/> No			697	<input type="checkbox"/> Yes, <input type="checkbox"/> No		
648	<input type="checkbox"/> Yes, <input type="checkbox"/> No			698	<input type="checkbox"/> Yes, <input type="checkbox"/> No		
649	<input type="checkbox"/> Yes, <input type="checkbox"/> No			699	<input type="checkbox"/> Yes, <input type="checkbox"/> No		

TOLL RESTRICTION-AREA/OFFICE CODE TABLE (6/8)

Area/Office Code Table No. 5

Code No.	Local Call Access	Restriction Level	Office Code	Code No.	Local Call Access	Restriction Level	Office Code
700	<input type="checkbox"/> Yes <input type="checkbox"/> No			750	<input type="checkbox"/> Yes, <input type="checkbox"/> No		
701	<input type="checkbox"/> Yes <input type="checkbox"/> No			751	<input type="checkbox"/> Yes, <input type="checkbox"/> No		
702	<input type="checkbox"/> Yes <input type="checkbox"/> No			752	<input type="checkbox"/> Yes, <input type="checkbox"/> No		
703	<input type="checkbox"/> Yes <input type="checkbox"/> No			753	<input type="checkbox"/> Yes, <input type="checkbox"/> No		
704	<input type="checkbox"/> Yes <input type="checkbox"/> No			754	<input type="checkbox"/> Yes, <input type="checkbox"/> No		
705	<input type="checkbox"/> Yes <input type="checkbox"/> No			755	<input type="checkbox"/> Yes, <input type="checkbox"/> No		
706	<input type="checkbox"/> Yes <input type="checkbox"/> No			756	<input type="checkbox"/> Yes, <input type="checkbox"/> No		
707	<input type="checkbox"/> Yes <input type="checkbox"/> No			757	<input type="checkbox"/> Yes, <input type="checkbox"/> No		
708	<input type="checkbox"/> Yes <input type="checkbox"/> No			758	<input type="checkbox"/> Yes, <input type="checkbox"/> No		
709	<input type="checkbox"/> Yes <input type="checkbox"/> No			759	<input type="checkbox"/> Yes, <input type="checkbox"/> No		
710	<input type="checkbox"/> Yes <input type="checkbox"/> No			760	<input type="checkbox"/> Yes, <input type="checkbox"/> No		
711	<input type="checkbox"/> Yes <input type="checkbox"/> No			761	<input type="checkbox"/> Yes, <input type="checkbox"/> No		
712	<input type="checkbox"/> Yes <input type="checkbox"/> No			762	<input type="checkbox"/> Yes, <input type="checkbox"/> No		
713	<input type="checkbox"/> Yes <input type="checkbox"/> No			763	<input type="checkbox"/> Yes, <input type="checkbox"/> No		
714	<input type="checkbox"/> Yes <input type="checkbox"/> No			764	<input type="checkbox"/> Yes, <input type="checkbox"/> No		
715	<input type="checkbox"/> Yes <input type="checkbox"/> No			765	<input type="checkbox"/> Yes, <input type="checkbox"/> No		
716	<input type="checkbox"/> Yes <input type="checkbox"/> No			766	<input type="checkbox"/> Yes, <input type="checkbox"/> No		
717	<input type="checkbox"/> Yes <input type="checkbox"/> No			767	<input type="checkbox"/> Yes, <input type="checkbox"/> No		
718	<input type="checkbox"/> Yes <input type="checkbox"/> No			768	<input type="checkbox"/> Yes, <input type="checkbox"/> No		
719	<input type="checkbox"/> Yes <input type="checkbox"/> No			769	<input type="checkbox"/> Yes, <input type="checkbox"/> No		
720	<input type="checkbox"/> Yes <input type="checkbox"/> No			770	<input type="checkbox"/> Yes, <input type="checkbox"/> No		
721	<input type="checkbox"/> Yes <input type="checkbox"/> No			771	<input type="checkbox"/> Yes, <input type="checkbox"/> No		
722	<input type="checkbox"/> Yes <input type="checkbox"/> No			772	<input type="checkbox"/> Yes, <input type="checkbox"/> No		
723	<input type="checkbox"/> Yes <input type="checkbox"/> No			773	<input type="checkbox"/> Yes, <input type="checkbox"/> No		
724	<input type="checkbox"/> Yes <input type="checkbox"/> No			774	<input type="checkbox"/> Yes, <input type="checkbox"/> No		
725	<input type="checkbox"/> Yes <input type="checkbox"/> No			775	<input type="checkbox"/> Yes, <input type="checkbox"/> No		
726	<input type="checkbox"/> Yes <input type="checkbox"/> No			776	<input type="checkbox"/> Yes, <input type="checkbox"/> No		
727	<input type="checkbox"/> Yes <input type="checkbox"/> No			777	<input type="checkbox"/> Yes, <input type="checkbox"/> No		
728	<input type="checkbox"/> Yes <input type="checkbox"/> No			778	<input type="checkbox"/> Yes, <input type="checkbox"/> No		
729	<input type="checkbox"/> Yes <input type="checkbox"/> No			779	<input type="checkbox"/> Yes, <input type="checkbox"/> No		
730	<input type="checkbox"/> Yes <input type="checkbox"/> No			780	<input type="checkbox"/> Yes, <input type="checkbox"/> No		
731	<input type="checkbox"/> Yes <input type="checkbox"/> No			781	<input type="checkbox"/> Yes, <input type="checkbox"/> No		
732	<input type="checkbox"/> Yes <input type="checkbox"/> No			782	<input type="checkbox"/> Yes, <input type="checkbox"/> No		
733	<input type="checkbox"/> Yes <input type="checkbox"/> No			783	<input type="checkbox"/> Yes, <input type="checkbox"/> No		
734	<input type="checkbox"/> Yes <input type="checkbox"/> No			784	<input type="checkbox"/> Yes, <input type="checkbox"/> No		
735	<input type="checkbox"/> Yes <input type="checkbox"/> No			785	<input type="checkbox"/> Yes, <input type="checkbox"/> No		
736	<input type="checkbox"/> Yes <input type="checkbox"/> No			786	<input type="checkbox"/> Yes, <input type="checkbox"/> No		
737	<input type="checkbox"/> Yes <input type="checkbox"/> No			787	<input type="checkbox"/> Yes, <input type="checkbox"/> No		
738	<input type="checkbox"/> Yes <input type="checkbox"/> No			788	<input type="checkbox"/> Yes, <input type="checkbox"/> No		
739	<input type="checkbox"/> Yes <input type="checkbox"/> No			789	<input type="checkbox"/> Yes, <input type="checkbox"/> No		
740	<input type="checkbox"/> Yes <input type="checkbox"/> No			790	<input type="checkbox"/> Yes, <input type="checkbox"/> No		
741	<input type="checkbox"/> Yes <input type="checkbox"/> No			791	<input type="checkbox"/> Yes, <input type="checkbox"/> No		
742	<input type="checkbox"/> Yes <input type="checkbox"/> No			792	<input type="checkbox"/> Yes, <input type="checkbox"/> No		
743	<input type="checkbox"/> Yes <input type="checkbox"/> No			793	<input type="checkbox"/> Yes, <input type="checkbox"/> No		
744	<input type="checkbox"/> Yes <input type="checkbox"/> No			794	<input type="checkbox"/> Yes, <input type="checkbox"/> No		
745	<input type="checkbox"/> Yes <input type="checkbox"/> No			795	<input type="checkbox"/> Yes, <input type="checkbox"/> No		
746	<input type="checkbox"/> Yes <input type="checkbox"/> No			796	<input type="checkbox"/> Yes, <input type="checkbox"/> No		
747	<input type="checkbox"/> Yes <input type="checkbox"/> No			797	<input type="checkbox"/> Yes, <input type="checkbox"/> No		
748	<input type="checkbox"/> Yes <input type="checkbox"/> No			798	<input type="checkbox"/> Yes, <input type="checkbox"/> No		
749	<input type="checkbox"/> Yes <input type="checkbox"/> No			799	<input type="checkbox"/> Yes, <input type="checkbox"/> No		

TOLL RESTRICTION-AREA/OFFICE CODE TABLE (7/8)

Area/Office Code Table No. 5

Code No.	Local Call Access	Restriction Level	Office Code	Code No.	Local Call Access	Restriction Level	Office Code
800	<input type="checkbox"/> Yes, <input type="checkbox"/> No			850	<input type="checkbox"/> Yes, <input type="checkbox"/> No		
801	<input type="checkbox"/> Yes, <input checked="" type="checkbox"/> No			851	<input type="checkbox"/> Yes, <input type="checkbox"/> No		
802	<input type="checkbox"/> Yes, <input type="checkbox"/> No			852	<input type="checkbox"/> Yes, <input type="checkbox"/> No		
803	<input type="checkbox"/> Yes, <input type="checkbox"/> No			853	<input type="checkbox"/> Yes, <input type="checkbox"/> No		
804	<input type="checkbox"/> Yes, <input type="checkbox"/> No			854	<input type="checkbox"/> Yes, <input type="checkbox"/> No		
805	<input type="checkbox"/> Yes, <input type="checkbox"/> No			855	<input type="checkbox"/> Yes, <input type="checkbox"/> No		
806	<input type="checkbox"/> Yes, <input type="checkbox"/> No			856	<input type="checkbox"/> Yes, <input type="checkbox"/> No		
807	<input type="checkbox"/> Yes, <input type="checkbox"/> No			857	<input type="checkbox"/> Yes, <input type="checkbox"/> No		
808	<input type="checkbox"/> Yes, <input type="checkbox"/> No			858	<input type="checkbox"/> Yes, <input type="checkbox"/> No		
809	<input type="checkbox"/> Yes, <input type="checkbox"/> No			859	<input type="checkbox"/> Yes, <input type="checkbox"/> No		
810	<input type="checkbox"/> Yes, <input checked="" type="checkbox"/> No			860	<input type="checkbox"/> Yes, <input type="checkbox"/> No		
811	<input type="checkbox"/> Yes, <input type="checkbox"/> No			861	<input type="checkbox"/> Yes, <input type="checkbox"/> No		
812	<input type="checkbox"/> Yes, <input type="checkbox"/> No			862	<input type="checkbox"/> Yes, <input type="checkbox"/> No		
813	<input type="checkbox"/> Yes, <input type="checkbox"/> No			863	<input type="checkbox"/> Yes, <input type="checkbox"/> No		
814	<input type="checkbox"/> Yes, <input type="checkbox"/> No			864	<input type="checkbox"/> Yes, <input type="checkbox"/> No		
815	<input type="checkbox"/> Yes, <input type="checkbox"/> No			865	<input type="checkbox"/> Yes, <input type="checkbox"/> No		
816	<input type="checkbox"/> Yes, <input type="checkbox"/> No			866	<input type="checkbox"/> Yes, <input type="checkbox"/> No		
817	<input type="checkbox"/> Yes, <input type="checkbox"/> No			867	<input type="checkbox"/> Yes, <input type="checkbox"/> No		
818	<input type="checkbox"/> Yes, <input type="checkbox"/> No			868	<input type="checkbox"/> Yes, <input type="checkbox"/> No		
819	<input type="checkbox"/> Yes, <input type="checkbox"/> No			869	<input type="checkbox"/> Yes, <input type="checkbox"/> No		
820	<input type="checkbox"/> Yes, <input type="checkbox"/> No			870	<input type="checkbox"/> Yes, <input type="checkbox"/> No		
821	<input type="checkbox"/> Yes, <input type="checkbox"/> No			871	<input type="checkbox"/> Yes, <input type="checkbox"/> No		
822	<input type="checkbox"/> Yes, <input type="checkbox"/> No			872	<input type="checkbox"/> Yes, <input type="checkbox"/> No		
823	<input type="checkbox"/> Yes, <input type="checkbox"/> No			873	<input type="checkbox"/> Yes, <input type="checkbox"/> No		
824	<input type="checkbox"/> Yes, <input type="checkbox"/> No			874	<input type="checkbox"/> Yes, <input type="checkbox"/> No		
825	<input type="checkbox"/> Yes, <input type="checkbox"/> No			875	<input type="checkbox"/> Yes, <input type="checkbox"/> No		
826	<input type="checkbox"/> Yes, <input type="checkbox"/> No			876	<input type="checkbox"/> Yes, <input type="checkbox"/> No		
827	<input type="checkbox"/> Yes, <input type="checkbox"/> No			877	<input type="checkbox"/> Yes, <input type="checkbox"/> No		
828	<input type="checkbox"/> Yes, <input type="checkbox"/> No			878	<input type="checkbox"/> Yes, <input type="checkbox"/> No		
829	<input type="checkbox"/> Yes, <input type="checkbox"/> No			879	<input type="checkbox"/> Yes, <input type="checkbox"/> No		
830	<input type="checkbox"/> Yes, <input type="checkbox"/> No			880	<input type="checkbox"/> Yes, <input type="checkbox"/> No		
831	<input type="checkbox"/> Yes, <input type="checkbox"/> No			881	<input type="checkbox"/> Yes, <input type="checkbox"/> No		
832	<input type="checkbox"/> Yes, <input type="checkbox"/> No			882	<input type="checkbox"/> Yes, <input type="checkbox"/> No		
833	<input type="checkbox"/> Yes, <input type="checkbox"/> No			883	<input type="checkbox"/> Yes, <input type="checkbox"/> No		
834	<input type="checkbox"/> Yes, <input type="checkbox"/> No			884	<input type="checkbox"/> Yes, <input type="checkbox"/> No		
835	<input type="checkbox"/> Yes, <input type="checkbox"/> No			885	<input type="checkbox"/> Yes, <input type="checkbox"/> No		
836	<input type="checkbox"/> Yes, <input type="checkbox"/> No			886	<input type="checkbox"/> Yes, <input type="checkbox"/> No		
837	<input type="checkbox"/> Yes, <input type="checkbox"/> No			887	<input type="checkbox"/> Yes, <input type="checkbox"/> No		
838	<input type="checkbox"/> Yes, <input type="checkbox"/> No			888	<input type="checkbox"/> Yes, <input type="checkbox"/> No		
839	<input type="checkbox"/> Yes, <input type="checkbox"/> No			889	<input type="checkbox"/> Yes, <input type="checkbox"/> No		
840	<input type="checkbox"/> Yes, <input type="checkbox"/> No			890	<input type="checkbox"/> Yes, <input type="checkbox"/> No		
841	<input type="checkbox"/> Yes, <input type="checkbox"/> No			891	<input type="checkbox"/> Yes, <input type="checkbox"/> No		
842	<input type="checkbox"/> Yes, <input type="checkbox"/> No			892	<input type="checkbox"/> Yes, <input type="checkbox"/> No		
843	<input type="checkbox"/> Yes, <input type="checkbox"/> No			893	<input type="checkbox"/> Yes, <input type="checkbox"/> No		
844	<input type="checkbox"/> Yes, <input type="checkbox"/> No			894	<input type="checkbox"/> Yes, <input type="checkbox"/> No		
845	<input type="checkbox"/> Yes, <input type="checkbox"/> No			895	<input type="checkbox"/> Yes, <input type="checkbox"/> No		
846	<input type="checkbox"/> Yes, <input type="checkbox"/> No			896	<input type="checkbox"/> Yes, <input type="checkbox"/> No		
847	<input type="checkbox"/> Yes, <input type="checkbox"/> No			897	<input type="checkbox"/> Yes, <input type="checkbox"/> No		
848	<input type="checkbox"/> Yes, <input type="checkbox"/> No			898	<input type="checkbox"/> Yes, <input type="checkbox"/> No		
849	<input type="checkbox"/> Yes, <input type="checkbox"/> No			899	<input type="checkbox"/> Yes, <input type="checkbox"/> No		

TOLL RESTRICTION-AREA/OFFICE CODE TABLE (8/8)

Area/Office Cods Table No 5

Code No.	Local Call Access	Restriction Level	Office Code	Code No.	Local Call Access	Restriction Level	Office Code
900	<input type="checkbox"/> Yes, <input type="checkbox"/> No			950	<input type="checkbox"/> Yes, <input type="checkbox"/> No		
901	<input type="checkbox"/> Yes, <input type="checkbox"/> No			951	<input type="checkbox"/> Yes, <input type="checkbox"/> No		
902	<input type="checkbox"/> Yes, <input type="checkbox"/> No			952	<input type="checkbox"/> Yes, <input type="checkbox"/> No		
903	<input type="checkbox"/> Yes, <input type="checkbox"/> No			953	<input type="checkbox"/> Yes, <input type="checkbox"/> No		
904	<input type="checkbox"/> Yes, <input type="checkbox"/> No			954	<input type="checkbox"/> Yes, <input type="checkbox"/> No		
905	<input type="checkbox"/> Yes, <input type="checkbox"/> No			955	<input type="checkbox"/> Yes, <input type="checkbox"/> No		
906	<input type="checkbox"/> Yes, <input type="checkbox"/> No			956	<input type="checkbox"/> Yes, <input type="checkbox"/> No		
907	<input type="checkbox"/> Yes, <input type="checkbox"/> No			957	<input type="checkbox"/> Yes, <input type="checkbox"/> No		
908	<input type="checkbox"/> Yes, <input type="checkbox"/> No			958	<input type="checkbox"/> Yes, <input type="checkbox"/> No		
909	<input type="checkbox"/> Yes, <input type="checkbox"/> No			959	<input type="checkbox"/> Yes, <input type="checkbox"/> No		
910	<input type="checkbox"/> Yes, <input type="checkbox"/> No			960	<input type="checkbox"/> Yes, <input type="checkbox"/> No		
911	<input type="checkbox"/> Yes, <input type="checkbox"/> No			961	<input type="checkbox"/> Yes, <input type="checkbox"/> No		
912	<input type="checkbox"/> Yes, <input type="checkbox"/> No			962	<input type="checkbox"/> Yes, <input type="checkbox"/> No		
913	<input type="checkbox"/> Yes, <input type="checkbox"/> No			963	<input type="checkbox"/> Yes, <input type="checkbox"/> No		
914	<input type="checkbox"/> Yes, <input type="checkbox"/> No			964	<input type="checkbox"/> Yes, <input type="checkbox"/> No		
915	<input type="checkbox"/> Yes, <input type="checkbox"/> No			965	<input type="checkbox"/> Yes, <input type="checkbox"/> No		
916	<input type="checkbox"/> Yes, <input type="checkbox"/> No			966	<input type="checkbox"/> Yes, <input type="checkbox"/> No		
917	<input type="checkbox"/> Yes, <input type="checkbox"/> No			967	<input type="checkbox"/> Yes, <input type="checkbox"/> No		
918	<input type="checkbox"/> Yes, <input type="checkbox"/> No			968	<input type="checkbox"/> Yes, <input type="checkbox"/> No		
919	<input type="checkbox"/> Yes, <input type="checkbox"/> No			969	<input type="checkbox"/> Yes, <input type="checkbox"/> No		
920	<input type="checkbox"/> Yes, <input type="checkbox"/> No			970	<input type="checkbox"/> Yes, <input type="checkbox"/> No		
921	<input type="checkbox"/> Yes, <input type="checkbox"/> No			971	<input type="checkbox"/> Yes, <input type="checkbox"/> No		
922	<input type="checkbox"/> Yes, <input type="checkbox"/> No			972	<input type="checkbox"/> Yes, <input type="checkbox"/> No		
923	<input type="checkbox"/> Yes, <input type="checkbox"/> No			973	<input type="checkbox"/> Yes, <input type="checkbox"/> No		
924	<input type="checkbox"/> Yes, <input type="checkbox"/> No			974	<input type="checkbox"/> Yes, <input type="checkbox"/> No		
925	<input type="checkbox"/> Yes, <input type="checkbox"/> No			975	<input type="checkbox"/> Yes, <input type="checkbox"/> No		
926	<input type="checkbox"/> Yes, <input type="checkbox"/> No			976	<input type="checkbox"/> Yes, <input type="checkbox"/> No		
927	<input type="checkbox"/> Yes, <input type="checkbox"/> No			977	<input type="checkbox"/> Yes, <input type="checkbox"/> No		
928	<input type="checkbox"/> Yes, <input type="checkbox"/> No			978	<input type="checkbox"/> Yes, <input type="checkbox"/> No		
929	<input type="checkbox"/> Yes, <input type="checkbox"/> No			979	<input type="checkbox"/> Yes, <input type="checkbox"/> No		
930	<input type="checkbox"/> Yes, <input type="checkbox"/> No			980	<input type="checkbox"/> Yes, <input type="checkbox"/> No		
931	<input type="checkbox"/> Yes, <input type="checkbox"/> No			981	<input type="checkbox"/> Yes, <input type="checkbox"/> No		
932	<input type="checkbox"/> Yes, <input type="checkbox"/> No			982	<input type="checkbox"/> Yes, <input type="checkbox"/> No		
933	<input type="checkbox"/> Yes, <input type="checkbox"/> No			983	<input type="checkbox"/> Yes, <input type="checkbox"/> No		
934	<input type="checkbox"/> Yes, <input type="checkbox"/> No			984	<input type="checkbox"/> Yes, <input type="checkbox"/> No		
935	<input type="checkbox"/> Yes, <input type="checkbox"/> No			985	<input type="checkbox"/> Yes, <input type="checkbox"/> No		
936	<input type="checkbox"/> Yes, <input type="checkbox"/> No			986	<input type="checkbox"/> Yes, <input type="checkbox"/> No		
937	<input type="checkbox"/> Yes, <input type="checkbox"/> No			987	<input type="checkbox"/> Yes, <input type="checkbox"/> No		
938	<input type="checkbox"/> Yes, <input type="checkbox"/> No			988	<input type="checkbox"/> Yes, <input type="checkbox"/> No		
939	<input type="checkbox"/> Yes, <input type="checkbox"/> No			989	<input type="checkbox"/> Yes, <input type="checkbox"/> No		
940	<input type="checkbox"/> Yes, <input type="checkbox"/> No			990	<input type="checkbox"/> Yes, <input type="checkbox"/> No		
941	<input type="checkbox"/> Yes, <input type="checkbox"/> No			991	<input type="checkbox"/> Yes, <input type="checkbox"/> No		
942	<input type="checkbox"/> Yes, <input type="checkbox"/> No			992	<input type="checkbox"/> Yes, <input type="checkbox"/> No		
943	<input type="checkbox"/> Yes, <input type="checkbox"/> No			993	<input type="checkbox"/> Yes, <input type="checkbox"/> No		
944	<input type="checkbox"/> Yes, <input type="checkbox"/> No			994	<input type="checkbox"/> Yes, <input type="checkbox"/> No		
945	<input type="checkbox"/> Yes, <input type="checkbox"/> No			995	<input type="checkbox"/> Yes, <input type="checkbox"/> No		
946	<input type="checkbox"/> Yes, <input type="checkbox"/> No			996	<input type="checkbox"/> Yes, <input type="checkbox"/> No		
947	<input type="checkbox"/> Yes, <input type="checkbox"/> No			997	<input type="checkbox"/> Yes, <input type="checkbox"/> No		
948	<input type="checkbox"/> Yes, <input type="checkbox"/> No			998	<input type="checkbox"/> Yes, <input type="checkbox"/> No		
949	<input type="checkbox"/> Yes, <input type="checkbox"/> No			999	<input type="checkbox"/> Yes, <input type="checkbox"/> No		

TOLL RESTRICTION—AREA/OFFICE CODE TABLE (1/8)

Area/Office Code Table Yo. 6

Code No.	Local Call Access	Restriction Level	Office Code		Code No.	Local Call Access	Restriction Level	Office Code
200	<input type="checkbox"/> Yes <input type="checkbox"/> No				250	<input type="checkbox"/> Yes, <input type="checkbox"/> No		
201	<input type="checkbox"/> Yes <input type="checkbox"/> No				251	<input type="checkbox"/> Yes, <input type="checkbox"/> No		
202	<input type="checkbox"/> Yes <input type="checkbox"/> No				252	<input type="checkbox"/> Yes, <input type="checkbox"/> No		
203	<input type="checkbox"/> Yes <input type="checkbox"/> No				253	<input type="checkbox"/> Yes, <input type="checkbox"/> No		
204	<input type="checkbox"/> Yes <input type="checkbox"/> No				254	<input type="checkbox"/> Yes, <input type="checkbox"/> No		
205	<input type="checkbox"/> Yes <input type="checkbox"/> No				255	<input type="checkbox"/> Yes, <input type="checkbox"/> No		
206	<input type="checkbox"/> Yes <input type="checkbox"/> No				256	<input type="checkbox"/> Yes, <input type="checkbox"/> No		
207	<input type="checkbox"/> Yes <input type="checkbox"/> No				257	<input type="checkbox"/> Yes, <input type="checkbox"/> No		
208	<input type="checkbox"/> Yes <input type="checkbox"/> No				258	<input type="checkbox"/> Yes, <input type="checkbox"/> No		
209	<input type="checkbox"/> Yes <input type="checkbox"/> No				259	<input type="checkbox"/> Yes, <input type="checkbox"/> No		
210	<input type="checkbox"/> Yes <input type="checkbox"/> No				260	<input type="checkbox"/> Yes, <input type="checkbox"/> No		
211	<input type="checkbox"/> Yes <input type="checkbox"/> No				261	<input type="checkbox"/> Yes, <input type="checkbox"/> No		
212	<input type="checkbox"/> Yes <input type="checkbox"/> No				262	<input type="checkbox"/> Yes, <input type="checkbox"/> No		
213	<input type="checkbox"/> Yes <input type="checkbox"/> No				263	<input type="checkbox"/> Yes, <input type="checkbox"/> No		
214	<input type="checkbox"/> Yes <input type="checkbox"/> No				264	<input type="checkbox"/> Yes, <input type="checkbox"/> No		
215	<input type="checkbox"/> Yes <input type="checkbox"/> No				265	<input type="checkbox"/> Yes, <input type="checkbox"/> No		
216	<input type="checkbox"/> Yes <input type="checkbox"/> No				266	<input type="checkbox"/> Yes, <input type="checkbox"/> No		
217	<input type="checkbox"/> Yes <input type="checkbox"/> No				267	<input type="checkbox"/> Yes, <input type="checkbox"/> No		
218	<input type="checkbox"/> Yes <input type="checkbox"/> No				268	<input type="checkbox"/> Yes, <input type="checkbox"/> No		
219	<input type="checkbox"/> Yes <input type="checkbox"/> No				269	<input type="checkbox"/> Yes, <input type="checkbox"/> No		
220	<input type="checkbox"/> Yes <input type="checkbox"/> No				270	<input type="checkbox"/> Yes, <input type="checkbox"/> No		
221	<input type="checkbox"/> Yes <input type="checkbox"/> No				271	<input type="checkbox"/> Yes, <input type="checkbox"/> No		
222	<input type="checkbox"/> Yes <input type="checkbox"/> No				272	<input type="checkbox"/> Yes, <input type="checkbox"/> No		
223	<input type="checkbox"/> Yes <input type="checkbox"/> No				273	<input type="checkbox"/> Yes, <input type="checkbox"/> No		
224	<input type="checkbox"/> Yes <input type="checkbox"/> No				274	<input type="checkbox"/> Yes, <input type="checkbox"/> No		
225	<input type="checkbox"/> Yes <input type="checkbox"/> No				275	<input type="checkbox"/> Yes, <input type="checkbox"/> No		
226	<input type="checkbox"/> Yes <input type="checkbox"/> No				276	<input type="checkbox"/> Yes, <input type="checkbox"/> No		
227	<input type="checkbox"/> Yes <input type="checkbox"/> No				277	<input type="checkbox"/> Yes, <input type="checkbox"/> No		
228	<input type="checkbox"/> Yes <input type="checkbox"/> No				278	<input type="checkbox"/> Yes, <input type="checkbox"/> No		
229	<input type="checkbox"/> Yes <input type="checkbox"/> No				279	<input type="checkbox"/> Yes, <input type="checkbox"/> No		
230	<input type="checkbox"/> Yes <input type="checkbox"/> No				280	<input type="checkbox"/> Yes, <input type="checkbox"/> No		
231	<input type="checkbox"/> Yes <input type="checkbox"/> No				281	<input type="checkbox"/> Yes, <input type="checkbox"/> No		
232	<input type="checkbox"/> Yes <input type="checkbox"/> No				282	<input type="checkbox"/> Yes, <input type="checkbox"/> No		
233	<input type="checkbox"/> Yes <input type="checkbox"/> No				283	<input type="checkbox"/> Yes, <input type="checkbox"/> No		
234	<input type="checkbox"/> Yes <input type="checkbox"/> No				284	<input type="checkbox"/> Yes, <input type="checkbox"/> No		
235	<input type="checkbox"/> Yes <input type="checkbox"/> No				285	<input type="checkbox"/> Yes, <input type="checkbox"/> No		
236	<input type="checkbox"/> Yes <input type="checkbox"/> No				286	<input type="checkbox"/> Yes, <input type="checkbox"/> No		
237	<input type="checkbox"/> Yes <input type="checkbox"/> No				287	<input type="checkbox"/> Yes, <input type="checkbox"/> No		
238	<input type="checkbox"/> Yes <input type="checkbox"/> No				288	<input type="checkbox"/> Yes, <input type="checkbox"/> No		
239	<input type="checkbox"/> Yes <input type="checkbox"/> No				289	<input type="checkbox"/> Yes, <input type="checkbox"/> No		
240	<input type="checkbox"/> Yes <input type="checkbox"/> No				290	<input type="checkbox"/> Yes, <input type="checkbox"/> No		
241	<input type="checkbox"/> Yes <input type="checkbox"/> No				291	<input type="checkbox"/> Yes, <input type="checkbox"/> No		
242	<input type="checkbox"/> Yes <input type="checkbox"/> No				292	<input type="checkbox"/> Yes, <input type="checkbox"/> No		
243	<input type="checkbox"/> Yes <input type="checkbox"/> No				293	<input type="checkbox"/> Yes, <input type="checkbox"/> No		
244	<input type="checkbox"/> Yes <input type="checkbox"/> No				294	<input type="checkbox"/> Yes, <input type="checkbox"/> No		
245	<input type="checkbox"/> Yes <input type="checkbox"/> No				295	<input type="checkbox"/> Yes, <input type="checkbox"/> No		
246	<input type="checkbox"/> Yes <input type="checkbox"/> No				296	<input type="checkbox"/> Yes, <input type="checkbox"/> No		
247	<input type="checkbox"/> Yes <input type="checkbox"/> No				297	<input type="checkbox"/> Yes, <input type="checkbox"/> No		
248	<input type="checkbox"/> Yes <input type="checkbox"/> No				298	<input type="checkbox"/> Yes, <input type="checkbox"/> No		
249	<input type="checkbox"/> Yes <input type="checkbox"/> No				299	<input type="checkbox"/> Yes, <input type="checkbox"/> No		

TOLL RESTRICTION-AREA/OFFICE CODE TABLE (2/8)

Area/Office Code Table No. 6

Code No.	Local Call Access	Restriction Level	Office Code	Code No.	Local Call Access	Restriction Level	Office Code
300	<input type="checkbox"/> Yes, <input type="checkbox"/> No			350	<input type="checkbox"/> Yes, <input type="checkbox"/> No		
301	<input type="checkbox"/> Yes, <input type="checkbox"/> No			351	<input type="checkbox"/> Yes, <input type="checkbox"/> No		
302	<input type="checkbox"/> Yes, <input type="checkbox"/> No			352	<input type="checkbox"/> Yes, <input type="checkbox"/> No		
303	<input type="checkbox"/> Yes, <input type="checkbox"/> No			353	<input type="checkbox"/> Yes, <input type="checkbox"/> No		
304	<input type="checkbox"/> Yes, <input type="checkbox"/> No			354	<input type="checkbox"/> Yes, <input type="checkbox"/> No		
305	<input type="checkbox"/> Yes, <input type="checkbox"/> No			355	<input type="checkbox"/> Yes, <input type="checkbox"/> No		
306	<input type="checkbox"/> Yes, <input type="checkbox"/> No			356	<input type="checkbox"/> Yes, <input type="checkbox"/> No		
307	<input type="checkbox"/> Yes, <input type="checkbox"/> No			357	<input type="checkbox"/> Yes, <input type="checkbox"/> No		
308	<input type="checkbox"/> Yes, <input type="checkbox"/> No			358	<input type="checkbox"/> Yes, <input type="checkbox"/> No		
309	<input type="checkbox"/> Yes, <input type="checkbox"/> No			359	<input type="checkbox"/> Yes, <input type="checkbox"/> No		
310	<input type="checkbox"/> Yes, <input type="checkbox"/> No			360	<input type="checkbox"/> Yes, <input type="checkbox"/> No		
311	<input type="checkbox"/> Yes, <input type="checkbox"/> No			361	<input type="checkbox"/> Yes, <input type="checkbox"/> No		
312	<input type="checkbox"/> Yes, <input type="checkbox"/> No			362	<input type="checkbox"/> Yes, <input type="checkbox"/> No		
313	<input type="checkbox"/> Yes, <input type="checkbox"/> No			363	<input type="checkbox"/> Yes, <input type="checkbox"/> No		
314	<input type="checkbox"/> Yes, <input type="checkbox"/> No			364	<input type="checkbox"/> Yes, <input type="checkbox"/> No		
315	<input type="checkbox"/> Yes, <input type="checkbox"/> No			365	<input type="checkbox"/> Yes, <input type="checkbox"/> No		
316	<input type="checkbox"/> Yes, <input type="checkbox"/> No			366	<input type="checkbox"/> Yes, <input type="checkbox"/> No		
317	<input type="checkbox"/> Yes, <input type="checkbox"/> No			367	<input type="checkbox"/> Yes, <input type="checkbox"/> No		
318	<input type="checkbox"/> Yes, <input type="checkbox"/> No			368	<input type="checkbox"/> Yes, <input type="checkbox"/> No		
319	<input type="checkbox"/> Yes, <input type="checkbox"/> No			369	<input type="checkbox"/> Yes, <input type="checkbox"/> No		
320	<input type="checkbox"/> Yes, <input type="checkbox"/> No			370	<input type="checkbox"/> Yes, <input type="checkbox"/> No		
321	<input type="checkbox"/> Yes, <input type="checkbox"/> No			371	<input type="checkbox"/> Yes, <input type="checkbox"/> No		
322	<input type="checkbox"/> Yes, <input type="checkbox"/> No			372	<input type="checkbox"/> Yes, <input type="checkbox"/> No		
323	<input type="checkbox"/> Yes, <input type="checkbox"/> No			373	<input type="checkbox"/> Yes, <input type="checkbox"/> No		
324	<input type="checkbox"/> Yes, <input type="checkbox"/> No			374	<input type="checkbox"/> Yes, <input type="checkbox"/> No		
325	<input type="checkbox"/> Yes, <input type="checkbox"/> No			375	<input type="checkbox"/> Yes, <input type="checkbox"/> No		
326	<input type="checkbox"/> Yes, <input type="checkbox"/> No			376	<input type="checkbox"/> Yes, <input type="checkbox"/> No		
327	<input type="checkbox"/> Yes, <input type="checkbox"/> No			377	<input type="checkbox"/> Yes, <input type="checkbox"/> No		
328	<input type="checkbox"/> Yes, <input type="checkbox"/> No			378	<input type="checkbox"/> Yes, <input type="checkbox"/> No		
329	<input type="checkbox"/> Yes, <input type="checkbox"/> No			379	<input type="checkbox"/> Yes, <input type="checkbox"/> No		
330	<input type="checkbox"/> Yes, <input type="checkbox"/> No			380	<input type="checkbox"/> Yes, <input type="checkbox"/> No		
331	<input type="checkbox"/> Yes, <input type="checkbox"/> No			381	<input type="checkbox"/> Yes, <input type="checkbox"/> No		
332	<input type="checkbox"/> Yes, <input type="checkbox"/> No			382	<input type="checkbox"/> Yes, <input type="checkbox"/> No		
333	<input type="checkbox"/> Yes, <input type="checkbox"/> No			383	<input type="checkbox"/> Yes, <input type="checkbox"/> No		
334	<input type="checkbox"/> Yes, <input type="checkbox"/> No			384	<input type="checkbox"/> Yes, <input type="checkbox"/> No		
335	<input type="checkbox"/> Yes, <input type="checkbox"/> No			385	<input type="checkbox"/> Yes, <input type="checkbox"/> No		
336	<input type="checkbox"/> Yes, <input type="checkbox"/> No			386	<input type="checkbox"/> Yes, <input type="checkbox"/> No		
337	<input type="checkbox"/> Yes, <input type="checkbox"/> No			387	<input type="checkbox"/> Yes, <input type="checkbox"/> No		
338	<input type="checkbox"/> Yes, <input type="checkbox"/> No			388	<input type="checkbox"/> Yes, <input type="checkbox"/> No		
339	<input type="checkbox"/> Yes, <input type="checkbox"/> No			389	<input type="checkbox"/> Yes, <input type="checkbox"/> No		
340	<input type="checkbox"/> Yes, <input type="checkbox"/> No			390	<input type="checkbox"/> Yes, <input type="checkbox"/> No		
341	<input type="checkbox"/> Yes, <input type="checkbox"/> No			391	<input type="checkbox"/> Yes, <input type="checkbox"/> No		
342	<input type="checkbox"/> Yes, <input type="checkbox"/> No			392	<input type="checkbox"/> Yes, <input type="checkbox"/> No		
343	<input type="checkbox"/> Yes, <input type="checkbox"/> No			393	<input type="checkbox"/> Yes, <input type="checkbox"/> No		
344	<input type="checkbox"/> Yes, <input type="checkbox"/> No			394	<input type="checkbox"/> Yes, <input type="checkbox"/> No		
345	<input type="checkbox"/> Yes, <input type="checkbox"/> No			395	<input type="checkbox"/> Yes, <input type="checkbox"/> No		
346	<input type="checkbox"/> Yes, <input type="checkbox"/> No			396	<input type="checkbox"/> Yes, <input type="checkbox"/> No		
347	<input type="checkbox"/> Yes, <input type="checkbox"/> No			397	<input type="checkbox"/> Yes, <input type="checkbox"/> No		
348	<input type="checkbox"/> Yes, <input type="checkbox"/> No			398	<input type="checkbox"/> Yes, <input type="checkbox"/> No		
349	<input type="checkbox"/> Yes, <input type="checkbox"/> No			399	<input type="checkbox"/> Yes, <input type="checkbox"/> No		

TOLL RESTRICTION-AREA/OFFICE CODE TABLE (3/8)

Area/Office Code Table No. 6

Code No.	Local Call Access	Restriction Level	Office Code	Code No.	Local Call Access	Restriction Level	Office Code
400	<input type="checkbox"/> Yes, <input type="checkbox"/> No			450	<input type="checkbox"/> Yes, <input type="checkbox"/> No		
401	<input type="checkbox"/> Yes, <input type="checkbox"/> No			451	<input type="checkbox"/> Yes, <input type="checkbox"/> No		
402	<input type="checkbox"/> Yes, <input type="checkbox"/> No			452	<input type="checkbox"/> Yes, <input type="checkbox"/> No		
403	<input type="checkbox"/> Yes, <input type="checkbox"/> No			453	<input type="checkbox"/> Yes, <input type="checkbox"/> No		
404	<input type="checkbox"/> Yes, <input type="checkbox"/> No			454	<input type="checkbox"/> Yes, <input type="checkbox"/> No		
405	<input type="checkbox"/> Yes, <input type="checkbox"/> No			455	<input type="checkbox"/> Yes, <input type="checkbox"/> No		
406	<input type="checkbox"/> Yes, <input type="checkbox"/> No			456	<input type="checkbox"/> Yes, <input type="checkbox"/> No		
407	<input type="checkbox"/> Yes, <input type="checkbox"/> No			457	<input type="checkbox"/> Yes, <input type="checkbox"/> No		
408	<input type="checkbox"/> Yes, <input type="checkbox"/> No			458	<input type="checkbox"/> Yes, <input type="checkbox"/> No		
409	<input type="checkbox"/> Yes, <input type="checkbox"/> No			459	<input type="checkbox"/> Yes, <input type="checkbox"/> No		
410	<input type="checkbox"/> Yes, <input type="checkbox"/> No			460	<input type="checkbox"/> Yes, <input type="checkbox"/> No		
411	<input type="checkbox"/> Yes, <input type="checkbox"/> No			461	<input type="checkbox"/> Yes, <input type="checkbox"/> No		
412	<input type="checkbox"/> Yes, <input type="checkbox"/> No			462	<input type="checkbox"/> Yes, <input type="checkbox"/> No		
413	<input type="checkbox"/> Yes, <input type="checkbox"/> No			463	<input type="checkbox"/> Yes, <input type="checkbox"/> No		
414	<input type="checkbox"/> Yes, <input type="checkbox"/> No			464	<input type="checkbox"/> Yes, <input type="checkbox"/> No		
415	<input type="checkbox"/> Yes, <input type="checkbox"/> No			465	<input type="checkbox"/> Yes, <input type="checkbox"/> No		
416	<input type="checkbox"/> Yes, <input type="checkbox"/> No			466	<input type="checkbox"/> Yes, <input type="checkbox"/> No		
417	<input type="checkbox"/> Yes, <input type="checkbox"/> No			467	<input type="checkbox"/> Yes, <input type="checkbox"/> No		
418	<input type="checkbox"/> Yes, <input type="checkbox"/> No			468	<input type="checkbox"/> Yes, <input type="checkbox"/> No		
419	<input type="checkbox"/> Yes, <input type="checkbox"/> No			469	<input type="checkbox"/> Yes, <input type="checkbox"/> No		
420	<input type="checkbox"/> Yes, <input type="checkbox"/> No			470	<input type="checkbox"/> Yes, <input type="checkbox"/> No		
421	<input type="checkbox"/> Yes, <input type="checkbox"/> No			471	<input type="checkbox"/> Yes, <input type="checkbox"/> No		
422	<input type="checkbox"/> Yes, <input type="checkbox"/> No			472	<input type="checkbox"/> Yes, <input type="checkbox"/> No		
423	<input type="checkbox"/> Yes, <input type="checkbox"/> No			473	<input type="checkbox"/> Yes, <input type="checkbox"/> No		
424	<input type="checkbox"/> Yes, <input type="checkbox"/> No			474	<input type="checkbox"/> Yes, <input type="checkbox"/> No		
425	<input type="checkbox"/> Yes, <input type="checkbox"/> No			475	<input type="checkbox"/> Yes, <input type="checkbox"/> No		
426	<input type="checkbox"/> Yes, <input type="checkbox"/> No			476	<input type="checkbox"/> Yes, <input type="checkbox"/> No		
427	<input type="checkbox"/> Yes, <input type="checkbox"/> No			477	<input type="checkbox"/> Yes, <input type="checkbox"/> No		
428	<input type="checkbox"/> Yes, <input type="checkbox"/> No			478	<input type="checkbox"/> Yes, <input type="checkbox"/> No		
429	<input type="checkbox"/> Yes, <input type="checkbox"/> No			479	<input type="checkbox"/> Yes, <input type="checkbox"/> No		
430	<input type="checkbox"/> Yes, <input type="checkbox"/> No			480	<input type="checkbox"/> Yes, <input type="checkbox"/> No		
431	<input type="checkbox"/> Yes, <input type="checkbox"/> No			481	<input type="checkbox"/> Yes, <input type="checkbox"/> No		
432	<input type="checkbox"/> Yes, <input type="checkbox"/> No			482	<input type="checkbox"/> Yes, <input type="checkbox"/> No		
433	<input type="checkbox"/> Yes, <input type="checkbox"/> No			483	<input type="checkbox"/> Yes, <input type="checkbox"/> No		
434	<input type="checkbox"/> Yes, <input type="checkbox"/> No			484	<input type="checkbox"/> Yes, <input type="checkbox"/> No		
435	<input type="checkbox"/> Yes, <input type="checkbox"/> No			485	<input type="checkbox"/> Yes, <input type="checkbox"/> No		
436	<input type="checkbox"/> Yes, <input type="checkbox"/> No			486	<input type="checkbox"/> Yes, <input type="checkbox"/> No		
437	<input type="checkbox"/> Yes, <input type="checkbox"/> No			487	<input type="checkbox"/> Yes, <input type="checkbox"/> No		
438	<input type="checkbox"/> Yes, <input type="checkbox"/> No			488	<input type="checkbox"/> Yes, <input type="checkbox"/> No		
439	<input type="checkbox"/> Yes, <input type="checkbox"/> No			489	<input type="checkbox"/> Yes, <input type="checkbox"/> No		
440	<input type="checkbox"/> Yes, <input type="checkbox"/> No			490	<input type="checkbox"/> Yes, <input type="checkbox"/> No		
441	<input type="checkbox"/> Yes, <input type="checkbox"/> No			491	<input type="checkbox"/> Yes, <input type="checkbox"/> No		
442	<input type="checkbox"/> Yes, <input type="checkbox"/> No			492	<input type="checkbox"/> Yes, <input type="checkbox"/> No		
443	<input type="checkbox"/> Yes, <input type="checkbox"/> No			493	<input type="checkbox"/> Yes, <input type="checkbox"/> No		
444	<input type="checkbox"/> Yes, <input type="checkbox"/> No			494	<input type="checkbox"/> Yes, <input type="checkbox"/> No		
445	<input type="checkbox"/> Yes, <input type="checkbox"/> No			495	<input type="checkbox"/> Yes, <input type="checkbox"/> No		
446	<input type="checkbox"/> Yes, <input type="checkbox"/> No			496	<input type="checkbox"/> Yes, <input type="checkbox"/> No		
447	<input type="checkbox"/> Yes, <input type="checkbox"/> No			497	<input type="checkbox"/> Yes, <input type="checkbox"/> No		
448	<input type="checkbox"/> Yes, <input type="checkbox"/> No			498	<input type="checkbox"/> Yes, <input type="checkbox"/> No		
449	<input type="checkbox"/> Yes, <input type="checkbox"/> No			499	<input type="checkbox"/> Yes, <input type="checkbox"/> No		

TOLL RESTRICTION—AREA/OFFICE CODE TABLE (4/8)

Area/Office Code Table No. 6

Code No.	Local Call Access	Restriction Level	Office Code	Co& No	Local Call ACCESS	Restriction Level	Office Code
500	<input type="checkbox"/> Yes, <input type="checkbox"/> No			550	<input type="checkbox"/> Yes, <input type="checkbox"/> No		
501	<input type="checkbox"/> Yes, <input type="checkbox"/> No			551	<input type="checkbox"/> Yes, <input type="checkbox"/> No		
502	<input type="checkbox"/> Yes, <input type="checkbox"/> No			552	<input type="checkbox"/> Yes, <input type="checkbox"/> No		
503	<input type="checkbox"/> Yes, <input type="checkbox"/> No			552	<input type="checkbox"/> Yes, <input type="checkbox"/> No		
504	<input type="checkbox"/> Yes, <input type="checkbox"/> No			554	<input type="checkbox"/> Yes, <input type="checkbox"/> No		
505	<input type="checkbox"/> Yes, <input type="checkbox"/> No			555	<input type="checkbox"/> Yes, <input type="checkbox"/> No		
506	<input type="checkbox"/> Yes, <input type="checkbox"/> No			555	<input type="checkbox"/> Yes, <input type="checkbox"/> No		
507	<input type="checkbox"/> Yes, <input type="checkbox"/> No			557	<input type="checkbox"/> Yes, <input type="checkbox"/> No		
508	<input type="checkbox"/> Yes, <input type="checkbox"/> No			558	<input type="checkbox"/> Yes, <input type="checkbox"/> No		
509	<input type="checkbox"/> Yes, <input type="checkbox"/> No			559	<input type="checkbox"/> Yes, <input type="checkbox"/> No		
510	<input type="checkbox"/> Yes, <input type="checkbox"/> No			560	<input type="checkbox"/> Yes, <input type="checkbox"/> No		
511	<input type="checkbox"/> Yes, <input type="checkbox"/> No			561	<input type="checkbox"/> Yes, <input type="checkbox"/> No		
512	<input type="checkbox"/> Yes, <input type="checkbox"/> No			562	<input type="checkbox"/> Yes, <input type="checkbox"/> No		
513	<input type="checkbox"/> Yes, <input type="checkbox"/> No			563	<input type="checkbox"/> Yes, <input type="checkbox"/> No		
514	<input type="checkbox"/> Yes, <input type="checkbox"/> No			564	<input type="checkbox"/> Yes, <input type="checkbox"/> No		
515	<input type="checkbox"/> Yes, <input type="checkbox"/> No			565	<input type="checkbox"/> Yes, <input type="checkbox"/> No		
516	<input type="checkbox"/> Yes, <input type="checkbox"/> No			566	<input type="checkbox"/> Yes, <input type="checkbox"/> No		
517	<input type="checkbox"/> Yes, <input type="checkbox"/> No			567	<input type="checkbox"/> Yes, <input type="checkbox"/> No		
518	<input type="checkbox"/> Yes, <input type="checkbox"/> No			568	<input type="checkbox"/> Yes, <input type="checkbox"/> No		
519	<input type="checkbox"/> Yes, <input type="checkbox"/> No			569	<input type="checkbox"/> Yes, <input type="checkbox"/> No		
520	<input type="checkbox"/> Yes, <input type="checkbox"/> No			570	<input type="checkbox"/> Yes, <input type="checkbox"/> No		
521	<input type="checkbox"/> Yes, <input type="checkbox"/> No			571	<input type="checkbox"/> Yes, <input type="checkbox"/> No		
522	<input type="checkbox"/> Yes, <input type="checkbox"/> No			572	<input type="checkbox"/> Yes, <input type="checkbox"/> No		
523	<input type="checkbox"/> Yes, <input type="checkbox"/> No			573	<input type="checkbox"/> Yes, <input type="checkbox"/> No		
524	<input type="checkbox"/> Yes, <input type="checkbox"/> No			574	<input type="checkbox"/> Yes, <input type="checkbox"/> No		
525	<input type="checkbox"/> Yes, <input type="checkbox"/> No			575	<input type="checkbox"/> Yes, <input type="checkbox"/> No		
526	<input type="checkbox"/> Yes, <input type="checkbox"/> No			576	<input type="checkbox"/> Yes, <input type="checkbox"/> No		
527	<input type="checkbox"/> Yes, <input type="checkbox"/> No			577	<input type="checkbox"/> Yes, <input type="checkbox"/> No		
528	<input type="checkbox"/> Yes, <input type="checkbox"/> No			578	<input type="checkbox"/> Yes, <input type="checkbox"/> No		
529	<input type="checkbox"/> Yes, <input type="checkbox"/> No			579	<input type="checkbox"/> Yes, <input type="checkbox"/> No		
530	<input type="checkbox"/> Yes, <input type="checkbox"/> No			580	<input type="checkbox"/> Yes, <input type="checkbox"/> No		
531	<input type="checkbox"/> Yes, <input type="checkbox"/> No			581	<input type="checkbox"/> Yes, <input type="checkbox"/> No		
532	<input type="checkbox"/> Yes, <input type="checkbox"/> No			582	<input type="checkbox"/> Yes, <input type="checkbox"/> No		
533	<input type="checkbox"/> Yes, <input type="checkbox"/> No			583	<input type="checkbox"/> Yes, <input type="checkbox"/> No		
534	<input type="checkbox"/> Yes, <input type="checkbox"/> No			584	<input type="checkbox"/> Yes, <input type="checkbox"/> No		
535	<input type="checkbox"/> Yes, <input type="checkbox"/> No			585	<input type="checkbox"/> Yes, <input type="checkbox"/> No		
536	<input type="checkbox"/> Yes, <input type="checkbox"/> No			586	<input type="checkbox"/> Yes, <input type="checkbox"/> No		
537	<input type="checkbox"/> Yes, <input type="checkbox"/> No			587	<input type="checkbox"/> Yes, <input type="checkbox"/> No		
538	<input type="checkbox"/> Yes, <input type="checkbox"/> No			588	<input type="checkbox"/> Yes, <input type="checkbox"/> No		
539	<input type="checkbox"/> Yes, <input type="checkbox"/> No			589	<input type="checkbox"/> Yes, <input type="checkbox"/> No		
540	<input type="checkbox"/> Yes, <input type="checkbox"/> No			590	<input type="checkbox"/> Yes, <input type="checkbox"/> No		
541	<input type="checkbox"/> Yes, <input type="checkbox"/> No			591	<input type="checkbox"/> Yes, <input type="checkbox"/> No		
542	<input type="checkbox"/> Yes, <input type="checkbox"/> No			592	<input type="checkbox"/> Yes, <input type="checkbox"/> No		
543	<input type="checkbox"/> Yes, <input type="checkbox"/> No			593	<input type="checkbox"/> Yes, <input type="checkbox"/> No		
544	<input type="checkbox"/> Yes, <input type="checkbox"/> No			594	<input type="checkbox"/> Yes, <input type="checkbox"/> No		
545	<input type="checkbox"/> Yes, <input type="checkbox"/> No			595	<input type="checkbox"/> Yes, <input type="checkbox"/> No		
546	<input type="checkbox"/> Yes, <input type="checkbox"/> No			596	<input type="checkbox"/> Yes, <input type="checkbox"/> No		
547	<input type="checkbox"/> Yes, <input type="checkbox"/> No			597	<input type="checkbox"/> Yes, <input type="checkbox"/> No		
548	<input type="checkbox"/> Yes, <input type="checkbox"/> No			598	<input type="checkbox"/> Yes, <input type="checkbox"/> No		
549	<input type="checkbox"/> Yes, <input type="checkbox"/> No			599	<input type="checkbox"/> Yes, <input type="checkbox"/> No		

TOLL RESTRICTION-AREA/OFFICE CODE TABLE (518)

Area Office Code Table No. 6

Code No.	Local Call Access	Restriction Level	Office Code	Code No.	Local Call Access	Restriction Level	Office Code
600	<input type="checkbox"/> Yes, <input type="checkbox"/> No			651	<input type="checkbox"/> Yes, <input type="checkbox"/> No		
601	<input type="checkbox"/> Yes, <input type="checkbox"/> No			652	<input type="checkbox"/> Yes, <input type="checkbox"/> No		
602	<input type="checkbox"/> Yes, <input type="checkbox"/> No			653	<input type="checkbox"/> Yes, <input type="checkbox"/> No		
603	<input type="checkbox"/> Yes, <input type="checkbox"/> No			654	<input type="checkbox"/> Yes, <input type="checkbox"/> No		
604	<input type="checkbox"/> Yes, <input type="checkbox"/> No			655	<input type="checkbox"/> Yes, <input type="checkbox"/> No		
605	<input type="checkbox"/> Yes, <input type="checkbox"/> No			656	<input type="checkbox"/> Yes, <input type="checkbox"/> No		
606	<input type="checkbox"/> Yes, <input type="checkbox"/> No			657	<input type="checkbox"/> Yes, <input type="checkbox"/> No		
607	<input type="checkbox"/> Yes, <input type="checkbox"/> No			658	<input type="checkbox"/> Yes, <input type="checkbox"/> No		
608	<input type="checkbox"/> Yes, <input type="checkbox"/> No			659	<input type="checkbox"/> Yes, <input type="checkbox"/> No		
609	<input type="checkbox"/> Yes, <input type="checkbox"/> No			660	<input type="checkbox"/> Yes, <input type="checkbox"/> No		
610	<input type="checkbox"/> Yes, <input type="checkbox"/> No			661	<input type="checkbox"/> Yes, <input type="checkbox"/> No		
611	<input type="checkbox"/> Yes, <input type="checkbox"/> No			662	<input type="checkbox"/> Yes, <input type="checkbox"/> No		
612	<input type="checkbox"/> Yes, <input type="checkbox"/> No			663	<input type="checkbox"/> Yes, <input type="checkbox"/> No		
613	<input type="checkbox"/> Yes, <input type="checkbox"/> No			664	<input type="checkbox"/> Yes, <input type="checkbox"/> No		
614	<input type="checkbox"/> Yes, <input type="checkbox"/> No			665	<input type="checkbox"/> Yes, <input type="checkbox"/> No		
615	<input type="checkbox"/> Yes, <input type="checkbox"/> No			666	<input type="checkbox"/> Yes, <input type="checkbox"/> No		
616	<input type="checkbox"/> Yes, <input type="checkbox"/> No			667	<input type="checkbox"/> Yes, <input type="checkbox"/> No		
617	<input type="checkbox"/> Yes, <input type="checkbox"/> No			668	<input type="checkbox"/> Yes, <input type="checkbox"/> No		
618	<input type="checkbox"/> Yes, <input type="checkbox"/> No			669	<input type="checkbox"/> Yes, <input type="checkbox"/> No		
619	<input type="checkbox"/> Yes, <input type="checkbox"/> No			670	<input type="checkbox"/> Yes, <input type="checkbox"/> No		
620	<input type="checkbox"/> Yes, <input type="checkbox"/> No			671	<input type="checkbox"/> Yes, <input type="checkbox"/> No		
621	<input type="checkbox"/> Yes, <input type="checkbox"/> No			672	<input type="checkbox"/> Yes, <input type="checkbox"/> No		
622	<input type="checkbox"/> Yes, <input type="checkbox"/> No			673	<input type="checkbox"/> Yes, <input type="checkbox"/> No		
623	<input type="checkbox"/> Yes, <input type="checkbox"/> No			674	<input type="checkbox"/> Yes, <input type="checkbox"/> No		
624	<input type="checkbox"/> Yes, <input type="checkbox"/> No			675	<input type="checkbox"/> Yes, <input type="checkbox"/> No		
625	<input type="checkbox"/> Yes, <input type="checkbox"/> No			676	<input type="checkbox"/> Yes, <input type="checkbox"/> No		
626	<input type="checkbox"/> Yes, <input type="checkbox"/> No			677	<input type="checkbox"/> Yes, <input type="checkbox"/> No		
627	<input type="checkbox"/> Yes, <input type="checkbox"/> No			678	<input type="checkbox"/> Yes, <input type="checkbox"/> No		
628	<input type="checkbox"/> Yes, <input type="checkbox"/> No			679	<input type="checkbox"/> Yes, <input type="checkbox"/> No		
629	<input type="checkbox"/> Yes, <input type="checkbox"/> No			680	<input type="checkbox"/> Yes, <input type="checkbox"/> No		
630	<input type="checkbox"/> Yes, <input type="checkbox"/> No			681	<input type="checkbox"/> Yes, <input type="checkbox"/> No		
631	<input type="checkbox"/> Yes, <input type="checkbox"/> No			682	<input type="checkbox"/> Yes, <input type="checkbox"/> No		
632	<input type="checkbox"/> Yes, <input type="checkbox"/> No			683	<input type="checkbox"/> Yes, <input type="checkbox"/> No		
633	<input type="checkbox"/> Yes, <input type="checkbox"/> No			684	<input type="checkbox"/> Yes, <input type="checkbox"/> No		
634	<input type="checkbox"/> Yes, <input type="checkbox"/> No			685	<input type="checkbox"/> Yes, <input type="checkbox"/> No		
635	<input type="checkbox"/> Yes, <input type="checkbox"/> No			686	<input type="checkbox"/> Yes, <input type="checkbox"/> No		
636	<input type="checkbox"/> Yes, <input type="checkbox"/> No			687	<input type="checkbox"/> Yes, <input type="checkbox"/> No		
637	<input type="checkbox"/> Yes, <input type="checkbox"/> No			688	<input type="checkbox"/> Yes, <input type="checkbox"/> No		
638	<input type="checkbox"/> Yes, <input type="checkbox"/> No			689	<input type="checkbox"/> Yes, <input type="checkbox"/> No		
639	<input type="checkbox"/> Yes, <input type="checkbox"/> No			690	<input type="checkbox"/> Yes, <input type="checkbox"/> No		
640	<input type="checkbox"/> Yes, <input type="checkbox"/> No			691	<input type="checkbox"/> Yes, <input type="checkbox"/> No		
641	<input type="checkbox"/> Yes, <input type="checkbox"/> No			692	<input type="checkbox"/> Yes, <input type="checkbox"/> No		
642	<input type="checkbox"/> Yes, <input type="checkbox"/> No			693	<input type="checkbox"/> Yes, <input type="checkbox"/> No		
643	<input type="checkbox"/> Yes, <input type="checkbox"/> No			694	<input type="checkbox"/> Yes, <input type="checkbox"/> No		
644	<input type="checkbox"/> Yes, <input type="checkbox"/> No			695	<input type="checkbox"/> Yes, <input type="checkbox"/> No		
645	<input type="checkbox"/> Yes, <input type="checkbox"/> No			696	<input type="checkbox"/> Yes, <input type="checkbox"/> No		
646	<input type="checkbox"/> Yes, <input type="checkbox"/> No			697	<input type="checkbox"/> Yes, <input type="checkbox"/> No		
647	<input type="checkbox"/> Yes, <input type="checkbox"/> No			698	<input type="checkbox"/> Yes, <input type="checkbox"/> No		
648	<input type="checkbox"/> Yes, <input type="checkbox"/> No			699	<input type="checkbox"/> Yes, <input type="checkbox"/> No		
649	<input type="checkbox"/> Yes, <input type="checkbox"/> No						

TOLL RESTRICTION-AREA/OFFICE CODE TABLE (6/8)

Area/Office Code Table No. 6

Code No.	Local Call Access	Restriction Level	Office Code	Code No.	Local Call Access	Restriction Level	Office Code
700	<input type="checkbox"/> Yes, <input type="checkbox"/> No			750	<input type="checkbox"/> Yes, <input type="checkbox"/> No		
701	<input type="checkbox"/> Yes, <input type="checkbox"/> No			751	<input type="checkbox"/> Yes, <input type="checkbox"/> No		
702	<input type="checkbox"/> Yes, <input type="checkbox"/> No			752	<input type="checkbox"/> Yes, <input type="checkbox"/> No		
703	<input type="checkbox"/> Yes, <input type="checkbox"/> No			753	<input type="checkbox"/> Yes, <input type="checkbox"/> No		
704	<input type="checkbox"/> Yes, <input type="checkbox"/> No			754	<input type="checkbox"/> Yes, <input type="checkbox"/> No		
705	<input type="checkbox"/> Yes, <input type="checkbox"/> No			755	<input type="checkbox"/> Yes, <input type="checkbox"/> No		
706	<input type="checkbox"/> Yes, <input type="checkbox"/> No			756	<input type="checkbox"/> Yes, <input type="checkbox"/> No		
707	<input type="checkbox"/> Yes, <input type="checkbox"/> No			757	<input type="checkbox"/> Yes, <input type="checkbox"/> No		
708	<input type="checkbox"/> Yes, <input type="checkbox"/> No			758	<input type="checkbox"/> Yes, <input type="checkbox"/> No		
709	<input type="checkbox"/> Yes, <input type="checkbox"/> No			759	<input type="checkbox"/> Yes, <input type="checkbox"/> No		
710	<input type="checkbox"/> Yes, <input type="checkbox"/> No			760	<input type="checkbox"/> Yes, <input type="checkbox"/> No		
711	<input type="checkbox"/> Yes, <input type="checkbox"/> No			761	<input type="checkbox"/> Yes, <input type="checkbox"/> No		
712	<input type="checkbox"/> Yes, <input type="checkbox"/> No			7 6 2	<input type="checkbox"/> Yes, <input type="checkbox"/> No		
713	<input type="checkbox"/> Yes, <input type="checkbox"/> No			7 6 3	<input type="checkbox"/> Yes, <input type="checkbox"/> No		
714	<input type="checkbox"/> Yes, <input type="checkbox"/> No			764	<input type="checkbox"/> Yes, <input type="checkbox"/> No		
715	<input type="checkbox"/> Yes, <input type="checkbox"/> No			765	<input type="checkbox"/> Yes, <input type="checkbox"/> No		
716	<input type="checkbox"/> Yes, <input type="checkbox"/> No			766	<input type="checkbox"/> Yes, <input type="checkbox"/> No		
717	<input type="checkbox"/> Yes, <input type="checkbox"/> No			767	<input type="checkbox"/> Yes, <input type="checkbox"/> No		
718	<input type="checkbox"/> Yes, <input type="checkbox"/> No			768	<input type="checkbox"/> Yes, <input type="checkbox"/> No		
719	<input type="checkbox"/> Yes, <input type="checkbox"/> No			769	<input type="checkbox"/> Yes, <input type="checkbox"/> No		
720	<input type="checkbox"/> Yes, <input type="checkbox"/> No			770	<input type="checkbox"/> Yes, <input type="checkbox"/> No		
721	<input type="checkbox"/> Yes, <input type="checkbox"/> No			771	<input type="checkbox"/> Yes, <input type="checkbox"/> No		
722	<input type="checkbox"/> Yes, <input type="checkbox"/> No			772	<input type="checkbox"/> Yes, <input type="checkbox"/> No		
723	<input type="checkbox"/> Yes, <input type="checkbox"/> No			773	<input type="checkbox"/> Yes, <input type="checkbox"/> No		
724	<input type="checkbox"/> Yes, <input type="checkbox"/> No			774	<input type="checkbox"/> Yes, <input type="checkbox"/> No		
725	<input type="checkbox"/> Yes, <input type="checkbox"/> No			775	<input type="checkbox"/> Yes, <input type="checkbox"/> No		
726	<input type="checkbox"/> Yes, <input type="checkbox"/> No			776	<input type="checkbox"/> Yes, <input type="checkbox"/> No		
727	<input type="checkbox"/> Yes, <input type="checkbox"/> No			777	<input type="checkbox"/> Yes, <input type="checkbox"/> No		
728	<input type="checkbox"/> Yes, <input type="checkbox"/> No			778	<input type="checkbox"/> Yes, <input type="checkbox"/> No		
729	<input type="checkbox"/> Yes, <input type="checkbox"/> No			779	<input type="checkbox"/> Yes, <input type="checkbox"/> No		
730	<input type="checkbox"/> Yes, <input type="checkbox"/> No			780	<input type="checkbox"/> Yes, <input type="checkbox"/> No		
731	<input type="checkbox"/> Yes, <input type="checkbox"/> No			781	<input type="checkbox"/> Yes, <input type="checkbox"/> No		
732	<input type="checkbox"/> Yes, <input type="checkbox"/> No			782	<input type="checkbox"/> Yes, <input type="checkbox"/> No		
733	<input type="checkbox"/> Yes, <input type="checkbox"/> No			783	<input type="checkbox"/> Yes, <input type="checkbox"/> No		
734	<input type="checkbox"/> Yes, <input type="checkbox"/> No			784	<input type="checkbox"/> Yes, <input type="checkbox"/> No		
735	<input type="checkbox"/> Yes, <input type="checkbox"/> No			785	<input type="checkbox"/> Yes, <input type="checkbox"/> No		
736	<input type="checkbox"/> Yes, <input type="checkbox"/> No			786	<input type="checkbox"/> Yes, <input type="checkbox"/> No		
737	<input type="checkbox"/> Yes, <input type="checkbox"/> No			787	<input type="checkbox"/> Yes, <input type="checkbox"/> No		
738	<input type="checkbox"/> Yes, <input type="checkbox"/> No			788	<input type="checkbox"/> Yes, <input type="checkbox"/> No		
739	<input type="checkbox"/> Yes, <input type="checkbox"/> No			789	<input type="checkbox"/> Yes, <input type="checkbox"/> No		
740	<input type="checkbox"/> Yes, <input type="checkbox"/> No			790	<input type="checkbox"/> Yes, <input type="checkbox"/> No		
741	<input type="checkbox"/> Yes, <input type="checkbox"/> No			791	<input type="checkbox"/> Yes, <input type="checkbox"/> No		
742	<input type="checkbox"/> Yes, <input type="checkbox"/> No			792	<input type="checkbox"/> Yes, <input type="checkbox"/> No		
743	<input type="checkbox"/> Yes, <input type="checkbox"/> No			793	<input type="checkbox"/> Yes, <input type="checkbox"/> No		
744	<input type="checkbox"/> Yes, <input type="checkbox"/> No			794	<input type="checkbox"/> Yes, <input type="checkbox"/> No		
745	<input type="checkbox"/> Yes, <input type="checkbox"/> No			795	<input type="checkbox"/> Yes, <input type="checkbox"/> No		
746	<input type="checkbox"/> Yes, <input type="checkbox"/> No			796	<input type="checkbox"/> Yes, <input type="checkbox"/> No		
747	<input type="checkbox"/> Yes, <input type="checkbox"/> No			797	<input type="checkbox"/> Yes, <input type="checkbox"/> No		
748	<input type="checkbox"/> Yes, <input type="checkbox"/> No			798	<input type="checkbox"/> Yes, <input type="checkbox"/> No		
749	<input type="checkbox"/> Yes, <input type="checkbox"/> No			799	<input type="checkbox"/> Yes, <input type="checkbox"/> No		

TOLL RESTRICTION-AREA/OFFICE CODE TABLE (7/8)

Area/Office Code Table No. 6

Code No.	Local Call Access	Restriction Level	Office Code	Code No.	Local Call Access	Restriction Level	Office Code
800	<input type="checkbox"/> Yes, <input type="checkbox"/> No			850	<input type="checkbox"/> Yes, <input type="checkbox"/> No		
801	<input type="checkbox"/> Yes, <input type="checkbox"/> No			851	<input type="checkbox"/> Yes, <input type="checkbox"/> No		
802	<input type="checkbox"/> Yes, <input type="checkbox"/> No			852	<input type="checkbox"/> Yes, <input type="checkbox"/> No		
803	<input type="checkbox"/> Yes, <input type="checkbox"/> No			853	<input type="checkbox"/> Yes, <input type="checkbox"/> No		
804	<input type="checkbox"/> Yes, <input type="checkbox"/> No			854	<input type="checkbox"/> Yes, <input type="checkbox"/> No		
805	<input type="checkbox"/> Yes, <input type="checkbox"/> No			855	<input type="checkbox"/> Yes, <input type="checkbox"/> No		
806	<input type="checkbox"/> Yes, <input type="checkbox"/> No			856	<input type="checkbox"/> Yes, <input type="checkbox"/> No		
807	<input type="checkbox"/> Yes, <input type="checkbox"/> No			857	<input type="checkbox"/> Yes, <input type="checkbox"/> No		
808	<input type="checkbox"/> Yes, <input type="checkbox"/> No			858	<input type="checkbox"/> Yes, <input type="checkbox"/> No		
809	<input type="checkbox"/> Yes, <input type="checkbox"/> No			859	<input type="checkbox"/> Yes, <input type="checkbox"/> No		
810	<input type="checkbox"/> Yes, <input type="checkbox"/> No			860	<input type="checkbox"/> Yes, <input type="checkbox"/> No		
811	<input type="checkbox"/> Yes, <input type="checkbox"/> No			861	<input type="checkbox"/> Yes, <input type="checkbox"/> No		
812	<input type="checkbox"/> Yes, <input type="checkbox"/> No			862	<input type="checkbox"/> Yes, <input type="checkbox"/> No		
813	<input type="checkbox"/> Yes, <input type="checkbox"/> No			863	<input type="checkbox"/> Yes, <input type="checkbox"/> No		
814	<input type="checkbox"/> Yes, <input type="checkbox"/> No			864	<input type="checkbox"/> Yes, <input type="checkbox"/> No		
815	<input type="checkbox"/> Yes, <input type="checkbox"/> No			865	<input type="checkbox"/> Yes, <input type="checkbox"/> No		
816	<input type="checkbox"/> Yes, <input type="checkbox"/> No			866	<input type="checkbox"/> Yes, <input type="checkbox"/> No		
817	<input type="checkbox"/> Yes, <input type="checkbox"/> No			867	<input type="checkbox"/> Yes, <input type="checkbox"/> No		
818	<input type="checkbox"/> Yes, <input type="checkbox"/> No			868	<input type="checkbox"/> Yes, <input type="checkbox"/> No		
819	<input type="checkbox"/> Yes, <input type="checkbox"/> No			869	<input type="checkbox"/> Yes, <input type="checkbox"/> No		
820	<input type="checkbox"/> Yes, <input type="checkbox"/> No			870	<input type="checkbox"/> Yes, <input type="checkbox"/> No		
821	<input type="checkbox"/> Yes, <input type="checkbox"/> No			871	<input type="checkbox"/> Yes, <input type="checkbox"/> No		
822	<input type="checkbox"/> Yes, <input type="checkbox"/> No			872	<input type="checkbox"/> Yes, <input type="checkbox"/> No		
823	<input type="checkbox"/> Yes, <input type="checkbox"/> No			873	<input type="checkbox"/> Yes, <input type="checkbox"/> No		
824	<input type="checkbox"/> Yes, <input type="checkbox"/> No			874	<input type="checkbox"/> Yes, <input type="checkbox"/> No		
825	<input type="checkbox"/> Yes, <input type="checkbox"/> No			875	<input type="checkbox"/> Yes, <input type="checkbox"/> No		
826	<input type="checkbox"/> Yes, <input type="checkbox"/> No			876	<input type="checkbox"/> Yes, <input type="checkbox"/> No		
827	<input type="checkbox"/> Yes, <input type="checkbox"/> No			877	<input type="checkbox"/> Yes, <input type="checkbox"/> No		
828	<input type="checkbox"/> Yes, <input type="checkbox"/> No			878	<input type="checkbox"/> Yes, <input type="checkbox"/> No		
829	<input type="checkbox"/> Yes, <input type="checkbox"/> No			879	<input type="checkbox"/> Yes, <input type="checkbox"/> No		
830	<input type="checkbox"/> Yes, <input type="checkbox"/> No			880	<input type="checkbox"/> Yes, <input type="checkbox"/> No		
831	<input type="checkbox"/> Yes, <input type="checkbox"/> No			881	<input type="checkbox"/> Yes, <input type="checkbox"/> No		
832	<input type="checkbox"/> Yes, <input type="checkbox"/> No			882	<input type="checkbox"/> Yes, <input type="checkbox"/> No		
833	<input type="checkbox"/> Yes, <input type="checkbox"/> No			883	<input type="checkbox"/> Yes, <input type="checkbox"/> No		
834	<input type="checkbox"/> Yes, <input type="checkbox"/> No			884	<input type="checkbox"/> Yes, <input type="checkbox"/> No		
835	<input type="checkbox"/> Yes, <input type="checkbox"/> No			885	<input type="checkbox"/> Yes, <input type="checkbox"/> No		
836	<input type="checkbox"/> Yes, <input type="checkbox"/> No			886	<input type="checkbox"/> Yes, <input type="checkbox"/> No		
837	<input type="checkbox"/> Yes, <input type="checkbox"/> No			887	<input type="checkbox"/> Yes, <input type="checkbox"/> No		
838	<input type="checkbox"/> Yes, <input type="checkbox"/> No			888	<input type="checkbox"/> Yes, <input type="checkbox"/> No		
839	<input type="checkbox"/> Yes, <input type="checkbox"/> No			889	<input type="checkbox"/> Yes, <input type="checkbox"/> No		
840	<input type="checkbox"/> Yes, <input type="checkbox"/> No			890	<input type="checkbox"/> Yes, <input type="checkbox"/> No		
841	<input type="checkbox"/> Yes, <input type="checkbox"/> No			891	<input type="checkbox"/> Yes, <input type="checkbox"/> No		
842	<input type="checkbox"/> Yes, <input type="checkbox"/> No			892	<input type="checkbox"/> Yes, <input type="checkbox"/> No		
843	<input type="checkbox"/> Yes, <input type="checkbox"/> No			893	<input type="checkbox"/> Yes, <input type="checkbox"/> No		
844	<input type="checkbox"/> Yes, <input type="checkbox"/> No			894	<input type="checkbox"/> Yes, <input type="checkbox"/> No		
845	<input type="checkbox"/> Yes, <input type="checkbox"/> No			895	<input type="checkbox"/> Yes, <input type="checkbox"/> No		
846	<input type="checkbox"/> Yes, <input type="checkbox"/> No			896	<input type="checkbox"/> Yes, <input type="checkbox"/> No		
847	<input type="checkbox"/> Yes, <input type="checkbox"/> No			897	<input type="checkbox"/> Yes, <input type="checkbox"/> No		
848	<input type="checkbox"/> Yes, <input type="checkbox"/> No			898	<input type="checkbox"/> Yes, <input type="checkbox"/> No		
849	<input type="checkbox"/> Yes, <input type="checkbox"/> No			899	<input type="checkbox"/> Yes, <input type="checkbox"/> No		

TOLL RESTRICTION-AREA/OFFICE CODE TABLE (8/8)

Area/Office Code Table No. 6

Code No.	Local Call Access	Restriction Level	Office Code	Code No.	Local Call Access	Restriction Level	Office Code
900	<input type="checkbox"/> Yes, <input type="checkbox"/> No			950	<input type="checkbox"/> Yes, <input type="checkbox"/> No		
901	<input type="checkbox"/> Yes, <input type="checkbox"/> No			951	<input type="checkbox"/> Yes, <input type="checkbox"/> No		
902	<input type="checkbox"/> Yes, <input type="checkbox"/> No			952	<input type="checkbox"/> Yes, <input type="checkbox"/> No		
903	<input type="checkbox"/> Yes, <input type="checkbox"/> No			953	<input type="checkbox"/> Yes, <input type="checkbox"/> No		
904	<input type="checkbox"/> Yes, <input type="checkbox"/> No			954	<input type="checkbox"/> Yes, <input type="checkbox"/> No		
905	<input type="checkbox"/> Yes, <input type="checkbox"/> No			955	<input type="checkbox"/> Yes, <input type="checkbox"/> No		
906	<input type="checkbox"/> Yes, <input type="checkbox"/> No			956	<input type="checkbox"/> Yes, <input type="checkbox"/> No		
907	<input type="checkbox"/> Yes, <input type="checkbox"/> No			957	<input type="checkbox"/> Yes, <input type="checkbox"/> No		
908	<input type="checkbox"/> Yes, <input type="checkbox"/> No			958	<input type="checkbox"/> Yes, <input type="checkbox"/> No		
909	<input type="checkbox"/> Yes, <input type="checkbox"/> No			959	<input type="checkbox"/> Yes, <input type="checkbox"/> No		
910	<input type="checkbox"/> Yes, <input type="checkbox"/> No			960	<input type="checkbox"/> Yes, <input type="checkbox"/> No		
911	<input type="checkbox"/> Yes, <input type="checkbox"/> No			961	<input type="checkbox"/> Yes, <input type="checkbox"/> No		
912	<input type="checkbox"/> Yes, <input type="checkbox"/> No			962	<input type="checkbox"/> Yes, <input type="checkbox"/> No		
913	<input type="checkbox"/> Yes, <input type="checkbox"/> No			963	<input type="checkbox"/> Yes, <input type="checkbox"/> No		
914	<input type="checkbox"/> Yes, <input type="checkbox"/> No			964	<input type="checkbox"/> Yes, <input type="checkbox"/> No		
915	<input type="checkbox"/> Yes, <input type="checkbox"/> No			965	<input type="checkbox"/> Yes, <input type="checkbox"/> No		
916	<input type="checkbox"/> Yes, <input type="checkbox"/> No			966	<input type="checkbox"/> Yes, <input type="checkbox"/> No		
917	<input type="checkbox"/> Yes, <input type="checkbox"/> No			967	<input type="checkbox"/> Yes, <input type="checkbox"/> No		
918	<input type="checkbox"/> Yes, <input type="checkbox"/> No			968	<input type="checkbox"/> Yes, <input type="checkbox"/> No		
919	<input type="checkbox"/> Yes, <input type="checkbox"/> No			969	<input type="checkbox"/> Yes, <input type="checkbox"/> No		
920	<input type="checkbox"/> Yes, <input type="checkbox"/> No			970	<input type="checkbox"/> Yes, <input type="checkbox"/> No		
921	<input type="checkbox"/> Yes, <input type="checkbox"/> No			971	<input type="checkbox"/> Yes, <input type="checkbox"/> No		
922	<input type="checkbox"/> Yes, <input type="checkbox"/> No			972	<input type="checkbox"/> Yes, <input type="checkbox"/> No		
923	<input type="checkbox"/> Yes, <input type="checkbox"/> No			973	<input type="checkbox"/> Yes, <input type="checkbox"/> No		
924	<input type="checkbox"/> Yes, <input type="checkbox"/> No			974	<input type="checkbox"/> Yes, <input type="checkbox"/> No		
925	<input type="checkbox"/> Yes, <input type="checkbox"/> No			975	<input type="checkbox"/> Yes, <input type="checkbox"/> No		
926	<input type="checkbox"/> Yes, <input type="checkbox"/> No			976	<input type="checkbox"/> Yes, <input type="checkbox"/> No		
927	<input type="checkbox"/> Yes, <input type="checkbox"/> No			977	<input type="checkbox"/> Yes, <input type="checkbox"/> No		
928	<input type="checkbox"/> Yes, <input type="checkbox"/> No			978	<input type="checkbox"/> Yes, <input type="checkbox"/> No		
929	<input type="checkbox"/> Yes, <input type="checkbox"/> No			979	<input type="checkbox"/> Yes, <input type="checkbox"/> No		
930	<input type="checkbox"/> Yes, <input type="checkbox"/> No			980	<input type="checkbox"/> Yes, <input type="checkbox"/> No		
931	<input type="checkbox"/> Yes, <input type="checkbox"/> No			981	<input type="checkbox"/> Yes, <input type="checkbox"/> No		
932	<input type="checkbox"/> Yes, <input type="checkbox"/> No			982	<input type="checkbox"/> Yes, <input type="checkbox"/> No		
933	<input type="checkbox"/> Yes, <input type="checkbox"/> No			983	<input type="checkbox"/> Yes, <input type="checkbox"/> No		
934	<input type="checkbox"/> Yes, <input type="checkbox"/> No			984	<input type="checkbox"/> Yes, <input type="checkbox"/> No		
935	<input type="checkbox"/> Yes, <input type="checkbox"/> No			985	<input type="checkbox"/> Yes, <input type="checkbox"/> No		
936	<input type="checkbox"/> Yes, <input type="checkbox"/> No			986	<input type="checkbox"/> Yes, <input type="checkbox"/> No		
937	<input type="checkbox"/> Yes, <input type="checkbox"/> No			987	<input type="checkbox"/> Yes, <input type="checkbox"/> No		
938	<input type="checkbox"/> Yes, <input type="checkbox"/> No			988	<input type="checkbox"/> Yes, <input type="checkbox"/> No		
939	<input type="checkbox"/> Yes, <input type="checkbox"/> No			989	<input type="checkbox"/> Yes, <input type="checkbox"/> No		
940	<input type="checkbox"/> Yes, <input type="checkbox"/> No			990	<input type="checkbox"/> Yes, <input type="checkbox"/> No		
941	<input type="checkbox"/> Yes, <input type="checkbox"/> No			991	<input type="checkbox"/> Yes, <input type="checkbox"/> No		
942	<input type="checkbox"/> Yes, <input type="checkbox"/> No			992	<input type="checkbox"/> Yes, <input type="checkbox"/> No		
943	<input type="checkbox"/> Yes, <input type="checkbox"/> No			993	<input type="checkbox"/> Yes, <input type="checkbox"/> No		
944	<input type="checkbox"/> Yes, <input type="checkbox"/> No			994	<input type="checkbox"/> Yes, <input type="checkbox"/> No		
945	<input type="checkbox"/> Yes, <input type="checkbox"/> No			995	<input type="checkbox"/> Yes, <input type="checkbox"/> No		
946	<input type="checkbox"/> Yes, <input type="checkbox"/> No			996	<input type="checkbox"/> Yes, <input type="checkbox"/> No		
947	<input type="checkbox"/> Yes, <input type="checkbox"/> No			997	<input type="checkbox"/> Yes, <input type="checkbox"/> No		
948	<input type="checkbox"/> Yes, <input type="checkbox"/> No			998	<input type="checkbox"/> Yes, <input type="checkbox"/> No		
949	<input type="checkbox"/> Yes, <input type="checkbox"/> No			999	<input type="checkbox"/> Yes, <input type="checkbox"/> No		

TOLL RESTRICTION-AREA/OFFICE CODE TABLE (1/8)

Area/Office Code Table No. 7

Code No.	Local Call Access	Restriction Level	Office Code	Code No.	Local Call Access	Restriction Level	Office Code
200	<input type="checkbox"/> Yes, <input type="checkbox"/> No			250	<input type="checkbox"/> Yes, <input type="checkbox"/> No		
201	<input type="checkbox"/> Yes, <input type="checkbox"/> No			251	<input type="checkbox"/> Yes, <input type="checkbox"/> No		
202	<input type="checkbox"/> Yes, <input type="checkbox"/> No			252	<input type="checkbox"/> Yes, <input type="checkbox"/> No		
203	<input type="checkbox"/> Yes, <input type="checkbox"/> No			253	<input type="checkbox"/> Yes, <input type="checkbox"/> No		
204	<input type="checkbox"/> Yes, <input type="checkbox"/> No			254	<input type="checkbox"/> Yes, <input type="checkbox"/> No		
205	<input type="checkbox"/> Yes, <input type="checkbox"/> No			255	<input type="checkbox"/> Yes, <input type="checkbox"/> No		
206	<input type="checkbox"/> Yes, <input type="checkbox"/> No			256	<input type="checkbox"/> Yes, <input type="checkbox"/> No		
207	<input type="checkbox"/> Yes, <input type="checkbox"/> No			257	<input type="checkbox"/> Yes, <input type="checkbox"/> No		
208	<input type="checkbox"/> Yes, <input type="checkbox"/> No			258	<input type="checkbox"/> Yes, <input type="checkbox"/> No		
209	<input type="checkbox"/> Yes, <input type="checkbox"/> No			259	<input type="checkbox"/> Yes, <input type="checkbox"/> No		
210	<input type="checkbox"/> Yes, <input type="checkbox"/> No			260	<input type="checkbox"/> Yes, <input type="checkbox"/> No		
211	<input type="checkbox"/> Yes, <input type="checkbox"/> No			261	<input type="checkbox"/> Yes, <input type="checkbox"/> No		
212	<input type="checkbox"/> Yes, <input type="checkbox"/> No			262	<input type="checkbox"/> Yes, <input type="checkbox"/> No		
213	<input type="checkbox"/> Yes, <input type="checkbox"/> No			263	<input type="checkbox"/> Yes, <input type="checkbox"/> No		
214	<input type="checkbox"/> Yes, <input type="checkbox"/> No			264	<input type="checkbox"/> Yes, <input type="checkbox"/> No		
215	<input type="checkbox"/> Yes, <input type="checkbox"/> No			265	<input type="checkbox"/> Yes, <input type="checkbox"/> No		
216	<input type="checkbox"/> Yes, <input type="checkbox"/> No			266	<input type="checkbox"/> Yes, <input type="checkbox"/> No		
217	<input type="checkbox"/> Yes, <input type="checkbox"/> No			267	<input type="checkbox"/> Yes, <input type="checkbox"/> No		
218	<input type="checkbox"/> Yes, <input type="checkbox"/> No			268	<input type="checkbox"/> Yes, <input type="checkbox"/> No		
219	<input type="checkbox"/> Yes, <input type="checkbox"/> No			269	<input type="checkbox"/> Yes, <input type="checkbox"/> No		
220	<input type="checkbox"/> Yes, <input type="checkbox"/> No			270	<input type="checkbox"/> Yes, <input type="checkbox"/> No		
221	<input type="checkbox"/> Yes, <input type="checkbox"/> No			271	<input type="checkbox"/> Yes, <input type="checkbox"/> No		
222	<input type="checkbox"/> Yes, <input type="checkbox"/> No			272	<input type="checkbox"/> Yes, <input type="checkbox"/> No		
223	<input type="checkbox"/> Yes, <input type="checkbox"/> No			273	<input type="checkbox"/> Yes, <input type="checkbox"/> No		
224	<input type="checkbox"/> Yes, <input type="checkbox"/> No			274	<input type="checkbox"/> Yes, <input type="checkbox"/> No		
225	<input type="checkbox"/> Yes, <input type="checkbox"/> No			275	<input type="checkbox"/> Yes, <input type="checkbox"/> No		
226	<input type="checkbox"/> Yes, <input type="checkbox"/> No			276	<input type="checkbox"/> Yes, <input type="checkbox"/> No		
227	<input type="checkbox"/> Yes, <input type="checkbox"/> No			277	<input type="checkbox"/> Yes, <input type="checkbox"/> No		
228	<input type="checkbox"/> Yes, <input type="checkbox"/> No			278	<input type="checkbox"/> Yes, <input type="checkbox"/> No		
229	<input type="checkbox"/> Yes, <input type="checkbox"/> No			279	<input type="checkbox"/> Yes, <input type="checkbox"/> No		
230	<input type="checkbox"/> Yes, <input type="checkbox"/> No			280	<input type="checkbox"/> Yes, <input type="checkbox"/> No		
231	<input type="checkbox"/> Yes, <input type="checkbox"/> No			281	<input type="checkbox"/> Yes, <input type="checkbox"/> No		
232	<input type="checkbox"/> Yes, <input type="checkbox"/> No			282	<input type="checkbox"/> Yes, <input type="checkbox"/> No		
233	<input type="checkbox"/> Yes, <input type="checkbox"/> No			283	<input type="checkbox"/> Yes, <input type="checkbox"/> No		
234	<input type="checkbox"/> Yes, <input type="checkbox"/> No			284	<input type="checkbox"/> Yes, <input type="checkbox"/> No		
235	<input type="checkbox"/> Yes, <input type="checkbox"/> No			285	<input type="checkbox"/> Yes, <input type="checkbox"/> No		
236	<input type="checkbox"/> Yes, <input type="checkbox"/> No			286	<input type="checkbox"/> Yes, <input type="checkbox"/> No		
237	<input type="checkbox"/> Yes, <input type="checkbox"/> No			287	<input type="checkbox"/> Yes, <input type="checkbox"/> No		
238	<input type="checkbox"/> Yes, <input type="checkbox"/> No			288	<input type="checkbox"/> Yes, <input type="checkbox"/> No		
239	<input type="checkbox"/> Yes, <input type="checkbox"/> No			289	<input type="checkbox"/> Yes, <input type="checkbox"/> No		
240	<input type="checkbox"/> Yes, <input type="checkbox"/> No			290	<input type="checkbox"/> Yes, <input type="checkbox"/> No		
241	<input type="checkbox"/> Yes, <input type="checkbox"/> No			291	<input type="checkbox"/> Yes, <input type="checkbox"/> No		
242	<input type="checkbox"/> Yes, <input type="checkbox"/> No			292	<input type="checkbox"/> Yes, <input type="checkbox"/> No		
243	<input type="checkbox"/> Yes, <input type="checkbox"/> No			293	<input type="checkbox"/> Yes, <input type="checkbox"/> No		
244	<input type="checkbox"/> Yes, <input type="checkbox"/> No			294	<input type="checkbox"/> Yes, <input type="checkbox"/> No		
245	<input type="checkbox"/> Yes, <input type="checkbox"/> No			295	<input type="checkbox"/> Yes, <input type="checkbox"/> No		
246	<input type="checkbox"/> Yes, <input type="checkbox"/> No			296	<input type="checkbox"/> Yes, <input type="checkbox"/> No		
247	<input type="checkbox"/> Yes, <input type="checkbox"/> No			297	<input type="checkbox"/> Yes, <input type="checkbox"/> No		
248	<input type="checkbox"/> Yes, <input type="checkbox"/> No			298	<input type="checkbox"/> Yes, <input type="checkbox"/> No		
249	<input type="checkbox"/> Yes, <input type="checkbox"/> No			299	<input type="checkbox"/> Yes, <input type="checkbox"/> No		

TOLL RESTRICTION-AREA/OFFICE CODE TABLE (2/8)

Area/Office Code Table No. 7

Code No.	Local Call Access	Restriction Level	Office Code	Code No.	Local Call Access	Restriction Level	Office Code
300	<input type="checkbox"/> Yes, <input type="checkbox"/> No			350	<input type="checkbox"/> Yes, <input type="checkbox"/> No		
301	<input type="checkbox"/> Yes, <input type="checkbox"/> No			351	<input type="checkbox"/> Yes, <input type="checkbox"/> No		
302	<input type="checkbox"/> Yes, <input type="checkbox"/> No			352	<input type="checkbox"/> Yes, <input type="checkbox"/> No		
303	<input type="checkbox"/> Yes, <input type="checkbox"/> No			353	<input type="checkbox"/> Yes, <input type="checkbox"/> No		
304	<input type="checkbox"/> Yes, <input type="checkbox"/> No			354	<input type="checkbox"/> Yes, <input type="checkbox"/> No		
305	<input type="checkbox"/> Yes, <input type="checkbox"/> No			355	<input type="checkbox"/> Yes, <input type="checkbox"/> No		
306	<input type="checkbox"/> Yes, <input type="checkbox"/> No			356	<input type="checkbox"/> Yes, <input type="checkbox"/> No		
307	<input type="checkbox"/> Yes, <input type="checkbox"/> No			357	<input type="checkbox"/> Yes, <input type="checkbox"/> No		
308	<input type="checkbox"/> Yes, <input type="checkbox"/> No			358	<input type="checkbox"/> Yes, <input type="checkbox"/> No		
309	<input type="checkbox"/> Yes, <input type="checkbox"/> No			359	<input type="checkbox"/> Yes, <input type="checkbox"/> No		
310	<input type="checkbox"/> Yes, <input type="checkbox"/> No			360	<input type="checkbox"/> Yes, <input type="checkbox"/> No		
311	<input type="checkbox"/> Yes, <input type="checkbox"/> No			361	<input type="checkbox"/> Yes, <input type="checkbox"/> No		
312	<input type="checkbox"/> Yes, <input type="checkbox"/> No			362	<input type="checkbox"/> Yes, <input type="checkbox"/> No		
313	<input type="checkbox"/> Yes, <input type="checkbox"/> No			363	<input type="checkbox"/> Yes, <input type="checkbox"/> No		
314	<input type="checkbox"/> Yes, <input type="checkbox"/> No			364	<input type="checkbox"/> Yes, <input type="checkbox"/> No		
315	<input type="checkbox"/> Yes, <input type="checkbox"/> No			365	<input type="checkbox"/> Yes, <input type="checkbox"/> No		
316	<input type="checkbox"/> Yes, <input type="checkbox"/> No			366	<input type="checkbox"/> Yes, <input type="checkbox"/> No		
317	<input type="checkbox"/> Yes, <input type="checkbox"/> No			367	<input type="checkbox"/> Yes, <input type="checkbox"/> No		
318	<input type="checkbox"/> Yes, <input type="checkbox"/> No			368	<input type="checkbox"/> Yes, <input type="checkbox"/> No		
319	<input type="checkbox"/> Yes, <input type="checkbox"/> No			369	<input type="checkbox"/> Yes, <input type="checkbox"/> No		
320	<input type="checkbox"/> Yes, <input type="checkbox"/> No			370	<input type="checkbox"/> Yes, <input type="checkbox"/> No		
321	<input type="checkbox"/> Yes, <input type="checkbox"/> No			371	<input type="checkbox"/> Yes, <input type="checkbox"/> No		
322	<input type="checkbox"/> Yes, <input type="checkbox"/> No			372	<input type="checkbox"/> Yes, <input type="checkbox"/> No		
323	<input type="checkbox"/> Yes, <input type="checkbox"/> No			373	<input type="checkbox"/> Yes, <input type="checkbox"/> No		
324	<input type="checkbox"/> Yes, <input type="checkbox"/> No			374	<input type="checkbox"/> Yes, <input type="checkbox"/> No		
325	<input type="checkbox"/> Yes, <input type="checkbox"/> No			375	<input type="checkbox"/> Yes, <input type="checkbox"/> No		
326	<input type="checkbox"/> Yes, <input type="checkbox"/> No			376	<input type="checkbox"/> Yes, <input type="checkbox"/> No		
327	<input type="checkbox"/> Yes, <input type="checkbox"/> No			377	<input type="checkbox"/> Yes, <input type="checkbox"/> No		
328	<input type="checkbox"/> Yes, <input type="checkbox"/> No			378	<input type="checkbox"/> Yes, <input type="checkbox"/> No		
329	<input type="checkbox"/> Yes, <input type="checkbox"/> No			379	<input type="checkbox"/> Yes, <input type="checkbox"/> No		
330	<input type="checkbox"/> Yes, <input type="checkbox"/> No			380	<input type="checkbox"/> Yes, <input type="checkbox"/> No		
331	<input type="checkbox"/> Yes, <input type="checkbox"/> No			381	<input type="checkbox"/> Yes, <input type="checkbox"/> No		
332	<input type="checkbox"/> Yes, <input type="checkbox"/> No			382	<input type="checkbox"/> Yes, <input type="checkbox"/> No		
333	<input type="checkbox"/> Yes, <input type="checkbox"/> No			383	<input type="checkbox"/> Yes, <input type="checkbox"/> No		
334	<input type="checkbox"/> Yes, <input type="checkbox"/> No			384	<input type="checkbox"/> Yes, <input type="checkbox"/> No		
335	<input type="checkbox"/> Yes, <input type="checkbox"/> No			385	<input type="checkbox"/> Yes, <input type="checkbox"/> No		
336	<input type="checkbox"/> Yes, <input type="checkbox"/> No			386	<input type="checkbox"/> Yes, <input type="checkbox"/> No		
337	<input type="checkbox"/> Yes, <input type="checkbox"/> No			387	<input type="checkbox"/> Yes, <input type="checkbox"/> No		
338	<input type="checkbox"/> Yes, <input type="checkbox"/> No			388	<input type="checkbox"/> Yes, <input type="checkbox"/> No		
339	<input type="checkbox"/> Yes, <input type="checkbox"/> No			389	<input type="checkbox"/> Yes, <input type="checkbox"/> No		
340	<input type="checkbox"/> Yes, <input type="checkbox"/> No			390	<input type="checkbox"/> Yes, <input type="checkbox"/> No		
341	<input type="checkbox"/> Yes, <input type="checkbox"/> No			391	<input type="checkbox"/> Yes, <input type="checkbox"/> No		
342	<input type="checkbox"/> Yes, <input type="checkbox"/> No			392	<input type="checkbox"/> Yes, <input type="checkbox"/> No		
343	<input type="checkbox"/> Yes, <input type="checkbox"/> No			393	<input type="checkbox"/> Yes, <input type="checkbox"/> No		
344	<input type="checkbox"/> Yes, <input type="checkbox"/> No			394	<input type="checkbox"/> Yes, <input type="checkbox"/> No		
345	<input type="checkbox"/> Yes, <input type="checkbox"/> No			395	<input type="checkbox"/> Yes, <input type="checkbox"/> No		
346	<input type="checkbox"/> Yes, <input type="checkbox"/> No			396	<input type="checkbox"/> Yes, <input type="checkbox"/> No		
347	<input type="checkbox"/> Yes, <input type="checkbox"/> No			397	<input type="checkbox"/> Yes, <input type="checkbox"/> No		
348	<input type="checkbox"/> Yes, <input type="checkbox"/> No			398	<input type="checkbox"/> Yes, <input type="checkbox"/> No		
349	<input type="checkbox"/> Yes, <input type="checkbox"/> No			399	<input type="checkbox"/> Yes, <input type="checkbox"/> No		

TOLL RESTRICTION-AREA/OFFICE CODE TABLE (318)

Area/Office Code Table No. 7

Code No.	Local Call Access	Restriction Level	Office Code	Code No.	Local Call Access	Restriction Level	Office Code
400	<input type="checkbox"/> Yes, <input type="checkbox"/> No			450	<input type="checkbox"/> Yes, <input type="checkbox"/> No		
401	<input type="checkbox"/> Yes, <input type="checkbox"/> No			451	<input type="checkbox"/> Yes, <input type="checkbox"/> No		
402	<input type="checkbox"/> Yes, <input type="checkbox"/> No			452	<input type="checkbox"/> Yes, <input type="checkbox"/> No		
403	<input type="checkbox"/> Yes, <input type="checkbox"/> No			453	<input type="checkbox"/> Yes, <input type="checkbox"/> No		
404	<input type="checkbox"/> Yes, <input type="checkbox"/> No			454	<input type="checkbox"/> Yes, <input type="checkbox"/> No		
405	<input type="checkbox"/> Yes, <input type="checkbox"/> No			455	<input type="checkbox"/> Yes, <input type="checkbox"/> No		
406	<input type="checkbox"/> Yes, <input type="checkbox"/> No			456	<input type="checkbox"/> Yes, <input type="checkbox"/> No		
407	<input type="checkbox"/> Yes, <input type="checkbox"/> No			457	<input type="checkbox"/> Yes, <input type="checkbox"/> No		
408	<input type="checkbox"/> Yes, <input type="checkbox"/> No			458	<input type="checkbox"/> Yes, <input type="checkbox"/> No		
409	<input type="checkbox"/> Yes, <input type="checkbox"/> No			459	<input type="checkbox"/> Yes, <input type="checkbox"/> No		
410	<input type="checkbox"/> Yes, <input type="checkbox"/> No			460	<input type="checkbox"/> Yes, <input type="checkbox"/> No		
411	<input type="checkbox"/> Yes, <input type="checkbox"/> No			461	<input type="checkbox"/> Yes, <input type="checkbox"/> No		
412	<input type="checkbox"/> Yes, <input type="checkbox"/> No			462	<input type="checkbox"/> Yes, <input type="checkbox"/> No		
413	<input type="checkbox"/> Yes, <input type="checkbox"/> No			463	<input type="checkbox"/> Yes, <input type="checkbox"/> No		
414	<input type="checkbox"/> Yes, <input type="checkbox"/> No			464	<input type="checkbox"/> Yes, <input type="checkbox"/> No		
415	<input type="checkbox"/> Yes, <input type="checkbox"/> No			465	<input type="checkbox"/> Yes, <input type="checkbox"/> No		
416	<input type="checkbox"/> Yes, <input type="checkbox"/> No			466	<input type="checkbox"/> Yes, <input type="checkbox"/> No		
417	<input type="checkbox"/> Yes, <input type="checkbox"/> No			467	<input type="checkbox"/> Yes, <input type="checkbox"/> No		
418	<input type="checkbox"/> Yes, <input type="checkbox"/> No			468	<input type="checkbox"/> Yes, <input type="checkbox"/> No		
419	<input type="checkbox"/> Yes, <input type="checkbox"/> No			469	<input type="checkbox"/> Yes, <input type="checkbox"/> No		
420	<input type="checkbox"/> Yes, <input type="checkbox"/> No			470	<input type="checkbox"/> Yes, <input type="checkbox"/> No		
421	<input type="checkbox"/> Yes, <input type="checkbox"/> No			471	<input type="checkbox"/> Yes, <input type="checkbox"/> No		
422	<input type="checkbox"/> Yes, <input type="checkbox"/> No			472	<input type="checkbox"/> Yes, <input type="checkbox"/> No		
423	<input type="checkbox"/> Yes, <input type="checkbox"/> No			473	<input type="checkbox"/> Yes, <input type="checkbox"/> No		
424	<input type="checkbox"/> Yes, <input type="checkbox"/> No			474	<input type="checkbox"/> Yes, <input type="checkbox"/> No		
425	<input type="checkbox"/> Yes, <input type="checkbox"/> No			475	<input type="checkbox"/> Yes, <input type="checkbox"/> No		
426	<input type="checkbox"/> Yes, <input type="checkbox"/> No			476	<input type="checkbox"/> Yes, <input type="checkbox"/> No		
427	<input type="checkbox"/> Yes, <input type="checkbox"/> No			477	<input type="checkbox"/> Yes, <input type="checkbox"/> No		
428	<input type="checkbox"/> Yes, <input type="checkbox"/> No			478	<input type="checkbox"/> Yes, <input type="checkbox"/> No		
429	<input type="checkbox"/> Yes, <input type="checkbox"/> No			479	<input type="checkbox"/> Yes, <input type="checkbox"/> No		
430	<input type="checkbox"/> Yes, <input type="checkbox"/> No			480	<input type="checkbox"/> Yes, <input type="checkbox"/> No		
431	<input type="checkbox"/> Yes, <input type="checkbox"/> No			481	<input type="checkbox"/> Yes, <input type="checkbox"/> No		
432	<input type="checkbox"/> Yes, <input type="checkbox"/> No			482	<input type="checkbox"/> Yes, <input type="checkbox"/> No		
433	<input type="checkbox"/> Yes, <input type="checkbox"/> No			483	<input type="checkbox"/> Yes, <input type="checkbox"/> No		
434	<input type="checkbox"/> Yes, <input type="checkbox"/> No			484	<input type="checkbox"/> Yes, <input type="checkbox"/> No		
435	<input type="checkbox"/> Yes, <input type="checkbox"/> No			485	<input type="checkbox"/> Yes, <input type="checkbox"/> No		
436	<input type="checkbox"/> Yes, <input type="checkbox"/> No			486	<input type="checkbox"/> Yes, <input type="checkbox"/> No		
437	<input type="checkbox"/> Yes, <input type="checkbox"/> No			487	<input type="checkbox"/> Yes, <input type="checkbox"/> No		
438	<input type="checkbox"/> Yes, <input type="checkbox"/> No			488	<input type="checkbox"/> Yes, <input type="checkbox"/> No		
439	<input type="checkbox"/> Yes, <input type="checkbox"/> No			489	<input type="checkbox"/> Yes, <input type="checkbox"/> No		
440	<input type="checkbox"/> Yes, <input type="checkbox"/> No			490	<input type="checkbox"/> Yes, <input type="checkbox"/> No		
441	<input type="checkbox"/> Yes, <input type="checkbox"/> No			491	<input type="checkbox"/> Yes, <input type="checkbox"/> No		
442	<input type="checkbox"/> Yes, <input type="checkbox"/> No			492	<input type="checkbox"/> Yes, <input type="checkbox"/> No		
443	<input type="checkbox"/> Yes, <input type="checkbox"/> No			493	<input type="checkbox"/> Yes, <input type="checkbox"/> No		
444	<input type="checkbox"/> Yes, <input type="checkbox"/> No			494	<input type="checkbox"/> Yes, <input type="checkbox"/> No		
445	<input type="checkbox"/> Yes, <input type="checkbox"/> No			495	<input type="checkbox"/> Yes, <input type="checkbox"/> No		
446	<input type="checkbox"/> Yes, <input type="checkbox"/> No			496	<input type="checkbox"/> Yes, <input type="checkbox"/> No		
447	<input type="checkbox"/> Yes, <input type="checkbox"/> No			497	<input type="checkbox"/> Yes, <input type="checkbox"/> No		
448	<input type="checkbox"/> Yes, <input type="checkbox"/> No			498	<input type="checkbox"/> Yes, <input type="checkbox"/> No		
449	<input type="checkbox"/> Yes, <input type="checkbox"/> No			499	<input type="checkbox"/> Yes, <input type="checkbox"/> No		

TOLL RESTRICTION-AREA/OFFICE CODE TABLE (4/8)

Area/Office Code Table No. 7

Code No.	Local Call Access	Restriction Level	Office Code	Code No.	Local Call Access	Restriction Level	Office Code
500	<input type="checkbox"/> Yes, <input type="checkbox"/> No			550	<input type="checkbox"/> Yes, <input type="checkbox"/> No		
501	<input type="checkbox"/> Yes, <input type="checkbox"/> No			551	<input type="checkbox"/> Yes, <input type="checkbox"/> No		
502	<input type="checkbox"/> Yes, <input type="checkbox"/> No			552	<input type="checkbox"/> Yes, <input type="checkbox"/> No		
503	<input type="checkbox"/> Yes, <input type="checkbox"/> No			553	<input type="checkbox"/> Yes, <input type="checkbox"/> No		
504	<input type="checkbox"/> Yes, <input type="checkbox"/> No			554	<input type="checkbox"/> Yes, <input type="checkbox"/> No		
505	<input type="checkbox"/> Yes, <input type="checkbox"/> No			555	<input type="checkbox"/> Yes, <input type="checkbox"/> No		
506	<input type="checkbox"/> Yes, <input type="checkbox"/> No			556	<input type="checkbox"/> Yes, <input type="checkbox"/> No		
507	<input type="checkbox"/> Yes, <input type="checkbox"/> No			557	<input type="checkbox"/> Yes, <input type="checkbox"/> No		
508	<input type="checkbox"/> Yes, <input type="checkbox"/> No			558	<input type="checkbox"/> Yes, <input type="checkbox"/> No		
509	<input type="checkbox"/> Yes, <input type="checkbox"/> No			559	<input type="checkbox"/> Yes, <input type="checkbox"/> No		
510	<input type="checkbox"/> Yes, <input type="checkbox"/> No			560	<input type="checkbox"/> Yes, <input type="checkbox"/> No		
511	<input type="checkbox"/> Yes, <input type="checkbox"/> No			561	<input type="checkbox"/> Yes, <input type="checkbox"/> No		
512	<input type="checkbox"/> Yes, <input type="checkbox"/> No			562	<input type="checkbox"/> Yes, <input type="checkbox"/> No		
513	<input type="checkbox"/> Yes, <input type="checkbox"/> No			563	<input type="checkbox"/> Yes, <input type="checkbox"/> No		
514	<input type="checkbox"/> Yes, <input type="checkbox"/> No			564	<input type="checkbox"/> Yes, <input type="checkbox"/> No		
515	<input type="checkbox"/> Yes, <input type="checkbox"/> No			565	<input type="checkbox"/> Yes, <input type="checkbox"/> No		
516	<input type="checkbox"/> Yes, <input type="checkbox"/> No			566	<input type="checkbox"/> Yes, <input type="checkbox"/> No		
517	<input type="checkbox"/> Yes, <input type="checkbox"/> No			567	<input type="checkbox"/> Yes, <input type="checkbox"/> No		
518	<input type="checkbox"/> Yes, <input type="checkbox"/> No			568	<input type="checkbox"/> Yes, <input type="checkbox"/> No		
5 1 9	<input type="checkbox"/> Yes, <input type="checkbox"/> No			570	<input type="checkbox"/> Yes, <input type="checkbox"/> No		
520	<input type="checkbox"/> Yes, <input type="checkbox"/> No			571	<input type="checkbox"/> Yes, <input type="checkbox"/> No		
521	<input type="checkbox"/> Yes, <input type="checkbox"/> No			572	<input type="checkbox"/> Yes, <input type="checkbox"/> No		
522	<input type="checkbox"/> Yes, <input type="checkbox"/> No			573	<input type="checkbox"/> Yes, <input type="checkbox"/> No		
523	<input type="checkbox"/> Yes, <input type="checkbox"/> No			574	<input type="checkbox"/> Yes, <input type="checkbox"/> No		
524	<input type="checkbox"/> Yes, <input type="checkbox"/> No			575	<input type="checkbox"/> Yes, <input type="checkbox"/> No		
525	<input type="checkbox"/> Yes, <input type="checkbox"/> No			576	<input type="checkbox"/> Yes, <input type="checkbox"/> No		
5 2 6	<input type="checkbox"/> Yes, <input type="checkbox"/> No			577	<input type="checkbox"/> Yes, <input type="checkbox"/> No		
527	<input type="checkbox"/> Yes, <input type="checkbox"/> No			578	<input type="checkbox"/> Yes, <input type="checkbox"/> No		
528	<input type="checkbox"/> Yes, <input type="checkbox"/> No			580	<input type="checkbox"/> Yes, <input type="checkbox"/> No		
530	<input type="checkbox"/> Yes, <input type="checkbox"/> No			5 8	<input type="checkbox"/> Yes, <input type="checkbox"/> No		
531	<input type="checkbox"/> Yes, <input type="checkbox"/> No			5 8 2	<input type="checkbox"/> Yes, <input type="checkbox"/> No		
532	<input type="checkbox"/> Yes, <input type="checkbox"/> No			583	<input type="checkbox"/> Yes, <input type="checkbox"/> No		
533	<input type="checkbox"/> Yes, <input type="checkbox"/> No			584	<input type="checkbox"/> Yes, <input type="checkbox"/> No		
534	<input type="checkbox"/> Yes, <input type="checkbox"/> No			585	<input type="checkbox"/> Yes, <input type="checkbox"/> No		
535	<input type="checkbox"/> Yes, <input type="checkbox"/> No			586	<input type="checkbox"/> Yes, <input type="checkbox"/> No		
536	<input type="checkbox"/> Yes, <input type="checkbox"/> No			587	<input type="checkbox"/> Yes, <input type="checkbox"/> No		
537	<input type="checkbox"/> Yes, <input type="checkbox"/> No			588	<input type="checkbox"/> Yes, <input type="checkbox"/> No		
538	<input type="checkbox"/> Yes, <input type="checkbox"/> No			589	<input type="checkbox"/> Yes, <input type="checkbox"/> No		
539	<input type="checkbox"/> Yes, <input type="checkbox"/> No			590	<input type="checkbox"/> Yes, <input type="checkbox"/> No		
540	<input type="checkbox"/> Yes, <input type="checkbox"/> No			591	<input type="checkbox"/> Yes, <input type="checkbox"/> No		
541	<input type="checkbox"/> Yes, <input type="checkbox"/> No			592	<input type="checkbox"/> Yes, <input type="checkbox"/> No		
5 4 2	<input type="checkbox"/> Yes, <input type="checkbox"/> No			593	<input type="checkbox"/> Yes, <input type="checkbox"/> No		
543	<input type="checkbox"/> Yes, <input type="checkbox"/> No			594	<input type="checkbox"/> Yes, <input type="checkbox"/> No		
544	<input type="checkbox"/> Yes, <input type="checkbox"/> No			595	<input type="checkbox"/> Yes, <input type="checkbox"/> No		
545	<input type="checkbox"/> Yes, <input type="checkbox"/> No			596	<input type="checkbox"/> Yes, <input type="checkbox"/> No		
546	<input type="checkbox"/> Yes, <input type="checkbox"/> No			597	<input type="checkbox"/> Yes, <input type="checkbox"/> No		
547	<input type="checkbox"/> Yes, <input type="checkbox"/> No			598	<input type="checkbox"/> Yes, <input type="checkbox"/> No		
548	<input type="checkbox"/> Yes, <input type="checkbox"/> No			599	<input type="checkbox"/> Yes, <input type="checkbox"/> No		
549	<input type="checkbox"/> Yes, <input type="checkbox"/> No						

TOLL RESTRICTION-AREA/OFFICE CODE TABLE (5/8)

Area/Office Code Table No. 7

Code No.	Local Call Access	Restriction Level	Office Code	Code No.	Local Call Access	Restriction Level	Office Code
600	<input type="checkbox"/> Yes, <input type="checkbox"/> No			650	<input type="checkbox"/> Yes, <input type="checkbox"/> No		
601	<input type="checkbox"/> Yes, <input type="checkbox"/> No			651	<input type="checkbox"/> Yes, <input type="checkbox"/> No		
602	<input type="checkbox"/> Yes, <input type="checkbox"/> No			652	<input type="checkbox"/> Yes, <input type="checkbox"/> No		
603	<input type="checkbox"/> Yes, <input type="checkbox"/> No			653	<input type="checkbox"/> Yes, <input type="checkbox"/> No		
604	<input type="checkbox"/> Yes, <input type="checkbox"/> No			654	<input type="checkbox"/> Yes, <input type="checkbox"/> No		
605	<input type="checkbox"/> Yes, <input type="checkbox"/> No			655	<input type="checkbox"/> Yes, <input type="checkbox"/> No		
606	<input type="checkbox"/> Yes, <input type="checkbox"/> No			656	<input type="checkbox"/> Yes, <input type="checkbox"/> No		
607	<input type="checkbox"/> Yes, <input type="checkbox"/> No			657	<input type="checkbox"/> Yes, <input type="checkbox"/> No		
608	<input type="checkbox"/> Yes, <input type="checkbox"/> No			658	<input type="checkbox"/> Yes, <input type="checkbox"/> No		
609	<input type="checkbox"/> Yes, <input type="checkbox"/> No			659	<input type="checkbox"/> Yes, <input type="checkbox"/> No		
610	<input type="checkbox"/> Yes, <input type="checkbox"/> No			660	<input type="checkbox"/> Yes, <input type="checkbox"/> No		
611	<input type="checkbox"/> Yes, <input type="checkbox"/> No			661	<input type="checkbox"/> Yes, <input type="checkbox"/> No		
612	<input type="checkbox"/> Yes, <input type="checkbox"/> No			662	<input type="checkbox"/> Yes, <input type="checkbox"/> No		
613	<input type="checkbox"/> Yes, <input type="checkbox"/> No			663	<input type="checkbox"/> Yes, <input type="checkbox"/> No		
614	<input type="checkbox"/> Yes, <input type="checkbox"/> No			664	<input type="checkbox"/> Yes, <input type="checkbox"/> No		
615	<input type="checkbox"/> Yes, <input type="checkbox"/> No			665	<input type="checkbox"/> Yes, <input type="checkbox"/> No		
616	<input type="checkbox"/> Yes, <input type="checkbox"/> No			666	<input type="checkbox"/> Yes, <input type="checkbox"/> No		
617	<input type="checkbox"/> Yes, <input type="checkbox"/> No			667	<input type="checkbox"/> Yes, <input type="checkbox"/> No		
618	<input type="checkbox"/> Yes, <input type="checkbox"/> No			668	<input type="checkbox"/> Yes, <input type="checkbox"/> No		
619	<input type="checkbox"/> Yes, <input type="checkbox"/> No			669	<input type="checkbox"/> Yes, <input type="checkbox"/> No		
620	<input type="checkbox"/> Yes, <input type="checkbox"/> No			670	<input type="checkbox"/> Yes, <input type="checkbox"/> No		
621	<input type="checkbox"/> Yes, <input type="checkbox"/> No			671	<input type="checkbox"/> Yes, <input type="checkbox"/> No		
622	<input type="checkbox"/> Yes, <input type="checkbox"/> No			672	<input type="checkbox"/> Yes, <input type="checkbox"/> No		
623	<input type="checkbox"/> Yes, <input type="checkbox"/> No			673	<input type="checkbox"/> Yes, <input type="checkbox"/> No		
624	<input type="checkbox"/> Yes, <input type="checkbox"/> No			674	<input type="checkbox"/> Yes, <input type="checkbox"/> No		
625	<input type="checkbox"/> Yes, <input type="checkbox"/> No			675	<input type="checkbox"/> Yes, <input type="checkbox"/> No		
626	<input type="checkbox"/> Yes, <input type="checkbox"/> No			676	<input type="checkbox"/> Yes, <input type="checkbox"/> No		
627	<input type="checkbox"/> Yes, <input type="checkbox"/> No			677	<input type="checkbox"/> Yes, <input type="checkbox"/> No		
628	<input type="checkbox"/> Yes, <input type="checkbox"/> No			678	<input type="checkbox"/> Yes, <input type="checkbox"/> No		
629	<input type="checkbox"/> Yes, <input type="checkbox"/> No			679	<input type="checkbox"/> Yes, <input type="checkbox"/> No		
630	<input type="checkbox"/> Yes, <input type="checkbox"/> No			680	<input type="checkbox"/> Yes, <input type="checkbox"/> No		
631	<input type="checkbox"/> Yes, <input type="checkbox"/> No			681	<input type="checkbox"/> Yes, <input type="checkbox"/> No		
632	<input type="checkbox"/> Yes, <input type="checkbox"/> No			682	<input type="checkbox"/> Yes, <input type="checkbox"/> No		
633	<input type="checkbox"/> Yes, <input type="checkbox"/> No			683	<input type="checkbox"/> Yes, <input type="checkbox"/> No		
634	<input type="checkbox"/> Yes, <input type="checkbox"/> No			684	<input type="checkbox"/> Yes, <input type="checkbox"/> No		
635	<input type="checkbox"/> Yes, <input type="checkbox"/> No			685	<input type="checkbox"/> Yes, <input type="checkbox"/> No		
636	<input type="checkbox"/> Yes, <input type="checkbox"/> No			686	<input type="checkbox"/> Yes, <input type="checkbox"/> No		
637	<input type="checkbox"/> Yes, <input type="checkbox"/> No			687	<input type="checkbox"/> Yes, <input type="checkbox"/> No		
638	<input type="checkbox"/> Yes, <input type="checkbox"/> No			688	<input type="checkbox"/> Yes, <input type="checkbox"/> No		
639	<input type="checkbox"/> Yes, <input type="checkbox"/> No			689	<input type="checkbox"/> Yes, <input type="checkbox"/> No		
640	<input type="checkbox"/> Yes, <input type="checkbox"/> No			690	<input type="checkbox"/> Yes, <input type="checkbox"/> No		
641	<input type="checkbox"/> Yes, <input type="checkbox"/> No			691	<input type="checkbox"/> Yes, <input type="checkbox"/> No		
642	<input type="checkbox"/> Yes, <input type="checkbox"/> No			692	<input type="checkbox"/> Yes, <input type="checkbox"/> No		
643	<input type="checkbox"/> Yes, <input type="checkbox"/> No			693	<input type="checkbox"/> Yes, <input type="checkbox"/> No		
644	<input type="checkbox"/> Yes, <input type="checkbox"/> No			694	<input type="checkbox"/> Yes, <input type="checkbox"/> No		
645	<input type="checkbox"/> Yes, <input type="checkbox"/> No			695	<input type="checkbox"/> Yes, <input type="checkbox"/> No		
646	<input type="checkbox"/> Yes, <input type="checkbox"/> No			696	<input type="checkbox"/> Yes, <input type="checkbox"/> No		
647	<input type="checkbox"/> Yes, <input type="checkbox"/> No			697	<input type="checkbox"/> Yes, <input type="checkbox"/> No		
648	<input type="checkbox"/> Yes, <input type="checkbox"/> No			698	<input type="checkbox"/> Yes, <input type="checkbox"/> No		
649	<input type="checkbox"/> Yes, <input type="checkbox"/> No			699	<input type="checkbox"/> Yes, <input type="checkbox"/> No		

TOLLRESTRICTION-AREA/OFFICE CODE TABLE (6/8)

Area/Office Code Table No. 7

Code No.	Local Call Access	Restriction Level	Office Code	Code No.	Local Call Access	Restriction Level	Office Code
700	<input type="checkbox"/> Yes <input type="checkbox"/> No			750	<input type="checkbox"/> Yes <input type="checkbox"/> No		
701	<input type="checkbox"/> Yes <input type="checkbox"/> No			751	<input type="checkbox"/> Yes <input type="checkbox"/> No		
702	<input type="checkbox"/> Yes <input type="checkbox"/> No			752	<input type="checkbox"/> Yes <input type="checkbox"/> No		
703	<input type="checkbox"/> Yes <input type="checkbox"/> No			753	<input type="checkbox"/> Yes <input type="checkbox"/> No		
704	<input type="checkbox"/> Yes <input type="checkbox"/> No			754	<input type="checkbox"/> Yes <input type="checkbox"/> No		
705	<input type="checkbox"/> Yes <input type="checkbox"/> No			755	<input type="checkbox"/> Yes <input type="checkbox"/> No		
706	<input type="checkbox"/> Yes <input type="checkbox"/> No			756	<input type="checkbox"/> Yes <input type="checkbox"/> No		
707	<input type="checkbox"/> Yes <input type="checkbox"/> No			757	<input type="checkbox"/> Yes <input type="checkbox"/> No		
708	<input type="checkbox"/> Yes <input type="checkbox"/> No			758	<input type="checkbox"/> Yes <input type="checkbox"/> No		
709	<input type="checkbox"/> Yes <input type="checkbox"/> No			759	<input type="checkbox"/> Yes <input type="checkbox"/> No		
710	<input type="checkbox"/> Yes <input type="checkbox"/> No			760	<input type="checkbox"/> Yes <input type="checkbox"/> No		
711	<input type="checkbox"/> Yes <input type="checkbox"/> No			761	<input type="checkbox"/> Yes <input type="checkbox"/> No		
712	<input type="checkbox"/> Yes <input type="checkbox"/> No			762	<input type="checkbox"/> Yes <input type="checkbox"/> No		
713	<input type="checkbox"/> Yes <input type="checkbox"/> No			763	<input type="checkbox"/> Yes <input type="checkbox"/> No		
714	<input type="checkbox"/> Yes <input type="checkbox"/> No			764	<input type="checkbox"/> Yes <input type="checkbox"/> No		
715	<input type="checkbox"/> Yes <input type="checkbox"/> No			765	<input type="checkbox"/> Yes <input type="checkbox"/> No		
716	<input type="checkbox"/> Yes <input type="checkbox"/> No			766	<input type="checkbox"/> Yes <input type="checkbox"/> No		
717	<input type="checkbox"/> Yes <input type="checkbox"/> No			767	<input type="checkbox"/> Yes <input type="checkbox"/> No		
718	<input type="checkbox"/> Yes <input type="checkbox"/> No			768	<input type="checkbox"/> Yes <input type="checkbox"/> No		
719	<input type="checkbox"/> Yes <input type="checkbox"/> No			769	<input type="checkbox"/> Yes <input type="checkbox"/> No		
720	<input type="checkbox"/> Yes <input type="checkbox"/> No			770	<input type="checkbox"/> Yes <input type="checkbox"/> No		
721	<input type="checkbox"/> Yes <input type="checkbox"/> No			771	<input type="checkbox"/> Yes <input type="checkbox"/> No		
722	<input type="checkbox"/> Yes <input type="checkbox"/> No			772	<input type="checkbox"/> Yes <input type="checkbox"/> No		
723	<input type="checkbox"/> Yes <input type="checkbox"/> No			773	<input type="checkbox"/> Yes <input type="checkbox"/> No		
724	<input type="checkbox"/> Yes <input type="checkbox"/> No			774	<input type="checkbox"/> Yes <input type="checkbox"/> No		
725	<input type="checkbox"/> Yes <input type="checkbox"/> No			775	<input type="checkbox"/> Yes <input type="checkbox"/> No		
726	<input type="checkbox"/> Yes <input type="checkbox"/> No			776	<input type="checkbox"/> Yes <input type="checkbox"/> No		
727	<input type="checkbox"/> Yes <input type="checkbox"/> No			777	<input type="checkbox"/> Yes <input type="checkbox"/> No		
728	<input type="checkbox"/> Yes <input type="checkbox"/> No			778	<input type="checkbox"/> Yes <input type="checkbox"/> No		
729	<input type="checkbox"/> Yes <input type="checkbox"/> No			779	<input type="checkbox"/> Yes <input type="checkbox"/> No		
730	<input type="checkbox"/> Yes <input type="checkbox"/> No			780	<input type="checkbox"/> Yes <input type="checkbox"/> No		
731	<input type="checkbox"/> Yes <input type="checkbox"/> No			781	<input type="checkbox"/> Yes <input type="checkbox"/> No		
732	<input type="checkbox"/> Yes <input type="checkbox"/> No			782	<input type="checkbox"/> Yes <input type="checkbox"/> No		
733	<input type="checkbox"/> Yes <input type="checkbox"/> No			783	<input type="checkbox"/> Yes <input type="checkbox"/> No		
734	<input type="checkbox"/> Yes <input type="checkbox"/> No			784	<input type="checkbox"/> Yes <input type="checkbox"/> No		
735	<input type="checkbox"/> Yes <input type="checkbox"/> No			785	<input type="checkbox"/> Yes <input type="checkbox"/> No		
736	<input type="checkbox"/> Yes <input type="checkbox"/> No			786	<input type="checkbox"/> Yes <input type="checkbox"/> No		
737	<input type="checkbox"/> Yes <input type="checkbox"/> No			787	<input type="checkbox"/> Yes <input type="checkbox"/> No		
738	<input type="checkbox"/> Yes <input type="checkbox"/> No			788	<input type="checkbox"/> Yes <input type="checkbox"/> No		
739	<input type="checkbox"/> Yes <input type="checkbox"/> No			789	<input type="checkbox"/> Yes <input type="checkbox"/> No		
740	<input type="checkbox"/> Yes <input type="checkbox"/> No			790	<input type="checkbox"/> Yes <input type="checkbox"/> No		
741	<input type="checkbox"/> Yes <input type="checkbox"/> No			791	<input type="checkbox"/> Yes <input type="checkbox"/> No		
742	<input type="checkbox"/> Yes <input type="checkbox"/> No			792	<input type="checkbox"/> Yes <input type="checkbox"/> No		
743	<input type="checkbox"/> Yes <input type="checkbox"/> No			793	<input type="checkbox"/> Yes <input type="checkbox"/> No		
744	<input type="checkbox"/> Yes <input type="checkbox"/> No			794	<input type="checkbox"/> Yes <input type="checkbox"/> No		
745	<input type="checkbox"/> Yes <input type="checkbox"/> No			795	<input type="checkbox"/> Yes <input type="checkbox"/> No		
746	<input type="checkbox"/> Yes <input type="checkbox"/> No			796	<input type="checkbox"/> Yes <input type="checkbox"/> No		
747	<input type="checkbox"/> Yes <input type="checkbox"/> No			797	<input type="checkbox"/> Yes <input type="checkbox"/> No		
748	<input type="checkbox"/> Yes <input type="checkbox"/> No			798	<input type="checkbox"/> Yes <input type="checkbox"/> No		
749	<input type="checkbox"/> Yes <input type="checkbox"/> No			799	<input type="checkbox"/> Yes <input type="checkbox"/> No		

TOLL RESTRICTION—AREA/OFFICE CODE TABLE (7/8)

Area/Office Code Table No. 7

Code No.	Local Call Access	Restriction Level	Office Code	Code No.	Local Call Access	Restriction Level	Office Code
800	<input type="checkbox"/> Yes, <input type="checkbox"/> No			850	<input type="checkbox"/> Yes, <input type="checkbox"/> No		
801	<input type="checkbox"/> Yes, <input type="checkbox"/> No			851	<input type="checkbox"/> Yes, <input type="checkbox"/> No		
802	<input type="checkbox"/> Yes, <input type="checkbox"/> No			852	<input type="checkbox"/> Yes, <input type="checkbox"/> No		
803	<input type="checkbox"/> Yes, <input type="checkbox"/> No			853	<input type="checkbox"/> Yes, <input type="checkbox"/> No		
804	<input type="checkbox"/> Yes, <input type="checkbox"/> No			854	<input type="checkbox"/> Yes, <input type="checkbox"/> No		
805	<input type="checkbox"/> Yes, <input type="checkbox"/> No			855	<input type="checkbox"/> Yes, <input type="checkbox"/> No		
806	<input type="checkbox"/> Yes, <input type="checkbox"/> No			856	<input type="checkbox"/> Yes, <input type="checkbox"/> No		
807	<input type="checkbox"/> Yes, <input type="checkbox"/> No			857	<input type="checkbox"/> Yes, <input type="checkbox"/> No		
808	<input type="checkbox"/> Yes, <input type="checkbox"/> No			858	<input type="checkbox"/> Yes, <input type="checkbox"/> No		
809	<input type="checkbox"/> Yes, <input type="checkbox"/> No			859	<input type="checkbox"/> Yes, <input type="checkbox"/> No		
810	<input type="checkbox"/> Yes, <input type="checkbox"/> No			860	<input type="checkbox"/> Yes, <input type="checkbox"/> No		
811	<input type="checkbox"/> Yes, <input type="checkbox"/> No			861	<input type="checkbox"/> Yes, <input type="checkbox"/> No		
812	<input type="checkbox"/> Yes, <input type="checkbox"/> No			862	<input type="checkbox"/> Yes, <input type="checkbox"/> No		
813	<input type="checkbox"/> Yes, <input type="checkbox"/> No			863	<input type="checkbox"/> Yes, <input type="checkbox"/> No		
814	<input type="checkbox"/> Yes, <input type="checkbox"/> No			864	<input type="checkbox"/> Yes, <input type="checkbox"/> No		
815	<input type="checkbox"/> Yes, <input type="checkbox"/> No			865	<input type="checkbox"/> Yes, <input type="checkbox"/> No		
816	<input type="checkbox"/> Yes, <input type="checkbox"/> No			866	<input type="checkbox"/> Yes, <input type="checkbox"/> No		
817	<input type="checkbox"/> Yes, <input type="checkbox"/> No			867	<input type="checkbox"/> Yes, <input type="checkbox"/> No		
818	<input type="checkbox"/> Yes, <input type="checkbox"/> No			868	<input type="checkbox"/> Yes, <input type="checkbox"/> No		
819	<input type="checkbox"/> Yes, <input type="checkbox"/> No			869	<input type="checkbox"/> Yes, <input type="checkbox"/> No		
820	<input type="checkbox"/> Yes, <input type="checkbox"/> No			870	<input type="checkbox"/> Yes, <input type="checkbox"/> No		
821	<input type="checkbox"/> Yes, <input type="checkbox"/> No			871	<input type="checkbox"/> Yes, <input type="checkbox"/> No		
822	<input type="checkbox"/> Yes, <input type="checkbox"/> No			872	<input type="checkbox"/> Yes, <input type="checkbox"/> No		
823	<input type="checkbox"/> Yes, <input type="checkbox"/> No			873	<input type="checkbox"/> Yes, <input type="checkbox"/> No		
824	<input type="checkbox"/> Yes, <input type="checkbox"/> No			874	<input type="checkbox"/> Yes, <input type="checkbox"/> No		
825	<input type="checkbox"/> Yes, <input type="checkbox"/> No			875	<input type="checkbox"/> Yes, <input type="checkbox"/> No		
826	<input type="checkbox"/> Yes, <input type="checkbox"/> No			876	<input type="checkbox"/> Yes, <input type="checkbox"/> No		
827	<input type="checkbox"/> Yes, <input type="checkbox"/> No			877	<input type="checkbox"/> Yes, <input type="checkbox"/> No		
828	<input type="checkbox"/> Yes, <input type="checkbox"/> No			878	<input type="checkbox"/> Yes, <input type="checkbox"/> No		
829	<input type="checkbox"/> Yes, <input type="checkbox"/> No			879	<input type="checkbox"/> Yes, <input type="checkbox"/> No		
830	<input type="checkbox"/> Yes, <input type="checkbox"/> No			880	<input type="checkbox"/> Yes, <input type="checkbox"/> No		
831	<input type="checkbox"/> Yes, <input type="checkbox"/> No			881	<input type="checkbox"/> Yes, <input type="checkbox"/> No		
832	<input type="checkbox"/> Yes, <input type="checkbox"/> No			882	<input type="checkbox"/> Yes, <input type="checkbox"/> No		
833	<input type="checkbox"/> Yes, <input type="checkbox"/> No			883	<input type="checkbox"/> Yes, <input type="checkbox"/> No		
834	<input type="checkbox"/> Yes, <input type="checkbox"/> No			884	<input type="checkbox"/> Yes, <input type="checkbox"/> No		
835	<input type="checkbox"/> Yes, <input type="checkbox"/> No			885	<input type="checkbox"/> Yes, <input type="checkbox"/> No		
836	<input type="checkbox"/> Yes, <input type="checkbox"/> No			886	<input type="checkbox"/> Yes, <input type="checkbox"/> No		
837	<input type="checkbox"/> Yes, <input type="checkbox"/> No			887	<input type="checkbox"/> Yes, <input type="checkbox"/> No		
838	<input type="checkbox"/> Yes, <input type="checkbox"/> No			888	<input type="checkbox"/> Yes, <input type="checkbox"/> No		
839	<input type="checkbox"/> Yes, <input type="checkbox"/> No			889	<input type="checkbox"/> Yes, <input type="checkbox"/> No		
840	<input type="checkbox"/> Yes, <input type="checkbox"/> No			890	<input type="checkbox"/> Yes, <input type="checkbox"/> No		
841	<input type="checkbox"/> Yes, <input type="checkbox"/> No			891	<input type="checkbox"/> Yes, <input type="checkbox"/> No		
842	<input type="checkbox"/> Yes, <input type="checkbox"/> No			892	<input type="checkbox"/> Yes, <input type="checkbox"/> No		
843	<input type="checkbox"/> Yes, <input type="checkbox"/> No			893	<input type="checkbox"/> Yes, <input type="checkbox"/> No		
844	<input type="checkbox"/> Yes, <input type="checkbox"/> No			894	<input type="checkbox"/> Yes, <input type="checkbox"/> No		
845	<input type="checkbox"/> Yes, <input type="checkbox"/> No			895	<input type="checkbox"/> Yes, <input type="checkbox"/> No		
846	<input type="checkbox"/> Yes, <input type="checkbox"/> No			896	<input type="checkbox"/> Yes, <input type="checkbox"/> No		
847	<input type="checkbox"/> Yes, <input type="checkbox"/> No			897	<input type="checkbox"/> Yes, <input type="checkbox"/> No		
848	<input type="checkbox"/> Yes, <input type="checkbox"/> No			898	<input type="checkbox"/> Yes, <input type="checkbox"/> No		
849	<input type="checkbox"/> Yes, <input type="checkbox"/> No			899	<input type="checkbox"/> Yes, <input type="checkbox"/> No		

TOLL RESTRICTION—AREA/OFFICE CODE TABLE (8/8)

Area/Office Code Table No. 7

Code No.	Local Call Access	Restriction Level	Office Code	Code No.	Local Call Access	Restriction Level	Office Code
900	<input type="checkbox"/> Yes, <input type="checkbox"/> No			950	<input type="checkbox"/> Yes, <input type="checkbox"/> No		
901	<input type="checkbox"/> Yes, <input type="checkbox"/> No			951	<input type="checkbox"/> Yes, <input type="checkbox"/> No		
902	<input type="checkbox"/> Yes, <input type="checkbox"/> No			952	<input type="checkbox"/> Yes, <input type="checkbox"/> No		
903	<input type="checkbox"/> Yes, <input type="checkbox"/> No			953	<input type="checkbox"/> Yes, <input type="checkbox"/> No		
904	<input type="checkbox"/> Yes, <input type="checkbox"/> No			954	<input type="checkbox"/> Yes, <input type="checkbox"/> No		
905	<input type="checkbox"/> Yes, <input type="checkbox"/> No			955	<input type="checkbox"/> Yes, <input type="checkbox"/> No		
906	<input type="checkbox"/> Yes, <input type="checkbox"/> No			956	<input type="checkbox"/> Yes, <input type="checkbox"/> No		
907	<input type="checkbox"/> Yes, <input type="checkbox"/> No			957	<input type="checkbox"/> Yes, <input type="checkbox"/> No		
908	<input type="checkbox"/> Yes, <input type="checkbox"/> No			958	<input type="checkbox"/> Yes, <input type="checkbox"/> No		
909	<input type="checkbox"/> Yes, <input type="checkbox"/> No			959	<input type="checkbox"/> Yes, <input type="checkbox"/> No		
910	<input type="checkbox"/> Yes, <input type="checkbox"/> No			960	<input type="checkbox"/> Yes, <input type="checkbox"/> No		
911	<input type="checkbox"/> Yes, <input type="checkbox"/> No			961	<input type="checkbox"/> Yes, <input type="checkbox"/> No		
912	<input type="checkbox"/> Yes, <input type="checkbox"/> No			962	<input type="checkbox"/> Yes, <input type="checkbox"/> No		
913	<input type="checkbox"/> Yes, <input type="checkbox"/> No			963	<input type="checkbox"/> Yes, <input type="checkbox"/> No		
914	<input type="checkbox"/> Yes, <input type="checkbox"/> No			964	<input type="checkbox"/> Yes, <input type="checkbox"/> No		
915	<input type="checkbox"/> Yes, <input type="checkbox"/> No			965	<input type="checkbox"/> Yes, <input type="checkbox"/> No		
916	<input type="checkbox"/> Yes, <input type="checkbox"/> No			966	<input type="checkbox"/> Yes, <input type="checkbox"/> No		
917	<input type="checkbox"/> Yes, <input type="checkbox"/> No			967	<input type="checkbox"/> Yes, <input type="checkbox"/> No		
918	<input type="checkbox"/> Yes, <input type="checkbox"/> No			968	<input type="checkbox"/> Yes, <input type="checkbox"/> No		
919	<input type="checkbox"/> Yes, <input type="checkbox"/> No			969	<input type="checkbox"/> Yes, <input type="checkbox"/> No		
920	<input type="checkbox"/> Yes, <input type="checkbox"/> No			970	<input type="checkbox"/> Yes, <input type="checkbox"/> No		
921	<input type="checkbox"/> Yes, <input type="checkbox"/> No			971	<input type="checkbox"/> Yes, <input type="checkbox"/> No		
922	<input type="checkbox"/> Yes, <input type="checkbox"/> No			972	<input type="checkbox"/> Yes, <input type="checkbox"/> No		
923	<input type="checkbox"/> Yes, <input type="checkbox"/> No			973	<input type="checkbox"/> Yes, <input type="checkbox"/> No		
924	<input type="checkbox"/> Yes, <input type="checkbox"/> No			974	<input type="checkbox"/> Yes, <input type="checkbox"/> No		
925	<input type="checkbox"/> Yes, <input type="checkbox"/> No			975	<input type="checkbox"/> Yes, <input type="checkbox"/> No		
926	<input type="checkbox"/> Yes, <input type="checkbox"/> No			976	<input type="checkbox"/> Yes, <input type="checkbox"/> No		
927	<input type="checkbox"/> Yes, <input type="checkbox"/> No			977	<input type="checkbox"/> Yes, <input type="checkbox"/> No		
928	<input type="checkbox"/> Yes, <input type="checkbox"/> No			978	<input type="checkbox"/> Yes, <input type="checkbox"/> No		
929	<input type="checkbox"/> Yes, <input type="checkbox"/> No			979	<input type="checkbox"/> Yes, <input type="checkbox"/> No		
930	<input type="checkbox"/> Yes, <input type="checkbox"/> No			980	<input type="checkbox"/> Yes, <input type="checkbox"/> No		
931	<input type="checkbox"/> Yes, <input type="checkbox"/> No			981	<input type="checkbox"/> Yes, <input type="checkbox"/> No		
932	<input type="checkbox"/> Yes, <input type="checkbox"/> No			982	<input type="checkbox"/> Yes, <input type="checkbox"/> No		
933	<input type="checkbox"/> Yes, <input type="checkbox"/> No			983	<input type="checkbox"/> Yes, <input type="checkbox"/> No		
934	<input type="checkbox"/> Yes, <input type="checkbox"/> No			984	<input type="checkbox"/> Yes, <input type="checkbox"/> No		
935	<input type="checkbox"/> Yes, <input type="checkbox"/> No			985	<input type="checkbox"/> Yes, <input type="checkbox"/> No		
936	<input type="checkbox"/> Yes, <input type="checkbox"/> No			986	<input type="checkbox"/> Yes, <input type="checkbox"/> No		
937	<input type="checkbox"/> Yes, <input type="checkbox"/> No			987	<input type="checkbox"/> Yes, <input type="checkbox"/> No		
938	<input type="checkbox"/> Yes, <input type="checkbox"/> No			988	<input type="checkbox"/> Yes, <input type="checkbox"/> No		
939	<input type="checkbox"/> Yes, <input type="checkbox"/> No			989	<input type="checkbox"/> Yes, <input type="checkbox"/> No		
940	<input type="checkbox"/> Yes, <input type="checkbox"/> No			990	<input type="checkbox"/> Yes, <input type="checkbox"/> No		
941	<input type="checkbox"/> Yes, <input type="checkbox"/> No			991	<input type="checkbox"/> Yes, <input type="checkbox"/> No		
942	<input type="checkbox"/> Yes, <input type="checkbox"/> No			992	<input type="checkbox"/> Yes, <input type="checkbox"/> No		
943	<input type="checkbox"/> Yes, <input type="checkbox"/> No			993	<input type="checkbox"/> Yes, <input type="checkbox"/> No		
944	<input type="checkbox"/> Yes, <input type="checkbox"/> No			994	<input type="checkbox"/> Yes, <input type="checkbox"/> No		
945	<input type="checkbox"/> Yes, <input type="checkbox"/> No			995	<input type="checkbox"/> Yes, <input type="checkbox"/> No		
946	<input type="checkbox"/> Yes, <input type="checkbox"/> No			996	<input type="checkbox"/> Yes, <input type="checkbox"/> No		
947	<input type="checkbox"/> Yes, <input type="checkbox"/> No			997	<input type="checkbox"/> Yes, <input type="checkbox"/> No		
948	<input type="checkbox"/> Yes, <input type="checkbox"/> No			998	<input type="checkbox"/> Yes, <input type="checkbox"/> No		
949	<input type="checkbox"/> Yes, <input type="checkbox"/> No			999	<input type="checkbox"/> Yes, <input type="checkbox"/> No		

TOLL RESTRICTION-AREA/OFFICE CODE TABLE (1/8)

Area/Office Code Table No. 8

Code No.	Local Call Access	Restriction Level	Office Code	Code No.	Local Call Access	Restriction Level	Office Code
200	<input type="checkbox"/> Yes, <input type="checkbox"/> No			250	<input type="checkbox"/> Yes, <input type="checkbox"/> No		
201	<input type="checkbox"/> Yes, <input type="checkbox"/> No			251	<input type="checkbox"/> Yes, <input type="checkbox"/> No		
202	<input type="checkbox"/> Yes, <input type="checkbox"/> No			252	<input type="checkbox"/> Yes, <input type="checkbox"/> No		
203	<input type="checkbox"/> Yes, <input type="checkbox"/> No			253	<input type="checkbox"/> Yes, <input type="checkbox"/> No		
204	<input type="checkbox"/> Yes, <input type="checkbox"/> No			254	<input type="checkbox"/> Yes, <input type="checkbox"/> No		
205	<input type="checkbox"/> Yes, <input type="checkbox"/> No			255	<input type="checkbox"/> Yes, <input type="checkbox"/> No		
206	<input type="checkbox"/> Yes, <input type="checkbox"/> No			256	<input type="checkbox"/> Yes, <input type="checkbox"/> No		
207	<input type="checkbox"/> Yes, <input type="checkbox"/> No			257	<input type="checkbox"/> Yes, <input type="checkbox"/> No		
208	<input type="checkbox"/> Yes, <input type="checkbox"/> No			258	<input type="checkbox"/> Yes, <input type="checkbox"/> No		
209	<input type="checkbox"/> Yes, <input type="checkbox"/> No			259	<input type="checkbox"/> Yes, <input type="checkbox"/> No		
210	<input type="checkbox"/> Yes, <input type="checkbox"/> No			260	<input type="checkbox"/> Yes, <input type="checkbox"/> No		
211	<input type="checkbox"/> Yes, <input type="checkbox"/> No			261	<input type="checkbox"/> Yes, <input type="checkbox"/> No		
212	<input type="checkbox"/> Yes, <input type="checkbox"/> No			262	<input type="checkbox"/> Yes, <input type="checkbox"/> No		
213	<input type="checkbox"/> Yes, <input type="checkbox"/> No			263	<input type="checkbox"/> Yes, <input type="checkbox"/> No		
214	<input type="checkbox"/> Yes, <input type="checkbox"/> No			264	<input type="checkbox"/> Yes, <input type="checkbox"/> No		
215	<input type="checkbox"/> Yes, <input type="checkbox"/> No			265	<input type="checkbox"/> Yes, <input type="checkbox"/> No		
216	<input type="checkbox"/> Yes, <input type="checkbox"/> No			266	<input type="checkbox"/> Yes, <input type="checkbox"/> No		
217	<input type="checkbox"/> Yes, <input type="checkbox"/> No			267	<input type="checkbox"/> Yes, <input type="checkbox"/> No		
218	<input type="checkbox"/> Yes, <input type="checkbox"/> No			268	<input type="checkbox"/> Yes, <input type="checkbox"/> No		
219	<input type="checkbox"/> Yes, <input type="checkbox"/> No			269	<input type="checkbox"/> Yes, <input type="checkbox"/> No		
220	<input type="checkbox"/> Yes, <input type="checkbox"/> No			270	<input type="checkbox"/> Yes, <input type="checkbox"/> No		
221	<input type="checkbox"/> Yes, <input type="checkbox"/> No			271	<input type="checkbox"/> Yes, <input type="checkbox"/> No		
222	<input type="checkbox"/> Yes, <input type="checkbox"/> No			272	<input type="checkbox"/> Yes, <input type="checkbox"/> No		
223	<input type="checkbox"/> Yes, <input type="checkbox"/> No			273	<input type="checkbox"/> Yes, <input type="checkbox"/> No		
224	<input type="checkbox"/> Yes, <input type="checkbox"/> No			274	<input type="checkbox"/> Yes, <input type="checkbox"/> No		
225	<input type="checkbox"/> Yes, <input type="checkbox"/> No			275	<input type="checkbox"/> Yes, <input type="checkbox"/> No		
226	<input type="checkbox"/> Yes, <input type="checkbox"/> No			276	<input type="checkbox"/> Yes, <input type="checkbox"/> No		
227	<input type="checkbox"/> Yes, <input type="checkbox"/> No			277	<input type="checkbox"/> Yes, <input type="checkbox"/> No		
228	<input type="checkbox"/> Yes, <input type="checkbox"/> No			278	<input type="checkbox"/> Yes, <input type="checkbox"/> No		
229	<input type="checkbox"/> Yes, <input type="checkbox"/> No			279	<input type="checkbox"/> Yes, <input type="checkbox"/> No		
230	<input type="checkbox"/> Yes, <input type="checkbox"/> No			280	<input type="checkbox"/> Yes, <input type="checkbox"/> No		
231	<input type="checkbox"/> Yes, <input type="checkbox"/> No			281	<input type="checkbox"/> Yes, <input type="checkbox"/> No		
232	<input type="checkbox"/> Yes, <input type="checkbox"/> No			282	<input type="checkbox"/> Yes, <input type="checkbox"/> No		
233	<input type="checkbox"/> Yes, <input type="checkbox"/> No			283	<input type="checkbox"/> Yes, <input type="checkbox"/> No		
234	<input type="checkbox"/> Yes, <input type="checkbox"/> No			284	<input type="checkbox"/> Yes, <input type="checkbox"/> No		
235	<input type="checkbox"/> Yes, <input type="checkbox"/> No			285	<input type="checkbox"/> Yes, <input type="checkbox"/> No		
236	<input type="checkbox"/> Yes, <input type="checkbox"/> No			286	<input type="checkbox"/> Yes, <input type="checkbox"/> No		
237	<input type="checkbox"/> Yes, <input type="checkbox"/> No			287	<input type="checkbox"/> Yes, <input type="checkbox"/> No		
238	<input type="checkbox"/> Yes, <input type="checkbox"/> No			288	<input type="checkbox"/> Yes, <input type="checkbox"/> No		
239	<input type="checkbox"/> Yes, <input type="checkbox"/> No			289	<input type="checkbox"/> Yes, <input type="checkbox"/> No		
240	<input type="checkbox"/> Yes, <input type="checkbox"/> No			290	<input type="checkbox"/> Yes, <input type="checkbox"/> No		
241	<input type="checkbox"/> Yes, <input type="checkbox"/> No			291	<input type="checkbox"/> Yes, <input type="checkbox"/> No		
242	<input type="checkbox"/> Yes, <input type="checkbox"/> No			292	<input type="checkbox"/> Yes, <input type="checkbox"/> No		
243	<input type="checkbox"/> Yes, <input type="checkbox"/> No			293	<input type="checkbox"/> Yes, <input type="checkbox"/> No		
244	<input type="checkbox"/> Yes, <input type="checkbox"/> No			294	<input type="checkbox"/> Yes, <input type="checkbox"/> No		
245	<input type="checkbox"/> Yes, <input type="checkbox"/> No			295	<input type="checkbox"/> Yes, <input type="checkbox"/> No		
246	<input type="checkbox"/> Yes, <input type="checkbox"/> No			296	<input type="checkbox"/> Yes, <input type="checkbox"/> No		
247	<input type="checkbox"/> Yes, <input type="checkbox"/> No			297	<input type="checkbox"/> Yes, <input type="checkbox"/> No		
248	<input type="checkbox"/> Yes, <input type="checkbox"/> No			298	<input type="checkbox"/> Yes, <input type="checkbox"/> No		
249	<input type="checkbox"/> Yes, <input type="checkbox"/> No			299	<input type="checkbox"/> Yes, <input type="checkbox"/> No		

TOLL RESTRICTION-AREA/OFFICE CODE TABLE (2/8)

Area/Office Code Table No. 8

Code No.	Local Call Access	Restriction Level	Office Code	Code No.	Local Call Access	Restriction Level	Office Code
300	<input type="checkbox"/> Yes, <input type="checkbox"/> No			350	<input type="checkbox"/> Yes, <input type="checkbox"/> No		
301	<input type="checkbox"/> Yes, <input type="checkbox"/> No			351	<input type="checkbox"/> Yes, <input type="checkbox"/> No		
302	<input type="checkbox"/> Yes, <input type="checkbox"/> No			352	<input type="checkbox"/> Yes, <input type="checkbox"/> No		
303	<input type="checkbox"/> Yes, <input type="checkbox"/> No			353	<input type="checkbox"/> Yes, <input type="checkbox"/> No		
304	<input type="checkbox"/> Yes, <input type="checkbox"/> No			354	<input type="checkbox"/> Yes, <input type="checkbox"/> No		
305	<input type="checkbox"/> Yes, <input type="checkbox"/> No			355	<input type="checkbox"/> Yes, <input type="checkbox"/> No		
306	<input type="checkbox"/> Yes, <input type="checkbox"/> No			356	<input type="checkbox"/> Yes, <input type="checkbox"/> No		
307	<input type="checkbox"/> Yes, <input type="checkbox"/> No			357	<input type="checkbox"/> Yes, <input type="checkbox"/> No		
308	<input type="checkbox"/> Yes, <input type="checkbox"/> No			358	<input type="checkbox"/> Yes, <input type="checkbox"/> No		
309	<input type="checkbox"/> Yes, <input type="checkbox"/> No			359	<input type="checkbox"/> Yes, <input type="checkbox"/> No		
310	<input type="checkbox"/> Yes, <input type="checkbox"/> No			360	<input type="checkbox"/> Yes, <input type="checkbox"/> No		
311	<input type="checkbox"/> Yes, <input type="checkbox"/> No			361	<input type="checkbox"/> Yes, <input type="checkbox"/> No		
312	<input type="checkbox"/> Yes, <input type="checkbox"/> No			362	<input type="checkbox"/> Yes, <input type="checkbox"/> No		
313	<input type="checkbox"/> Yes, <input type="checkbox"/> No			363	<input type="checkbox"/> Yes, <input type="checkbox"/> No		
314	<input type="checkbox"/> Yes, <input type="checkbox"/> No			364	<input type="checkbox"/> Yes, <input type="checkbox"/> No		
315	<input type="checkbox"/> Yes, <input type="checkbox"/> No			365	<input type="checkbox"/> Yes, <input type="checkbox"/> No		
316	<input type="checkbox"/> Yes, <input type="checkbox"/> No			366	<input type="checkbox"/> Yes, <input type="checkbox"/> No		
317	<input type="checkbox"/> Yes, <input type="checkbox"/> No			367	<input type="checkbox"/> Yes, <input type="checkbox"/> No		
318	<input type="checkbox"/> Yes, <input type="checkbox"/> No			368	<input type="checkbox"/> Yes, <input type="checkbox"/> No		
319	<input type="checkbox"/> Yes, <input type="checkbox"/> No			369	<input type="checkbox"/> Yes, <input type="checkbox"/> No		
320	<input type="checkbox"/> Yes, <input type="checkbox"/> No			370	<input type="checkbox"/> Yes, <input type="checkbox"/> No		
321	<input type="checkbox"/> Yes, <input type="checkbox"/> No			371	<input type="checkbox"/> Yes, <input type="checkbox"/> No		
322	<input type="checkbox"/> Yes, <input type="checkbox"/> No			372	<input type="checkbox"/> Yes, <input type="checkbox"/> No		
323	<input type="checkbox"/> Yes, <input type="checkbox"/> No			373	<input type="checkbox"/> Yes, <input type="checkbox"/> No		
324	<input type="checkbox"/> Yes, <input type="checkbox"/> No			374	<input type="checkbox"/> Yes, <input type="checkbox"/> No		
325	<input type="checkbox"/> Yes, <input type="checkbox"/> No			375	<input type="checkbox"/> Yes, <input type="checkbox"/> No		
326	<input type="checkbox"/> Yes, <input type="checkbox"/> No			376	<input type="checkbox"/> Yes, <input type="checkbox"/> No		
327	<input type="checkbox"/> Yes, <input type="checkbox"/> No			377	<input type="checkbox"/> Yes, <input type="checkbox"/> No		
328	<input type="checkbox"/> Yes, <input type="checkbox"/> No			378	<input type="checkbox"/> Yes, <input type="checkbox"/> No		
329	<input type="checkbox"/> Yes, <input type="checkbox"/> No			379	<input type="checkbox"/> Yes, <input type="checkbox"/> No		
330	<input type="checkbox"/> Yes, <input type="checkbox"/> No			380	<input type="checkbox"/> Yes, <input type="checkbox"/> No		
331	<input type="checkbox"/> Yes, <input type="checkbox"/> No			381	<input type="checkbox"/> Yes, <input type="checkbox"/> No		
332	<input type="checkbox"/> Yes, <input type="checkbox"/> No			382	<input type="checkbox"/> Yes, <input type="checkbox"/> No		
333	<input type="checkbox"/> Yes, <input type="checkbox"/> No			383	<input type="checkbox"/> Yes, <input type="checkbox"/> No		
334	<input type="checkbox"/> Yes, <input type="checkbox"/> No			384	<input type="checkbox"/> Yes, <input type="checkbox"/> No		
335	<input type="checkbox"/> Yes, <input type="checkbox"/> No			385	<input type="checkbox"/> Yes, <input type="checkbox"/> No		
336	<input type="checkbox"/> Yes, <input type="checkbox"/> No			386	<input type="checkbox"/> Yes, <input type="checkbox"/> No		
337	<input type="checkbox"/> Yes, <input type="checkbox"/> No			387	<input type="checkbox"/> Yes, <input type="checkbox"/> No		
338	<input type="checkbox"/> Yes, <input type="checkbox"/> No			388	<input type="checkbox"/> Yes, <input type="checkbox"/> No		
339	<input type="checkbox"/> Yes, <input type="checkbox"/> No			389	<input type="checkbox"/> Yes, <input type="checkbox"/> No		
340	<input type="checkbox"/> Yes, <input type="checkbox"/> No			390	<input type="checkbox"/> Yes, <input type="checkbox"/> No		
341	<input type="checkbox"/> Yes, <input type="checkbox"/> No			391	<input type="checkbox"/> Yes, <input type="checkbox"/> No		
342	<input type="checkbox"/> Yes, <input type="checkbox"/> No			392	<input type="checkbox"/> Yes, <input type="checkbox"/> No		
343	<input type="checkbox"/> Yes, <input type="checkbox"/> No			393	<input type="checkbox"/> Yes, <input type="checkbox"/> No		
344	<input type="checkbox"/> Yes, <input type="checkbox"/> No			394	<input type="checkbox"/> Yes, <input type="checkbox"/> No		
345	<input type="checkbox"/> Yes, <input type="checkbox"/> No			395	<input type="checkbox"/> Yes, <input type="checkbox"/> No		
346	<input type="checkbox"/> Yes, <input type="checkbox"/> No			396	<input type="checkbox"/> Yes, <input type="checkbox"/> No		
347	<input type="checkbox"/> Yes, <input type="checkbox"/> No			397	<input type="checkbox"/> Yes, <input type="checkbox"/> No		
348	<input type="checkbox"/> Yes, <input type="checkbox"/> No			398	<input type="checkbox"/> Yes, <input type="checkbox"/> No		
349	<input type="checkbox"/> Yes, <input type="checkbox"/> No			399	<input type="checkbox"/> Yes, <input type="checkbox"/> No		

TOLL RESTRICTION—AREA/OFFICE CODE TABLE (3/8)

Area/Office Code Table No. 8

Code No.	Local Call Access	Restriction Level	Office Code	Code No.	Local Call Access	Restriction Level	Office Code
400	<input type="checkbox"/> Yes, <input type="checkbox"/> No			450	<input type="checkbox"/> Yes, <input type="checkbox"/> No		
401	<input type="checkbox"/> Yes, <input type="checkbox"/> No			451	<input type="checkbox"/> Yes, <input type="checkbox"/> No		
402	<input type="checkbox"/> Yes, <input type="checkbox"/> No			452	<input type="checkbox"/> Yes, <input type="checkbox"/> No		
403	<input type="checkbox"/> Yes, <input type="checkbox"/> No			453	<input type="checkbox"/> Yes, <input type="checkbox"/> No		
404	<input type="checkbox"/> Yes, <input type="checkbox"/> No			454	<input type="checkbox"/> Yes, <input type="checkbox"/> No		
405	<input type="checkbox"/> Yes, <input type="checkbox"/> No			455	<input type="checkbox"/> Yes, <input type="checkbox"/> No		
406	<input type="checkbox"/> Yes, <input type="checkbox"/> No			456	<input type="checkbox"/> Yes, <input type="checkbox"/> No		
407	<input type="checkbox"/> Yes, <input type="checkbox"/> No			457	<input type="checkbox"/> Yes, <input type="checkbox"/> No		
408	<input type="checkbox"/> Yes, <input type="checkbox"/> No			458	<input type="checkbox"/> Yes, <input type="checkbox"/> No		
409	<input type="checkbox"/> Yes, <input type="checkbox"/> No			459	<input type="checkbox"/> Yes, <input type="checkbox"/> No		
410	<input type="checkbox"/> Yes, <input type="checkbox"/> No			460	<input type="checkbox"/> Yes, <input type="checkbox"/> No		
411	<input type="checkbox"/> Yes, <input type="checkbox"/> No			461	<input type="checkbox"/> Yes, <input type="checkbox"/> No		
412	<input type="checkbox"/> Yes, <input type="checkbox"/> No			462	<input type="checkbox"/> Yes, <input type="checkbox"/> No		
413	<input type="checkbox"/> Yes, <input type="checkbox"/> No			463	<input type="checkbox"/> Yes, <input type="checkbox"/> No		
414	<input type="checkbox"/> Yes, <input type="checkbox"/> No			464	<input type="checkbox"/> Yes, <input type="checkbox"/> No		
415	<input type="checkbox"/> Yes, <input type="checkbox"/> No			465	<input type="checkbox"/> Yes, <input type="checkbox"/> No		
416	<input type="checkbox"/> Yes, <input type="checkbox"/> No			466	<input type="checkbox"/> Yes, <input type="checkbox"/> No		
417	<input type="checkbox"/> Yes, <input type="checkbox"/> No			467	<input type="checkbox"/> Yes, <input type="checkbox"/> No		
418	<input type="checkbox"/> Yes, <input type="checkbox"/> No			468	<input type="checkbox"/> Yes, <input type="checkbox"/> No		
419	<input type="checkbox"/> Yes, <input type="checkbox"/> No			469	<input type="checkbox"/> Yes, <input type="checkbox"/> No		
420	<input type="checkbox"/> Yes, <input type="checkbox"/> No			470	<input type="checkbox"/> Yes, <input type="checkbox"/> No		
421	<input type="checkbox"/> Yes, <input type="checkbox"/> No			471	<input type="checkbox"/> Yes, <input type="checkbox"/> No		
422	<input type="checkbox"/> Yes, <input type="checkbox"/> No			472	<input type="checkbox"/> Yes, <input type="checkbox"/> No		
423	<input type="checkbox"/> Yes, <input type="checkbox"/> No			473	<input type="checkbox"/> Yes, <input type="checkbox"/> No		
424	<input type="checkbox"/> Yes, <input type="checkbox"/> No			474	<input type="checkbox"/> Yes, <input type="checkbox"/> No		
425	<input type="checkbox"/> Yes, <input type="checkbox"/> No			475	<input type="checkbox"/> Yes, <input type="checkbox"/> No		
426	<input type="checkbox"/> Yes, <input type="checkbox"/> No			476	<input type="checkbox"/> Yes, <input type="checkbox"/> No		
427	<input type="checkbox"/> Yes, <input type="checkbox"/> No			477	<input type="checkbox"/> Yes, <input type="checkbox"/> No		
428	<input type="checkbox"/> Yes, <input type="checkbox"/> No			478	<input type="checkbox"/> Yes, <input type="checkbox"/> No		
429	<input type="checkbox"/> Yes, <input type="checkbox"/> No			479	<input type="checkbox"/> Yes, <input type="checkbox"/> No		
430	<input type="checkbox"/> Yes, <input type="checkbox"/> No			480	<input type="checkbox"/> Yes, <input type="checkbox"/> No		
431	<input type="checkbox"/> Yes, <input type="checkbox"/> No			481	<input type="checkbox"/> Yes, <input type="checkbox"/> No		
432	<input type="checkbox"/> Yes, <input type="checkbox"/> No			482	<input type="checkbox"/> Yes, <input type="checkbox"/> No		
433	<input type="checkbox"/> Yes, <input type="checkbox"/> No			483	<input type="checkbox"/> Yes, <input type="checkbox"/> No		
434	<input type="checkbox"/> Yes, <input type="checkbox"/> No			484	<input type="checkbox"/> Yes, <input type="checkbox"/> No		
435	<input type="checkbox"/> Yes, <input type="checkbox"/> No			485	<input type="checkbox"/> Yes, <input type="checkbox"/> No		
436	<input type="checkbox"/> Yes, <input type="checkbox"/> No			486	<input type="checkbox"/> Yes, <input type="checkbox"/> No		
437	<input type="checkbox"/> Yes, <input type="checkbox"/> No			487	<input type="checkbox"/> Yes, <input type="checkbox"/> No		
438	<input type="checkbox"/> Yes, <input type="checkbox"/> No			488	<input type="checkbox"/> Yes, <input type="checkbox"/> No		
439	<input type="checkbox"/> Yes, <input type="checkbox"/> No			489	<input type="checkbox"/> Yes, <input type="checkbox"/> No		
440	<input type="checkbox"/> Yes, <input type="checkbox"/> No			490	<input type="checkbox"/> Yes, <input type="checkbox"/> No		
441	<input type="checkbox"/> Yes, <input type="checkbox"/> No			491	<input type="checkbox"/> Yes, <input type="checkbox"/> No		
442	<input type="checkbox"/> Yes, <input type="checkbox"/> No			492	<input type="checkbox"/> Yes, <input type="checkbox"/> No		
443	<input type="checkbox"/> Yes, <input type="checkbox"/> No			493	<input type="checkbox"/> Yes, <input type="checkbox"/> No		
444	<input type="checkbox"/> Yes, <input type="checkbox"/> No			494	<input type="checkbox"/> Yes, <input type="checkbox"/> No		
445	<input type="checkbox"/> Yes, <input type="checkbox"/> No			495	<input type="checkbox"/> Yes, <input type="checkbox"/> No		
446	<input type="checkbox"/> Yes, <input type="checkbox"/> No			496	<input type="checkbox"/> Yes, <input type="checkbox"/> No		
447	<input type="checkbox"/> Yes, <input type="checkbox"/> No			497	<input type="checkbox"/> Yes, <input type="checkbox"/> No		
448	<input type="checkbox"/> Yes, <input type="checkbox"/> No			498	<input type="checkbox"/> Yes, <input type="checkbox"/> No		
449	<input type="checkbox"/> Yes, <input type="checkbox"/> No			499	<input type="checkbox"/> Yes, <input type="checkbox"/> No		

TOLL RESTRICTION-AREA/OFFICE CODE TABLE (418)

Area/Office Code Table No. 8

Code No.	Local Call Access	Restriction Level	Office Code	Code No.	Local Call Access	Restriction Level	Office Code
500	<input type="checkbox"/> Yes, <input type="checkbox"/> No			550	<input type="checkbox"/> Yes, <input type="checkbox"/> No		
501	<input type="checkbox"/> Yes, <input type="checkbox"/> No			551	<input type="checkbox"/> Yes, <input type="checkbox"/> No		
502	<input type="checkbox"/> Yes, <input type="checkbox"/> No			552	<input type="checkbox"/> Yes, <input type="checkbox"/> No		
503	<input type="checkbox"/> Yes, <input type="checkbox"/> No			553	<input type="checkbox"/> Yes, <input type="checkbox"/> No		
504	<input type="checkbox"/> Yes, <input type="checkbox"/> No			554	<input type="checkbox"/> Yes, <input type="checkbox"/> No		
505	<input type="checkbox"/> Yes, <input type="checkbox"/> No			555	<input type="checkbox"/> Yes, <input type="checkbox"/> No		
506	<input type="checkbox"/> Yes, <input type="checkbox"/> No			556	<input type="checkbox"/> Yes, <input type="checkbox"/> No		
507	<input type="checkbox"/> Yes, <input type="checkbox"/> No			557	<input type="checkbox"/> Yes, <input type="checkbox"/> No		
508	<input type="checkbox"/> Yes, <input type="checkbox"/> No			558	<input type="checkbox"/> Yes, <input type="checkbox"/> No		
509	<input type="checkbox"/> Yes, <input type="checkbox"/> No			559	<input type="checkbox"/> Yes, <input type="checkbox"/> No		
510	<input type="checkbox"/> Yes, <input type="checkbox"/> No			560	<input type="checkbox"/> Yes, <input type="checkbox"/> No		
511	<input type="checkbox"/> Yes, <input type="checkbox"/> No			561	<input type="checkbox"/> Yes, <input type="checkbox"/> No		
512	<input type="checkbox"/> Yes, <input type="checkbox"/> No			562	<input type="checkbox"/> Yes, <input type="checkbox"/> No		
513	<input type="checkbox"/> Yes, <input type="checkbox"/> No			563	<input type="checkbox"/> Yes, <input type="checkbox"/> No		
514	<input type="checkbox"/> Yes, <input type="checkbox"/> No			564	<input type="checkbox"/> Yes, <input type="checkbox"/> No		
515	<input type="checkbox"/> Yes, <input type="checkbox"/> No			565	<input type="checkbox"/> Yes, <input type="checkbox"/> No		
516	<input type="checkbox"/> Yes, <input type="checkbox"/> No			566	<input type="checkbox"/> Yes, <input type="checkbox"/> No		
517	<input type="checkbox"/> Yes, <input type="checkbox"/> No			567	<input type="checkbox"/> Yes, <input type="checkbox"/> No		
518	<input type="checkbox"/> Yes, <input type="checkbox"/> No			568	<input type="checkbox"/> Yes, <input type="checkbox"/> No		
519	<input type="checkbox"/> Yes, <input type="checkbox"/> No			569	<input type="checkbox"/> Yes, <input type="checkbox"/> No		
520	<input type="checkbox"/> Yes, <input type="checkbox"/> No			570	<input type="checkbox"/> Yes, <input type="checkbox"/> No		
521	<input type="checkbox"/> Yes, <input type="checkbox"/> No			571	<input type="checkbox"/> Yes, <input type="checkbox"/> No		
522	<input type="checkbox"/> Yes, <input type="checkbox"/> No			572	<input type="checkbox"/> Yes, <input type="checkbox"/> No		
523	<input type="checkbox"/> Yes, <input type="checkbox"/> No			573	<input type="checkbox"/> Yes, <input type="checkbox"/> No		
524	<input type="checkbox"/> Yes, <input type="checkbox"/> No			574	<input type="checkbox"/> Yes, <input type="checkbox"/> No		
525	<input type="checkbox"/> Yes, <input type="checkbox"/> No			575	<input type="checkbox"/> Yes, <input type="checkbox"/> No		
526	<input type="checkbox"/> Yes, <input type="checkbox"/> No			576	<input type="checkbox"/> Yes, <input type="checkbox"/> No		
527	<input type="checkbox"/> Yes, <input type="checkbox"/> No			577	<input type="checkbox"/> Yes, <input type="checkbox"/> No		
528	<input type="checkbox"/> Yes, <input type="checkbox"/> No			578	<input type="checkbox"/> Yes, <input type="checkbox"/> No		
529	<input type="checkbox"/> Yes, <input type="checkbox"/> No			579	<input type="checkbox"/> Yes, <input type="checkbox"/> No		
530	<input type="checkbox"/> Yes, <input type="checkbox"/> No			580	<input type="checkbox"/> Yes, <input type="checkbox"/> No		
531	<input type="checkbox"/> Yes, <input type="checkbox"/> No			581	<input type="checkbox"/> Yes, <input type="checkbox"/> No		
532	<input type="checkbox"/> Yes, <input type="checkbox"/> No			582	<input type="checkbox"/> Yes, <input type="checkbox"/> No		
533	<input type="checkbox"/> Yes, <input type="checkbox"/> No			583	<input type="checkbox"/> Yes, <input type="checkbox"/> No		
534	<input type="checkbox"/> Yes, <input type="checkbox"/> No			584	<input type="checkbox"/> Yes, <input type="checkbox"/> No		
535	<input type="checkbox"/> Yes, <input type="checkbox"/> No			585	<input type="checkbox"/> Yes, <input type="checkbox"/> No		
536	<input type="checkbox"/> Yes, <input type="checkbox"/> No			586	<input type="checkbox"/> Yes, <input type="checkbox"/> No		
537	<input type="checkbox"/> Yes, <input type="checkbox"/> No			587	<input type="checkbox"/> Yes, <input type="checkbox"/> No		
538	<input type="checkbox"/> Yes, <input type="checkbox"/> No			588	<input type="checkbox"/> Yes, <input type="checkbox"/> No		
539	<input type="checkbox"/> Yes, <input type="checkbox"/> No			589	<input type="checkbox"/> Yes, <input type="checkbox"/> No		
540	<input type="checkbox"/> Yes, <input type="checkbox"/> No			590	<input type="checkbox"/> Yes, <input type="checkbox"/> No		
541	<input type="checkbox"/> Yes, <input type="checkbox"/> No			591	<input type="checkbox"/> Yes, <input type="checkbox"/> No		
542	<input type="checkbox"/> Yes, <input type="checkbox"/> No			592	<input type="checkbox"/> Yes, <input type="checkbox"/> No		
543	<input type="checkbox"/> Yes, <input type="checkbox"/> No			593	<input type="checkbox"/> Yes, <input type="checkbox"/> No		
544	<input type="checkbox"/> Yes, <input type="checkbox"/> No			594	<input type="checkbox"/> Yes, <input type="checkbox"/> No		
545	<input type="checkbox"/> Yes, <input type="checkbox"/> No			595	<input type="checkbox"/> Yes, <input type="checkbox"/> No		
546	<input type="checkbox"/> Yes, <input type="checkbox"/> No			596	<input type="checkbox"/> Yes, <input type="checkbox"/> No		
547	<input type="checkbox"/> Yes, <input type="checkbox"/> No			597	<input type="checkbox"/> Yes, <input type="checkbox"/> No		
548	<input type="checkbox"/> Yes, <input type="checkbox"/> No			598	<input type="checkbox"/> Yes, <input type="checkbox"/> No		
549	<input type="checkbox"/> Yes, <input type="checkbox"/> No			599	<input type="checkbox"/> Yes, <input type="checkbox"/> No		

TOLL RESTRICTION—AREA/OFFICE CODE TABLE (5/8)

Area/Office Code Table No. 6

Code No.	Local Call Access	Restriction Level	Office Code	Code No.	Local Call Access	Restriction Level	Office Code
600	<input type="checkbox"/> Yes, <input type="checkbox"/> No			650	<input type="checkbox"/> Yes, <input type="checkbox"/> No		
601	<input type="checkbox"/> Yes, <input type="checkbox"/> No			651	<input type="checkbox"/> Yes, <input type="checkbox"/> No		
602	<input type="checkbox"/> Yes, <input type="checkbox"/> No			652	<input type="checkbox"/> Yes, <input type="checkbox"/> No		
603	<input type="checkbox"/> Yes, <input type="checkbox"/> No			653	<input type="checkbox"/> Yes, <input type="checkbox"/> No		
604	<input type="checkbox"/> Yes, <input type="checkbox"/> No			654	<input type="checkbox"/> Yes, <input type="checkbox"/> No		
605	<input type="checkbox"/> Yes, <input type="checkbox"/> No			655	<input type="checkbox"/> Yes, <input type="checkbox"/> No		
606	<input type="checkbox"/> Yes, <input type="checkbox"/> No			656	<input type="checkbox"/> Yes, <input type="checkbox"/> No		
607	<input type="checkbox"/> Yes, <input type="checkbox"/> No			657	<input type="checkbox"/> Yes, <input type="checkbox"/> No		
608	<input type="checkbox"/> Yes, <input type="checkbox"/> No			658	<input type="checkbox"/> Yes, <input type="checkbox"/> No		
609	<input type="checkbox"/> Yes, <input type="checkbox"/> No			659	<input type="checkbox"/> Yes, <input type="checkbox"/> No		
610	<input type="checkbox"/> Yes, <input type="checkbox"/> No			660	<input type="checkbox"/> Yes, <input type="checkbox"/> No		
611	<input type="checkbox"/> Yes, <input type="checkbox"/> No			661	<input type="checkbox"/> Yes, <input type="checkbox"/> No		
612	<input type="checkbox"/> Yes, <input type="checkbox"/> No			662	<input type="checkbox"/> Yes, <input type="checkbox"/> No		
613	<input type="checkbox"/> Yes, <input type="checkbox"/> No			663	<input type="checkbox"/> Yes, <input type="checkbox"/> No		
614	<input type="checkbox"/> Yes, <input type="checkbox"/> No			664	<input type="checkbox"/> Yes, <input type="checkbox"/> No		
615	<input type="checkbox"/> Yes, <input type="checkbox"/> No			665	<input type="checkbox"/> Yes, <input type="checkbox"/> No		
616	<input type="checkbox"/> Yes, <input type="checkbox"/> No			666	<input type="checkbox"/> Yes, <input type="checkbox"/> No		
617	<input type="checkbox"/> Yes, <input type="checkbox"/> No			667	<input type="checkbox"/> Yes, <input type="checkbox"/> No		
618	<input type="checkbox"/> Yes, <input type="checkbox"/> No			668	<input type="checkbox"/> Yes, <input type="checkbox"/> No		
619	<input type="checkbox"/> Yes, <input type="checkbox"/> No			669	<input type="checkbox"/> Yes, <input type="checkbox"/> No		
620	<input type="checkbox"/> Yes, <input type="checkbox"/> No			670	<input type="checkbox"/> Yes, <input type="checkbox"/> No		
621	<input type="checkbox"/> Yes, <input type="checkbox"/> No			671	<input type="checkbox"/> Yes, <input type="checkbox"/> No		
622	<input type="checkbox"/> Yes, <input type="checkbox"/> No			672	<input type="checkbox"/> Yes, <input type="checkbox"/> No		
623	<input type="checkbox"/> Yes, <input type="checkbox"/> No			673	<input type="checkbox"/> Yes, <input type="checkbox"/> No		
624	<input type="checkbox"/> Yes, <input type="checkbox"/> No			674	<input type="checkbox"/> Yes, <input type="checkbox"/> No		
625	<input type="checkbox"/> Yes, <input type="checkbox"/> No			675	<input type="checkbox"/> Yes, <input type="checkbox"/> No		
626	<input type="checkbox"/> Yes, <input type="checkbox"/> No			676	<input type="checkbox"/> Yes, <input type="checkbox"/> No		
627	<input type="checkbox"/> Yes, <input type="checkbox"/> No			677	<input type="checkbox"/> Yes, <input type="checkbox"/> No		
628	<input type="checkbox"/> Yes, <input type="checkbox"/> No			678	<input type="checkbox"/> Yes, <input type="checkbox"/> No		
629	<input type="checkbox"/> Yes, <input type="checkbox"/> No			679	<input type="checkbox"/> Yes, <input type="checkbox"/> No		
630	<input type="checkbox"/> Yes, <input type="checkbox"/> No			680	<input type="checkbox"/> Yes, <input type="checkbox"/> No		
631	<input type="checkbox"/> Yes, <input type="checkbox"/> No			681	<input type="checkbox"/> Yes, <input type="checkbox"/> No		
632	<input type="checkbox"/> Yes, <input type="checkbox"/> No			682	<input type="checkbox"/> Yes, <input type="checkbox"/> No		
633	<input type="checkbox"/> Yes, <input type="checkbox"/> No			683	<input type="checkbox"/> Yes, <input type="checkbox"/> No		
634	<input type="checkbox"/> Yes, <input type="checkbox"/> No			684	<input type="checkbox"/> Yes, <input type="checkbox"/> No		
635	<input type="checkbox"/> Yes, <input type="checkbox"/> No			685	<input type="checkbox"/> Yes, <input type="checkbox"/> No		
636	<input type="checkbox"/> Yes, <input type="checkbox"/> No			686	<input type="checkbox"/> Yes, <input type="checkbox"/> No		
637	<input type="checkbox"/> Yes, <input type="checkbox"/> No			687	<input type="checkbox"/> Yes, <input type="checkbox"/> No		
638	<input type="checkbox"/> Yes, <input type="checkbox"/> No			688	<input type="checkbox"/> Yes, <input type="checkbox"/> No		
639	<input type="checkbox"/> Yes, <input type="checkbox"/> No			689	<input type="checkbox"/> Yes, <input type="checkbox"/> No		
640	<input type="checkbox"/> Yes, <input type="checkbox"/> No			690	<input type="checkbox"/> Yes, <input type="checkbox"/> No		
641	<input type="checkbox"/> Yes, <input type="checkbox"/> No			691	<input type="checkbox"/> Yes, <input type="checkbox"/> No		
642	<input type="checkbox"/> Yes, <input type="checkbox"/> No			692	<input type="checkbox"/> Yes, <input type="checkbox"/> No		
643	<input type="checkbox"/> Yes, <input type="checkbox"/> No			693	<input type="checkbox"/> Yes, <input type="checkbox"/> No		
644	<input type="checkbox"/> Yes, <input type="checkbox"/> No			694	<input type="checkbox"/> Yes, <input type="checkbox"/> No		
645	<input type="checkbox"/> Yes, <input type="checkbox"/> No			695	<input type="checkbox"/> Yes, <input type="checkbox"/> No		
646	<input type="checkbox"/> Yes, <input type="checkbox"/> No			696	<input type="checkbox"/> Yes, <input type="checkbox"/> No		
647	<input type="checkbox"/> Yes, <input type="checkbox"/> No			697	<input type="checkbox"/> Yes, <input type="checkbox"/> No		
648	<input type="checkbox"/> Yes, <input type="checkbox"/> No			698	<input type="checkbox"/> Yes, <input type="checkbox"/> No		
649	<input type="checkbox"/> Yes, <input type="checkbox"/> No			699	<input type="checkbox"/> Yes, <input type="checkbox"/> No		

TOLL RESTRICTION-AREA/OFFICE CODE TABLE (6/8)

Area/Office Code Table No. 8

Code No.	Local Access	Call	Restriction Level	Office Code	Code No.	Local Access	Call	Restriction Level	Office Code
700	<input type="checkbox"/> Yes <input type="checkbox"/> No				750	<input type="checkbox"/> Yes, <input type="checkbox"/> No			
701	<input type="checkbox"/> Yes <input type="checkbox"/> No				751	<input type="checkbox"/> Yes, <input type="checkbox"/> No			
702	<input type="checkbox"/> Yes <input type="checkbox"/> No				752	<input type="checkbox"/> Yes, <input type="checkbox"/> No			
703	<input type="checkbox"/> Yes <input type="checkbox"/> No				753	<input type="checkbox"/> Yes, <input type="checkbox"/> No			
704	<input type="checkbox"/> Yes <input type="checkbox"/> No				754	<input type="checkbox"/> Yes, <input type="checkbox"/> No			
705	<input type="checkbox"/> Yes <input type="checkbox"/> No				755	<input type="checkbox"/> Yes, <input type="checkbox"/> No			
706	<input type="checkbox"/> Yes <input type="checkbox"/> No				756				
707	<input type="checkbox"/> Yes <input type="checkbox"/> No				757	<input type="checkbox"/> Yes, <input type="checkbox"/> No			
708	<input type="checkbox"/> Yes <input type="checkbox"/> No				7 5 8	<input type="checkbox"/> Yes, <input type="checkbox"/> No			
709	<input type="checkbox"/> Yes <input type="checkbox"/> No				7 5 9	<input type="checkbox"/> Yes, <input type="checkbox"/> No			
710	<input type="checkbox"/> Yes <input type="checkbox"/> No				760	<input type="checkbox"/> Yes, <input type="checkbox"/> No			
711	<input type="checkbox"/> Yes <input type="checkbox"/> No				761	<input type="checkbox"/> Yes, <input type="checkbox"/> No			
712	<input type="checkbox"/> Yes <input type="checkbox"/> No				762	<input type="checkbox"/> Yes, <input type="checkbox"/> No			
713	<input type="checkbox"/> Yes <input type="checkbox"/> No				763	<input type="checkbox"/> Yes, <input type="checkbox"/> No			
714	<input type="checkbox"/> Yes <input type="checkbox"/> No				7 6 4	<input type="checkbox"/> Yes, <input type="checkbox"/> No			
715	<input type="checkbox"/> Yes <input type="checkbox"/> No				7 6 5	<input type="checkbox"/> Yes, <input type="checkbox"/> No			
716	<input type="checkbox"/> Yes <input type="checkbox"/> No				766	<input type="checkbox"/> Yes, <input type="checkbox"/> No			
717	<input type="checkbox"/> Yes <input type="checkbox"/> No				7 6 7	<input type="checkbox"/> Yes, <input type="checkbox"/> No			
718	<input type="checkbox"/> Yes <input type="checkbox"/> No				7 6 8	<input type="checkbox"/> Yes, <input type="checkbox"/> No			
719	<input type="checkbox"/> Yes <input type="checkbox"/> No				7 6 9	<input type="checkbox"/> Yes, <input type="checkbox"/> No			
720	<input type="checkbox"/> Yes <input type="checkbox"/> No				770	<input type="checkbox"/> Yes, <input type="checkbox"/> No			
721	<input type="checkbox"/> Yes <input type="checkbox"/> No				771	<input type="checkbox"/> Yes, <input type="checkbox"/> No			
722	<input type="checkbox"/> Yes <input type="checkbox"/> No				772	<input type="checkbox"/> Yes, <input type="checkbox"/> No			
723	<input type="checkbox"/> Yes <input type="checkbox"/> No				773	<input type="checkbox"/> Yes, <input type="checkbox"/> No			
724	<input type="checkbox"/> Yes <input type="checkbox"/> No				774	<input type="checkbox"/> Yes, <input type="checkbox"/> No			
725	<input type="checkbox"/> Yes <input type="checkbox"/> No				775	<input type="checkbox"/> Yes, <input type="checkbox"/> No			
726	<input type="checkbox"/> Yes <input type="checkbox"/> No				776	<input type="checkbox"/> Yes, <input type="checkbox"/> No			
727	<input type="checkbox"/> Yes <input type="checkbox"/> No				777	<input type="checkbox"/> Yes, <input type="checkbox"/> No			
728	<input type="checkbox"/> Yes <input type="checkbox"/> No				778	<input type="checkbox"/> Yes, <input type="checkbox"/> No			
729	<input type="checkbox"/> Yes <input type="checkbox"/> No				779	<input type="checkbox"/> Yes, <input type="checkbox"/> No			
730	<input type="checkbox"/> Yes <input type="checkbox"/> No				780	<input type="checkbox"/> Yes, <input type="checkbox"/> No			
731	<input type="checkbox"/> Yes <input type="checkbox"/> No				781	<input type="checkbox"/> Yes, <input type="checkbox"/> No			
7 3 2	<input type="checkbox"/> Yes <input type="checkbox"/> No				782	<input type="checkbox"/> Yes, <input type="checkbox"/> No			
733	<input type="checkbox"/> Yes <input type="checkbox"/> No				783	<input type="checkbox"/> Yes, <input type="checkbox"/> No			
734	<input type="checkbox"/> Yes <input type="checkbox"/> No				784	<input type="checkbox"/> Yes, <input type="checkbox"/> No			
735	<input type="checkbox"/> Yes <input type="checkbox"/> No				785	<input type="checkbox"/> Yes, <input type="checkbox"/> No			
736	<input type="checkbox"/> Yes <input type="checkbox"/> No				786	<input type="checkbox"/> Yes, <input type="checkbox"/> No			
737	<input type="checkbox"/> Yes <input type="checkbox"/> No				787	<input type="checkbox"/> Yes, <input type="checkbox"/> No			
738	<input type="checkbox"/> Yes <input type="checkbox"/> No				788	<input type="checkbox"/> Yes, <input type="checkbox"/> No			
739	<input type="checkbox"/> Yes <input type="checkbox"/> No				789	<input type="checkbox"/> Yes, <input type="checkbox"/> No			
740	<input type="checkbox"/> Yes <input type="checkbox"/> No				790	<input type="checkbox"/> Yes, <input type="checkbox"/> No			
741	<input type="checkbox"/> Yes <input type="checkbox"/> No				791	<input type="checkbox"/> Yes, <input type="checkbox"/> No			
742	<input type="checkbox"/> Yes <input type="checkbox"/> No				792	<input type="checkbox"/> Yes, <input type="checkbox"/> No			
743	<input type="checkbox"/> Yes <input type="checkbox"/> No				793	<input type="checkbox"/> Yes, <input type="checkbox"/> No			
744	<input type="checkbox"/> Yes <input type="checkbox"/> No				794	<input type="checkbox"/> Yes, <input type="checkbox"/> No			
745	<input type="checkbox"/> Yes <input type="checkbox"/> No				795	<input type="checkbox"/> Yes, <input type="checkbox"/> No			
746	<input type="checkbox"/> Yes <input type="checkbox"/> No				796	<input type="checkbox"/> Yes, <input type="checkbox"/> No			
7 4 7	<input type="checkbox"/> Yes <input type="checkbox"/> No				7 9 7	<input type="checkbox"/> Yes, <input type="checkbox"/> No			
7 4 8	<input type="checkbox"/> Yes <input type="checkbox"/> No				7 9 8	<input type="checkbox"/> Yes, <input type="checkbox"/> No			
7 4 9	<input type="checkbox"/> Yes <input type="checkbox"/> No				799	<input type="checkbox"/> Yes, <input type="checkbox"/> No			

TOLL RESTRICTION-AREA/OFFICE CODE TABLE (7/8)

Area/Office Code Table No 8

Code No.	Local Ca I Access	Restriction Level	Office Code	Code No.	Local Ca Access	Restriction Level	Office Code
800	<input type="checkbox"/> Yes, <input checked="" type="checkbox"/> No			850	<input type="checkbox"/> Yes, <input checked="" type="checkbox"/> No		
801	<input type="checkbox"/> Yes, <input checked="" type="checkbox"/> No			851	<input type="checkbox"/> Yes, <input checked="" type="checkbox"/> No		
802	<input checked="" type="checkbox"/> Yes, <input type="checkbox"/> No			852	<input type="checkbox"/> Yes, <input checked="" type="checkbox"/> No		
803	<input type="checkbox"/> Yes, <input checked="" type="checkbox"/> No			853	<input type="checkbox"/> Yes, <input checked="" type="checkbox"/> No		
804	<input type="checkbox"/> Yes, <input checked="" type="checkbox"/> No			854	<input type="checkbox"/> Yes, <input checked="" type="checkbox"/> No		
805	<input type="checkbox"/> Yes, <input checked="" type="checkbox"/> No			855	<input type="checkbox"/> Yes, <input checked="" type="checkbox"/> No		
806	<input type="checkbox"/> Yes, <input checked="" type="checkbox"/> No			856	<input type="checkbox"/> Yes, <input checked="" type="checkbox"/> No		
807	<input type="checkbox"/> Yes, <input checked="" type="checkbox"/> No			857	<input type="checkbox"/> Yes, <input checked="" type="checkbox"/> No		
808	<input type="checkbox"/> Yes, <input checked="" type="checkbox"/> No			858	<input type="checkbox"/> Yes, <input checked="" type="checkbox"/> No		
809	<input type="checkbox"/> Yes, <input checked="" type="checkbox"/> No			859	<input type="checkbox"/> Yes, <input checked="" type="checkbox"/> No		
810	<input type="checkbox"/> Yes, <input checked="" type="checkbox"/> No			860	<input type="checkbox"/> Yes, <input checked="" type="checkbox"/> No		
811	<input type="checkbox"/> Yes, <input checked="" type="checkbox"/> No			861	<input type="checkbox"/> Yes, <input checked="" type="checkbox"/> No		
812	<input type="checkbox"/> Yes, <input checked="" type="checkbox"/> No			862	<input type="checkbox"/> Yes, <input checked="" type="checkbox"/> No		
813	<input type="checkbox"/> Yes, <input checked="" type="checkbox"/> No			863	<input type="checkbox"/> Yes, <input checked="" type="checkbox"/> No		
814	<input type="checkbox"/> Yes, <input checked="" type="checkbox"/> No			864	<input type="checkbox"/> Yes, <input checked="" type="checkbox"/> No		
815	<input type="checkbox"/> Yes, <input checked="" type="checkbox"/> No			865	<input type="checkbox"/> Yes, <input checked="" type="checkbox"/> No		
816	<input type="checkbox"/> Yes, <input checked="" type="checkbox"/> No			866	<input type="checkbox"/> Yes, <input checked="" type="checkbox"/> No		
817	<input type="checkbox"/> Yes, <input checked="" type="checkbox"/> No			867	<input type="checkbox"/> Yes, <input checked="" type="checkbox"/> No		
818	<input type="checkbox"/> Yes, <input checked="" type="checkbox"/> No			868	<input type="checkbox"/> Yes, <input checked="" type="checkbox"/> No		
819	<input type="checkbox"/> Yes, <input checked="" type="checkbox"/> No			869	<input type="checkbox"/> Yes, <input checked="" type="checkbox"/> No		
820	<input type="checkbox"/> Yes, <input checked="" type="checkbox"/> No			870	<input type="checkbox"/> Yes, <input checked="" type="checkbox"/> No		
821	<input type="checkbox"/> Yes, <input checked="" type="checkbox"/> No			871	<input type="checkbox"/> Yes, <input checked="" type="checkbox"/> No		
822	<input type="checkbox"/> Yes, <input checked="" type="checkbox"/> No			872	<input type="checkbox"/> Yes, <input checked="" type="checkbox"/> No		
823	<input type="checkbox"/> Yes, <input checked="" type="checkbox"/> No			873	<input type="checkbox"/> Yes, <input checked="" type="checkbox"/> No		
824	<input type="checkbox"/> Yes, <input checked="" type="checkbox"/> No			874	<input type="checkbox"/> Yes, <input checked="" type="checkbox"/> No		
825	<input type="checkbox"/> Yes, <input checked="" type="checkbox"/> No			875	<input type="checkbox"/> Yes, <input checked="" type="checkbox"/> No		
826	<input type="checkbox"/> Yes, <input checked="" type="checkbox"/> No			876	<input type="checkbox"/> Yes, <input checked="" type="checkbox"/> No		
827	<input type="checkbox"/> Yes, <input checked="" type="checkbox"/> No			877	<input type="checkbox"/> Yes, <input checked="" type="checkbox"/> No		
828	<input type="checkbox"/> Yes, <input checked="" type="checkbox"/> No			878	<input type="checkbox"/> Yes, <input checked="" type="checkbox"/> No		
829	<input type="checkbox"/> Yes, <input checked="" type="checkbox"/> No			879	<input type="checkbox"/> Yes, <input checked="" type="checkbox"/> No		
830	<input type="checkbox"/> Yes, <input checked="" type="checkbox"/> No			880	<input type="checkbox"/> Yes, <input checked="" type="checkbox"/> No		
831	<input type="checkbox"/> Yes, <input checked="" type="checkbox"/> No			881	<input type="checkbox"/> Yes, <input checked="" type="checkbox"/> No		
832	<input type="checkbox"/> Yes, <input checked="" type="checkbox"/> No			882	<input type="checkbox"/> Yes, <input checked="" type="checkbox"/> No		
833	<input type="checkbox"/> Yes, <input checked="" type="checkbox"/> No			883	<input type="checkbox"/> Yes, <input checked="" type="checkbox"/> No		
834	<input type="checkbox"/> Yes, <input checked="" type="checkbox"/> No			884	<input type="checkbox"/> Yes, <input checked="" type="checkbox"/> No		
835	<input type="checkbox"/> Yes, <input checked="" type="checkbox"/> No			885	<input type="checkbox"/> Yes, <input checked="" type="checkbox"/> No		
836	<input type="checkbox"/> Yes, <input checked="" type="checkbox"/> No			886	<input type="checkbox"/> Yes, <input checked="" type="checkbox"/> No		
837	<input type="checkbox"/> Yes, <input checked="" type="checkbox"/> No			887	<input type="checkbox"/> Yes, <input checked="" type="checkbox"/> No		
838	<input type="checkbox"/> Yes, <input checked="" type="checkbox"/> No			888	<input type="checkbox"/> Yes, <input checked="" type="checkbox"/> No		
839	<input type="checkbox"/> Yes, <input checked="" type="checkbox"/> No			889	<input type="checkbox"/> Yes, <input checked="" type="checkbox"/> No		
840	<input type="checkbox"/> Yes, <input checked="" type="checkbox"/> No			890	<input type="checkbox"/> Yes, <input checked="" type="checkbox"/> No		
841	<input type="checkbox"/> Yes, <input checked="" type="checkbox"/> No			891	<input type="checkbox"/> Yes, <input checked="" type="checkbox"/> No		
842	<input type="checkbox"/> Yes, <input checked="" type="checkbox"/> No			892	<input type="checkbox"/> Yes, <input checked="" type="checkbox"/> No		
843	<input type="checkbox"/> Yes, <input checked="" type="checkbox"/> No			893	<input type="checkbox"/> Yes, <input checked="" type="checkbox"/> No		
844	<input type="checkbox"/> Yes, <input checked="" type="checkbox"/> No			894	<input type="checkbox"/> Yes, <input checked="" type="checkbox"/> No		
845	<input type="checkbox"/> Yes, <input checked="" type="checkbox"/> No			895	<input type="checkbox"/> Yes, <input checked="" type="checkbox"/> No		
846	<input type="checkbox"/> Yes, <input checked="" type="checkbox"/> No			896	<input type="checkbox"/> Yes, <input checked="" type="checkbox"/> No		
847	<input type="checkbox"/> Yes, <input checked="" type="checkbox"/> No			897	<input type="checkbox"/> Yes, <input checked="" type="checkbox"/> No		
848	<input type="checkbox"/> Yes, <input checked="" type="checkbox"/> No			898	<input type="checkbox"/> Yes, <input checked="" type="checkbox"/> No		
849	<input type="checkbox"/> Yes, <input checked="" type="checkbox"/> No			899	<input type="checkbox"/> Yes, <input checked="" type="checkbox"/> No		

TOLL RESTRICTION-AREA/OFFICE CODE TABLE (818)

Area/Office Code Table No. 8

Code NO.	Local Access	Call Restriction Level	Office Code	Code No.	Local Access	Call Restriction Level	Office Code
400	<input type="checkbox"/> Yes, <input type="checkbox"/> No			950	<input type="checkbox"/> Yes, <input type="checkbox"/> No		
901	<input type="checkbox"/> Yes, <input type="checkbox"/> No			951	<input type="checkbox"/> Yes, <input type="checkbox"/> No		I
902	<input type="checkbox"/> Yes, <input type="checkbox"/> No			952	<input type="checkbox"/> Yes, <input type="checkbox"/> No		
903	<input type="checkbox"/> Yes, <input type="checkbox"/> No			953	<input type="checkbox"/> Yes, <input type="checkbox"/> No		
904	<input type="checkbox"/> Yes, <input type="checkbox"/> No			954	<input type="checkbox"/> Yes, <input type="checkbox"/> No		
905	<input type="checkbox"/> Yes, <input type="checkbox"/> No			956	<input type="checkbox"/> Yes, <input type="checkbox"/> No		
906	<input type="checkbox"/> Yes, <input type="checkbox"/> No			957	<input type="checkbox"/> Yes, <input type="checkbox"/> No		
910	<input type="checkbox"/> Yes, <input type="checkbox"/> No			960	<input type="checkbox"/> Yes, <input type="checkbox"/> No		
911	<input type="checkbox"/> Yes, <input type="checkbox"/> No			961	<input type="checkbox"/> Yes, <input type="checkbox"/> No		
912	<input type="checkbox"/> Yes, <input type="checkbox"/> No			962	<input type="checkbox"/> Yes, <input type="checkbox"/> No		
913	<input type="checkbox"/> Yes, <input type="checkbox"/> No			963	<input type="checkbox"/> Yes, <input type="checkbox"/> No		
914	<input type="checkbox"/> Yes, <input type="checkbox"/> No			964	<input type="checkbox"/> Yes, <input type="checkbox"/> No		
915	<input type="checkbox"/> Yes, <input type="checkbox"/> No			965	<input type="checkbox"/> Yes, <input type="checkbox"/> No		
916	<input type="checkbox"/> Yes, <input type="checkbox"/> No			966	<input type="checkbox"/> Yes, <input type="checkbox"/> No		
917	<input type="checkbox"/> Yes, <input type="checkbox"/> No			967	<input type="checkbox"/> Yes, <input type="checkbox"/> No		
918	<input type="checkbox"/> Yes, <input type="checkbox"/> No			968	<input type="checkbox"/> Yes, <input type="checkbox"/> No		
919	<input type="checkbox"/> Yes, <input type="checkbox"/> No			969	<input type="checkbox"/> Yes, <input type="checkbox"/> No		
920	<input type="checkbox"/> Yes, <input type="checkbox"/> No			970	<input type="checkbox"/> Yes, <input type="checkbox"/> No		
921	<input type="checkbox"/> Yes, <input type="checkbox"/> No			971	<input type="checkbox"/> Yes, <input type="checkbox"/> No		
922	<input type="checkbox"/> Yes, <input type="checkbox"/> No			972	<input type="checkbox"/> Yes, <input type="checkbox"/> No		
923	<input type="checkbox"/> Yes, <input type="checkbox"/> No			973	<input type="checkbox"/> Yes, <input type="checkbox"/> No		
924	<input type="checkbox"/> Yes, <input type="checkbox"/> No			974	<input type="checkbox"/> Yes, <input type="checkbox"/> No		
925	<input type="checkbox"/> Yes, <input type="checkbox"/> No			975	<input type="checkbox"/> Yes, <input type="checkbox"/> No		
926	<input type="checkbox"/> Yes, <input type="checkbox"/> No			976	<input type="checkbox"/> Yes, <input type="checkbox"/> No		
927	<input type="checkbox"/> Yes, <input type="checkbox"/> No			977	<input type="checkbox"/> Yes, <input type="checkbox"/> No		
928	<input type="checkbox"/> Yes, <input type="checkbox"/> No			978	<input type="checkbox"/> Yes, <input type="checkbox"/> No		
929	<input type="checkbox"/> Yes, <input type="checkbox"/> No			979	<input type="checkbox"/> Yes, <input type="checkbox"/> No		
930	<input type="checkbox"/> Yes, <input type="checkbox"/> No			980	<input type="checkbox"/> Yes, <input type="checkbox"/> No		
931	<input type="checkbox"/> Yes, <input type="checkbox"/> No			981	<input type="checkbox"/> Yes, <input type="checkbox"/> No		
932	<input type="checkbox"/> Yes, <input type="checkbox"/> No			982	<input type="checkbox"/> Yes, <input type="checkbox"/> No		
933	<input type="checkbox"/> Yes, <input type="checkbox"/> No			983	<input type="checkbox"/> Yes, <input type="checkbox"/> No		
934	<input type="checkbox"/> Yes, <input type="checkbox"/> No			984	<input type="checkbox"/> Yes, <input type="checkbox"/> No		
935	<input type="checkbox"/> Yes, <input type="checkbox"/> No			985	<input type="checkbox"/> Yes, <input type="checkbox"/> No		
936	<input type="checkbox"/> Yes, <input type="checkbox"/> No			986	<input type="checkbox"/> Yes, <input type="checkbox"/> No		
937	<input type="checkbox"/> Yes, <input type="checkbox"/> No			987	<input type="checkbox"/> Yes, <input type="checkbox"/> No		
938	<input type="checkbox"/> Yes, <input type="checkbox"/> No			988	<input type="checkbox"/> Yes, <input type="checkbox"/> No		
939	<input type="checkbox"/> Yes, <input type="checkbox"/> No			989	<input type="checkbox"/> Yes, <input type="checkbox"/> No		
940	<input type="checkbox"/> Yes, <input type="checkbox"/> No			990	<input type="checkbox"/> Yes, <input type="checkbox"/> No		
941	<input type="checkbox"/> Yes, <input type="checkbox"/> No			991	<input type="checkbox"/> Yes, <input type="checkbox"/> No		
942	<input type="checkbox"/> Yes, <input type="checkbox"/> No			992	<input type="checkbox"/> Yes, <input type="checkbox"/> No		
943	<input type="checkbox"/> Yes, <input type="checkbox"/> No			993	<input type="checkbox"/> Yes, <input type="checkbox"/> No		
944	<input type="checkbox"/> Yes, <input type="checkbox"/> No			994	<input type="checkbox"/> Yes, <input type="checkbox"/> No		
945	<input type="checkbox"/> Yes, <input type="checkbox"/> No			995	<input type="checkbox"/> Yes, <input type="checkbox"/> No		
946	<input type="checkbox"/> Yes, <input type="checkbox"/> No			996	<input type="checkbox"/> Yes, <input type="checkbox"/> No		
947	<input type="checkbox"/> Yes, <input type="checkbox"/> No			997	<input type="checkbox"/> Yes, <input type="checkbox"/> No		
948	<input type="checkbox"/> Yes, <input type="checkbox"/> No			998	<input type="checkbox"/> Yes, <input type="checkbox"/> No		
949	<input type="checkbox"/> Yes, <input type="checkbox"/> No			999	<input type="checkbox"/> Yes, <input type="checkbox"/> No		

TOLL RESTRICTION-OFFICE CODE TABLE

Office Code Table No. ____ (01 to 64)

┌── 2 Hundred (230 to 249)

┌── 2 Hundred (200 to 249)

I	200	300	400	500	600	700	800	900		200	300	400	500	600	700	800	900
00									50								
01									51								
02									52								
03									53								
04									54								
05									55								
06									56								
07									57								
08									58								
09									59								
10									60								
11									61								
12									62								
13									63								
14									64								
15									65								
16									66								
17									67								
18									68								
19									69								
20									70								
21								II	71								
2	2	1							72								
23									73								
24									74								
25									75								
26									76								
27									77								
28									78								
29									79								
30									80								
31									81								
32									82								
33									83								
34									84								
35									85								
36									86								
37									87								
38									88								
39									89								
40									90								
41									91								
42									92								
43									93								
44									94								
45									95								
46									96								
47									97								
48									98								
49									99								

TOLLRESTRICTION-OFFICECODETABLE

Office Code Table No. ____ (01 to 64)

_____ 2 Hundred (200 to 249)

_____ 2 Hundred (200 to 249)

	200	300	400	500	600	700	800	900		200	300	400	500	600	700	800	900
00									50								
01									51							I	
02									52								
03									53								
04									54								
05									55								
06									56								
07									57								
08									58								
09									59								
10									60								
11									61								
12									62								
13									63								
14									64								
15									65								
16									66								
17									67								
18									68								
19									69								
20									70								
21									71								
22									72								
23									73								
24									74								
25									75								
26									76								
27									77								
28									78								
29									79								
30									80								
31									81								
32									82								
33									83								
34									84								
35									85								
36									86								
37									87								
38									88								
39									89								
40									90								
41									91								
42									92								
43									93								
44									94								
45									95								
46									96								
47									97								
48									98								
49									99								

TOLL RESTRICTION-OFFICE CODE TABLE

Office Code Table No. ____ (01 to 64)

	2 - Hundred (200 to 249)								2 Hundred (200 to 249)							
	200	300	400	500	600	700	800	900	200	300	400	500	600	700	800	900
00									50							
01									51							
02									52							
03									53							
04									54							
05									55							
06									56							
07									57							
08									58							
09									59							
10									60							
11									61							
12									62							
13									63							
14									64							
15									65							
16									66							
17									67							
18									68							
19									69							
20									70							
21									71							
22									72							
23									73							
24									74							
25									75							
26									76							
27									77							
28									78							
29									79							
30									80							
31									81							
32									82							
33									83							
34									84							
35									85							
36									86							
37									87							
38									88							
39									89							
40									90							
41									91							
42									92							
43									93							
44									94							
45									95							
46									96							
47									97							
48									98							
49									99							

TOLL RESTRICTION-OFFICE CODE TABLE

Office Code Table No. ___ (01 to 64)

	2 Hundred (200 to 249)								2 Hundred (200 to 249)							
	200	300	400	500	600	700	800	900	200	300	400	500	600	700	800	900
00								50								
01								51								
02								52								
03								53								
04								54								
05								55								
06								56								
07								57								
08								58								
09								59								
10								60								
11								61								
12								62								
13								63								
14								64								
15								65								
16								66								
17								67								
18								68								
19								69								
20								70								
21								71								
22								72								
23								73								
24								74								
25								75								
26								76								
27								77								
28								78								
29								79								
30								80								
31								81								
32								82								
33								83								
34								84								
35								85								
36								86								
37								87								
38								88								
39								89								
40								90								
41								91								
42								92								
43								93								
44								94								
45								95								
46								96								
47								97								
48								98								
49								99								

TOLL RESTRICTION-OFFICE CODE TABLE

Office Code Table No. ____ (01 to 64)

— 2 Hundred (200 to 249)

└ 2 Hundred (200 to 249)

	200	300	400	500	600	700	800	900		200	300	400	500	600	700	800	900
00										50							
01										51							
02										52							
03										53							
04										54							
05										55							
06										56							
07										57							
08										58							
09										59							
10										60							
11										61							
12										62							
13										63							
14										64							
15										65							
16										66							
17										67							
18										68							
19										69							
20										70							
21										71							
22										72							
23										73							
24										74							
25										75							
26										76							
27										77							
28										78							
29										79							
30										80							
31										81							
32										82							
33										83							
34										84							
35										85							
36										86							
37										87							
38										88							
39	I									89							
40										90							
41										91							
42										92							
43										93							
44										94							
45										95							
46										96							
47										97							
48										98							
49										99							

TOLL RESTRICTION-OFFICE CODE TABLE

Office Code Table No. ____ (01 to 64)

2 Hundred (200 to 249)								2 Hundred (200 to 249)							
200	300	400	500	600	700	800	900	200	300	400	500	600	700	800	900
00								50							
01								51							
02								52							
03								53							
04								54							
05								55							
06								56							
07								57							
08								58							
09								59							
10								60							
11								61							
12								62							
13								63							
14								64							
15								65							
16								66							
17								67							
18								68							
19								69							
20								70							
21								71							
22								72							
23								73							
24								74							
25								75							
26								76							
27								77							
28								78							
29								79							
30								80							
31								81							
32								82							
33								83							
34								84							
35								85							
36								86							
37								87							
38								88							
39								89							
40								90							
41								91							
42								92							
43								93							
44								94							
45								95							
46								96							
47								97							
48								98							
49								99							

TOLL RESTRICTION-OFFICE CODE TABLE

Office Code Table No. ____ (01 to 64)

— 2 Hundred (200 to 249)

— 2 Hundred (200 to 249)

	2 Hundred (200 to 249)							2 Hundred (200 to 249)								
	200	300	400	500	600	700	800	900	200	300	400	500	600	700	800	900
00									50							
01									51							
02									52							
03									53							
04									54							
05									55							
06									56							
07									57							
08									58							
09									59							
10									60							
11									61							
12									62							
13									63							
14									64							
15									65							
16									66							
17									67							
18									68							
19									69							
20									70							
21									71							
22									72							
23									73							
24									74							
25									75							
26									76							
27									77							
28									78							
29									79							
30									80							
31									81							
32									82							
33									83							
34									84							
35									85							
36									86							
37									87							
38									88							
39									89							
40									90							
41									91							
42									92							
43									93							
44									94							
45									95							
46									96							
47									97							
49									99							

TOLL RESTRICTION-OFFICE CODE TABLE

Office Code Table No. ___ (01 to 64)

2 Hundred (200 to 249)

2 Hundred (200 to 249)

	200	300	400	500	600	700	800	900	200	300	400	500	600	700	800	900
00									50							
01									51							
02									52							
03									53							
04									54							
05									55							
06									56							
07									57							
08									58							
09									59							
10									60							
11									61							
12									62							
13									63							
14									64							
15									65							
16									66							
17									67							
18									68							
19									69							
20									70							
21									71							
22									72							
23									73							
24									74							
25									75							
26									76							
27									77							
28									78							
29									79							
30									80							
31									81							
32									82							
33									83							
34									84							
35									85							
36									86							
37									87							
38									88							
39									89							
40									90							
41									91							
42									92							
43									93							
44									94							
45									95							
46									96							
47									97							
48									98							
49									99							

TOLL RESTRICTION-OFFICE CODE TABLE

Office Code Table No. ____ (01 to 64)

— 2 Hundred (200 to 249)

— 2 Hundrec (200 to 249)

	200	300	400	500	600	700	800	900		200	300	400	500	600	700	800	900
00									50								
01		I	I						51								
02						I			52								
03									53			I					
04									54								
05									55			I					
06									56								
07									57								
08									58								
09									59								
10									60								
11									61								
12									62			I					
13									63			I					
14									64								
15									65								
16									66								
17									67								
18									68								
19									69								
20									70								
21									71								
22									72								
23									73								
24									74								
25									75								
26									76								
27									77								
28									78								
29									79								
30									80								
31									81								
32									82								
33									83								
34									84								
35									85								
36									86								
37									87								
38									88								
39									89								
40									90								
41									91								
42									92								
43									93								
44									94								
45									95								
46									96								
47									97								
48									98								
49									99								

TOLL RESTRICTION-OFFICE CODE TABLE

Office Code Table No. ____ (01 to 64)

	2 Hundred (200 to 249)								2 Hundred (200 to 249)							
	200	300	400	500	600	700	800	900	200	300	400	500	600	700	800	900
00									50							
01									51							
02									52							
03									53							
04									54							
05									55							
06									56							
07									57							
08									58							
09									59							
10									60							
11									61							
12									62							
13									63							
14									64							
15									65							
16									66							
17									67							
18									68							
19									69							
20									70							
21									71							
22									72							
23									73							
24									74							
25									75							
26									76							
27									77							
28									78							
29									79							
30									80							
31									81							
32									82							
33									83							
34									84							
35									85							
36									86							
37									87							
38									88							
39									89							
40									90							
41									91							
42									92							
43									93							
44									94							
45									95							
46									96							
47									97							
48									98							
49									99							

TOLL RESTRICTION-OFFICE CODE TABLE

Office Code Table No. ____ (01 to 64j)

2 Hundred (200 to 249)								2 Hundred (200 to 249)							
200	300	400	500	600	700	800	900	200	300	400	500	600	700	800	900
00								50							
01								51							
02								52							
03								53							
04								54							
05								55							
06								56							
07								57							
08								58							
09								59							
10								60							
11								61							
12								62							
13								63							
14								64							
15								65							
16								66							
17								67							
18								68							
19								69							
20								70							
21								71							
22								72							
23								73							
24								74							
25								75							
26								76							
27								77							
28								78							
29								79							
30								80							
31								81							
32								82							
33								83							
34								84							
35								85							
36								86							
37								87							
38								88							
39								89							
40								90							
41								91							
42								92							
43								93							
44								94							
45								95							
46								96							
47								97							
48								98							
49								99							

TOLL RESTRICTION-OFFICE CODE TABLE

Office Code Table No. ____ (01 to 64)

	2 Hundred (200 to 249)								2 Hundred (200 to 249)							
	200	300	400	500	600	700	800	900	200	300	400	500	600	700	800	900
00									50							
01									51							
02									52							
03									53							
04									54							
05									55							
06									56							
07									57							
08									58							
09									59							
10									60							
11									61							
12									62							
13									63							
14									64							
15									65							
16									66							
17									67							
18									68							
19									69							
20									70							
21									71							
22									72							
23									73							
24									74							
25									75							
26									76							
27									77							
28									78							
29									79							
30									80							
31									81							
32									82							
33									83							
34									84							
35									85							
36									86							
37									87							
38									88							
39									89							
40									90							
41									91							
42									92							
43									93							
44									94							
45									95							
46									96							
47									97							
48									98							
49									99							

TOLL RESTRICTION-OFFICE CODE TABLE

Office Code Table No. __ (01 to 64)

	2 Hundred (200 to 249)								2 Hundred (200 to 249)							
	200	300	400	500	600	700	800	900	200	300	400	500	600	700	800	900
00								50								
01								51								
02								52								
03								53								
04								54								
05								55								
06								56								
07								57								
08								58								
09								59								
10								60								
11								61								
12								62								
13								63								
14								64								
15								65								
16								66								
17								67								
18								68								
19								69								
20								70								
21								71								
22								72								
23								73								
24								74								
25								75								
26								76								
27								77								
28								78								
29								79								
30								80								
31								81								
32								82								
33								83								
34								84								
35								85								
36								86								
37								87								
38								88								
39								89								
40								90								
41								91								
42								92								
43								93								
44								94								
45								95								
46								96								
47								97								
48								98								
49								99								

TOLL RESTRICTION-OFFICE CODE TABLE

Office Code Table No. ____ (01 to 64)

	2 Hundred (200 to 249)									2 Hundred (200 to 249)								
	200	300	400	500	600	700	800	900		200	300	400	500	600	700	800	900	
00									50									
01									51									
02									52									
03									53									
04									54									
05									55									
06									56									
07									57									
08									58									
09									59									
10									60									
11									61									
12									62									
13									63									
14									64									
15									65									
16									66									
17									67									
18									68									
19									69									
20									70									
21									71									
22									72									
23									73									
24									74									
25									75									
26									76									
27									77									
28									78									
29									79									
30									80									
31									81									
32									82									
33									83									
34									84									
35									85									
36									86									
37									87									
38									88									
39									89									
40									90									
41									91									
42									92									
43									93									
44									94									
45									95									
46									96									
47									97									
48									98									
49									99									

TOLL RESTRICTION-OFFICE CODE TABLE

Office Code Table No. (01 to 64)

┌── 2 Hundred (200 to 249)

└── 2 Hundred (200 to 249)

	200	1300	400	500	600	I	700	800	900		200	300	400	500	600	700	800	900	
00.										50								I	
01										51									
02										52									
03										53									
04										54									
05										55									
0 6										56									
07										57									
08										58									
09										59									
10										60									
11										61									
12										62									
13										63									
14										64									
15										65									
16										66									
17										67									
18										68									
19										69									
20										70									
21										71									
22										72									
23										73									
24										74									
25										75									
26										76									
27										77									
28										78									
29										79									
30										80									
31										81									
32										82									
33										83									
34										84									
35										85									
36										86									
37										87									
38										88									
39										89									
40										90									
41										91									
42										92									
43										93									
44										94									
45										95									
46										96									
47										97									
48										98									
49										99									

TOLL RESTRICTION-OFFICE CODE TABLE

Office Code Table No. ____ (01 to 64)

_____ 2 Hundred (200 to 249)

_____ 2 Hundred (200 to 249)

	2 0 0	3 0 0	4 0 0	5 0 0	6 0 0	7 0 0	8 0 0	9 0 0		2 0 0	3 0 0	4 0 0	5 0 0	6 0 0	7 0 0	8 0 0	9 0 0
00										50							
01										51							
02																	
03										53							
04										54							
05										55							
06										56							
07										57							
08										58							
09										59							
10										60							
11										61							
12										62							
13										63							
14										64							
15										65							
16										66							
17										67							
18										68							
19										69							
20										70							
21										71							
22										72							
23										73							
24										74							
25										75							
26										76							
27										77							
28										78							
29										79							
30										80							
31										81							
32										82							
33										83							
34										84							
35										85							
36										86							
37										87							
38										88							
39										89							
40										90							
41										91							
42										92							
43										93							
44										94							
45										95							
46										96							
47										97							
48										98							
49										99							

TOLL RESTRICTION-OFFICE CODE TABLE

Office Code Table No. ____ (01 to 64)

2 Hundred (200 to 249)							2 Hundred (200 to 249)								
200	300	400	500	600	700	800	900	200	300	400	500	600	700	800	900
00								50							
01								51							
02								52							
03								53							
04								54							
05								55							
06								56							
07								57							
08								58							
09								59							
10								60							
11								61							
12								62							
13								63							
14								64							
15								65							
16								66							
17								67							
18								68							
19								69							
20								70							
21								71							
22								72							
23								73							
24								74							
25								75							
26								76							
27								77							
28								78							
29								79							
30								80							
31								81							
32								82							
33								83							
34								84							
35								85							
36								86							
37								87							
38								88							
39								89							
40								90							
41								91							
42								92							
43								93							
44								94							
45								95							
46								96							
47								97							
48								98							
49	I							99							

TOLL RESTRICTION-OFFICE CODE TABLE

Office Code Table No. ____ (01 to 64)

	2 Hundred (200 to 249)								2 Hundred (200 to 249)							
	200	300	400	500	600	700	800	900	200	300	400	500	600	700	800	900
00									50							
01									51							
02									52							
03									53							
04									54							
05									55							
06									56							
07									57							
08									58							
09									59							
10									60							
11									61							
12									62							
13									63							
14									64							
15									65							
16									66							
17									67							
18									68							
19									69							
20									70							
21									71							
22									72							
23									73							
24									74							
25									75							
26									76							
27									77							
28									78							
29									79							
30									80							
31									81							
32									82							
33									83							
34									84							
35									85							
36									86							
37									87							
38									88							
39									89							
40									90							
41									91							
42									92							
43									93							
44									94							
45									95							
46									96							
47									97							
48									98							
49									99							

TOLL RESTRICTION-OFFICE CODE TABLE

Office Code Table No. ____ (01 to 64)

┌── 2 Hundred (200 to 249)

┌── 2 Hundred (200 to 249)

	200	300	400	500	600	700	800	900		200	300	400	500	600	700	800	900
00									50	I							
01									51	!							
02									52								
03									53	!							
04									54								
05									55								
06									56								
07									57								
08									58								
09									59								
10									60								
11									61								
12									62								
13									63								
14									64								
15	I								65								
16									66								
17									67								
18									68								
19									69								
20									70								
21									71								
22									72								
23									73								
24									74								
25									75								
26									76								
27									77								
28									78								
29									79								
30									80								
31									81								
32									82								
33									83								
34									84								
35									85								
36									86								
37									87								
38									88								
39									89								
40									90								
41									91								
42									92								
43									93								
44									94								
45									95								
46									96								
47									97								
48									98								
49									99								

TOLL RESTRICTION-OFFICE CODE TABLE

Office Code Table No. ____ (01 to 64)

┌─── 2 Hundred (200 to 249)

┌─── 2 Hundred (200 to 249)

	2 Hundred (200 to 249)								2 Hundred (200 to 249)							
	200	300	400	500	600	700	800	900	200	300	400	500	600	700	800	900
00									50							
01									51							
02									52							
03									53							
04									54							
05									55							
06									56							
07									57							
08									58							
09									59							
10									60							
11									61							
12									62							
13									63							
14									64							
15									65							
16									66							
17									67							
18									68							
19									69							
20									70							
21									71							
22									72							
23									73							
24									74							
25									75							
26									76							
27									77							
28									78							
29									79							
30									80							
31									81							
32									82							
33									83							
34									84							
35									85							
36									86							
37									87							
38									88							
39									89							
40									90							
41									91							
42									92							
43									93							
44									94							
45									95							
46									96							
47									97							
48									98							
49									99							

TOLL RESTRICTION-OFFICE CODE TABLE

Office Code Table No. ____ (01 to 64)

┌── 2 Hundred (200 to 249)

└── 2 Hundred (200 to 249)

	200	300	400	500	600	700	800	900		200	300	400	500	600	700	800	900
00									50								
01									51								
02									52								
03									53								
04									54								
05									55								
06									56								
07									II 57 I								
08									58								
09									59								
10									60								
11									61								
12									62								
13									63								
14									64								
15									65								
16									66								
17									67								
18									68								
19									69								
20									70								
21									71								
22									72								
23									73								
24									74								
25									75								
26									76								
27									77								
28									78								
29									79								
30									80								
31									81								
32									82								
33									83								
34									84								
35									85								
36									86								
37									87								
38									88								
39									89								
40									90								
41									91								
42									92								
43									93								
44									94								
45									95								
46									96								
47									97								
48									98								
49									99								

TOLL RESTRICTION-OFFICE CODE TABLE

Office Code Table No. __ (01 to 64)

A 2 Hundred (200 to 249)									1 Hundred (200 to 249)								
200	300	400	500	600	700	800	900		200	300	400	500	600	700	800	900	
00								50									
01								51									
02								52									
03								53									
04								54									
05								55									
06								56									
07								57									
08								58									
09								59									
10								60									
11								61									
12								62									
13								63									
14								64									
15								65									
16								66									
17								67									
18								68									
19								69									
20								70									
21								71									
22								72									
23								73									
24								74									
25								75									
26								76									
27								77									
28								78									
29								79									
30								80									
31								81									
32								82									
33								83									
34								84									
35								85									
36								86									
37								87									
38								88									
39								89									
40								90									
41								91									
42								92									
43								93									
44								94									
45								95									
46								96									
47								97									
48								98									
49								99									

TOLL RESTRICTION-OFFICE CODE TABLE

Office Code Table No. ____ (01 to 64)

	2 Hundred (200 to 249)								2 Hundred (200 to 249)								
	200	300	400	500	600	700	800	900		200	300	400	500	600	700	800	900
00									50								
01									51								
02									52								
03									53								
04									54								
05									55								
06									56								
07									57								
08									58								
09									59								
10									60								
11									61								
12									62								
13									63								
14									64								
15									65								
16									66								
17									67								
18									68								
19									69								
20									70								
21									71								
22									72								
23									73								
24									74								
25									75								
26									76								
27									77								
28									78								
29									79								
30									80								
31									81								
32									82								
33									83								
34									84								
35									85								
36									86								
37									87								
38									88								
39									89								
40									90								
41									91								
42									92								
43									93								
44									94								
45									95								
46									96								
47									97								
48									98								
49									99								

TOLL RESTRICTION-OFFICE CODE TABLE

Office Code Table No. ____ (01 to 64)

	2 Hundred (200 to 249)								2 Hundred (200 to 249)							
	200	300	400	500	600	700	800	900	200	300	400	500	600	700	800	900
00									50							
01									51							
02									52							
03									53							
04									54							
05									55							
06									56							
07									57							
08									58							
09									59							
10									60							
11									61							
12									62							
13									63							
14									64							
15									65							
16									66							
17									67							
18									68							
19									69							
20									70							
21									71							
22									72							
23									73							
24									74							
25									75							
26									76							
27									77							
28									78							
29									79							
30									80							
31									81							
32									82							
33									83							
34									84							
35									85							
36									86							
37									87							
38									88							
39									89							
40									90							
41									91							
42									92							
43									93							
44									94							
45									95							
46									96							
47									97							
48									98							
49									99							

TOLL RESTRICTION-OFFICE CODE TABLE

Office Code Table No. ____ (01 to 64)

2 Hundred (200 to 249)									2 Hundred (200 to 249)								
	200	300	400	500	600	700	800	900		200	300	400	500	600	700	800	900
00									50								
01									51								
02									52								
03									53								
04									54								
05									55								
06									56								
07									57								
08									58								
09									59								
10									60								
11									61								
12									62								
13									63								
14									64								
15									65								
16									66								
17									67								
18									68								
19									69								
20									70								
21									71								
22									72								
23									73								
24									74								
25									75								
26									76								
27									77								
28									78								
29									79								
30									80								
31									81								
32									82								
33									83								
34									84								
35									85								
36									86								
37									87								
38									88								
39									89								
40									90								
41									91								
42									92								
43									93								
44									94								
45									95								
46									96								
47									97								
48									98								
49									99								

TOLL RESTRICTION-OFFICE CODE TABLE

Office Code Table No. ____ (01 to 64)

	2 Hundred (200 to 249)									2 Hundred (200 to 249)							
	200	300	400	500	600	700	800	900		200	300	400	500	600	700	800	900
00									50								
01									51								
02									52								
03									53								
04									54								
05									55								
06									56								
07									57								
08									58								
09									59								
10									60								
11									61								
12									62								
13									63								
14									64								
15									65								
16									66								
17									67								
18									68								
19									69								
20									70								
21									71								
22									72								
23									73								
24									74								
25									75								
26									76								
27									77								
28									78								
29									79								
30									80								
31									81								
32									82								
33									83								
34									84								
35									85								
36									86								
37									87								
38									88								
39									89								
40									90								
41									91								
42									92								
43									93								
44									94								
45									95								
46									96								
47									97								
48									98								
49									99								

TOLL RESTRICTION-OFFICE CODE TABLE

Office Code Table No. ____ (01 to 64)

	2 Hundred (200 to 249)									2 Hundred (200 to 249)							
	200	300	400	500	600	700	800	900		200	300	400	500	600	700	800	900
00									50								
01									51								
02									52								
03									53								
04									54								
05									55								
06									56								
07									57								
08									58								
09									59								
10									60								
11									61								
12									62								
13									63								
14									64								
15									65								
16									66								
17									67								
18									68								
19									69								
20									70								
21									71								
22									72								
23									73								
24									74								
25									75								
26									76								
27									77								
28									78								
29									79								
30									80								
31									81								
32									82								
33									83								
34									84								
35									85								
36									86								
37									87								
38									88								
39									89								
40									90								
41									91								
42									92								
43									93								
44									94								
45									95								
46									96								
47									97								
48									98								
49									99								

TOLL RESTRICTION-OFFICE CODE TABLE

Office Code Table No. ____ (01 to 64)

—— 2 Hundred (200 to 249)

—— 2 Hundred (200 to 249)

2 Hundred (200 to 249)								2 Hundred (200 to 249)							
200	300	400	500	600	700	800	900	200	300	400	500	600	700	800	900
00								50							
01								51							
02								52							
03								53							
04								54							
05								55							
06								56							
07								57							
08								58							
09								59							
10								60							
11								61							
12								62							
13								63							
14								64							
15								65							
16								66							
17								67							
18								68							
19								69							
20								70							
21								71							
22								72							
23								73							
24								74							
25								75							
26								76							
27								77							
28								78							
29								79							
30								80							
31								81							
32								82							
33								83							
34								84							
35								85							
36								86							
37								87							
38								88							
39								89							
40								90							
41								91							
42								92							
43								93							
44								94							
45								95							
46								96							
47								97							
48								98							
49								99							

TOLL RESTRICTION-OFFICE CODE TABLE

Office Code Table No. ____ (01 to 64)

	2 Hundred (200 to 249)									2 Hundred (200 to 249)							
	200	300	400	500	600	700	800	900		200	300	400	500	600	700	800	900
00									50								
01									51								
02									52								
03									53								
04									54								
05									55								
06									56								
07									57								
08									58								
09									59								
10									60								
11									61								
12									62								
13									63								
14									64								
15									65								
16									66								
17									67								
18									68								
19									69								
20									70								
21									71								
22									72								
23									73								
24									74								
25									75								
26									76								
27									77								
28									78								
29									79								
30									80								
31									81								
32									82								
33									83								
34									84								
35									85								
36									86								
37									87								
38									88								
39									89								
40									90								
41									91								
42									92								
43									93								
44									94								
45									95								
46									96								
47									97								
48									98								
49									99								

TOLL RESTRICTION-OFFICE CODE TABLE

Office Code Table No. ____ (01 to 64)

┌── 2 Hundred (200 to 249)

└── 2 Hundred (200 to 249)

	200	300	400	500	600	700	800	900		200	300	400	500	600	700	800	900
00									50								
01									51								
02									52								
03									53								
04									54								
05									55								
06									56								
07									57								
08									58								
09									59								
10									60								
11									61								
12									62								
13									63								
14									64								
15									65								
16									66								
17									67								
18									68								
19									69								
20									70								
21									71								
22									72								
23									73								
24									74								
25									75								
26									76								
27									77								
28									78								
29									79								
30									80								
31									81								
32									82								
33									83								
34									84								
35									85								
36									86								
37									87								
38									88								
39									89								
40									90								
41									91								
42									92								
43									93								
44									94								
45									95								
46									96								
47									97								
49									99								

TOLL RESTRICTION-OFFICE CODE TABLE

Office Code Table No. __ (01 to 64)

	2 Hundred (200 to 249)									2 Hundred (200 to 249)							
	200	300	400	500	600	700	800	900		200	300	400	500	600	700	800	900
00									50								
01									51								
02									52								
03									53								
04									54								
05									55								
06									56								
07									57								
08									58								
09									59								
10									60								
11									61								
12									62								
13									63								
14									64								
15									65								
16									66								
17									67								
18									68								
19									69								
20									70								
21									71								
22									72								
23									73								
24									74								
25									75								
26									76								
27									77								
28									78								
29									79								
30									80								
31									81								
32									a2								
33									a3								
34									a4								
35									85								
36									86								
37									a7								
38									88								
39									a9								
40									90								
41									91								
42									92								
43									93								
44									94								
45									95								
46									96								
47									97								
48									98								
49									99								

TOLL RESTRICTION-OFFICE CODE TABLE

Office Code Table No. ____ (01 to 64)

	2 Hundred (200 to 249)									2 Hundred (200 to 249)							
	200	300	400	500	600	700	800	900		200	300	400	500	600	700	800	900
00									50								
01									51								
02									52								
03									53								
04									54								
05									55								
06									56								
07									57								
08									58								
09									59								
10									60								
11									61								
12									62								
13									63								
14									64								
15								6		5							
16									66								
17									67								
18									68								
19									69								
20									70								
21									71								
22									72								
23									73								
24									74								
25									75								
26									76								
27									77								
28									78								
29									79								
30									80								
31									81								
32									82								
33									83								
34									84								
35									85								
36									86								
37									87								
38									88								
39									89								
40									90								
41									91								
42									92								
43									93								
44									94								
45									95								
46									96								
47									97								
48									98								
49									99								

TOLL RESTRICTION-OFFICE CODE TABLE

Office Code Table No. ____ (01 to 64)

└── 2 Hundred (200 to 249)

└── 2 Hundred (200 to 249)

	200	300	400	500	600	700	800	900		200	300	400	500	600	700	800	900
00									50								
01									51								
02									52								
03									53								
04									54								
05									55								
06									56								
07									57								
08									58								
09									59								
10									60								
11									61								
12									62								
13									63								
14									64								
15									65								
16									66								
17									67								
18									68								
19									69								
20									70								
21									71								
22									72								
23									73								
24									74								
25									75								
26									76								
27									77								
28									78								
29									79								
30									80								
31									81								
32									82								
33									83								
34									84								
35									85								
36									86								
37									87								
38									88								
39									89								
40									90								
41									91								
42									92								
43									93								
44									94								
45									95								
46									96								
47									97								
48									98								
49									99								

TOLL RESTRICTION-OFFICE CODE TABLE

Office Code Table No. ____ (01 to 64)

_____ 2 Hundred (200 to 249)

_____ 2 Hundred (200 to 249)

2 Hundred (200 to 249)							2 Hundred (200 to 249)								
200	300	400	500	600	700	800	900	200	300	400	500	600	700	800	900
00								50							
01								51							
02								52							
03								53							
04								54							
05								55							
06								56							
07								57							
08								58							
09								59							
10								60							
11								61							
12								62							
13								63							
14								64							
15								65							
16								66							
17								67							
18								68							
19								69							
20								70							
21								71							
22								72							
23								73							
24								74							
25								75							
26								76							
27								77							
28								78							
29								79							
30								80							
31								81							
32								82							
33								83							
34								84							
35								85							
36								86							
37								87							
38								88							
39								89							
40								90							
41								91							
42								92							
43								93							
44								94							
45								95							
46								96							
47								97							
48								98							
49								99							

TOLL RESTRICTION-OFFICE CODE TABLE

Office Code Table No. ____ (01 to 64)

	2 Hundred (200 to 249)								2 Hundred (200 to 249)							
	200	300	400	500	600	700	800	900	200	300	400	500	600	700	800	900
00									50							
01									51							
02									52							
03									53							
04									54							
05									55							
06									56							
07									57							
08									58							
09									59							
10									60							
11									61							
12									62							
13									63							
14									64							
15									65							
16									66							
17									67							
18									68							
19									69							
20									70							
21									71							
22									72							
23									73							
24									74							
25									75							
26									76							
27									77							
28									78							
29									79							
30									80							
31									81							
32									82							
33									83							
34									84							
35									85							
36									86							
37									87							
38									88							
39									89							
40									90							
41									91							
42									92							
43									93							
44									94							
45									95							
46									96							
47									97							
48									98							
49									99							

TOLL RESTRICTION-OFFICE CODE TABLE

Office Code Table No. ____ (01 to 64)

	2 Hundred (200 to 249)									2 Hundred (200 to 249)							
	200	300	400	500	600	700	800	900		200	300	400	500	600	700	800	900
00									50								
01									51								
02									52								
03									53								
04									54								
05									55								
06									56								
07									57								
08									58								
09									59								
10									60								
11									61								
12									62								
13									63								
14									64								
15									65								
16									66								
17									67								
18									68								
19									69								
20									70								
21									71								
22									72								
23									73								
24									74								
25									75								
26									76								
27									77								
28									78								
29									79								
30									80								
31									81								
32									82								
33									83								
34									84								
35									85								
36									86								
37									87								
38									88								
39									89								
40									90								
41									91								
42									92								
43									93								
44									94								
45									95								
46									96								
47									97								
48									98								
49									99								

TOLL RESTRICTION-OFFICE CODE TABLE

Office Code Table No. ____ (01 to 64)

	2 Hundred (200 to 249)								2 Hundred (200 to 249)							
	200	300	400	500	600	700	800	900	200	300	400	500	600	700	800	900
00									50							
01									51							
02									52							
03									53							
04									54							
05									55							
06									56							
07									57							
08									58							
09									59							
10									60							
11									61							
12									62							
13									63							
14									64							
15									65							
16									66							
17									67							
18									68							
19									69							
20									70							
21									71							
22									72							
23									73							
24									74							
25									75							
26									76							
27									77	I						
28									78							
29									79							
30									80							
31									a1							
32									a2							
33									a3							
34									a4							
35									85							
36									86							
37									II	a7						
38									88							
39									89							
40									90							
41									91							
42									92							
43									93							
44									94							
45									95							
46									96							
A7									97							
48									98							
49									99							

TOLL RESTRICTION-OFFICE CODE TABLE

Office Code Table No. ____ (01 to 64)

2 Hundred (200 to 249)

2 Hundred (200to 249)

2 Hundred (200 to 249)									2 Hundred (200to 249)								
200	300	400	500	600	700	800	900		200	300	400	500	600	700	800	900	
00								50									
01								51									
02								52									
03	I							53									
04								54									
05								55									
06								56									
07								57	I								
08								58									
09								59									
10								60									
11								61									
12								62									
13								63									
14								64									
15								65									
16								66									
17								67									
18								68									
19								69									
20								70									
21								71									
22								72									
23								73									
24								74									
25							II	75									
26								76									
27								77									
28								78									
29								79									
30								80									
31								81									
32								82									
33								83									
34								84									
35								85									
36								86									
37								87									
38								88									
39								89									
40								90									
41								91									
42								92									
43								93									
44								94									
45								95									
46								96									
47								97									
48								98									
49							99										

TOLL RESTRICTION-OFFICE CODE TABLE

Office Code Table No. ____ (01 to 64)

└── 2 Hundred (200 to 249)

── 2 Hundred (200 to 249)

	200	300	400	500	600	700	800	900		200	300	400	500	600	700	800	900
00									50								
01									51								
02									52								
03									53								
04									54								
05									55								
06									56								
07									57								
08									58								
09									59								
10									60								
11									61								
12									62								
13									63								
14									64								
15									65								
16									66								
17									67								
18									68								
19									69								
20									70								
21									71								
22									72								
23									73								
24									74								
25									75								
26									76								
27									77								
28									78								
29									79								
30									80								
31									81								
32									82								
33									83								
34									84								
35									85								
36									86								
37									87								
38									88								
39									89								
40									90								
41									91								
42									92								
43									93								
44									94								
45									95								
46									96								
47									97								
48									98								
49									99								

TOLL RESTRICTION-OFFICE CODE TABLE

Office Code Table No. ____ (01 to 64)

—— 2 Hundred (200 to 249)

—— 2 Hundred (200 to 249)

2 Hundred (200 to 249)									2 Hundred (200 to 249)								
230	300	400	500	600	700	800	900		200	300	400	500	600	700	800	900	
00								50									
01								51									
02								52									
03								53									
04								54									
05								55									
06								56									
07								57									
08								58									
09								59									
10								60									
11								61									
12								62									
13								63									
14								64									
15								65									
16								66									
17								67									
18								68									
19								69									
20								70									
21								71									
22								72									
23								73									
24								74									
25								75									
26								76									
27								77									
28								78									
29								79									
30								80									
31								81									
32								82									
33								83									
34								84									
35								85									
36								86									
37								87									
38								88									
39								89									
40								90									
41								91									
42								92									
43								93									
44								94									
45								95									
46								96									
47								97									
48								98									
49								99									

TOLL RESTRICTION-OFFICE CODE TABLE

Office Code Table No. ____ (01 to 64)

	2 Hundred (200 to 249)								2 Hundred (200 to 249)							
	200	300	400	500	600	700	800	900	23C	300	400	500	600	700	800	900
00									50							
01									51							
02									52							
03									53							
04									54							
05									55							
06									56							
07									57							
08									58							
09									59							
10									60							
11									61							
12									62							
13									63							
14									64							
15									65							
16									66							
17									67							
18									68							
19									69							
20									70							
21									71							
22									72							
23									73							
24									74							
25									75							
26									76							
27									77							
28									78							
29									79							
30									80							
31									81							
32									82							
33									83							
34									84							
35									85							
36									86							
37									87							
38									88							
39									89							
40									90							
41									91							
42									92							
43									93							
44									94							
45									95							
46									96							
47									97							
48									98							
49									99							

TOLL RESTRICTION-OFFICE CODE TABLE

Office Code Table No. ____ (01 to 64)

_____ 2 Hundred (200 to 249)

_____ 2 Hundred (200 to 249)

	200	300	400	500	600	700	800	900		200	300	400	500	600	700	800	900
00									50								
01									51								
02									52								
03									53								
04									54								
05									55								
06									56								
07	I							II	57			*					
08									58								
09									59								
10									60								
11									61								
12									62								
13									63								
14									64								
15									65								
16									66								
17									67								
18									68								
19									69								
20									70								
21									71								
22									72								
23									73								
24									74								
25									75								
26									76								
27									77								
28									78								
29									79								
30									80								
31									81								
32									82								
33									83								
34									84								
35									85								
36									86								
37									a7								
38									88								
39									a9								
40									90								
41									91								
42									92								
43									93								
44									94								
45									95								
46									96								
47									97								
48									98								
49									99								

TOLL RESTRICTION-OFFICE CODE TABLE

Office Code Table No. ____ (01 to 64)

	2 Hundred (200 to 249)								-2 Hundred (200 to 249)							
	200	300	400	500	600	700	800	900	200	300	400	500	600	700	800	900
00									50							
01									51							
02									52							
03									53							
04									54							
05									55							
06									56							
07									57							
08									58							
09									59							
10									60							
11									61							
12									62							
13									63							
14									64							
15									65							
16									66							
17									67							
18									68							
19									69							
20									70							
21									71							
22									72							
23									73							
24									74							
25									75							
26									76							
27									77							
28									78							
29									79							
30									80							
31									81							
32									82							
33									83							
34									84							
35									85							
36									86							
37									87							
38									88							
39									89							
40									90							
41									91							
42									92							
43									93							
44									94							
45									95							
46									96							
47									97							
48									98							
49									99							

TOLL RESTRICTION-OFFICE CODE TABLE

Office Code Table No. __ (01 to 64)

	2 Hundred (200 to 249)								2 Hundred (200 to 249)							
	200	300	400	500	600	700	800	900	200	300	400	500	600	700	800	900
00									50							
01									51							
02									52							
03									53							
04									54							
05									55							
06									56							
07									57							
08									58							
09									59							
10									60							
11									61							
12									62							
13									63							
14									64							
15									65							
16									66							
17									67							
18									68							
19									69							
20									70							
21									71							
22									72							
23									73							
24									74							
25									75							
26									76							
27									77							
28									78							
29									79							
30									80							
31									81							
32									82							
33									83							
34									84							
35									85							
36									86							
37									87							
38									88							
39									89							
40									90							
41									91							
42									92							
43									93							
44									94							
45									95							
46									96							
47									97							
48									98							
49									99							

TOLL RESTRICTION-OFFICE CODE TABLE

Office Code Table No. ____ (01 to 64)

— 2 Hundred (200 to 249)

-- 2 Hundred (200 to 249)

	200	300	400	500	600	700	800	900		200	300	400	500	600	700	800	900
00									50								
01									51								
02									52								
03									53								
04									54								
05									55								
06									56								
07									57								
08									58								
09									59								
10									60								
11									61								
12									62								
13									63								
14									64								
15									65								
16									66								
17									67								
18									68								
19									69								
20									70								
21									71								
22									72								
23									73								
24									74								
25									75								
26									76								
27									77								
28									78								
29									79								
30									80								
31									81								
32									82								
33									83								
34									84								
35									85								
36									86								
37									87								
38									88								
39									89								
40									90								
41									91								
42									92								
43									93								
44									94								
45									95								
46									96								
47									97								
48									98								
49									99								

TOLL RESTRICTION-OFFICE CODE TABLE

Office Code Table No. __ (01 to 64)

	2 Hundred (200 to 249)								2 Hundred (200 to 249)								
	200	300	400	500	600	700	800	900		200	300	400	500	600	700	800	900
00									50								
01									51								
02									52								
03									53								
04									54								
05									55								
06									56								
07									57								
08									58								
09									59								
10									60								
11									61								
12									62								
13									63								
14									64								
15									65								
16									66								
17									67								
18									68								
19									69								
20									70								
21									71								
22									72								
23									73								
24									74								
25									75								
26									76								
27									77								
28									78								
29									79								
30									80								
31									81								
32									82								
33									83								
34									84								
35									85								
36									86								
37									87								
38									88								
39									89								
40									90								
41									91								
42									92								
43									93								
44									94								
45									95								
46									96								
47									97								
48									98								
49									99								

TOLL RESTRICTION-OFFICE CODE TABLE

Office Code Table No. ____ (01 to 64)

└── 2 Hundred (200 to 249)

└── 2 Hundred (200 to 249)

	2 Hundred (200 to 249)							2 Hundred (200 to 249)								
	200	300	400	500	600	700	800	900	200	300	400	500	600	700	800	900
00									50							
01									51							
02									52							
03									53							
04									54							
05									55							
06									56							
07									57							
08									58							
09									59							
10									60							
11									61							
12									62							
13									63							
14									64							
15									65							
16									66							
17									67							
18									68							
19									69							
20									70							
21									71							
22									72							
23									73							
24									74							
25									75							
26									76							
27									77							
28									78							
29									79							
30									80							
31									81							
32									82							
33									83							
34									84							
35									85							
36									86							
37									87							
38									88							
39									89							
40									90							
41									91							
42									92							
43									93							
44									94							
45									95							
46									96							
47									97							
48									98							
49									99							

TOLL RESTRICTION-OFFICE CODE TABLE

Office Code Table No. ____ (01 to 64)

	2 Hundred (200 to 249)									2 Hundred (200 to 249)							
	200	300	400	500	600	700	800	900		200	300	400	500	600	700	800	900
00									50								
01									51								
02									52								
03									53								
04									54								
05									55								
06									56								
07									57								
08									58								
09									59								
10									60								
11									61								
12									62								
13									63								
14									64								
15									65								
16									66								
17									67								
18									68								
19									69								
20									70								
21									71								
22									72								
23									73								
24									74								
25									75								
26									76								
27									77								
28									78								
29									79								
30									80								
31									81								
32									82								
33									83								
34									84								
35									85								
36									86								
37									87								
38									88								
39									89								
40									90								
41									91								
42									92								
43									93								
44									94								
45									95								
46									96								
47									97								
48									98								
49									99								

TOLL RESTRICTION-OFFICE CODE TABLE

Office Code Table No. ____ (01 to 64)

2 Hundred (200 to 249)

2 Hundred (200 to 249)

	200	300	400	500	600	700	800	900		200	300	400	500	600	700	800	900
00									50								
01									51								
02									52								
03									53								
04									54								
05									55								
06									56								
07									57								
08									58								
09									59								
10									60								
11									61								
12									62								
13									63								
14									64								
15									65								
16									66								
17									67								
18									68								
19									69								
20									70								
21									71								
22									72								
23									73								
24									74								
25									75								
26									76								
27									77								
28									78								
29									79								
30									80								
31									81								
32									82								
33									83								
34									84								
35									85								
36									86								
37									87								
38									88								
39									89								
40									90								
41									91								
42									92								
43									93								
44									94								
45									95								
46									96								
47									97								
48									98								
49									99								

TOLL RESTRICTION-OFFICE CODE TABLE

Office Code Table No. ____ (01 to 64)

_____ 2 Hundred (200 to 249)

_____ 2 Hundred (200 to 249)

	200	300	400	500	600	700	800	900		200	300	400	500	600	700	800	900
00									50								
01									51								
02									52								
03									53								
04									54								
05									55								
06									56								
07									57								
08									58								
09									59								
10									60								
11									61								
12									62								
13																	
14									64								
15									65								
16									66								
17									67								
18									68								
19									69								
20									70								
21									71								
22									72								
23									73								
24									74								
25									75								
26									76								
27									77								
28									78								
29									79								
30									80								
31									81								
32									82								
33									83								
34									84								
35									85								
36									86								
37									87								
38									88								
39									89								
40									90								
41									91								
42									92								
43									93								
44									94								
45									95								
46									96								
47									97								
48									98								
49									99								

TOLL RESTRICTION-OFFICE CODE TABLE

Office Code Table No. ____ (01 to 64)

2 Hundred (200 to 249)

2 Hundred (200 to 249)

00	200	300	400	500	600	700	800	900	50	200	300	400	500	600	700	800	900
01									51								
02									52								
03									53								
04									54								
05									55								
06									56								
07									57								
08									58								
09									59								
10									60								
11									61								
12									62								
13									63								
14									64								
15									65								
16									66								
17									67								
18									68								
19									69								
20									70								
21									71								
22									72								
23									73								
24									74								
25									75								
26									76								
27									77								
28									78								
29									79								
30									80								
31									81								
32									82								
33									83								
34									84								
35									85								
36									86								
37									87								
38									88								
39									89								
40									90								
41									91								
42									92								
43									93								
44									94								
45									95								
46									96								
47									97								
48									98								
49									99								

TOLL RESTRICTION-OFFICE CODE TABLE

Office Code Table No. ____ (01 to 64)

— 2 Hundred (200 to 249)

— 2 Hundred (200 to 249)

	200	300	400	500	600	700	800	900		200	300	400	500	600	700	800	900
00									50								
01									51								
02									52								
03									53								
04									54								
05									55								
06									56								
07									57								
08									58								
09									59								
10									60								
11									61								
12									62								
13									63								
14									64								
15									65								
16									66								
17									67								
18									68								
19									69								
20									70								
21									71								
22									72								
23									73								
24									74								
25									75								
26									76								
27									77								
28									78								
29									79								
30									80								
31									81								
32									82								
33									83								
34									84								
35									85								
36									86								
37									87								
38									88								
39									89								
40									90								
41									91								
42									92								
43									93								
44									94								
45									95								
46									96								
47									97								
48									98								
49									99								

TOLL RESTRICTION-OFFICE CODE TABLE

Office Code Table No. ____ (01 to 64)

	2 Hundred (200 to 249)								2 Hundred (200 to 249,							
	200	300	400	500	600	700	800	900	200	300	400	500	600	700	800	900
00									50							
01									51							
02									52							
03									53							
04									54							
05									55							
06									56							
07									57							
08									58							
09									59							
10									60							
11									61							
12									62							
13									63							
14									64							
15									65							
16									66							
17									67							
18									68							
19									69							
20									70							
21									71							
22									72							
23									73							
24									74							
25									75							
26									76							
27									77							
28									78							
29									79							
30									80							
31									81							
32									82							
33									83							
34									84							
35									85							
36									86							
37									87							
38									88							
39									89							
40									90							
41									91							
42									92							
43									93							
44									94							
45									95							
46									96							
47									97							
48									98							
49									99							

TOLL RESTRICTION-OFFICE CODE TABLE

Office Code Table No. ____ (01 to 64)

	2 Hundred (200 to 249)									2 Hundred (200 to 249)							
	200	300	400	500	600	700	800	900		200	300	400	500	600	700	800	900
00									50								
01									51								
02									52								
03									53								
04									54								
05									55								
06									56								
07									II 57 I								
08									58								
09									59								
10									60								
11									61								
12									62								
13									63								
14									64								
15									65								
16									66								
17									67								
18									68								
19									69								
20									70								
21									71								
22									72								
23									73								
24									74								
25									75								
26									76								
27									77								
28									78								
29									79								
30									80								
31									81								
32									82								
33									83								
34									84								
35									85								
36									86								
37									87								
38									88								
39									89								
40									90								
41									91								
42									92								
43									93								
44									94								
45									95								
46									96								
47									97								
48									98								
49									99								

TOLL RESTRICTION-OFFICE CODE TABLE

Office Code Table No. ____ (01 to 64)

2 Hundred (200 to 249)								2 Hundred (200 to 249)							
200	300	400	500	600	700	800	900	200	300	400	500	600	700	800	900
00								50							
01								51							
02								52							
03								53							
04								54							
05								55							
06								56							
07								57							
08								58							
09								59							
10								60							
11								61							
12								62							
13								63							
14								64							
15								65							
16								66							
17								67							
18								68							
19								69							
20								70							
21								71							
22								72							
23								73							
24								74							
25								75							
26								76							
27								77							
28								78							
29								79							
30								80							
31								81							
32								82							
33								83							
34								84							
35								85							
36								86							
37								87							
38								88							
39								89							
40								90							
41								91							
42								92							
43								93							
44								94							
45								95							
46								96							
47								97							
48								98							
49								99							

TOLL RESTRICTION-OFFICE CODE TABLE

Office Code Table No. ____ (01 to 64)

	2 Hundred (200to 249)									2 Hundred (200 to 249)								
	200	300	400	500	600	700	800	900	200	300	400	500	600	700	800	900		
00																		
01																		
02																		
03																		
04																		
05																		
06																		
07																		
08																		
09																		
10																		
11																		
12																		
13																		
14																		
15																		
16																		
17																		
18																		
19																		
20																		
21																		
22																		
23																		
24																		
25																		
26																		
27																		
28																		
29																		
30																		
31																		
32																		
33																		
34																		
35																		
36																		
37																		
38																		
39																		
40																		
41																		
42																		
43																		
44																		
45																		
46																		
47																		
48																		
49																		

TOLL RESTRICTION-OFFICE CODE TABLE

Office Code Table No. __ (01 to 64)

	2 Hundred (200 to 249)								2 Hundred (200 to 249)							
	200	300	400	500	600	700	800	900	200	300	400	500	600	700	800	900
00									50							
01									51							
02									52							
03									53							
04									54							
05									55							
06									56							
07									57							
08									58							
09									59							
10									60							
11									61							
12									62							
13									63							
14									64							
15									65							
16									66							
17									67							
18									68							
19									69							
20									70							
21									71							
22									72							
23									73							
24									74							
25									75							
26									76							
27									77							
28									78							
29									79							
30									80							
31									81							
32									82							
33									83							
34									84							
35									85							
36									86							
37									87							
38									88							
39									89							
40									90							
41									91							
42									92							
43									93							
44									94							
45									95							
46									96							
47									97							
48									98							
49									99							

TOLL RESTRICTION-OFFICE CODE TABLE

Office Code Table No. ____ (01 to 64)

	2 Hundred (200 to 249)								2 Hundred (200 to 249)							
	200	300	400	500	600	700	800	900	200	300	400	500	600	700	800	900
00									50							
01									51							
02									52							
03									53							
04									54							
05									55							
06									56							
07									57							
08									58							
09									59							
10									60							
11									61							
12									62							
13									63							
14									64							
15									65							
16									66							
17									67							
18									68							
19									69							
20									70							
21									71							
22									72							
23									73							
24									74							
25									75							
26									76							
27									77							
28									78							
29									79							
30									80							
31									81							
32									82							
33									83							
34									84							
35									85							
36									86							
37									87							
38									88							
39									89							
40									90							
41									91							
42									92							
43									93							
44									94							
45									95							
46									96							
47									97							
48									98							
49									99							

TOLL RESTRICTION-OFFICE CODE TABLE

Office Code Table No. ____ (01 to 64)

┌── 2 Hundred (200 to 249)

┌── 2 Hundred (200 to 249)

┌── 2 Hundred (200 to 249)								┌── 2 Hundred (200 to 249)							
200	300	400	500	600	700	800	900	200	300	400	500	600	700	800	900
00								50							
01								51							
02								52							
03								53							
04								54							
05								55							
06								56							
07								57							
08								58							
09								59							
10								60							
11								61							
12								62							
13								63							
14								64							
15								65							
16								66							
17								67							
18								68							
19								69							
20								70							
21								71							
22								72							
23								73							
24								74							
25								75							
26								76							
27								77							
28								78							
29								79							
30								80							
31								81							
32								82							
33								83							
34								84							
35								85							
36								86							
37								87							
38								88							
39								89							
40								90							
41								91							
42								92							
43								93							
44								94							
45								95							
46								96							
47			I					97							
48								98							
49								99							

TOLL RESTRICTION-OFFICE CODE TABLE

Office Code Table No. ____ (01 to 64)

	2 Hundred (200 to 249)							2 Hundred (200 to 249)									
	200	300	400	500	600	700	800	900		200	300	400	500	600	700	800	900
00									50								
01									51								
02									52								
03									53								
04									54								
05									55								
06									56								
07									57								
08									58								
09									59								
10									60								
11									61								
12									62								
13									63								
14									64								
15									65								
16									66								
17									67								
18									68								
19									69								
20									70								
21									71								
22									72								
23									73								
24									74								
25									75								
26									76								
27									77								
28									78								
29									79								
30									80								
31									81								
32									82								
33									83								
34									84								
35									85								
36									86								
37									87								
38									88								
39									89								
40									90								
41									91								
42									92								
43									93								
44									94								
45									95								
46									96								
47									97								
48									98								
49									99								

TOLL RESTRICTION-711 0 DIGIT TOLL RESTRICTION TABLE

Entry No.	Set Data	Default Value	Entry No.	Set Data	Default Value
01	-----	blank	33	-----	blank
02	-----		34	-----	
03	-----		35	-----	
04	-----		36	-----	
05	-----		37	-----	
06	-----		38	-----	
07	-----		39	-----	
08	-----		40	-----	
09	-----		41	-----	
10	-----		42	-----	
11	-----		43	-----	
12	-----		44	-----	
13	-----		45	-----	
14	-----		46	-----	
15	-----		47	-----	
16	-----		48	-----	
17	-----		49	-----	
18	-----		50	-----	
19	-----		51	-----	
20	-----		52	-----	
21	-----		53	-----	
22	-----		54	-----	
23	-----		55	-----	
24	-----		56	-----	
25	-----		57	-----	
26	-----		58	-----	
27	-----		59	-----	
28	-----		60	-----	
29	-----		61	-----	
30	-----		62	-----	
31	-----		63	-----	
32	-----		64	-----	

9. Automatic Route Selection

AUTOMATIC ROUTE SELECTION-LEADING DIGIT TABLE (1 / 7)

Entry No.	Set Data		Default		Entry No.	Set Data		Default		Entry No.	Set Data		Default	
	AC	OC	AC	OC		AC	OC	AC	OC		AC	OC	AC	OC
200	-	-	blank	blank	240	-	-	blank	blank	280	-	-	blank	blank
201	-	-			241	-	-			281	-	-		
202	-	-			242	-	-			282	-	-		
203	-	-			243	-	-			283	-	-		
204	-	-			244	-	-			284	-	-		
205	-	-			245	-	-			285	-	-		
206	-	-			246	-	-			286	-	-		
207	-	-			247	-	-			287	-	-		
208	-	-			248	-	-			288	-	-		
209	-	-			249	-	-			289	-	-		
210	-	-			250	-	-			290	-	-		
211	-	-			251	-	-			291	-	-		
212	-	-			252	-	-			292	-	-		
213	-	-			253	-	-			293	-	-		
214	-	-			254	-	-			294	-	-		
215	-	-			255	-	-			295	-	-		
216	-	-			256	-	-			296	-	-		
217	-	-			257	-	-			297	-	-		
218	-	-			258	-	-			298	-	-		
219	-	-			259	-	-			299	-	-		
220	-	-			260	-	-			300	-	-		
221	-	-			261	-	-			301	-	-		
222	-	-			262	-	-			302	-	-		
223	-	-			263	-	-			303	-	-		
224	-	-			264	-	-			304	-	-		
225	-	-			265	-	-			305	-	-		
226	-	-			266	-	-			306	-	-		
227	-	-			267	-	-			307	-	-		
228	-	-			268	-	-			308	-	-		
229	-	-			269	-	-			309	-	-		
230	-	-			270	-	-			310	-	-		
231	-	-			271	-	-			311	-	-		
232	-	-			272	-	-			312	-	-		
233	-	-			273	-	-			313	-	-		
234	-	-			274	-	-			314	-	-		
235	-	-			275	-	-			315	-	-		
236	-	-			276	-	-			316	-	-		
237	-	-			277	-	-			317	-	-		
238	-	-			278	-	-			318	-	-		
239	-	-			279	-	-			319	-	-		

AUTOMATIC ROUTE SELECTION-LEADING DIGIT TABLE (2/7)

Entry No.	Set Data		Default		Entry No.	Set Data		Default		Entry No.	Set Data		Default	
	AC	OC	AC	OC		AC	OC	AC	OC		AC	OC	AC	OC
320	-	-	blank	blank	360	-	-	blank	blank	400	-	-	blank	blank
321	-	-			361	-	-			401	-	-		
322	-	-			362	-	-			402	-	-		
323	-	-			363	-	-			403	-	-		
324	-	-			364	-	-			404	-	-		
325	-	-			365	-	-			405	-	-		
326	-	-			366	-	-			406	-	-		
327	-	-			367	-	-			407	-	-		
328	-	-			368	-	-			408	-	-		
329	-	-			369	-	-			409	-	-		
330	-	-			370	-	-			410	-	-		
331	-	-			371	-	-			411	-	-		
332	-	-			372	-	-			412	-	-		
333	-	-			373	-	-			413	-	-		
334	-	-			374	-	-			414	-	-		
335	-	-			375	-	-			415	-	-		
336	-	-			376	-	-			416	-	-		
337	-	-			377	-	-			417	-	-		
338	-	-			378	-	-			418	-	-		
339	-	-			379	-	-			419	-	-		
340	-	-			380	-	-			420	-	-		
341	-	-			381	-	-			421	-	-		
342	-	-			382	-	-			422	-	-		
343	-	-			383	-	-			423	-	-		
344	-	-			384	-	-			424	-	-		
345	-	-			385	-	-			425	-	-		
346	-	-			386	-	-			426	-	-		
347	-	-			387	-	-			427	-	-		
348	-	-			388	-	-			428	-	-		
349	-	-			389	-	-			429	-	-		
350	-	-			390	-	-			430	-	-		
351	-	-			391	-	-			431	-	-		
352	-	-			392	-	-			432	-	-		
353	-	-			393	-	-			433	-	-		
354	-	-			394	-	-			434	-	-		
355	-	-			395	-	-			435	-	-		
356	-	-			396	-	-			436	-	-		
357	-	-			397	-	-			437	-	-		
358	-	-			398	-	-			438	-	-		
359	-	-			399	-	-			439	-	-		

AUTOMATIC ROUTE SELECTION-LEADING DIGIT TABLE (5/7)

Entry No.	Set Data		Default		Entry No.	Set AC	Data o c	Default		Entry No.	Set AC	Data OC	Default	
	AC	OC	AC	OC				AC	OC				AC	OC
680			blank	blank	720			blank	blank	760			blank	blank
681					721					761				
682					722					762				
683					723					763				
684					724					764				
685					725					765				
686					726					766				
687					727					767				
688					728					768				
689					729					769				
690					730					770				
691					731					771				
692					732					772				
693					733					773				
694					734					774				
695					735					775				
696					736					776				
697					737					777				
698					738					778				
699					739					779				
700					740					780				
701					741					781				
702					742					782				
703					743					783				
704					744					784				
705					745					785				
706					746					786				
707					747					787				
708					748					788				
709					749					789				
710					750					790				
711					751					791				
712					752					792				
713					753					793				
714					754					794				
715					755					795				
716					756					796				
717					757					797				
718					758					798				
719					759					799				

AUTOMATIC ROUTE SELECTION-LEADING DIGIT TABLE (617)

Entry No.	Set Data		Default		Entry No.	Set Data		Default		Entry No.	Set Data		Default	
	AC	OC	AC	OC		AC	OC	AC	OC		AC	OC	AC	OC
800	-	-	dank	blank	840	-	-	blank	blank	880	-	-	blank	blank
801	-	-			841	-	-			881	-	-		
802	-	-			842	-	-			882	-	-		
803	-	-			843	-	-			883	-	-		
804	-	-			844	-	-			884	-	-		
805	-	-			845	-	-			885	-	-		
806	-	-			846	-	-			886	-	-		
807	-	-			847	-	-			887	-	-		
808	-	-			848	-	-			888	-	-		
809	-	-			849	-	-			889	-	-		
810	-	-			850	-	-			890	-	-		
811	-	-			851	-	-			891	-	-		
812	-	-			852	-	-			892	-	-		
813	-	-			853	-	-			893	-	-		
814	-	-			854	-	-			894	-	-		
815	-	-			855	-	-			895	-	-		
816	-	-			856	-	-			896	-	-		
817	-	-			857	-	-			897	-	-		
818	-	-			858	-	-			898	-	-		
819	-	-			859	-	-			899	-	-		
820	-	-			860	-	-			900	-	-		
821	-	-			861	-	-			901	-	-		
822	-	-			862	-	-			902	-	-		
823	-	-			863	-	-			903	-	-		
824	-	-			864	-	-			904	-	-		
825	-	-			865	-	-			905	-	-		
826	-	-			866	-	-			906	-	-		
827	-	-			867	-	-			907	-	-		
828	-	-			868	-	-			908	-	-		
829	-	-			869	-	-			909	-	-		
830	-	-			870	-	-			910	-	-		
831	-	-			871	-	-			911	-	-		
832	-	-			872	-	-			912	-	-		
833	-	-			873	-	-			913	-	-		
834	-	-			874	-	-			914	-	-		
835	-	-			875	-	-			915	-	-		
636	-	-			876	-	-			916	-	-		
837	-	-			877	-	-			917	-	-		
838	-	-			878	-	-			918	-	-		
839	-	-			879	-	-			919	-	-		

AUTOMATIC ROUTE SELECTION-OFFICE CODE TABLES

Office Code Table No. __ (01 to 32)

Item	Set Data	Default Value
Area Code	- - - (3 digits: 200 to 999, or blank)	blank
Route Plan Table	- - (2 digits: 01 to 32)	01

-- 2 Hundred (200to 249)

2 Hundred (250 to 299)

	203	1300	400	500	600	700	1800	900		200	300	400	500	600	700	800	900
00									50								
01									51								
02									52								
03									53								
04									54								
05									55								
06									56								
07									57								
08									58								
09									59								
10									60								
11									61								
12									62								
13									63								
14									64								
15									65								
16									66								
17									67								
18									68								
19									69								
20									70								
21									71								
22									72								
23									73								
24									74								
25									75								
26									76								
27									77								
28									78								
29									79								
30									80								
31									81								
32									82								
33									83								
34									84								
35									85								
36									86								
37									87								
38									88								
39									89								
40									90								
41									91								
42									92								
43									93								
44									94								
45									95								
46									96								
47									97								
48									98								
49									99								

AUTOMATIC ROUTE SELECTION-OFFICE CODE TABLES

Office Code Table No. ____ (01 to 32)

Item	Set Data	Default Value
Area Code	- - - (3 digits: 200 to 999, or blank)	blank
Route Plan Table	- - (2 digits: 01 to 32)	01

2 Hundred (200 to 249)

2 Hundred (250 to 299)

00	2 Hundred (200 to 249)								2 Hundred (250 to 299)							
	200	300	400	500	600	700	900		50	200	300	400	500	600	700	800
01									50							
02									51							
03									52							
04									53							
05									54							
06									55							
07									56							
08									57							
09									58							
10									59							
11									60							
12									61							
13									62							
14									63							
15									64							
16									65							
17									66							
18									67							
19									68							
20									69							
21									70							
22									71							
23									72							
24									73							
25									74							
26									75							
27									76							
28									77							
29									78							
30									79							
31									80							
32									81							
33									82							
34									83							
35									84							
36									85							
37									86							
38									87							
39									88							
40									89							
41									90							
42									91							
43									92							
44									93							
45									94							
46									95							
47									96							
48									97							
49									98							
									99							

AUTOMATIC ROUTE SELECTION-OFFICE CODE TABLES

Office Code Table No. __ (01 to 32)

Item	Set Data	Default Value
Area Code	____ (3 digits: 200 to 999, or blank)	blank
Route Plan Table	(2 digits: 01 to 32)	01

	2 Hundred (200 to 249)								2 Hundred (250 to 299)							
	200	300	400	500	600	700	800	900	200	300	400	500	600	700	800	900
00									50							
01									51							
02									52							
03									53							
04									54							
05									55							
06									56							
07									57							
08									58							
09									59							
10									60							
11									61							
12									62							
13									63							
14									64							
15									65							
16									66							
17									67							
18									68							
19									69							
20									70							
21									71							
22									72							
23									73							
24									74							
25									75							
26									76							
27									77							
28									78							
29									79							
30									80							
31									81							
32									82							
33									83							
34									84							
35									85							
36									86							
37									87							
38									88							
39									89							
40									90							
41									91							
42									92							
43									93							
44									94							
45									95							
46									96							
47									97							
48									98							
49									99							

AUTOMATIC ROUTE SELECTION-OFFICE CODE TABLES

Office Code Table No. ____ (01 to 32)

Item	Set Data	Default Value
Area Code	____ (3 digits: 200 to 999, or blank)	blank
Route Plan Table	____ (2 digits: 01 to 32)	01

	2 Hundred (200 to 249)								2 Hundred (250 to 299)							
	200	300	400	500	600	700	800	900	200	300	400	500	600	700	800	900
00									50							
01									51							
02									52							
03									53							
04									54							
05									55							
06									56							
07									57							
08									58							
09									59							
10									60							
11									61							
12									62							
13									63							
14									64							
15									65							
16									66							
17									67							
18									68							
19									69							
20									70							
21									71							
22									72							
23									73							
24									74							
25									75							
26									76							
27									77							
28									78							
29									79							
30									80							
31									81							
32									82							
33									83							
34									84							
35									85							
36									86							
37									87							
38									88							
39									89							
40									90							
41									91							
42									92							
43									93							
44									94							
45									95							
46									96							
47									97							
48									98							
49									99							

AUTOMATIC ROUTE SELECTION-OFFICE CODE TABLES

Office Code Table No. ____ (01 to 32)

item	Set Data	Default Value
Area Code	____ (3 digits: 200 to 999, or blank)	blank
Route Plan Table	(2 digits: 01 to 32)	01

	2 Hundred (200 to 249)									2 Hundred (250 to 299)								
	200	300	400	500	600	700	800	900	200	300	400	500	600	700	800	900		
00									50									
01									51									
02									52									
03									53									
04									54									
05									55									
06									56									
07									57									
08									58									
09									59									
10									60									
11									61									
12									62									
13									63									
14									64									
15									65									
16									66									
17									67									
18									68									
19									69									
20									70									
21									71									
22									72									
23									73									
24									74									
25									75									
26									76									
27									77									
28									78									
29									79									
30									80									
31									81									
32									82									
33									83									
34									84									
35									85									
36									86									
37									87									
38									88									
39									89									
40									90									
41									91									
42									92									
43									93									
44									94									
45									95									
46									96									
47									97									
48									98									
49									99									

AUTOMATIC ROUTE SELECTION-OFFICE CODE TABLES

Office Code Table No. ____ (01 to 32)

Item	Set Data	Default Value
Area Code	____ (3 digits: 200 to 999, or blank)	blank
Route Plan Table	- (2 digits: 01 to 32)	01

	2 Hundred (200 to 249)									2 Hundred (250 to 299)								
	200	300	400	500	600	700	800	900	200	300	400	500	600	700	800	900		
00									50									
01									51									
02									52									
03									53									
04									54									
05									55									
06									56									
07									57									
08									58									
09									59									
10									60									
11									61									
12									62									
13									63									
14									64									
15									65									
16									66									
17									67									
18									68									
19									69									
20									70									
21									71									
22									72									
23									73									
24									74									
25									75									
26									76									
27									77									
28									78									
29									79									
30									80									
31									81									
32									82									
33									83									
34									84									
35									85									
36									86									
37									87									
38									88									
39									89									
40									90									
41									91									
42									92									
43									93									
44									94									
45									95									
46									96									
47									97									
48									99									

AUTOMATIC ROUTE SELECTION-OFFICE CODE TABLES

Office Code Table No. ____ (01 to 32)

item	Set Data	Default Value
Area Code	____ (3 digits: 200 to 999, or blank)	blank
Route Plan Table	____ (2 digits: 01 to 32)	01

	2 Hundred (200 to 249)									2 Hundred (250 to 299)								
	200	300	400	500	600	700	800	900		200	300	400	500	600	700	800	900	
00									50									
01									51									
02									52									
03									53									
04									54									
05									55									
06									56									
07									57									
08									58									
09									59									
10									60									
11									61									
12									62									
13									63									
14									64									
15									65									
16									66									
17									67									
18									68									
19									69									
20									70									
21									71									
22									72									
23									73									
24									74									
25									75									
26									76									
27									77									
28									78									
29									79									
30									80									
31									81									
32									82									
33									83									
34									84									
35									85									
36									86									
37									87									
38									88									
39									89									
40									90									
41									91									
42									92									
43									93									
44									94									
45									95									
46									96									
47									97									
48									98									
49									99									

AUTOMATIC ROUTE SELECTION-OFFICE CODE TABLES

Office Code Table No. __ (01 to 32)

Item	Set Data	Default Value
Area Code	. . . (3 digits: 200 to 999, or blank)	blank
Route Plan Table	(2 digits: 01 to 32)	01

-- 2 Hundred (200 to 249)

— 2 Hundred (250 to 299)

	200	300	400	500	600	700	800	900		200	300	400	500	600	700	800	900
00									50								
01									51								
02									52								
03									53								
04									54								
05									55								
06									56								
07									57								
08									58								
09									59								
10									60								
11									61								
12									62								
13									63								
14									64								
15									65								
16									66								
17									67								
18									68								
19									69								
20									70								
21									71								
22									72								
23									73								
24									74								
25									75								
26									76								
27									77								
28									78								
29									79								
30									80								
31									81								
32									82								
33									83								
34									84								
35									85								
36									86								
37									87								
38									88								
39									89								
40									90								
41									91								
42									92								
43									93								
44									94								
45									95								
46									96								
47									97								
48									98								
49									99								

AUTOMATIC ROUTE SELECTION-OFFICE CODE TABLES

Office Code Table No. ____ (01 to 32)

Item	Set Data	Default Value
Area Code	- - - (3 digits: 200 to 999, or blank)	blank
Route Plan Table	- - (2 digits: 01 to 32)	01

	2 Hundred (200 to 249)									2 Hundred (250 to 299)								
	200	300	400	500	600	700	800	900	200	300	400	500	600	700	800	900		
00									50									
01									51									
02									52									
03									53									
04									54									
05									55									
06									56									
07									57									
08									58									
09									59									
10									60									
11									61									
12									62									
13									63									
14									64									
15									65									
16									66									
17									67									
18									68									
19									69									
20									70									
21									71									
22									72									
23									73									
24									74									
25									75									
26									76									
27									77									
28									78									
29									79									
30									80									
31									81									
32									82									
33									83									
34									84									
35									85									
36									86									
37									87									
38									88									
39									89									
40									90									
41									91									
42									92									
43									93									
44									94									
45									95									
46									96									
47									97									
48									98									
49									99									

AUTOMATIC ROUTE SELECTION-OFFICE CODE TABLES

Office Code Table No. ____ (01 to 32)

Item	Set Data	Default Value
Area Code	- - - (3 digits: 200 to 999. or blank)	blank
Route Plan Table	- - (2 digits: 01 to 32)	01

- 2 Hundred (200 to 249)

- 2 Hundred (250 to 299)

	200	300	400	500	600	700	800	900	II	200	300	400	500	600	700	800	900
00									50								
01									51								
02									52								
03									53								
04									54								
05									55								
06									56								
07									57								
08									58								
09									59								
10									60								
11									61								
12									62								
13									63								
14									64								
15									65								
16									66								
17									67								
18									68								
19									69								
20									70								
21									71								
22									72								
23									73								
24									74								
25									75								
26									76								
27									77								
28									78								
29									79								
30									80								
31									81								
32									82								
33									83								
34									84								
35									85								
36									86								
37									87								
38									88								
39									89								
40									90								
41									91								
42									92								
43									93								
44									94								
45									95								
46									96								
47									97								
48									98								
49									99								

AUTOMATIC ROUTE SELECTION-OFFICE CODE TABLES

Office Code Table No. ____ (01 to 32)

Item	Set Data	Default Value
Area Code	____ - ____ (3 digits: 200 to 999, or blank)	blank
Route Plan Table	- ____ - ____ (2 digits: 01 to 32)	01

, ---- 2 Hundred (200 to 249)

|----- 2 Hundred (250 to 299)

	200	300	400	500	600	700	800	900		200	300	400	500	600	700	800	900
00									50								
01									51								
02									52								
03									53								
04									54								
05									55								
06									56								
07									57								
08									58								
09									59								
10									60								
11									61								
12									62								
13									63								
14									64								
15									65								
16									66								
17									67								
18									68								
19									69								
20									70								
21									71								
22									72								
23									73								
24									74								
25									75								
26									76								
27									77								
28									78								
29									79								
30									80								
31									81								
32									82								
33									83								
34									84								
35									85								
36									86								
37									87								
38									88								
39									89								
40									90								
41									91								
42									92								
43									93								
44									94								
45									95								
46									96								
47									97								
AR									98								
49									99								

AUTOMATIC ROUTE SELECTION-OFFICE CODE TABLES

Office Code Table No. ____ (01 to 32)

Item	Set Data	Default Value
Area Code	- - - (3 digits: 200 to 999, or blank)	blank
Route Plan Table	- - d i g i t s : 01 to 32	01

└── 2 Hundred (200 to 249)

└── 2 Hundred (250 to 299)

	200	300	400	500	600	700	800	900		200	300	400	500	600	700	800	900
00									50								
01									51								
02									52								
03									53								
04									54								
05									55								
06									56								
07									57								
08									58								
09									59								
10									60								
11									61								
12									62								
13									63								
14									64								
15									65								
16									66								
17									67								
18									68								
19									69								
20									70								
21									71								
22									72								
23									73								
24									74								
25									75								
26									76								
27									77								
28									78								
29									79								
30									80								
31									81								
32									82								
33									83								
34									84								
35									85								
36									86								
37									87								
38									88								
39									89								
40									90								
41									91								
42									92								
43									93								
44									94								
45									95								
46									96								
47									97								
48									98								
49									99								

AUTOMATIC ROUTE SELECTION-OFFICE CODE TABLES

Office Code Table No. ____ (01 to 32)

Item	Set Data	Default Value
Area Code	. . . (3 digits: 200 to 999, or blank)	blank
Route Plan Table	____ (2 digits: 01 to 32)	01

	2 Hundred (200 to 249)									2 Hundred (250 to 299)								
	200	300	400	500	600	700	800	900	200	300	400	500	600	700	800	900		
00									50									
01									51									
02									52									
03									53									
04									54									
05									55									
06									56									
07									57									
08									58									
09									59									
10									60									
11									61									
12									62									
13									63									
14									64									
15									65									
16									66									
17									67									
18									68									
19									69									
20									70									
21									71									
22									72									
23									73									
24									74									
25									75									
26									76									
27									77									
28									78									
29									79									
30									80									
31									81									
32									82									
33									83									
34									84									
35									85									
36									86									
37									87									
38									88									
39									89									
40									90									
41									91									
42									92									
43									93									
44									94									
45									95									
46									96									
47									97									
48									98									
49									99									

AUTOMATIC ROUTE SELECTION-OFFICE CODE TABLES

Office Code Table No. ____ (01 to 32)

Item	Set Data	Default Value
Area Code	____ (3 digits: 200 to 999. or blank)	blank
Route Plan Table	____ (2 digits: 01 to 32)	01

	2 Hundred (200 to 249)								900	2 Hundred (250 to 299)							
	200	300	400	500	1600	1700	1800			200	300	400	500	600	700	800	900
00									50								
01									51								
02									52								
03									53								
04									54								
05									55								
06									56								
07									57								
08									58								
09									59								
10									60								
11	I								I 61	I							
12									62								
13									63								
14									64								
15									65								
16									66								
17									67								
18									68								
19									69								
20									70								
21									71								
22									72								
23									73								
24									74								
25									75								
26									76								
27									77								
28									78								
29									79								
30									80								
31									81								
32									82								
33									I 83	I							
--									84								
34									85								
35									86								
36									87								
37									88								
38									89								
39									90								
40									91								
41									92								
42									93								
43									94								
44									95								
45									96								
46									97								
47									98								
48									99								
49																	

AUTOMATIC ROUTE SELECTION-OFFICE CODE TABLES

Office Code Table No. ____ (01 to 32)

item	Set Data	Default Value
Area Code	- - - (3 digits: 200 to 999, or blank)	blank
Route Plan Table	- - (2 digits: 01 to 32)	01

└── 2 Hundred (200 to 249)

└── 2 Hundred (250 to 299)

	2 Hundred (200 to 249)					2 Hundred (250 to 299)										
	200	300	400	500	600	700	800	900	200	300	400	500	600	700	800	900
00									50							
01									51							
02									52							
03									53							
04									54							
05									55							
06									56							
07									57							
08									58							
09									59							
10									60							
11									61							
12									62							
13									63							
14									64							
15									65							
16									66							
17									67							
18									68							
19									69							
20									70							
21									71							
22									72							
23									73							
24									74							
25									75							
26									76							
27									77							
28									78							
29									79							
30									80							
31									81							
32									82							
33									83							
34									84							
35									85							
36									86							
37									87							
38									88							
39									89							
40									90							
41									91							
42									92							
43									93							
44									94							
45									95							
46									96							
47									97							
48									98							
49									99							

AUTOMATIC ROUTE SELECTION-OFFICE CODE TABLES

Office Code Table No. ____ (01 to 32)

Item	Set Data	Default Value
Area Code	--- (3 digits : 200 to 999, or blank)	blank
Route Plan Table	(2 digits : 01 to 32)	01

└── 2 Hundred (200 to 249)

└── 2 Hundred (250 to 299)

	200	300	400	500	600	700	800	900		200	300	400	500	600	700	800	900
00							II		50								
01									51								
02									52								
03									53								
04									54								
05									55								
06									56								
07									57								
08									58								
09									59								
10									60								
11									61								
12									62								
13									63								
14									64								
15									65								
16									66								
17									67								
18									68								
19									69								
20									70								
21									71								
22									72								
23									73								
24									74								
25									75								
26									76								
27									77								
28									78								
29									79								
30									80								
31									81								
32									82								
33									83								
34									84								
35									85								
36									86								
37									87								
38									88								
39									89								
40									90								
41									91								
42									92								
43									93								
44									94								
45									95								
46									96								
47									97								
48									98								
49									99								

AUTOMATIC ROUTE SELECTION-OFFICE CODE TABLES

Office Code Table No. ____ (01 to 32)

Item	Set Data	Default Value
Area Code	____ (3 digits: 200 to 999, or blank)	blank
Route Plan Table	- - (2 digits: 01 to 32)	01

	2 Hundred (200 to 249)									2 Hundred (250 to 299)								
	200	300	400	500	600	700	800	900	200	300	400	500	600	700	800	900		
00									50									
01									51									
02									52									
03									53									
04									54									
05									55									
06									56									
07									57									
08									58									
09									59									
10									60									
11									61									
12									62									
13									63									
14									64									
15									65									
16									66									
17									67									
18									68									
19									69									
20									70									
21									71									
22									72									
23									73									
24									74									
25									75									
26									76									
27									77									
28									78									
29									79									
30									80									
31									81									
32									82									
33									83									
34									84									
35									85									
36									86									
37									87									
38									88									
39									89									
40									90									
41									91									
42									92									
43									93									
44									94									
45									95									
46									96									
47									97									
48									98									
49									99									

AUTOMATIC ROUTE SELECTION-OFFICE CODE TABLES

Office Code Table No. ____ (01 to 32)

Item	Set Data	Default Value
Area Code	- - - (3 digits: 200 to 999, or blank)	blank
Route Plan Table	- - (2 digits: 01 to 32)	31

	2 Hundred (200 to 249)									2 Hundred (250 to 299)							
	200	300	400	500	600	700	800	900		200	300	400	500	600	700	800	900
00									50								
01									51								
02									52								
03									53								
04									54								
05									55								
06									56								
07									57								
08									58								
09									59								
10									60								
11									61								
12									62								
13									63								
14									64								
15									65								
16									66								
17									67								
18									68								
19									69								
20									70								
21									71								
22									72								
23									73								
24									74								
25									75								
26									76								
27									77								
28									78								
29									79								
30									80								
31									81								
32									82								
33									83								
34									84								
35									85								
36									86								
37									87								
38									88								
39									89								
40									90								
41									91								
42									92								
43									93								
44									94								
45									95								
46									96								
47									97								
48									98								
49									99								

AUTOMATIC ROUTE SELECTION-OFFICE CODE TABLES

Office Code Table No. ____ (01 to 32)

item	Set Data	Default Value
Area Code	____ (3 digits: 200 to 999, or blank)	blank
Route Plan Table	- - ____ (2 digits: 01 to 32)	01

└── 2 Hundred (200 to 249)

└── 2 Hundred (250 to 299)

	2 Hundred (200 to 249)									2 Hundred (250 to 299)								
	200	300	400	500	600	700	800	900		200	300	400	500	600	700	800	900	
00									50									
01									51									
02									52									
03									53									
04									54									
05									55									
06									56									
07									57									
08									58									
09									59									
10									60									
11									61									
12									62									
13									63									
14									64									
15									65									
16									66									
17									67									
18									68									
19									69									
20									70									
21									71									
22									72									
23									73									
24									74									
25									75									
26									76									
27									77									
28									78									
29									79									
30									80									
31									81									
32									82									
33									83									
34									84									
35									85									
36									86									
37									87									
38									88									
39									89									
40									90									
41									91									
42									92									
43									93									
44									94									
45									95									
46									96									
47									97									
48									98									
49									99									

AUTOMATIC ROUTE SELECTION-OFFICE CODE TABLES

Office Code Table No. ____ (01 to 32)

Item	Set Data ____	Default Value
Area Code	____ (3 digits: 200 to 999, or blank)	blank
Route Plan Table	____ (2 digits: 01 to 32)	01

└── 2 Hundred (200 to 249)

└── 2 Hundred (250 to 299)

	2 Hundred (200 to 249)									2 Hundred (250 to 299)								
	200	300	400	500	600	700	800	900	200	300	400	500	600	700	800	900		
00									50									
01									51									
02									52									
03									53									
04									54									
05									55									
06									56									
07									57									
08									58									
09									59									
10									60									
11									61									
12									62									
13									63									
14									64									
15									65									
16									66									
17									67									
18									68									
19									69									
20									70									
21									71									
22									72									
23									73									
24									74									
25									75									
26									76									
27									77									
28									78									
29									79									
30									80									
31									81									
32									82									
33									83									
34									84									
35									85									
36									86									
37									87									
38									88									
39									89									
40									90									
41									91									
42									92									
43									93									
44									94									
45									95									
46									96									
47									97									
48									98									
49									99									

AUTOMATIC ROUTE SELECTION-OFFICE CODE TABLES

Office Code Table No. ____ (01 to 32)

Item	Set Data	Default Value
Area Code	- - - (3 digits: 200 to 999, or blank)	blank
Route Plan Table	- - (2 digits: 01 to 32)	01

; 2 Hundred (200 to 249)

2 Hundred (250 to 299)

	200	300	400	500	600	700	800	900		200	300	400	500	600	700	800	900
00									50								
01									51								
02									52								
03									53								
04									54								
05									55								
06									56								
07									57								
08									58								
09									59								
10									60								
11									61								
12									62								
13									63								
14									64								
15									65								
16									66								
17									67								
18									68								
19									69								
20									70								
21									71								
22									72								
23									73								
24									74								
25									75								
26									76								
27									77								
28									78								
29									79								
30									80								
31									81								
32									82								
33									83								
34									84								
35									85								
36									86								
37									87								
38									88								
39									89								
40									90								
41									91								
42									92								
43									93								
44									94								
45									95								
46									96								
47									97								
48									98								
49									99								

AUTOMATIC ROUTE SELECTION-OFFICE CODE TABLES

Office Code Table No. ____ (01 to 32)

Item	Set Data	Default Value
Area Code	- - - (3 digits: 230 to 999, or blank)	blank
Route Plan Table	- - (2 digits: 01 to 32)	01

└── 2 Hundred (200 to 249)

└── 2 Hundred (250 to 299)

	200	300	400	500	600	700	900		200	300	400	500	600	700	800	900
00									50							
01									51							
02									52							
03									53							
04									54							
05									55							
06									56							
07									57							
08									58							
09									59							
10									60							
11									61							
12									62							
13									63							
14									64							
15									65							
16									66							
17									67							
18									68							
19									69							
20									70							
21									71							
22									72							
23									73							
24									74							
25									75							
26									76							
27									77							
28									78							
29									79							
30									80							
31									81							
32									82							
33									83							
34									84							
35									85							
36									86							
37									87							
38									88							
39									89							
40									90							
41									91							
42									92							
43									93							
44									94							
45									95							
46									96							
47									97							
48									98							
49									99							

AUTOMATIC ROUTE SELECTION-OFFICE CODE TABLES

Office Code Table No. __ (01 to 32)

item	Set Data	Default Value
Area Code	- - - (3 digits: 200 to 999, or blank)	blank
Route Plan Table	- - (2 digits: 01 to 32)	01

	2 Hundred (200 to 249)									2 Hundred (250 to 299)								
	200	300	400	500	600	700	800	900		200	300	400	500	600	700	800	900	
00									50									
01									51									
02									52									
03									53									
04									54									
05									55									
06									56									
07									57									
08									58									
09									59									
10									60									
11									61									
12									62									
13									63									
14									64									
15									65									
16									66									
17									67									
18									68									
19									69									
20									70									
21									71									
22									72									
23									73									
24									74									
25									75									
26									76									
27									77									
28									78									
29									79									
30									80									
31									81									
32									82									
33									83									
34									84									
35									85									
36									86									
37									87									
38									88									
39									89									
40									90									
41									91									
42									92									
43									93									
44									94									
45									95									
46									96									
47									97									
48									98									
49									99									

AUTOMATIC ROUTE SELECTION-OFFICE CODE TABLES

Office Code Table No. ____ (01 to 32)

item	Set Data	Default Value
Area Code	- - - 3 digits: 200 to 999. or blank)	blank
Route Plan Table	____ (2 digits: 01 to 32)	01

	2 Hundred (200 to 249)								2 Hundred (250 to 299)							
	200	300	400	1500	600	700	800	900	200	300	400	500	600	700	800	900
00									50							
01									51							
02									52							
03									53							
04									54							
05									55							
06									56							
07									57							
08									58							
09									59							
10									60							
11									61							
12									62							
13									63							
14									64							
15									65							
16									66							
17									67							
18									68					v	-	t
19									69							
20									70							
21									71							
22									72							
23									73							
24									74							
25									75							
26									76							
27									77							
28									78							
29									79							
30									80							
31									81							
32									82							
33									83							
34									84							
35									85							
36									86							
37									87							
38									88							
39									89							
40									90							
41									91							
42									92							
43									93							
44									94							
45									95							
46									96							
47									97							
48									98							
49									99							

AUTOMATIC ROUTE SELECTION-OFFICE CODE TABLES

Office Code Table No. ____ (01 to 32)

Item	Set Data	Default Value
Area Code	- - - (3 digits: 200 to 999, or blank)	blank
Route Plan Table	- - (2 digits: 01 to 32)	01

	2 Hundred (200 to 249)									2 Hundred (250 to 299)								
	200	300	400	500	600	700	800	900		200	300	400	500	600	700	800	900	
00									50									
01									51									
02									52									
03									53									
04									54									
05									55									
06									56									
07									57									
08									58									
09									59									
10									60									
11									61									
12									62									
13									63									
14									64									
15									65									
16									66									
17									67									
18									68									
19									69									
20									70									
21									71									
22									72									
23									73									
24									74									
25									75									
26									76									
27									77									
28									78									
29									79									
30									80									
31									81									
32									82									
33									83									
34									84									
35									85									
36									86									
37									87									
38									88									
39									89									
40									90									
41									91									
42									92									
43									93									
44									94									
45									95									
46									96									
47									97									
48									98									
49									99									

AUTOMATIC ROUTE SELECTION-ROUTE PLAN TABLES (116)

Route Plan Table No.	Start Hour		Route List Number							
	Hour	AM/PM	MON.	TUE.	WED.	THU.	FRI.	SAT.	SUN.	
01	____ <input type="checkbox"/> AM, <input type="checkbox"/> PM <input type="checkbox"/> AM, ____ ____ <input type="checkbox"/> AM, <input type="checkbox"/> PM <input type="checkbox"/> AM, <input type="checkbox"/> PM	____ <input type="checkbox"/> AM, <input type="checkbox"/> PM ____ <input type="checkbox"/> AM, <input type="checkbox"/> PM <input type="checkbox"/> AM, <input type="checkbox"/> PM	____ ____ ____ 	____ ____ ____ 	____ ____ ____ 	____ ____ ____ 	____ ____ ____ 	____ ____ ____ 	____ ____ ____ 	____ ____ ____
02	____ - - • A M u P M ____ ____ <input type="checkbox"/> AM, <input type="checkbox"/> PM <input type="checkbox"/> AM, <input type="checkbox"/> PM	____ <input type="checkbox"/> AM, <input type="checkbox"/> PM ____ <input type="checkbox"/> AM, <input type="checkbox"/> PM <input type="checkbox"/> AM, <input type="checkbox"/> PM								
03	- - • A M . f l P M ____ <input type="checkbox"/> AM, <input type="checkbox"/> PM <input type="checkbox"/> AM, <input type="checkbox"/> PM <input type="checkbox"/> AM, <input type="checkbox"/> PM	____ <input type="checkbox"/> AM, <input type="checkbox"/> PM ____ <input type="checkbox"/> AM, <input type="checkbox"/> PM <input type="checkbox"/> AM, <input type="checkbox"/> PM								
04	____ <input type="checkbox"/> AM, <input type="checkbox"/> PM <input type="checkbox"/> AM, <input type="checkbox"/> PM <input type="checkbox"/> AM, <input type="checkbox"/> PM <input type="checkbox"/> AM, <input type="checkbox"/> PM	____ <input type="checkbox"/> AM, <input type="checkbox"/> PM ____ <input type="checkbox"/> AM, <input type="checkbox"/> PM <input type="checkbox"/> AM, <input type="checkbox"/> PM								
05	____ <input type="checkbox"/> AM, <input type="checkbox"/> PM <input type="checkbox"/> AM, <input type="checkbox"/> PM <input type="checkbox"/> AM, <input type="checkbox"/> PM <input type="checkbox"/> AM, <input type="checkbox"/> PM	____ <input type="checkbox"/> AM, <input type="checkbox"/> PM ____ <input type="checkbox"/> AM, <input type="checkbox"/> PM <input type="checkbox"/> AM, <input type="checkbox"/> PM								
06	____ <input type="checkbox"/> AM, <input type="checkbox"/> PM <input type="checkbox"/> AM, <input type="checkbox"/> PM <input type="checkbox"/> AM, <input type="checkbox"/> PM <input type="checkbox"/> AM, <input type="checkbox"/> PM	____ <input type="checkbox"/> AM, <input type="checkbox"/> PM ____ <input type="checkbox"/> AM, <input type="checkbox"/> PM <input type="checkbox"/> AM, <input type="checkbox"/> PM								

Note:

	Selection of value	Default value
Start Hour	blank, 2 digits (01 to 12), AM/PM	blank
Route List Number	blank, 2 digits (01 to 64)	blank

- Route list number corresponding to the **ap**-pointed time must be set up. No blanks should be appointed in the Route list.
- When blank is set up, all that line have to be blank.

AUTOMATIC ROUTE SELECTION-ROUTE PLAN TABLES (216)

Route Plan Table No.	Stat-I Hour		Route List Number						
	Hour	AM/PM	MON.	TUE.	WED.	THU.	FRI.	SAT.	SUN.
07	-	<input type="checkbox"/> AM, <input type="checkbox"/> PM		---	---	---			
	-	<input type="checkbox"/> AM, <input type="checkbox"/> PM		---	---	---			
	-	<input type="checkbox"/> AM, <input type="checkbox"/> PM	---	---	---	---			
	<input type="checkbox"/> AM, <input type="checkbox"/> PM	<input type="checkbox"/> PM		---	---	---			
08	---	<input type="checkbox"/> AM, <input type="checkbox"/> PM	---	---	---	---			
	---	<input type="checkbox"/> AM, <input type="checkbox"/> PM	---	---	---	---			
	---	<input type="checkbox"/> AM, <input type="checkbox"/> PM	---	---	---	---			
	---	<input type="checkbox"/> AM, <input type="checkbox"/> PM	---	---	---	---			
09		<input type="checkbox"/> AM, <input type="checkbox"/> PM		---	---	---			
		<input type="checkbox"/> AM, <input type="checkbox"/> PM		---	---	---			
		<input type="checkbox"/> AM, <input type="checkbox"/> PM		---	---	---			
		<input type="checkbox"/> AM, <input type="checkbox"/> PM	---	---	---	---			
10		---	<input type="checkbox"/> AM, <input type="checkbox"/> PM	---	---	---			
	<input type="checkbox"/> AM, <input type="checkbox"/> PM	<input type="checkbox"/> PM		---	---	---			
		<input type="checkbox"/> AM, <input type="checkbox"/> PM		---	---	---			
		<input type="checkbox"/> AM, <input type="checkbox"/> PM	---	---	---	---			
11		<input type="checkbox"/> AM, <input type="checkbox"/> PM		---	---	---			
		<input type="checkbox"/> AM, <input type="checkbox"/> PM	---	---	---	---			
		<input type="checkbox"/> AM, <input type="checkbox"/> PM		---	---	---			
		<input type="checkbox"/> AM, <input type="checkbox"/> PM		---	---	---			
12		<input type="checkbox"/> AM, <input type="checkbox"/> PM	---	---	---	---			
		<input type="checkbox"/> AM, <input type="checkbox"/> PM		---	---	---			
		<input type="checkbox"/> AM, <input type="checkbox"/> PM		---	---	---			
		<input type="checkbox"/> AM, <input type="checkbox"/> PM	---	---	---	---			

AUTOMATIC ROUTE SELECTION-ROUTE PLAN TABLES (316)

Route Plan Table No.	Start Hour		Route List Number						
	Hour	AM/PM	MON.	TUE.	WED.	THU.	FRI.	SAT.	SUN.
13	____	<input type="checkbox"/> AM, <input type="checkbox"/> PM	____	____	____	____	____	____	____
	____	<input type="checkbox"/> AM, <input type="checkbox"/> PM	____	____	____	____	____	____	____
	____	<input type="checkbox"/> AM, <input type="checkbox"/> PM	____	____	____	____	____	____	____
			____	____	____	____	____	____	____
14	____	<input type="checkbox"/> AM, <input type="checkbox"/> PM	____	____	____	____	____	____	____
	____	<input type="checkbox"/> AM, <input type="checkbox"/> PM	____	____	____	____	____	____	____
	____	<input type="checkbox"/> AM, <input type="checkbox"/> PM	____	____	____	____	____	____	____
	____	<input type="checkbox"/> AM, <input type="checkbox"/> PM	____	____	____	____	____	____	____
15	<input type="checkbox"/> PM		____	____	____	____	____	____	____
			____	____	____	____	____	____	____
	____		____	____	____	____	____	____	____
		<input type="checkbox"/> AM,	____	____	____	____	____	____	____
16	____	<input type="checkbox"/> AM, <input type="checkbox"/> PM	____	____	____	____	____	____	____
			____	____	____	____	____	____	____
	____	<input type="checkbox"/> AM, <input type="checkbox"/> PM	____	____	____	____	____	____	____
	____	<input type="checkbox"/> AM, <input type="checkbox"/> PM	____	____	____	____	____	____	____
17			____	____	____	____	____	____	____
		<input type="checkbox"/> PM	____	____	____	____	____	____	____
			____	____	____	____	____	____	____
			____	____	____	____	____	____	____
18	____	<input type="checkbox"/> AM, <input type="checkbox"/> PM	____	____	____	____	____	____	____
			____	____	____	____	____	____	____
		<input type="checkbox"/> PM	____	____	____	____	____	____	____
			____	____	____	____	____	____	____

AUTOMATIC ROUTE SELECTION-ROUTE PLAN TABLES (416)

Route Plan Table No.	Start Hour		Route List Number							
	Hour	AM/PM	MON.	TUE.	WED.	THU.	FRI.	SAT.	SUN.	
19	-	-	<input type="checkbox"/> AM, <input type="checkbox"/> PM	---	-	-	-	-	-	-
	-	-	<input type="checkbox"/> AM, <input type="checkbox"/> PM	---	-	-	-	-	-	-
	-	-	<input type="checkbox"/> AM, <input type="checkbox"/> PM	---	-	-	-	-	-	-
	-	-	<input type="checkbox"/> AM, <input type="checkbox"/> PM	---	-	-	-	-	-	-
20	<input type="checkbox"/>	<input type="checkbox"/>	<input type="checkbox"/> AM, <input type="checkbox"/> PM	---	-	-	---	---	---	---
	<input type="checkbox"/>	<input type="checkbox"/>	<input type="checkbox"/> AM, <input type="checkbox"/> PM	---	-	-	---	---	---	---
	-	-	<input type="checkbox"/> AM, <input type="checkbox"/> PM	---	-	-	---	---	---	---
	<input type="checkbox"/>	<input type="checkbox"/>	<input type="checkbox"/> AM, <input type="checkbox"/> PM	---	-	-	---	---	---	---
21	<input type="checkbox"/>	<input type="checkbox"/>	<input type="checkbox"/> AM, <input type="checkbox"/> PM	---	-	-	---	---	---	---
	<input type="checkbox"/>	<input type="checkbox"/>	<input type="checkbox"/> AM, <input type="checkbox"/> PM	---	-	-	---	---	---	---
	<input type="checkbox"/>	<input type="checkbox"/>	<input type="checkbox"/> AM, <input type="checkbox"/> PM	---	-	-	---	---	---	---
	<input type="checkbox"/>	<input type="checkbox"/>	<input type="checkbox"/> AM, <input type="checkbox"/> PM	---	-	-	---	---	---	---
22	<input type="checkbox"/>	<input type="checkbox"/>	<input type="checkbox"/> AM, <input type="checkbox"/> PM	---	-	-	---	---	---	---
	<input type="checkbox"/>	<input type="checkbox"/>	<input type="checkbox"/> AM, <input type="checkbox"/> PM	---	-	-	---	---	---	---
	-	-	<input type="checkbox"/> AM, <input type="checkbox"/> PM	---	-	-	---	---	---	---
	<input type="checkbox"/>	<input type="checkbox"/>	<input type="checkbox"/> AM, <input type="checkbox"/> PM	---	-	-	---	---	---	---
23	<input type="checkbox"/>	<input type="checkbox"/>	<input type="checkbox"/> AM, <input type="checkbox"/> PM	---	-	-	---	---	---	---
	<input type="checkbox"/>	<input type="checkbox"/>	<input type="checkbox"/> AM, <input type="checkbox"/> PM	---	-	-	---	---	---	---
	<input type="checkbox"/>	<input type="checkbox"/>	<input type="checkbox"/> AM, <input type="checkbox"/> PM	---	-	-	---	---	---	---
	<input type="checkbox"/>	<input type="checkbox"/>	<input type="checkbox"/> AM, <input type="checkbox"/> PM	---	-	-	---	---	---	---
24	<input type="checkbox"/>	<input type="checkbox"/>	<input type="checkbox"/> AM, <input type="checkbox"/> PM	---	-	-	---	---	---	---
	<input type="checkbox"/>	<input type="checkbox"/>	<input type="checkbox"/> AM, <input type="checkbox"/> PM	---	-	-	---	---	---	---
	<input type="checkbox"/>	<input type="checkbox"/>	<input type="checkbox"/> AM, <input type="checkbox"/> PM	---	-	-	---	---	---	---
	-	-	<input type="checkbox"/> AM, <input type="checkbox"/> PM	---	-	-	---	---	---	---

AUTOMATIC ROUTE SELECTION-ROUTE PLAN TABLES (516)

Route Plan Table No.	Start Hour		Route List Number						
	Hour	(AM/PM)	MON.	TUE.	WED.	THU.	FRI.	SAT.	SUN.
25	☺ ☀	☺ ☀	---	-	-	---	---	---	---
	-	<input type="checkbox"/> AM, <input type="checkbox"/> PM	---	-	-	---	---	---	---
	<input type="checkbox"/> PM	☺ ☀	---	-	-	---	---	---	---
	☺ ☺	<input type="checkbox"/> AM, <input type="checkbox"/> PM	---	-	-	---	---	---	---
26	☺ ☺	☺ ☺ ☺ ☺	---	-	-	---	---	---	---
	<input type="checkbox"/> PM	<input type="checkbox"/> AM,	---	-	-	---	---	---	---
	☺ ☺	☺ ☺ ☺ ☺	---	-	-	---	---	---	---
	---	<input type="checkbox"/> AM, <input type="checkbox"/> PM	---	-	-	---	---	---	---
27	☺ ☺ ☺	☺ ☺ ☺ ☺ ☺ ☺	---	---	---	---	---	---	---
	---	☺ ☺ ☺ ☺ ☺ ☺	---	---	---	---	---	---	---
	---	☺ ☺ ☺ ☺ ☺ ☺	---	---	---	---	---	---	---
	-	<input type="checkbox"/> AM, <input type="checkbox"/> PM	---	---	---	---	---	---	---
28	<input type="checkbox"/>	☺ ☺ ☺ ☺	---	---	---	---	---	---	---
	<input type="checkbox"/> PM	☺ ☺ ☺	---	---	---	---	---	---	---
	<input type="checkbox"/>	☺ ☺ ☺ ☺	---	---	---	---	---	---	---
	---	☺ ☺ ☺ ☺ ☺ ☺	---	---	---	---	---	---	---
29	☺ ☺	☺ ☺ ☺ ☺	---	---	---	---	---	---	---
	☺ ☺	☺ ☺ ☺ ☺	---	---	---	---	---	---	---
	☺ ☺	☺ ☺ ☺ ☺	---	---	---	---	---	---	---
	☺ ☺	<input type="checkbox"/> AM, <input type="checkbox"/> PM	---	---	---	---	---	---	---
30	☺ ☺	☺ ☺ ☺ ☺	---	---	---	---	---	---	---
	-	<input type="checkbox"/> AM, <input type="checkbox"/> PM	---	---	---	---	---	---	---
	-	0AM, <input type="checkbox"/> PM	---	---	---	---	---	---	---
	-	0AM <input type="checkbox"/> PM	---	---	---	---	---	---	---

AUTOMATIC ROUTE SELECTION-ROUTE LISTS TABLE (2/4)

Route List No	Set Data													
	PRIORITY 1		PRIORITY 2				PRIORITY 3				PRIORITY 4			
	TG	MOD	WT	ALV	TG	MOD	WT	ALV	TG	MOD	WT	ALV	TG	MOD
#15	---	-	<input type="checkbox"/> Yes, <input type="checkbox"/> No	-	-	-	-	-	-	-	-	-	-	-
#16	---	---	<input type="checkbox"/> Yes, <input type="checkbox"/> No	-	-	-	-	-	-	-	-	-	-	-
#17	---	---	<input type="checkbox"/> Yes, <input type="checkbox"/> No	-	-	-	-	-	-	-	-	-	-	-
#18	---	---	<input type="checkbox"/> Yes, <input type="checkbox"/> No	-	-	-	-	-	-	-	-	-	-	-
#19	---	---	<input type="checkbox"/> Yes, <input type="checkbox"/> No	-	-	-	-	-	-	-	-	-	-	-
#20	---	---	<input type="checkbox"/> Yes, <input type="checkbox"/> No	-	-	-	-	-	-	-	-	-	-	-
#21	---	<input type="checkbox"/>	<input type="checkbox"/> Yes, <input type="checkbox"/>	-	-	-	-	-	-	-	-	-	-	-
#22	---	---	<input type="checkbox"/> Yes, <input type="checkbox"/>	-	-	-	-	-	-	-	-	-	-	-
#23	---	---	<input type="checkbox"/> Yes, <input type="checkbox"/> No	-	-	-	-	-	-	-	-	-	-	-
#24	---	<input type="checkbox"/> No	<input type="checkbox"/>	-	-	-	-	-	-	-	-	-	-	-
#25	---	<input type="checkbox"/>	<input type="checkbox"/> Yes, <input type="checkbox"/> No	-	-	-	-	-	-	-	-	-	-	-
#26	---	<input type="checkbox"/>	<input type="checkbox"/> Yes, <input type="checkbox"/>	-	-	-	-	-	-	-	-	-	-	-
#27	---	<input type="checkbox"/>	<input type="checkbox"/> Yes, <input type="checkbox"/>	-	-	-	-	-	-	-	-	-	-	-
#28	---	<input type="checkbox"/>	<input type="checkbox"/> Yes, <input type="checkbox"/>	-	-	-	-	-	-	-	-	-	-	-
#29	---	<input type="checkbox"/>	<input type="checkbox"/> Yes, <input type="checkbox"/>	-	-	-	-	-	-	-	-	-	-	-
#30	---	<input type="checkbox"/>	<input type="checkbox"/> Yes, <input type="checkbox"/>	-	-	-	-	-	-	-	-	-	-	-
#31	---	<input type="checkbox"/>	<input type="checkbox"/> Yes, <input type="checkbox"/>	-	-	-	-	-	-	-	-	-	-	-
#32	---	<input type="checkbox"/> No	<input type="checkbox"/>	-	-	-	-	-	-	-	-	-	-	-
#33	---	---	<input type="checkbox"/>	-	-	-	-	-	-	-	-	-	-	-
#34	---	---	<input type="checkbox"/> Yes, <input type="checkbox"/>	-	-	-	-	-	-	-	-	-	-	-

AUTOMATIC ROUTE SELECTION-ROUTE LISTS TABLE (3/4)

Route List No.	Set Data													
	PRIORITY 1		PRIORITY 2				PRIORITY 3				PRIORITY 4			
	TG	MOD	WT	ALV	TG	MOD	WT	ALV	TG	MOD	WT	ALV	TG	MOD
#35	-	-	<input type="checkbox"/> No_ <input type="checkbox"/> Yes,	---	---	---	<input type="checkbox"/> Yes, <input type="checkbox"/> No	---	-	-	---	<input type="checkbox"/> Yes, <input type="checkbox"/> No	-	-
#36	-	-	<input type="checkbox"/> No_ <input type="checkbox"/> Yes,	---	---	---	<input type="checkbox"/> Yes, <input type="checkbox"/> No	---	-	-	---	<input type="checkbox"/> Yes, <input type="checkbox"/> No	-	-
#37	-	-	---	<input type="checkbox"/> Yes, <input type="checkbox"/> No	---	---	<input type="checkbox"/> Yes, <input type="checkbox"/> No	---	-	-	---	<input type="checkbox"/> Yes, <input type="checkbox"/> No	-	-
#38	-	-	<input type="checkbox"/> No_ <input type="checkbox"/> Yes,	---	---	---	<input type="checkbox"/> Yes, <input type="checkbox"/> No	---	-	-	---	<input type="checkbox"/> Yes, <input type="checkbox"/> No	-	-
#39	-	-	<input type="checkbox"/> Yes, <input type="checkbox"/> No	---	---	---	<input type="checkbox"/> Yes, <input type="checkbox"/> No	---	-	-	---	<input type="checkbox"/> Yes, <input type="checkbox"/> No	-	-
#40	-	-	---	<input type="checkbox"/> Yes, <input type="checkbox"/> No	---	---	<input type="checkbox"/> Yes, <input type="checkbox"/> No	---	-	-	---	<input type="checkbox"/> Yes, <input type="checkbox"/> No	-	-
#41	-	-	<input type="checkbox"/> No_ <input type="checkbox"/> Yes,	---	---	---	<input type="checkbox"/> Yes, <input type="checkbox"/> No	---	-	-	---	<input type="checkbox"/> Yes, <input type="checkbox"/> No	-	-
#42	-	-	---	<input type="checkbox"/> Yes, <input type="checkbox"/> No	---	---	<input type="checkbox"/> Yes, <input type="checkbox"/> No	---	-	-	---	<input type="checkbox"/> Yes, <input type="checkbox"/> No	-	-
#43	-	-	---	<input type="checkbox"/> Yes, <input type="checkbox"/> No	---	---	<input type="checkbox"/> Yes, <input type="checkbox"/> No	---	-	-	---	<input type="checkbox"/> Yes, <input type="checkbox"/> No	-	-
#44	-	-	---	<input type="checkbox"/> Yes, <input type="checkbox"/> No	---	---	<input type="checkbox"/> Yes, <input type="checkbox"/> No	---	-	-	---	<input type="checkbox"/> Yes, <input type="checkbox"/> No	-	-
#45	-	-	---	<input type="checkbox"/> Yes, <input type="checkbox"/> No	---	---	<input type="checkbox"/> Yes, <input type="checkbox"/> No	---	-	-	---	<input type="checkbox"/> Yes, <input type="checkbox"/> No	-	-
#46	-	-	<input type="checkbox"/> Yes, <input type="checkbox"/> No	---	---	---	<input type="checkbox"/> Yes, <input type="checkbox"/> No	---	-	-	---	<input type="checkbox"/> Yes, <input type="checkbox"/> No	-	-
#47	-	-	<input type="checkbox"/> Yes, <input type="checkbox"/> No	---	---	---	<input type="checkbox"/> Yes, <input type="checkbox"/> No	---	-	-	---	<input type="checkbox"/> Yes, <input type="checkbox"/> No	-	-
#48	-	-	<input type="checkbox"/> Yes, <input type="checkbox"/> No	---	---	---	<input type="checkbox"/> Yes, <input type="checkbox"/> No	---	-	-	---	<input type="checkbox"/> Yes, <input type="checkbox"/> No	-	-
#49	-	-	<input type="checkbox"/> No_ <input type="checkbox"/> Yes,	---	---	---	<input type="checkbox"/> Yes, <input type="checkbox"/> No	---	-	-	---	<input type="checkbox"/> Yes, <input type="checkbox"/> No	-	-
#50	-	-	<input type="checkbox"/> No_ <input type="checkbox"/> Yes,	---	---	---	<input type="checkbox"/> Yes, <input type="checkbox"/> No	---	-	-	---	<input type="checkbox"/> Yes, <input type="checkbox"/> No	-	-
#51	-	-	<input type="checkbox"/> No_ <input type="checkbox"/> Yes,	---	---	---	<input type="checkbox"/> Yes, <input type="checkbox"/> No	---	-	-	---	<input type="checkbox"/> Yes, <input type="checkbox"/> No	-	-
#52	-	-	---	<input type="checkbox"/> Yes, <input type="checkbox"/> No	---	---	<input type="checkbox"/> Yes, <input type="checkbox"/> No	---	-	-	---	<input type="checkbox"/> Yes, <input type="checkbox"/> No	-	-
#53	-	-	---	<input type="checkbox"/> Yes, <input type="checkbox"/> No	---	---	<input type="checkbox"/> Yes, <input type="checkbox"/> No	---	-	-	---	<input type="checkbox"/> Yes, <input type="checkbox"/> No	-	-
#54	-	-	---	<input type="checkbox"/> Yes, <input type="checkbox"/> No	---	---	<input type="checkbox"/> Yes, <input type="checkbox"/> No	---	-	-	---	<input type="checkbox"/> Yes, <input type="checkbox"/> No	-	-

AUTOMATIC ROUTE SELECTION-ROUTE LISTS TABLE (4/4)

Route List No.	Set Data															
	PRIORITY 1		PRIORITY 2				PRIORITY 3				PRIORITY 4					
	TG	MOD	WT	ALV	TG	MOD	WT	ALV	TG	MOD	WT	ALV	TG			
#55	---	---	<input type="checkbox"/> Yes, <input type="checkbox"/> No	---	-	-	---	<input type="checkbox"/> Yes, <input type="checkbox"/> No	-	-	-	---	<input type="checkbox"/> Yes, <input type="checkbox"/> No	-	-	---
#56	---	---	<input type="checkbox"/> Yes, <input type="checkbox"/> No	---	-	-	---	<input type="checkbox"/> Yes, <input type="checkbox"/> No	-	-	-	---	<input type="checkbox"/> Yes, <input type="checkbox"/> No	-	-	---
#57	---	---	<input type="checkbox"/> Yes, <input type="checkbox"/> No	---	-	-	---	<input type="checkbox"/> Yes, <input type="checkbox"/> No	-	-	-	---	<input type="checkbox"/> Yes, <input type="checkbox"/> No	-	-	---
#58	---	---	<input type="checkbox"/> Yes, <input type="checkbox"/> No	---	-	-	---	<input type="checkbox"/> Yes, <input type="checkbox"/> No	-	-	-	---	<input type="checkbox"/> Yes, <input type="checkbox"/> No	-	-	---
#59	---	---	<input type="checkbox"/> Yes, <input type="checkbox"/> No	---	-	-	---	<input type="checkbox"/> Yes, <input type="checkbox"/> No	-	-	-	---	<input type="checkbox"/> Yes, <input type="checkbox"/> No	-	-	---
#60	---	---	<input type="checkbox"/> Yes, <input type="checkbox"/> No	---	-	-	---	<input type="checkbox"/> Yes, <input type="checkbox"/> No	-	-	-	---	<input type="checkbox"/> Yes, <input type="checkbox"/> No	-	-	---
#61	---	---	<input type="checkbox"/> Yes, <input type="checkbox"/> No	---	-	-	---	<input type="checkbox"/> Yes, <input type="checkbox"/> No	-	-	-	---	<input type="checkbox"/> Yes, <input type="checkbox"/> No	-	-	---
#62	---	---	<input type="checkbox"/> Yes, <input type="checkbox"/> No	---	-	-	---	<input type="checkbox"/> Yes, <input type="checkbox"/> No	-	-	-	---	<input type="checkbox"/> Yes, <input type="checkbox"/> No	-	-	---
#63	---	---	<input type="checkbox"/> Yes, <input type="checkbox"/> No	---	-	-	---	<input type="checkbox"/> Yes, <input type="checkbox"/> No	-	-	-	---	<input type="checkbox"/> Yes, <input type="checkbox"/> No	-	-	---
#64	---	---	<input type="checkbox"/> Yes, <input type="checkbox"/> No	---	-	-	---	<input type="checkbox"/> Yes, <input type="checkbox"/> No	-	-	-	---	<input type="checkbox"/> Yes, <input type="checkbox"/> No	-	-	---

AUTOMATIC ROUTE SELECTION-MODIFIED DIGIT TABLE (1/2)

Ent. No.	Set Data	
	Del.	Digits to be inserted
01		
02		
03		
04		
05		
06		
07		
08		
09		
10		
11		
12		
13		
14		
15		
16		

Note:

Item	Selection of Value	Default Value
Del.	1 digit (0 to 9) : digit to be deleted	0
Digits to be inserted	maximum 26 digits consisting of numbers, ●, #, and marks below H: Home position, [: Secret (Start) P: Pause,] : Secret (End) D: Switch to DTMF , • : *Secret has to be input as a pair ([]).	blank

• Setting up blanks means all blank.

AUTOMATIC ROUTE SELECTION-MODIFIED DIGIT TABLE (2/2)

Ent. No.	Set Data	
	Del.	Digits to be inserted
17		
18		
19		
20		
21		
22		
23		
24		
25		
26		
27		
28		
29		
30		
31		
32		

10. Special Attended

SPECIAL ATTENDED-UCD (1/2)

UCD No.	FDN		OFDN		OT		UCD No.	FDN		OFDN		OT	
	Set Data	Default Value	Set Data	Default Value	Set Data	Default Value		Set Data	Default Value	Set Data	Default Value	Set Data	Default Value
01	---	blank (no use)	---	blank	---	---	17	---	blank	---	blank	---	blank
02	---		---		---	---	18	---		---		---	
03	---		---		---	---	19	---		---		---	
04	---		---		---	---	20	---		---		---	
05	---		---		---	blank	21	---		---		---	
06	---		---		---		22	---		---		---	
07	---		---		---		23	---		---		---	
08	---		---		---		24	---		---		---	
09	---		---		---		25	---		---		---	
10	---		---		---		26	---		---		---	
11	---		---		---		27	---		---		---	
12	---		---		---		28	---		---		---	
13	---		---		---		29	---		---		---	
14	---		---		---		30	---		---		---	
15	---		---		---		31	---		---		---	
16	---		---		---		32	---		---		---	

10-3

UCD: UCD group

FDN: Floating DN (dial number of 3 or 4 digits, blank)

OFDN: Overflow DN (dial number of 3 or 4 digits, blank)

OT: Overflow Time (1 to 10 minutes)

. Pressing TAB key scrolls the UCD No.

. For UCD No. (01 to 04) following DN can be set up as OFDN.

Extension DN, FDN of another UCD group

external operator FDN

. For UCD No. (05 to 32), same DN as for UCD No. (01 to 04) can be set as OFDN. However FDN of UCD No. (01 to 04) can not be set up.

. Connection of OFDN and OT between UCD No. (05 to 32).

Blank has to be set for both OFDN and OT.

Incomplete setting of OFDN and OT causes error.

SPECIAL ATTENDED-UCD (2/2)

UCD No.	Set Data UCD Time Table	Default Value
1		blank
2		blank
3		blank
4		blank

Remark:

Selection of value for UCD Time Table

1T: 15 sec. timer

2T: 30 sec. timer

3T: 45 sec. timer

4T: 60 sec. timer

01W: If OGM 1 is busy when it is sent out, wait until it becomes idle.

02W: If OGM 2 is busy when it is sent out, wait until it becomes idle.

01S: If OGM 1 is busy when it is sent out, skip to the next command.

02S: If OGM 2 is busy when it is sent out, skip to the next command.

H: Send out the Hold tone.

TR: Transfer to the overflow DN.

OFF: disconnect

11. Miscellaneous

MISCELLANEOUS- POWER FAILURE TRANSFER ASSIGNMENT

No.	Trunk				Extension			
	Set Data	Default Value	Set Data	Default Value	Set Data	Default Value	Set Data	Default Value
	Shelf		Slot		Shelf		Slot	
1	—	blank	— —	blank		blank	— —	blank
2	—		— —				- -	
3	—		— —				- —	
4	—		— —				- -	
5	—		— —				- -	
6	—		— —				- -	
7	—		— —				- -	
8	—		— —				— —	
9	—		— —				- -	
10	—		— —				- -	
11	—		— —				- -	
12	—		— —				- -	
13	—		— —				- -	
14	—		— —				- -	
15	—		— —				- -	
16	—		— —				- -	
17	—		— —				- -	
18	—		— —				— —	

Note:

Item	Selection of Value
Shelf	1 : for Basic shelf 2 : for Expansion shelf t 3 : for Expansion shelf 2 blank : not assigning
Slot	01 to 12 : for Basic shelf 01 to 15 : for Expansion shelf (1 and 2) blank : not assigning