

Panasonic

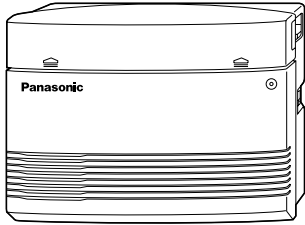

Advanced Hybrid System

User Manual

Model No. **KX-TA624**



Please read this manual before using the Advanced Hybrid System.

Thank you for purchasing this Panasonic Telephone System.

System Components

	Model No.	Description
Service Unit	KX-TA624	Advanced Hybrid System (Main Unit)
Telephone	KX-T7020 KX-T7030 KX-T7130 KX-T7135 KX-T7050 KX-T7055	EMSS Proprietary Telephone EMSS Proprietary Telephone with Display EMSS Proprietary Telephone with Display EMSS Proprietary Telephone with Backlit Display EMSS Proprietary Telephone EMSS Proprietary Telephone
Optional Equipment	KX-T7040	DSS Console
User-supplied Equipment	Single Line Telephones	

For your future reference

SERIAL NO.	_____
(found on the side of the unit)	
DATE OF PURCHASE	_____
NAME OF DEALER	_____
DEALER'S ADDRESS	_____

DEALER'S TEL NO.	_____

Cautions

When using the KX-T7000 series, please note the following:

- If a problem occurs, unplug the extension line and connect to a known working phone. If the known working phone operates properly, have the defective phone repaired by a specified Panasonic Factory Servicenter. If the known working phone does not operate properly, check the Advanced Hybrid System and the internal extension wiring.
- Keep the unit away from heating appliances and electrical noise generating devices such as fluorescent lamps and motors.
- The unit should be kept free of dust, moisture and vibration, and should not be exposed to direct sunlight.
- Do not use benzine, thinner, or any abrasive powder to clean the cabinet. Wipe it with a soft cloth.
- Do not use any handset other than a Panasonic handset.

When you ship the product

Carefully pack and send it prepaid, adequately insured and preferably in the original carton. Attach a postage-paid letter, detailing the symptom, to the outside of the carton. **DO NOT** send the product to the Executive or Regional Sales offices. They are **NOT** equipped to make repairs.

Product service

Panasonic Servicenters for this product are listed in the servicenter directory. Consult with your authorized Panasonic dealer for detailed instructions.

WARNING:

TO PREVENT FIRE OR SHOCK HAZARD, DO NOT EXPOSE THIS PRODUCT TO RAIN OR ANY TYPE OF MOISTURE.

Accessory Order Information

- Replacement parts and accessories are available through your local authorized parts distributor.
- For ordering accessories, call toll free 1-800-332-5368.

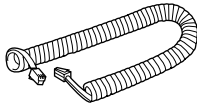
Part No.	Illustration	Description	Dimensions
KX-J07W/B KX-J15W/B KX-J25W/B		Handset cord	213.36 cm {7 feet} 457.2 cm {15 feet} 762 cm {25 feet}

W: White

B : Black

Introduction

Who Should Use This Manual

This manual is designed for users of an Advanced Hybrid System, model number KX-TA624. It is to be used after the system is installed and System Programming is completed. The focus is Proprietary Telephones (PTs); KX-T7020/KX-T7030/KX-T7130/KX-T7135/KX-T7050/KX-T7055, Single Line Telephones (SLTs) and their features. The step-by-step procedures required to activate each feature are explained in detail. Illustrations of the KX-TA624 system and the required System Programming are provided separately in the Installation Manual.

How to Use This Manual

This manual consists of the following sections.

(Section 1) PT Overview

Provides configuration information on PTs. It also provides an illustration of each telephone, identifies their feature buttons, supplies background information on these feature buttons, and gives the initial settings.

(Section 2) Station Programming (Personal Programming)

Provides the steps required to assign features to PT flexible buttons and to the PT system.

(Section 3) Telephone Features

Provides background information on the PT and SLT features and lists the steps required to activate each feature.

(Section 4) DSS Console Features (KX-T7040)

Provides background information on the DSS Console features and lists the steps required to activate each feature.

(Section 5) Appendix

Provides PT Display Examples, a Feature Number List, Tone List, and other information.

Introduction

Features and Capabilities

KX-TA624 is a sophisticated and powerful system which fulfills your expectations of an office communications system. Some of the special features are listed below.

- **Automatic Callback Busy (Camp-On)** informs you when the selected outside (CO) line or the called party becomes idle.
- **Call Log, Incoming (— Option)** allows you to confirm the incoming outside call information on the display. You can also call back the caller by selecting one of the logged numbers. This feature is available only for the KX-T7030, KX-T7130 and KX-T7135.
- **Conference, Unattended** allows you to leave a conference and let the other two parties continue a conversation when you are in a conference with two outside parties. You can also return to the conference.
- **Data Line Security** prohibits various tones, such as a call waiting tone or hold recall tone, from sounding at an extension in the data communication mode. It also blocks overriding by other extensions, such as Executive Busy Override.
- **Direct Inward System Access (DISA)** allows external callers to call extensions in the system. If an optional card is installed, an outgoing message will greet the caller and give information about how to access an extension.
- **Doorphone and Door Opener (— Option)** enables a conversation between you and a visitor at the door. You can also unlock the door for a few seconds from your phone.
- **Executive Busy Override** allows you to enter into an existing conversation at an extension/outside (CO) line.
- **Message Waiting** allows you to leave a message notice for another extension. The message waiting lamp (MESSAGE indicator) gives visual indication that a message has been received.
- **Paralleled Telephone Connection** allows you to connect your PT in parallel with a single line telephone. Each telephone can have the same extension number so that you can use either telephone.
- **Voice Mail Integration (— Option)** has been upgraded to “APT Integration”. In addition to standard services (Custom Service, Automated Attendant Service, Voice Mail Service, Interview Service) for outside callers, proprietary telephone users can take advantage of:
 - ◆ Live Call Screening — you can monitor incoming calls like you would with a telephone answering machine. Take the call or let the caller leave a message.
 - ◆ Two-Way Recording — you can record conversations into your mailbox or someone else’s mailbox.
 - ◆ Voice Mail Transfer — you can easily transfer a caller to a mailbox.

Introduction

Terms Used in the Descriptions

Feature Numbers

A feature number is an access code for various features when programming or executing features using proprietary or single line telephones connected to the system. You can access available features by dialing the corresponding feature number (and additional parameter, if required).

The lists of feature numbers are shown in the Appendix (Section 5).

If you use a rotary telephone;

It is not possible to access features that have “*” or “#” in their feature numbers.

Tones

Various tone types, such as a Confirmation tone, Dial tone, Call Waiting tone, etc. are explained in the Appendix (Section 5).

Display

The PT display examples are given in each operation step, if required. The display information list is in the Appendix for your reference.

Programming References

The related and required programming titles are noted for your reference.

System Programming should be done by the extension which is connected to jack number 01. A KX-T7030, KX-T7130 and KX-T7135 can be used for this programming. Station Programming is individual programming at your own proprietary telephone (PT). You can customize the extension to your needs using any type of proprietary telephone.

Feature References

The related feature titles are noted for your reference.

Table of Contents

Section 1 PT Overview 1-1

1.1 Configuration 1-2

Location of Controls	1-3
Feature Buttons	1-8
Fixed Buttons	1-8
Flexible Buttons	1-10
Line Access Buttons	1-11
Group-CO (G-CO) Button	1-11
Other-CO (O-CO) Button	1-12
Single-CO (S-CO) Button	1-12
Initial Settings	1-13
Display Contrast Adjustment (KX-T7030, KX-T7130 and KX-T7135 only)	1-13
When using the headset (KX-T7030, KX-T7130 and KX-T7135 only)	1-13
Volume Control — Handset Receiver/Headset/Ringer/Speaker	1-14
LED Indication	1-15

Section 2 Station Programming (Personal Programming) 2-1

2.1 Station Programming Instructions 2-2

2.2 Station Programming (Personal Programming) 2-6

Call Waiting Tone Type Assignment	2-6
Flexible Button Assignment	2-7
Another Extension Message Waiting Button	2-7
Caller ID Indication Button	2-8
Caller ID Selection Button	2-9
Conference (CONF) Button	2-10
Direct Station Selection (DSS) Button	2-11
FWD/DND Button	2-12
Group-CO (G-CO) Button	2-12
Live Call Screening (LCS) Button	2-13
Live Call Screening (LCS) Cancel Button	2-14
Log-In/Log-Out Button	2-15
One-Touch Dialing Button	2-16
Other-CO (O-CO) Button	2-17
Return to Message Waiting (MESSAGE) Button	2-17
SAVE Button	2-18
Single-CO (S-CO) Button	2-19
Two-Way Record Button	2-20

Table of Contents

Two-Way Transfer Button	2-21
Voice Mail (VM) Transfer Button	2-22
Intercom Alert Assignment	2-23
Live Call Screening Mode Set	2-24
Outside (CO) Line Ringing Selection	2-25
Preferred Line Assignment — Incoming	2-26
No Line Preference — Incoming	2-26
Ringing Line Preference — Incoming	2-27
Prime Line Preference — Incoming	2-27
Preferred Line Assignment — Outgoing	2-28
No Line Preference — Outgoing	2-28
Idle Line Preference — Outgoing	2-29
Prime Line Preference — Outgoing	2-29
Self-Extension Number Confirmation (KX-T7030, KX-T7130 and KX-T7135 only)	2-30
Station Programming Data Default Set	2-31

Section 3 Telephone Features 3-1

3.1 Basic Operations 3-2

Making Calls	3-2
Intercom Calling	3-2
Outward Dialing	3-2
Receiving Calls	3-3

3.2 Telephone Features 3-4

A

Absent Message Capability	3-4
Account Code Entry	3-7
Answering, Direct Outside (CO) Line	3-9
Automatic Callback Busy (Camp-On)	3-10

B

Background Music (BGM)	3-12
Busy Station Signaling (BSS)	3-13

C

Call Forwarding — SUMMARY	3-14
Call Forwarding — All Calls	3-15
Call Forwarding — Busy/No Answer	3-16
Call Forwarding — to an Outside (CO) Line	3-17
Call Forwarding — Follow Me	3-18

Table of Contents

Call Forwarding — CANCEL	3-19
Call Hold	3-20
Call Hold, Exclusive	3-22
Call Hold Retrieve	3-23
Call Information/Log, Incoming	3-24
Call Log, Incoming	3-26
Call Log Lock, Incoming in the Personal Area	3-31
Call Park	3-32
Call Pickup, Directed	3-34
Call Pickup, Group	3-35
Call Pickup Deny	3-36
Call Retrieving from a TAM (Telephone Answering Machine)	3-37
Call Splitting	3-38
Call Transfer — to Extension	3-39
Call Transfer — to an Outside (CO) Line	3-42
Call Waiting	3-43
Call Waiting from a Central Office	3-46
Caller ID Call Waiting	3-47
Conference	3-49
Conference, Unattended	3-52
D	
Data Line Security	3-53
Direct Inward System Access (DISA)	3-54
Do Not Disturb (DND)	3-58
Do Not Disturb (DND) Override	3-59
Door Opener	3-60
Doorphone Call	3-62
E	
Electronic Station Lockout	3-64
Emergency Call	3-66
Executive Busy Override — Extension	3-67
Executive Busy Override — Outside (CO) Line	3-68
Executive Busy Override Deny	3-69
External Feature Access	3-70
F	
Flash	3-71

Table of Contents

H

Hands-free Answerback (— for KX-T7020/KX-T7030/KX-T7130/KX-T7135 only)	3-72
Hands-free Operation (— for KX-T7020/KX-T7030/KX-T7130/KX-T7135 only)	3-73

I

Intercom Calling	3-74
------------------------	------

L

Live Call Screening (LCS)	3-75
Lockout	3-81
Log-In/Log-Out	3-81

M

Message Waiting	3-83
Message Waiting for Another Extension	3-86
Message Waiting for Another Extension Lock	3-88
Microphone Mute (— for KX-T7020/KX-T7030/KX-T7130/KX-T7135 only)	3-89
Mixed Station Dialing	3-89

O

One-Touch Dialing	3-90
Operator Call	3-91
Outward Dialing, Line Access — SUMMARY	3-92
Line Access, Automatic	3-93
Line Access, Individual	3-94
Line Access, Outside (CO) Line Group	3-94

P

Paging — SUMMARY	3-95
Paging — All	3-96
Paging — External	3-96
Paging — Group	3-97
Paging — ANSWER	3-98
Paging and Transfer	3-99
Paging — DENY	3-102
Paralleled Telephone Connection	3-103
Personal Speed Dialing	3-104
Pickup Dialing (Hot Line) (— Single Line Telephone only)	3-106
Power Failure Transfer	3-107
Pulse to Tone Conversion	3-108

Table of Contents

R

Redial, Last Number	3-109
Redial, Saved Number	3-110
Room Monitor	3-111

S

Secret Dialing	3-113
Station Feature Clear	3-114
Switching to Tone Alert	3-115
System Speed Dialing	3-116

T

Time (Day/Night/Lunch) Service	3-117
Timed Reminder	3-118
Toll Restriction Override	3-120
Toll Restriction Override by Account Codes	3-120
Toll Restriction for System Speed Dialing	3-121
Toll Restriction — Station Lock Boundary Class	3-121
Two-Way Recording into Voice Mail	3-122

V

Voice Mail Integration for KX-TVS50/KX-TVS75/KX-TVS80/KX-TVS100/KX-TVS110	3-124
Voice Mail Transfer	3-127

W

Walking COS	3-128
-------------------	-------

3.3 Operator/Manager Service Features 3-129

Manager Programming (Manager only)	3-130
Call Log, Incoming in the Common Area — CLEAR ALL	3-132
Call Log Lock, Incoming in the Common Area	3-133
Date and Time Setting	3-134
Electronic Station Lockout — CANCEL ALL	3-135
Live Call Screening Password Control	3-136
Outgoing Message (OGM)	3-137
Remote Station Lock Control	3-139
The 301st Call Log, Incoming in the Common Area Treatment	3-141
Time (Day/Night/Lunch) Service Setting	3-142
Timed Reminder, Remote (Wake-Up Call)	3-144
Extension Password Set (Manager only)	3-146

Table of Contents

Section 4	DSS Console Features (KX-T7040)	4-1
4.1	Configuration	4-2
	Location of Controls	4-3
4.2	DSS Console Features	4-4
	Station Programming	4-4
	Extension Number Assignment	4-5
	One-Touch Dialing Assignment	4-5
	One-Touch Access Assignment for System Features	4-6
	Another Extension Message Waiting Button Assignment	4-6
	Live Call Screening (LCS) Button Assignment	4-7
	Live Call Screening (LCS) Cancel Button Assignment	4-7
	Two-Way Record Button Assignment	4-8
	Two-Way Transfer Button Assignment	4-8
	Voice Mail (VM) Transfer Button Assignment	4-9
	Day Button Assignment (Operator and Manager only)	4-9
	Night Button Assignment (Operator and Manager only)	4-10
	Lunch Button Assignment (Operator and Manager only)	4-10
	Station Lock Button Assignment (Operator and Manager only)	4-11
	Station Programming Cancel	4-11
	Direct Station Dialing	4-12
	One-Touch Dialing	4-12
	One-Touch Access for System Features	4-12
	Call Transfer	4-13
Section 5	Appendix	5-1
	Display Examples	5-2
	Feature Number List	5-8
	Tone List	5-11
	Troubleshooting	5-13

Section 1

PT Overview

Contents

1.1	<i>Configuration</i>	1-2
	<i>Location of Controls</i>	1-3
	<i>Feature Buttons</i>	1-8
	<i>Initial Settings</i>	1-13
	<i>LED Indication</i>	1-15

<Note>

All illustrations used in the initial settings are based on the KX-T7130/
KX-T7135 model.

1.1

Configuration

Panasonic Proprietary Telephones (PTs) are available to utilize various features of the KX-TA624 System, in addition to supporting basic telephone services (making and receiving calls).

There are five PT models.

	KX-T7020	KX-T7030	KX-T7130	KX-T7135	KX-T7050	KX-T7055
Display	None	16 char./line	16 char./line	16 char./line	None	None
Speakerphone	Yes	Yes	Yes	Yes	Monitor only	Monitor only
CO Buttons	12	12	12	12	12	3
Programmable Feature Buttons	4	4	12	12	4	3
Fixed Feature Buttons	Refer to the “Fixed Buttons” (1.1 Configuration) section.					

1.1

Configuration

Location of Controls

■ KX-T7020

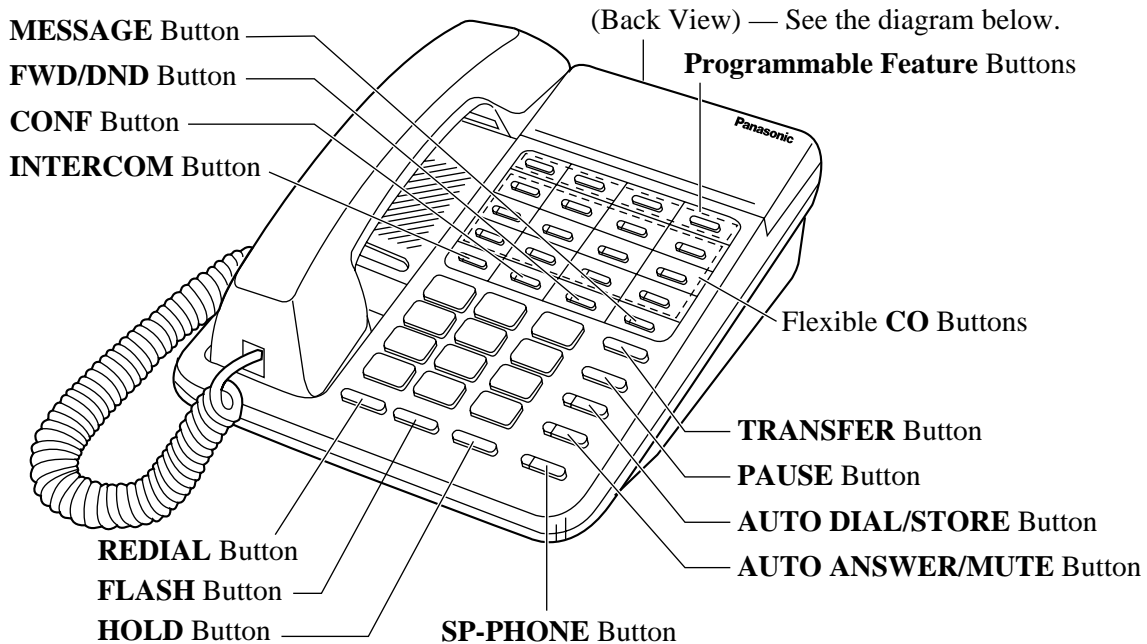

<Side View>

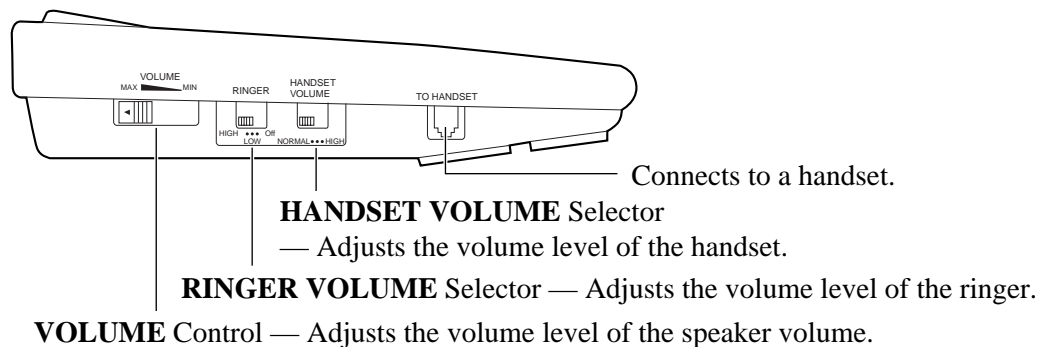

<Back View>

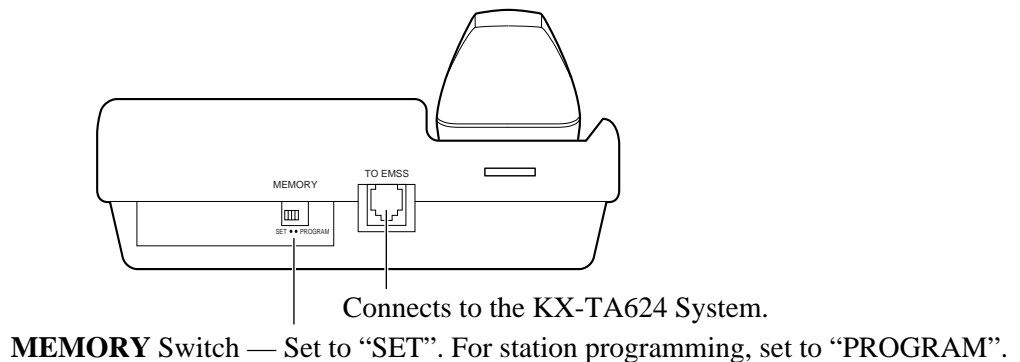

1.1

Configuration

■ KX-T7030

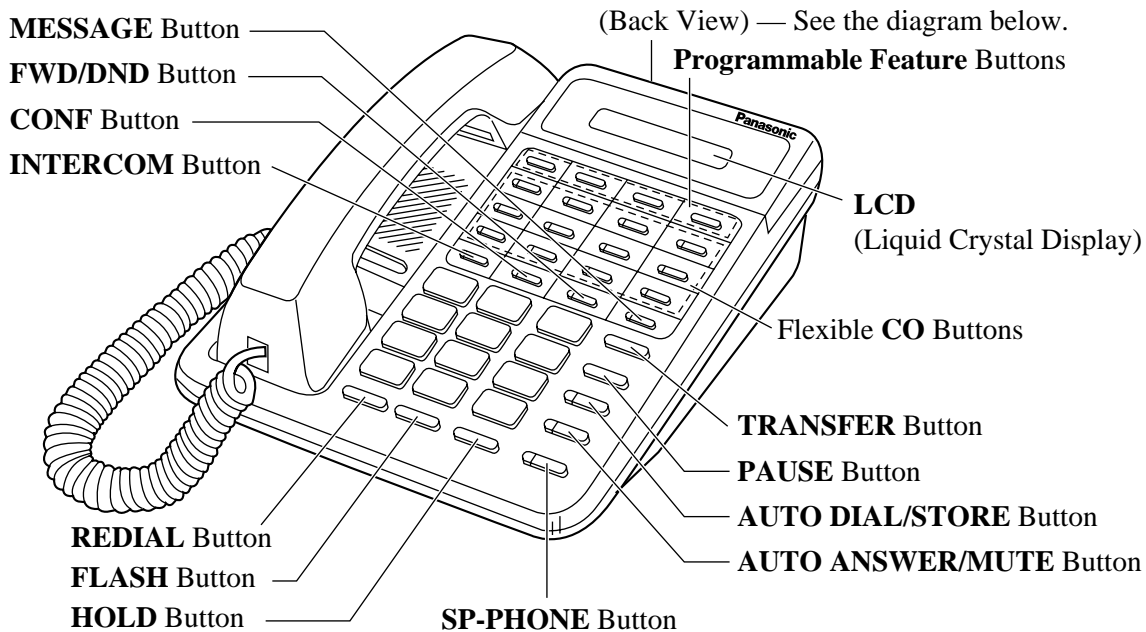

<Side View>

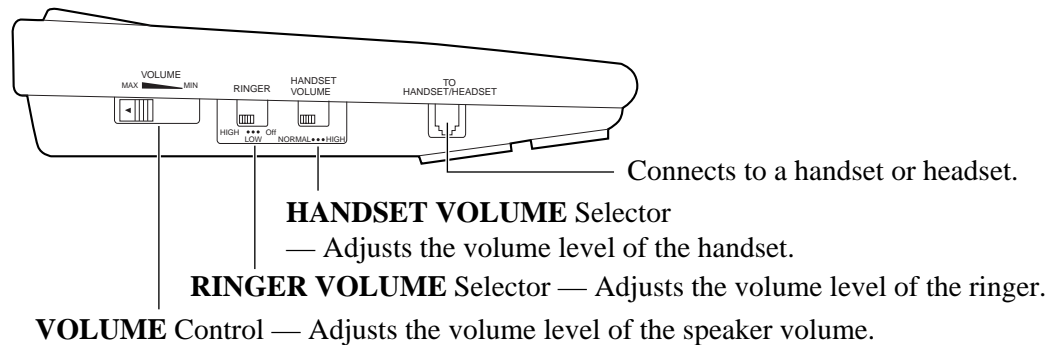

<Back View>

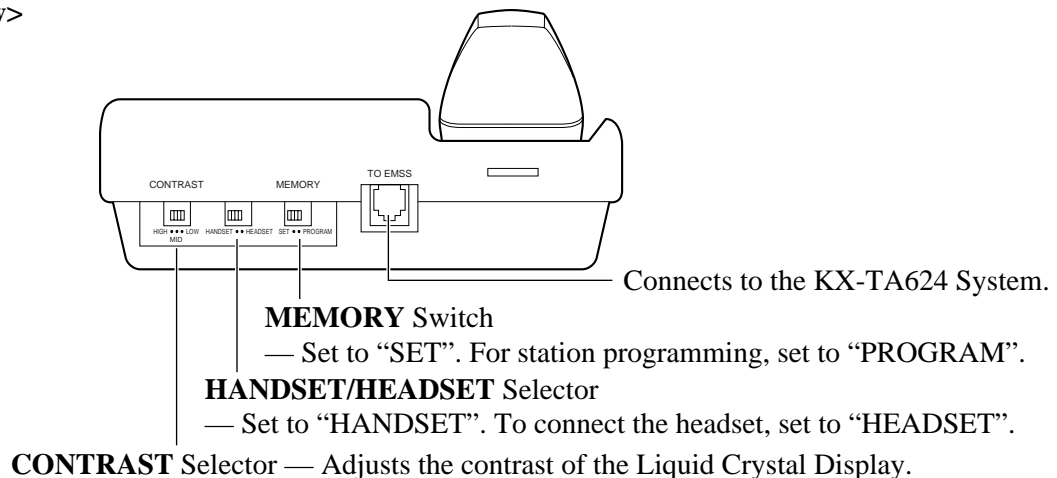

1.1

Configuration

■ KX-T7130/KX-T7135

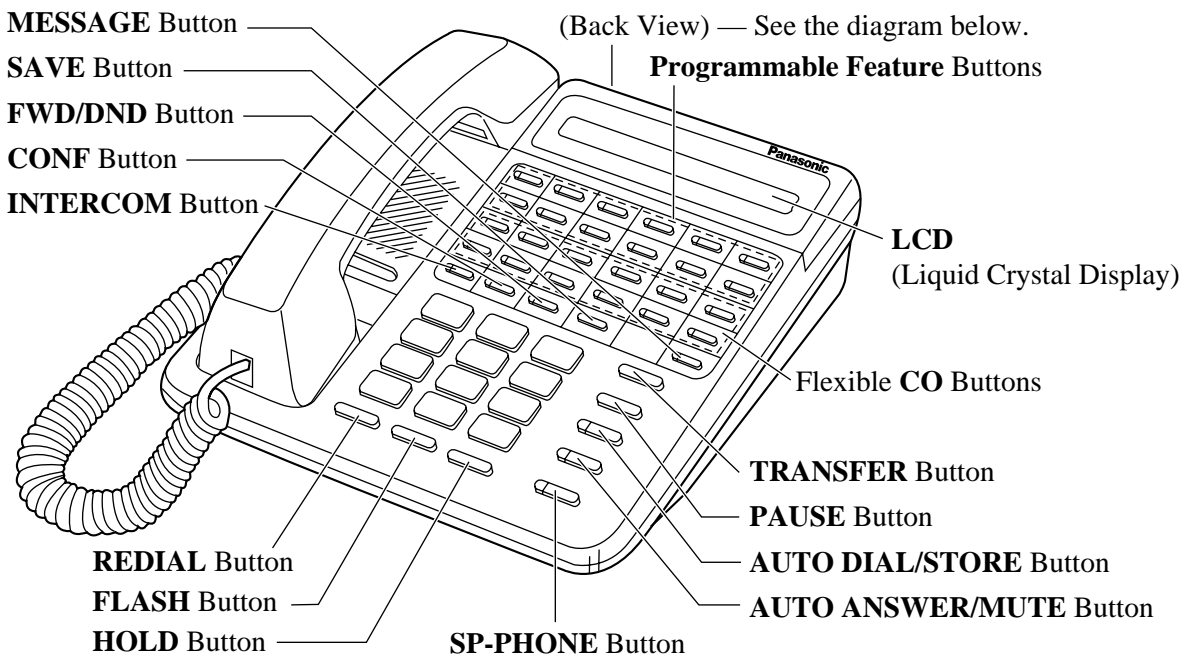

<Side View>

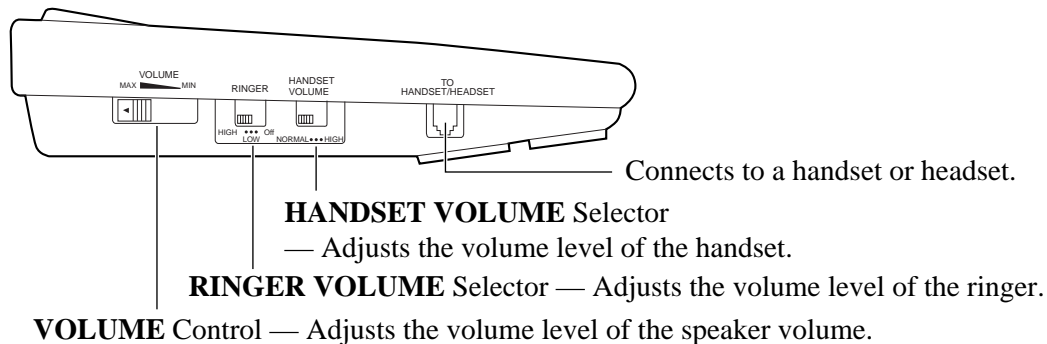

<Back View>

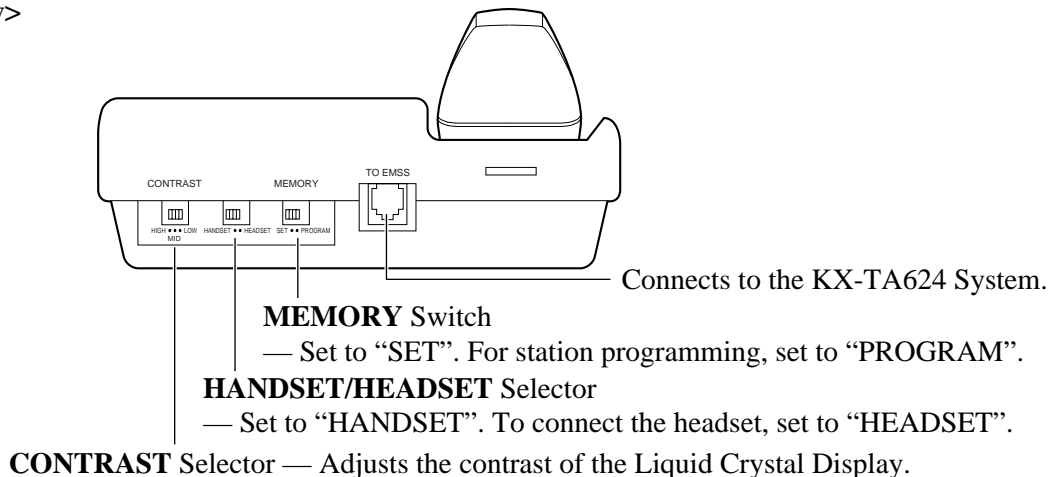

1.1

Configuration

■ KX-T7050

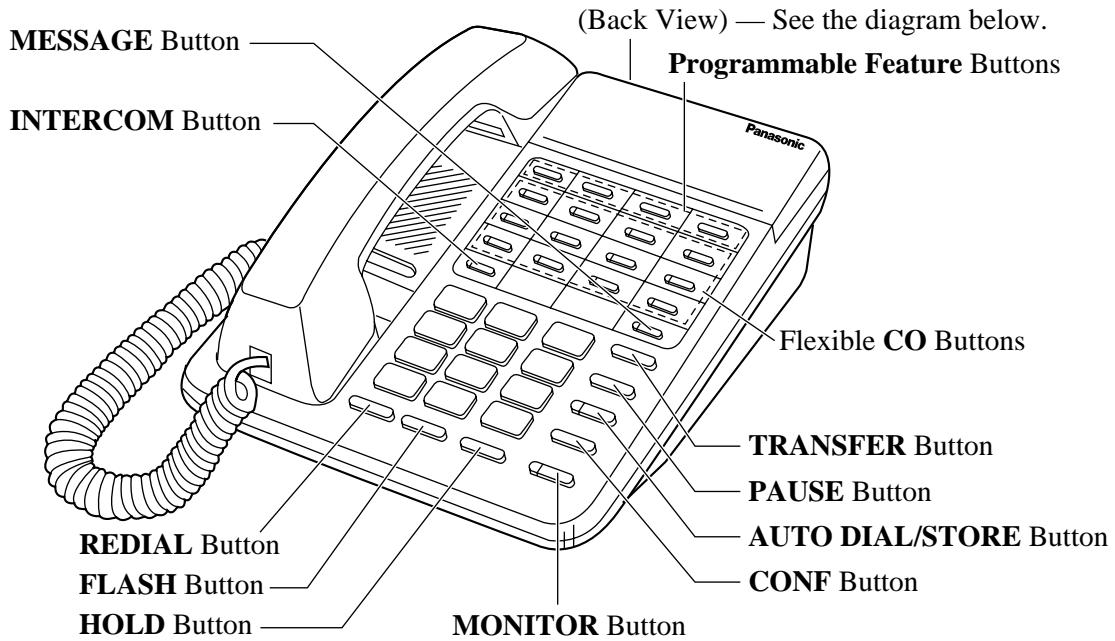

<Side View>

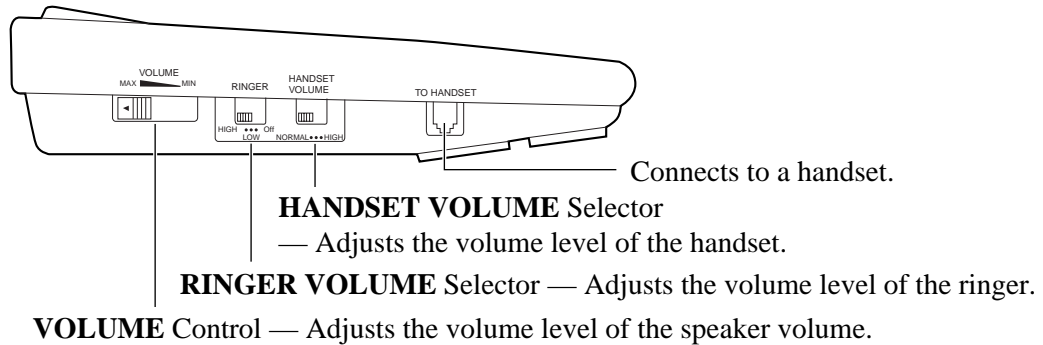

<Back View>

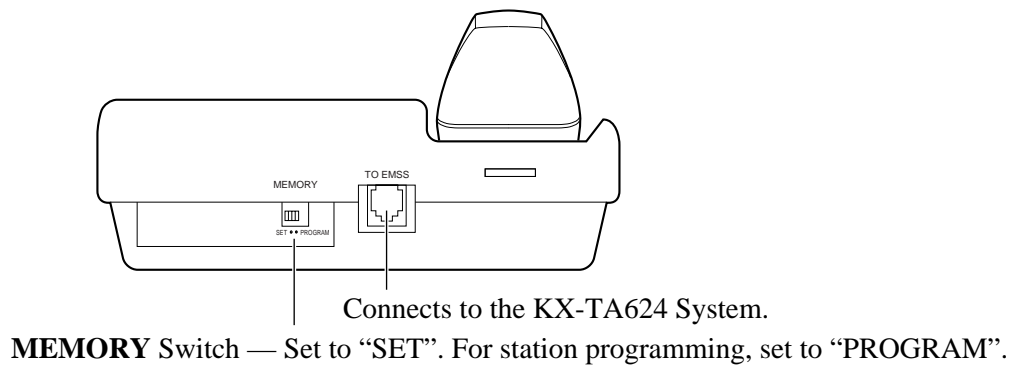

1.1

Configuration

■ KX-T7055

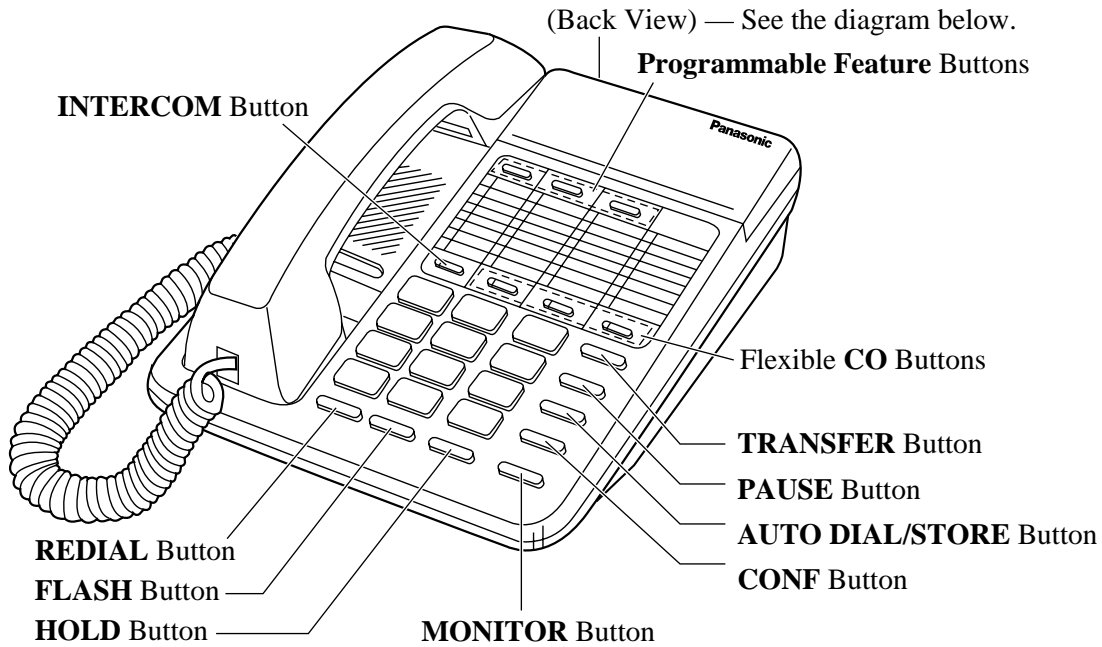

<Side View>

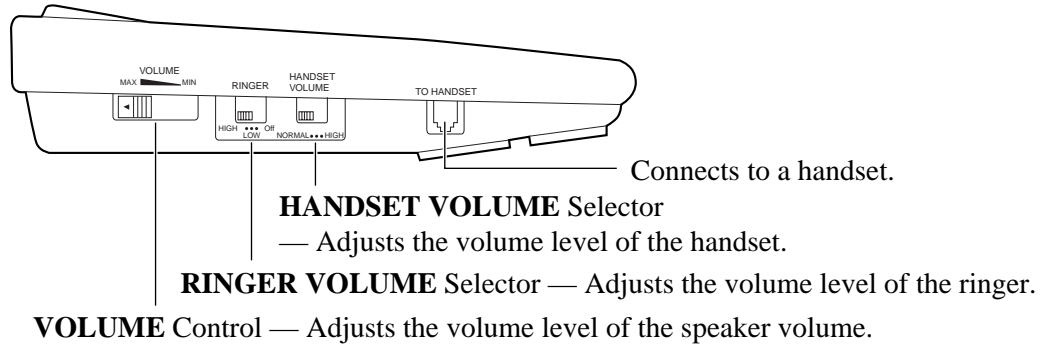

<Back View>

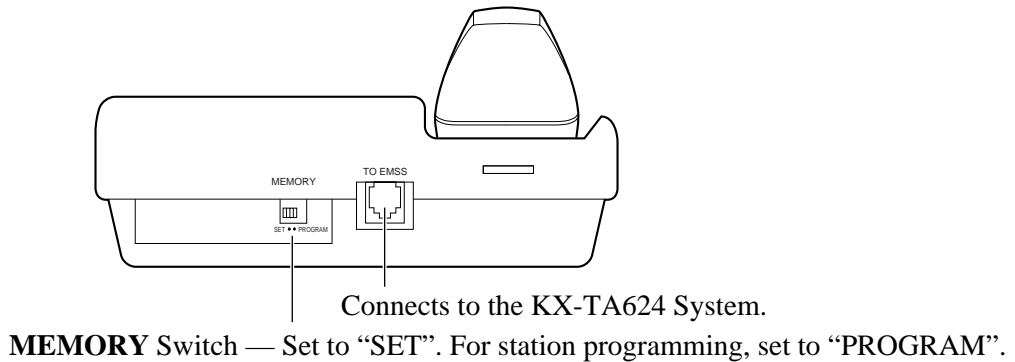

Feature Buttons

PTs have the following types of Feature Buttons.

- **Fixed Buttons**
- **Flexible CO Buttons**
- **Programmable Feature Buttons**

Fixed Buttons

Fixed buttons have specific features permanently assigned to them. These default feature assignments cannot be changed. The following table lists the fixed buttons located on each PT model.

Feature Button	T7020	T7030	T7130	T7135	T7050	T7055
AUTO ANSWER/MUTE	✓	✓	✓	✓		
AUTO DIAL/STORE	✓	✓	✓	✓	✓	✓❖
CONF	✓	✓	✓	✓	✓❖	✓❖
FLASH❖	✓	✓	✓	✓	✓	✓
FWD/DND	✓	✓	✓	✓		
HOLD❖	✓	✓	✓	✓	✓	✓
INTERCOM	✓	✓	✓	✓	✓	✓
MESSAGE	✓	✓	✓	✓	✓	
MONITOR					✓	✓❖
PAUSE❖	✓	✓	✓	✓	✓	✓
REDIAL❖	✓	✓	✓	✓	✓	✓
SAVE❖			✓	✓		
SP-PHONE	✓	✓	✓	✓		
TRANSFER❖	✓	✓	✓	✓	✓	✓

“✓” indicates the button is available.

❖: The button is not provided with an LED (Light Emitting Diode).

Usage

AUTO ANSWER/MUTE Button

Used for answering an extension automatically, or turns the microphone off during a conversation.

AUTO DIAL/STORE Button

Used for System Speed Dialing or storing program changes.

CONF (Conference) Button

Used to establish a three-party conference.

FLASH Button

Sends an External Feature Access signal to the central office or host PBX to access their system features. If a PBX is not being used, this button can be used to disconnect the current call and start another call without hanging up.

FWD/DND (Call Forwarding/Do Not Disturb) Button

Used to program the Call Forwarding feature or set the Do Not Disturb (DND) feature.

HOLD Button

Used to place a call on hold.

INTERCOM Button

Used to make or receive intercom calls.

MESSAGE Button

Used to call back the message sender.

MONITOR Button

Used for a hands-free dialing operation.

PAUSE Button

Inserts a pause in speed dial numbers or in other numbers.

REDIAL Button

Used for Last Number or Automatic Redialing.

SAVE Button

Used for Saved Number Redialing.

SP-PHONE (Speakerphone) Button

Used for a hands-free speakerphone operation.

TRANSFER Button

Transfers a call to another extension or external destination.

Flexible Buttons

Flexible Buttons do not have specific features permanently assigned to them. Features are assigned to Flexible Buttons through Station Programming. “Flexible Button Assignment” is addressed in Station Programming (Section 2). The four types of Flexible Buttons are as follows.

- **Flexible CO Buttons** (located on a PT only)
- **Flexible DSS Buttons** (located on a DSS Console only)
- **Programmable Feature (PF) Buttons** (located on a PT and DSS Console)
- **Flexible MESSAGE Buttons** (located on a PT except the KX-T7055)

The following table outlines the features that can be assigned to the Flexible Buttons.

Feature (Buttons)	CO	DSS	PF	MESSAGE
Group-CO (G-CO)	✓	—	—	—
Other-CO (O-CO)	✓	—	—	—
Single-CO (S-CO)	✓	—	—	—
Caller ID Indication — Common	✓	—	—	—
Caller ID Indication — Personal	✓	—	—	—
Caller ID Selection — Common	✓	—	—	—
Caller ID Selection — Personal	✓	—	—	—
Conference (CONF)	✓	—	—	—
FWD/DND	✓	—	—	—
Log-In/Log-Out	✓	—	—	—
SAVE	✓	—	—	—
Day	—	✓	—	—
Lunch	—	✓	—	—
Night	—	✓	—	—
Station Lock	—	✓	—	—
Message Waiting (MESSAGE)	—	—	—	✓
Another Extension Message Waiting	✓	✓	—	—
Live Call Screening (LCS)†	✓	✓	—	—
LCS Cancel†	✓	✓	—	—
Two-Way Record†	✓	✓	—	—
Two-Way Transfer†	✓	✓	—	—
Voice Mail Transfer†	✓	✓	—	—
DSS	✓	✓	—	✓
One-Touch Dialing	✓	✓	✓	✓

“✓” indicates that the feature is available.

† Available when the KX-TA624 is connected to a Proprietary Telephone capable Panasonic Voice Processing System (one that supports APT Integration; KX-TVS50/KX-TVS80).

Line Access Buttons

One of the following three types of CO buttons must be used to seize an outside (CO) line when making a call.

- **Group-CO (G-CO) button**
- **Other-CO (O-CO) button**
- **Single-CO (S-CO) button**

Conditions

- A flexible CO button can be assigned as a Line Access Button (G-CO, O-CO or S-CO) in Station Programming. Once a flexible CO button is assigned as a Line Access Button, it provides the line status using lighting patterns and color indication. Please refer to “LED Indication” in this section.
- You can set the G-CO and S-CO buttons on one telephone. Incoming and outgoing calls on the line are shown on the button in the following priority.
S-CO > G-CO

Group-CO (G-CO) Button

To use outside (CO) lines efficiently, a group of outside (CO) lines (outside (CO) line group) can be assigned to a CO button. This button is referred to as Group-CO (G-CO) button. Any incoming calls from any outside (CO) line in the outside (CO) line group arrive at the G-CO button. To make an outside call, you can access an idle outside (CO) line in the group by simply pressing the assigned G-CO button.

Conditions

- The same line can be assigned as an S-CO button and G-CO button.
- The extension for making and/or receiving calls in outside (CO) line groups must be programmed.
- When your extension is assigned as the incoming call destination for an outside (CO) line, you cannot receive any incoming outside calls unless a G-CO, O-CO or S-CO button associated with the line is assigned.

Programming Reference

- Station Programming (Section 2)
Flexible Button Assignment — Group-CO (G-CO) Button

Feature References

Feature Buttons — Flexible Buttons (Section 1.1 Configuration)
Outward Dialing, Line Access — Line Access, Outside (CO) Line Group

Other-CO (O-CO) Button

Outside (CO) lines which are not assigned to S-CO or G-CO buttons can be assigned to a flexible CO button on a proprietary telephone. The assigned button serves as the O-CO button. An incoming call, on assigned outside (CO) lines, arrives at the O-CO button. To make an outside call, you simply press the designated O-CO button.

Programming Reference

- Station Programming (Section 2)
Flexible Button Assignment — Other-CO (O-CO) Button

Feature References

Feature Buttons — Flexible Buttons (Section 1.1 Configuration)
Outward Dialing, Line Access — Line Access, Automatic

Single-CO (S-CO) Button

An S-CO button is an outside (CO) line access button. This allows you to access a specific line by pressing an S-CO button. An incoming call can be directed to an S-CO button.

Conditions

- Only one S-CO button can be assigned to an outside (CO) line.
- The same outside (CO) line can be assigned as an S-CO button and G-CO button.

Programming Reference

- Station Programming (Section 2)
Flexible Button Assignment — Single-CO (S-CO) Button

Feature References

Feature Buttons — Flexible Buttons (Section 1.1 Configuration)
Outward Dialing, Line Access — Line Access, Individual

Initial Settings

Display Contrast Adjustment (KX-T7030, KX-T7130 and KX-T7135 only)

The CONTRAST selector is used to adjust the display contrast.

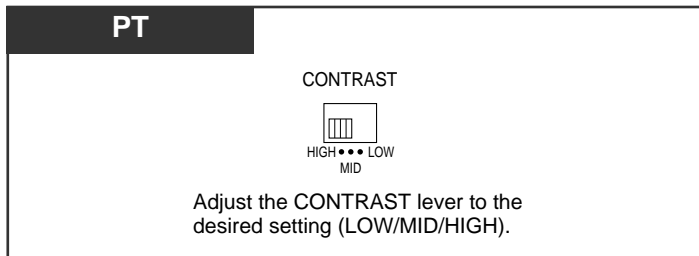

When using the headset (KX-T7030, KX-T7130 and KX-T7135 only)

The Panasonic Advanced Hybrid System supports the use of a headset on a proprietary telephone (PT). When you use the headset (optional), you should switch the selection mode first.



Volume Control — Handset Receiver/Headset/Ringer/Speaker

Allows you to adjust the following volume settings as necessary.

- Handset Receiver volume
- Headset volume
- Ringer volume
- Speaker volume

To adjust the handset receiver volume

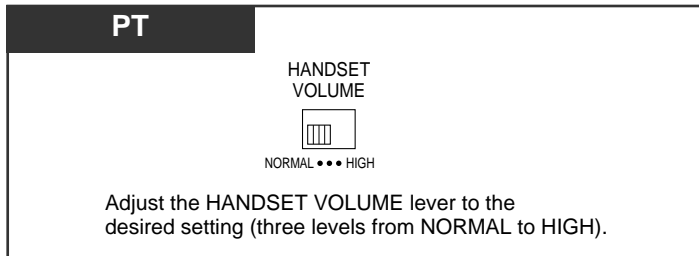

To adjust the headset volume

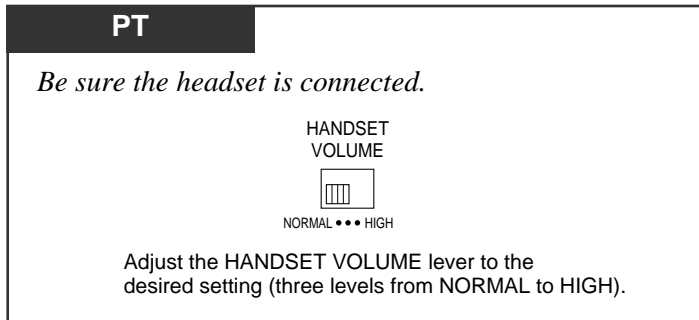

To adjust the ringer volume

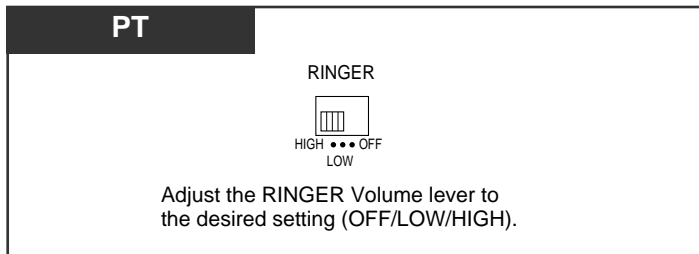

To adjust the speaker volume

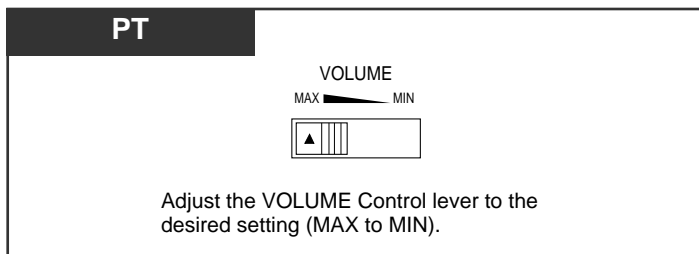

LED Indication

The Light Emitting Diode (LED) buttons indicate the line conditions with lighting patterns.

Flashing light patterns

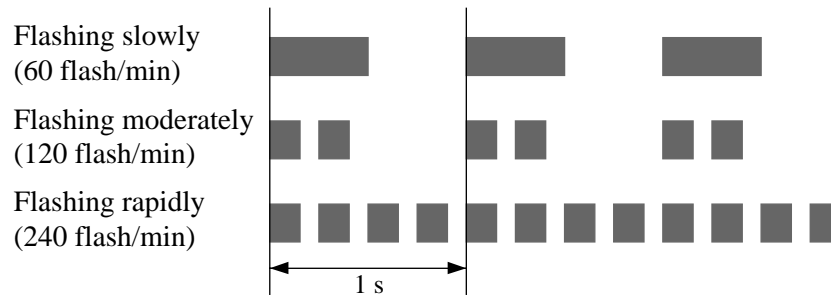

LED Indication on the INTERCOM Button

The table below shows the lighting patterns for intercom line conditions.

INTERCOM button	Intercom Line Condition
Off	Idle
Green On	Intercom call / Conference established
Flashing Green Slowly	Intercom call hold
Flashing Green Moderately	Intercom call exclusive hold
Flashing Green Rapidly	Incoming intercom/doorphone call

LED Indication on the CO Button

The table below shows the lighting patterns for outside (CO) line conditions.

CO Button	Outside (CO) Line Condition
Off	Idle
Green On	You are using the line.
Flashing Green Slowly	You have a held call or Hold Recall
Flashing Green Moderately	You have one of the following: (1) exclusive hold, (2) outside-to-outside (CO-to-CO) line call, or (3) Conference, Unattended.
Flashing Red Rapidly	Incoming call
Red On	Other-use
Flashing Red Slowly	Other-hold*

— Item with an * is only available on a Single-CO button.

BLF on DSS Button

The Busy Lamp Field (BLF) indicator button is red when the corresponding extension is busy. This is available for flexible CO buttons assigned as DSS buttons on proprietary telephones and DSS buttons on DSS Consoles.

Section 2
Station Programming
(Personal Programming)

Contents

<i>2.1 Station Programming Instructions</i>	<i>2-2</i>
<i>2.2 Station Programming (Personal Programming) (A-Z) ...</i>	<i>2-6</i>

<Note>

All illustrations used in these operating instructions are based on the KX-T7130/KX-T7135 model.

2.1 *Station Programming Instructions*

Station Programming allows you, the proprietary telephone (PT) user, to program certain features from your telephone individually. To program, you need to switch your telephone to the Station Programming mode. During the programming mode, your telephone is busy to outside callers. If you want to make a normal call operation, you must finish the programming mode.

Programming Mode Display

When you enter the Station Programming mode, the display shows the following message as the initial programming mode.

PITS-PGM NO? →

The display also gives you helpful or stored data information related to the programming steps. In this section, the display example in the programming steps are noted, if required. You can also refer to the “Display Examples” in the Appendix (Section 5).

To enter the Station Programming mode

PT

Be sure the telephone is idle and on-hook.

MEMORY



SET • PROGRAM

Set the MEMORY switch to “PROGRAM”.

To exit the Station Programming mode

PT

When the display shows the initial programming mode

MEMORY



SET • PROGRAM

Set the MEMORY switch to “SET”.

Programming is completed and the normal call operation resumes.

When storing data

After pressing the STORE button to store data, you may hear one of the following tones.

- Confirmation tone (one beep): storage is completed.
- Confirmation tone (two beeps): the data is the same as the last entry.
- Alarm tone (three beeps): the entry is not valid.

2.1

Station Programming Instructions

To confirm the assigned data

—Be sure that you are in the Station Programming mode. Set the MEMORY switch to “PROGRAM”.

The diagram shows a display screen with a dark header labeled "PT". Below the header, there are two input fields: "program access number" and "HOLD". Below the "program access number" field is the instruction "Enter the program access number." Below the "HOLD" field is the instruction "Press HOLD." A callout bubble points to the "HOLD" field with the text "• The display shows the initial programming mode." A larger callout bubble points to the "program access number" field with a list of options:

- Enter the **program access number*** as follows.
 - 1: Preferred Line Assignment — Outgoing
 - 2: Preferred Line Assignment — Incoming
 - 3: Outside (CO) Line Ringing Selection
 - 4: Intercom Alert Assignment
 - 5: Call Waiting Tone Type Assignment
 - 6: Self-Extension Number Confirmation (KX-T7030, KX-T7130 and KX-T7135 only)
 - 7: Extension Password Set (Manager only)
 - 0: Date and Time Setting (Operator/Manager only)
- The display shows the programmed data.

<PT Display Example>
When you press “5”, the display shows:

— The Call Waiting tone is currently programmed to Tone 1.

— To exit the Station Programming mode, set the MEMORY switch to “SET”.
— If you wish to change the data, follow the programming procedure explained in this section.

* A **program access number** is required to program/confirm the data by Station Programming.

2.1 Station Programming Instructions

To confirm the assigned data on the Flexible button

- Be sure that you are in the Station Programming mode. Set the MEMORY switch to “PROGRAM”.

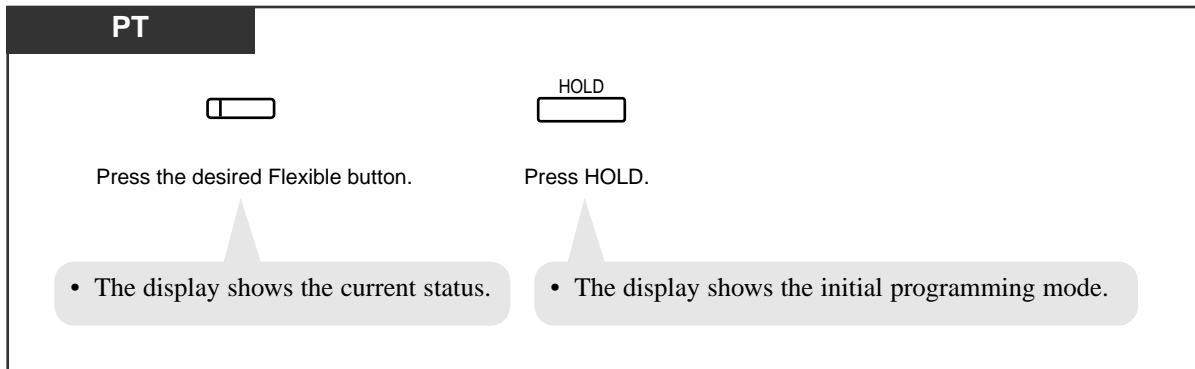

- To exit the Station Programming mode, set the MEMORY switch to “SET”.
- If you wish to change the data, follow the programming procedure explained in this section.

To clear the data on the Flexible button

- Be sure that you are in the Station Programming mode. Set the MEMORY switch to “PROGRAM”.

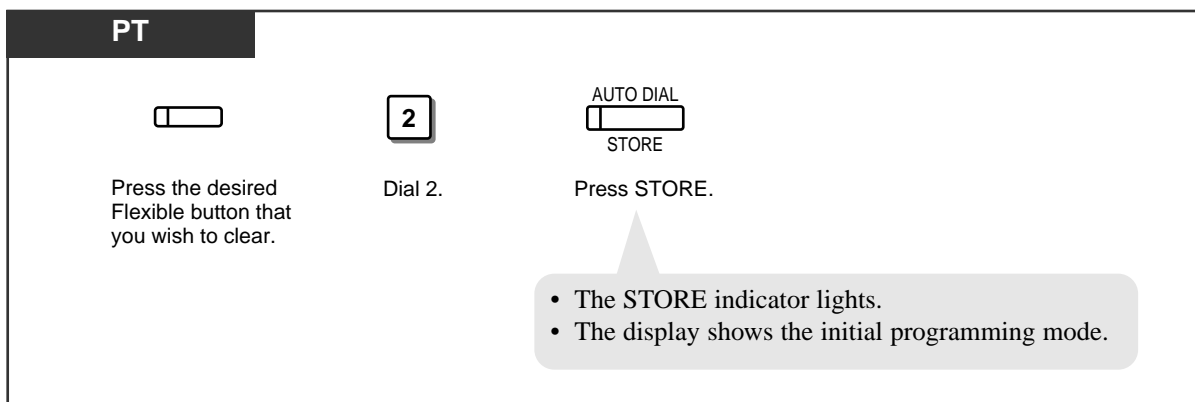

- To exit the Station Programming mode, set the MEMORY switch to “SET”.

- The following outline contains the buttons and program access numbers used for Station Programming. Detailed operating instructions are explained in this section.

2.1

Station Programming Instructions

Station Programming Outline

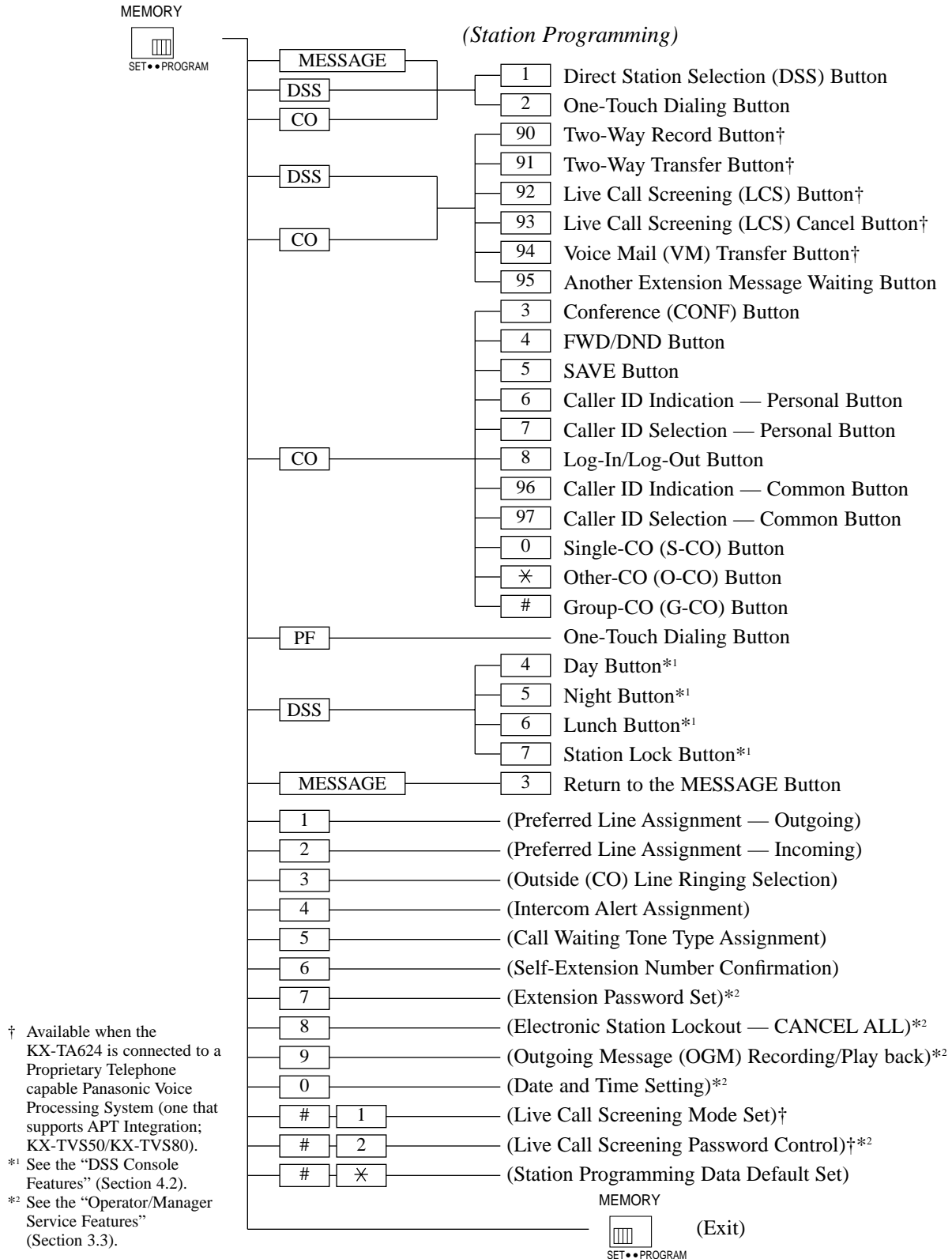

† Available when the KX-TA624 is connected to a Proprietary Telephone capable Panasonic Voice Processing System (one that supports APT Integration; KX-TVS50/KX-TVS80).

*¹ See the “DSS Console Features” (Section 4.2).

*² See the “Operator/Manager Service Features” (Section 3.3).

2.2 Station Programming (Personal Programming)

Call Waiting Tone Type Assignment

Allows you to select the call waiting tone type (Tone 1 or Tone 2).

— Be sure that you are in the Station Programming mode. Set the MEMORY switch to “PROGRAM”.

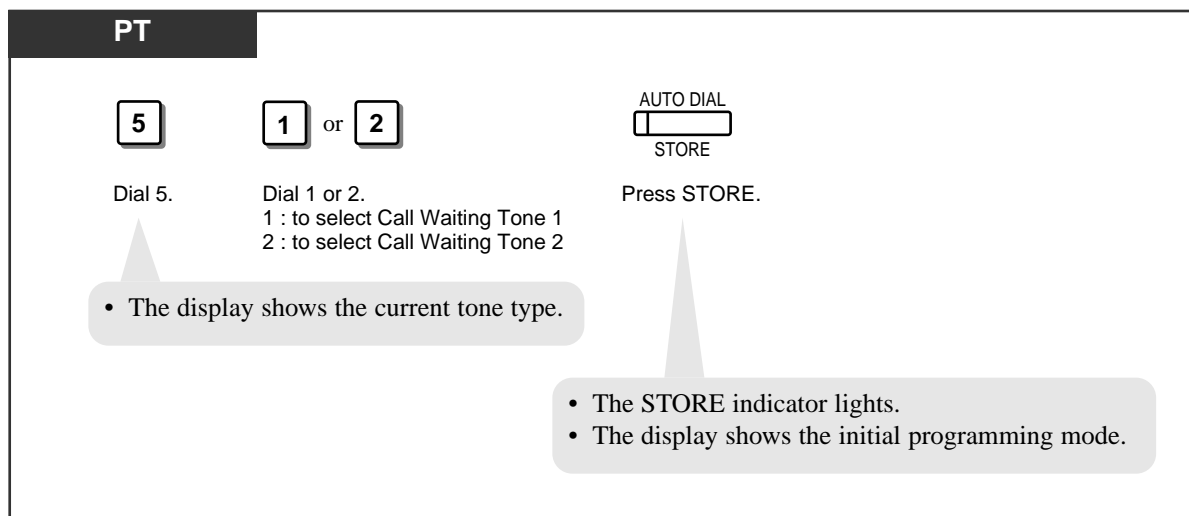

— To exit the Station Programming mode, set the MEMORY switch to “SET”.

Conditions

- The tone type patterns are described in the Appendix (Section 5).
- The default is “Tone 1”.

Feature References

Busy Station Signaling (BSS)
Call Waiting

2.2 Station Programming (Personal Programming)

Flexible Button Assignment

Each Flexible button on your telephone and the console can be assigned as various feature buttons such as a DSS Button, FWD/DND Button, etc. The assignable features are limited by the button type. Please refer to “Flexible Buttons” in Section 1.1.

Another Extension Message Waiting Button (Assignment)

Allows you to assign a Flexible button (CO, DSS) as an Another Extension Message Waiting button.

— Be sure that you are in the Station Programming mode. Set the MEMORY switch to “PROGRAM”.

The diagram illustrates the steps to assign a Flexible button as an Another Extension Message Waiting button on a PT display. It shows the following components and instructions:

- PT Display:** A rectangular display area with a dark header labeled "PT".
- Buttons:** A "9" button, a "5" button, an "extension no." button, and an "AUTO DIAL STORE" button.
- Instructions:**
 - "Press the desired Flexible button you wish to assign as an Another Extension Message Waiting button."
 - "Dial 95."
 - "Enter the extension number (100 through 199)."
 - "Press STORE."
- Display Examples:**
 - <PT Display Example>**: Shows "MW-" on the display.
 - <PT Display Example>**: Shows "MW-xxx" on the display, with a line pointing to "xxx" labeled "extension number".
- Callouts:**
 - A callout points to the "STORE" button with the text: "The STORE indicator lights." and "The display shows the initial programming mode."
 - A callout points to the second display example with the text: "To erase an incorrect entry, press the TRANSFER (CLEAR) button. (The TRANSFER button becomes the CLEAR button during programming.)"

— To exit the Station Programming mode, set the MEMORY switch to “SET”.

Feature Reference

Message Waiting for Another Extension

2.2 Station Programming (Personal Programming)

Caller ID Indication Button (Assignment)

Allows you to assign a Flexible CO button as the Caller ID Indication button.

— Be sure that you are in the Station Programming mode. Set the MEMORY switch to “PROGRAM”.

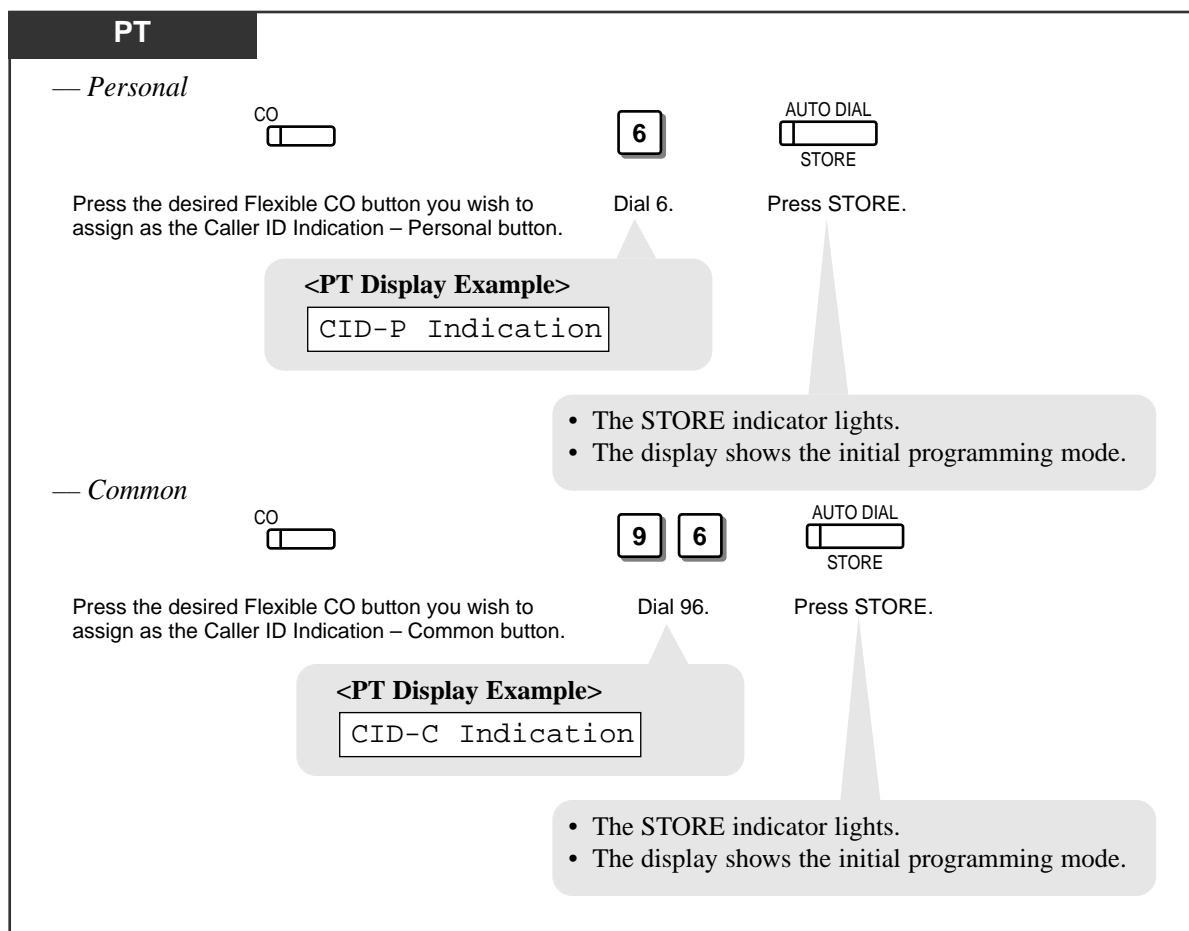

— To exit the Station Programming mode, set the MEMORY switch to “SET”.

Condition

- PT** • System Programming determines who can assign the Caller ID Indication — Common button.

Programming Reference

- System Programming — Installation Manual
[909] Common Area Call Log Check Assignment

Feature References

Call Information/Log, Incoming
Call Log, Incoming

2.2 Station Programming (Personal Programming)

Caller ID Selection Button (Assignment)

Allows you to assign a Flexible CO button as the Caller ID Selection button.

— Be sure that you are in the Station Programming mode. Set the MEMORY switch to “PROGRAM”.

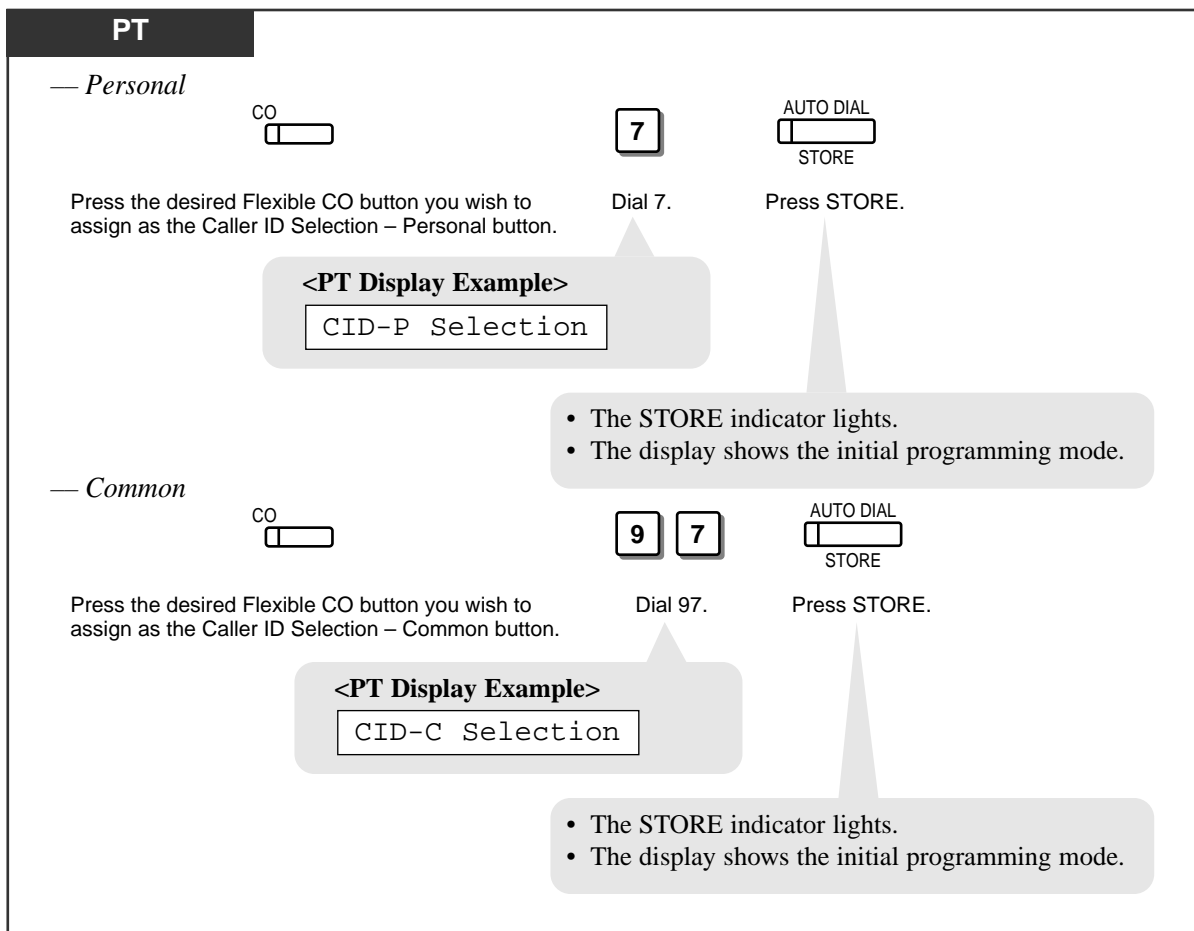

— To exit the Station Programming mode, set the MEMORY switch to “SET”.

Condition

- PT** • System Programming determines who can assign the Caller ID Selection — Common button.

Programming Reference

- System Programming — Installation Manual
[909] Common Area Call Log Check Assignment

Feature References

- Call Information/Log, Incoming
- Call Log, Incoming

2.2 Station Programming (Personal Programming)

Conference (CONF) Button (Assignment)

Allows you to assign a Flexible CO button as the Conference (CONF) button.

— Be sure that you are in the Station Programming mode. Set the MEMORY switch to “PROGRAM”.

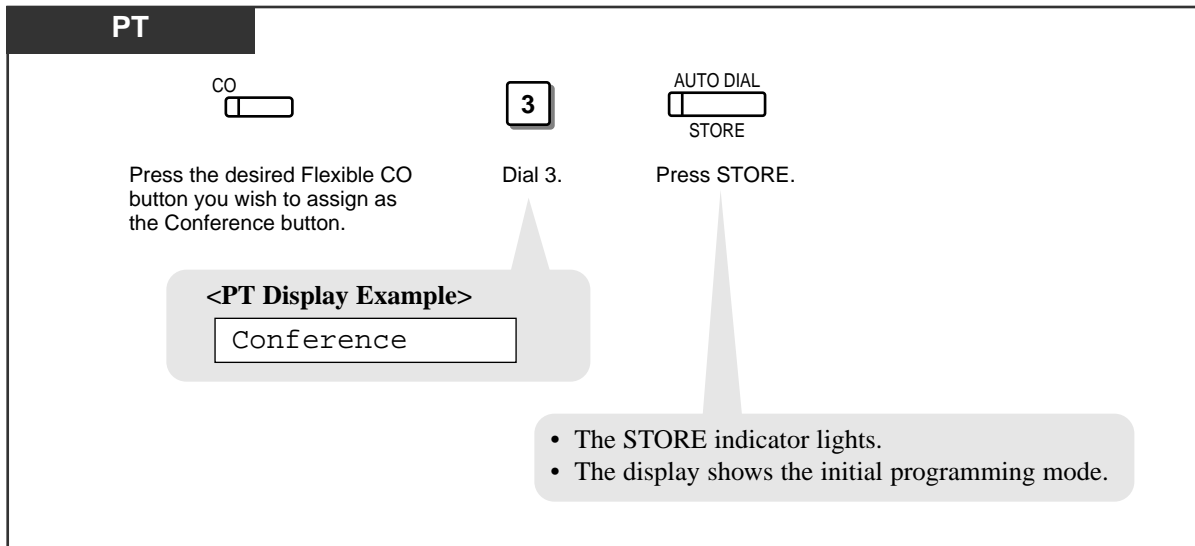

— To exit the Station Programming mode, set the MEMORY switch to “SET”.

Feature References

Conference
Conference, Unattended

2.2 Station Programming (Personal Programming)

Direct Station Selection (DSS) Button (Assignment)

Allows you to assign a Flexible button (CO, DSS, MESSAGE) as a DSS button.

— Be sure that you are in the Station Programming mode. Set the MEMORY switch to “PROGRAM”.

PT

1 **AUTO DIAL**
STORE

Press the desired Flexible button you wish to assign as a DSS button.

Dial 1.

Enter the extension number (100 through 199).

Press STORE.

<PT Display Example>
EXT-

<PT Display Example>
EXT-xxx
extension number

- The STORE indicator lights.
- The display shows the initial programming mode.

- To erase an incorrect entry, press the TRANSFER (CLEAR) button.
(The TRANSFER button becomes the CLEAR button during programming.)

— To exit the Station Programming mode, set the MEMORY switch to “SET”.

Condition

- DSS buttons are provided on the DSS Console with a default setting. You can change the setting from a paired telephone.

Feature Reference

Intercom Calling

2.2 Station Programming (Personal Programming)

FWD/DND Button (Assignment)

Allows you to assign a Flexible CO button as the FWD/DND button.

— Be sure that you are in the Station Programming mode. Set the MEMORY switch to “PROGRAM”.

The diagram shows the PT display interface for assigning a Flexible CO button as the FWD/DND button. It includes the following elements:

- CO**: A button with a small rectangular display.
- 4**: A button with the number 4.
- AUTO DIAL STORE**: A button with a small rectangular display and the text "STORE" below it.
- Instructions**:
 - "Press the desired Flexible CO button you wish to assign as the FWD/DND button."
 - "Dial 4."
 - "Press STORE."
- <PT Display Example>**: A callout box showing the display content "FWD/DND".
- Notes**: A callout box with two bullet points:
 - The STORE indicator lights.
 - The display shows the initial programming mode.

— To exit the Station Programming mode, set the MEMORY switch to “SET”.

Feature References

Call Forwarding
Do Not Disturb (DND)

Group-CO (G-CO) Button (Assignment)

Allows you to assign a Flexible CO button as a Group-CO button.

— Be sure that you are in the Station Programming mode. Set the MEMORY switch to “PROGRAM”.

The diagram shows the PT display interface for assigning a Flexible CO button as a Group-CO button. It includes the following elements:

- CO**: A button with a small rectangular display.
- #**: A button with the hash symbol.
- outside (CO) line group no.**: A button with a small rectangular display.
- AUTO DIAL STORE**: A button with a small rectangular display and the text "STORE" below it.
- Instructions**:
 - "Press the desired Flexible CO button you wish to assign as a G-CO button."
 - "Dial #."
 - "Enter the outside (CO) line group (trunk group) number (1 through 6)."
 - "Press STORE."
- <PT Display Example>**: A callout box showing the display content "TRK GRP-".
- <PT Display Example>**: A callout box showing the display content "TRK GRP-x".
- Notes**: A callout box with two bullet points:
 - The STORE indicator lights.
 - The display shows the initial programming mode.
- Additional Note**: A callout box with two bullet points:
 - To erase an incorrect entry, press the TRANSFER (CLEAR) button. (The TRANSFER button becomes the CLEAR button during programming.)

— To exit the Station Programming mode, set the MEMORY switch to “SET”.

2.2 Station Programming (Personal Programming)

Live Call Screening (LCS) Button (Assignment)[†]

Allows you to assign a Flexible button (CO, DSS) as the Live Call Screening (LCS) button.

— Be sure that you are in the Station Programming mode. Set the MEMORY switch to “PROGRAM”.

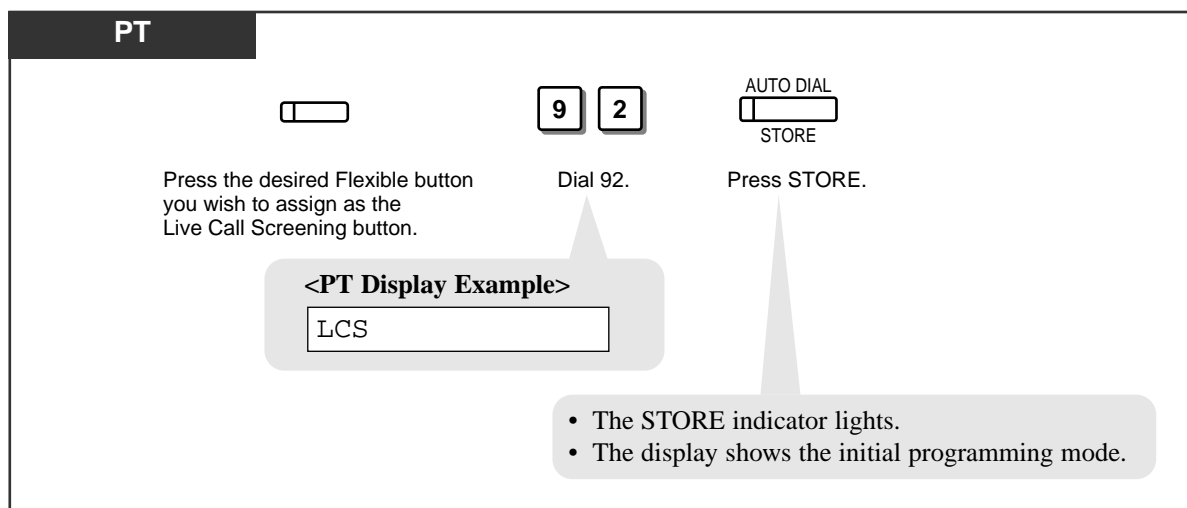

— To exit the Station Programming mode, set the MEMORY switch to “SET”.

Feature Reference

Live Call Screening (LCS)

[†] Available when the KX-TA624 is connected to a Proprietary Telephone capable Panasonic Voice Processing System (one that supports APT Integration; KX-TVS50/KX-TVS80).

2.2 Station Programming (Personal Programming)

Live Call Screening (LCS) Cancel Button (Assignment)[†]

Allows you to assign a Flexible button (CO, DSS) as the Live Call Screening (LCS) Cancel button.

— Be sure that you are in the Station Programming mode. Set the MEMORY switch to “PROGRAM”.

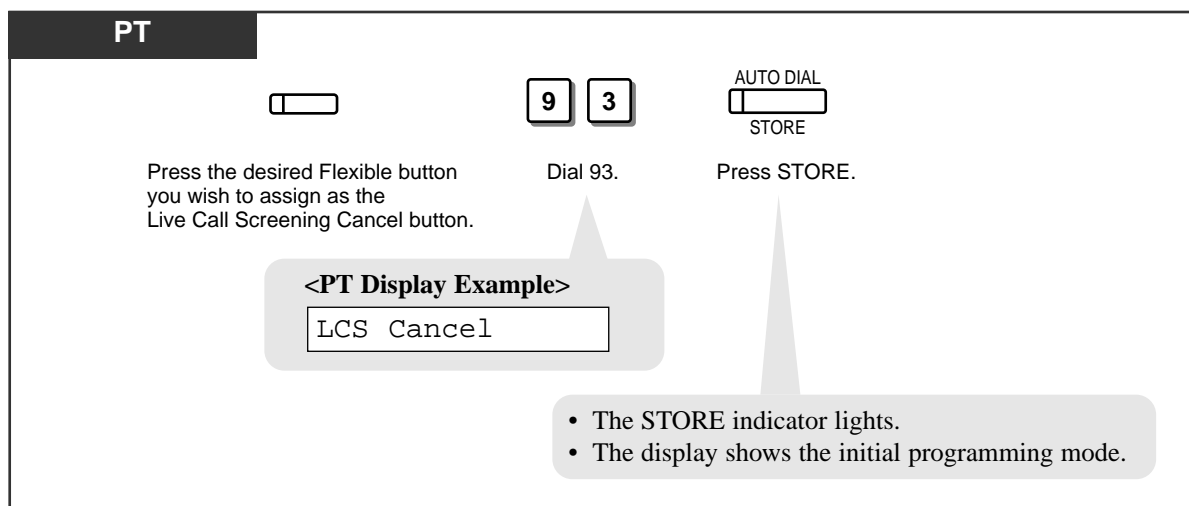

— To exit the Station Programming mode, set the MEMORY switch to “SET”.

Feature Reference

Live Call Screening (LCS)

[†] Available when the KX-TA624 is connected to a Proprietary Telephone capable Panasonic Voice Processing System (one that supports APT Integration; KX-TVS50/KX-TVS80).

2.2 Station Programming (Personal Programming)

Log-In/Log-Out Button (Assignment)

Allows you to assign a Flexible CO button as the Log-In/Log-Out button.

— Be sure that you are in the Station Programming mode. Set the MEMORY switch to “PROGRAM”.

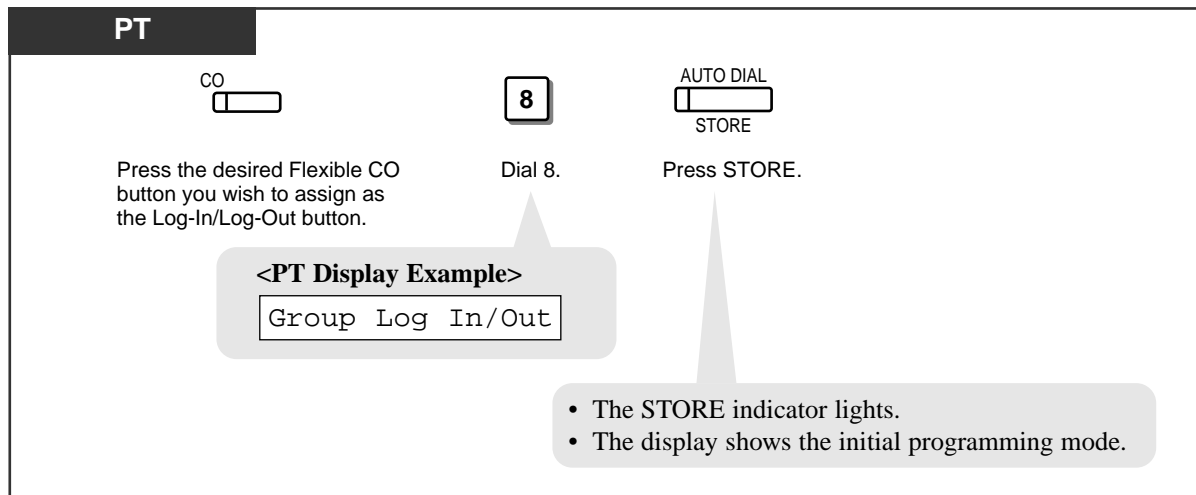

— To exit the Station Programming mode, set the MEMORY switch to “SET”.

Feature Reference

Log-In/Log-Out

2.2 Station Programming (Personal Programming)

One-Touch Dialing Button (Assignment)

Allows you to assign a Flexible button (CO, DSS, MESSAGE, PF) as a One-Touch Dialing button.

— Be sure that you are in the Station Programming mode. Set the MEMORY switch to “PROGRAM”.

PT

CO
No.
MESSAGE
PF

+ 2

desired number

AUTO DIAL
STORE

Press the desired Flexible button you wish to assign as a One-Touch Dialing button and dial 2, or press the desired PF button.

Enter the desired number (extension number, phone number, etc.).

Press STORE.

<PT Display Example>
Not Stored

- The STORE indicator lights.
- The display shows the initial programming mode.

- Up to 24 digits can be stored.
- To erase an incorrect entry, press the TRANSFER (CLEAR) button. (The TRANSFER button becomes the CLEAR button during programming.)

— To exit the Station Programming mode, set the MEMORY switch to “SET”

Conditions

- The number can be an extension number, telephone number or feature number. Up to twenty-four digits can be stored in a One-Touch Dialing button.
- To store the telephone number of an external party, a line access code (9 or 81 through 86) must be stored as the first digit.
- You can store a number consisting of twenty-five digits or more by dividing and assigning it into two One-Touch Dialing buttons. In this case, the line access code should be stored in the first button.
- To store an account code, press * * and then enter the desired code. The account codes must be stored after the line access code.
- You can use 0 through 9, *, #, PAUSE and INTERCOM for storing.
 - * #: change the dialing mode (Pulse to Tone)
 - PAUSE: pause
 - INTERCOM: secret

2.2 Station Programming (Personal Programming)

Other-CO (O-CO) Button (Assignment)

Allows you to assign a Flexible CO button as the Other-CO button.

— Be sure that you are in the Station Programming mode. Set the MEMORY switch to “PROGRAM”.

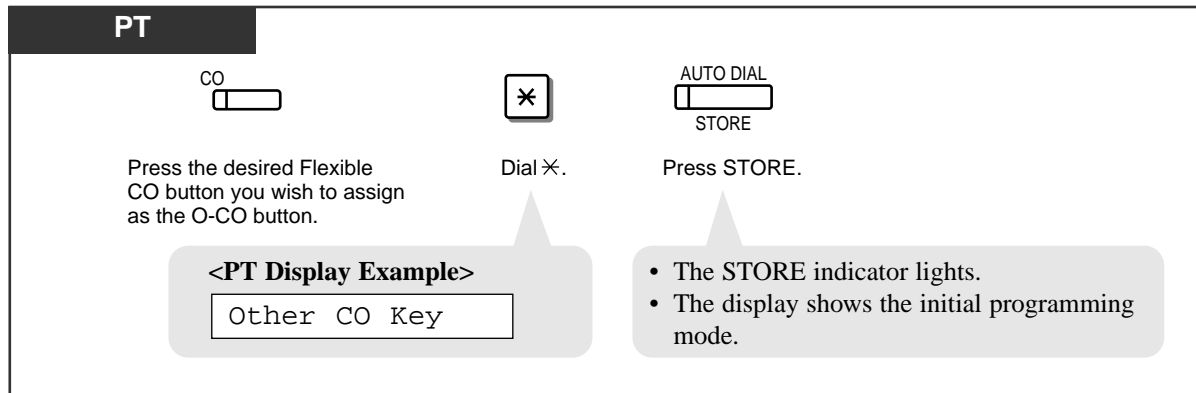

— To exit the Station Programming mode, set the MEMORY switch to “SET”.

Return to Message Waiting (MESSAGE) Button (Assignment)

Allows you to restore the message waiting feature to the Message Waiting (MESSAGE) button.

— Be sure that you are in the Station Programming mode. Set the MEMORY switch to “PROGRAM”.

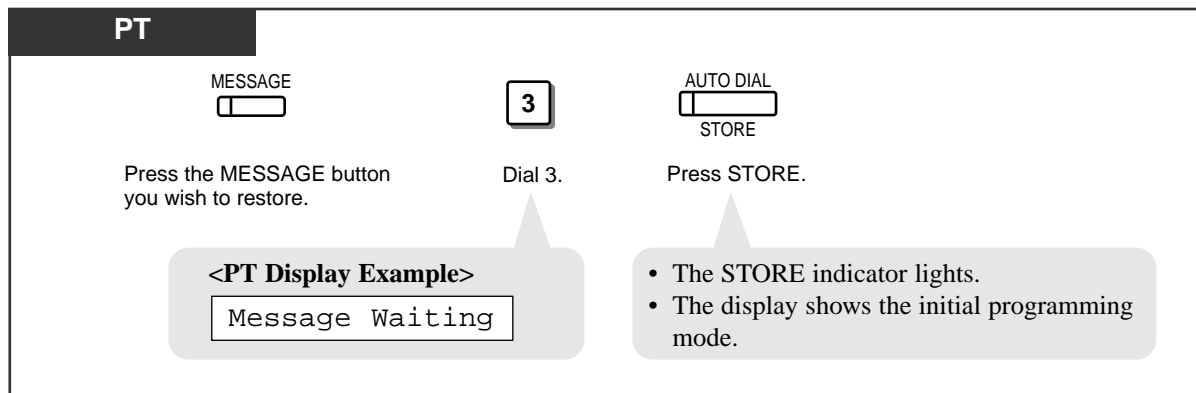

— To exit the Station Programming mode, set the MEMORY switch to “SET”.

Feature Reference

Message Waiting

2.2 Station Programming (Personal Programming)

SAVE Button (Assignment)

Allows you to assign a Flexible CO button as the SAVE button.

— Be sure that you are in the Station Programming mode. Set the MEMORY switch to “PROGRAM”.

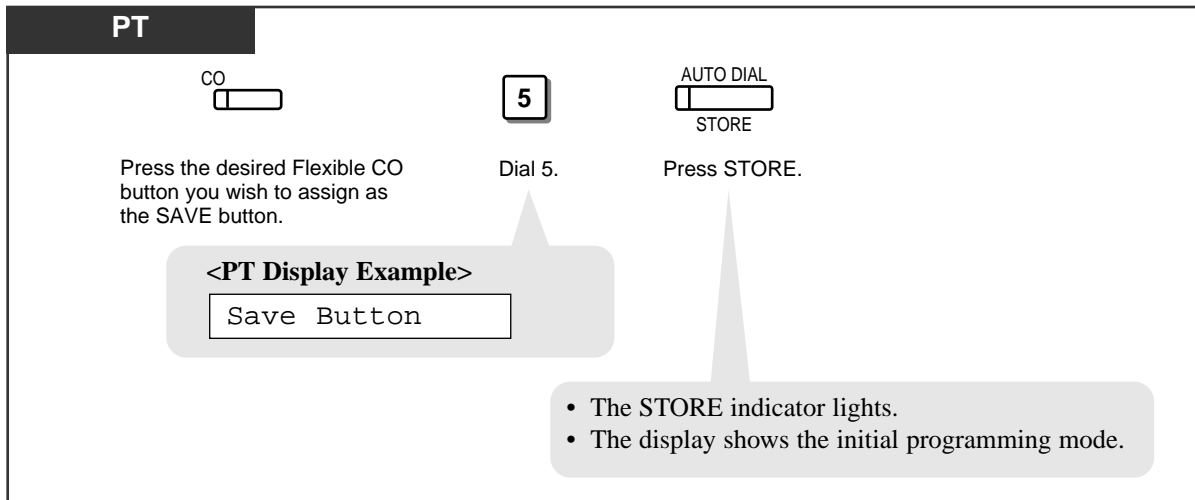

— To exit the Station Programming mode, set the MEMORY switch to “SET”.

Feature Reference

Redial, Saved Number

2.2 Station Programming (Personal Programming)

Single-CO (S-CO) Button (Assignment)

Allows you to assign a Flexible CO button as a Single-CO button.

— Be sure that you are in the Station Programming mode. Set the MEMORY switch to “PROGRAM”.

PT

CO

outside line (CO) no.

AUTO DIAL

STORE

Press the desired Flexible CO button you wish to assign as an S-CO button.

Dial 0.

Enter the outside (CO) line number (1 through 6).

Press STORE.

<PT Display Example>

CO-

<PT Display Example>

CO-x

outside (CO) line number

- The STORE indicator lights.
- The display shows the initial programming mode.

- To erase an incorrect entry, press the TRANSFER (CLEAR) button. (The TRANSFER button becomes the CLEAR button during programming.)

— To exit the Station Programming mode, set the MEMORY switch to “SET”.

Condition

- You can assign the same outside (CO) line to an S-CO and G-CO button.

2.2 Station Programming (Personal Programming)

Two-Way Record Button (Assignment)[†]

Allows you to assign a Flexible button (CO, DSS) as the Two-Way Record button. This allows you to record a conversation into your voice mailbox.

— Be sure that you are in the Station Programming mode. Set the MEMORY switch to “PROGRAM”.

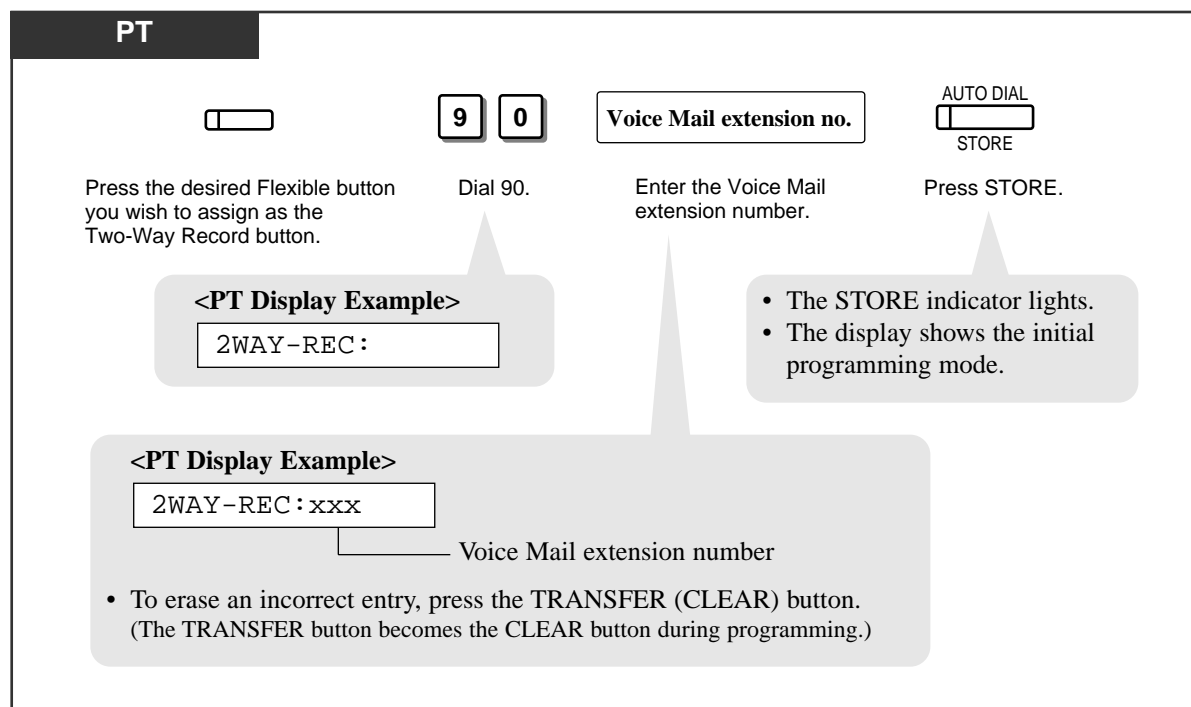

— To exit the Station Programming mode, set the MEMORY switch to “SET”.

Condition

- You cannot enter a non-existent extension number.
- A voice mail extension number must be assigned by System Programming.

Feature Reference

Two-Way Recording into Voice Mail

[†] Available when the KX-TA624 is connected to a Proprietary Telephone capable Panasonic Voice Processing System (one that supports APT Integration; KX-TVS50/KX-TVS80).

2.2 Station Programming (Personal Programming)

Two-Way Transfer Button (Assignment)[†]

Allows you to assign a Flexible button (CO, DSS) as the Two-Way Transfer button. This allows you to record a conversation into a desired mailbox.

— Be sure that you are in the Station Programming mode. Set the MEMORY switch to “PROGRAM”.

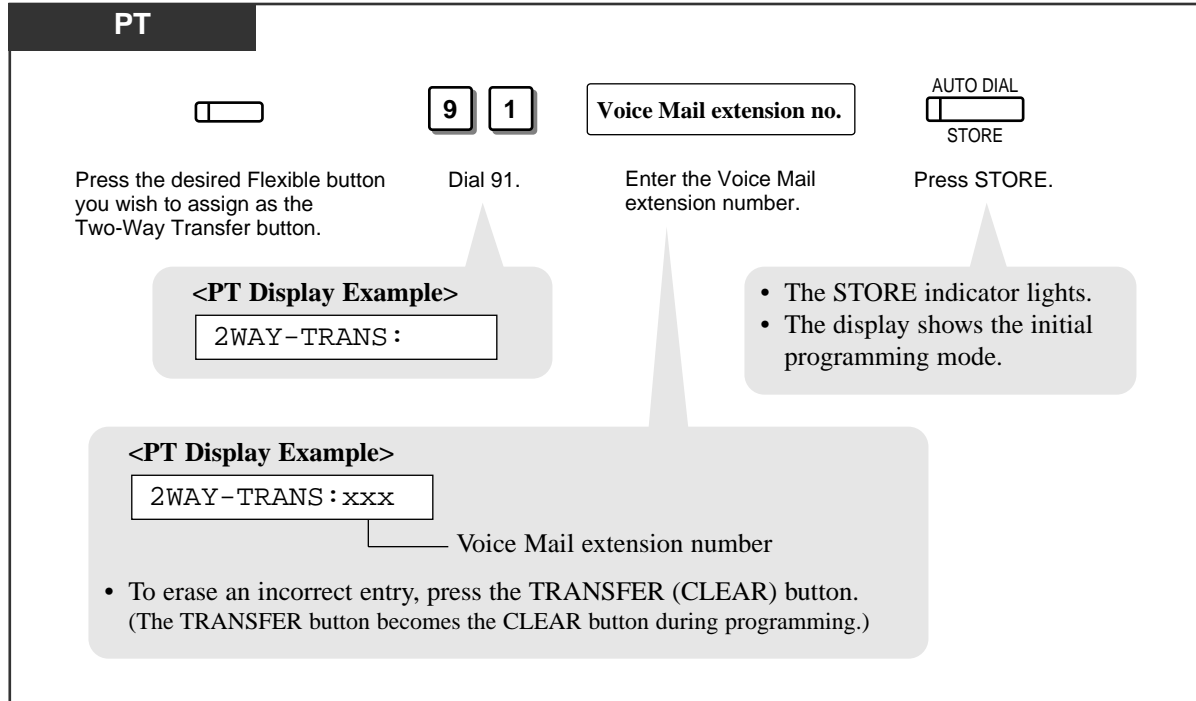

— To exit the Station Programming mode, set the MEMORY switch to “SET”.

Condition

- You cannot enter a non-existent extension number.
- A voice mail extension number must be assigned by System Programming.

Feature Reference

Two-Way Recording into Voice Mail

[†] Available when the KX-TA624 is connected to a Proprietary Telephone capable Panasonic Voice Processing System (one that supports APT Integration; KX-TVS50/KX-TVS80).

2.2 Station Programming (Personal Programming)

Voice Mail (VM) Transfer Button (Assignment)[†]

Allows you to assign a Flexible button (CO, DSS) as the VM Transfer button.

— Be sure that you are in the Station Programming mode. Set the MEMORY switch to “PROGRAM”.

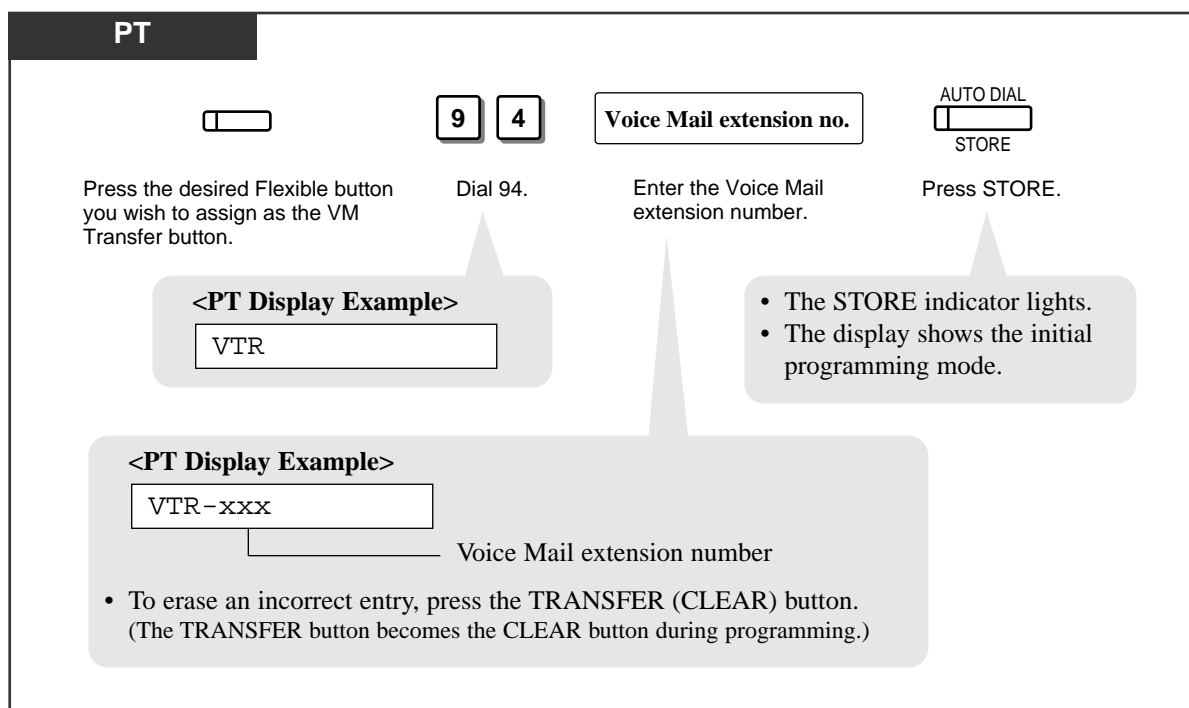

— To exit the Station Programming mode, set the MEMORY switch to “SET”.

Condition

- You cannot enter a non-existent extension number.
- A voice mail extension number must be assigned by System Programming.

Feature Reference

Voice Mail Transfer

[†] Available when the KX-TA624 is connected to a Proprietary Telephone capable Panasonic Voice Processing System (one that supports APT Integration; KX-TVS50/KX-TVS80).

2.2 Station Programming (Personal Programming)

Intercom Alert Assignment

Allows you to select the alert mode (tone/voice) when receiving an intercom (extension) call.

— Be sure that you are in the Station Programming mode. Set the MEMORY switch to “PROGRAM”.

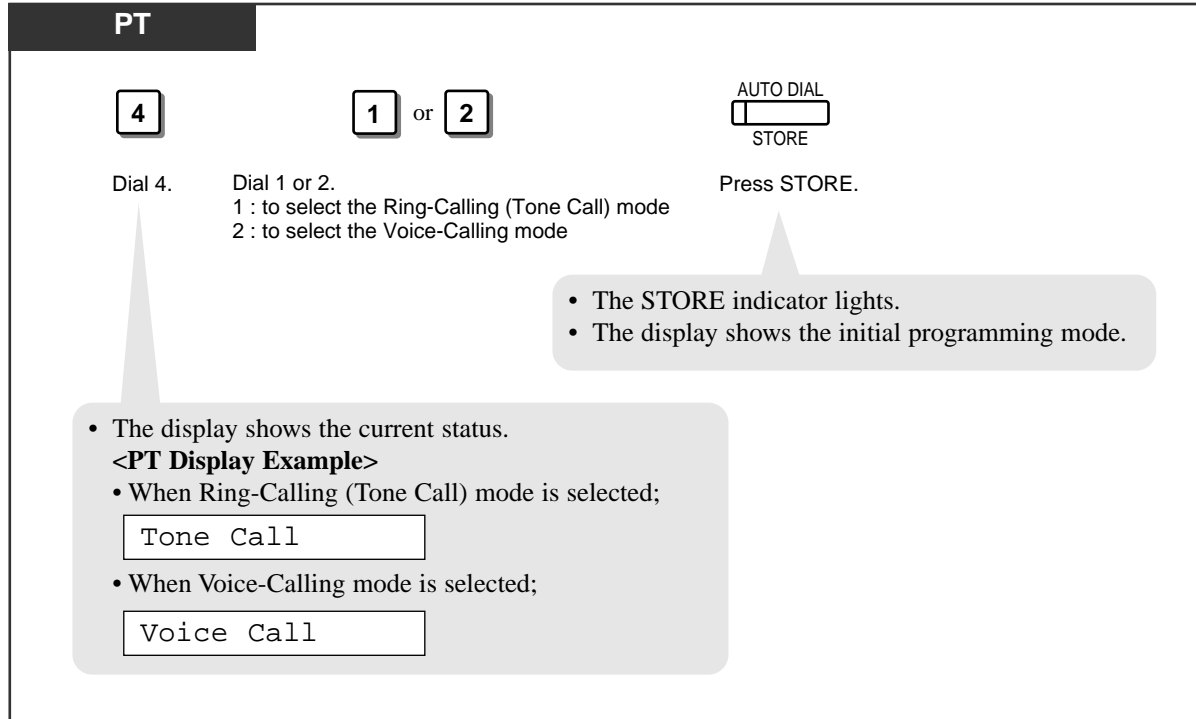

— To exit the Station Programming mode, set the MEMORY switch to “SET”.

Condition

- The default is “Ring-Calling (Tone Call)”.

2.2 Station Programming (Personal Programming)

Live Call Screening Mode Set[†]

Assign whether the recording message is monitored through the built-in speaker (Hands-free mode) or an alert tone is sent (Private mode) while incoming callers are leaving a message.

— Be sure that you are in the Station Programming mode. Set the MEMORY switch to “PROGRAM”.

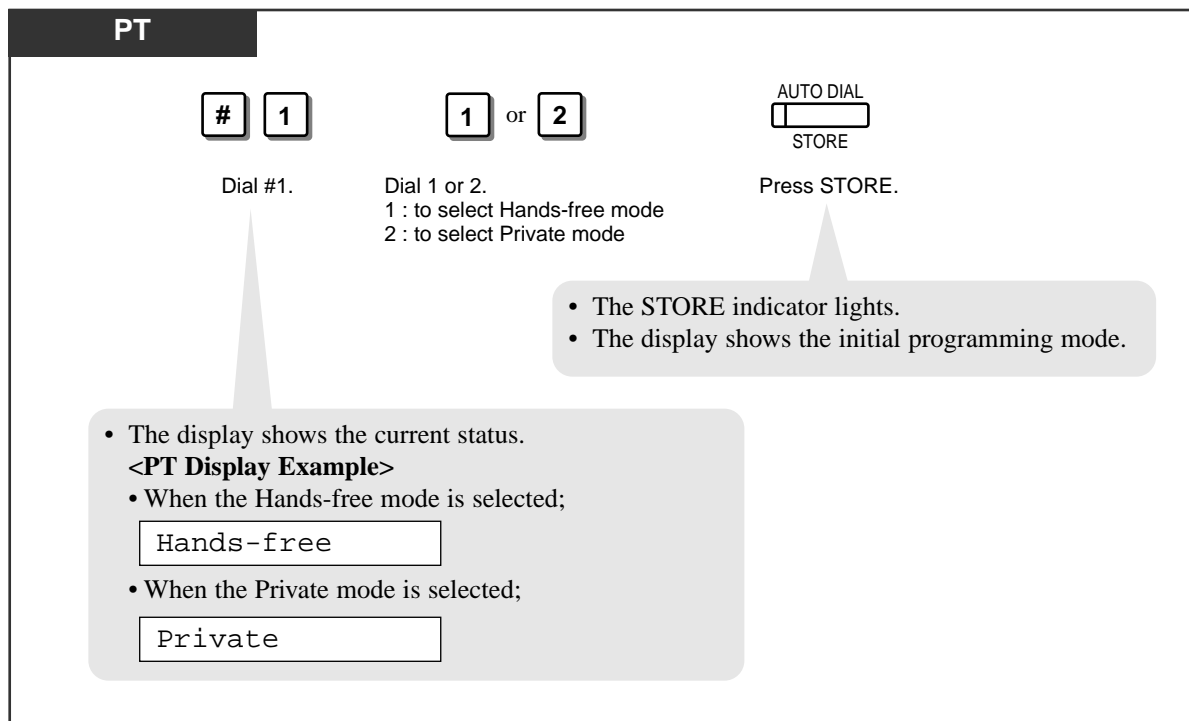

— To exit the Station Programming mode, set the MEMORY switch to “SET”.

Condition

- The default is the “Hands-free” mode.

Feature Reference

Live Call Screening (LCS)

[†] Available when the KX-TA624 is connected to a Proprietary Telephone capable Panasonic Voice Processing System (one that supports APT Integration; KX-TVS50/KX-TVS80).

2.2 Station Programming (Personal Programming)

Outside (CO) Line Ringing Selection

You can select whether the extension will ring or not when an outside call is received at your extension.

— Be sure that you are in the Station Programming mode. Set the MEMORY switch to “PROGRAM”.

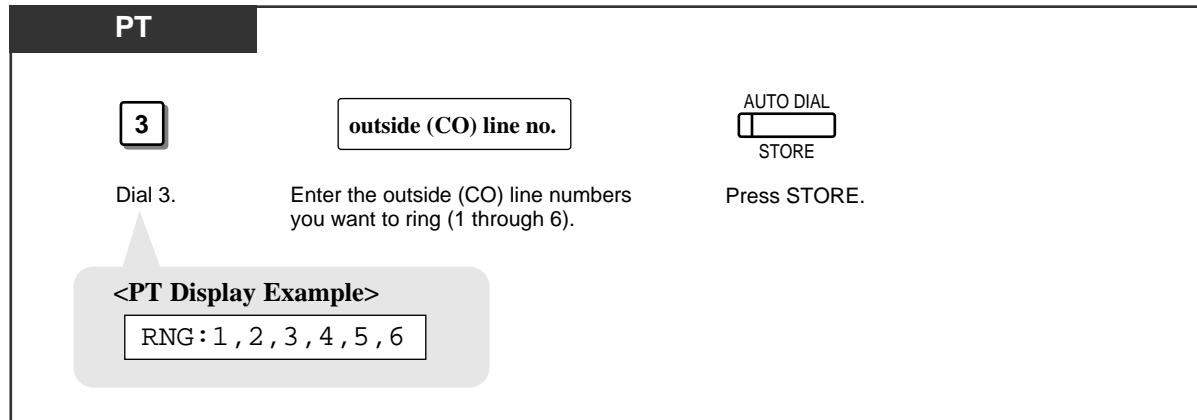

— To exit the Station Programming mode, set the MEMORY switch to “SET”.

Conditions

- The “Flexible Ringing Assignment” should be set to “Enable”. (Refer to System Programming.)
- When an outside call is received at extension but doesn’t ring, the CO indicator will flash. If you want to answer the outside call, press the flashing CO button.

Programming References

- System Programming — Installation Manual
[408]–[410] Flexible Ringing Assignment — Day/Night/Lunch

2.2 Station Programming (Personal Programming)

Preferred Line Assignment — Incoming

Allows you to select the method used to answer incoming outside calls from the following three line preferences.

- 1.) No Line Preference
- 2.) Ringing Line Preference (— default)
- 3.) Prime Line Preference

Follow the corresponding programming procedure according to your selection.

No Line Preference — Incoming (Assignment)

No line is selected when you go off-hook. You must select a line to answer an incoming call by pressing a CO button.

— Be sure that you are in the Station Programming mode. Set the MEMORY switch to “PROGRAM”.

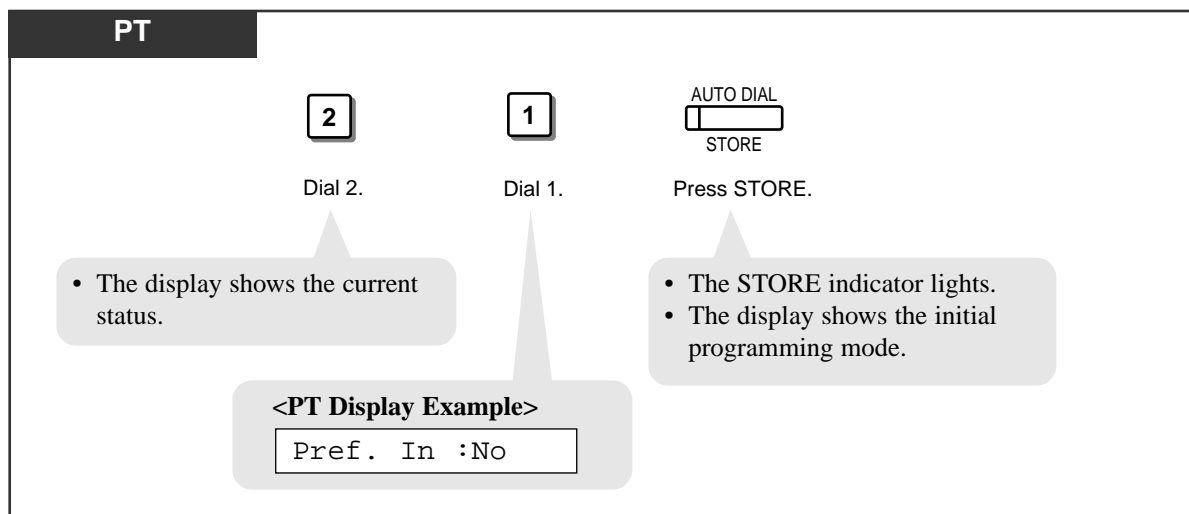

— To exit the Station Programming mode, set the MEMORY switch to “SET”.

2.2 Station Programming (Personal Programming)

Ringing Line Preference — Incoming (Assignment)

When you go off-hook, you can answer any call ringing at your telephone.

— Be sure that you are in the Station Programming mode. Set the MEMORY switch to “PROGRAM”.

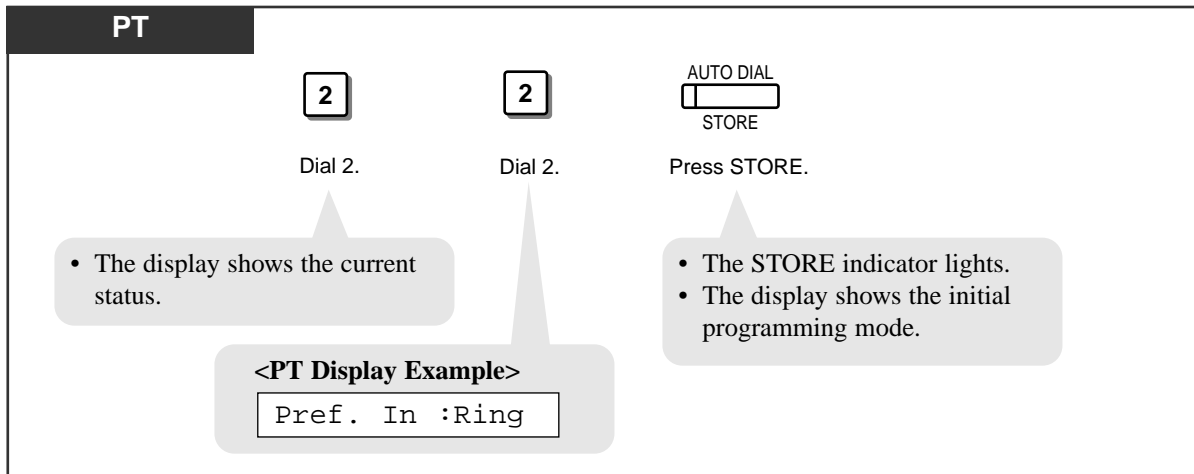

— To exit the Station Programming mode, set the MEMORY switch to “SET”.

Prime Line Preference — Incoming (Assignment)

When you go off-hook, you can answer a call on the line which is assigned as the prime line.

— Be sure that you are in the Station Programming mode. Set the MEMORY switch to “PROGRAM”.

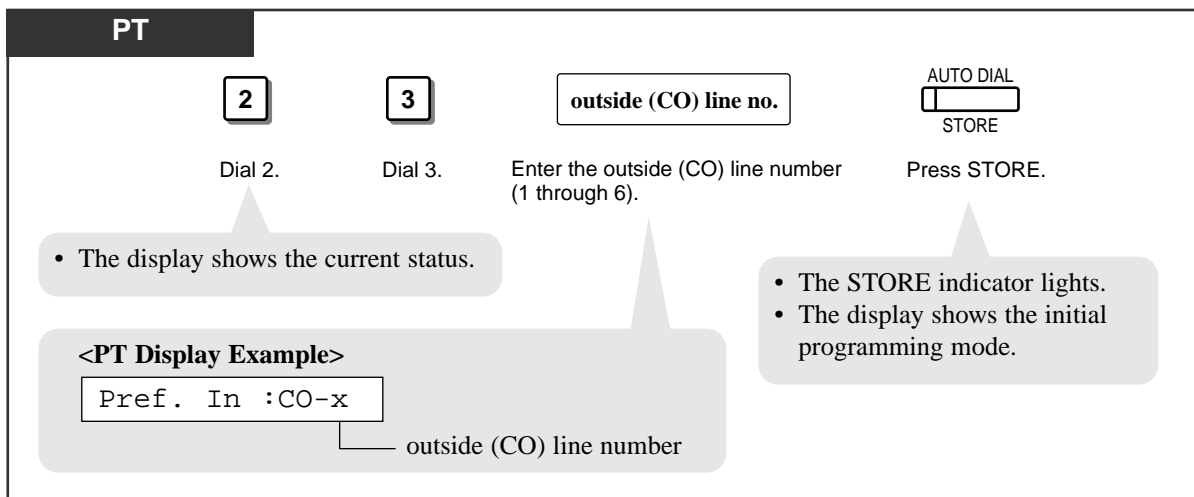

— To exit the Station Programming mode, set the MEMORY switch to “SET”.

2.2 Station Programming (Personal Programming)

Preferred Line Assignment — Outgoing

Allows you to select the desired outgoing line preference to originate calls from the following three line preferences.

- 1.) No Line Preference (— default)
- 2.) Idle Line Preference
- 3.) Prime Line Preference

Follow the programming procedure according to your selection.

<Note>

When setting “Idle Line Preference” or “Prime Line Preference”, you **cannot** access any PT features after going off-hook. To access these PT features, press the INTERCOM button before or after going off-hook.

No Line Preference — Outgoing (Assignment)

When going off-hook, you are not connected to any line. You must choose the line.

— Be sure that you are in the Station Programming mode. Set the MEMORY switch to “PROGRAM”.

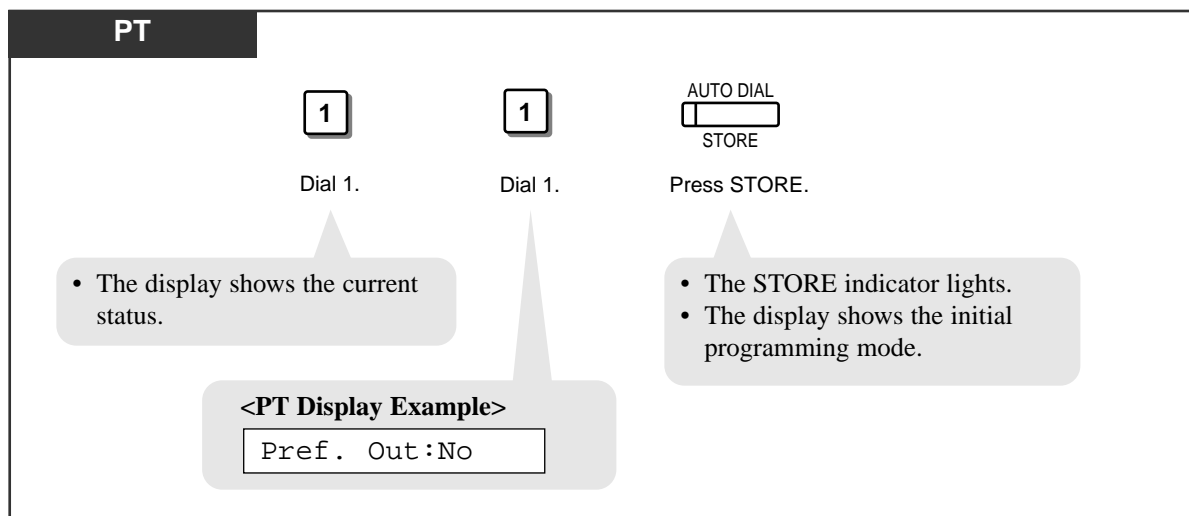

— To exit the Station Programming mode, set the MEMORY switch to “SET”.

2.2 Station Programming (Personal Programming)

Idle Line Preference — Outgoing (Assignment)

When going off-hook, you are connected to an idle line.

— Be sure that you are in the Station Programming mode. Set the MEMORY switch to “PROGRAM”.

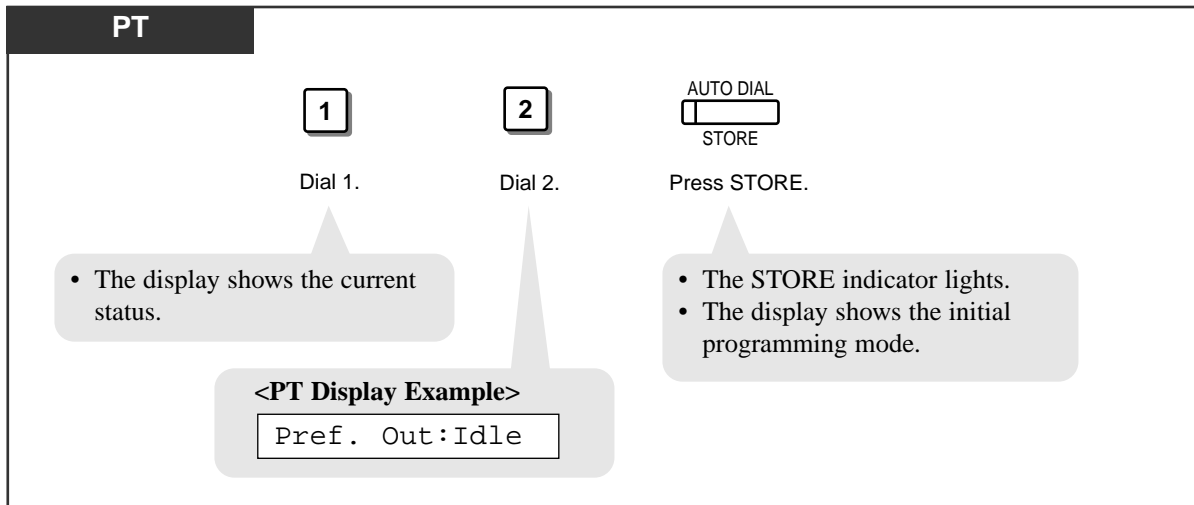

— To exit the Station Programming mode, set the MEMORY switch to “SET”.

Prime Line Preference — Outgoing (Assignment)

When going off-hook, you are connected to a pre-assigned line.

— Be sure that you are in the Station Programming mode. Set the MEMORY switch to “PROGRAM”.

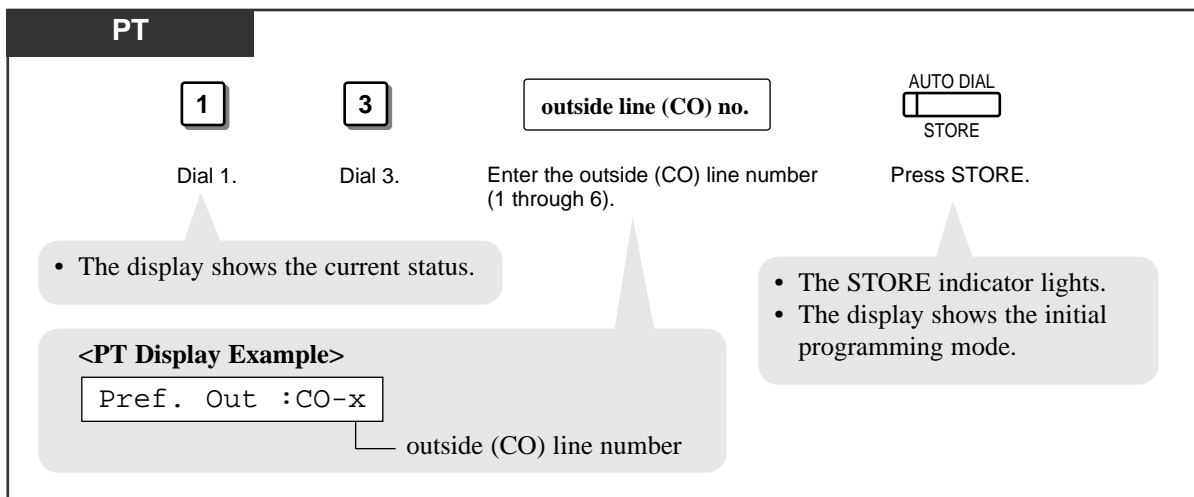

— To exit the Station Programming mode, set the MEMORY switch to “SET”.

2.2 Station Programming (Personal Programming)

Self-Extension Number Confirmation

(KX-T7030, KX-T7130 and KX-T7135 only)

Allows you to display your jack and extension number.

— Be sure that you are in the Station Programming mode. Set the MEMORY switch to “PROGRAM”.

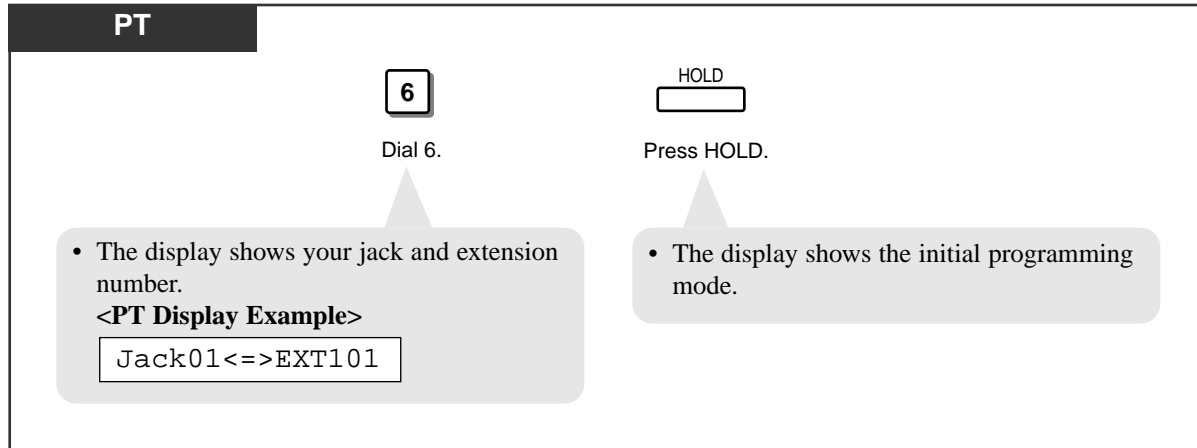

— To exit the Station Programming mode, set the MEMORY switch to “SET”.

2.2 Station Programming (Personal Programming)

Station Programming Data Default Set

Allows you to return each of the following programmable items to their default settings.

- a) Call Waiting Tone Type Assignment (default: Tone 1)
- b) Intercom Alert Assignment (default: Ring-Calling (Tone Call))
- c) Outside (CO) Line Ringing Selection (default: Ring – all outside (CO) lines)
- d) Preferred Line Assignment — Incoming (default: Ringing Line Preference)
- e) Preferred Line Assignment — Outgoing (default: No Line Preference)

— Be sure that you are in the Station Programming mode. Set the MEMORY switch to “PROGRAM”.

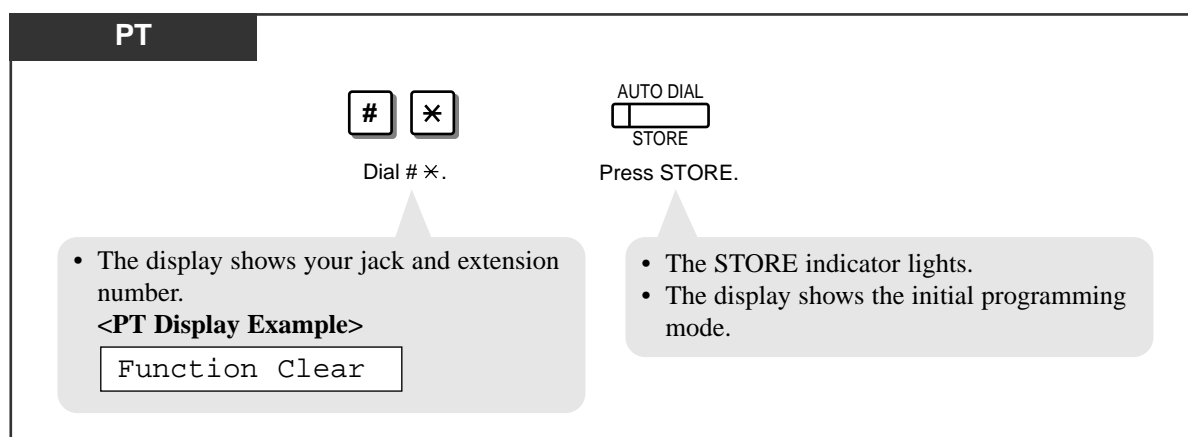

— To exit the Station Programming mode, set the MEMORY switch to “SET”.

Condition

- This feature also cancels the Hands-free Answerback feature and pressing the AUTO ANSWER/MUTE button in the Room Monitor feature.

Feature References

Hands-free Answerback
Room Monitor

Section 3

Telephone Features

Contents

3.1	<i>Basic Operations</i>	3-2
	<i>Making Calls</i>	3-2
	<i>Receiving Calls</i>	3-3
3.2	<i>Telephone Features (A - Z)</i>	3-4
3.3	<i>Operator/Manager Service Features</i> (— <i>for an Operator and Manager only</i>)	3-127

<Note>

When setting “Idle Line Preference — Outgoing” or “Prime Line Preference”, you **cannot** access any PT features after going off-hook. To access PT features, press the INTERCOM button before or after going off-hook.

If you use a rotary telephone:

It is not possible to access features which have “*” or “#” in their feature numbers except for the ones can use “0” instead of “#”.

When the “Pickup Dialing (Hot Line)” feature is set on your single line telephone, the dialing sequence should be completed within a pre-determined time (Pickup Dial Waiting Time — default: 3 sec.) after lifting the handset.

To change the time, refer to System Programming in the Installation Manual.

Refer to Section 5 “Tone List” for tones.

All PT illustrations used in these operating instructions are based on the KX-T7130/KX-T7135 model.

Making Calls**Intercom Calling**

Allows you to make a call to another extension.

Any Telephone



Lift the handset or press
SP-PHONE/MONITOR.

extension number

 or

Enter an extension number (100 through 199).
or press DSS.

- The INTERCOM indicator light turns green.

Outward Dialing

Allows you to make a call to an external party using one of the following line access methods.

- 1.) Line Access, Automatic
- 2.) Line Access, Individual
- 3.) Line Access, Outside (CO) Line Group

Any Telephone



Lift the handset
or press
SP-PHONE/MONITOR.

line access code

 or



Outside line
dial tone

phone number

Enter a line access code (9 or 81 through 86).
or press CO.
9: Line Access, Automatic
CO: Line Access, Individual
81 through 86: Line Access, Outside (CO) Line Group

Dial the phone number.

Conditions

- PT • There are three types of Line Preference for outgoing calls (— Idle Line/No Line/Prime Line). Each preference can be selected by Station Programming.
- PT • Helpful hints for the Hands-free (speakerphone) operation are noted in the “Hands-free Operation” feature.
- PT • When the unit is not in use, the Liquid Crystal Display will show:
 - the month, day and present time
 - the month, day, year and day of the week
 - your extension number and name

3.1

Basic Operations

Programming References

- Station Programming (Section 2)
Preferred Line Assignment — Outgoing
- System Programming — Installation Manual
[405]–[407] Flexible Outward Dialing Assignment — Day/Night/Lunch

Feature References

- Hands-free Operation
- Intercom Calling
- Outward Dialing — Line Access, Automatic
Line Access, Individual
Line Access, Outside (CO) Line Group

Receiving Calls

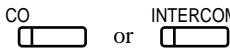
Any Telephone	PT
 <p>Lift the handset or press SP-PHONE.</p>	 <p>Press a rapidly flashing CO or INTERCOM.</p> <ul style="list-style-type: none">• The CO or INTERCOM indicator light turns steady green.

Conditions

- PT • There are three types of Line Preference for incoming calls (— No Line/Prime Line/Ringing Line). Each preference can be selected by Station Programming.
- PT • Helpful hints for the Hands-free (speakerphone) operation are noted in the “Hands-free Operation” feature.

Programming References

- Station Programming (Section 2)
Preferred Line Assignment — Incoming
- System Programming — Installation Manual
[400] Outside (CO) Line Connection Assignment
[408]–[410] Flexible Ringing Assignment — Day/Night/Lunch

Feature References

- Answering, Direct Outside (CO) Line
- Hands-free Operation

Absent Message Capability

Allows you to show the reason for your absence, if the calling extension uses a Panasonic proprietary telephone with a display.

This way the caller can know when or where you can be reached. You can choose one of six messages.

Message No.	Message
1	Will Return Soon
2	Gone Home
3	At Ext % % % └── Extension number
4	Back at % % : % % AM (or PM) └── Minute └── Hour
5	Out until % % / % % └── Day └── Month
6	In a Meeting

Note: Enter the desired value in the “%” space. You must make an entry in all of the %s using 0 through 9.

3.2 Telephone Features

A

Setting

Message 1. "Will Return Soon"

Any Telephone

Lift the handset or press SP-PHONE/MONITOR.

Dial 751#.

Confirmation tone and dial tone

Hang up or press SP-PHONE/MONITOR.

- Single line telephone users can dial "0" instead of "#".

Message 2. "Gone Home"

Any Telephone

Lift the handset or press SP-PHONE/MONITOR.

Dial 752#.

Confirmation tone and dial tone

Hang up or press SP-PHONE/MONITOR.

- Single line telephone users can dial "0" instead of "#".

Message 3. "At Ext %%" (extension number)

Any Telephone

Lift the handset or press SP-PHONE/MONITOR.

Dial 753.

Enter the extension number (100 through 199) where you will be.

Dial #.

Confirmation tone and dial tone

Hang up or press SP-PHONE/MONITOR.

- Single line telephone users can dial "0" instead of "#".

Message 4. "Back at % : % AM (or PM)" (time)

Any Telephone

Lift the handset or press SP-PHONE/MONITOR.

Dial 754.

Enter the hour (01 through 12) and minute (00 through 59).

Dial 0 or 1.

Dial #.

Confirmation tone and dial tone

Hang up or press SP-PHONE/MONITOR.

- Single line telephone users can dial "0" instead of "#".

Message 5. "Out until %% / %%" (month/day)

Any Telephone

Lift the handset or press SP-PHONE/MONITOR.

Dial 755.

Enter the month (01 through 12) and day (01 through 31).

Dial #.

Confirmation tone and dial tone

Hang up or press SP-PHONE/MONITOR.

- Single line telephone users can dial "0" instead of "#".

Message 6. "In a Meeting"

Any Telephone

Lift the handset or press SP-PHONE/MONITOR.

Dial 756#.

Confirmation tone and dial tone

Hang up or press SP-PHONE/MONITOR.

- Single line telephone users can dial "0" instead of "#".

Canceling

Any Telephone

Lift the handset or press SP-PHONE/MONITOR.

Dial 750#.

Confirmation tone and dial tone

Hang up or press SP-PHONE/MONITOR.

<PT Display Example>

Message Cancel

- Single line telephone users can dial "0" instead of "#".

Condition

- PT • To confirm the message, go off-hook. It will be displayed.

Account Code Entry

An account code is used to identify outside calls for accounting and billing purposes. The account code is appended to the “Station Message Detail Recording (SMDR)” call record. For incoming outside calls, account codes are not required. For outgoing outside calls, account codes are often required. You can enter account codes in the following four modes.

Verify - All mode: You must always enter a pre-assigned account code.

Verify - Toll mode: You can enter a pre-assigned account code so that you can override toll restriction.

Option mode: An account code can be entered when a record of the account code is required. It can be any number.

Forced mode: You must always enter an account code. It can be any number.

Making calls with account codes except in the Option mode

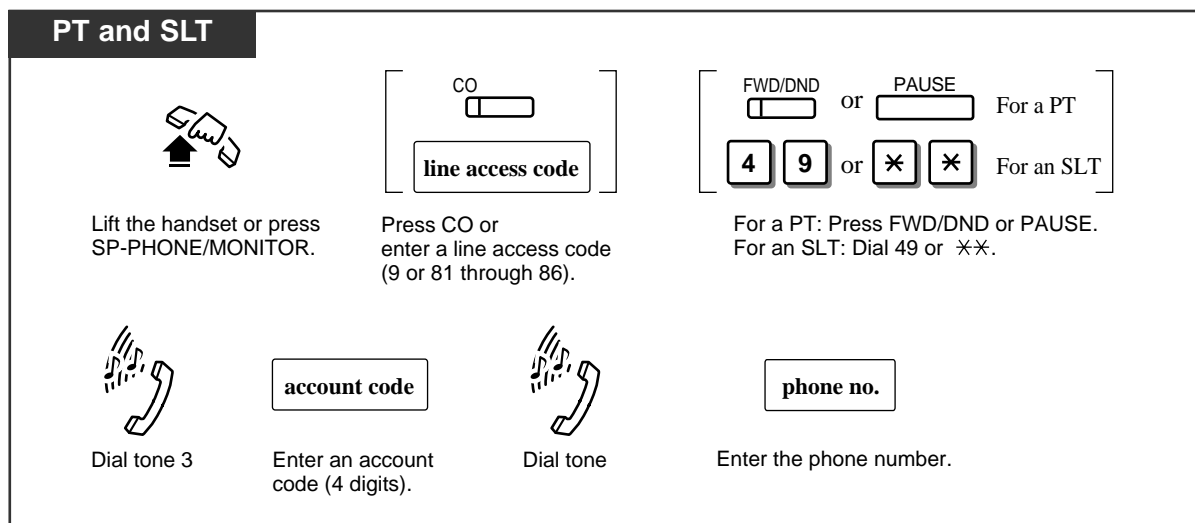

Making calls with account codes in the Option mode and receiving calls

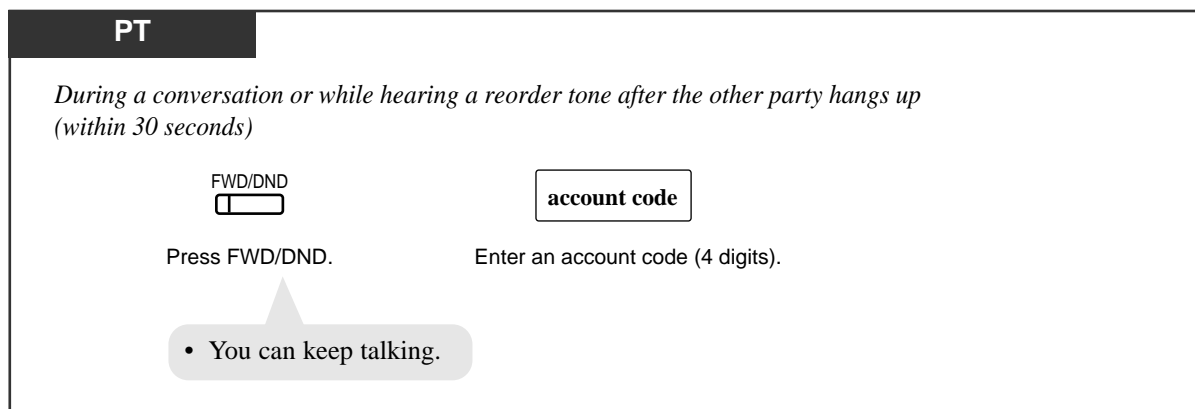

Conditions

- In the Verify-All mode, you must always enter a pre-assigned account code when making any of the following calls unless one has previously been stored in memory.
 - a) Call Forwarding — to an Outside (CO) Line
 - b) Manual Dialing (Selecting an outside (CO) line)
 - c) One-Touch Dialing (PT only)
 - d) Pickup Dialing (Hot Line) (SLT only)
 - e) Personal Speed Dialing
 - f) System Speed Dialing
- In the Verify-Toll mode, you can enter a pre-assigned account code only when you need to override toll restriction.
- In the Option mode, you can record a calling or called party's account code in the SMDR during a conversation or within thirty seconds after the other party hangs up.
- You do not need to make an account code entry when receiving incoming calls.
- You can clear and re-enter a number by pressing “* *” or the FWD/DND button while entering an account code.
- An account code can be stored into Memory Dialing (“One-Touch Dialing”, “Pickup Dialing (Hot Line)”, “System/Personal Speed Dialing”, “Call Forwarding — to Outside (CO) Line”). To store an account code, “* *” must be entered before the account code. Example (Pickup Dialing):
 — [Off-hook] [742] [Line Access Code] [* *] [Account Code] [Phone Number] [#]
 [On-hook]
- If an entered account code does not match the pre-assigned account code in the verify-all mode, when making an outside call, a reorder tone is heard.
- PT • An account code has four digits (0 through 9). FLASH, PAUSE, etc. cannot be used.

Programming References

- System Programming — Installation Manual
 - [310] Account Codes
 - [601]–[603] TRS – Class of Service (COS) Assignment — Day/Night/Lunch
 - [605] Account Code Entry Mode
 - [805] SMDR Account Code Selection

Feature References

- Station Message Detail Recording (SMDR) (→ See the Installation Manual.)
- Toll Restriction Override by Account Codes

Answering, Direct Outside (CO) Line

Allows you to answer an outside call by pressing a CO button. You do not have to lift the handset or press the SP-PHONE/MONITOR button.

To answer an incoming outside call

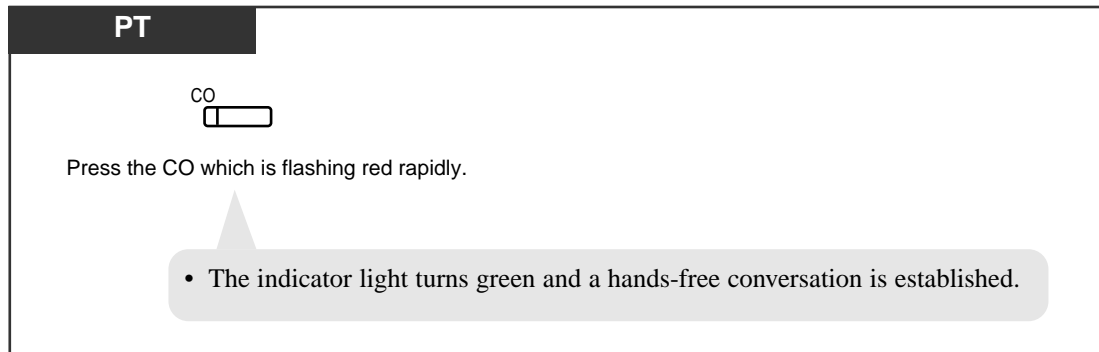

Conditions

- PT** • Specify which line is connected when multiple incoming outside calls arrive at the same time.
- PT** • There are three types of CO buttons: Group-CO (G-CO) button, Other-CO (O-CO) button and Single-CO (S-CO) button. These can be assigned to flexible CO buttons by Station Programming.
- PT** • This feature is not available for the KX-T7050 and KX-T7055.

Programming References

- Station Programming (Section 2)
 - Flexible Button Assignment — Group-CO (G-CO) Button,
Other-CO (O-CO) Button,
Single-CO (S-CO) Button
 - Preferred Line Assignment — Incoming

Feature Reference

Hands-free Operation

Automatic Callback Busy (Camp-On)

Allows you to receive callback ringing when the dialed line becomes idle. When you answer the callback ringing;

For an extension: The called extension starts ringing without dialing.

For an outside (CO) line: The line is seized.

Setting

Any Telephone

If you hear a busy tone



Dial 6.



Confirmation tone and reorder tone



Hang up or press SP-PHONE/MONITOR.

Wait for the Camp-On recall.

<PT Display Example>

Callback Ext xxx

└── extension number

Answering an intercom recall

Any Telephone

If you hear the telephone ringing



Lift the handset or press SP-PHONE/MONITOR.

<PT Display Example>

xxx: Tony

└── extension number

- You hear a ringback tone and the called extension rings automatically.

3.2 Telephone Features

A

Answering an outside (CO) line recall

Any Telephone

If you hear the telephone ringing



Lift the handset or press SP-PHONE/MONITOR .



Dial tone

phone no.

Enter the phone number.

<PT Display Example>

CO x Free

outside (CO) line number

Canceling

Any Telephone



Lift the handset or press SP-PHONE/MONITOR.

Condition

- If you do not answer within four callback ring signals (within 10 seconds), this feature will be canceled.

Background Music (BGM)

You can listen to background music through the built-in speaker of the telephone. An external music source, such as a radio, can be connected. The music stops whenever a call comes in, a page comes in, or you go off-hook.

Setting / Canceling

PT

When the handset is on the cradle and the SP-PHONE/MONITOR button is off

1

Dial 1.

- The display shows either of the following for five seconds depending on whether BGM is on or off:
<PT Display Example>

BGM on

or

BGM off

Busy Station Signaling (BSS)

The busy extension that you called will hear the assigned Call Waiting tone and know that you are waiting.

Any Telephone

If you make an intercom call and hear a busy tone

1

Wait for an answer and talk.

Dial 1.

Conditions

- To answer from the calling extension, see “Call Waiting” in this manual.
- If you hear a reorder tone when you set this feature, this feature cannot be operated with the called party. This feature is only available if the called extension has set the “Call Waiting” feature.

Feature Reference

Call Waiting

Call Forwarding — SUMMARY

Automatically transfers incoming calls to another extension or to an external destination. The following types are available.

Type	Description
Call Forwarding — All Calls	All incoming calls are forwarded to another extension.
Call Forwarding — Busy/No Answer	All incoming calls are forwarded to another extension when you do not answer or your extension is busy.
Call Forwarding — to Outside (CO) Line	All incoming calls are forwarded to an outside (CO) line.
Call Forwarding — Follow Me	Allows you to set the “Call Forwarding — All Calls” feature from another extension.

Note: You can also set Voice Mail as the forwarding destination. Refer to “Voice Mail Integration for KX-TVS50/KX-TVS75/KX-TVS80/KX-TVS100/KX-TVS110” in this manual.

Conditions

- To cancel the Call Forwarding features, refer to “Call Forwarding — CANCEL” in this manual.
- Call Forwarding can only be extended to one target telephone. For example, extension A is forwarded to extension B, and if extension B tries to set Call Forwarding to extension C, an alarm tone will be heard and the setting will be rejected. If extension B has already set Call Forwarding to extension C, and extension A tries to set Call Forwarding to extension B, the setting will be also rejected.

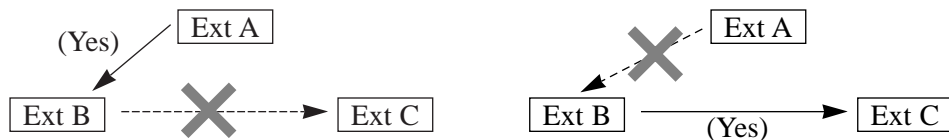

- If the destination extension has already set “Do Not Disturb”, you cannot forward any calls to the extension.
- Setting a new “Call Forwarding” feature (All Calls, Busy/No Answer, etc.) cancels any other “Call Forwarding” features or the “Do Not Disturb (DND)” feature.
- If your entry is valid, confirmation tone 1 (one beep) is sent. If your entry is the same as previously programmed data, confirmation tone 2 (two beeps) is sent. Refer to the “Tone List” in the Appendix (Section 5).
- You can call the original extension from the Call Forwarding destination extension. (For example, Boss Secretary)
- Camp-On recall and Hold recall are not forwarded.

3.2 Telephone Features

C

- PT** • A flexible CO button on the KX-T7050 and KX-T7055 (no FWD/DND button provided) can be assigned as the FWD/DND button.
- PT** • The lighting patterns of the FWD/DND button are as follows.
 - Off: Both features are not set.
 - Red: DND mode
 - Flashing red slowly: FWD mode
- PT** • You can check the assignment by pressing the FWD/DND button while on-hook.

Programming Reference

- Station Programming (Section 2)
 - Flexible Button Assignment — FWD/DND Button

Feature References

Call Forwarding — CANCEL

Do Not Disturb (DND)

Voice Mail Integration for KX-TVS50/KX-TVS75/KX-TVS80/KX-TVS100/KX-TVS110

Call Forwarding — All Calls

You can re-direct all of your calls to another extension.

Setting

PT and SLT

Lift the handset or press SP-PHONE/MONITOR.

For a PT: Press FWD/DND. For an SLT: Dial 71.

Dial 1.

Enter the destination extension number (100 through 199).

Dial #.

Confirmation tone and dial tone.

Hang up or press SP-PHONE/MONITOR.

You may press the flexible button assigned as the FWD/DND button instead.

<PT Display Example>
FWD(All) Extxxx
extension number where the call is to be forwarded

- The FWD/DND indicator light flashes red slowly.
- Single line telephone users can dial "0" instead of "#".

Call Forwarding — Busy/No Answer

You can forward your calls to another extension when your extension is busy or if you do not answer the call within a pre-determined time.

Setting

PT and SLT

Lift the handset or press SP-PHONE/MONITOR.

FWD/DND For a PT
7 1 For an SLT

For a PT: Press FWD/DND.
For an SLT: Dial 71.

Dial 2. Enter the destination extension number (100 through 199).

Dial #.

Confirmation tone and dial tone

Hang up or press SP-PHONE/MONITOR.

- You may press the flexible button assigned as the FWD/DND button instead.

<PT Display Example>

FWD (B/NA) Extxxx

extension number where the call is to be forwarded

- The FWD/DND indicator light flashes red slowly.
- Single line telephone users can dial “0” instead of “#”.

Programming Reference

- System Programming — Installation Manual
[202] Call Forwarding Start Time

3.2 Telephone Features

C

Call Forwarding — to an Outside (CO) Line

You can forward calls to an external party.
System programming is required to execute this feature.

Setting

PT and SLT

Lift the handset or press SP-PHONE/MONITOR.

For a PT: Press FWD/DND.
For an SLT: Dial 7 1.

Dial 3. Enter the line access code (9 or 81 through 86).

Enter the phone number.

Dial #. Confirmation tone and dial tone

Hang up or press SP-PHONE/MONITOR.

<PT Display Example>

- When you dial line access code “9”:
FWD(All) All COs
- When you dial line access code “81 through 86”:
FWD(All) CO Gx
outside (CO) line group number

- The FWD/DND indicator light flashes red slowly.

Conditions

- If an incoming outside call is forwarded to an outside (CO) line, the “Outside-to-Outside (CO-to-CO) Line Call Duration Time” is applied to the call and the line will be disconnected when it expires (default: 10 minutes). An alarm tone is sent to both parties fifteen seconds before the assigned duration time limit.
- Up to thirty-two digits (including the line access code) can be programmed.
- If a CPC signal is sent to an outside (CO) line before the assigned duration time limit, a call between two external parties will be disconnected.
- This feature cannot be used for incoming outside calls from lines assigned as “Normal”, by System Programming.
- An account code must be entered by pressing “* *” and entering the account code after the line access code in the account code verify-all and forced modes.

Programming References

- System Programming — Installation Manual
 - [205] Outside-to-Outside (CO-to-CO) Line Duration Time Limit
 - [414]–[416] Outside (CO) Line Mode — Day/Night/Lunch
 - [605] Account Code Entry Mode
 - [607] Call Forwarding to an Outside (CO) Line

Call Forwarding — Follow Me

You can set the “Call Forwarding” feature from the destination extension. This is useful if you forget to set “Call Forwarding — All Calls” before you leave your desk.

Setting

PT and SLT

At the destination extension



Lift the handset or press SP-PHONE/MONITOR.

FWD/DND

For a PT

7

1

For an SLT

5

Dial 5.

extension no.

#

Dial #.



Confirmation tone and dial tone



Hang up or press SP-PHONE/MONITOR.

- You may press the flexible button assigned as the FWD/DND button instead.

<PT Display Example>

FWD(From) Extxxx

└─ your extension number

- The FWD/DND indicator light flashes red slowly at your extension.
- Single line telephone users can dial “0” instead of “#”.

Condition

- This feature can be canceled at your extension or the destination extension.

Call Forwarding — CANCEL

There are two canceling methods for “Call Forwarding”. The canceling depends on the Call Forwarding type that has been assigned.

Canceling Call Forwarding at your (original) extension

PT and SLT



Lift the handset or press SP-PHONE/MONITOR.

FWD/DND

For a PT

7

1

For an SLT

For a PT: Press FWD/DND.
For an SLT: Dial 71.

0

#

Dial 0. Dial #.



Confirmation tone and dial tone



Hang up or press SP-PHONE/MONITOR.

- You may press the flexible button assigned as the FWD/DND button instead.

<PT Display Example>

FWD/DND Cancel

- The FWD/DND indicator light turns off.
- Single line telephone users can dial “0” instead of “#”.

Canceling Call Forwarding at the destination extension — “Follow Me (All Calls)” only

PT and SLT



Lift the handset or press SP-PHONE/MONITOR.

FWD/DND

For a PT

7

1

For an SLT

For a PT: Press FWD/DND.
For an SLT: Dial 71.

8

extension no.

#

Dial 8. Enter your extension number. Dial #.



Confirmation tone and dial tone



Hang up or press SP-PHONE/MONITOR.

- You may press the flexible button assigned as the FWD/DND button instead.

<PT Display Example>





FWD/DND Cancel

- The FWD/DND indicator light turns off at your extension.
- Single line telephone users can dial “0” instead of “#”.



Call Hold

Allows you to place a call on hold.

To place a call on hold

PT	SLT
<p><i>During a conversation</i></p> <p> Press HOLD.</p> <p> Confirmation tone and dial tone</p> <ul style="list-style-type: none">• You may replace the handset.• The corresponding CO or INTERCOM indicator light flashes green slowly.	<p><i>During a conversation</i></p> <p> Flash the hookswitch.</p> <p> Confirmation tone and dial tone</p> <ul style="list-style-type: none">• You may replace the handset.

Retrieving a call on hold

PT	SLT
<p><i>At the holding extension</i></p> <p> or  Press the CO or INTERCOM which is flashing green slowly.</p> <ul style="list-style-type: none">• The CO or INTERCOM indicator light turns steady green.	<p><i>At the holding extension</i></p> <p> Flash the hookswitch.</p> <ul style="list-style-type: none">• If the handset is replaced, just off-hook to retrieve the call.

Conditions

- To retrieve a call on hold at another extension, refer to “Call Hold Retrieve” in this manual.
- If a held call is not retrieved within a pre-determined time (default: 30 seconds), “Hold Alarm/Hold Recall” occurs. If the hold recall time is set to “Disable”, it will not be recalled.
- If a held outside call is not answered within thirty minutes, it will be automatically disconnected.
- When going off-hook:
 - Before recalling: A dial tone will be heard while the call is on hold. You may dial another telephone number.
 - While recalling: Only the first call on hold will be released and enter the conversation mode.
- You cannot hold a doorphone call.
- PT • With outside calls, you can put multiple calls on hold. However, with intercom calls, you can put only one call on hold. One way around this is to use the Call Park feature.
- PT • If a call is placed on hold for more than the programmed time, ringing or an alarm tone will be heard (Hold Recall/Hold Alarm) and the following displays will be shown. While the alarm tone is being sent, the LCD will flash.
 - Example:
 - When holding extension 111, Mr. Brown: “111: Brown” will be displayed.
 - When holding outside (CO) line, CO 1: “Call on CO 1” will be displayed.
- SLT • If “Hold-2” or “Hold-3” is assigned by System Programming, you must dial “20” after flashing the hookswitch.
- SLT • Only an outside or intercom call can be placed on hold at one time. If you want to hold both calls, use the Call Park feature.

Programming References

- System Programming — Installation Manual
 - [104] Hold Mode Selection
 - [200] Hold Recall Time

Feature References

Call Hold Retrieve
Call Park
Hold Alarm/Hold Recall (→ See the Installation Manual.)

Call Hold, Exclusive

Prevents other extension users from retrieving your held call. Only the user who held the call can retrieve it.

To place a call on exclusive hold

PT

During a conversation

HOLD
Press HOLD.

HOLD
Press HOLD again.

- The CO or INTERCOM indicator light flashes green slowly.
- The current call is placed on hold.

- The CO or INTERCOM indicator light flashes green moderately.
- The current call is placed on exclusive hold.

Retrieving a call on exclusive hold

PT

CO or **INTERCOM**
Press the CO or INTERCOM which is on exclusive hold.

- The CO or INTERCOM indicator light turns steady green.
- The held call is released.

Conditions

- PT** • If a held call is not retrieved within a pre-determined time (default: 30 seconds), Hold Alarm/Hold Recall occurs.
- PT** • If an outside call is placed on hold and not retrieved within thirty minutes, it will be automatically disconnected.
- PT** • With outside calls, you can put multiple calls on exclusive hold. However, with intercom calls, you can put only one call on exclusive hold.

Programming Reference

- System Programming — Installation Manual
[200] Hold Recall Time





Feature References

Call Hold
Hold Alarm/Hold Recall (→ See the Installation Manual.)



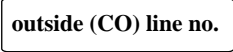

Call Hold Retrieve

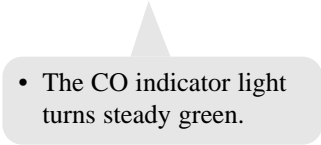
Allows you to retrieve a call that has been placed on hold by another extension.

Retrieving an outside call on hold

Any Telephone	PT
<p data-bbox="272 537 506 562"><i>At the other extension</i></p> <div data-bbox="337 583 422 651"></div> <p data-bbox="289 684 513 751">Lift the handset or press SP-PHONE/MONITOR.</p> <div data-bbox="496 596 602 646"></div> <p data-bbox="516 684 587 705">Dial 53.</p> <div data-bbox="634 596 865 646"></div> <p data-bbox="646 684 854 751">Enter the held outside (CO) line number (1 through 6).</p> <div data-bbox="906 562 977 672"></div> <p data-bbox="886 684 1010 726">Confirmation tone</p>	<p data-bbox="1075 537 1308 562"><i>At the other extension</i></p> <div data-bbox="1179 596 1256 646"></div> <p data-bbox="1107 684 1393 726">Press the CO whose indicator is flashing red slowly.</p> <div data-bbox="1075 743 1393 886"><ul style="list-style-type: none">• The CO indicator light turns steady green.</div>

Retrieving an intercom call on hold

Any Telephone
<p data-bbox="315 1100 548 1125"><i>At the other extension</i></p> <div data-bbox="451 1150 535 1218"></div> <p data-bbox="383 1251 613 1293">Lift the handset or press SP-PHONE/MONITOR.</p> <div data-bbox="699 1163 751 1213"></div> <p data-bbox="699 1251 760 1272">Dial 5.</p> <div data-bbox="862 1163 1034 1213"></div> <p data-bbox="829 1251 1086 1293">Enter the holding extension number (100 through 199).</p> <div data-bbox="1179 1129 1256 1239"></div> <p data-bbox="1140 1251 1308 1272">Confirmation tone</p>

Conditions

- “Call Park” and “Exclusive Call Hold” cannot be retrieved by this feature.
- You can hear a confirmation tone when the call is retrieved by entering the feature number.

Feature References

Call Hold
Call Hold, Exclusive
Call Park

Call Information/Log, Incoming

Provides you with the caller's telephone number and name simultaneously on the outside (CO) line assigned to receive Caller ID service* calls. If the call is not answered, the call information is automatically recorded.

Display Operation (— for the KX-T7030, KX-T7130 and KX-T7135)

JOHN WHITE

While receiving an incoming outside call, the display shows the caller's telephone number or name.

- If you want to see other information, press the Caller ID Selection button or press #.
- The display changes as follows.

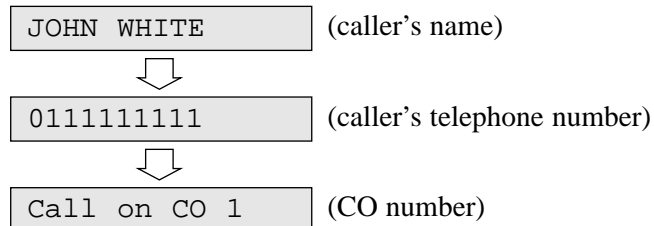

1. Lift the **handset** or press the **SP-PHONE** button.
2. Press the **Caller ID Selection** button to see other information.
 - The display changes as follows.

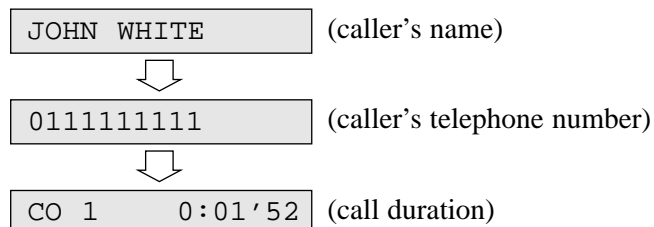

Conditions

- The Caller ID Indication button indicator light may turn on when a call is received.
- Even if you answer a call, the call information can be recorded by pressing the Caller ID Indication button during the conversation.
- You can modify and call back the logged numbers. Refer to the “Call Log, Incoming” feature.
- A caller's name will not be displayed unless it is sent from the Central Office.
- System Programming determines which is displayed first, the name or number.
- You can program by System Programming whether or not to print out a Caller ID number on the SMDR.
- You can also program by System Programming whether or not to print out a Caller ID number on the SMDR before the call is answered.
- If “OUT OF AREA” is displayed, the call may be from out of the calling area.
- If “LONG DISTANCE” is displayed, it may be a long distance call.
- If “PRIVATE” is displayed, the caller chose not to reveal their information.

3.2 Telephone Features

C

Programming References

- Station Programming (Section 2)
Flexible Button Assignment — Caller ID Indication Button,
Caller ID Selection Button
- System Programming — Installation Manual
 - [900] Caller ID Assignment
 - [904] Caller ID Log Priority Selection
 - [906] Caller ID SMDR Format
 - [907] Caller ID SMDR Printout Selection

Feature References

Call Log, Incoming
Call Log Lock, Incoming in the Personal Area
Call Log Lock, Incoming in the Common Area (3.3 Operator/Manager Service Features)

* The Caller ID service provides you with the caller's information, such as the name and telephone number, on the outside (CO) line assigned to receive Caller ID service calls. Refer to the Installation Manual.

Call Log, Incoming

If a call is not answered, the incoming outside call information from the Caller ID service* is automatically logged in the system and the Caller ID Indication button indicator lights. There are two kinds of call log areas available in the system. One is the personal area, which stores call logs for each extension. The other is the common area, which stores call logs for the system. A call comes directly to a certain extension is stored in the extension's personal area. A call for multiple extensions and a call via the DISA Intercept Routing feature is stored in the common area. To check the caller's information stored in the personal area, you need to assign the Caller ID Indication — Personal button. For common area, the Caller ID Indication — Common button is necessary. Up to 20 calls can be logged in each personal area and up to 300 calls in the common area. When the call log in the personal area is full (20 calls are stored), you can select how the 21st call is treated. Either a new call can be disregarded or the new call can overwrite the oldest call that have been already confirmed (Default: Record the new call.). As for the common area, only the operator or manager can control this. (Refer to “The 301st Call Log, Incoming in the Common Area Treatment” in section 3.3.)

Overwriting the call log in the personal area

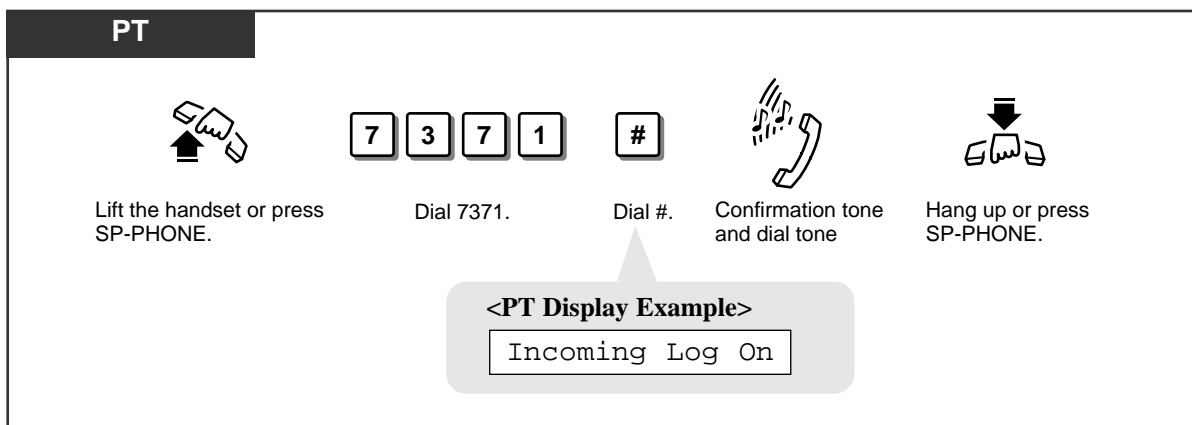

Disregarding the 21st call in the personal area

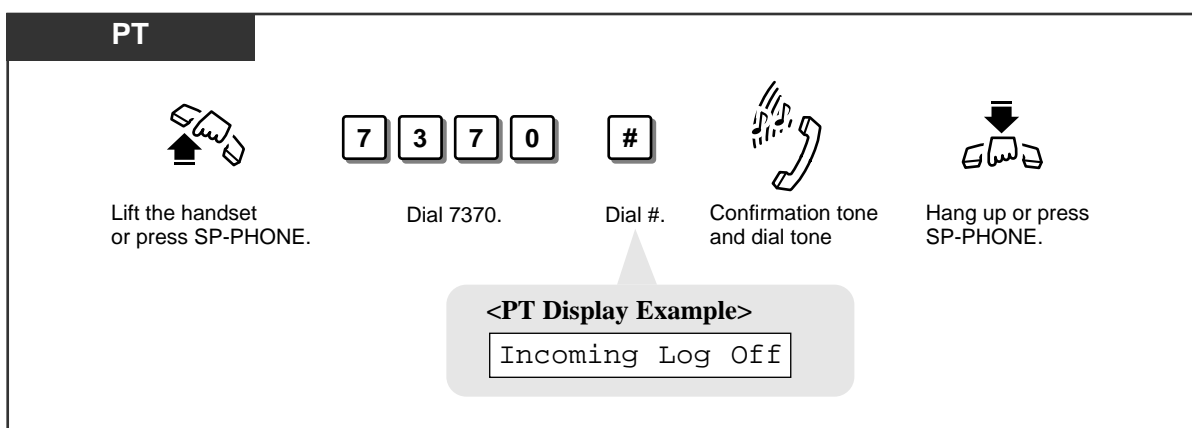

3.2 Telephone Features

C

Confirming and calling back

Display Operation (— for the KX-T7030, KX-T7130 and KX-T7135)

When the Caller ID Indication — Personal button indicator is red, there are new calls logged in the personal area. When the Caller ID Indication — Common button indicator is red, there are new calls logged in the common area.

001:0111111111

002:0924773333

1. Confirm the number of logged calls.
2. Press the **Caller ID Indication** button to see the incoming call information.
 - The new information that you have not confirmed will be displayed first.
3. You can confirm another caller's information by pressing the **Caller ID Indication** button again. After displaying all of the new information, the old information you have already confirmed will be displayed.
 - To modify the telephone number, use the HOLD button to erase and “0 to 9, * and PAUSE” to add numbers from the first digit.
 - To clear the displayed information, press the TRANSFER button.
 - To clear all logged call information in the personal area, go off-hook and press 70*#. As for the common area, only the operator or manager can clear all logged call information. (Refer to “Call Log, Incoming in the Common Area — CLEAR ALL” in section 3.3.)The display shows as follows.

CID Log Clear

- To return to the initial display, go off-hook and on-hook. The display also returns to the initial display automatically if no operation is done for twenty seconds.
- Pressing the Caller ID Selection — Personal button or # provides you with further information about the party stored in the personal area. Pressing the Caller ID Selection — Common button or # provides you with further information about the party stored in the common area. The display changes as follows.

(Continued)

<Example>

If the information is stored in log 003,

003:BOB HANKS — caller's name



003:0011223344 — caller's number



003:Oct30 09:00P — date and time

- Only twelve digits (or characters) of caller's number (or name) can be displayed even though sixteen digits (or characters) of information may have been received. To scroll the display, press → (the FWD/DND button).

003:0011223344

4. Confirm the displayed number and lift the **handset** or press the **SP-PHONE** button.
5. Press the **Caller ID Indication** button.
 - You may press a CO button first to select a specified outside (CO) line.
The last displayed number is dialed.

Confirming the number of logged calls

PT

— *In the Personal Area*



Press Caller ID Selection — Personal button while on-hook.

<PT Display Example>

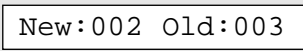

- The above information will be displayed for 3 seconds.

— *In the Common Area*



Press Caller ID Selection — Common button while on-hook.

<PT Display Example>

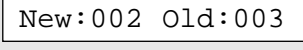

- The above information will be displayed for 3 seconds.

Conditions

- PT** • When “Disregarding the 21st call in the personal area” has been set and 20 calls are logged or all of the old information has been overwritten in the personal area, the Caller ID Selection — Personal button indicator lights and informs you that no more calls can be logged.
- PT** • System Programming determines who can check the caller’s information stored in the common area.
- PT** • If nobody has assigned the Caller ID Indication — Common button, a call directed to multiple extensions and a call via the DISA Intercept Routing feature will be stored in an extension’s personal area that is connected to the lowest jack number and the extension’s Caller ID Indication — Personal button indicator will light.

Programming References

- Station Programming (Section 2)
 - Flexible Button Assignment — Caller ID Indication Button
 - Caller ID Selection Button
- System Programming — Installation Manual
 - [900] Caller ID Assignment
 - [901] Caller ID Area Code Assignment
 - [902] Caller ID Modification for Local Calls
 - [903] Caller ID Modification for Long Distance Calls
 - [904] Caller ID Log Priority Selection
 - [909] Common Area Call Log Check Assignment

Feature References

Call Log Lock, Incoming in the Personal Area
Call Log, Incoming in the Common Area — CLEAR ALL
(3.3 Operator/Manager Service Features)
Call Log Lock, Incoming in the Common Area (3.3 Operator/Manager Service Features)
The 301st Call Log, Incoming in the Common Area Treatment
(3.3 Operator/Manager Service Features)

* The Caller ID service provides you with the caller's information, such as the name and telephone number, on the outside (CO) line, assigned to receive Caller ID service calls. Refer to the Installation Manual.

Call Log Lock, Incoming in the Personal Area

Allows you to lock the display of your extension so that the “Call Log, Incoming” feature is not shown on the display when you press the Caller ID Indication — Personal button, if you do not want others to see the information stored in the personal area. This feature also works as Electronic Station Lockout.

Locking

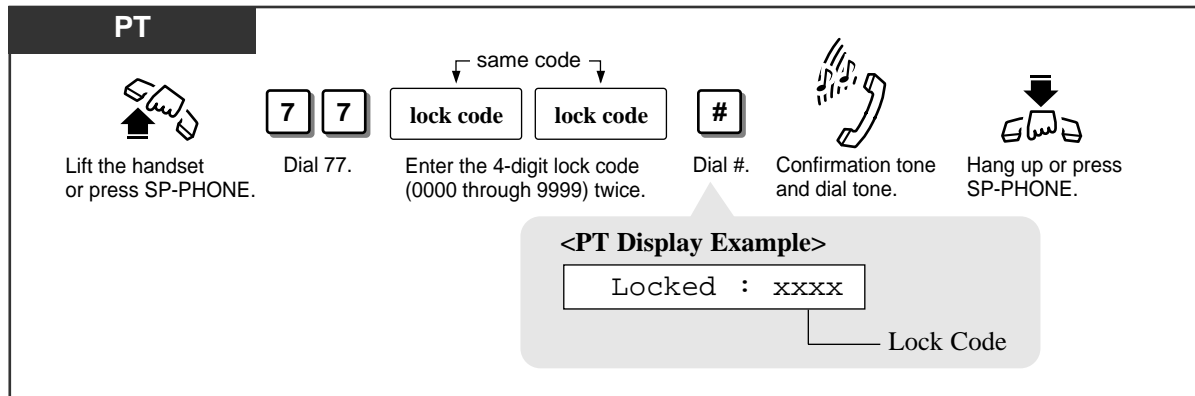

Unlocking

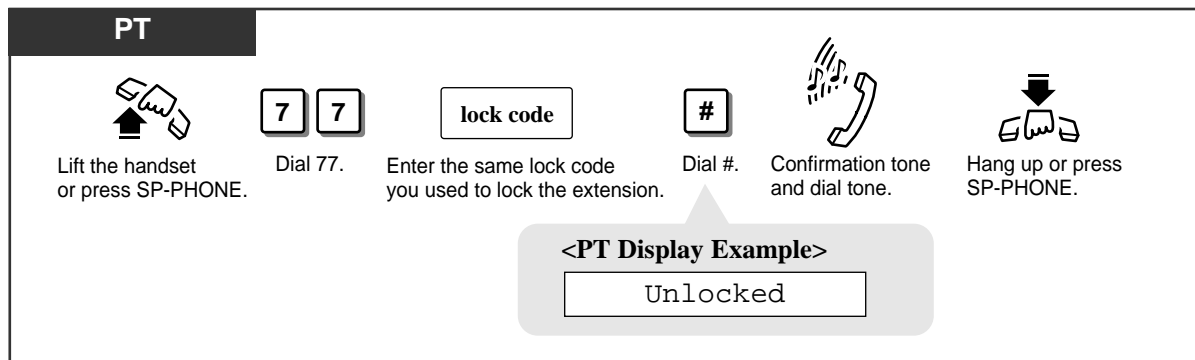

Conditions

- PT** • The operator or manager can cancel this feature for all other extensions (Electronic Station Lockout — CANCEL ALL).
- PT** • “Remote Station Lock Control” overrides this feature. If the operator or manager sets Remote Station Lock on the extension you have already locked, you cannot unlock it.

Feature References

Call Log, Incoming
Electronic Station Lockout
Call Log Lock, Incoming in the Common Area (3.3 Operator/Manager Service Features)
Electronic Station Lockout — CANCEL ALL (3.3 Operator/Manager Service Features)
Remote Station Lock Control (3.3 Operator/Manager Service Features)

Call Park

Allows you to place a held call into a system parking area so that you can perform other tasks. The parked call can be retrieved by any extension user. Up to ten calls can be parked.

PT and SLT

During a conversation

HOLD



For a PT

For an SLT



2 2

parking zone no.



For a PT: Press HOLD.
For an SLT: Flash the hookswitch. Confirmation tone and dial tone Dial 22. Enter a parking zone number (0 through 9). Confirmation tone and dial tone

<PT Display Example>

Call Prked at x

Parking zone number

- **If you hear a busy tone**, it indicates the specified parking zone is unavailable.

<PT Display Example>

Park at x N/A

Parking zone number

- You do not need to redial the feature number to change the parking zone. Just enter the parking zone number while hearing the busy tone.

Retrieving a parked call

Any Telephone



5 2

parking zone no.



Lift the handset or press SP-PHONE/MONITOR. Dial 52. Enter a parking zone number (0 through 9) where the call is parked. Confirmation tone and dial tone

You can talk to the party.

- **If there is no held call**, you will hear a reorder tone.

<PT Display Example>

No Held Call

3.2 Telephone Features

C

Conditions

- If a parked call is not retrieved within a pre-determined time (default: 30 seconds), “Hold Alarm/Hold Recall” occurs.
- If a parked call is not retrieved within thirty minutes, it will be automatically disconnected.
- This feature is useful when you want to hold more than one intercom call with a PT, or more than one intercom or outside call with an SLT.

Programming Reference

- System Programming — Installation Manual
[200] Hold Recall Time

Feature Reference

Hold Alarm/Hold Recall (→ See the Installation Manual.)

Call Pickup, Directed

Allows you to answer an incoming call ringing at any other extension.

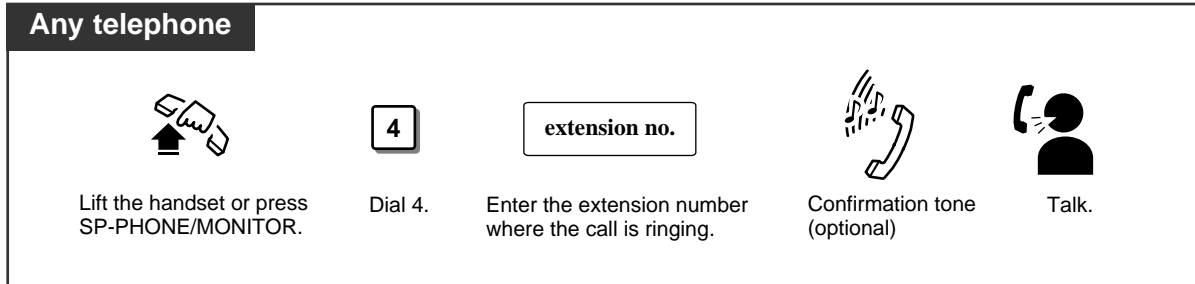

Conditions

- Doorphone calls can be picked up from extensions that are not programmed to answer doorphone calls.
- You can hear a confirmation tone when the call is picked up. The tone can be disabled.
- If a ringing extension sets the Call Pickup Deny feature, you will hear a reorder tone.

Programming Reference

- System Programming — Installation Manual
[117] Call Pickup Tone

Feature References

Call Pickup Deny
Doorphone Call

Call Pickup, Group

Allows you to answer a call that is ringing at another telephone within your extension group.

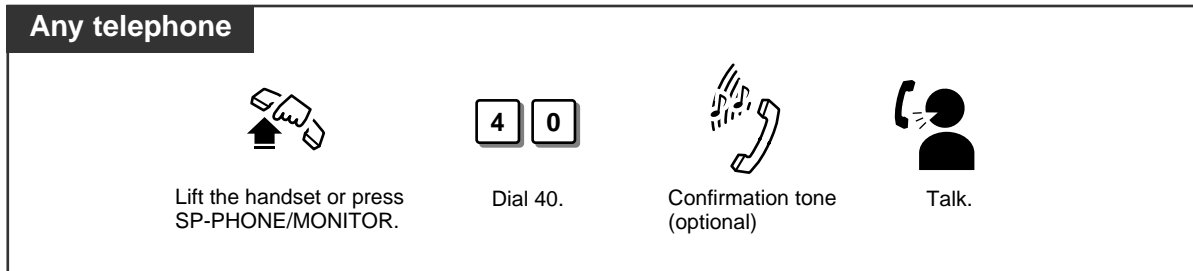

Conditions

- You can pick up an incoming outside, intercom or doorphone call, but you cannot pickup a Camp-On recall and hold recall.
- You can hear a confirmation tone when the call is picked up. The tone can be disabled.
- If a ringing extension sets the Call Pickup Deny feature, you will hear a reorder tone.

Programming References

- System Programming — Installation Manual
 - [117] Call Pickup Tone
 - [600] Extension Group Assignment

Feature References

Call Pickup Deny
Extension Group (→ See the Installation Manual.)

Call Pickup Deny

Allows you to prevent another extension from picking up your calls with the “Call Pickup” feature.

Setting / Canceling

Any Telephone



Lift the handset or press
SP-PHONE/MONITOR.

7	2	1	#	To set.
7	2	0	#	To cancel.

To set: Dial 721#.
To cancel: Dial 720#.



Confirmation tone
and dial tone



Hang up or press
SP-PHONE/MONITOR.

<PT Display Example>

- When setting:

C.Pickup Deny
- When canceling:

C.Pickup Allow
- Single line telephone users can dial “0” instead of “#”.

Feature References

Call Pickup, Directed
Call Pickup, Group

3.2 Telephone Features

C

Call Retrieving from a TAM (Telephone Answering Machine)

Allows you to answer an incoming call received by a TAM.
System Programming is required to use this feature.

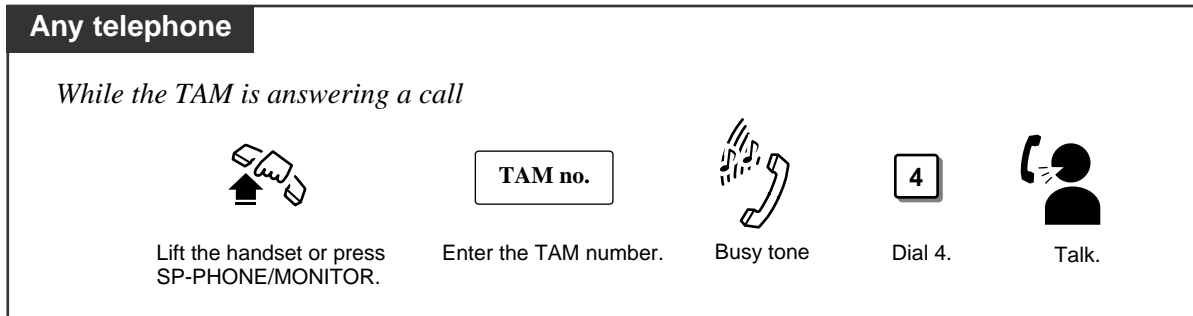

Conditions

- When you try to pick up a call and hear a reorder tone, the TAM is not answering the call or the dialed extension is not the TAM extension.
- A TAM number is the 3-digit extension number of the TAM.

Programming Reference

- System Programming — Installation Manual
[611] TAM (Telephone Answering Machine) Extension

Call Splitting

Allows you to talk to two different parties alternately. If a call is received while you are already on the line, you can place the current call on hold and have a conversation with the other party.



Having a conversation while another call is on (exclusive) hold

PT

Between one extension and one outside (CO) line



Press HOLD.

CO  or INTERCOM 

Press CO or INTERCOM.

- Repeating these operations (steps 1 and 2) alternates between the callers.

Between two outside (CO) lines



Press HOLD.

CO 

Press CO.

- Repeating these operations (steps 1 and 2) alternates between the callers.

Between two extensions



Press HOLD.

- Pressing the HOLD button alternates between the callers.

SLT



Flash the hookswitch.

- The first held call is released.
- Flashing this switch alternates between the callers.

Condition

- This feature does not work during a doorphone call or paging.

Programming Reference

- System Programming — Installation Manual
[104] Hold Mode Selection

Feature References

Call Hold
Call Hold, Exclusive

Call Transfer — to Extension

Allows you to transfer a received call to another extension. There are two ways.

Screened Call Transfer: The destination confirms the transfer before sending.

Unscreened Call Transfer: The line is released after transferring the call without confirmation.

Screened Call Transfer

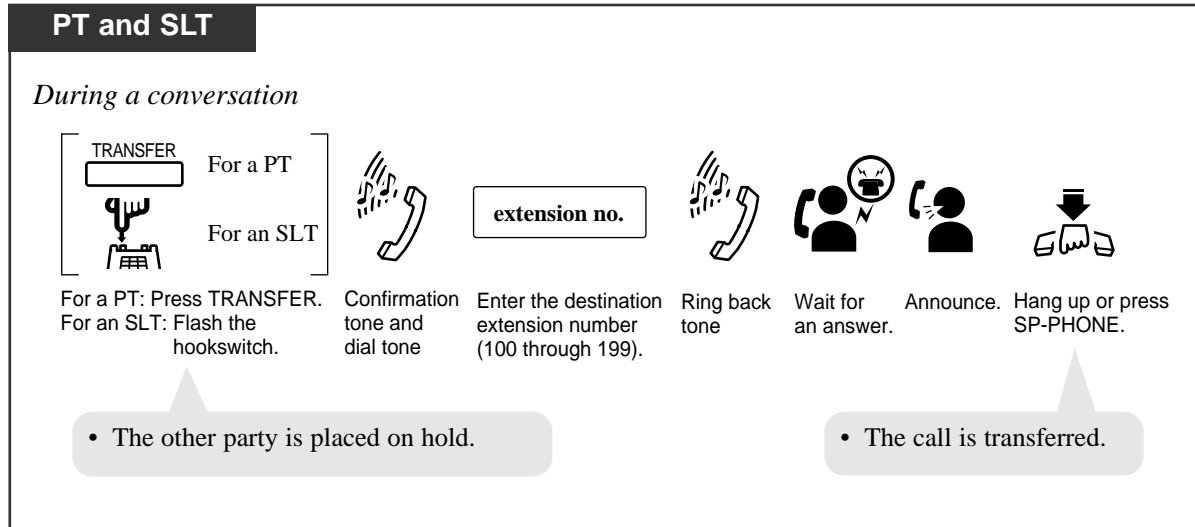

Unscreened Call Transfer

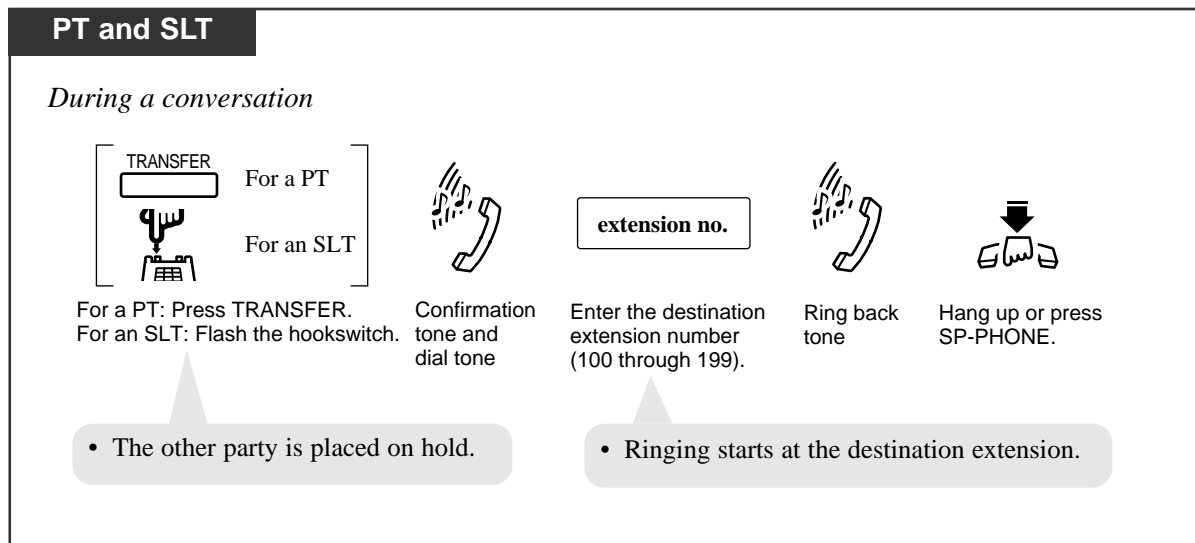

Call Transfer using a DSS button

Allows you to perform a Screened or Unscreened Call Transfer by using a DSS button. There are two operations, depending on whether or not One-Touch Transfer* is set.

* **One-Touch Transfer** allows you to hold an outside call and transfer it to an extension by pressing one key. This feature provides automatic hold and transfer, without pressing the TRANSFER button. System Programming is required to use this feature.

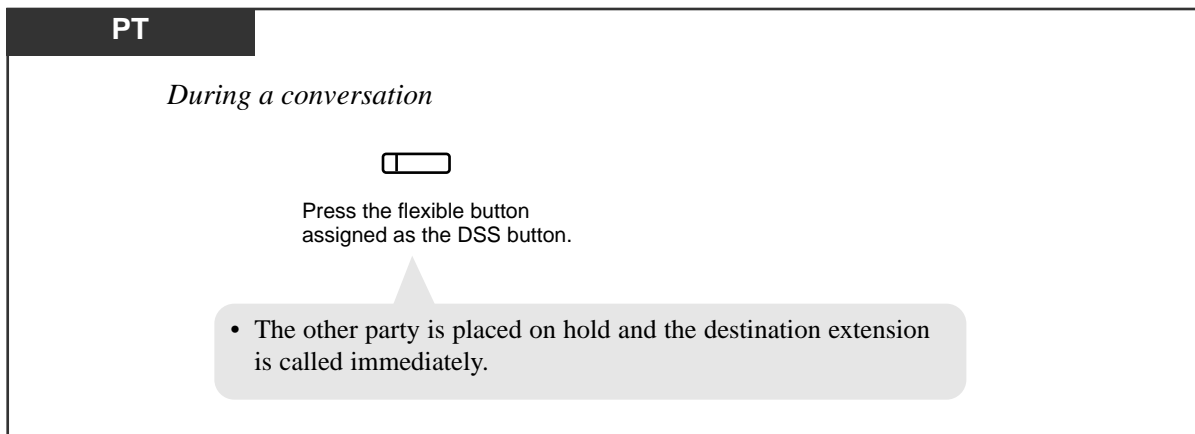
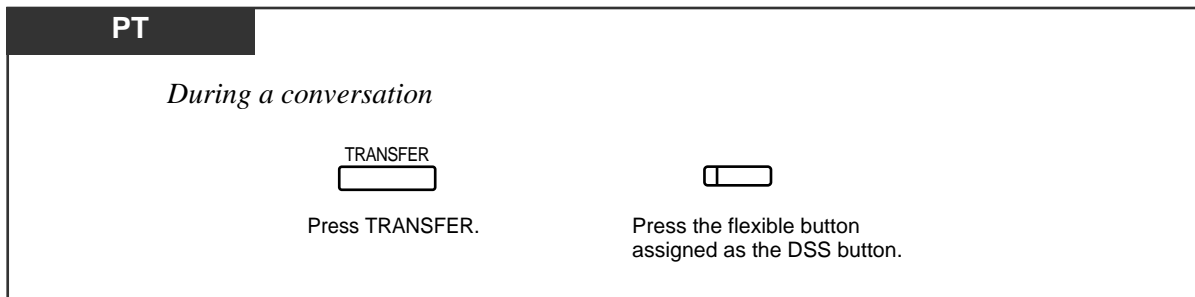
“With Transfer” mode**“Without Transfer” mode**

Conditions

- If the destination extension does not answer the call within a pre-determined time (default: 30 seconds), “Transfer Recall” occurs.
- If there is no answer within thirty minutes after “Transfer Recall” starts, the line will be disconnected.
- When the dialed extension is busy, you may access the extension by dialing “1” (Busy Station Signaling) or “2” (Executive Busy Override) and going on-hook.
- PT • If you want to return to the held call, press the TRANSFER button or corresponding CO or INTERCOM button before the destination extension answers.
- PT • When “Transfer Recall” occurs, the display will show the following:
<Example>

RCL: Ext 101
- PT • A flexible CO button can be assigned as a DSS button.
- PT • To use “One-Touch Transfer”, System Programming is required.
- SLT • If you want to return to the held call, flash the hookswitch before the destination extension answers.
- SLT • If “Hold-3” is assigned in System Programming, you must dial “20” after flashing the hookswitch.

Programming References

- Station Programming (Section 2)
 - Flexible Button Assignment — Direct Station Selection (DSS) Button
- System Programming — Installation Manual
 - [005] One-Touch Transfer Using a DSS Button
 - [104] Hold Mode Selection
 - [201] Transfer Recall Time

Feature References

- Call Transfer, Screened – to Extension (→ See the Installation Manual.)
- Call Transfer, Unscreened – to Extension (→ See the Installation Manual.)
- One-Touch Transfer Using a DSS Button (→ See the Installation Manual.)

Call Transfer — to an Outside (CO) Line

Allows you to transfer a received call to an external party.

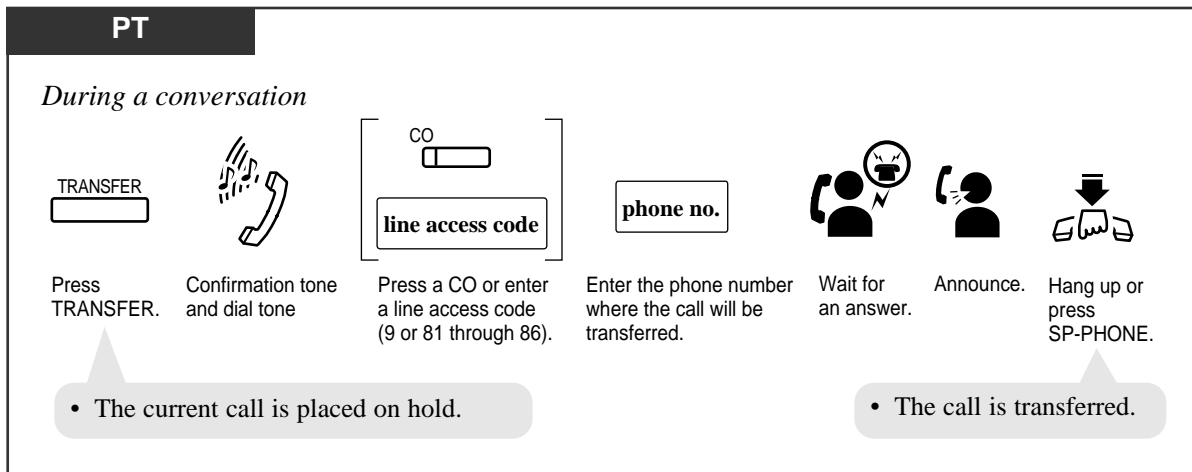

Conditions

- PT** • If a CPC signal is sent to an outside (CO) line before the assigned time limit, a call between two external parties will be disconnected.
- PT** • System programming is required to execute this feature.
- PT** • If a call between two external parties is established, an alarm tone is sent to both parties fifteen seconds before the assigned time limit (default: 10 minutes). “Hold Alarm/Hold Recall” is sent to the transferring extension fifty seconds before time out.
- PT** • If you want to return to the held call, press the TRANSFER button or corresponding CO or INTERCOM button before the destination party answers.
- PT** • If you want to join the conversation after transferring the call, press the corresponding CO button. A conference call is established.
- PT** • To change the party where the call is transferred before hanging-up, press the CO button whose indicator is flashing slowly to retrieve the call, then repeat the Call Transfer procedure.

Programming References

- System Programming — Installation Manual
 - [205] Outside-to-Outside (CO-to-CO) Line Duration Time Limit
 - [420] Calling Party Control (CPC) Signal
 - [606] Call Transfer to an Outside (CO) Line

Feature References

- Conference
- Hold Alarm/Hold Recall (→ See the Installation Manual.)

3.2 Telephone Features

C

Call Waiting

During a conversation, a Call Waiting tone informs you that there is a call waiting. You can answer the second call by disconnecting the first call or placing it on hold.

Setting / Canceling for outside calls

Any Telephone

 Lift the handset or press SP-PHONE/MONITOR.

To set.
 To cancel.

To set: Dial 7311#. To cancel: Dial 7310#.

 Confirmation tone and dial tone

 Hang up or press SP-PHONE/MONITOR.

<PT Display Example>

- When setting:
- When canceling:

- Single line telephone users can dial "0" instead of "#".

Setting / Canceling for intercom calls and doorphone calls

Any Telephone

 Lift the handset or press SP-PHONE/MONITOR.

To set.
 To cancel.

To set: Dial 7321#. To cancel: Dial 7320#.

 Confirmation tone and dial tone

 Hang up or press SP-PHONE/MONITOR.

<PT Display Example>

- When setting:
- When canceling:

- Single line telephone users can dial "0" instead of "#".

To talk to the new party by terminating the current call

PT	SLT
<p><i>While hearing a Call Waiting tone</i></p> <div style="display: flex; justify-content: space-around; align-items: center;"> <div style="text-align: center;"> <p>CO or INTERCOM </p> <p>Press the flashing CO or INTERCOM.</p> </div> <div style="text-align: center;"> <p>Talk to the new caller.</p> </div> </div> <div style="border: 1px solid gray; border-radius: 15px; background-color: #eee; padding: 5px; margin-top: 10px; text-align: center;"> <ul style="list-style-type: none"> • The current call is disconnected. </div>	<p><i>While hearing a Call Waiting tone</i></p> <div style="display: flex; justify-content: space-around; align-items: center;"> <div style="text-align: center;"> <p>Hang up.</p> </div> <div style="text-align: center;"> <p>Lift the handset.</p> </div> <div style="text-align: center;"> <p>Talk to the new caller.</p> </div> </div> <div style="border: 1px solid gray; border-radius: 15px; background-color: #eee; padding: 5px; margin-top: 10px; text-align: center;"> <ul style="list-style-type: none"> • The current call is disconnected. </div>

To talk to the new party by holding the current call

PT	SLT
<p><i>While hearing the Call Waiting tone and the CO or INTERCOM indicator is flashing rapidly</i></p> <div style="display: flex; justify-content: space-around; align-items: center;"> <div style="text-align: center;"> <p>HOLD </p> <p>Press HOLD.</p> </div> <div style="text-align: center;"> <p>CO or INTERCOM </p> <p>Press the flashing CO or INTERCOM.</p> </div> <div style="text-align: center;"> <p>Talk to the new caller.</p> </div> </div> <div style="border: 1px solid gray; border-radius: 15px; background-color: #eee; padding: 5px; margin-top: 10px; text-align: center;"> <ul style="list-style-type: none"> • The current call is placed on hold. </div>	<p><i>While hearing a Call Waiting tone</i></p> <div style="display: flex; justify-content: space-around; align-items: center;"> <div style="text-align: center;"> <p>Flash the hookswitch.</p> </div> <div style="text-align: center;"> <p>Dial tone</p> </div> <div style="text-align: center;"> <p>Hang up.</p> </div> <div style="text-align: center;"> <p>Lift the handset.</p> </div> <div style="text-align: center;"> <p>Talk to the new caller.</p> </div> </div> <div style="border: 1px solid gray; border-radius: 15px; background-color: #eee; padding: 5px; margin-top: 10px; text-align: center;"> <ul style="list-style-type: none"> • The current call is placed on hold. </div>

— If both the current call and new call are extension calls, you do not have to press the INTERCOM button.

Conditions

- The default setting for Call Waiting is “disabled”.
- When Call Waiting is enabled, a Call Waiting tone is sent to the user under the following conditions.
 - 1) When an outside call is received,
 - 2) When another extension executes the “Busy Station Signaling (BSS)” feature, or
 - 3) When a doorphone call is received.
- Setting “Data Line Security” temporarily cancels this feature.
- You can change the desired Call Waiting tone for an incoming outside call and intercom call (Tone 1 or Tone 2). As for a doorphone call, Tone 1 is used as a Call Waiting tone (not changeable).
- PT • If a Call Waiting tone is heard and the CO or INTERCOM indicator does not flash, this tone indicates Call Waiting from your telephone company. In this case, see “Call Waiting from a Central Office” or “External Feature Access”.
- SLT • If “Hold-2” or “Hold-3” is assigned in System Programming, you must dial “20” after flashing the hookswitch.
- SLT • You cannot transfer the new call while holding the current call. If you want to do so, first park the original call using the Call Park feature; then hang up; then take the new call.

Programming References

- Station Programming (Section 2)
 - Call Waiting Tone Type Assignment
- System Programming — Installation Manual
 - [104] Hold Mode Selection

Feature References

Busy Station Signaling (BSS)
Call Park
Call Waiting from a Central Office
Data Line Security
External Feature Access

Call Waiting from a Central Office

During a conversation, a Call Waiting tone offered by your Central Office signals you that there is a call waiting. You can respond to the call by placing the first call on hold.

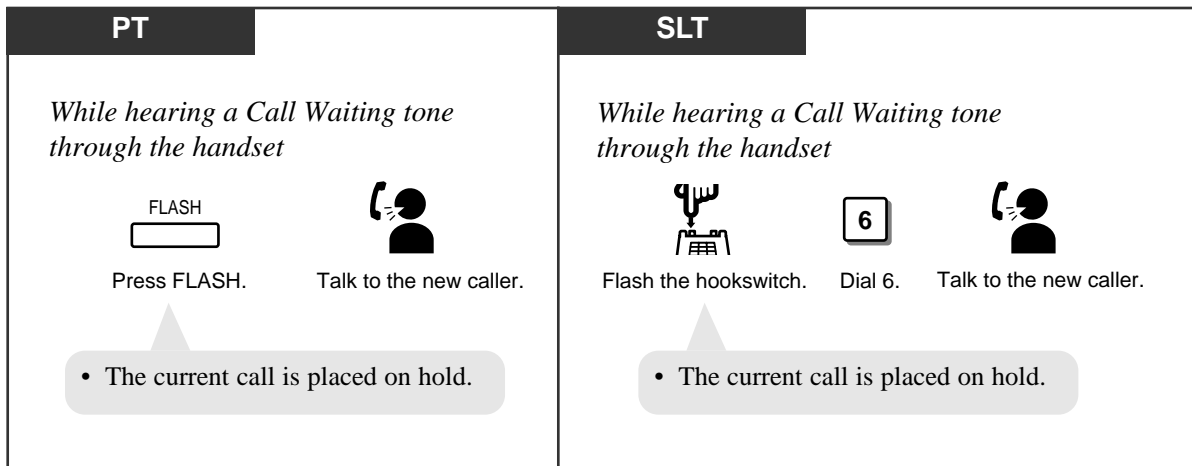

Conditions

- PT • You can return to the original party by pressing the FLASH button again.
- SLT • You can return to the original party by repeating the steps above.
- SLT • If “Hold-2” or “Hold-3” is assigned in System Programming, you must dial “20” after flashing the hookswitch.

Programming References

System Programming — Installation Manual

- [104] Hold Mode Selection
- [110] Flash Key Mode
- [418] Flash Time

Feature Reference

External Feature Access

Caller ID Call Waiting

During a conversation, a Call Waiting tone offered by your Central Office informs you that there is a call waiting. If the Caller ID service provides you with a caller's information, such as the name and telephone number, the new caller's information will be displayed (flashing) on your extension (KX-T7030, KX-T7130 and KX-T7135 only) during the assigned time. You can answer the second call by disconnecting the first call or placing it on hold.

To talk to the new party by holding the current call

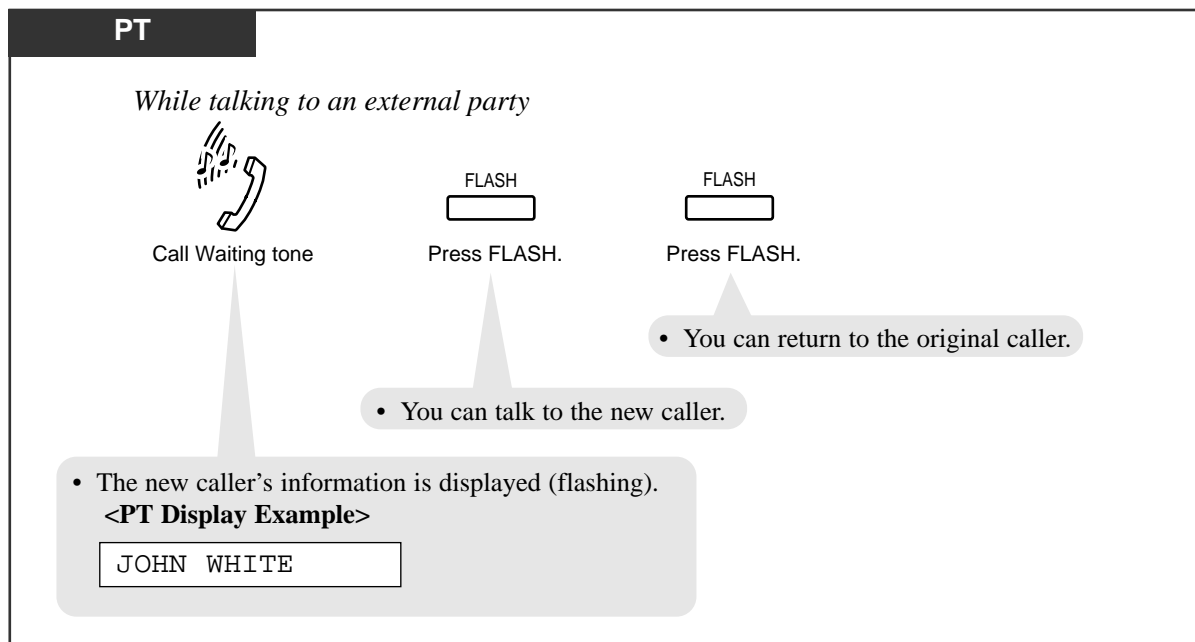

To talk to the new party by terminating the current call

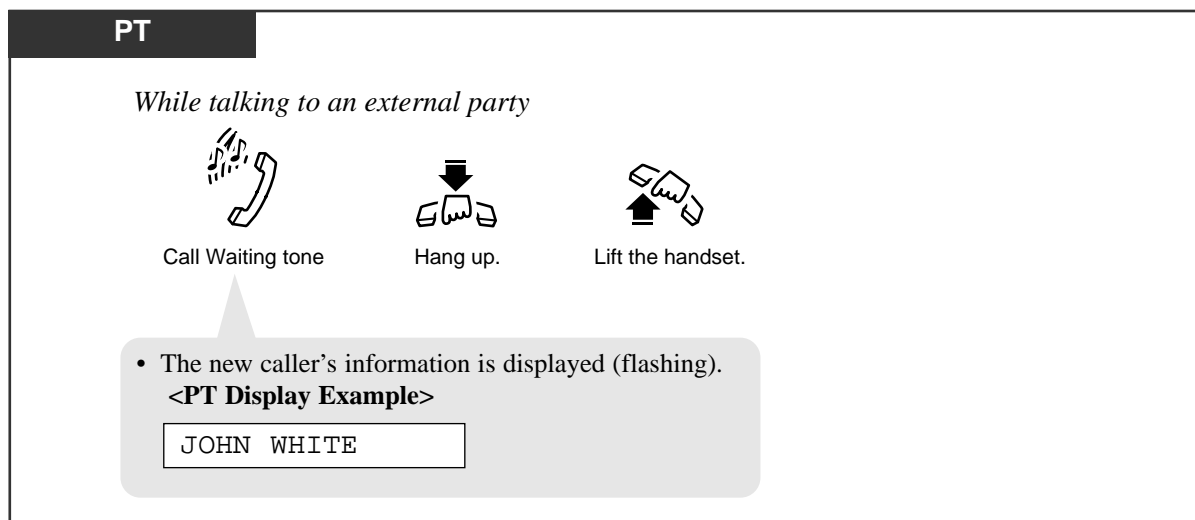

Conditions

- PT • You can program the new caller information display timer. If you do not press the FLASH button while the information is displayed (flashing), the display stops flashing. In this situation, the caller information is automatically recorded in your personal area and your Caller ID Indication — Personal button indicator lights if the call has been directed to your extension. A call directed to multiple extensions is automatically recorded in the common area and all corresponding Caller ID Indication — Common button indicators light. However in this case, if nobody has assigned the Caller ID Indication — Common button, the call information is recorded in an extension's personal area that is connected to the lowest jack number and the extension's Caller ID Indication — Personal button indicator lights.
- PT • This feature is available during a conversation with an external party except for the following cases: (1) during a conference, (2) during holding a call, (3) during transferring a call, (4) during the Two-Way Recording, (5) during the Live Call Screening, (6) during an outside-to-outside (CO-to-CO) line call and (7) during DISA outgoing message.
- PT • The TRANSFER button, HOLD button and Conference (CONF) button do not work while the new caller information is flashing.
- PT • A contract with your Central Office may be required for the Call Waiting service. Consult the Central Office for details.

Programming Reference

System Programming — Installation Manual
[908] Caller ID Call Waiting Time

Feature Reference

Call Information/Log Incoming

Conference

During a two-party conversation, you can add a third party to make a three-party conference. The members of a conference may be three extensions, one extension and two outside (CO) lines, or two extensions and one outside (CO) line.

To establish a conference

PT

During a two-party conversation

CONF phone no. CONF A three-party conference is now established.

Press CONF. Enter the phone number of the third party. Talk to the third party. Press CONF. Confirmation tone (optional)

- The CONF indicator light turns steady red.
- The corresponding CO or INTERCOM indicator light turns green.

- You must dial the line access code (9 or 81 through 86) as the first digit when calling an external party.

- The current party is placed on hold.
- The CONF indicator light flashes red slowly.

SLT

During a two-party conversation

phone no. 3 A three-party conference is now established.

Flash the hookswitch. Enter the phone number of the third party. Talk to the third party. Flash the hookswitch. Dial 3. Confirmation tone (optional)

- You must dial the line access code (9 or 81 through 86) as the first digit when calling an external party.

- The other party is placed on hold.

To leave the conference

Any telephone



Hang up or press SP-PHONE.

- The other two parties may continue their conversation.
- If the other two parties are both outside (CO) lines, they will be disconnected.

To talk to the original party while holding the third party

SLT



Flash the hookswitch.



Confirmation tone (optional)



Talk to the original party.

To terminate one party and talk to the other

PT

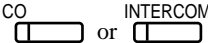

CO or INTERCOM

Press the CO or INTERCOM of the party to remain connected.



Confirmation tone (optional)



Talk.

- A conversation with the desired party is established and the other party is disconnected.

Conditions

- A conference call can also be established by “Executive Busy Override”.
- When a two-party call is changed to a three-party call or vice versa, a confirmation tone is sent to all parties. The tone can be disabled.
- PT** • Pressing a CO button which is not in the conference allows you to exit from the conference, leaving the other two parties connected unless they are both outside (CO) lines.
If the other parties are both outside (CO) lines, they will be disconnected.
- PT** • If the third party does not answer, press the CO button or INTERCOM button to return to the second party.
- SLT** • You can return to the original party before the third party answers by flashing the hookswitch.
- SLT** • If “Hold-2” or “Hold-3” is assigned in System Programming, you must dial “20” after flashing the hookswitch.

Programming References

- Station Programming (Section 2)
Flexible Button Assignment — Conference (CONF) Button
- System Programming — Installation Manual
[104] Hold Mode Selection
[105] Conference Tone

Feature References

Conference, Unattended
Executive Busy Override — Extension
Executive Busy Override — Outside (CO) Line

Conference, Unattended

When you are in a conference with two outside parties, you can leave the conference call allowing the other two parties to continue their conversation.

To establish an Unattended Conference

PT

During a conversation with two outside parties

CONF

Press CONF to leave the conference.

- An outside-to-outside (CO-to-CO) line call between the other two parties is established.

To return to the conference

PT

CO

Press the CO flashing green moderately.

Conditions

- System Programming is required to execute this feature.
- PT • When an Unattended Conference is established, an alarm tone is sent to both outside parties fifteen seconds before the assigned time limit (default: 10 minutes). “Hold Recall” is activated at the extension that leaves the conference fifty seconds before the time out. The call is disconnected when the time out expires unless the extension returns to the conference.
- PT • For example, if you are on-hook and hear “Hold Recall” during the Unattended Conference mode, the display will show “CO 2 & CO 3” for fifty seconds before the time out.

Programming References

- System Programming — Installation Manual
 - [205] Outside-to-Outside (CO-to-CO) Line Duration Time Limit
 - [606] Call Transfer to an Outside (CO) Line

Feature References

Conference
 Hold Alarm/Hold Recall (→ See the Installation Manual.)

Data Line Security

Your extension can be protected against interruptions from the “Call Waiting”, “Hold Alarm/Hold Recall”, and “Executive Busy Override” features. Data communication devices, such as computers and facsimiles, can operate uninterrupted.

Setting / Canceling

Any Telephone



Lift the handset or press SP-PHONE/MONITOR.

7	3	0	1	#	To set.
7	3	0	0	#	To cancel.

To set: Dial 7301#.
To cancel: Dial 7300#.



Confirmation tone and dial tone



Hang up or press SP-PHONE/MONITOR.

<PT Display Example>

- When setting:
- When canceling:
- Single line telephone users can dial “0” instead of “#”.

Feature References

- Call Waiting
- Executive Busy Override — Extension
- Executive Busy Override — Outside (CO) Line
- Hold Alarm/Hold Recall (→ See the Installation Manual.)

Direct Inward System Access (DISA)

Allows an outside caller to access specific extensions, etc., as if the caller is an extension in the system. A DISA outgoing message gives outside callers assistance, such as listing the extension numbers or DISA built-in auto attendant (AA) numbers in the system. If the optional OGM/FAX Detection card is not installed, callers will only hear a beep instead of a message. This saves you having an operator. A pre-assigned DISA security code may be necessary, depending on the mode, to access the features directly.

None Security mode: Any caller can make outside or intercom calls without entering a DISA security code.

Trunk Security mode (default): You need to enter a DISA security code when making outside calls.

All Security mode: You need to enter a DISA security code when making any call. You also have the option of calling an extension or ring group using a one digit number (DISA built-in auto attendant number) via DISA calls.

Calling an extension by following the outgoing message

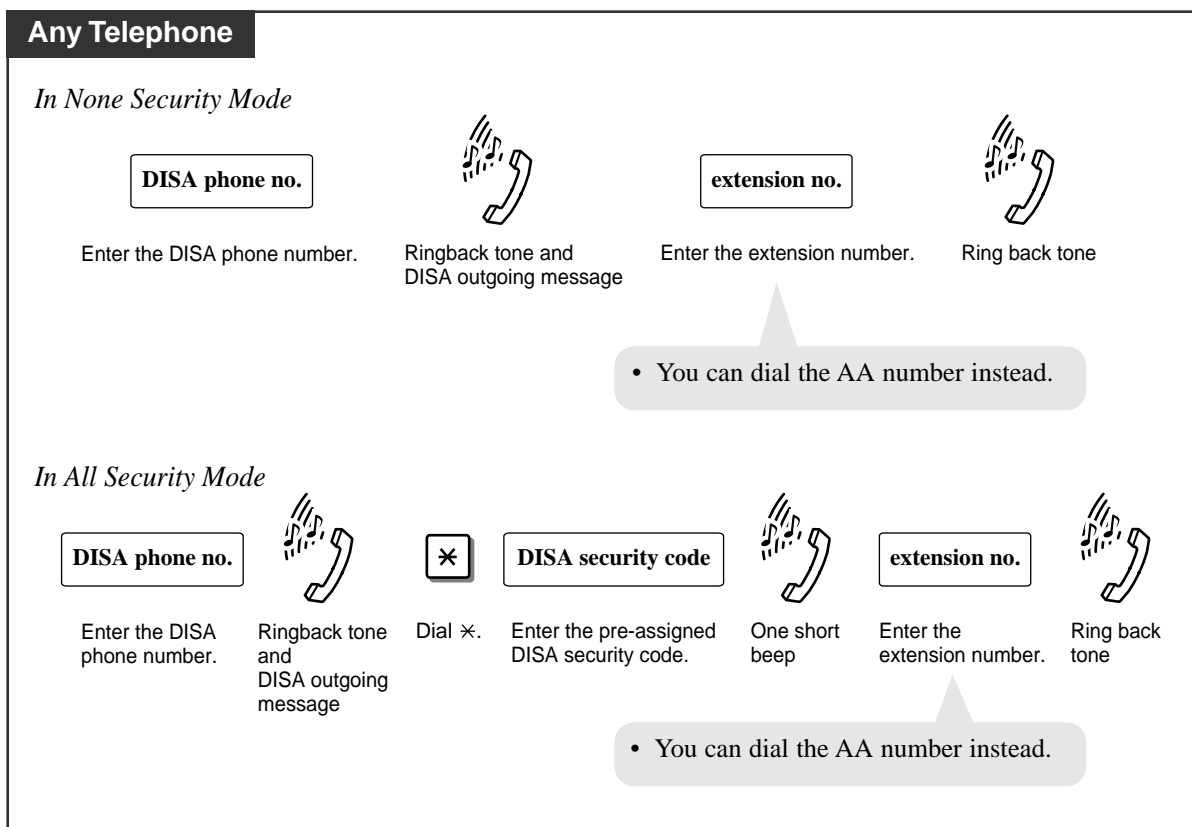

3.2 Telephone Features

D

Calling an extension without an outgoing message

Any Telephone

In None Security Mode

DISA phone no.

Enter the DISA phone number.



Ringback tone and one short beep

extension no.

Enter the extension number.



Ring back tone

• You can dial the AA number instead.

In All Security Mode

DISA phone no.

Enter the DISA phone number.



Ringback tone and one short beep

Dial *.

DISA security code

Enter the pre-assigned DISA security code.



One short beep

extension no.

Enter the extension number.



Ring back tone

• You can dial the AA number instead.

Calling an external party by following the outgoing message

Any Telephone

In None Security Mode

DISA phone no.

Enter the DISA phone number.



Ringback tone and DISA outgoing message

line access code

Enter a line access code (9 or 81 through 86).



Dial tone from the Central Office

phone no.

Enter the phone number of the external party.

In Trunk Security Mode

DISA phone no.

Enter the DISA phone number.



Ringback tone and DISA outgoing message

Dial *.

DISA security code

Enter the pre-assigned DISA security code.



One short beep

line access code

Enter a line access code (9 or 81 through 86).



Dial tone from the Central Office

phone no.

Enter the phone number of the external party.

In All Security Mode

DISA phone no.

Enter the DISA phone number.



Ringback tone and DISA outgoing message

Dial *.

DISA security code

Enter the pre-assigned DISA security code.



One short beep

line access code

Enter a line access code (9 or 81 through 86).



Dial tone from the Central Office

phone no.

Enter the phone number of the external party.

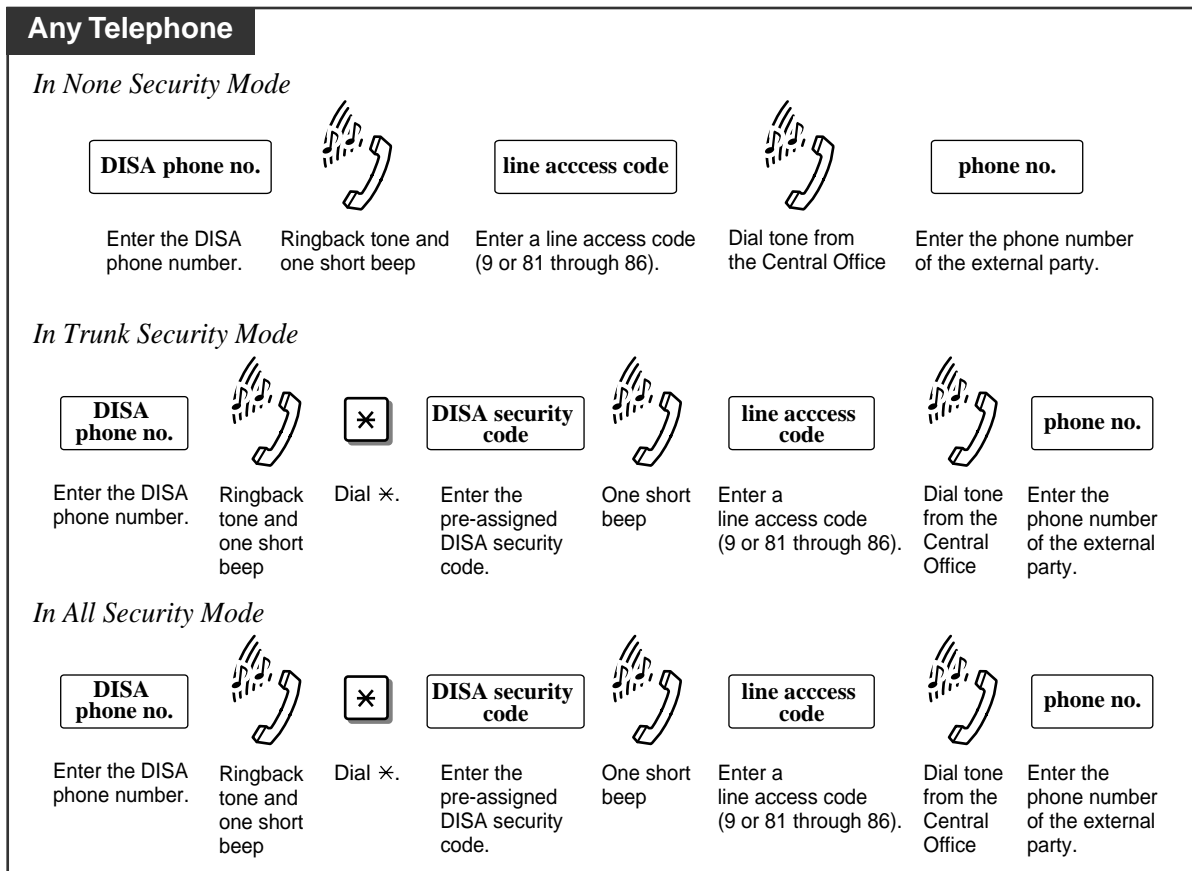
Calling an external party without an outgoing message**Conditions**

- An optional OGM/FAX Detection card is necessary for outgoing messages.
- When an incoming call is not answered before the “DISA Ringing Time before Intercept” (default: 20 seconds) expires, “Intercept Routing” starts or the call will be disconnected.
- “Intercept Routing” starts after the “DISA Waiting Time after OGM” expires (default: 5 seconds), if nothing has been dialed. The call is disconnected when the “DISA Ringing Time after Intercept” (default: 20 seconds) expires, or when there is no destination for “Intercept Routing”.
- This system supports up to ten programmable DISA built-in auto attendant (AA) numbers. Each number must be one digit. You can access an extension or a ring group by entering a 1-digit AA number.
- You can store up to four programmable DISA security codes. The number of digits of the codes can be programmed (default: 4 digits). Each code must be different.
- When the “Outside-to Outside (CO-to-CO) Line Duration Time Limit” expires, both lines are disconnected unless the caller re-tries or extends the time (default: 10 min.), if available. A warning tone is sent to both parties fifteen seconds before the time limit.
- If you dial the wrong DISA security code, three beeps will be heard. The call will be disconnected after three failed attempts. If you enter the security code a second and third time, you do not need to dial *.

Programming References

- System Programming — Installation Manual
 - [205] Outside-to-Outside (CO-to-CO) Line Duration Time Limit
 - [414]-[416] Outside (CO) Line Mode — Day/Night/Lunch
 - [500] DISA Incoming Dialing Mode Selection
 - [501] DISA Built-in Auto Attendant
 - [502] OGM Mode Selection
 - [503] FAX Connection
 - [504] DISA Delayed Answer Time
 - [505] DISA Waiting Time after OGM
 - [506] DISA Busy Mode
 - [507] DISA Intercept Mode
 - [508] DISA Ringing Time before Intercept
 - [509] DISA Ringing Time after Intercept
 - [510] DISA No Dial Mode
 - [511] DISA Security Type
 - [512] DISA Security Codes
 - [513] Cyclic Tone Detection
 - [514] FAX Tone Detection
 - [515] Intercept Time for Internal DISA
 - [516] DISA Incoming Assignment
 - [517] DISA AA Wait Time
 - [518] DISA Tone Selection after the Security Code
 - [530] DISA Security Codes Digits Selection

Feature References

- Intercept Routing (→ See the Installation Manual.)
- Outgoing Message (OGM) (3.3 Operator/Manager Service Features)

Do Not Disturb (DND)

Allows you to prevent other parties from disturbing you. Your extension will not receive intercom or outside calls.

Setting / Canceling

PT and SLT



Lift the handset or press SP-PHONE/MONITOR.

FWD/DND

FWD/DND

For a PT

7

1

For an SLT

4

To set.

0

To cancel.

#

Dial #.



Confirmation tone and dial tone



Hang up or press SP-PHONE/MONITOR.

- When setting, the FWD/DND indicator lights.
<PT Display Example>

Do Not Disturb
- When canceling, the FWD/DND indicator light turns off.
<PT Display Example>

FWD/DND Cancel
- Single line telephone users can dial “0” instead of “#”.

Conditions

- A calling extension that has “Do Not Disturb (DND) Override” enabled can override your extension when the “Do Not Disturb (DND)” mode is set.
- DND also inhibits for paging.
- If the Call Forwarding feature has already been set, setting the DND feature will cancel Call Forwarding.
- The Timed Reminder alarm and Hold Recall features override this feature.
- PT A flexible CO button on the KX-T7050 and KX-T7055 (no FWD/DND button provided) can be assigned as the FWD/DND button.
- PT If the “Do Not Disturb (DND)” mode is set, you can still answer a call by pressing the CO button.
- PT The lighting patterns of the FWD/DND button are as follows.
 - Off: Both features are not set.
 - Red: DND mode
 - Flashing red slowly: FWD mode

Programming Reference

- Station Programming (Section 2)
Flexible Button Assignment — FWD/DND Button

Feature References

Call Forwarding

Do Not Disturb (DND) Override

Do Not Disturb (DND) Override

Allows you to call an extension even though the “Do Not Disturb (DND)” feature is set. System Programming is required to use this feature.

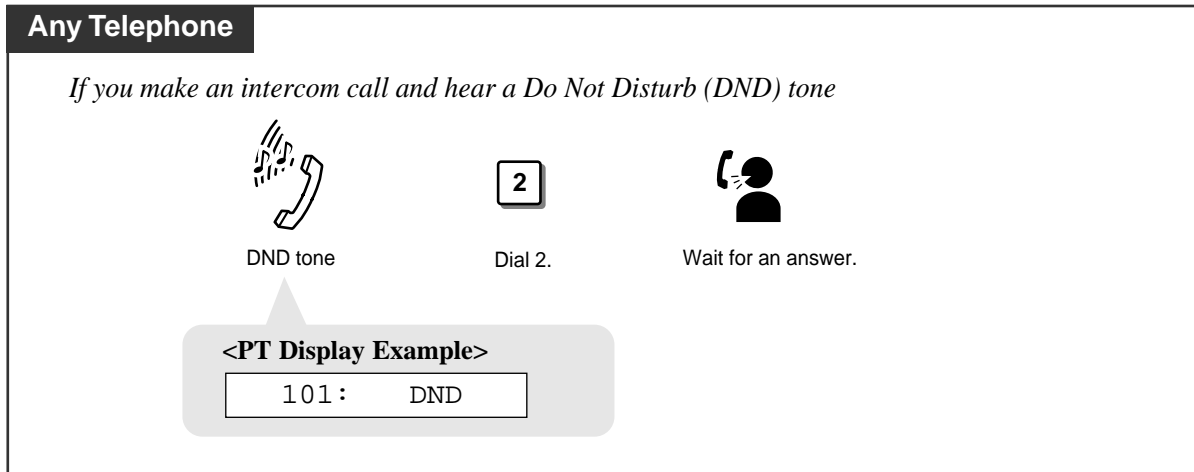

Conditions

- If you hear a reorder tone after dialing 2, the “Do Not Disturb (DND) Override” feature is not set at your extension.
- If you hear a busy tone after dialing 2, the line is busy. You can use the Automatic Callback Busy (Camp-On) feature.

Programming Reference

- System Programming — Installation Manual
[609] Do Not Disturb Override

Feature References

Automatic Callback Busy (Camp-On)
Do Not Disturb (DND)

Door Opener

Allows you to unlock the door from your telephone.
Up to four door openers can be connected to the system.

To unlock the door from an assigned extension

Any Telephone

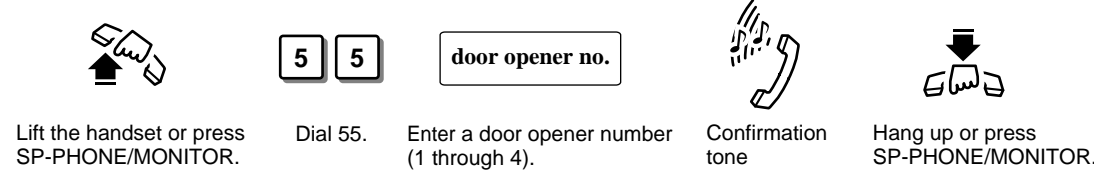

Lift the handset or press SP-PHONE/MONITOR.

Dial 55.

Enter a door opener number (1 through 4).

Confirmation tone

Hang up or press SP-PHONE/MONITOR.

- The door is left unlocked for 5 seconds (default).

<PT Display Example>

D - Opener x-On

door opener number

To unlock the door while talking to the doorphone

PT and SLT

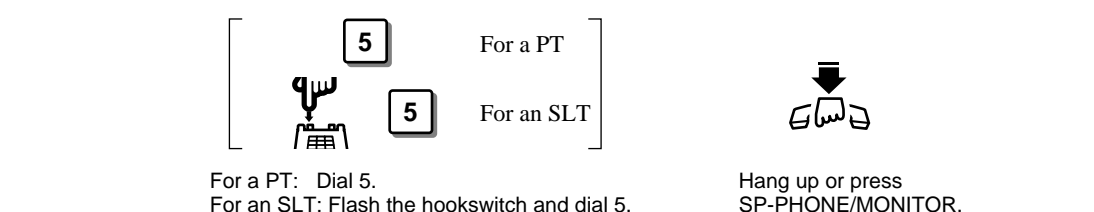

For a PT: Dial 5.

For an SLT: Flash the hookswitch and dial 5.

Hang up or press SP-PHONE/MONITOR.

- The door is left unlocked for 5 seconds (default).

<PT Display Example>

D - Opener x-On

door opener number

3.2 Telephone Features

D

Conditions

- An optional Doorphone/Door Opener card is necessary for this feature.
- If you dial 5 again while the door is open, the door will stay open for another five seconds (default).
- You must program the extensions which can open the doors for the day, night and lunch modes.
- You can modify the door opener timer through System Programming.
- The door opener will open the door, even if a doorphone is not installed.

Programming References

- System Programming — Installation Manual
 - [703]–[705] Door Opener Assignment — Day/Night/Lunch
 - [709] Door Opener Timer

Doorphone Call

Allows you to have a conversation with a visitor at your doorphone.
Up to four doorphones can be connected to the system.

Calling an extension from a doorphone

Any Doorphone



Press the Doorphone button for one second.



Wait for an answer and talk.

Answering a doorphone call

Any Telephone

When you hear the doorphone ring tone at the extension



Lift the handset or press SP-PHONE.

Calling a doorphone

Any Telephone



Lift the handset or press SP-PHONE.

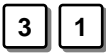

Dial 31.



Enter a doorphone number (1 through 4).



Confirmation tone



Talk.

<PT Display Example>



doorphone number

Conditions

- An optional Doorphone/Door Opener card and doorphones are necessary for this feature.
- If you do not answer an incoming doorphone call within fifteen or thirty seconds, the call will be canceled.
- You must program the extensions which can receive calls from each doorphone for the day, night and lunch modes.
- Any extension user can call a doorphone.
- Doorphone 1 and Doorphone 2 cannot receive calls simultaneously. When one is in use, an extension user cannot have a conversation with the other. This is the same for Doorphone 3 and Doorphone 4.
- Doorphones can also be used for the Room Monitor feature.

Programming References

- System Programming — Installation Manual
 - [700]–[702] Doorphone Ringing Assignment — Day/Night/Lunch
 - [706] Doorphone Ringing/Tone Pattern Selection
 - [707] Doorphone Access Tone Selection
 - [708] Doorphone Ringing Time

Feature References

Call Waiting
Room Monitor

Electronic Station Lockout

Allows you to lock your extension so that other users cannot make outside calls from your extension. This feature also works as Call Log Lock, Incoming in the Personal Area.

Locking

Any Telephone

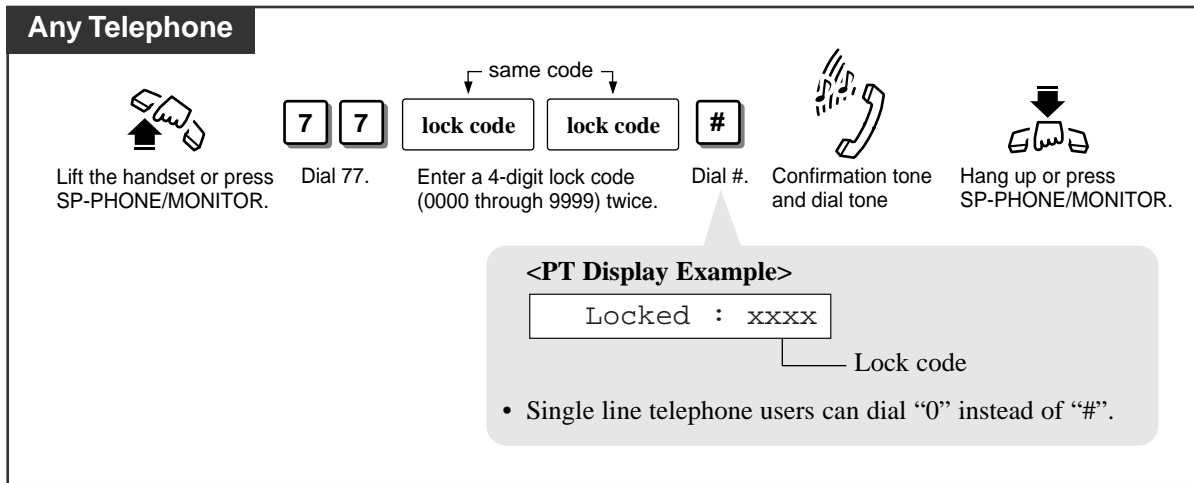

Lift the handset or press SP-PHONE/MONITOR.

Dial 77.

Enter a 4-digit lock code (0000 through 9999) twice.

Dial #.

Confirmation tone and dial tone

Hang up or press SP-PHONE/MONITOR.

<PT Display Example>

Locked : xxxx

Lock code

- Single line telephone users can dial "0" instead of "#".

Unlocking

Any Telephone

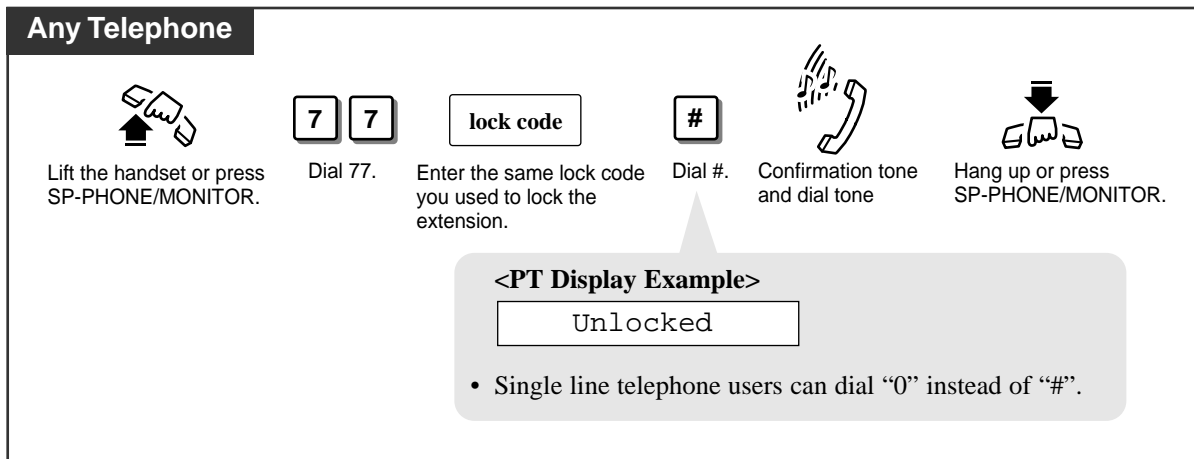

Lift the handset or press SP-PHONE/MONITOR.

Dial 77.

Enter the same lock code you used to lock the extension.

Dial #.

Confirmation tone and dial tone

Hang up or press SP-PHONE/MONITOR.

<PT Display Example>

Unlocked

- Single line telephone users can dial "0" instead of "#".

Conditions

- If another user tries to access an outside (CO) line and presses a dial key from a locked extension, the user will hear a reorder tone and for PT users “Restricted” is shown on the display.
However, calls can be made at a locked extension depending on system programming. System programming determines which COS number applies to calls at the locked extension.
- An extension assigned as an operator or manager can cancel this feature for all extensions (Electronic Station Lockout — CANCEL ALL).
- “Remote Station Lock Control” overrides this feature. If the operator or manager sets Remote Station Lock on the extension you have already locked, you cannot unlock it.
- The lock code must be four digits and must not have the “#” and “*” buttons.
- You can make intercom calls and receive intercom or outside calls at a locked extension.

Programming Reference

- System Programming — Installation Manual
[312] Toll Restriction — Station Lock Boundary Class

Feature References

Call Log Lock, Incoming in the Personal Area
Electronic Station Lockout — CANCEL ALL (3.3 Operator/Manager Service Features)
Remote Station Lock Control (3.3 Operator/Manager Service Features)
Toll Restriction — Station Lock Boundary Class

Emergency Call

Allows you to dial a pre-assigned emergency number after seizing an outside (CO) line. Up to five emergency dial numbers can be stored.

Dialing

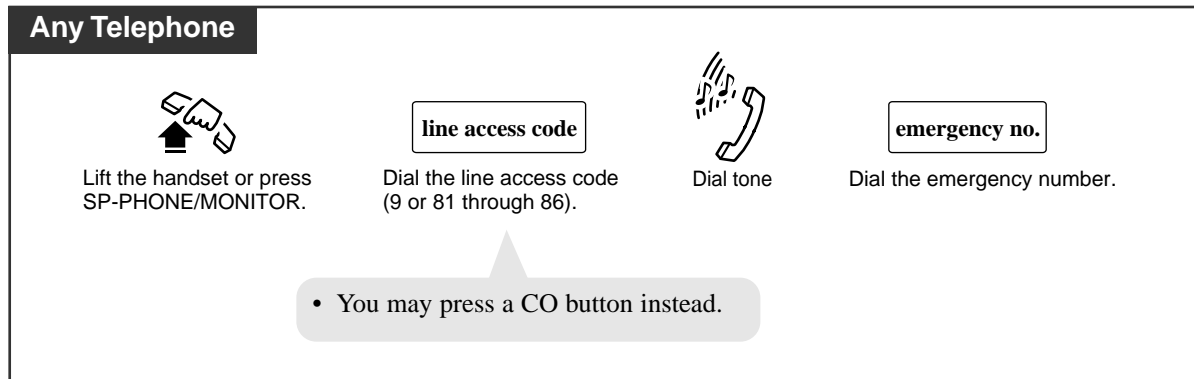

Conditions

- An emergency call is allowed even in the following cases,
 - Account Code – Verify (All) mode
 - Any toll restriction COS number
 - Electronic Station Lockout
- If your system is connected to a host PBX, you must dial the host PBX line access code after the line access code.

Programming References

- System Programming — Installation Manual
 - [309] Emergency Dial Number Set
 - [403] Host PBX Access Codes

Feature References

Account Code Entry
Electronic Station Lockout
Toll Restriction (→ See the Installation Manual.)

3.2 Telephone Features

E

Executive Busy Override — Extension

Allows you to connect to an existing intercom (extension) call. System Programming is required to use this feature.

Any Telephone

If you make an intercom call and while hearing a busy tone

 Dial 2.

 Confirmation tone (optional)

A three-party conference is now established.

To leave the conference

Any Telephone

 Hang up or press SP-PHONE.

The other two parties continue their conversation.

To terminate one party and talk to the other

PT

CO or INTERCOM

Press the CO or INTERCOM of the party to remain connected.

 Confirmation tone (optional)

- If all three parties are extensions, this operation is not available.

Conditions

- This feature does not work when “Data Line Security” or “Executive Busy Override Deny” is set at either or both of the other parties.
- When a two-party call is changed to a three-party call or vice versa, a confirmation tone is sent to all parties. The tone can be disabled.

Programming References



- System Programming — Installation Manual
 - [105] Conference Tone
 - [608] Executive Busy Override

Feature References

Conference
Data Line Security
Executive Busy Override Deny

Executive Busy Override — Outside (CO) Line



Allows you to connect to an existing outside call or add a third party to your existing conversation. System Programming is required to use this feature.

PT		
 Lift the handset or press SP-PHONE/MONITOR.	 Press the desired CO whose indicator is lit red.	 Confirmation tone (optional)
A three-party conference is now established.		

To leave the conference

PT	
 Hang up or press SP-PHONE/MONITOR.	The other two parties continue their conversation.

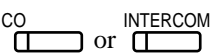
To terminate one party and talk to the other

PT	
 Press the CO or INTERCOM of the party to remain connected.	 Confirmation tone (optional)

Conditions

- PT** • This feature does not work when “Data Line Security” or “Executive Busy Override Deny” is set at the extension engaged in the existing outside call.
- PT** • When a two-party call is changed to a three-party call or vice versa, a confirmation tone is sent to all parties. The tone can be disabled.

Programming References

- System Programming — Installation Manual
 - [105] Conference Tone
 - [608] Executive Busy Override

Feature References

Conference
Data Line Security
Executive Busy Override Deny

3.2 Telephone Features

E

Executive Busy Override Deny

Allows you to prevent other extension users from interrupting your conversation.

Setting / Canceling

Any Telephone

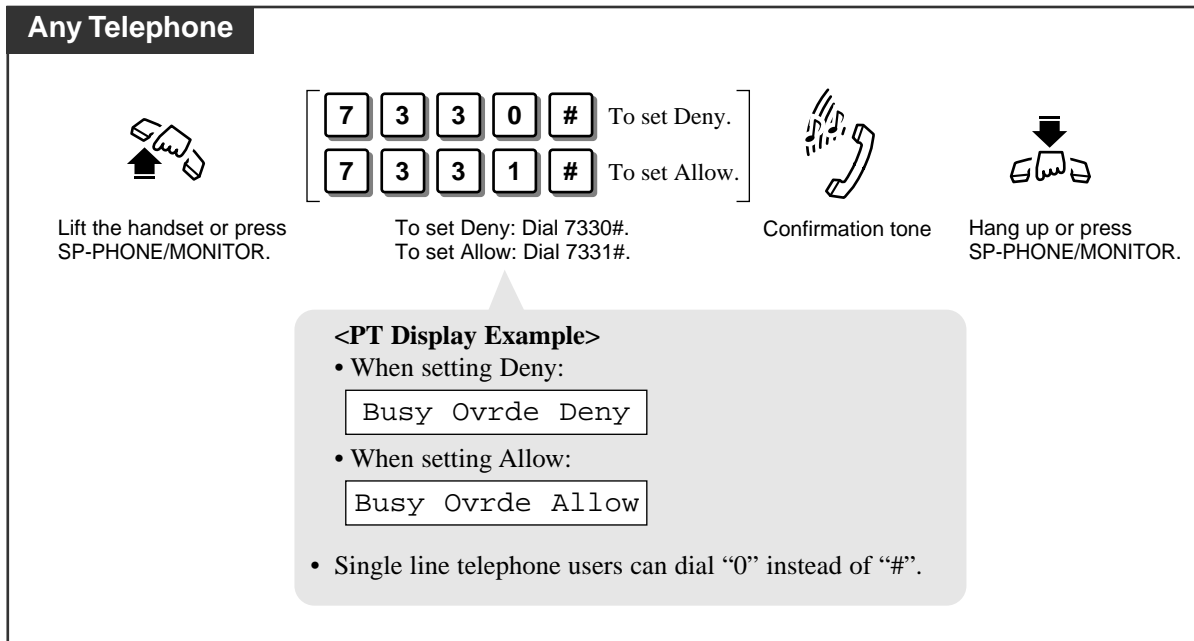

Lift the handset or press SP-PHONE/MONITOR.

7	3	3	0	#	To set Deny.
7	3	3	1	#	To set Allow.

To set Deny: Dial 7330#.
To set Allow: Dial 7331#.

Confirmation tone

Hang up or press SP-PHONE/MONITOR.

<PT Display Example>

- When setting Deny:
Busy Ovrde Deny
- When setting Allow:
Busy Ovrde Allow
- Single line telephone users can dial "0" instead of "#".

Programming Reference

- System Programming — Installation Manual
[608] Executive Busy Override

Feature References

- Executive Busy Override — Extension
- Executive Busy Override — Outside (CO) Line

External Feature Access

Allows you to access special features (e.g., Call Waiting) offered by a host PBX or Central Office. This feature is effective only during an outside call. You can access the feature by using either the FLASH button or the feature number.

Using the FLASH button

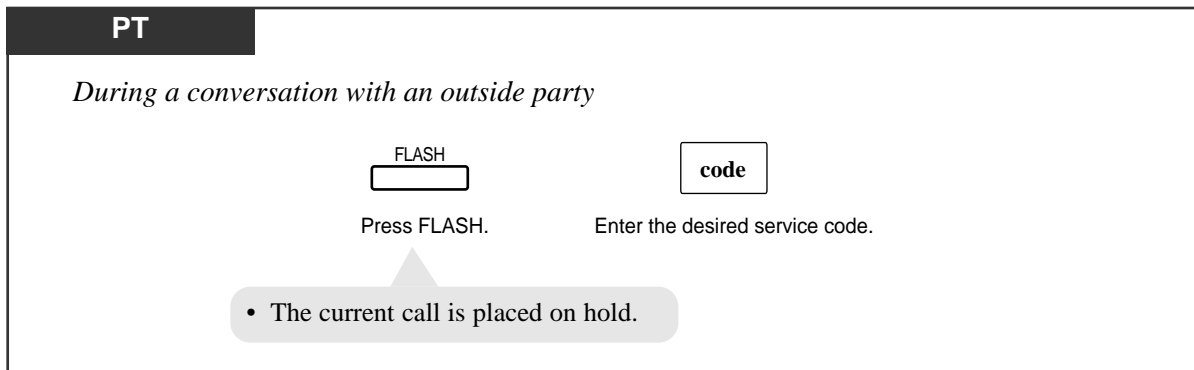

Using the feature number

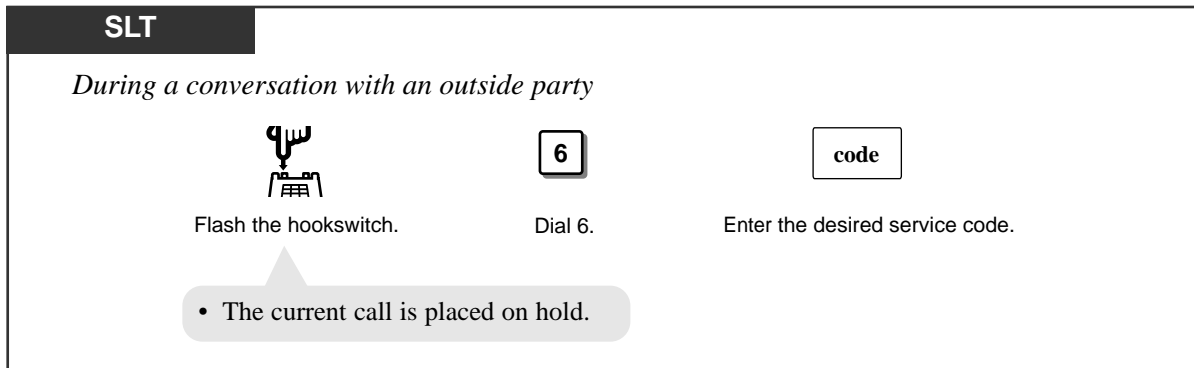

Conditions

- PT** • A “Flash Time” must be assigned as required by the host PBX, or outside (CO) line.
- PT** • You may access some features of the host PBX using the FLASH button. If the system is connected to a host PBX and the flash operation is required, follow the flash operation procedure which is required by the host PBX.

Programming References

- System Programming — Installation Manual
 - [110] Flash Key Mode
 - [418] Flash Time

Feature Reference

Flash

3.2 Telephone Features

F

Flash

Allows you to disconnect the current call and make another call without hanging up.

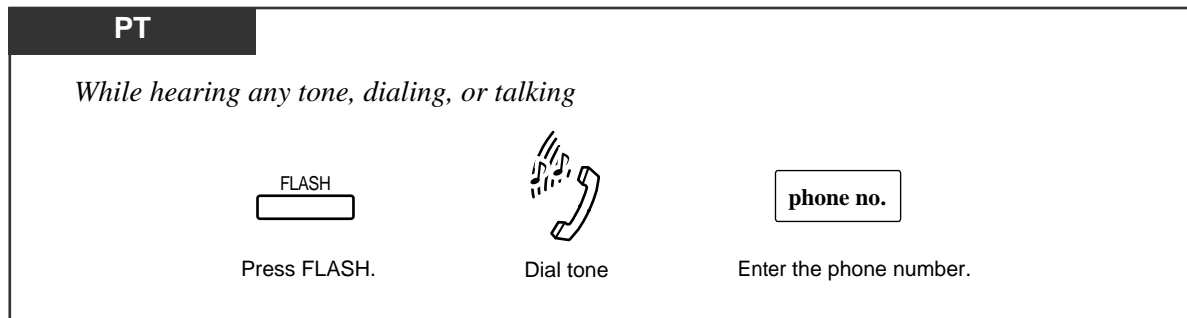

Condition

- System Programming may be required to perform this feature properly.

Programming References

- System Programming — Installation Manual
 - [110] Flash Key Mode
 - [418] Flash Time

Feature Reference

External Feature Access

Hands-free Answerback

(— for KX-T7020/KX-T7030/KX-T7130/KX-T7135 only)

Allows you to answer an intercom call without lifting the handset.

Setting

PT

When the SP-PHONE and the AUTO ANSWER/MUTE indicators are off

AUTO ANSWER
MUTE

Press AUTO ANSWER/MUTE.

- The AUTO ANSWER/MUTE indicator turns on.

Canceling

PT

When the AUTO ANSWER/MUTE indicator is on

AUTO ANSWER
MUTE

Press AUTO ANSWER/MUTE.

- The AUTO ANSWER/MUTE indicator light turns off.

Conditions

- PT** • This feature does not work for incoming outside calls or doorphone calls.
- PT** • When an outside call is transferred to your extension, this feature is overridden and a ring tone is heard.

Hands-free Operation

(— for KX-T7020/KX-T7030/KX-T7130/KX-T7135 only)

Allows you to dial and to talk to the other party without lifting the handset.

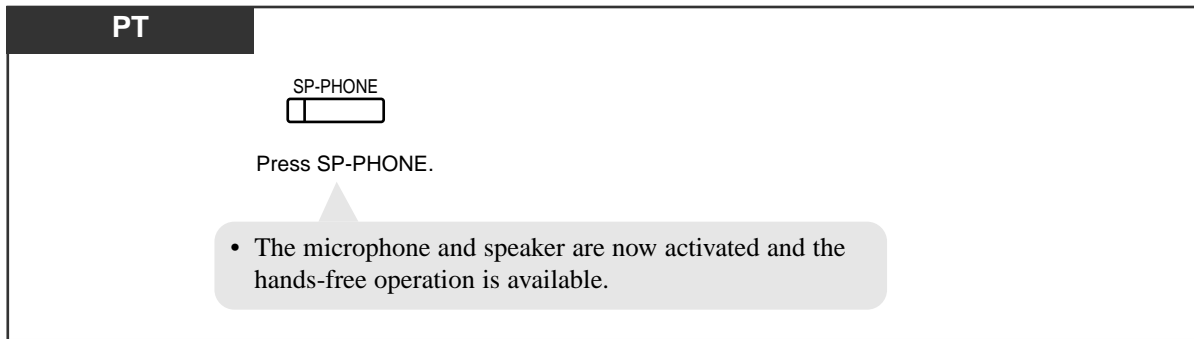

Switching from the handset to hands-free mode

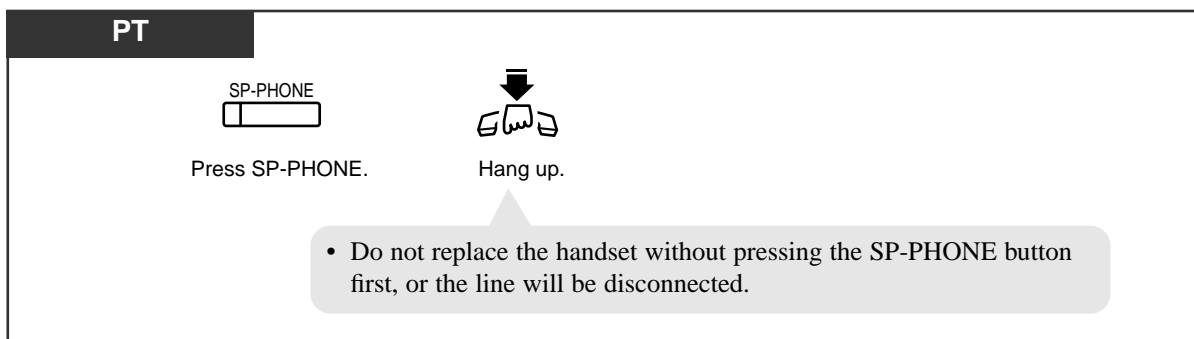

Switching from hands-free to the handset mode

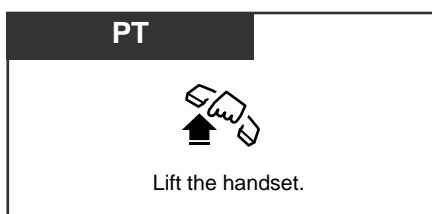

Conditions

- PT • Helpful hints for the Hands-free operation:
 - Use this unit in a quiet room for best performance.
 - If you and the other party talk at the same time, parts of your conversation will be lost. To avoid this, talk alternately.
- PT • The hands-free mode is canceled if you do not start dialing within ten seconds.
- PT • The KX-T7050 and KX-T7055 have MONITOR buttons instead of a SP-PHONE button. It can be used for hands-free dialing, etc., but it cannot be used for a hands-free conversation.
- PT • You can enable the hands-free mode by pressing a CO or INTERCOM button.

Intercom Calling

Allows you to make a call to another extension.

Using the handset

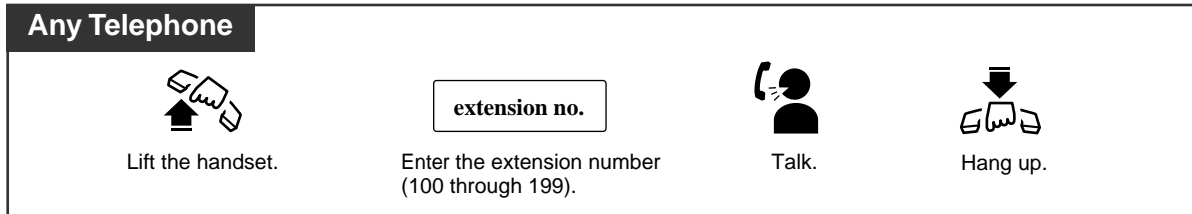

Using the Speakerphone

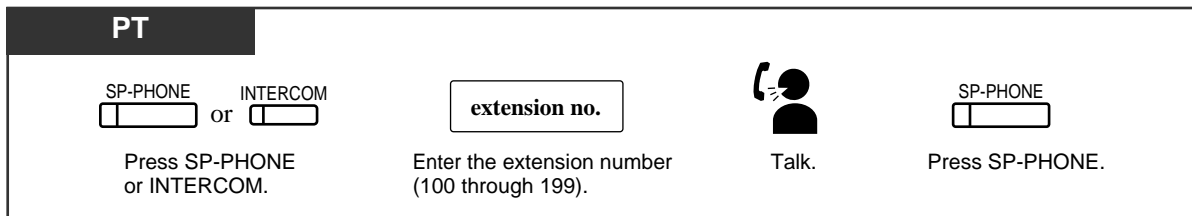

Using a DSS (Direct Station Selection) button

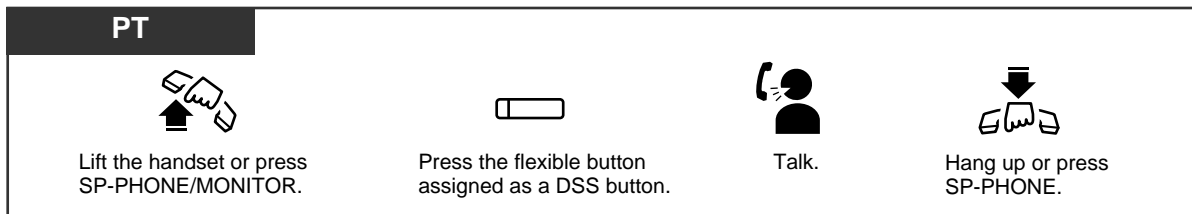

Conditions

- After dialing an extension number, you will hear one of the following tones.
 - Ringback tone:** Indicates the destination extension is being called.
 - Confirmation tone:** Indicates you can perform voice calling (e.g., Paging).
 - Busy tone:** Indicates the destination extension is busy.
 - Do Not Disturb (DND) tone:** Indicates the destination extension has set the “Do Not Disturb (DND)” feature.

- An extension number and a name, if programmed, are shown on a display PT during an intercom call.
- You can assign a DSS button on a flexible button through Station Programming. The stored number can be displayed by pressing the desired DSS button while on-hook.

Programming References

- Station Programming (Section 2)
 - Flexible Button Assignment — Direct Station Selection (DSS) Button
- System Programming — Installation Manual
 - [009] Extension Number Assignment
 - [604] Extension Name Setting

Live Call Screening (LCS) †

While a caller is leaving a message in your mailbox, you can monitor the message. If desired, you can answer the call while monitoring. There are two methods available. In both modes, when you are having a conversation, you will hear a Call Waiting tone if Call Waiting has been enabled.

Hands-free mode: You can monitor a message automatically through the telephone speaker at the same time.

Private mode: You will hear an alert tone while the caller is leaving a message.

Preparation

- Assign the Live Call Screening (LCS) button (Station Programming)
- Select the mode, either Hands-free or Private (Station Programming)
- Set the Password
- Set the LCS feature

Flowchart of the Live Call Screening (LCS) Feature

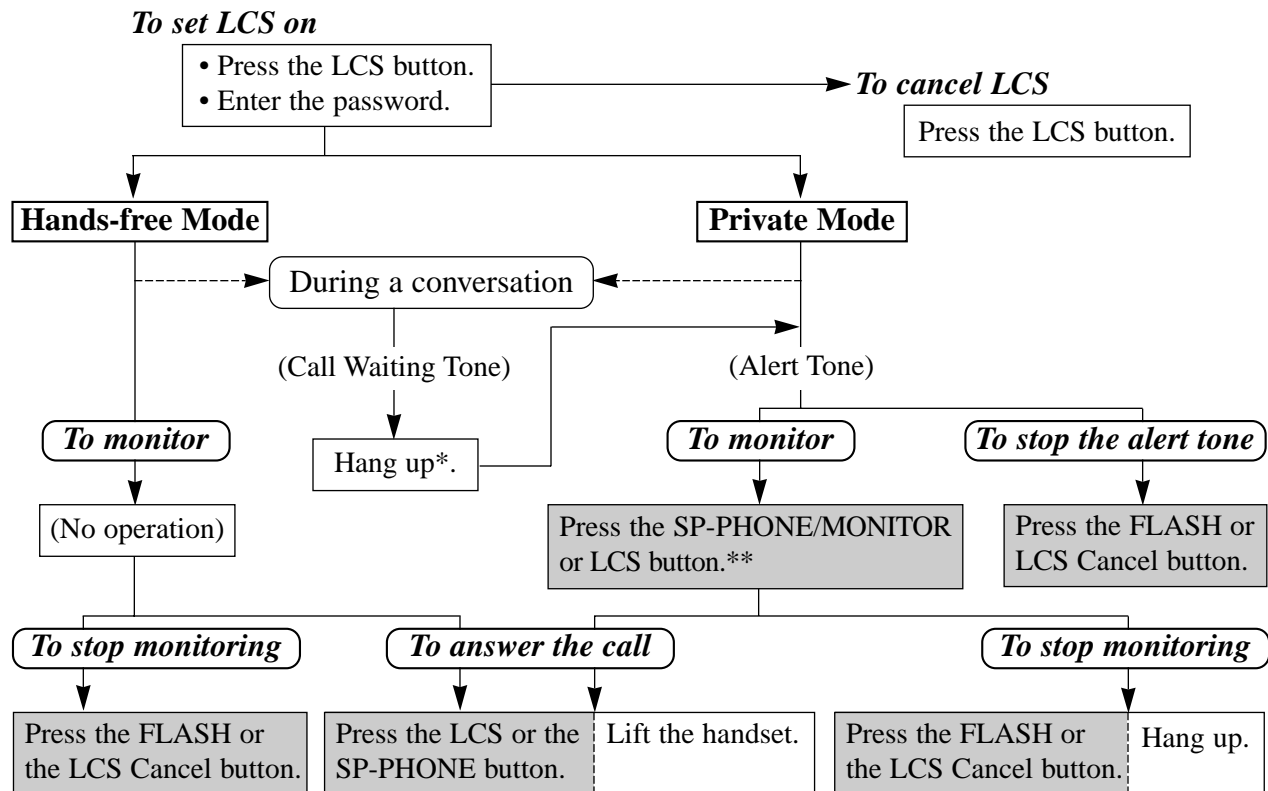

- *: To hold the current call temporarily, press the HOLD button. To return to the held call, press the CO button whose indicator light flashes green slowly.
- **: If you lift the handset to monitor a message recording, the caller will be able to hear you. Even in this case, the message will still be recorded.
- The shaded areas are for the Hands-free operation.

† Available when the KX-TA624 is connected to a Proprietary Telephone capable Panasonic Voice Processing System (one that supports APT Integration; KX-TVS50/KX-TVS80).

Setting the password

PT

Lift the handset or press SP-PHONE/MONITOR.

Dial 77*.

Enter the password (000 through 999) twice.

Dial #.

Confirmation tone and dial tone

Hang up or press SP-PHONE/MONITOR.

<PT Display Example>

Password: xxx

password

- To change your password, you must follow the instructions below for “Canceling the password”.

Canceling the password

PT

Lift the handset or press SP-PHONE/MONITOR.

Dial 77*.

Enter the password (000 through 999).

Dial #.

Confirmation tone and dial tone

Hang up or press SP-PHONE/MONITOR.

<PT Display Example>

Password Cancel

Setting Live Call Screening

PT

When the telephone is idle and on-hook.

Press the Flexible button assigned as the Live Call Screening button.

Enter the password (000 through 999).

<PT Display Example>

LCS

- The Live Call Screening indicator light turns red.

3.2 Telephone Features

L

Canceling Live Call Screening

PT

When the telephone is idle and on-hook;



Press the Flexible button assigned as the Live Call Screening button.

<PT Display Example>

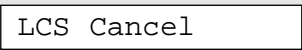

- The Live Call Screening indicator light turns off.

In the Hands-free mode;

When callers are connected to your voice mailbox, the message recording is monitored automatically through your extension speaker. While monitoring in the Hands-free mode, the Live Call Screening indicator light flashes slowly.

Having a conversation with a party

PT

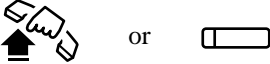

Lift the handset or press SP-PHONE, or press the Live Call Screening button.

- The Live Call Screening indicator light turns red from flashing slowly.
- In the Keep Recording mode, the Two-Way Record indicator turns on. Pressing the Two-Way Record button cancels the recording and the light turns off.

Stopping the monitoring

PT

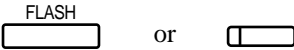



Press FLASH or the Live Call Screening Cancel button.

- The Live Call Screening indicator light turns red from flashing slowly.

In the Private mode;

Stopping the alert tone

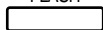
PT

 or 

Press FLASH or the Live Call Screening Cancel button.

Monitoring the message recording

PT





Press SP-PHONE/MONITOR or the Live Call Screening button.

- To stop monitoring, hang up, press FLASH or the Live Call Screening Cancel button.
- If you lift the handset to monitor the message recording, the caller will be able to hear you. Even in this case, the message will still be recorded.

Talking to the party

PT

 or 

Lift the handset or press SP-PHONE, or the flashing Live Call Screening button.

3.2 Telephone Features

L

During a conversation with another party;

When the extension user is having a conversation, the Call Waiting tone will be heard if Call Waiting has been enabled. The Live Call Screening indicator light flashes.

— *If you want to terminate the current call*

Monitoring

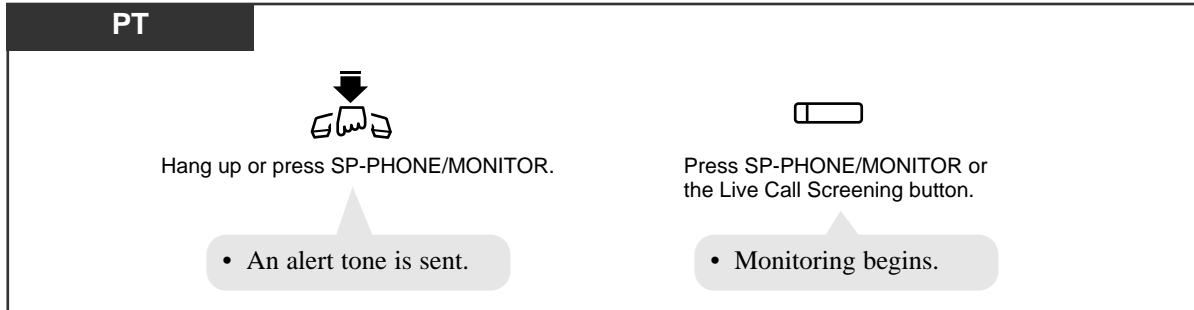

Having a conversation with a party

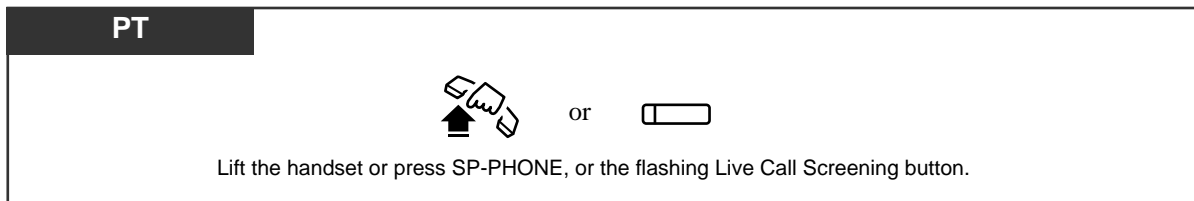

— *If you want to hold the current call*

Monitoring

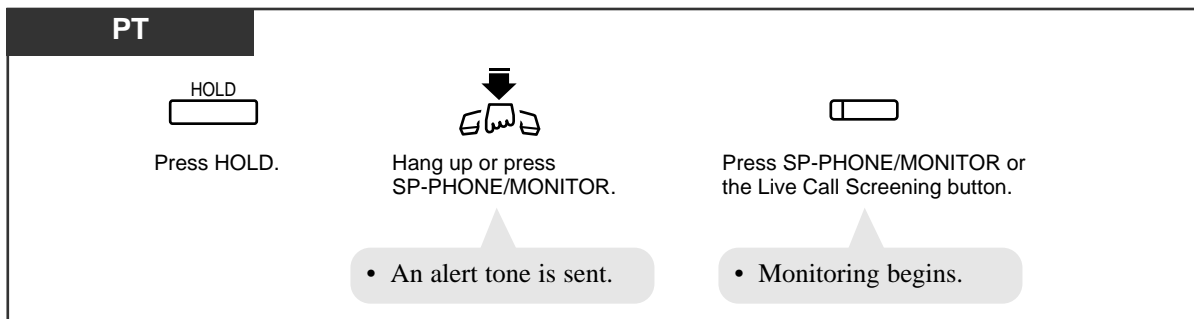

Having a conversation with a party

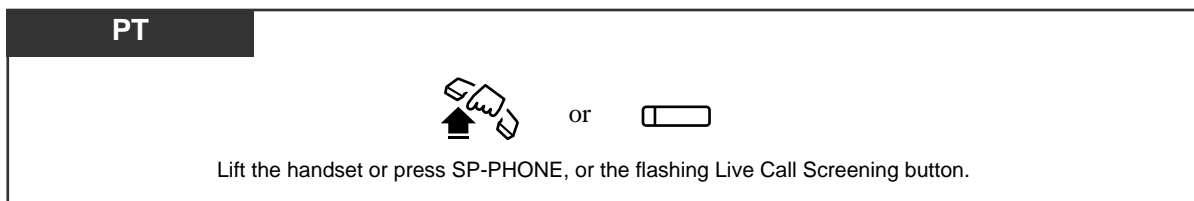

Conditions

- PT • A flexible CO or DSS button can be assigned as the Live Call Screening (LCS) button or the Live Call Screening (LCS) Cancel button.
- PT • The Live Call Screening indicator shows the feature status as follows:
 - Red (steady). The Live Call Screening mode is on.
 - Off The Live Call Screening mode is off.
 - Flashing green slowly . . . Live Call Screening is active.*
 - Flashing green rapidly . . . An alert tone is ringing.**
 - * The DSS button indicator flashes red slowly while Live Call Screening is active.
 - ** The DSS button indicator flashes red moderately while an alert tone is ringing.
- PT • The Two-Way Record indicator shows the feature status as follows:
 - On Recording the conversation.
 - Off. Not recording.
- PT • The operator and the manager can clear a password at any extension.
- PT • During the Keep Recording mode, if you want to stop recording the conversation, press the Two-Way Recording button.
- PT • With the KX-T7030, KX-T7130 and KX-T7135, you can assign the password using the display operation.

Programming References

- Station Programming (Section 2)
 - Flexible Button Assignment — Live Call Screening (LCS) Button,
Live Call Screening (LCS) Cancel Button
Two-Way Record Button
 - Live Call Screening Mode Set
- System Programming — Installation Manual
 - [620] Live Call Screening Recording Mode Assignment

Feature References

- Live Call Screen Password Control (3.3 Operator/Manager Service Features)
- Station Programming — Live Call Screening (LCS) Button Assignment
- Live Call Screening (LCS) Cancel Button Assignment
(4.2 DSS Console Features)

3.2 Telephone Features

L

Lockout

If one party in a conversation goes on-hook, both parties will be disconnected from the speech path automatically. A reorder tone is sent to the off-hook party before it is disconnected. No operation is necessary.

Log-In/Log-Out

Allows you to assign the Log-In mode or Log-Out mode within a hunting or ring group. When in the Log-Out mode, you can leave the group temporarily, preventing hunting calls from being sent to your extension. The lighting patterns of the Log-In/Log-Out button on a proprietary telephone and status are as follows.

- Off: Log-In mode
- Red: Log-Out mode

Log-In / Log-Out (Using the Log-In/Log-Out button)

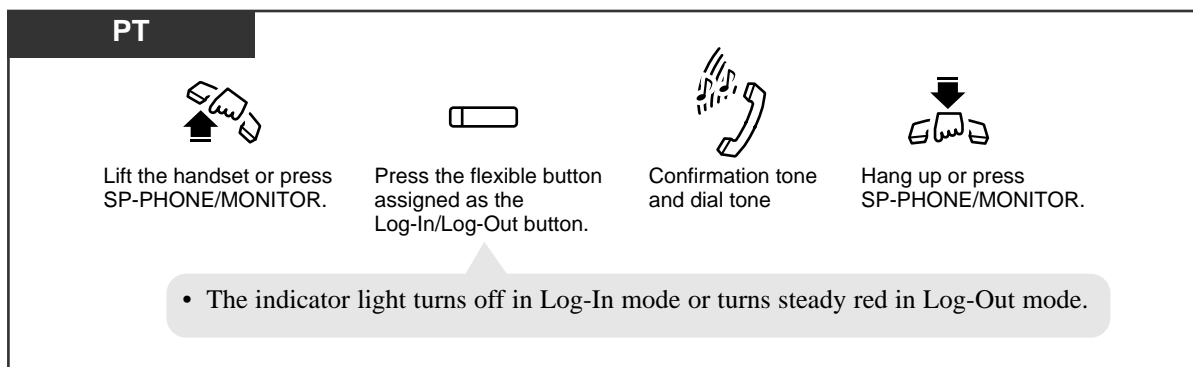

Log-In / Log-Out (Using the feature number)

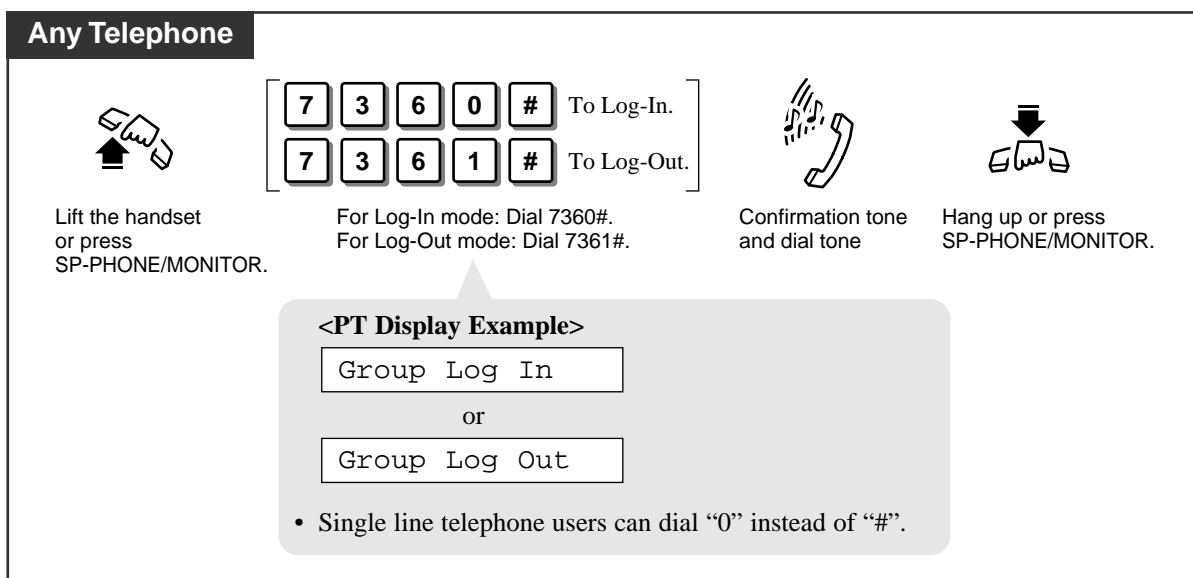

Conditions

- The default is “Log-In” mode.
 - There should be at least one extension that is in Log-In mode.
 - If every extension has logged out except one person, and that person tries to log out, their extensions will display “Not Valid”. In other words, the last member of the group cannot log out.
- PT • The Log-In/Log-Out button can be assigned to a flexible CO button.

Programming References

- Station Programming (Section 2)
Flexible Button Assignment — Log-In/Log-Out Button
- System Programming — Installation Manual
 - [100] Hunting Group Set
 - [600] Extension Group Assignment

Feature Reference

Station Hunting (→ See the Installation Manual.)

Message Waiting

When the called extension is busy or does not answer your call, you can leave a notification so that the called party may call you back.

As a message receiver, the MESSAGE button light lets you know that a call has been received. If you receive notification, you can call back the original party by a simple operation. This operation is available only for proprietary telephones with MESSAGE buttons.

Setting

Any Telephone



Lift the handset or press SP-PHONE/MONITOR. Dial 701. Enter the extension number (100 through 199) where the message will be left. Dial #. Confirmation tone and dial tone. Hang up or press SP-PHONE/MONITOR.

- Single line telephone users can dial “0” instead of “#”.

PT

If the called extension is busy or does not answer



Press MESSAGE. Confirmation tone and dial tone. Hang up or press SP-PHONE/MONITOR.

Canceling

Any Telephone



Lift the handset or press SP-PHONE/MONITOR. Dial 702. Enter the extension number (100 through 199) where you left a message. Dial #. Confirmation tone and dial tone. Hang up or press SP-PHONE/MONITOR.

- Single line telephone users can dial “0” instead of “#”.

Canceling using the MESSAGE button

PT

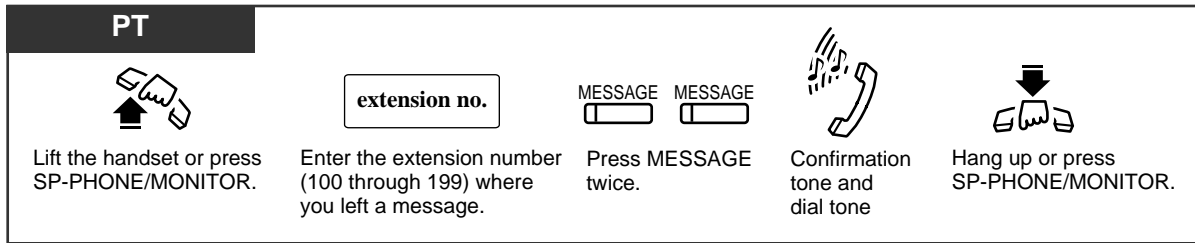

Lift the handset or press SP-PHONE/MONITOR.

extension no.
Enter the extension number (100 through 199) where you left a message.

MESSAGE MESSAGE
Press MESSAGE twice.

Confirmation tone and dial tone

Hang up or press SP-PHONE/MONITOR.

Checking and Selecting a message notification by the message receiver

If there is a message, the message waiting lamp (MESSAGE button indicator) light will be on.

PT

When the telephone is idle and on-hook



MESSAGE
[]

Press MESSAGE repeatedly until the desired message appears.

- The stored messages are shown on the display in the order they were received.
- When Tony at extension 123 left a message:
<PT Display Example>
123 : Tony

Calling back the message notification sender

PT

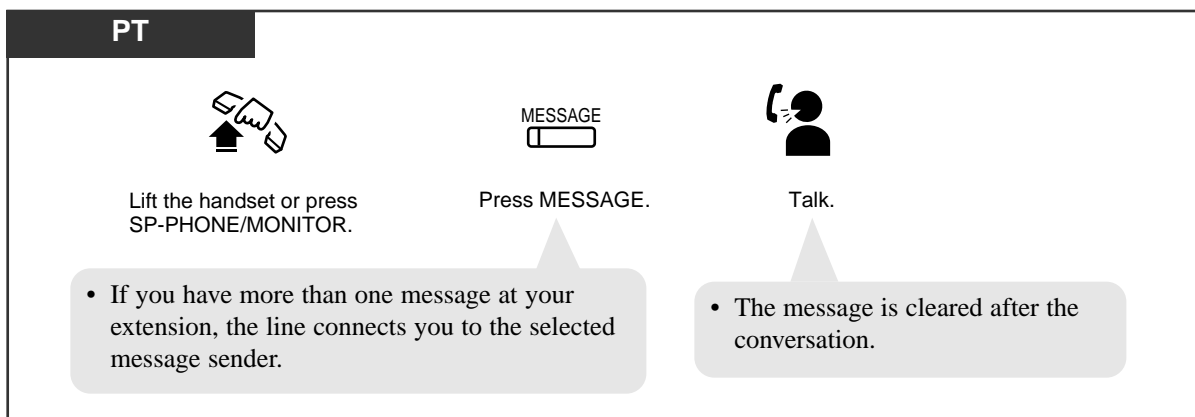

Lift the handset or press SP-PHONE/MONITOR.

MESSAGE
[]

Press MESSAGE.

Talk.

- If you have more than one message at your extension, the line connects you to the selected message sender.
- The message is cleared after the conversation.

3.2 Telephone Features

M

Clearing all message notifications by the message receiver

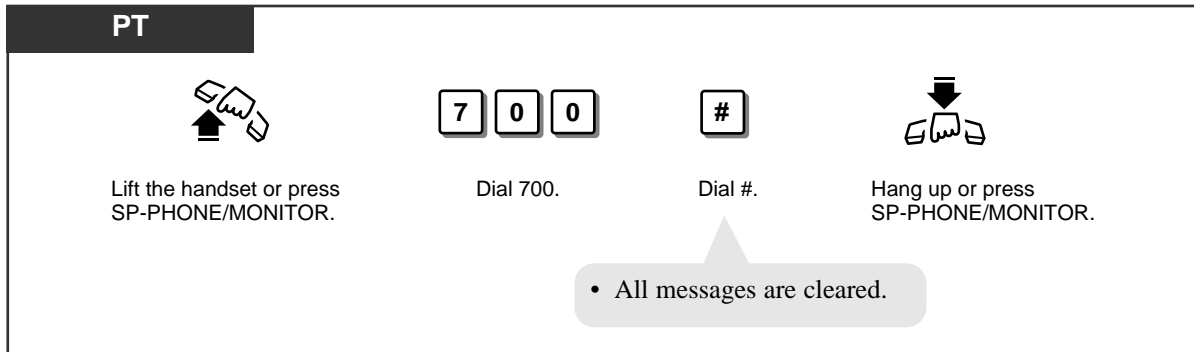

Conditions

- PT** • Each extension can have a maximum of 8 simultaneous messages. If you try to set the ninth message, you will hear a reorder tone.
- PT** • If the MESSAGE indicator does not go out after calling the extension which left the message, another message is waiting.
- PT** • If multiple message notifications are left at your extension, call back is executed in the order received.
- PT** • If you select a specific message to call back, the other call backs will be executed in the order received, starting with the one selected.
(ex.) 5 → 6 → 7 → 8 → 1 → 2 → 3 → 4

Programming Reference

- Station Programming (Section 2)
Flexible Button Assignment — Return to Message Waiting (MESSAGE) Button

Feature Reference

Message Waiting for Another Extension

Message Waiting for Another Extension

Allows you to check messages left at another extension and call back the message sender. The Another Extension Message Waiting button light on your extension lets you know that another extension has a message waiting. You can call back the message sender by a simple operation. You can also clear all messages left at another extension. System Programming is required to use this feature.

Checking and Selecting a message notification at another extension

If there is a message at another extension, the message waiting lamp light (Another Extension Message Waiting button indicator) will be on.

PT

When the telephone is idle and on-hook



Press the Flexible button assigned as an Another Extension Message Waiting button repeatedly until the desired message appears.

- The stored messages are shown on the display in the order they were received.
- When Tony at extension 123 left a message:

<PT Display Example>

123 : Tony

Calling back the message notification sender for another extension

PT



Lift the handset or press SP-PHONE/MONITOR.



Press the Flexible button assigned as an Another Extension Message Waiting button.



Talk.

- If another extension has more than one message, the line connects you to the selected message sender.
- The message is cleared after the conversation.

3.2 Telephone Features

Clearing all message notifications at another extension

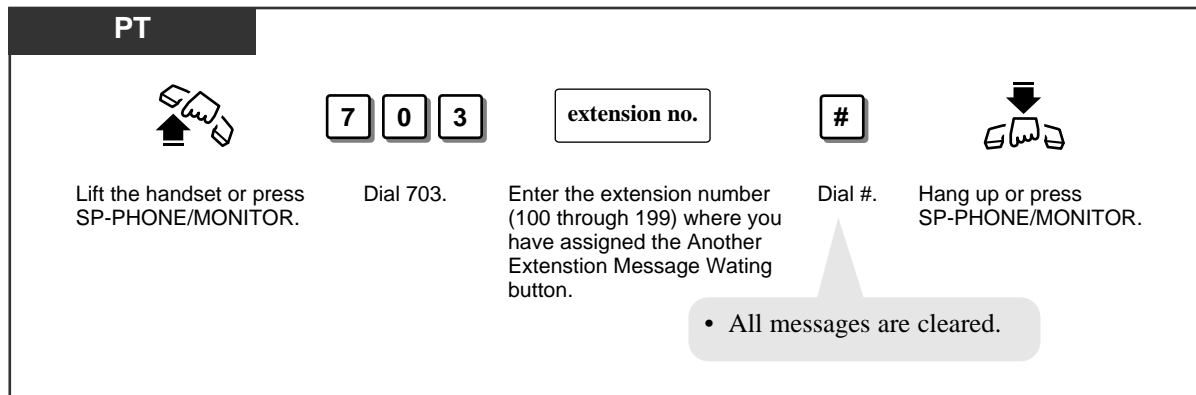

Conditions

- PT • If the Another Extension Message Waiting button indicator does not go out after calling the extension which left the message, another message is waiting.
- PT • If multiple message notifications are left at another extension, call back is executed in the order received.
- PT • If you select a specific message to call back, the other call backs will be executed in the order received, starting with the one selected.
(ex.) 5 → 6 → 7 → 8 → 1 → 2 → 3 → 4
- PT • The Another Extension Message Waiting button indicator light will be on and off simultaneously with the MESSAGE button indicator on another extension.

Programming References

- Station Programming (Section 2)
Flexible Button Assignment — Another Extension Message Waiting Button
- System Programming — Installation Manual
[618] Message Waiting for Another Extension

Feature References

Message Waiting
Station Programming — Another Extension Message Waiting Button Assignment
(4.2 DSS Console Features)

Message Waiting for Another Extension Lock

Allows you to lock the Message Waiting for Another Extension feature so that another extension cannot check messages left at your extension.

Locking

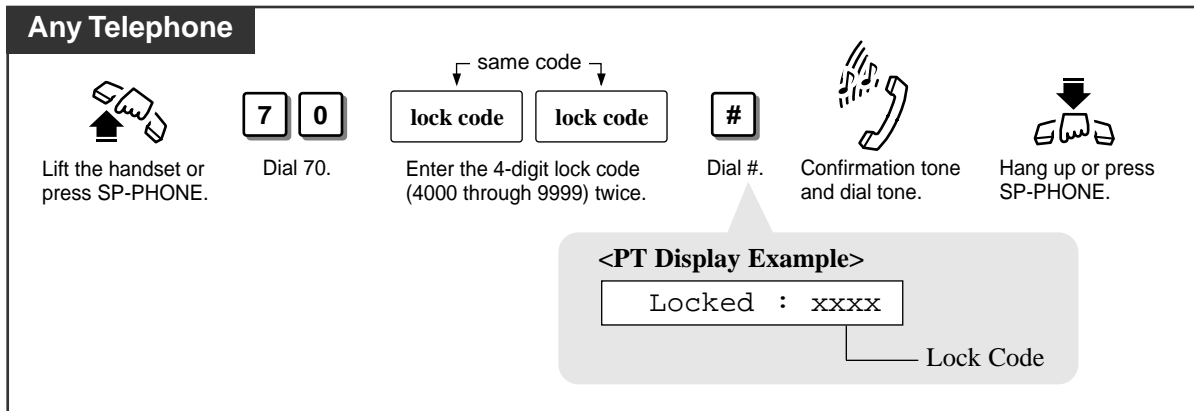

Unlocking

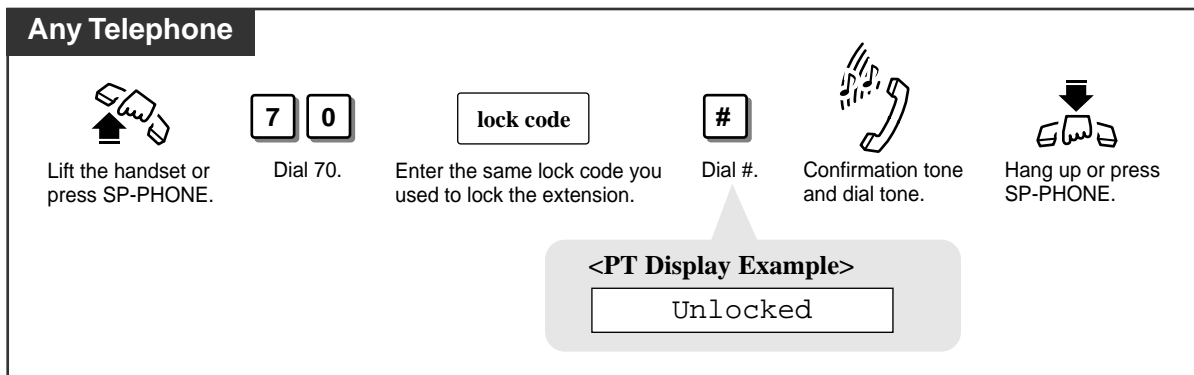

Conditions

- PT** • The operator or manager can cancel this feature for all other extensions (Electronic Station Lockout — CANCEL ALL).
- Another extension cannot clear message notifications at your extension while locked.
- Another Extension Message Waiting button indicator on another extension will light even if you have locked your extension, but another extension cannot check and call back messages left at your extension.
- Message Waiting feature at your extension is available even while locked.

Feature References

Message Waiting for Another Extension
Electronic Station Lockout — CANCEL ALL (3.3 Operator/Manager Service Features)

Microphone Mute

(— for KX-T7020/KX-T7030/KX-T7130/KX-T7135 only)

Allows you to turn off the microphone so you can consult privately with others in the room. You will still be able to hear the other party.

Setting

PT

During a conversation in the handsfree mode

AUTO ANSWER
MUTE

Press AUTO ANSWER/MUTE.

- The AUTO ANSWER/MUTE indicator light flashes red slowly.

Canceling

PT

When microphone mute is established

AUTO ANSWER
MUTE

Press AUTO ANSWER/MUTE.

- The AUTO ANSWER/MUTE indicator light turns off.

Condition

- PT** • This feature is only available during a hands-free conversation.

Mixed Station Dialing

Any telephone, either a KX-T7020/KX-T7030/KX-T7050/KX-T7055/KX-T7130/KX-T7135, single line rotary phone (10 pps, 20 pps) or single line touch tone telephone, may be used as an extension for the system.

One-Touch Dialing

Allows you to call a number or access a system feature with the touch of a button. This is done by storing an extension number, telephone number or feature number (up to twenty-four digits) in a One-Touch Dialing button.

Dialing

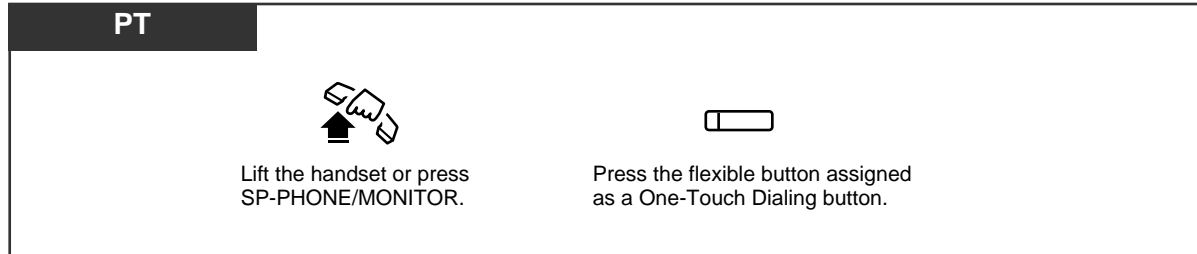

Conditions

- PT • The destination numbers are stored through Station Programming.
- PT • You may press a CO button to select a desired outside (CO) line before pressing the One-Touch Dialing button.
- PT • “Speed Dialing”, “One-Touch Dialing” and manual dialing can be used together.
- PT • You can store a number consisting of twenty-five digits or more by dividing and storing it into two One-Touch Dialing buttons.
- PT • The telephone number dialed will be displayed on the LCD. Use the FWD/DND (→) or CONF (←) button to scroll the display to either side.
- PT • A pause is automatically entered after the stored line access code, 9 or 81 through 86, when dialing.
- PT • To confirm the current status of the button, press the button while on-hook.

Programming Reference

- Station Programming (Section 2)
Flexible Button Assignment — One-Touch Dialing Button

Feature Reference

- Station Programming — One-Touch Dialing Assignment (4.2 DSS Console Features)

Operator Call

Allows you to call an operator within the system. One extension can be assigned as an operator.

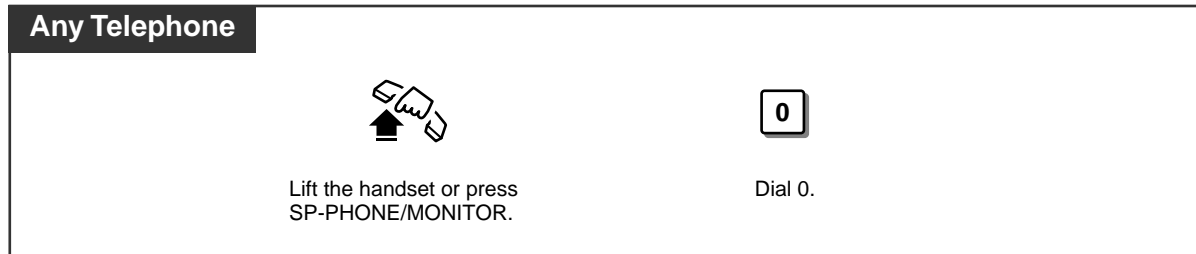

Condition

- If an operator is not assigned, this feature is not available and you will hear a reorder tone.

Programming Reference

- System Programming — Installation Manual
[008] Operator Assignment

Outward Dialing, Line Access — SUMMARY

An outside (CO) line can be accessed in the following ways.

Line Access, Automatic	Dial the feature number (9) .
Line Access, Individual	Press a Single-CO (S-CO) button.
Line Access, Outside (CO) Line Group	Dial the feature number (8) and an outside (CO) line group number (1-6) . or Press a Group-CO (G-CO) button

Conditions

- After dialing the feature number or pressing the CO button, you will hear one of the following tones.

Dial tone: Indicates an idle outside (CO) line is accessed.

CO x

— is shown on a PT display. (x: outside (CO) line number)

Busy tone: Indicates the selected outside (CO) line is busy.

CO in Use

— is shown on a PT display.

Reorder tone:

- 1) Indicates the outside (CO) line you have attempted to access is not assigned.

CO Not Assigned

— is shown on a PT display.

- 2) Indicates access to outside (CO) lines is denied.

Restricted

— is shown on a PT display.

- **Restricted** may be displayed on a PT display and a reorder tone may sound due to the following.

— The extension has been locked by the owner (Electronic Station Lockout) or the operator/manager (Remote Station Lock Control).

— The extension is restricted by the account code mode, “Verified - All”.

— The extension is restricted from making toll calls (Toll Restriction).

- PT** • The CO button assignment on your telephone can be re-arranged as required. Refer to the “Flexible Button Assignment” in Station Programming (Section 2).

- PT** • An outside (CO) line which is not assigned to a CO button cannot be dialed.

3.2 Telephone Features

Programming References

- Station Programming (Section 2)
Flexible Button Assignment — Group-CO (G-CO) Button,
Single-CO (S-CO) Button
- System Programming — Installation Manual
 - [400] Outside (CO) Line Connection Assignment
 - [404] Outside (CO) Line Group Assignment
 - [405]–[407] Flexible Outward Dialing Assignment — Day/Night/Lunch
 - [419] Automatic Designated Outside (CO) Line Access

Feature References

Account Code Entry
Electronic Station Lockout
Remote Station Lock Control (3.3 Operator/Manager Service Features)
Toll Restriction (→ See the Installation Manual.)

Line Access, Automatic

Allows you to select an available outside (CO) line automatically.

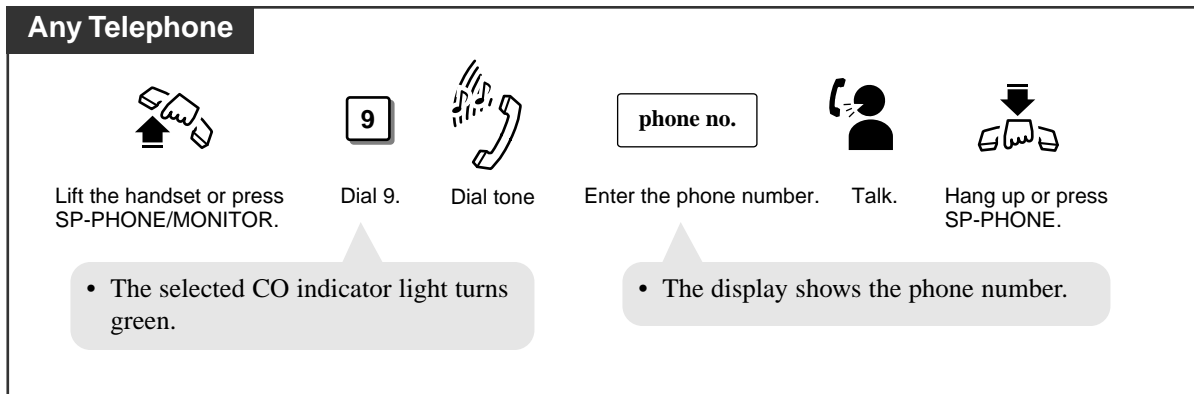

Line Access, Individual

Allows you to select the desired outside (CO) line without dialing the line access code.

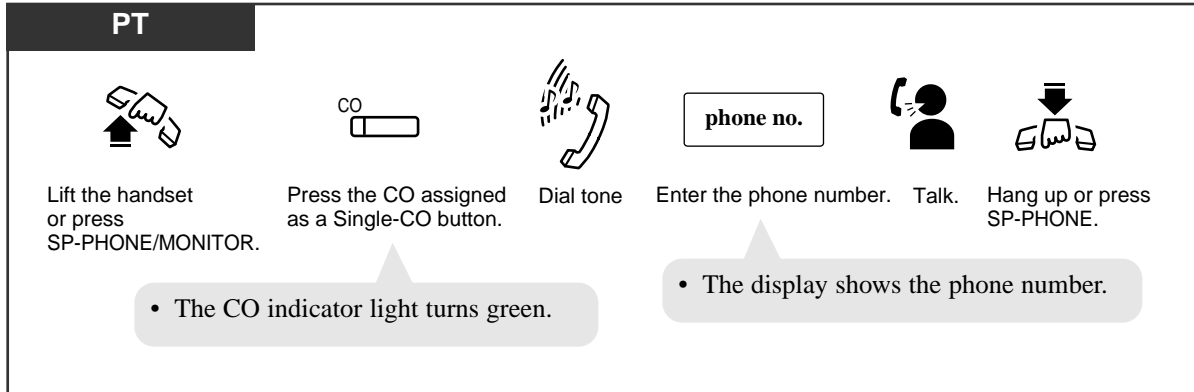

Condition

- PT** • You may skip off-hook and press the Single-CO (S-CO) button directly.

Line Access, Outside (CO) Line Group

Allows you to select an idle line within a designated outside (CO) line group. Through programming, outside (CO) lines can be divided into six line groups.

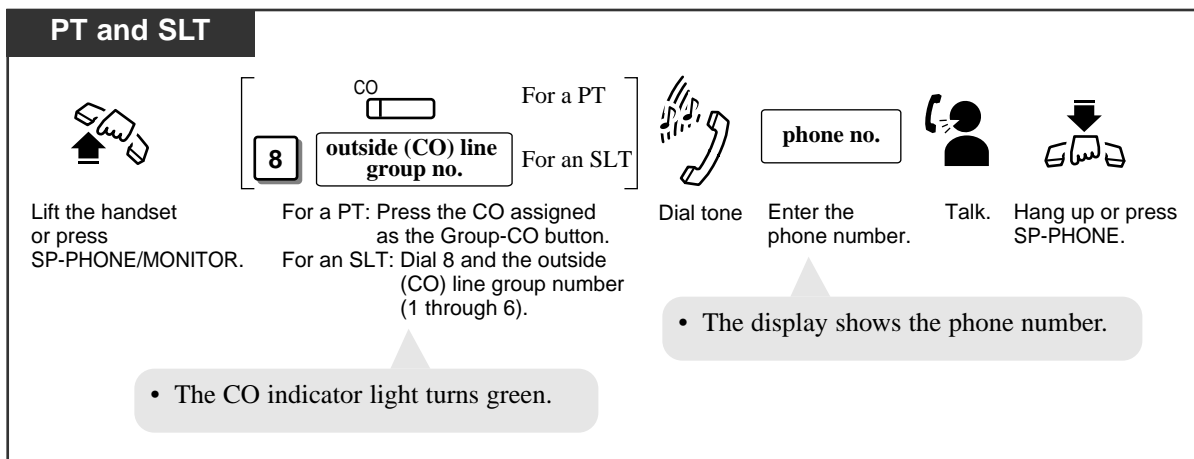

Condition

- PT** • You may press the Group-CO (G-CO) button directly without going off-hook.

Paging — SUMMARY

Allows you to make a voice announcement to several people at the same time. Your message is announced over the built-in speakers of proprietary telephones (PT) and/or an external speaker. The paged person can answer your page from a nearby telephone. You cannot be paged at a single line telephone, but you can answer a page, which is announced over nearby PTs or an external pager, from your single line telephone. There are three types of paging as shown below. You can select the appropriate type according to your needs.

Type	Description
Paging — All	Paging through both the built-in speakers and an external pager.
Paging — External	Paging to an external pager.
Paging — Group	Paging to all groups (all extensions) simultaneously.
	Paging to a particular group of extensions using the built-in speakers.

Conditions

- To answer the page, refer to “Paging — ANSWER”.
- The paged extension users hear a confirmation tone before the voice announcement.
- A confirmation tone is sent to the external pager (External Pager Confirmation Tone) before the voice announcement. The tone can be disabled.
- You can hear a confirmation tone before making the voice announcement.
- More than one person cannot use the paging feature at the same time.
- You cannot page extensions which have set the DND or Paging — DENY feature, or which are in use.

Programming References

- System Programming — Installation Manual
 - [106] External Paging Access Tone
 - [600] Extension Group Assignment — (Used for “Paging — Group” only.)

Feature References

Do Not Disturb (DND)
Paging — ANSWER
Paging — DENY

Paging — All

Allows you to make a voice announcement to all extensions. Your message is announced over the built-in speakers of proprietary telephones (PT) and the external pager.

Any Telephone

Lift the handset or press SP-PHONE/MONITOR.

Dial 33*.

Confirmation tone

Announce.

Wait for an answer.

Talk.

<PT Display Example>

Paging All

- You may dial “339” instead of “33*”.

Paging — External

Allows you to make a voice announcement over the external pager.

Any Telephone

Lift the handset or press SP-PHONE/MONITOR.

Dial 34.

Confirmation tone (optional)

Announce.

Wait for an answer.

Talk.

<PT Display Example>

External Page

Conditions

- If the pager is in use, a busy tone will be heard.
- When the program [106] is set to “DISABLE”, the confirmation tone is not sent to the external pager.

3.2 Telephone Features

P

Paging — Group

Allows you to select an extension group and make a voice announcement. You can select all extension groups simultaneously. The announcement can only be heard through the extensions' built-in speakers.

To access all groups simultaneously

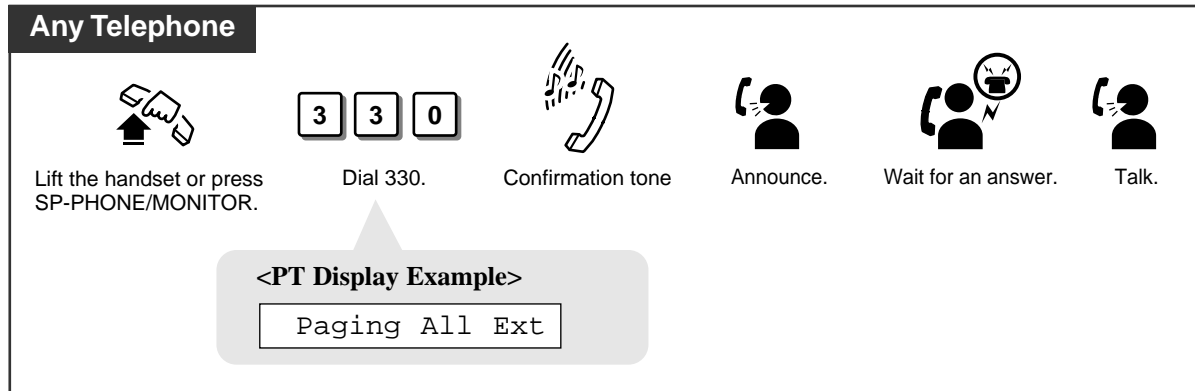

To access a particular group of extensions

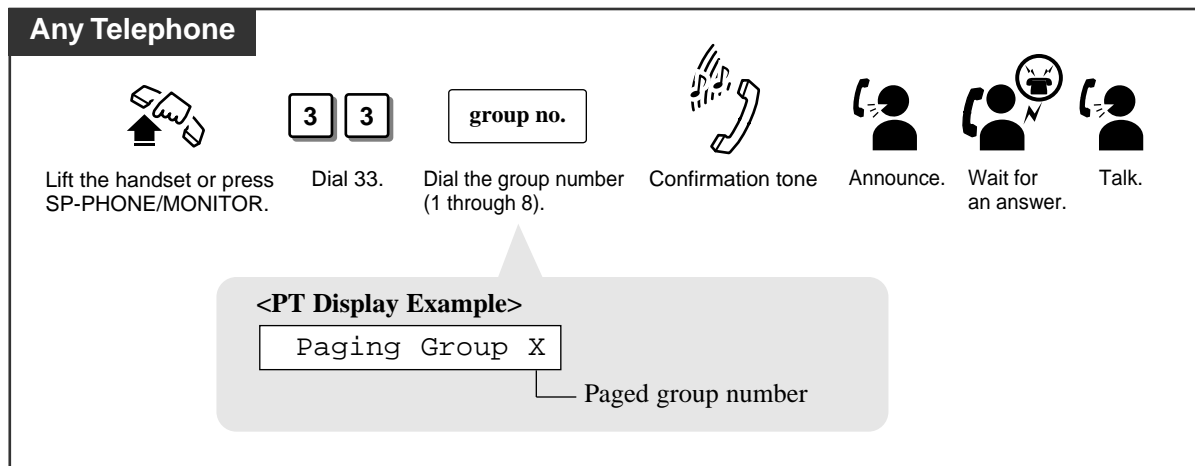





Condition

- There is a maximum of eight extension groups.

Paging — ANSWER

Allows you to answer an announced page at any extension within the system.

Any Telephone

 Lift the handset or press SP-PHONE/MONITOR.	 Dial 43.	 Confirmation tone	 Talk.
---	---	---	--

Conditions

- You can hear a confirmation tone when the page is answered.
- PT • If an outside call has been paged and transferred, you can answer the call by pressing the corresponding CO button whose indicator is flashing slowly.

Paging and Transfer

You can transfer a call using the paging feature (Paging — All, Paging — External, or Paging — Group).

Using Paging — All

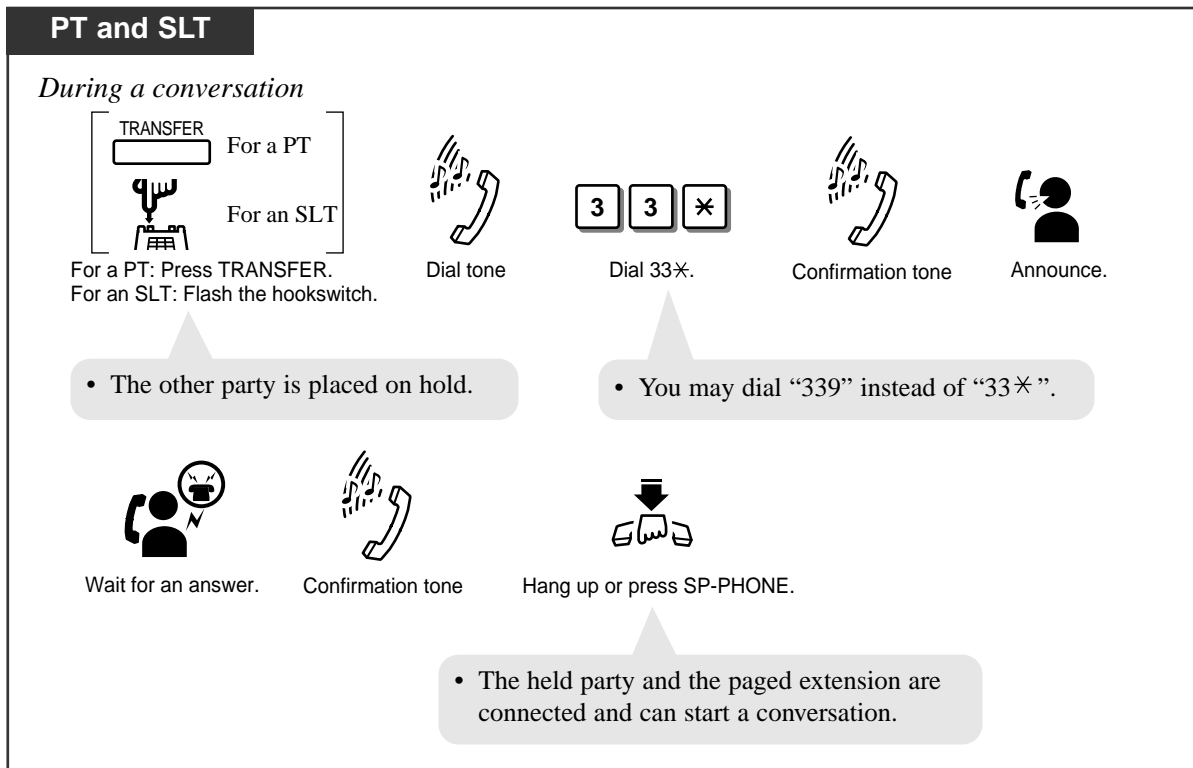

Using Paging — External: to an external pager

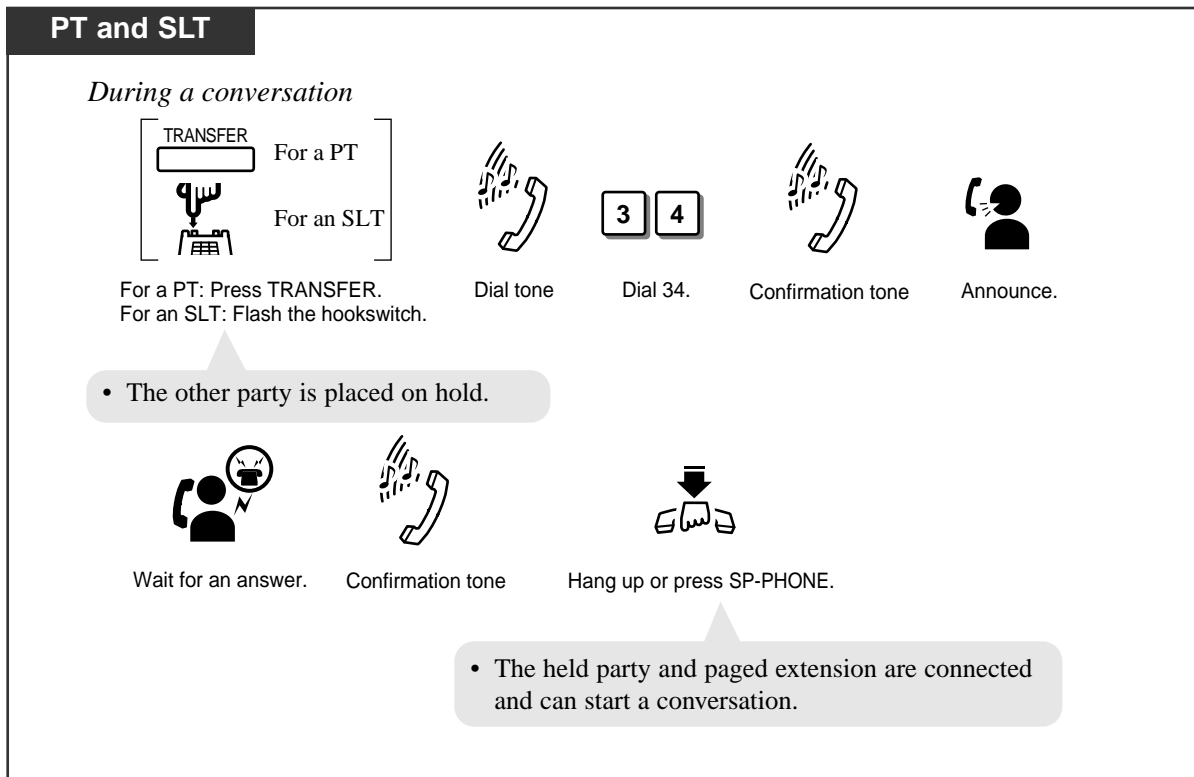

Using Paging — Group: to all extension groups

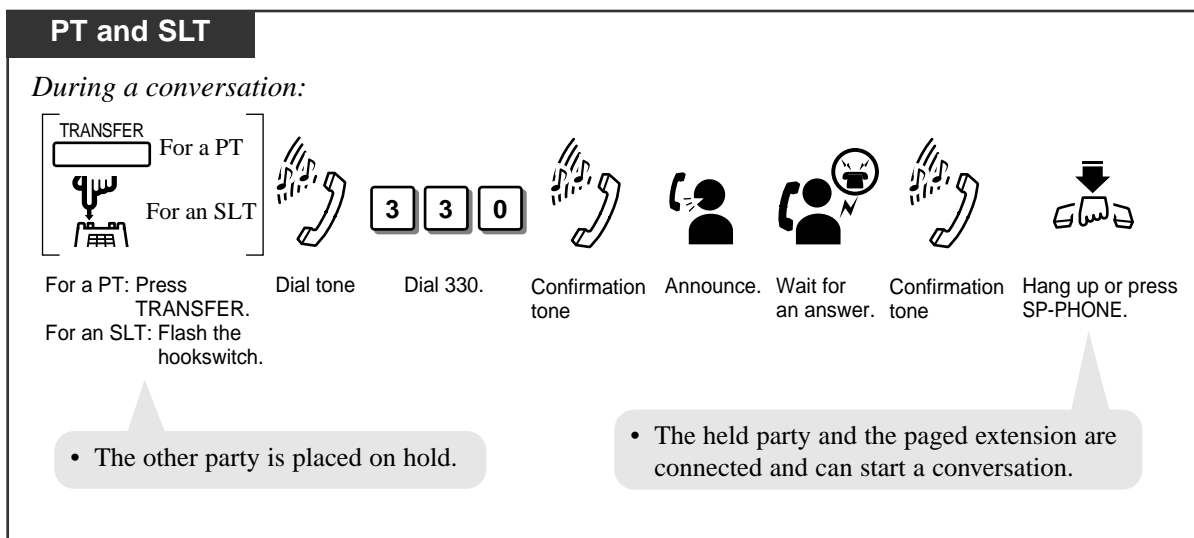

3.2 Telephone Features

P

Using Paging — Group: to a particular extension group

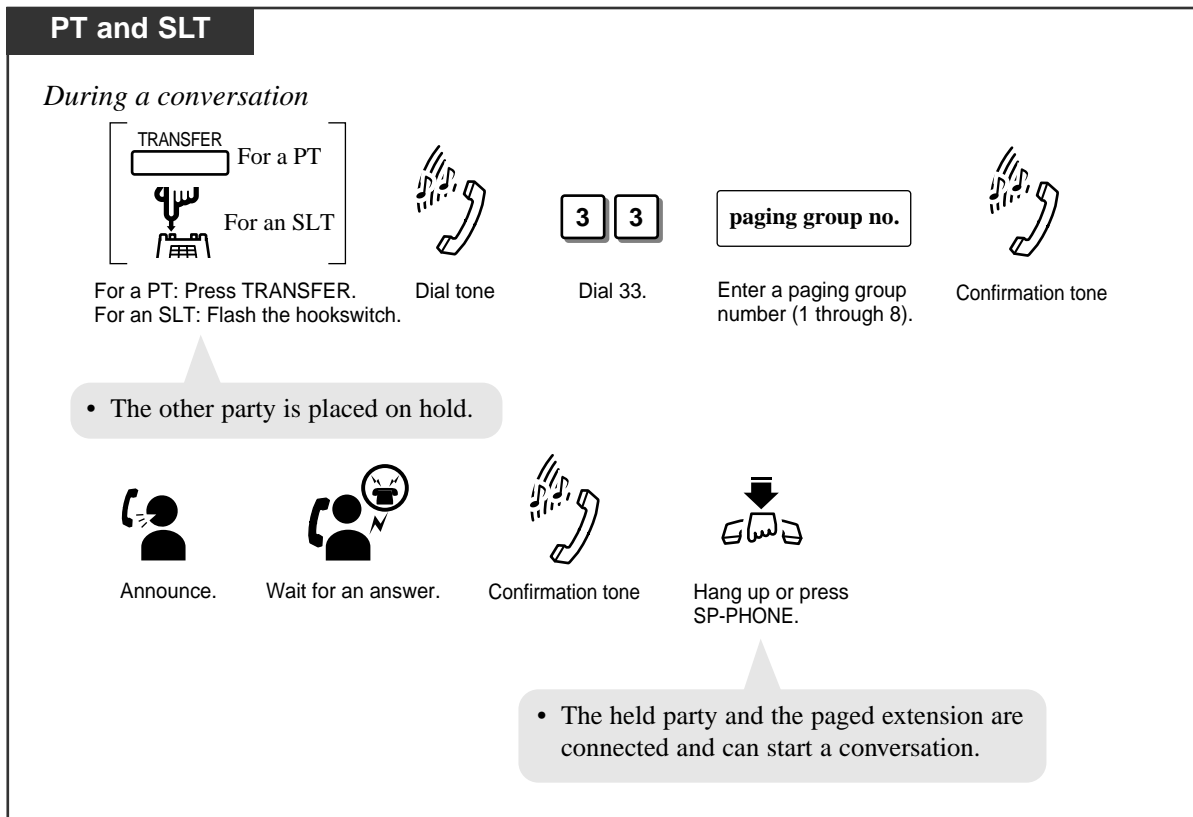

Condition

- SLT** • If “Hold-3” is assigned in System Programming, you must dial “20” after flashing the hookswitch.

Programming References

- System Programming — Installation Manual
 - [104] Hold Mode Selection
 - [600] Extension Group Assignment

Paging — DENY

A page sent to a built-in speaker can be denied by any extension in the system.

Setting

The diagram shows a sequence of steps for setting 'Paging Deny'. It starts with a handset icon and an upward arrow, with the instruction 'Lift the handset or press SP-PHONE/MONITOR.' Below this is a row of five boxes containing the digits '7', '3', '4', '1', and '#'. The instruction 'Dial 7341#' is centered below these boxes. To the right is a handset icon with a downward arrow, with the instruction 'Hang up or press SP-PHONE/MONITOR.' Below this is a callout box titled '<PT Display Example>' containing a rectangular box with the text 'Paging Deny'.

Canceling

The diagram shows a sequence of steps for canceling 'Paging Deny'. It starts with a handset icon and an upward arrow, with the instruction 'Lift the handset or press SP-PHONE/MONITOR.' Below this is a row of five boxes containing the digits '7', '3', '4', '0', and '#'. The instruction 'Dial 7340#' is centered below these boxes. To the right is a handset icon with a downward arrow, with the instruction 'Hang up or press SP-PHONE/MONITOR.' Below this is a callout box titled '<PT Display Example>' containing a rectangular box with the text 'Paging Allow'.

Paralleled Telephone Connection

Any extension can be connected in parallel with a proprietary telephone and a single line telephone. In the event of a power failure, CO1 and CO4 can be accessed using the single line telephones that are connected in parallel with the proprietary telephones to jack numbers 01 and 09 respectively. If the extension receives a call, ringing will be heard from the proprietary telephone and the single line telephone. You can answer the call by using either the proprietary telephone or the single line telephone. An answering machine, facsimile, MODEM (personal computer), etc., can be connected instead of a single line telephone.

System Programming is required to enable this feature.

Conditions

- PT • A proprietary telephone LCD will show you a single line telephone is in use.
- SLT • The following features will not work with a single line telephone connected in parallel with a proprietary telephone.
 - Call Splitting
 - Caller ID Call Waiting
 - Conference
 - Door Opener while talking to the doorphone
 - External Feature Access
 - Pickup dialing
- SLT • A single line telephone connected in parallel with a proprietary telephone cannot make a call in the following cases.
 - The proprietary telephone is set to the BGM mode.
 - The proprietary telephone is receiving a page through the built-in speaker.
 - The proprietary telephone is set to the PROGRAM mode.
- SLT • A single line telephone connected in parallel with a proprietary telephone will not ring in the following cases.
 - The proprietary telephone is set to Hands-free Answerback.
 - The proprietary telephone is set to “Voice Call” in the Intercom Alert Assignment.
 - The proprietary telephone is receiving a call from a doorphone.

Programming Reference

- System Programming — Installation Manual
[610] Paralleled Telephone Connection

Personal Speed Dialing

Allows you to store up to ten speed dial numbers at your extension. These numbers are available for your extension only.

Storing a phone number

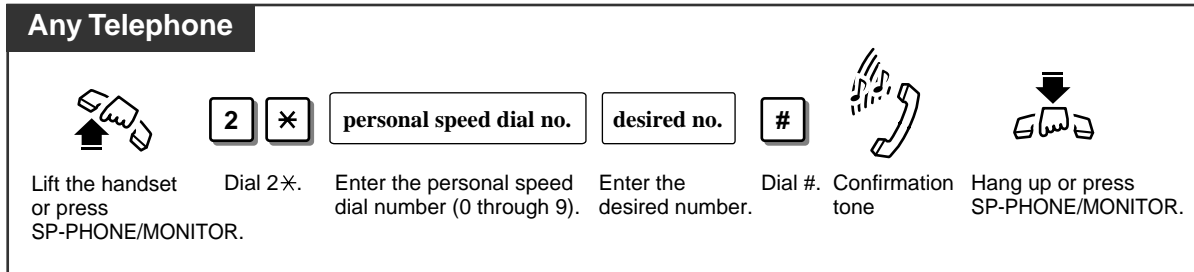

Dialing

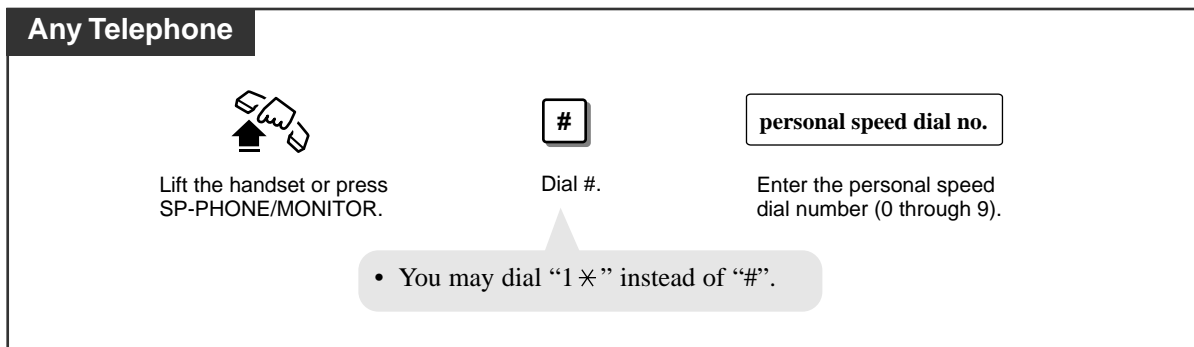

Checking the stored personal speed dialing numbers (with a display PT only)

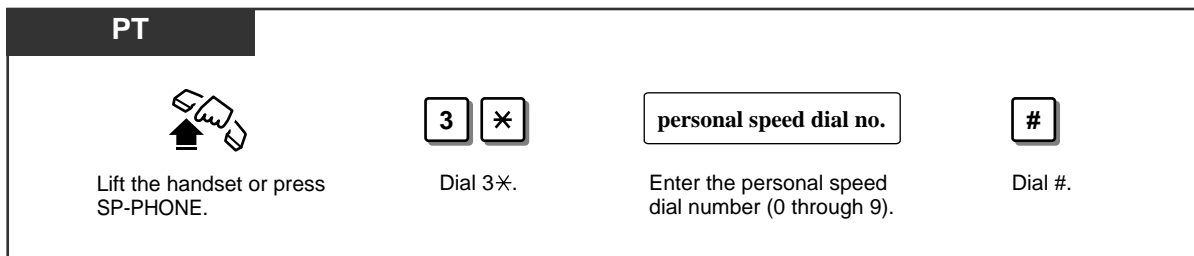

Conditions

- An account code must be stored by pressing “* *” and entering the account code after the line access code in the account code verify-all and forced modes.
- You can store an extension number, telephone number, or feature number of up to twenty-four digits. Valid digits are “0 through 9”.
- A pause can be stored by pressing the * key. However, in the account code verify-all, verify-toll and forced modes, “*” is not regarded as a pause.
- To store the telephone number of an external party, a line access code (9 or 81 through 86) must be stored as the first digit.
- PT • The number of Personal Speed Dialing numbers corresponds to the number of PF buttons assigned as One-Touch Dialing. (PF buttons are on a proprietary telephone.) You cannot assign both the One-Touch Dialing and Personal Speed Dialing features to the same number. For example, if you assign One-Touch Dialing to the PF 1 button and then Personal Speed Dialing 0, only the Personal Speed Dialing 0 feature will be assigned.
- SLT • A rotary telephone cannot use this feature.

Programming Reference

- Station Programming (Section 2)
Flexible Button Assignment — One-Touch Dialing Button

Pickup Dialing (Hot Line) (— Single Line Telephone only)

Allows you to make an outgoing call by just going off-hook.

Storing a phone number

SLT



Lift the handset or press SP-PHONE/MONITOR.

7

4

2

Dial 742.

phone no.

Enter the phone number.

#

Dial #.



Confirmation tone and dial tone



Hang up or press SP-PHONE/MONITOR.

- You must dial a line access code (9 or 81 through 86) as the first digit when storing an external party phone number.

Setting / Canceling

SLT



Lift the handset or press SP-PHONE/MONITOR.

7

4

1

#

To set.

7

4

0

#

To cancel.

To set: Dial 741#.
To cancel: Dial 740#.



Confirmation tone and dial tone



Hang up or press SP-PHONE/MONITOR.

Dialing

SLT



Lift the handset or press SP-PHONE/MONITOR.



Wait for an answer.



Talk.

Conditions

- This feature will not work if you answer an incoming call or retrieve a call on hold.
- Up to thirty-two digits, consisting of “0 through 9” and “*”, can be stored. The “*” button is used as a PAUSE. However, in the account code verify-all, verify-toll and forced modes, “*” is not regarded as a pause.
- An account code must be stored by pressing “* *” and entering the account code after the line access code in the account code verify-all and forced modes.
- During the waiting time after going off-hook, you can call another party and override this feature. You can change the waiting time between going off-hook and connecting with a called line by System Programming.
- A rotary telephone cannot use this feature.

Programming Reference

- System Programming — Installation Manual
[203] Pickup Dial Delay Time

Power Failure Transfer

During a power failure, each of the following outside (CO) lines will be connected to an assigned extension.

Outside (CO) line 1: jack number 01

Outside (CO) line 4: jack number 09

Conditions

- During a power failure, all features cannot be used except for incoming and outgoing outside calls from jack numbers 01 and 09.
- If jack numbers 01 and 09 are connected to proprietary telephones, disconnect the units and connect single line telephones.

Pulse to Tone Conversion

Allows you to change the dialing mode from Pulse to Tone to access services that require tones, such as computer telephone services and Voice Mail.

Any Telephone		
phone no. (Pulse mode)	* #	desired no. (Tone mode)
Enter the phone number (Pulse mode).	Dial *#.	Enter the desired number (Tone mode).

Condition

- You cannot change from Tone to Pulse dialing mode.

Redial, Last Number

Automatically saves the last outside phone number dialed so that you can make a call to the same party later using a simple operation.

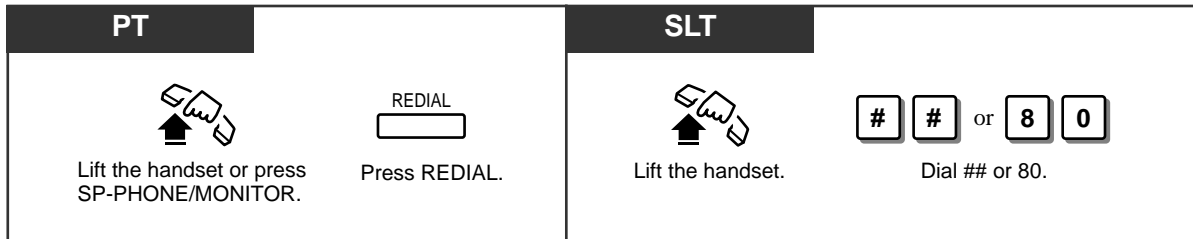

Conditions

- Up to sixty-four digits can be stored and redialed. This does not include an outside (CO) line access code.
- If you hear a busy tone when attempting to redial, select another line and press the REDIAL button or feature number.
- The stored number will be replaced even if only one digit is dialed the next time an outside call is made. Dialing an outside (CO) line access code will not affect the stored number.
- PT • “*”, “#”, “PAUSE”, and “INTERCOM” (for secret dialing) are counted as one digit.
- PT • While calling or during a conversation, pressing the REDIAL button will disconnect the current call and redial the stored number in 3 seconds.
- PT • You can check the stored number. Press the REDIAL button while on-hook, and the stored number will be displayed.

Redial, Saved Number

Allows you to save the current external telephone number during a conversation, so that you can redial the same party later using a simple operation. The saved number can be redialed until another number is stored.

Storing

PT

During a conversation or while hearing a busy tone



Press AUTO DIAL/STORE.



Press SAVE.

Dialing

PT



Lift the handset or press
SP-PHONE/MONITOR.



Press SAVE.

Conditions

- PT • Up to sixty-four digits can be stored and redialed. This does not include an outside (CO) line access code.
- PT • “*”, “#”, “PAUSE”, and “INTERCOM” (for secret dialing) are counted as one digit.
- PT • A flexible button can be assigned as the SAVE button.
- PT • You can check the stored number. Press the SAVE button while on-hook, and the stored number will be displayed.
- PT • You can change the outside (CO) line when dialing. You may press a CO button to select an outside (CO) line directly after going off-hook before pressing the SAVE button.

Programming Reference

- Station Programming (Section 2)
Flexible Button Assignment — SAVE Button

Room Monitor

Allows you to monitor a room through a proprietary telephone with an AUTO ANSWER/MUTE button. The proprietary telephone you want to monitor should be prepared for monitoring beforehand. You can also monitor through a doorphone. You can use a proprietary telephone with an AUTO ANSWER/MUTE button and single line telephone with a MUTE button for monitoring.

Setting a monitored PT

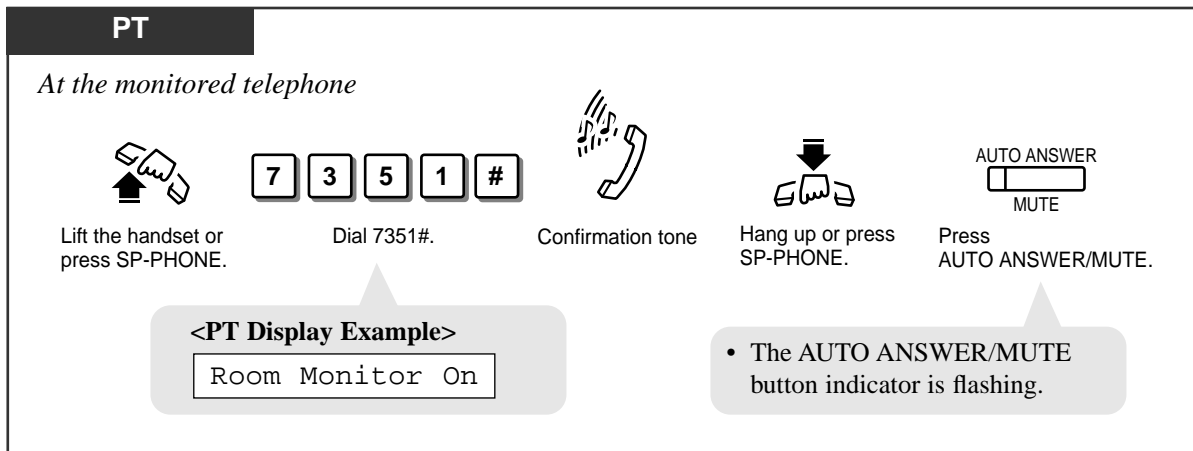

Monitoring

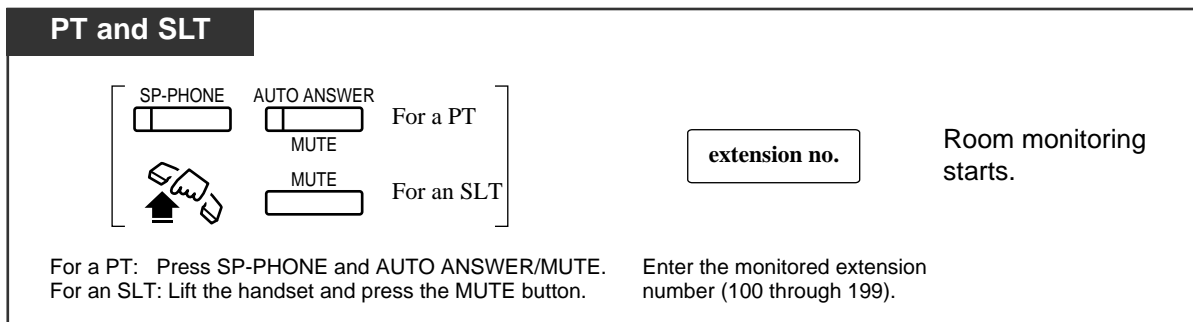

Talking with a person in the monitored room

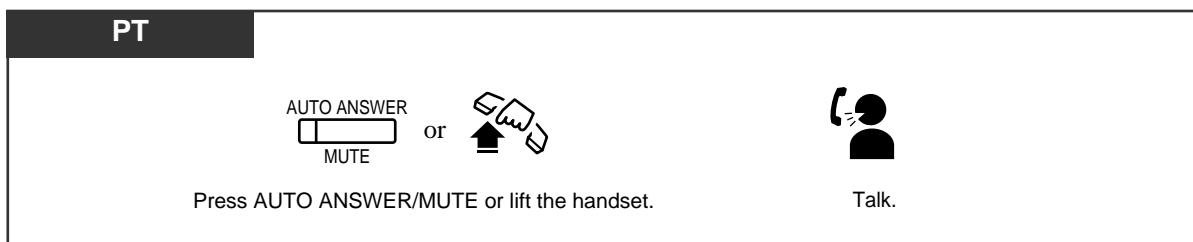

Canceling a monitor temporarily

PT

At the monitored telephone

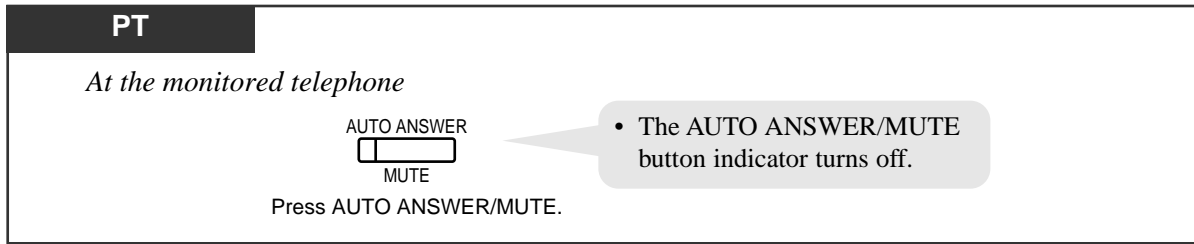

AUTO ANSWER

MUTE

Press AUTO ANSWER/MUTE.

- The AUTO ANSWER/MUTE button indicator turns off.

Canceling

PT

At the monitored telephone

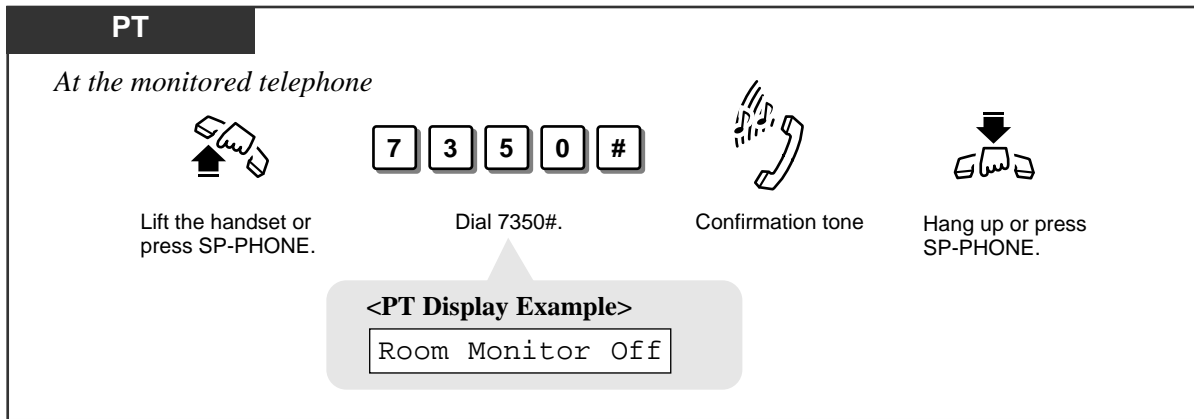

Lift the handset or press SP-PHONE.

Dial 7350#.

Confirmation tone

Hang up or press SP-PHONE.

<PT Display Example>
Room Monitor Off

Monitoring through a doorphone

PT and SLT

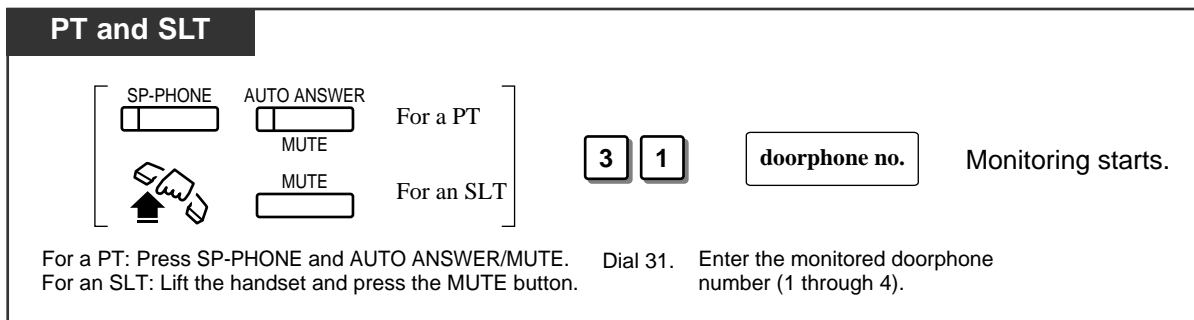

For a PT: Press SP-PHONE and AUTO ANSWER/MUTE.

For an SLT: Lift the handset and press the MUTE button.

Dial 31. Enter the monitored doorphone number (1 through 4).

Monitoring starts.

Conditions

- The doorphone access tone can be disabled by System Programming.
- PT** The access tone will not be sent to the monitored PT. The paging access tone will also not be sent to the monitored PT.
- PT** System Programming is required to monitor through a PT.
- PT** This feature is not available for the KX-T7050 and KX-T7055.

Programming References

- System Programming — Installation Manual
 - [612] Room Monitor Assignment
 - [707] Doorphone Access Tone Selection

Secret Dialing

Allows you to conceal all or part(s) of a “System Speed Dialing” or “One-Touch Dialing” number assigned to a flexible button which normally appears on the display.

PT

When storing the phone number

INTERCOM

Press INTERCOM before and after the part you wish to conceal.

<PT Display Example>

— “201” is not shown on the display when you dial.

Conditions

- PT** • A secret code, “[” or “]” (pressing the INTERCOM button), are counted as one digit.
- PT** • You can conceal one or more parts of a telephone number.
- PT** • If the phone number “9-1-[201]-431-2111” has been stored, the display will show the following when the call is made.

-1-. . . -431-2111
- PT** • You can program whether to print out the concealed number(s) on the SMDR or not by System Programming.
- PT** • Do not press the INTERCOM button before a line access number (9 or 81 through 86).

Programming References

- Station Programming (Section 2)
 - Flexible Button Assignment — One-Touch Dialing Button
- System Programming — Installation Manual
 - [001] System Speed Dialing Entry
 - [803] Secret Speed Dialing/One-Touch Dialing Printing

Feature References

One-Touch Dialing
System Speed Dialing

Station Feature Clear

Allows you to reset the following station features to the default settings.

- a) Absent Message Capability
- b) Automatic Callback Busy (Camp-On)
- c) Background Music (BGM)
- d) Call Forwarding
- e) Call Log, Incoming
- f) Call Pickup Deny
- g) Call Waiting
- h) Data Line Security
- i) Do Not Disturb (DND)
- j) Executive Busy Override Deny
- k) Log-In/Log-Out
- l) Message Waiting – (All messages will be erased.)
- m) Paging — DENY
- n) Pickup Dialing (Hot Line) – (The stored telephone number will be erased.)
- o) Room Monitor
- p) Timed Reminder
- q) Voice Mail Integration

Clearing the current feature settings

Any Telephone



Lift the handset or press
SP-PHONE/MONITOR.



Dial 79#.



Confirmation tone
and dial tone



Hang up or press
SP-PHONE/MONITOR.

<PT Display Example>

Ext Data Clear

- Single line telephone users can dial “0” instead of “#”.

Switching to Tone Alert

“Voice Call” (through the built-in speaker) which is set at the called party’s extension can be switched to “Tone Call” (ringing). This feature must be set beforehand at the called party’s extension by Station Programming.

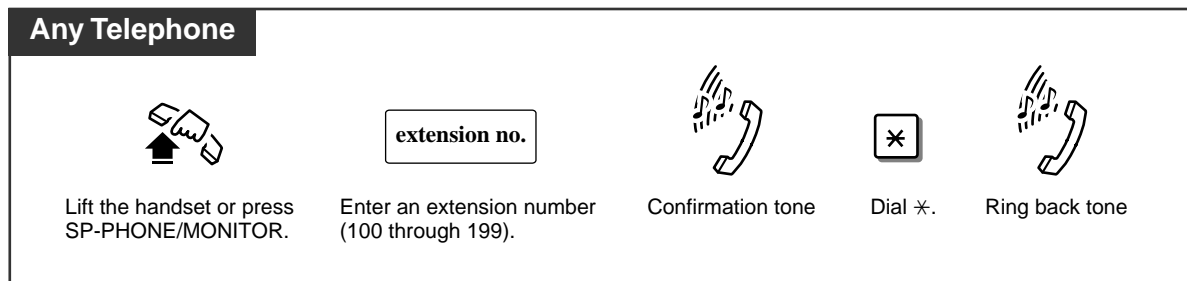

Conditions

- This feature is not available for rotary telephones.
- Switching from “Tone Call” to “Voice Call” is not available.

Programming Reference

- Station Programming (Section 2)
Intercom Alert Assignment

System Speed Dialing

Allows you to make a call using pre-programmed speed dial numbers. This system supports *one hundred* speed dial numbers which are available to all extension users.

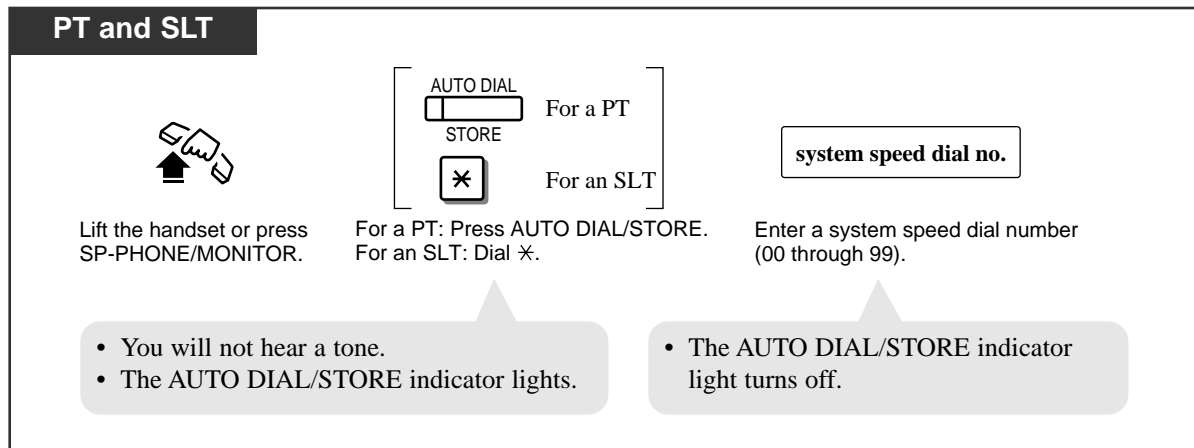

Conditions

- System Speed Dial numbers must be stored by System Programming.
- “Speed Dialing”, “One-Touch Dialing” and manual dialing can be used together.
- You may press a CO button or dial a line access code to select a desired outside (CO) line before pressing the AUTO DIAL/STORE button or dialing ✳.
- It is possible to change toll restriction COS number with this feature (Toll Restriction for System Speed Dialing). In this case, System Programming is necessary.

PT

- A System Speed Dial number can be divided when stored.

<Example>

If the number is divided and stored in System Speed Dial numbers 01 and 02,
press: [AUTO DIAL/STORE] [0] [1] [AUTO DIAL/STORE] [0] [2].

PT

- The dialed number appears on the display.

PT

- A rotary telephone cannot use this feature.

Programming References

- System Programming — Installation Manual
 - [001] System Speed Dialing Entry
 - [301] Toll Restriction — System Speed Dialing Boundary Class

Feature Reference

Toll Restriction for System Speed Dialing

3.2 Telephone Features

T

Time (Day/Night/Lunch) Service

This system supports the Day, Night and Lunch modes. The system operation for originating and receiving calls can be different in the day, night and lunch modes. “Time Service” can only be set by the operator and manager. For a PT user, even if your extension is not assigned as the operator or manager, you can use your display to check the current mode.

Confirming the current mode (with a display PT only)

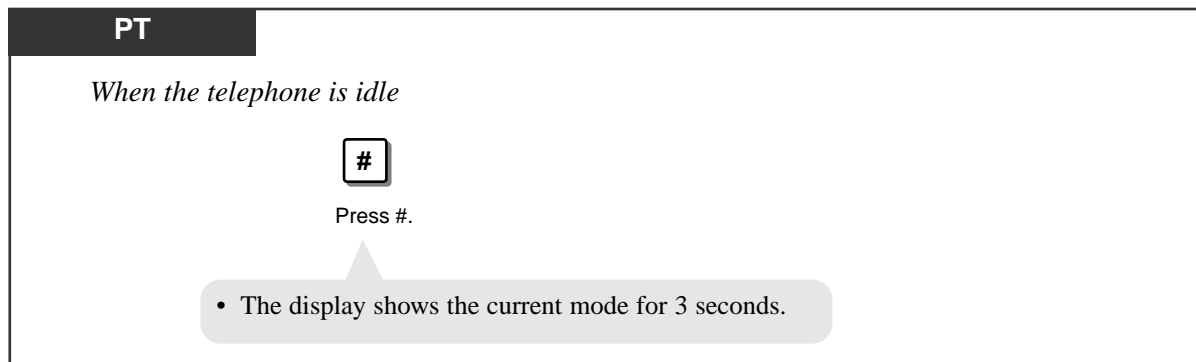

Condition

- The Day/Night/Lunch mode is automatically switched at a predetermined time (default: 9:00 a.m. for every day, 5:00 p.m. for every night), if the automatic mode is selected.

Programming References

- System Programming — Installation Manual
 - [006] Time (Day/Night/Lunch) Service Changing Mode
 - [007] Time (Day/Night/Lunch) Service Start Time

Feature References

Time (Day/Night/Lunch) Service Setting (3.3 Operator/Manager Service Features)
Time (Day/Night/Lunch) Service (→ See the Installation Manual.)

Timed Reminder

You can receive a ringback at your telephone to remind you of a meeting or appointment. Either one time or daily (everyday until canceled) is available at a pre-set time.

Setting

Any Telephone



Lift the handset or press SP-PHONE/MONITOR.

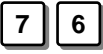

Dial 76.



Enter the hour (01 through 12).



Enter the minute (00 through 59).

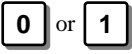

For AM: Dial 0.
For PM: Dial 1.

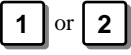

For a one time alarm*¹: Dial 1.
For a daily alarm*²: Dial 2.



Dial #.



Hang up or press SP-PHONE/MONITOR.

- Single line telephone users can dial "0" instead of "#".

*¹ An alarm will be heard at the preset time and then the setting is cleared.
*² An alarm will be heard daily at the preset time until the setting is changed or canceled.

Canceling

Any Telephone



Lift the handset or press SP-PHONE/MONITOR.

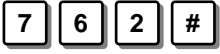

Dial 762#.



Confirmation tone and dial tone



Hang up or press SP-PHONE/MONITOR.

<PT Display Example>

Alarm Cancel

- Single line telephone users can dial "0" instead of "#".

3.2 Telephone Features

T

Checking the set time (with a display PT only)

PT

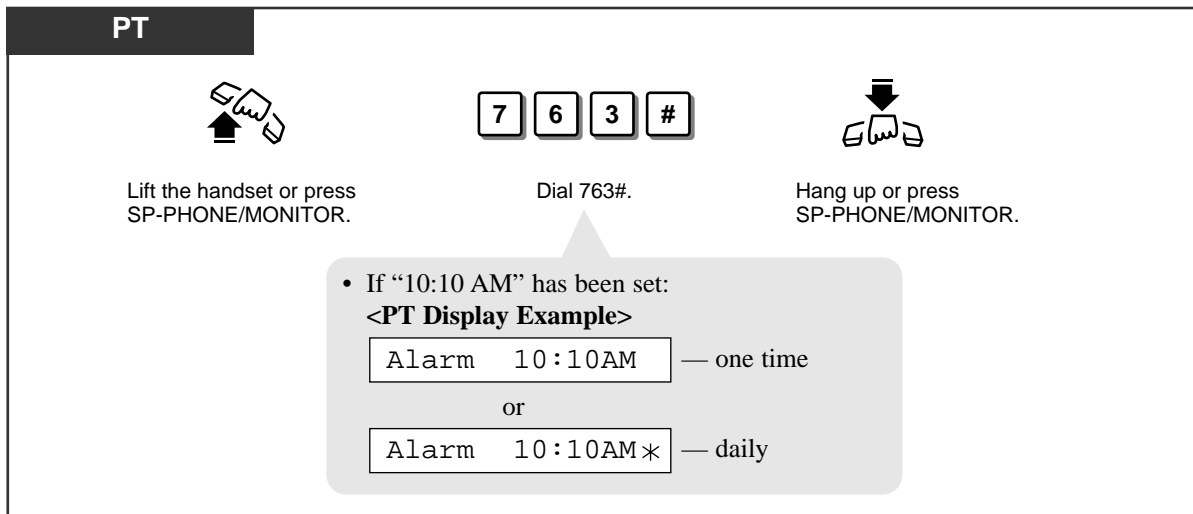

Lift the handset or press SP-PHONE/MONITOR.

Dial 763#.

Hang up or press SP-PHONE/MONITOR.

- If “10:10 AM” has been set:
<PT Display Example>
Alarm 10:10AM — one time
or
Alarm 10:10AM* — daily

Stopping the alarm

Any Telephone

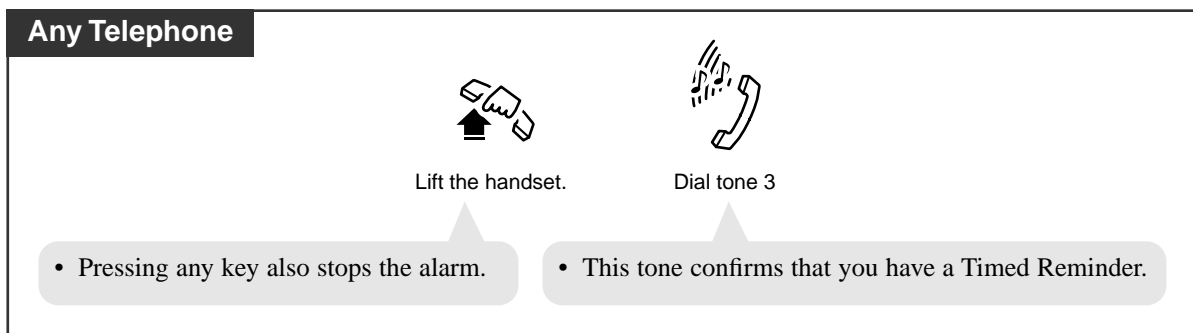

Lift the handset.

Dial tone 3

- Pressing any key also stops the alarm.
- This tone confirms that you have a Timed Reminder.

Conditions

- Be sure the system clock is set correctly.
- The alarm continues for thirty seconds.
- If you receive an incoming call during the alarm, ringing starts after the alarm stops.
- If the alarm is set to sound during a conversation, the alarm will start after the conversation.
- If the operator, manager or you set a new time, the preset time will be cleared.
- If an alarm time has not been set, the display will show the following.

PT

Alarm Not Stored

Programming Reference

- System Programming — Installation Manual
[000] Date and Time Setting

Feature Reference

Timed Reminder, Remote (Wake-Up Call) (3.3 Operator/Manage Service Features)

Toll Restriction Override

There are three types of toll restriction override.

- **Toll Restriction Override by Account Codes**
- **Toll Restriction for System Speed Dialing**
- **Toll Restriction — Station Lock Boundary Class**

Toll Restriction Override by Account Codes

Allows you to temporarily override toll restriction and make a toll call from a toll-restricted telephone assigned to the verify-toll mode. You can carry out this feature by entering a pre-assigned account code before dialing the telephone number. For the operation procedure, refer to “Account Code Entry”.

Conditions

- This feature changes the toll restriction COS number as follows.
 - When an account code is entered, the COS number is changed to the COS number 2. The COS numbers 1 and 2 will not be changed.
- If you do not enter an account code or enter an invalid one, a regular toll restriction check is done.
- You can enter an account code only when you need to override toll restriction.
- To override toll restriction in the option, forced or verify-all mode, use the Walking COS feature.

Programming References

- System Programming — Installation Manual
 - [310] Account Codes
 - [601]–[603] TRS – Class of Service (COS) Assignment — Day/Night/Lunch
 - [605] Account Code Entry Mode

Feature References

Account Code Entry
Toll Restriction (→ See the Installation Manual.)
Walking COS

Toll Restriction for System Speed Dialing

Allows you to change the toll restriction in “System Speed Dialing”. Normally, calls originated by “System Speed Dialing” are restricted depending on the extension’s toll restriction COS number. Once this option is set, the COS number is changed to the one assigned in the program [301]. You can select the toll restriction COS number by System Programming.

Programming Reference

- System Programming — Installation Manual
[301] Toll Restriction — System Speed Dialing Boundary Class

Feature References

System Speed Dialing
Toll Restriction (→ See the Installation Manual.)

Toll Restriction — Station Lock Boundary Class

Allows assigning a toll restriction class when the Electronic Station Lockout or Remote Station Lock feature is set.

You usually cannot make an outside call at a locked extension, however if a toll restriction class is assigned in program [312], you can make an outside call at the locked extension.

Conditions

- The higher toll restriction COS number will take precedence.
For example, if toll restriction COS number 4 is assigned to an extension and the station lock boundary class is 3, you are allowed to make a call with toll restriction COS 4.

Programming Reference

- System Programming — Installation Manual
[312] Toll Restriction — Station Lock Boundary Class

Feature References

Electronic Station Lockout
Remote Station Lock Control
Toll Restriction (→ See the Installation Manual.)

Two-Way Recording into Voice Mail †

Allows you to record a conversation into your mailbox or a specified mailbox.

Recording into your mailbox

PT

During a conversation



Press the Flexible button assigned as the Two-Way Record button.

- The Two-Way Record indicator light turns red.

Stopping Recording

PT



Press the Flexible button assigned as the Two-Way Record button.

- The Two-Way Record indicator light turns off.

Recording into another mailbox

PT

During a conversation



Press the Flexible button assigned as the Two-Way Transfer button.

OR 

Enter an extension number or press the desired DSS.

- The Two-Way Transfer indicator light turns red.

Stopping Recording

PT



Press the Flexible button assigned as the Two-Way Transfer button.

- The Two-Way Transfer indicator light turns off.

† Available when the KX-TA624 is connected to a Proprietary Telephone capable Panasonic Voice Processing System (one that supports APT Integration; KX-TVS50/KX-TVS80).

3.2 Telephone Features

T

Conditions

- PT • A flexible CO or DSS button can be assigned as the Two-Way Record button or the Two-Way Transfer button.
- PT • Pressing the Two-Way Record button sends an alarm tone, if an idle voice mail port is not available.
- PT • Pressing the Two-Way Transfer button followed by an extension number sends an alarm tone, if an idle voice mail port is not available.

Programming Reference

- Station Programming (Section 2)
Flexible Button Assignment — Two-Way Record Button, Two-Way Transfer Button

Feature References

- Station Programming — Two-Way Record Button Assignment
Two-Way Transfer Button Assignment
(4.2 DSS Console Features)

Voice Mail Integration for KX-TVS50/KX-TVS75/ KX-TVS80/KX-TVS100/KX-TVS110

Allows you to forward your calls to your mailbox in a Panasonic Voice Processing System (VPS) equipment (KX-TVS50/KX-TVS75/KX-TVS80/KX-TVS100/KX-TVS110). A caller can leave a message in your mailbox. If you use a proprietary telephone which has a MESSAGE button, the button light will turn on to let you know you have messages. If you use a single line telephone, dial tone 3 will let you know you have messages when you go off-hook.

Setting Call Forwarding destination to Voice Mail

PT and SLT

Lift the handset or press SP-PHONE/MONITOR.

For a PT: Press FWD/DND.
For an SLT: Dial 71.

Dial the Call Forwarding number.
1: Call Forwarding — All Calls
2: Call Forwarding — Busy/No Answer

Enter the Voice Mail extension number.

Dial #.

Confirmation tone and dial tone

Hang up or press SP-PHONE/MONITOR.

- You may press the flexible button assigned as the FWD/DND button instead.
- Calls directed to you are automatically forwarded to your mailbox.
- Callers can leave their messages in the mailbox, according to the Voice Mail guidance.

Canceling Call Forwarding destination to Voice Mail

PT and SLT

Lift the handset or press SP-PHONE/MONITOR.

For a PT: Press FWD/DND.
For an SLT: Dial 71.

Dial 0.

Dial #.

Confirmation tone and dial tone

Hang up or press SP-PHONE/MONITOR.

- You may press the flexible button assigned as the FWD/DND button instead.

3.2 Telephone Features

Listening to a stored message

You can listen to the messages stored in your mailbox easily. There are two operations to play back messages.

Using the Message Waiting (MESSAGE) button

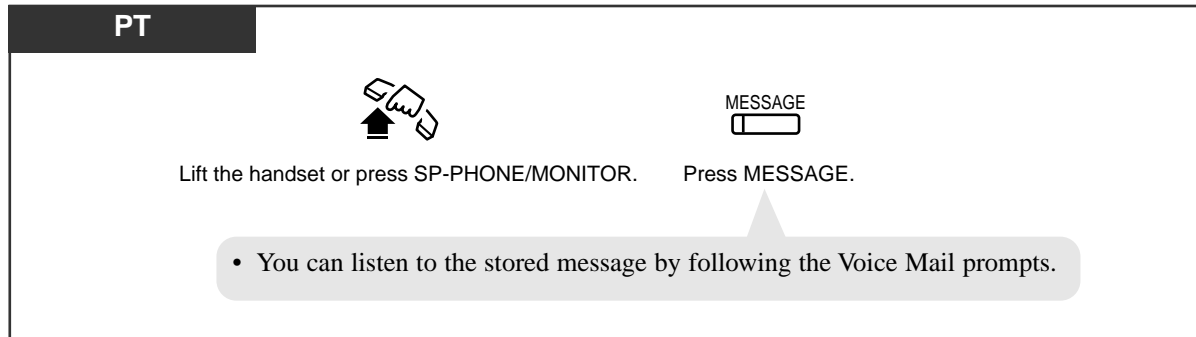

By manual dialing

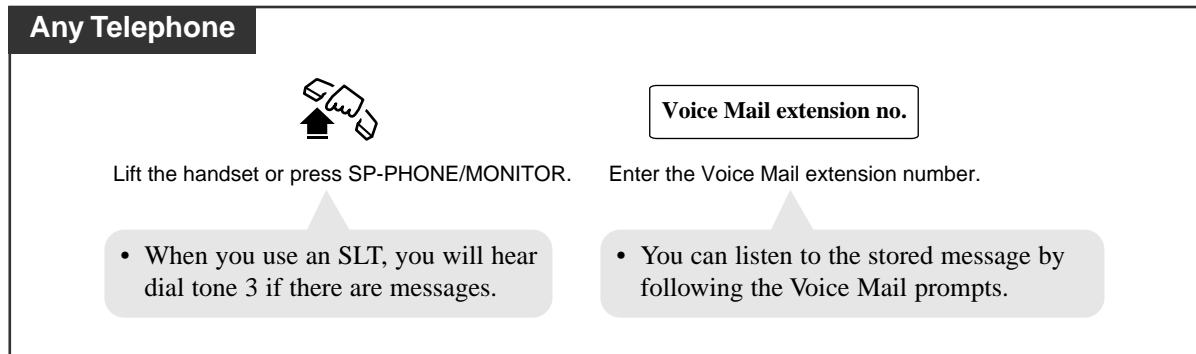

Conditions

- Voice Mail can be assigned as the destination for the following features.
 - a) Call Forwarding — All Calls
 - b) Call Forwarding — Busy/No Answer
 - c) Intercept Routing
- Outside callers can leave messages in your mailbox. When an incoming outside call is received, the operator answers the call and transfers it to your extension.
 - **If you set the “Call Forwarding” feature at the Voice Mail destination;**
The call will be forwarded to Voice Mail automatically.
 - **If you do not set the “Call Forwarding” feature;**
The call will return to the operator. Then the operator will transfer the call to Voice Mail.
- An incoming call via DISA is automatically transferred to Voice Mail when the destination extension is assigned to “Intercept” and a Voice Mail extension is assigned as the Intercept Routing destination.
- You can also transfer the received outside calls to specific mailboxes so that callers can leave messages.

- PT • A flexible button can be assigned as the FWD/DND button.
- PT • If you set the Call Forwarding — Busy/No Answer feature, the FWD/DND button light will keep flashing. To stop this flashing, go off-hook and dial 716#.
- SLT • You will hear dial tone 3 if there are messages in your mailbox when you go off-hook. When you access voice mail, you have to listen to all of the new messages. If you do not listen to all of the messages, dial tone 3 will be eliminated and you will not know there are messages left in your mailbox the next time you go off-hook.

Programming References

- Station Programming (Section 2)
 - Flexible Button Assignment — FWD/DND Button,
Return to Message Waiting (MESSAGE) Button

Feature References

- Call Forwarding — All Calls, Busy/No Answer
- Intercept Routing (→ See the Installation Manual.)

Voice Mail Transfer †

You can transfer outside calls to the Voice Processing System so that callers can leave their messages in a desired extension mailbox. When you transfer an outside call to the designated extension;

— **If the extension has set the “Call forwarding” function whose destination is Voice Mail;**

The call will be forwarded to Voice Mail.

— **If the extension has not set the “Call forwarding” function;**

The call will return to you. You can then transfer the call to Voice Mail by simply following the operation below.

PT

If the call returns to you

Press the Flexible button assigned as the Voice Mail (VM) Transfer button.

or
Enter an extension number or press DSS.

- The call will be transferred to Voice Mail.
- The caller can leave the message according to the Voice Mail guidance.

Conditions

- PT** • A flexible button can be assigned as the Voice Mail (VM) Transfer button.

Programming References

- Station Programming (Section 2)
Flexible Button Assignment — Voice Mail (VM) Transfer Button

Feature Reference

Voice Mail Integration for KX-TVS50/KX-TVS75/KX-TVS80/KX-TVS100/KX-TVS110
Station Programming — Voice Mail (VM) Transfer Button Assignment
(4.2 DSS Console Features)

† Available when the KX-TA624 is connected to a Proprietary Telephone capable Panasonic Voice Processing System (one that supports APT Integration; KX-TVS50/KX-TVS80).

Walking COS

Allows you to use your calling privileges (TRS — Class of Service) at another extension. You may override restrictions which may be set at the extension.

Making a call

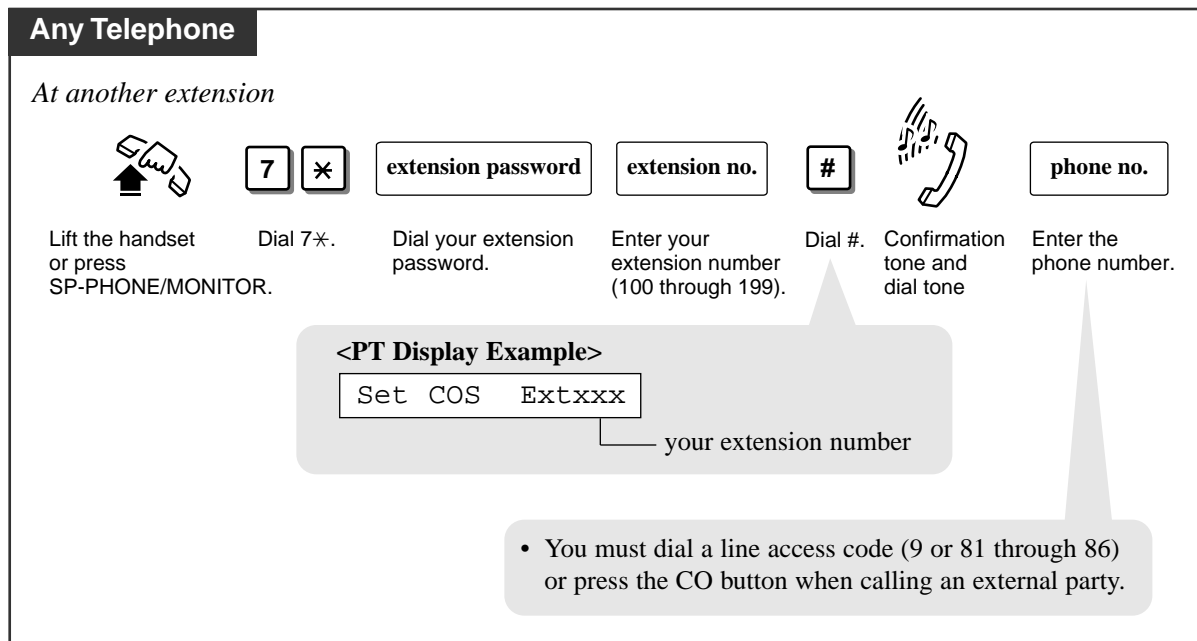

Conditions

- TRS Class of Service (COS) is used to define the feature. Each extension is assigned a TRS COS number.
- SLT • A rotary telephone cannot use this feature.

Programming References

- Operator/Manager Service Features
 Extension Password Set (Manager only)
- System Programming — Installation Manual
 [601]–[603] TRS – Class of Service (COS) Assignment — Day/Night/Lunch

Feature Reference

Toll Restriction Override

3.3

Operator/Manager Service Features

The system supports one operator and one manager. Any extension can be appointed as the operator and jack number 01 is appointed as the manager. System Programming is required to assign the operator. The manager can program a few System Program (see following “Manager Programming”) with their extension password. The operator and manager can perform the following features.

- 1) Call Log, Incoming in the Common Area — CLEAR ALL
- 2) Call Log Lock, Incoming in the Common Area
- 3) Date and Time Setting
- 4) Electronic Station Lockout — CANCEL ALL
- 5) Live Call Screening Password Control
- 6) Outgoing Message (OGM)
- 7) Remote Station Lock Control
- 8) The 301st Call Log, Incoming in the Common Area Treatment
- 9) Time (Day/Night/Lunch) Service Setting
- 10) Timed Reminder, Remote (Wake-Up Call)
- 11) Extension Password Set (Manager only)

Programming Reference

- System Programming — Installation Manual
[008] Operator Assignment

3.3

Operator/Manager Service Features

Manager Programming (Manager only)

The manager (jack number 01) can program the following System Programming with their extension password even when they do not know the system password for System Programming.

- [001] System Speed Dialing Entry
- [512] DISA Security Codes
- [530] DISA Security Codes Digit Selection

To enter the programming mode

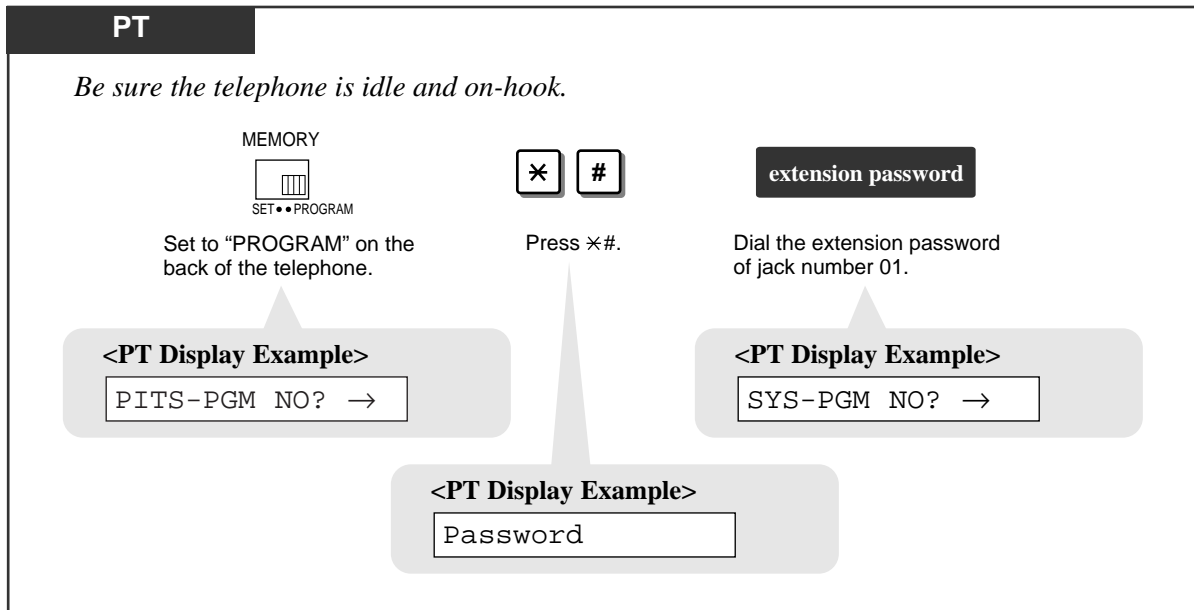

Programming sequence

After entering the programming mode

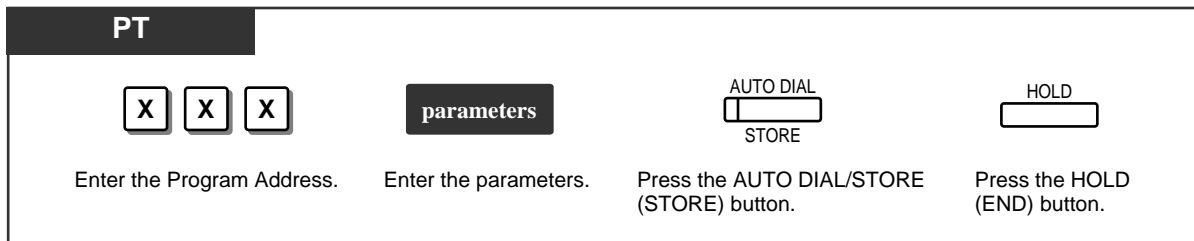

After pressing the STORE button, you will hear one of the following tones.

Confirmation tone (1 beep): This informs you that storing is completed. You can continue programming by entering the same or another program address

(2 beeps): This informs you that the parameter has already been stored.

Alarm tone (3 beeps): This informs you that the entry is invalid.

3.3 *Operator/Manager Service Features*

To exit the programming mode

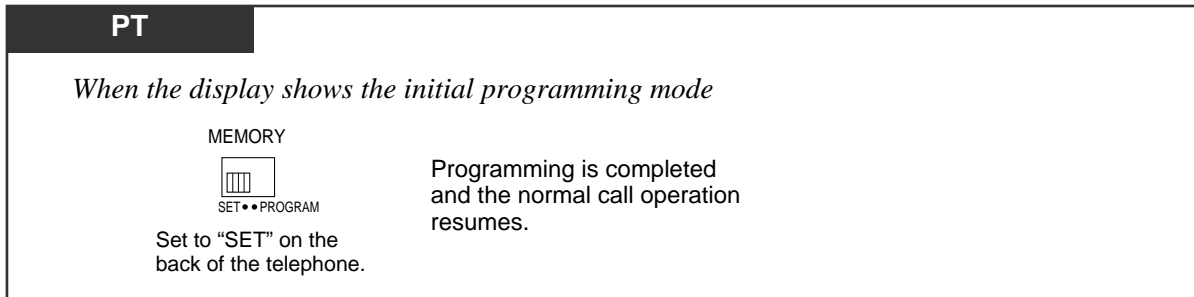

Conditions

- PT • During the programming mode, your extension is treated as a busy extension.
- PT • If you enter the wrong extension password, you will hear an alarm tone (3 beeps). Try again.

Programming References

- System Programming — Installation Manual
 - [001] System Speed Dialing Entry
 - [512] DISA Security Codes
 - [530] DISA Security Codes Digit Selection

Feature Reference

Extension Password Set (Manager only) (3.3 Operator/Manager Service Features)

3.3 Operator/Manager Service Features

Call Log, Incoming in the Common Area — CLEAR ALL

The operator or manager can clear all call information stored in the common area.

Setting

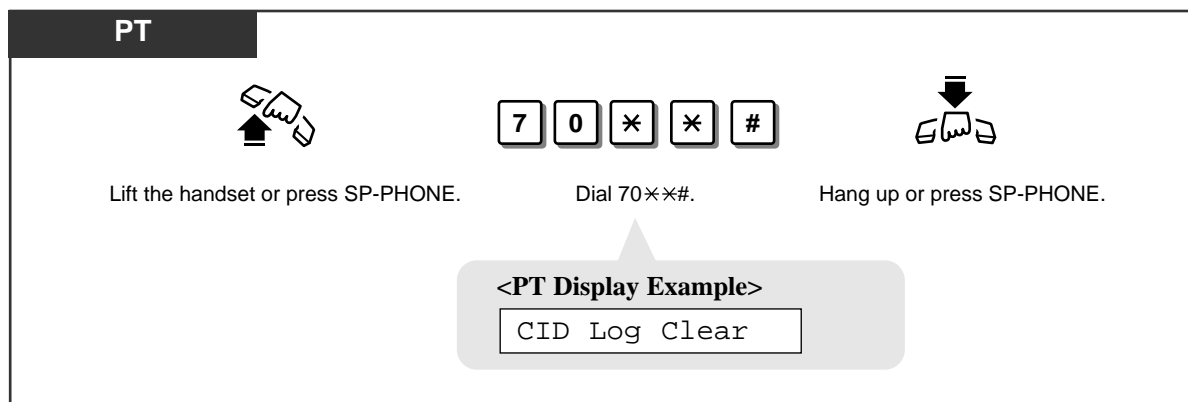

Conditions

- This operation is not available while someone is checking a call information stored in the common area.

3.3 Operator/Manager Service Features

Call Log Lock, Incoming in the Common Area

The operator or manager can lock the displays of extensions so that the “Call Log, Incoming” feature is not shown on the displays when the Caller ID Indication — Common button is pressed. It prevents others from seeing the information stored in the common area.

Locking

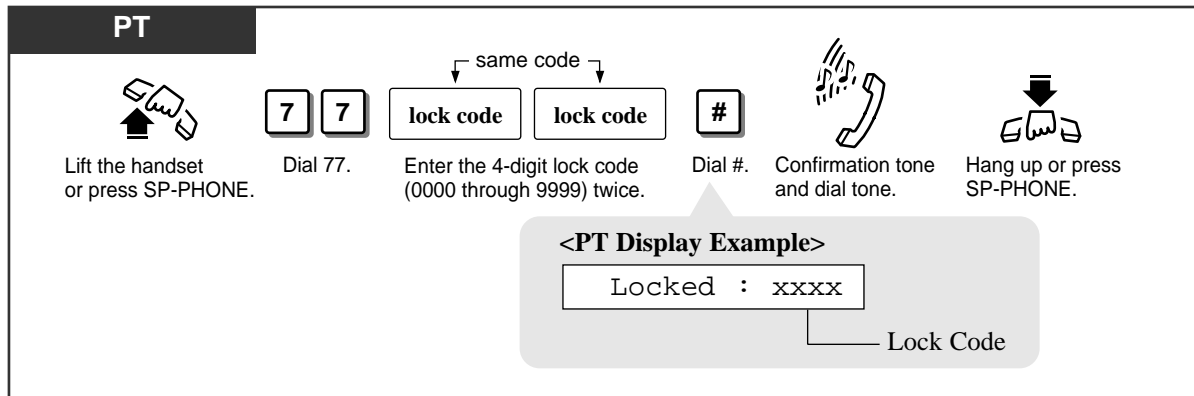

Unlocking

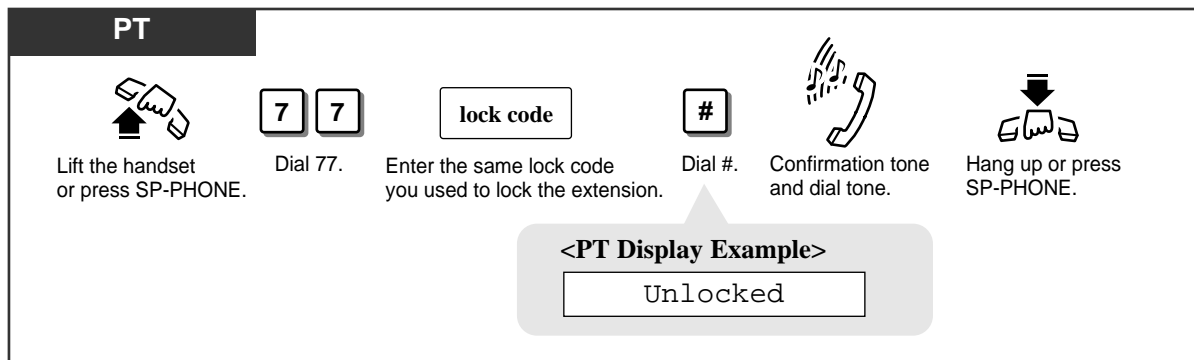

Feature References

- Call Log, Incoming
- Call Log Lock, Incoming in the Personal Area

3.3 Operator/Manager Service Features

Date and Time Setting

When the current time setting is wrong, you can adjust it by the following procedure.

Setting

— Be sure that you are in the Station Programming mode. Set the MEMORY switch to “PROGRAM”.

PT

0 Dial 0.	year Enter the year (last 2 digits).	month Enter the month (01 through 12).	day Enter the day (01 through 31).	day of the week Enter the day of the week. 0: For Sun 1: For Mon 2: For Tue 3: For Wed 4: For Thu 5: For Fri 6: For Sat
---------------------	--	--	--	---

<PT Display Example>
980715 6 07:52 1

hour Enter the hour (01 through 12).	minute Enter the minute (00 through 59).	0 or 1 Dial 0 or 1. For AM: Dial 0. For PM: Dial 1.	AUTO DIAL STORE Press AUTO DIAL/STORE.
--	--	--	--

- The STORE indicator light turns on.

— To exit the Station Programming mode, set the MEMORY switch to “SET”.

3.3 *Operator/Manager Service Features*

Electronic Station Lockout — CANCEL ALL

The operator or manager can cancel Electronic Station Lockout at all extensions.

Setting

— Be sure that you are in the Station Programming mode. Set the MEMORY switch to “PROGRAM”.

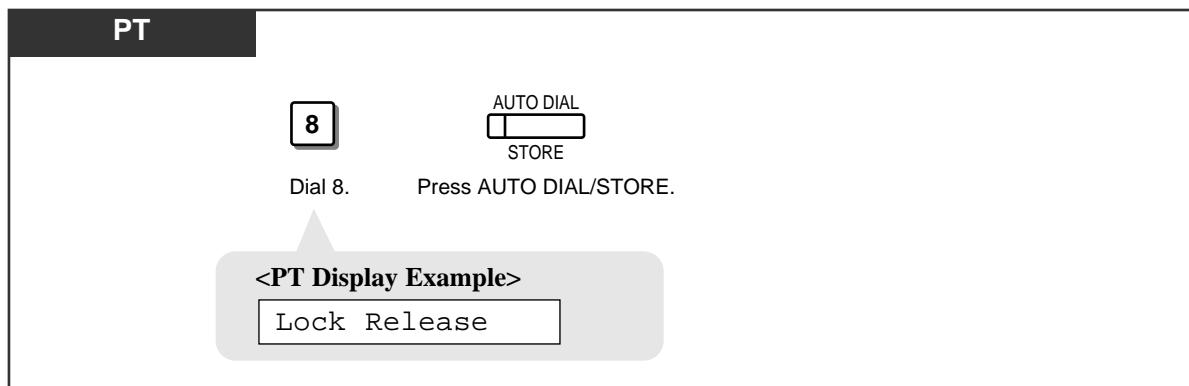

— To exit the Station Programming mode, set the MEMORY switch to “SET”.

Condition

- This feature also cancels Call Log Lock, Incoming in the Personal Area and Message Waiting for Another Extension Lock at all extensions.

Feature Reference

Call Log Lock, Incoming in the Personal Area
Electronic Station Lockout
Message Waiting for Another Extension Lock

3.3 Operator/Manager Service Features

Live Call Screening Password Control †

The operator or manager can clear the Live Call Screening password on any extension.

Clearing the Live Call Screening password

— Be sure that you are in the Station Programming mode. Set the MEMORY switch to “PROGRAM”.

The diagram illustrates the PT (Proprietary Telephone) display interface for clearing the Live Call Screening password. It shows a sequence of steps: 1. Pressing the '#' and '2' buttons, with the instruction 'Dial #2.'. 2. Entering the 'extension number' into the display, with the instruction 'Dial the extension number where you want to clear the password.'. 3. Pressing the 'STORE' button, with the instruction 'Press STORE.' and a note that 'The STORE indicator lights.'. A callout box titled '<PT Display Example>' shows the display showing '123:Cancel?' and includes a note: 'To erase an incorrect entry, press the TRANSFER (CLEAR) button. (The TRANSFER button becomes the CLEAR button during programming.)'

— To exit the Station Programming mode, set the MEMORY switch to “SET”.

Condition

- If the extension user forgets their pre-set password, they can ask the operator or manager to clear the password.

Feature Reference

Live Call Screening (LCS)

† Available when the KX-TA624 is connected to a Proprietary Telephone capable Panasonic Voice Processing System (one that supports APT Integration; KX-TVS50/KX-TVS80).

3.3 Operator/Manager Service Features

Outgoing Message (OGM)

The operator or manager can record or play back the outgoing message.

This is played when a caller accesses the DISA feature.

Two Outgoing Messages (OGM 1 and OGM 2) are available for DISA 1 and DISA 2.

Recording a message

— Be sure that you are in the Station Programming mode. Set the MEMORY switch to “PROGRAM”.

The diagram illustrates the steps for recording a message in PT mode. It includes icons for dialing numbers, lifting the handset, dialing OGM numbers, confirmation tones, and recording. A callout box shows a display example: 'Record 1&2:00' with a 'Time counter (seconds)' label. A list of notes explains the STORE indicator light and automatic recording.

PT

Dial 9. Lift the handset. Dial 0 for both OGM 1 and OGM 2. Dial 1 for OGM 1. Dial 2 for OGM 2. Confirmation tone. Record a message (up to 30 seconds).

AUTO DIAL STORE
Press AUTO DIAL/STORE. Confirmation tone

<PT Display Example>
Record 1&2:00
Time counter (seconds)

- The STORE indicator light turns off. Recording starts after the confirmation tone.

• The STORE indicator light turns steady red.
• If you exceed the time (30 seconds), recording is stopped automatically.

— To exit the Station Programming mode, set the MEMORY switch to “SET”.

3.3 *Operator/Manager Service Features*

Playing back a message

- Be sure that you are in the Station Programming mode. Set the MEMORY switch to “PROGRAM”.

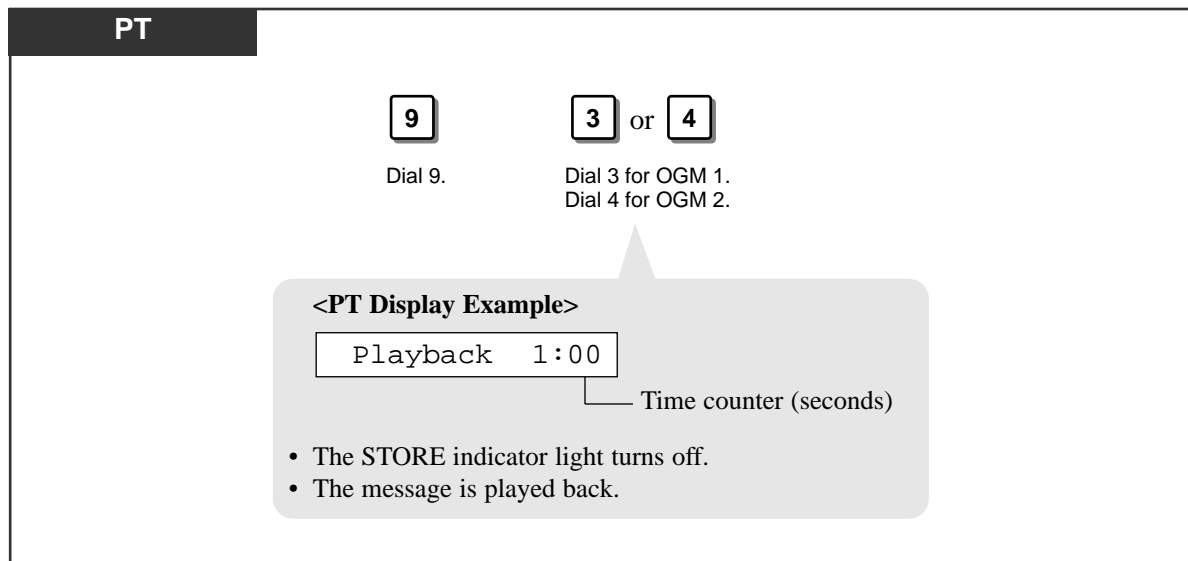

- To exit the Station Programming mode, set the MEMORY switch to “SET”.

Programming Reference

- System Programming — Installation Manual
[502] OGM Mode Selection

Feature Reference

Direct Inward System Access (DISA)

3.3 Operator/Manager Service Features

Remote Station Lock Control

The operator or manager can remotely lock or unlock a desired extension. You can lock outside calls.

Locking

PT



Lift the handset or press SP-PHONE/MONITOR.



Press the flexible button assigned as the Station Lock button.

<PT Display Example>

Locked	Ext101
--------	--------

- The Station Lock button indicator turns red.

Unlocking

PT



Lift the handset or press SP-PHONE/MONITOR.



Press the Station Lock button whose indicator lights red.

<PT Display Example>

Unlocked	Ext101
----------	--------

- The Station Lock button indicator turns off.

3.3 *Operator/Manager Service Features*

Conditions

- This feature overrides the “Electronic Station Lockout” feature. If “Electronic Station Lockout” has already been set by the extension user and this feature is set afterwards, the extension user cannot cancel the lock. Only the operator or manager can cancel the lock.
- Extension passwords must be assigned to the operator and manager extensions beforehand.
- The Electronic Station Lockout — CANCEL ALL feature can cancel this feature.
- An extension user can make a call at the locked extension depending on system programming. System programming determines which COS number applies to a call at the locked extension.

Programming Reference

- System Programming — Installation Manual
[312] Toll Restriction — Station Lock Boundary Class

Feature References

Electronic Station Lockout
Toll Restriction — Station Lock Boundary Class
Electronic Station Lockout — CANCEL ALL (3.3 Operator/Manager Service Features)
Station Programming — Station Lock Button Assignment (Operator and Manager only)
(4.2 DSS Console Features)

3.3 Operator/Manager Service Features

The 301st Call Log, Incoming in the Common Area Treatment

When the call log is full in the common area (300 calls are stored), you can select how the 301st call is treated. Either a new call can be disregarded or the new call can overwrite the oldest call that has been already confirmed (Default: Record the new call.).

Overwriting the call log in the common area

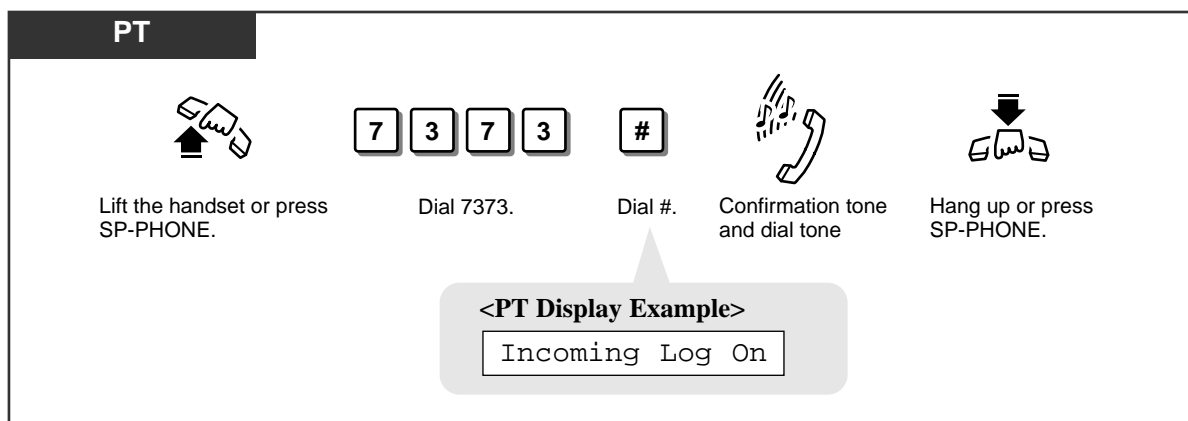

Disregarding the 301st call in the common area

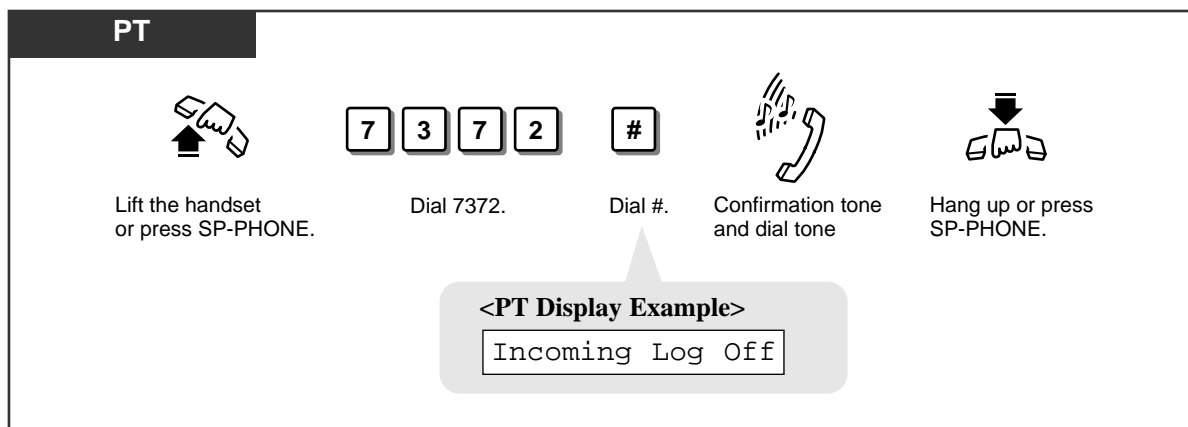

Conditions

- PT** • When “Disregarding the 301st call in the common area” has been set and 300 calls are logged or all of the old information has been overwritten, the Caller ID Selection — Common button indicator lights and informs you that no more calls can be logged.

Feature Reference

Call Log, Incoming

3.3

Operator/Manager Service Features

Time (Day/Night/Lunch) Service Setting

This system supports the Day, Night and Lunch modes. The system operation for originating and receiving calls can be different in the Day, Night and Lunch modes. Toll restriction can be programmed to prevent unauthorized toll calls for each mode.

Changing Day, Night or Lunch mode in manual or automatic mode

PT



Lift the handset or press SP-PHONE/MONITOR.

7	8	1	#	or	<input type="checkbox"/>	For Manual-Day mode
7	8	2	#	or	<input type="checkbox"/>	For Manual-Night mode
7	8	3	#	or	<input type="checkbox"/>	For Manual-Lunch mode

For manual-day mode: Dial 781# or press the DSS button assigned as the Day button.
For manual-night mode: Dial 782# or press the DSS button assigned as the Night button.
For manual-lunch mode: Dial 783# or press the DSS button assigned as the Lunch button.



Confirmation tone and dial tone



Hang up or press SP-PHONE/MONITOR.

- The display shows one of the following depending on whether the service is in the Day, Night or Lunch mode.
<PT Display Example>

or

or
- The assigned button indicator turns on.

Canceling the manual Day, Night or Lunch mode and returning to the automatic mode

PT



Lift the handset or press SP-PHONE/MONITOR.

7	8	0	#
---	---	---	---

Dial 780#.



Confirmation tone and dial tone



Hang up or press SP-PHONE/MONITOR.

Confirming the current mode (with a display PT only)

PT

When the telephone is idle



Press #.

- The display shows the current mode for 3 seconds.

3.3 *Operator/Manager Service Features*

Conditions

- The day/night/lunch mode can be changed either automatically at a predetermined time (default: 9:00 a.m. for every day, 5:00 p.m. for every night) or manually at any time by System Programming.
- Even if the automatic mode has been selected by System Programming, the operator or manager can change the day, night and lunch modes manually.
- The following programs have separate day, night and lunch programming.

1) Delayed Ringing Assignment	5) Flexible Ringing Assignment
2) Door Opener Assignment	6) Outside (CO) Line Mode
3) Doorphone Ringing Assignment	7) TRS – Class of Service (COS)
4) Flexible Outward Dialing Assignment	Assignment
- If the lunch mode is set using feature number 783# in the automatic mode, the mode will not be changed until the lunch mode is canceled using feature number 780#. The day and night modes are automatically changed at the programmed time even if feature number 780# is not entered.
- Feature number 780# is not accepted in the manual mode.
- One of the day, night or lunch button indicators on the DSS console lights red to display the current mode.
- If the day, night or lunch mode is changed manually in the automatic changing mode and the manager starts System Programming, the manual setting will be canceled after System Programming is completed. It will return to the automatic day, night or lunch mode.

Programming References

- System Programming — Installation Manual
 - [006] Time (Day/Night/Lunch) Service Changing Mode
 - [007] Time (Day/Night/Lunch) Service Start Time
 - [405]–[407] Flexible Outward Dialing Assignment — Day/Night/Lunch
 - [408]–[410] Flexible Ringing Assignment — Day/Night/Lunch
 - [411]–[413] Delayed Ringing Assignment — Day/Night/Lunch
 - [414]–[416] Outside (CO) Line Mode — Day/Night/Lunch
 - [601]–[603] TRS – Class of Service (COS) Assignment — Day/Night/Lunch
 - [700]–[702] Doorphone Ringing Assignment — Day/Night/Lunch
 - [703]–[705] Door Opener Assignment — Day/Night/Lunch

Feature References

- Direct In Lines (DIL) (→ See the Installation Manual.)
- Door Opener
- Doorphone Call
- Outside (CO) Line Connection Assignment — Outgoing (→ See the Installation Manual.)
- Ringing, Delayed (→ See the Installation Manual.)
- Station Programming — Day Button Assignment (Operator and Manager only)
 - Lunch Button Assignment (Operator and Manager only)
 - Night Button Assignment (Operator and Manager only)
 - (4.2 DSS Console Features)
- Toll Restriction (→ See the Installation Manual.)

3.3

Operator/Manager Service Features

Timed Reminder, Remote (Wake-Up Call)

The operator or manager can remotely set or cancel the Timed Reminder of a desired extension.

Setting

PT

 Lift the handset or press SP-PHONE/MONITOR.

7 6 4 Dial 764.

extension no. Dial the desired extension number (100 through 199).

Dial #.

 Confirmation tone and dial tone

7 6 Dial 76.

hour Enter the hour (01 through 12).

minute Enter the minute (00 through 59).

0 or **1** For AM: Dial 0. For PM: Dial 1.

1 or **2** For a one time alarm*1: Dial 1. For a daily alarm*2: Dial 2.

Dial #.

 Confirmation tone

 Hang up or press SP-PHONE/MONITOR.

*1 An alarm will be heard at the preset time and then the setting is cleared.
*2 An alarm will be heard daily at the preset time until the setting is changed or canceled.

Canceling

PT

 Lift the handset or press SP-PHONE/MONITOR.

7 6 4 Dial 764.

extension no. Dial the desired extension number (100 through 199).

Dial #.

 Confirmation tone and dial tone

7 6 2 # Dial 762#.

 Confirmation tone

 Hang up or press SP-PHONE/MONITOR.

<PT Display Example>
Alarm Cancel

3.3 Operator/Manager Service Features

Checking the time setting (with a display PT only)

PT

Lift the handset or press SP-PHONE/MONITOR.

Dial 764.

Dial the desired extension number (100 through 199).

Dial #.

Confirmation tone and dial tone

Dial 763#.

Hang up or press SP-PHONE/MONITOR.

• If “10:10” has been set:
<PT Display Example>

Alarm 10:10AM	— one time
or	
Alarm 10:10AM*	— daily

Conditions

- Be sure the system clock is set correctly.
- There is no limit to the number of the extensions who can set Timed Reminder at the same time.

Feature Reference

Timed Reminder

3.3 Operator/Manager Service Features

Extension Password Set (Manager only)

The manager can assign a password to each extension. The assigned password can be used for the Walking COS feature. The assigned password for the manager (jack number 01) can also be used for the Manager Programming.

Setting

— Be sure that you are in the Station Programming mode. Set the MEMORY switch to “PROGRAM”.

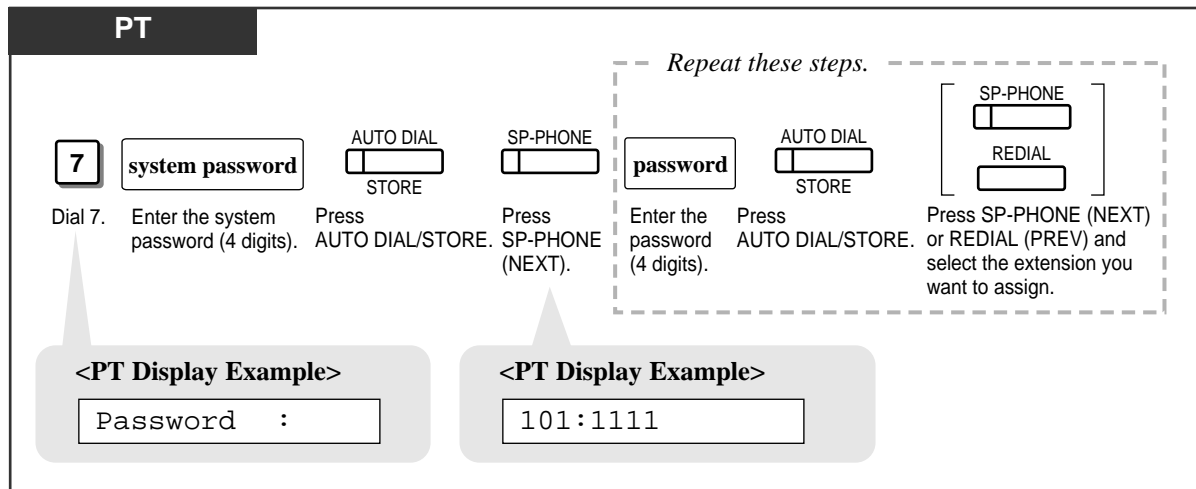

— To exit the Station Programming mode, set the MEMORY switch to “SET”.

Conditions

- The extension number is displayed in the order of the jack number when you press the NEXT or PREV button.
- To erase an incorrect entry, press the CLEAR (TRANSFER) button and enter a new number.

Feature References

Walking COS
Manager Programming (Manager only) (3.3 Operator/Manager Service Features)

Section 4
DSS Console Features
(KX-T7040)

Contents

4.1	<i>Configuration</i>	4-2
	<i>Location of Controls</i>	4-3
4.2	<i>DSS Console Features</i>	4-4
	<i>Station Programming</i>	4-4
	<i>Direct Station Dialing</i>	4-12
	<i>One-Touch Dialing</i>	4-12
	<i>One-Touch Access for System Features</i>	4-12
	<i>Call Transfer</i>	4-13

<Note>

All paired telephone illustrations used in the operating instructions are based on the KX-T7130/KX-T7135 model.

With a Direct Station Selection (DSS) Console, model KX-T7040, you can make or transfer calls and access system features with the touch of a button. The DSS Console must be connected to a Panasonic Advanced Hybrid System and paired with a PT. System Programming is required to designate the jack numbers of the DSS Console. With a paired telephone, you can carry out the following operations using the DSS Console.

- Direct access to an extension (Direct Station Dialing)
- Quick access to an external party (One-Touch Dialing)
- Quick access to a system feature (One-Touch Access for System Features)
- Easy transfer to an extension (Call Transfer)
- Direct access to an Another Extension Message Waiting (Message Waiting)
- Quick setting and cancel the Live Call Screening (Live Call Screening (LCS)†)
- Quick setting of the Two-Way Recording into Voice Mail (Two-Way Recording into Voice Mail†)
- Quick setting of the Voice Mail Transfer (Voice Mail (VM) Transfer†)
- Quick access to the day mode (Time (Day/Night/Lunch) Service) (Operator and Manager only)
- Quick access to the night mode (Time (Day/Night/Lunch) Service) (Operator and Manager only)
- Quick access to the lunch mode (Time (Day/Night/Lunch) Service) (Operator and Manager only)
- Quick setting of the Remote Station Lock Control (Remote Station Lock Control) (Operator and Manager only)

Conditions

- The KX-T7040 and Proprietary Telephone (PT) should be placed side by side on your desk.
- A single line telephone cannot be utilized with the KX-T7040.
- For System Programming, please refer to the Installation Manual.

Programming References

- System Programming — Installation Manual
 - [003] DSS Console Port Assignment
 - [004] Paired Telephone Assignment for DSS Console
 - [112] DSS Console Indication Mode

† Available when the KX-TA624 is connected to a Proprietary Telephone capable Panasonic Voice Processing System (one that supports APT Integration; KX-TVS50/KX-TVS80).

4.1

Configuration

Location of Controls

DSS Buttons with a Busy Lamp Field (BLF) (01 through 32):

These are used to access extensions. The BLF indicates the busy or idle status of each extension in the system. These buttons can also be changed to other feature buttons.

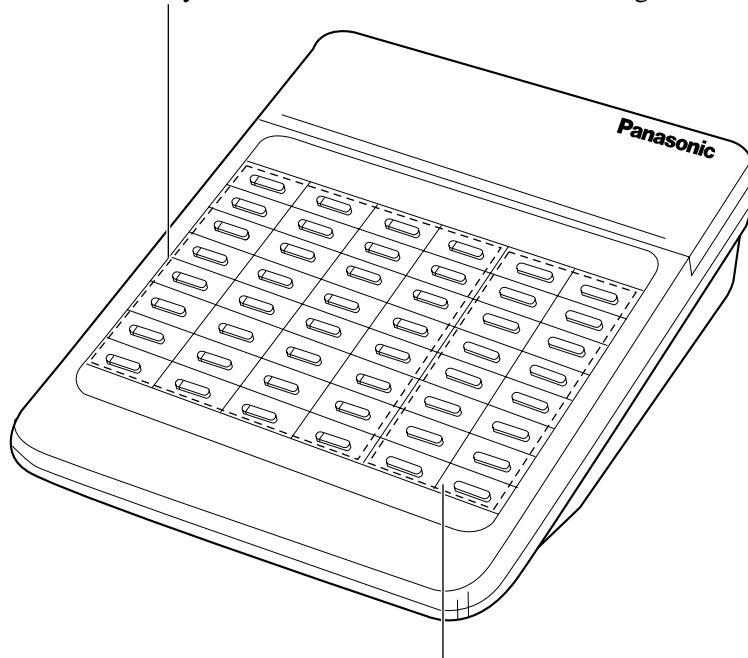

PF (Programmable Feature) Buttons (01 through 16):

These buttons are provided with no default settings. With a paired telephone, you can program the buttons as other feature buttons.

<Back View>

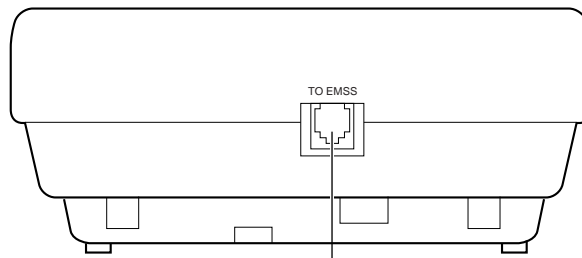

Connects to the KX-TA624 System.

Station Programming

PF buttons are provided with no default settings, while each DSS button has a default setting as follows.

DSS 01–24: extension numbers 101–124

DSS 25–32: no default settings

To meet your various needs, DSS buttons can be changed to other feature buttons.

Every DSS or PF button can be assigned to another extension number, telephone number or feature number by Station Programming.

Conditions

- DSS buttons can be changed to any of the following feature buttons by Station Programming.
 - a) *Another* DSS Button (Every DSS button can be assigned to another extension number.)
 - b) One-Touch Dialing/One-Touch Access Button
 - c) Another Extension Message Waiting Button
 - d) Live Call Screening (LCS) Button†
 - e) Live Call Screening (LCS) Cancel Button†
 - f) Two-Way Record Button†
 - g) Two-Way Transfer Button†
 - h) Voice Mail (VM) Transfer Button†
 - i) Day Button (Operator and Manager only)
 - j) Night Button (Operator and Manager only)
 - k) Lunch Button (Operator and Manager only)
 - l) Station Lock Button (Operator and Manager only)
- PF buttons can be changed to One-Touch Dialing/One-Touch Access buttons by Station Programming.
- When the STORE button is pressed after programming, you will hear beep tones as follows.
 - One beep: The entry is different from the one that was stored previously.
 - Two beeps: The entry is the same as the previously stored one.
- You can check the stored data by pressing the desired button while on-hook. The data will be displayed.

Programming References

- Station Programming (Section 2)
 - Flexible Button Assignment — Another Extension Message Waiting Button
 - Direct Station Selection (DSS) Button,
 - Live Call Screening (LCS) Button†
 - Live Call Screening (LCS) Cancel Button†
 - One-Touch Dialing Button
 - Two-Way Record Button†
 - Two-Way Transfer Button†
 - Voice Mail (VM) Transfer Button†





† Available when the KX-TA624 is connected to a Proprietary Telephone capable Panasonic Voice Processing System (one that supports APT Integration; KX-TVS50/KX-TVS80).

Extension Number Assignment

You can assign a desired number to a DSS button.

— Be sure that you are in the Station Programming mode. Set the MEMORY switch to “PROGRAM”.

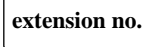
PT and DSS Console

<p>[DSS Console]</p>  <p>Press the desired DSS button.</p>	<p>[Paired telephone]</p>  <p>Dial 1.</p>	<p>[Paired telephone]</p>  <p>Enter the desired extension number (100 through 199).</p>	<p>[Paired telephone]</p>  <p>Press AUTO DIAL/STORE.</p>	<p>Repeat these steps to program numbers for other DSS buttons.</p>
---	--	--	--	---



— To exit the Station Programming mode, set the MEMORY switch to “SET”.

One-Touch Dialing Assignment

You can assign a DSS or PF button as a One-Touch Dialing button. The number can be an extension number or a telephone number. Up to twenty-four digits can be stored in each memory location.

— Be sure that you are in the Station Programming mode. Set the MEMORY switch to “PROGRAM”.

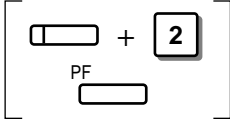
PT and DSS Console

<p>[DSS Console and Paired telephone]</p>  <p>Press the desired DSS button (on the DSS Console) and dial 2 (on the paired telephone), or press the PF button (on the DSS Console).</p>	<p>[Paired telephone]</p>  <p>Enter the desired number.</p>	<p>[Paired telephone]</p>  <p>Press AUTO DIAL/STORE.</p>	<p>Repeat these steps to program numbers for other DSS or PF buttons.</p>
---	--	--	---

- When you assign an outside phone number, you must enter a line access code first.



— To exit the Station Programming mode, set the MEMORY switch to “SET”.

One-Touch Access Assignment for System Features

You can assign a desired feature to a DSS or PF button.

— Be sure that you are in the Station Programming mode. Set the MEMORY switch to “PROGRAM”.

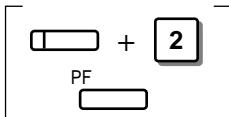
PT and DSS Console

<p>[DSS Console and Paired telephone]</p>  <p>Press the desired DSS button (on the DSS Console) and dial 2 (on the paired telephone), or press the PF button (on the DSS Console).</p>	<p>[Paired telephone]</p> <div style="border: 1px solid black; padding: 5px; width: fit-content; margin: 0 auto;">feature no.</div> <p>Enter the desired feature number.</p>	<p>[Paired telephone]</p>  <p>Press AUTO DIAL/STORE.</p>
---	--	--

Repeat these steps to program numbers for other DSS or PF buttons.

- If you wish to access the “Paging — All” feature, enter feature number 33✕.



— To exit the Station Programming mode, set the MEMORY switch to “SET”.

Another Extension Message Waiting Button Assignment

You can assign a DSS button as an Another Extension Message Waiting button.

— Be sure that you are in the Station Programming mode. Set the MEMORY switch to “PROGRAM”.

PT and DSS Console

<p>[DSS Console]</p>  <p>Press the desired DSS button.</p>	<p>[Paired telephone]</p> <div style="display: inline-block; border: 1px solid black; padding: 2px 5px; margin-right: 5px;">9</div> <div style="display: inline-block; border: 1px solid black; padding: 2px 5px;">5</div> <p>Dial 95.</p>	<p>[Paired telephone]</p> <div style="border: 1px solid black; padding: 5px; width: fit-content; margin: 0 auto;">extension no.</div> <p>Enter the desired extension number (100 through 199).</p>	<p>[Paired telephone]</p>  <p>Press AUTO DIAL/STORE.</p>
---	--	--	--

Repeat these steps to program numbers for other DSS buttons.

— To exit the Station Programming mode, set the MEMORY switch to “SET”.

4.2

DSS Console Features

Live Call Screening (LCS) Button Assignment †

You can assign a DSS button as the Live Call Screening (LCS) button.

— Be sure that you are in the Station Programming mode. Set the MEMORY switch to “PROGRAM”.

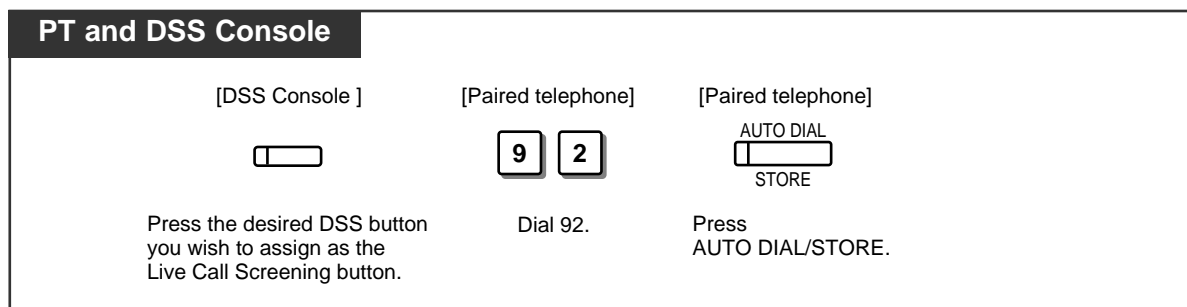

— To exit the Station Programming mode, set the MEMORY switch to “SET”.

Live Call Screening (LCS) Cancel Button Assignment †

You can assign a DSS button as the Live Call Screening (LCS) Cancel button.

— Be sure that you are in the Station Programming mode. Set the MEMORY switch to “PROGRAM”.

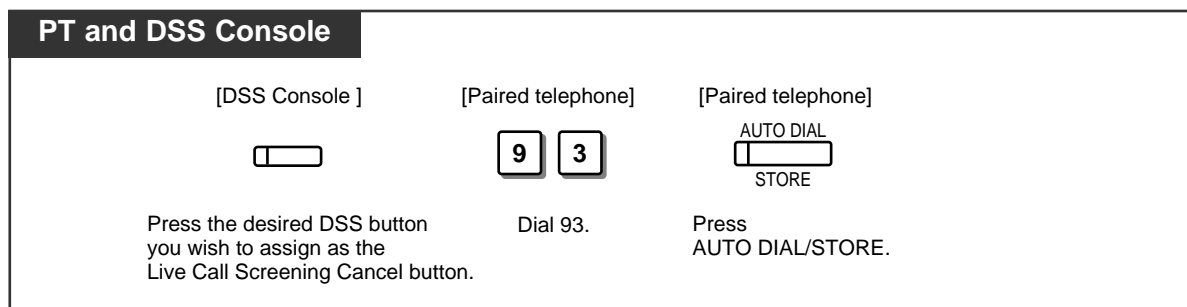

— To exit the Station Programming mode, set the MEMORY switch to “SET”.

† Available when the KX-TA624 is connected to a Proprietary Telephone capable Panasonic Voice Processing System (one that supports APT Integration; KX-TVS50/KX-TVS80).

Two-Way Record Button Assignment †

You can assign a DSS button as the Two-Way Record button. This allows you to record a conversation into your voice mailbox.

— Be sure that you are in the Station Programming mode. Set the MEMORY switch to “PROGRAM”.

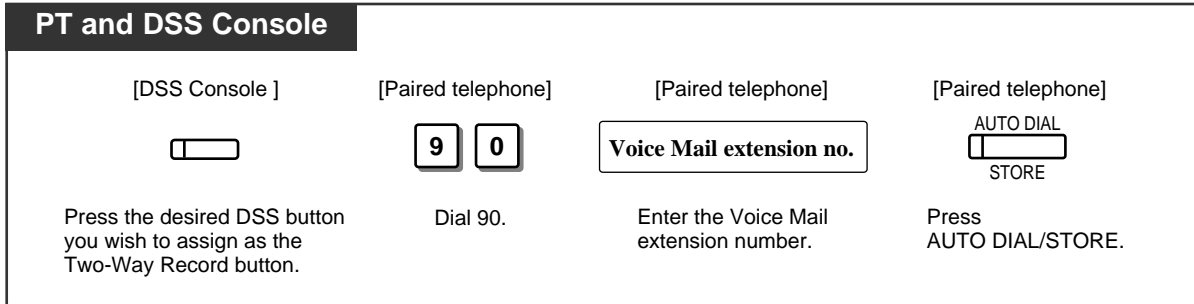

— To exit the Station Programming mode, set the MEMORY switch to “SET”.

Two-Way Transfer Button Assignment †

You can assign a DSS button as the Two-Way Transfer button. This allows you to record a conversation into a desired mailbox.

— Be sure that you are in the Station Programming mode. Set the MEMORY switch to “PROGRAM”.

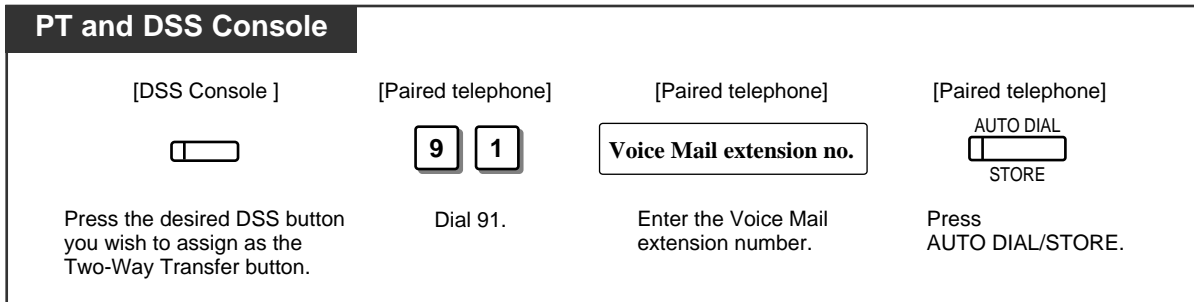

— To exit the Station Programming mode, set the MEMORY switch to “SET”.

† Available when the KX-TA624 is connected to a Proprietary Telephone capable Panasonic Voice Processing System (one that supports APT Integration; KX-TVS50/KX-TVS80).

4.2

DSS Console Features

Voice Mail (VM) Transfer Button Assignment †

You can assign a DSS button as the Voice Mail (VM) Transfer button.

— Be sure that you are in the Station Programming mode. Set the MEMORY switch to “PROGRAM”.

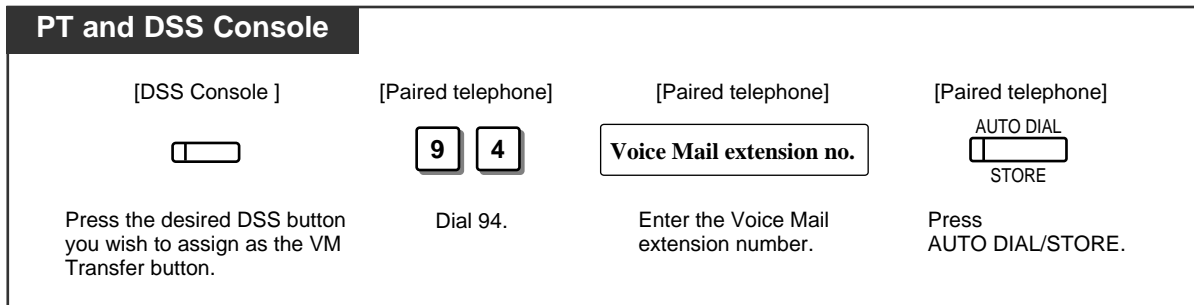

— To exit the Station Programming mode, set the MEMORY switch to “SET”.

† Available when the KX-TA624 is connected to a Proprietary Telephone capable Panasonic Voice Processing System (one that supports APT Integration; KX-TVS50/KX-TVS80).

Day Button Assignment (Operator and Manager only)

You can assign a DSS button as the Day button. Simply pressing the assigned button sets the day mode.

— Be sure that you are in the Station Programming mode. Set the MEMORY switch to “PROGRAM”.

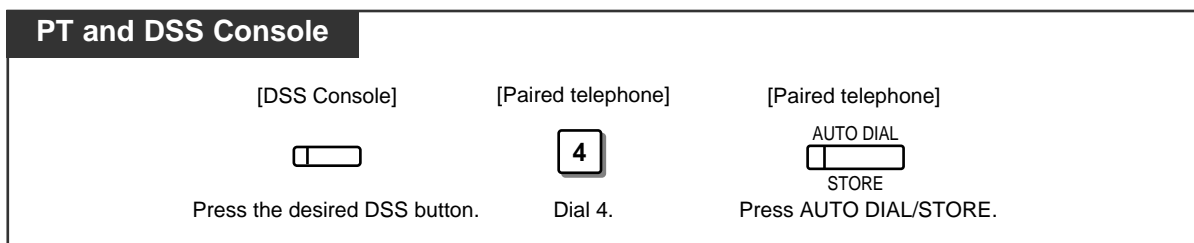



— To exit the Station Programming mode, set the MEMORY switch to “SET”.

Night Button Assignment (Operator and Manager only)

You can assign a DSS button as the Night button. Simply pressing the assigned button sets the night mode.

— Be sure that you are in the Station Programming mode. Set the MEMORY switch to “PROGRAM”.



PT and DSS Console		
[DSS Console]	[Paired telephone]	[Paired telephone]
		
Press the desired DSS button.	Dial 5.	Press AUTO DIAL/STORE.

— To exit the Station Programming mode, set the MEMORY switch to “SET”.

Lunch Button Assignment (Operator and Manager only)

You can assign a DSS button as the Lunch button. Simply pressing the assigned button sets the lunch mode.

— Be sure that you are in the Station Programming mode. Set the MEMORY switch to “PROGRAM”.

PT and DSS Console		
[DSS Console]	[Paired telephone]	[Paired telephone]
		
Press the desired DSS button.	Dial 6.	Press AUTO DIAL/STORE.

— To exit the Station Programming mode, set the MEMORY switch to “SET”.

4.2



DSS Console Features

Station Lock Button Assignment (Operator and Manager only)

You can assign the Station Lock button to a DSS button for the remote station lock control feature.

— Be sure that you are in the Station Programming mode. Set the MEMORY switch to “PROGRAM”.

PT and DSS Console

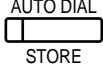

[DSS Console]	[Paired telephone]	[Paired telephone]	[Paired telephone]	Repeat these steps to program numbers for other DSS buttons.
				
Press the desired DSS button.	Dial 7.	Enter the desired extension number (100 through 199).	Press AUTO DIAL/STORE.	

— To exit the Station Programming mode, set the MEMORY switch to “SET”.

Station Programming Cancel

To cancel after programming

PT and DSS Console

[DSS Console]	[Paired telephone]	[Paired telephone]
		
Press the DSS or PF button which you wish to cancel.	Dial 2.	Press AUTO DIAL/STORE.
		<ul style="list-style-type: none">• The number is canceled.

Direct Station Dialing

An extension can be called and accessed, by simply pressing a DSS button. The BLF shows if the extension is engaged.

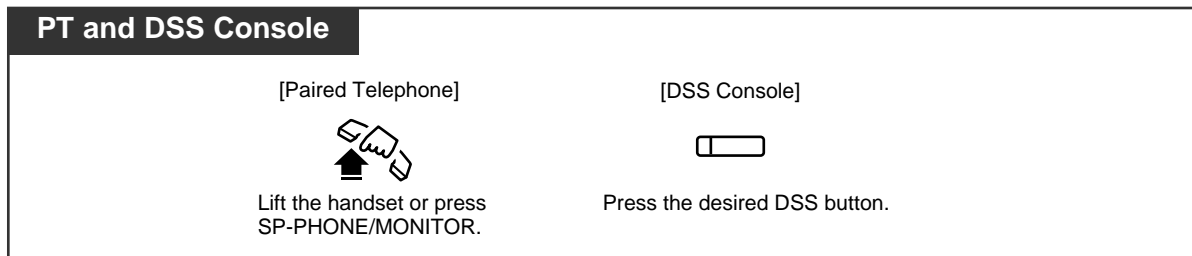

One-Touch Dialing

The stored number is dialed automatically by pressing a programmed DSS or PF button.

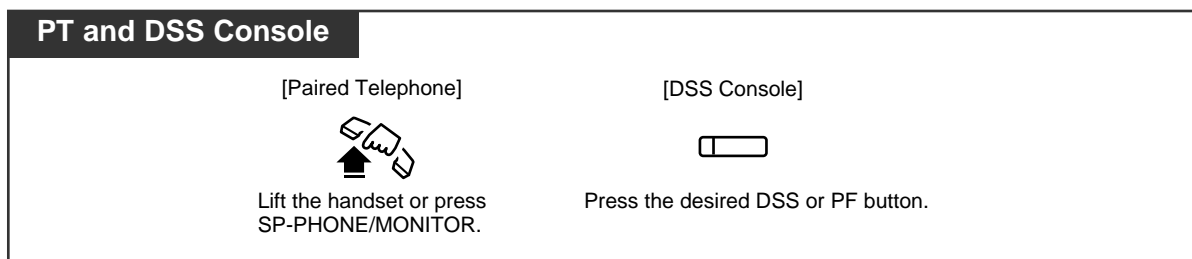

One-Touch Access for System Features

You can access system features by pressing a programmed DSS or PF button.

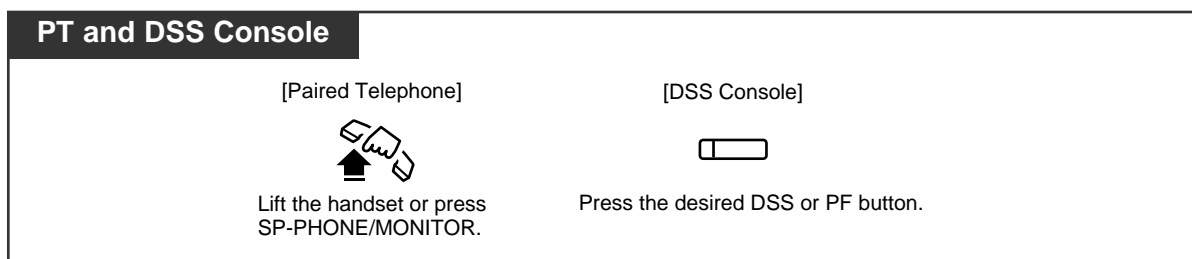

Call Transfer

A call can be transferred to an extension using a DSS button.

Without Transfer

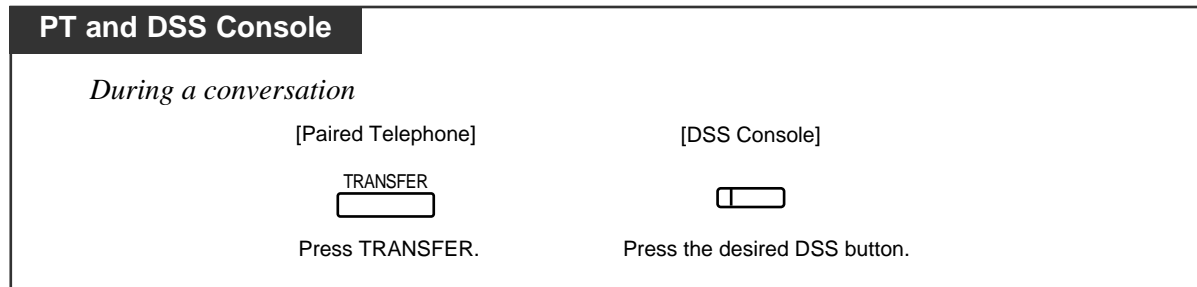

With Transfer

An outside call can be transferred to an extension using a one-touch operation. The One-Touch Transfer feature must be set by System Programming.

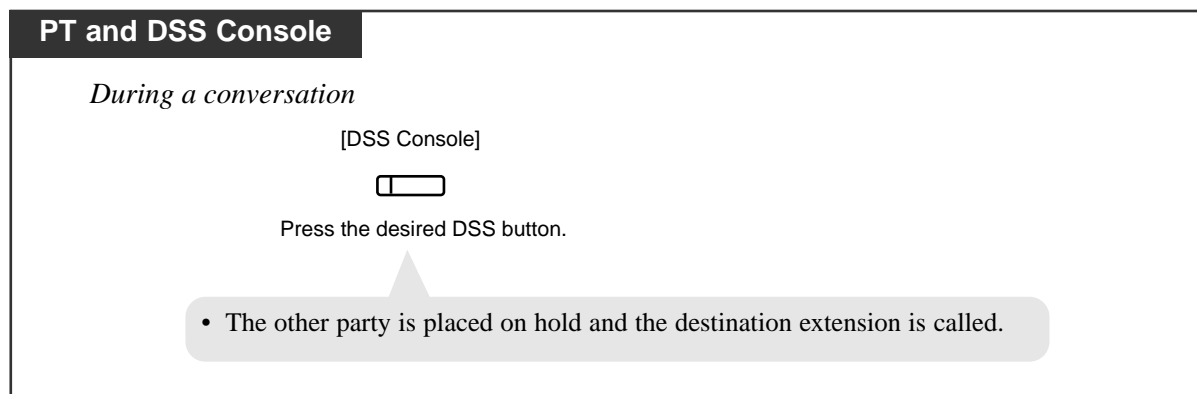

Programming Reference

- System Programming — Installation Manual
[005] One-Touch Transfer Using a DSS Button

Section 5

Appendix

Contents

<i>Display Examples</i>	5-2
<i>Feature Number List</i>	5-8
<i>Tone List</i>	5-11
<i>Troubleshooting</i>	5-13

Display Examples

Display	Description
Set Time & Date	Factory setting. The system clock is not working properly.
Jan 1 12:00AM Jan 1 20:00	The current date and time using a 12-hour clock. The current date and time using a 24-hour clock. — Pressing “*” while on-hook alternates between this display and the following two displays.
Jan 1,1998 THU	The current date and day of the week.
123: 123:Tony Viola	Making or receiving an intercom call. Also, displayed while on-hook. A name is not assigned. Making or receiving an intercom call or called by “Camp-On” (intercom recall). Also, displayed while on-hook. A name is assigned. Confirming key programming on a DSS or MESSAGE button.
101: Busy	The destination extension is busy.
101: DND	The destination extension has set “Do Not Disturb (DND)”.
1234567890	Called by an outside (CO) line with a Caller ID*-number. *Caller ID: Provides you with a caller’s information, such as the name and telephone number, on an outside (CO) line assigned to receive Caller ID service calls. This requires subscribing to caller identification services. Refer to the Installation Manual.
Panasonic	Called by an outside (CO) line, with a Caller ID*-name.
950-1001PP12345&	Confirming the key programming on the REDIAL, SAVE, or One-Touch Dialing button.
→123:Tony Viola	Making or receiving an intercom call after a call is forwarded. A name is assigned.
→101:Busy	The destination extension is busy after a call is forwarded.
Alarm 10:15AM	The “Timed Reminder” setting is completed or a “Timed Reminder” call was received (one-time mode). Confirming the “Timed Reminder” programming.
Alarm 10:15AM*	The “Timed Reminder” setting is completed or a “Timed Reminder” call was received (everyday mode). Confirming the “Timed Reminder” programming.
Alarm Cancel	Canceled “Timed Reminder”.
Alarm Not Stored	Confirming “Timed Reminder” programming when it is not stored.
At Ext 101	Absent Message 3.

Display	Description
Back at 11:00AM	Absent Message 4.
BGM off	Stopped BGM.
BGM on	Started BGM.
Busy	The called doorphone or external pager is in use.
Busy Ovrde Allow	Canceled “Executive Busy Override Deny”.
Busy Ovrde Deny	Completed setting “Executive Busy Override Deny”.
C.Pickup Allow	Canceled “Call Pickup Deny”.
C.Pickup Deny	Completed setting “Call Pickup Deny”.
Call on CO 1	Called by an outside (CO) line.
Call Prked at 1	Completed setting “Call Park”.
Callback All COs	Completed setting “Camp-On” when there is no idle outside (CO) line.
Callback CO 1	Completed setting “Camp-On”.
Callback CO G1	Completed setting “Camp-On”.
Callback Ext 101	Completed setting “Camp-On”.
CID Log Clear	Cleared all logs.
CO 1	An idle outside (CO) line is seized.
CO 1 0:01'15	The duration time of incoming outside call.
CO 1 & CO 2	A Conference with two outside (CO) lines. Called by hold recall. — “Conference, Unattended”.
CO 3 Free	Called by “Camp-On” (Outside (CO) line recall).
Conference	Confirming key programming on the Conference button.
CO in Use	The selected outside (CO) line is busy.
CO Not Assigned	The desired outside (CO) line is restricted (not assigned).
CW(CO) Off	Canceled “Call Waiting” for outside calls.
CW(CO) On	Completed setting “Call Waiting” for outside calls.
CW(Ext/Door) Off	Canceled “Call Waiting” for intercom calls and doorphone calls.
CW(Ext/Door) On	Completed setting “Call Waiting” for intercom calls and doorphone calls.
Data Mode Off	Canceled “Data Line Security”.
Data Mode On	Completed setting “Data Line Security”.
Day Mode	Day mode status. — “Time (Day/Night/Lunch) Service”

Display	Description
Do Not Disturb	Confirming the key programming on the FWD/DND button. Completed setting “Do Not Disturb (DND)”.
D - Opener 1-On	Completed opening the door.
Door Phone 1	Making or receiving a doorphone call.
Ext101 & CO 1	Conference with an extension and outside (CO) line.
Ext101 & Ext102	Conference with two extensions.
Enter ACCNT Code	Pressing the FWD/DND or PAUSE button. — “Account Code Entry”
Ext Data Clear	Executed “Station Feature Clear”.
External Page	Accessed to “Paging — External”.
FWD(ALL) All COs	Completed setting “Call Forwarding — to Outside (CO) Line”. Confirming the key programming on the FWD/DND button.
FWD (All) CO G1	Completed setting “Call Forwarding — to Outside (CO) Line” (- to outside (CO) line group). Confirming the key programming on the FWD/DND button.
FWD(ALL) Ext101	Completed setting “Call Forwarding — All Calls”. Confirming the key programming on the FWD/DND button.
FWD(B/NA) Ext101	Completed setting “Call Forwarding — Busy/No Answer”. Confirming the key programming on the FWD/DND button.
FWD(From) Ext101	Completed setting “Call Forwarding — Follow Me”.
FWD/DND Cancel	Canceled “Call Forwarding” or “Do Not Disturb (DND)”.
Gone Home	Absent Message 2.
Group Log In	“Log-In” is set.
Group Log Out	“Log-Out” is set.
In a Meeting	Absent Message 6.
Incoming Log Off	Canceled “Incoming Call Log”.
Incoming Log On	“Incoming Call Log” is set.
LCS	Completed setting “Live Call Screening (LCS)”.
LCS Cancel	Canceled “Live Call Screening (LCS)”.
Locked : 4567	Completed setting “Call Log Lock, Incoming”. Completed setting “Electronic Station Lockout”. Completed setting “Message Waiting for Another Extension Lock”.
Lunch Mode	Lunch mode status. — “Time (Day/Night/Lunch) Service”

Display	Description
Message Cancel	Canceled Absent Message.
MW at Ext 101	Completed setting "Message Waiting".
MW Not Accepted	The "Message Waiting" setting was not accepted.
MW Cancelled	Canceled "Message Waiting".
New:002 Old:003	Confirming the number of logged calls.
Night Mode	Night mode status. — "Time (Day/Night/Lunch) Service"
No Held Call	There is not a held call when retrieving a call on hold or parked call.
No Incoming Call	There is not an incoming call when trying to pick up a call.
No Page	When trying to answer a page, there is no call or someone has already answered the page.
Not Valid	Illegal operation.
Out Until 12/12	Absent Message 5.
Paging All	Accessing "Paging — All".
Paging All Ext	Accessed "Paging — Group" (- to all extensions).
Paging Allow	Canceled "Paging — DENY".
Paging Deny	"Paging — DENY" is set.
Paging Group 1	Accessed "Paging — Group" (- to a particular extension group).
Park at 1 N/A	The "Call Park" setting was not available.
Password:123	Completed setting the LCS password. — "Live Call Screening (LCS)"
Password Cancel	Canceled the LCS password. — "Live Call Screening (LCS)"
PITS-PGM NO? →	Entered the Station Programming mode.
PSD Set 1	"Personal Speed Dialing" is set.
PSD 1 Not Stored	Confirming the Personal Speed Dialing number.
RCL: Ext 101	Called by transfer recall, without a name. — "Call Transfer"
Restricted	The outgoing call is restricted.
Room Monitor Off	Canceled "Room Monitor".
Room Monitor On	"Room Monitor" is set.

Display	Description
Set COS Ext101	The walking COS feature is set.
SYS-PGM NO? →	Entered the System Programming mode.
Transfer to CO	The destination extension has set “Call Forwarding — to Outside (CO) Line”.
Unlocked	Canceled “Call Log Lock, Incoming”. Canceled “Electronic Station Lockout”. Canceled “Message Waiting for Another Extension Lock”.
Will Return Soon	Absent Message 1.

Examples — in Station Programming mode

Display	Description
CID-C Indication	The Caller ID Indication — Common button is assigned.
CID-P Indication	The Caller ID Indication — Personal button is assigned.
CID-C Selection	The Caller ID Selection — Common button is assigned.
CID-P Selection	The Caller ID Selection — Personal button is assigned.
CO-1	The Single-CO (S-CO) button is assigned.
Conference	The Conference (CONF) button is assigned.
C.W.Tone-1	Selecting a Call Waiting tone.
Day	The Day button is assigned.
Ext101: 1234	Assigned an extension password.
EXT-123	The DSS button is assigned.
Function Clear	Station Programming data can be cleared.
FWD/DND	The FWD/DND button is assigned.
Group Log In/Out	The Log-In/Log-Out button is assigned.
Hands-free	Selecting a Hands-free mode. — “Live Call Screening (LCS)”.
Jack01<=>EXT101	Confirming a jack number and extension number.
LCS	The Live Call Screening (LCS) button is assigned.
LCS Cancel	The Live Call Screening (LCS) Cancel button is assigned.
Lock Release	“Electronic Station Lockout — CANCEL ALL” is set.
Lunch	The Lunch button is assigned.

Display	Description
Message Waiting	Restored the Message Waiting (MESSAGE) button.
MW-123	The Another Extension Message Waiting button is assigned.
Night	The Night button is assigned.
Not Stored	No programming is assigned.
Other CO Key	The Other-CO (O-CO) button is assigned.
Playback 1:00	When playing back the OGM.
Pref. In :CO-2	Selecting a “Prime Line Preference — Incoming”.
Pref. In :No	Selecting a “No Line Preference — Incoming”.
Pref. In :Ring	Selecting a “Ring Line Preference — Incoming”.
Pref. Out:CO-2	Selecting a “Prime Line Preference — Outgoing”.
Pref. Out:Idle	Selecting an “Idle Line Preference — Outgoing”.
Pref. Out:No	Selecting a “No Line Preference — Outgoing”.
Private	Selecting a Private mode. — “Live Call Screening (LCS)”.
Record 1 :00	When recording the OGM.
RNG:1,2,3,4,5,6	Selecting an “Outside (CO) Line Ringing Selection”.
Save Button	The SAVE button is assigned.
Tone Call	Selecting a Ring-Calling mode.
TRK GRP-6	The Group-CO (G-CO) button is assigned.
Voice Call	Selecting a Voice-Calling mode.
VTR-101	The Voice Mail (VM) Transfer button is assigned.
2WAY-REC:101	The Two-Way Recording button is assigned.
2WAY-TRANS:101	The Two-Way Transfer button is assigned.
092-555-2111	The One-Touch Dialing button is assigned.
*EXT-101	The Station Lock button is assigned.

Conditions

- If the displayed characters exceed sixteen digits, “&” is shown on the right-hand side of the display.
- The duration time display is only shown when you make or receive an outside call. The Count start time for outgoing calls can be programmed as desired.
- When you confirm key programming, be sure to press the button while on-hook.

Feature Number List**Feature Numbers and Additional Required Digits**

Feature	Number	Additional Required Digits
Absent Message Capability set / cancel	75	1-6 / 0 + #
Account Code Entry for an SLT	49 or * *	Account code
Call Forwarding set / cancel	71	(1-3) + desired number / 0 + #
Call Forwarding — Follow Me set / cancel	71	5 / 8 + EXTN. (extension no.) + #
Call Hold (Hold Mode 2 or 3) for an SLT	20	
Call Hold, Retrieve outside call / intercom call	53 / 5	CO (outside line no.) / EXTN.
Call Log, Incoming in the Common Area All Clear	70 * * #	
Call Log, Incoming in the Personal Area All Clear	70 * #	
Call Log, Incoming the 21st call in the personal area overwrite / disregard	737	1 / 0 + #
Call Log, Incoming the 301st call in the common area overwrite / disregard	737	3 / 2 + #
Call Log Lock, Incoming lock unlock	77 77	0000-9999 twice + # 0000-9999 + #
Call Park / Call Park Retrieve	22 / 52	0-9
Call Pickup, Directed	4	EXTN.
Call Pickup, Group	40	
Call Pickup Deny set / cancel	72	1 / 0 + #
Call Retrieving from TAM	4* ¹	
Call Waiting set / cancel for extensions	732	1 / 0 + #
Call Waiting set / cancel for outside (CO) lines	731	1 / 0 + #
Data Line Security set / cancel	730	1 / 0 + #
Do Not Disturb (DND) set / cancel	71	4 / 0 + #
Doorphone Call calling / door open	31 / 55	1-4
Electronic Station Lockout set cancel	77 77	0000-9999 twice + # 0000-9999 + #
Executive Busy Override Deny set / cancel	733	0 / 1 + #
Extension Number	100-199	
External Feature Access	6	
Live Call Screening Password set cancel	77 * 77 *	000-999 twice + # 000-999 + #

*¹ Dial after dialing the TAM's extension number and hearing its busy tone.

Feature	Number	Additional Required Digits
Log-In / Log-Out	736	0 / 1 + #
Message Waiting set / cancel	70	(1 + EXTN.) / (2 + EXTN.) + #
Message Waiting cancel all messages	70	0 + #
Message Waiting for Another Extension cancel all messages	70	3 + EXTN. + #
Message Waiting for Another Extension Lock set	70	4000-9999 twice + #
cancel	70	4000-9999 + #
Operator Call	0	
Outward Dialing		
— Line Access, Automatic	9	
— Line Access, Outside (CO) Line Group	8	1-6
Paging — All	33	* or 9
Paging — External	34	
Paging — Group all / particular	33	0 / 1-8
Paging — ANSWER	43	
Paging — DENY set / cancel	734	1 / 0 + #
Personal Speed Dialing	1* or #	0-9
Personal Speed Dialing store	2*	(0-9) + phone no. + #
Personal Speed Dialing confirm	3*	0-9 + #
Pickup Dialing (Hot Line) assign / set / cancel for an SLT	74	2 + phone no. / 1 / 0 + #
Redial, Last Number for an SLT	## or 80	
Room Monitor set / cancel	735	1 / 0 + #
Station Feature Clear	79	#
System Speed Dialing for an SLT	*	00-99
Timed Reminder set	76	hhmm* ² + (0 / 1) + (1 / 2) + #
Timed Reminder cancel / confirm	76	2 / 3 + #
Timed Reminder, Remote cancel	764	EXTN. + # + 762#
Timed Reminder, Remote check	764	EXTN. + # + 763#
Timed Reminder, Remote set	764	EXTN. + # + 76 + hhmm* ² + (0 / 1) + (1 / 2) + #
Time Service set / cancel	78	1-3 / 0 + #
Walking COS	7*	Extension password + EXTN. + #

*² hhmm hh: hour (01 - 12) / mm: minute (00 - 59)

Feature Numbers

Feature	Number
<i>While a busy tone is heard</i>	
Automatic Callback Busy (Camp-On)	6
Busy Station Signaling (BSS)	1
Executive Busy Override	2
<i>While a Do Not Disturb tone is heard</i>	
Do Not Disturb (DND) Override	2
<i>During a call or while talking</i>	
Switching to Tone Alert	×
Conference	3
Door open	5
Pulse to Tone Conversion	×#
<i>When the telephone is on-hook</i>	
Background Music (BGM) on / off	1
Time (Day/Night/Lunch) mode display	#
EXTN. and extension name / Date (day/month) and time display / date (month/day/year/day of the week) display changing	×

Conditions

- When “×” or “#” are included in a feature number, users with rotary telephones cannot access the feature except for the ones which can use “0” instead of “#”.

Tone List

< TONE >

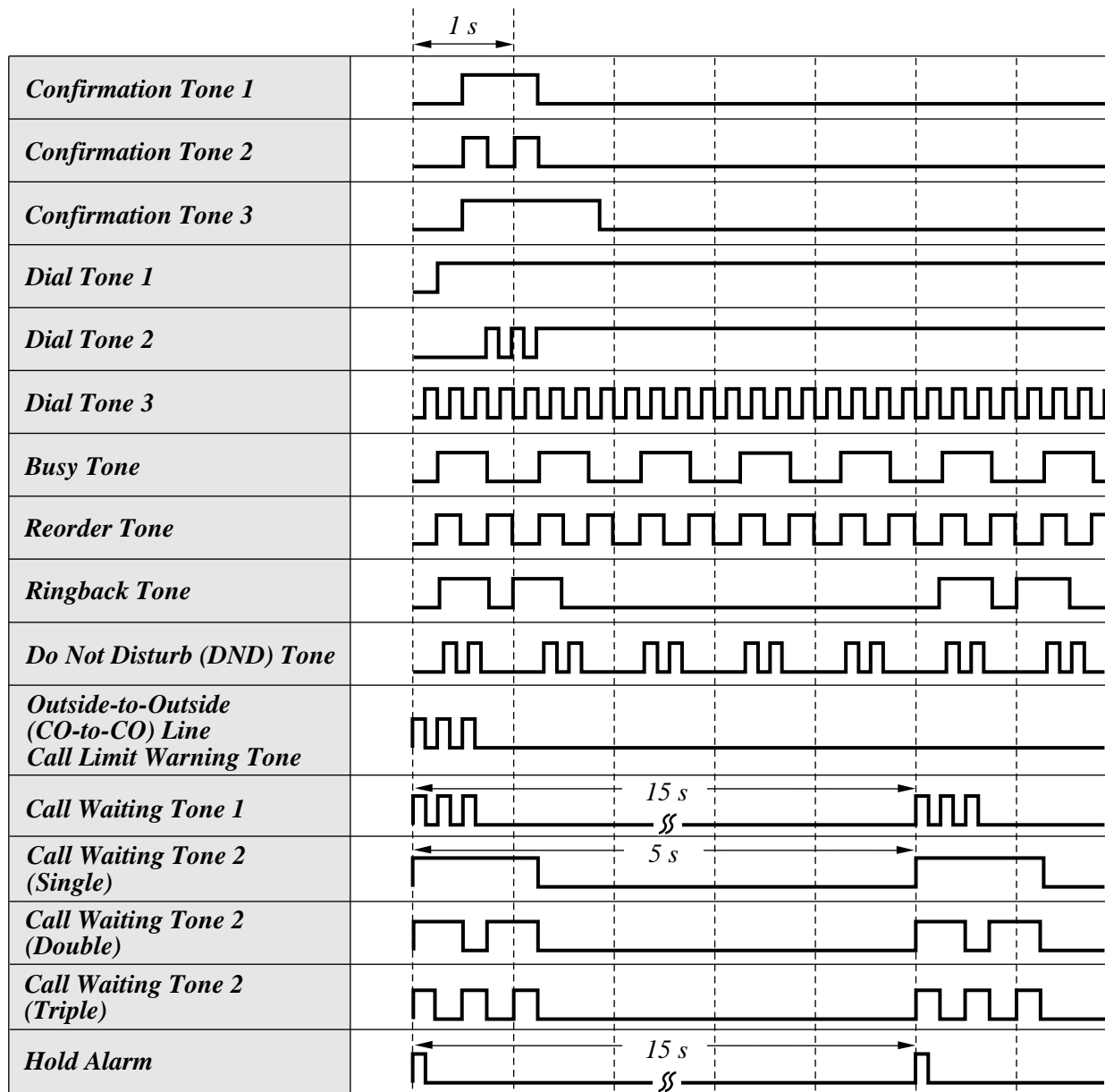

< RING TONE >

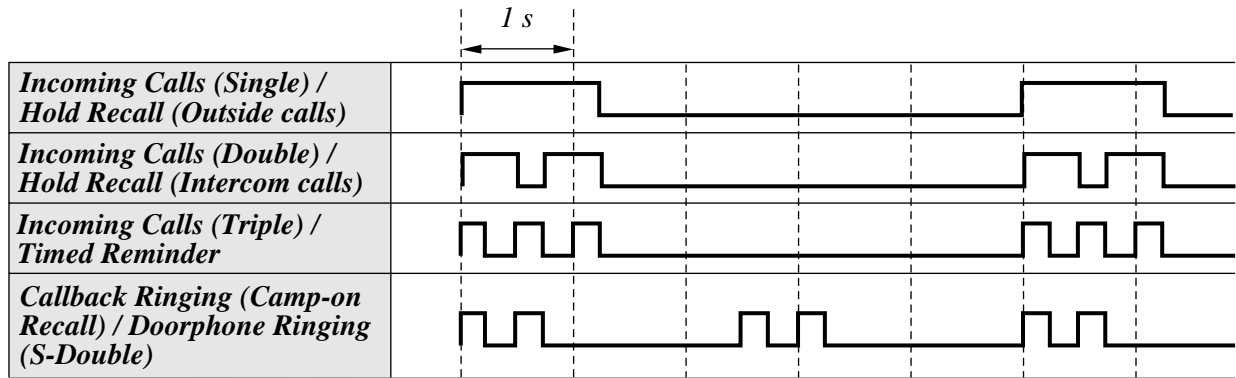

Troubleshooting

If a power failure occurs...

Your system enables a conversation between a specific outside (CO) line and extension (Power Failure Transfer) and supports system data backup.

Power Failure Transfer

A specific extension can be automatically connected to a specific outside (CO) line. This provides outside (CO) line calls between the following extension and outside (CO) line.

Outside (CO) line 1 is connected to extension jack number 01.

Outside (CO) line 4 is connected to extension jack number 09.

- All other conversations will be disconnected during a power failure.
- Proprietary telephones (PT) cannot be used during a power failure. A single line telephone will work in the event of a power failure. Connect the single line telephone to the above jack.
- When power is restored after a power failure, your system automatically restarts, maintaining as much of the previous system data as possible.

Problem	Probable Cause	Possible Solution
Nothing is heard in the hands-free mode.	The “Headset” mode is selected.	When the headset is not used, set the mode to “Handset”. Refer to “Initial Settings” (Section 1.1).
The unit does not ring.	<ul style="list-style-type: none"> • An outside (CO) line number is not programmed. • The Ringer Volume is set to “OFF”. 	<ul style="list-style-type: none"> • To program outside (CO) line numbers, refer to the Installation Manual. • Increase the Ringer Volume. Refer to “Initial Settings” (Section 1.1).
The display flashes the following message. <div style="border: 1px solid black; padding: 2px; width: fit-content; margin: 5px auto;">Set Time & Date</div>	The system internal clock is not working properly.	Consult with an authorized Panasonic Factory Servicenter.

**Panasonic Consumer Electronics
Company, Division of Matsushita
Electric Corporation of America**

One Panasonic Way, Secaucus,
New Jersey 07094

**Panasonic Sales Company (“PSC”),
Division of Matsushita Electric of
Puerto Rico, Inc.**

Ave. 65 de Infantería, Km. 9.5,
San Gabriel Industrial Park, Carolina,
Puerto Rico 00985

Copyright:

This manual is copyrighted by Kyushu Matsushita Electric Co., Ltd. (KME). Under the applicable copyright laws, this manual may not be reproduced in any form, in whole or part, without the prior written consent of KME and its licensee.

© 1999 Kyushu Matsushita Electric Co., Ltd. All Rights Reserved.