

# Panasonic

Integrated Telephone System

EASA-PHONE®

Model No. **KX-T2395/KX-T2395D-W**

Pulse-or-tone dialling capability

## OPERATING INSTRUCTIONS



**PLEASE READ BEFORE USE AND SAVE.**

La referencia rápida en español puede ser encontrada en las páginas 35~41.  
(Spanish Quick Reference can be found on pages 35~41.)

**AUTO-LOGIC™**

Please read **IMPORTANT SAFETY INSTRUCTIONS** on pages 43–44 before use. Read and understand all instructions.

## Features

Thank you for your purchasing the Panasonic integrated telephone system.

### **Tone Remote Control System**

lets you activate functions from a remote location, via a tone telephone.

### **AUTO-LOGIC™ Operation**

automatically rewinds, plays messages, stops at the last message and resets itself at the touch of one button.

### **2-Way/Memo Recording**

lets you store phone conversations and allows your family or secretary to leave personal messages on the tape.

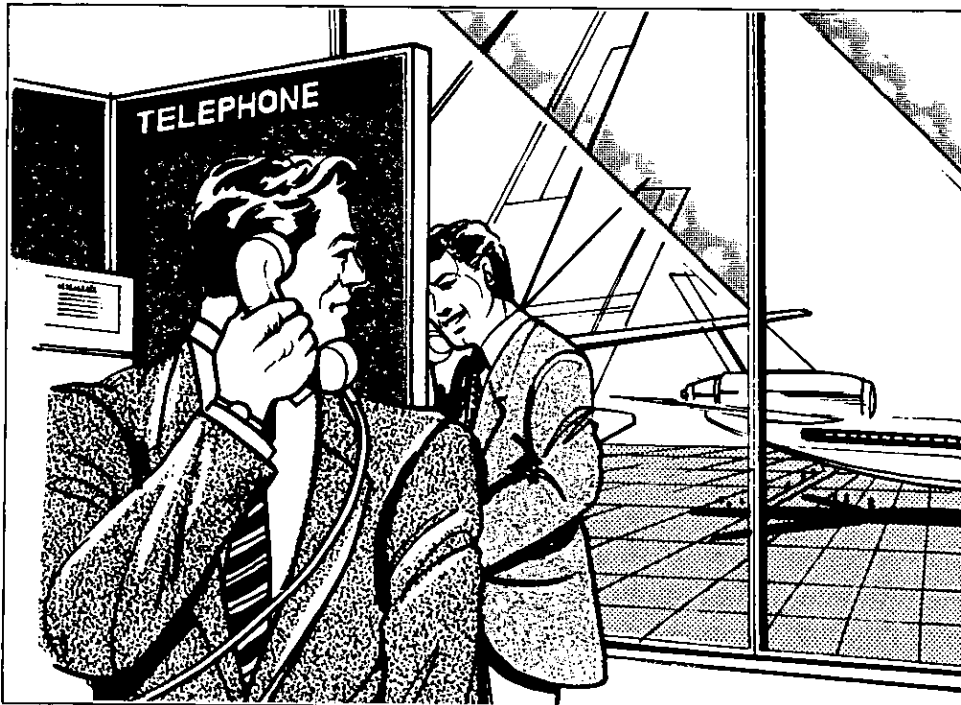

**Call Screening**

lets you listen to your caller before picking up the receiver.

**Built-in Speakerphone**

for "hands-free" conversations or conference calls.

**One-Touch Automatic Dialing**

for up to 12 telephone numbers.

**Switchable Tone/Pulse Settings**

for compatibility with tone-actuated computer systems and any phone line.

**One-Touch Tone Switching**

lets you temporarily switch to tone from pulse mode by pressing a button.

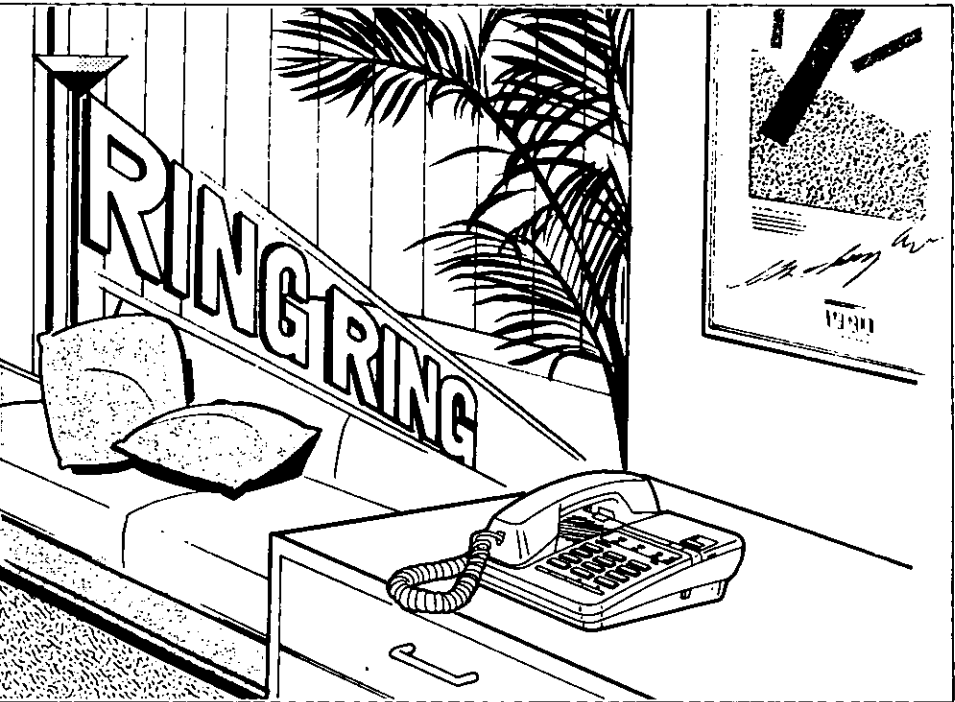

# Table of Contents

---

## PREPARATION

---

### TELEPHONE

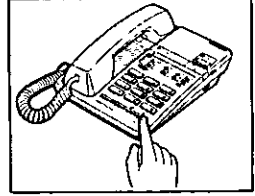

### ANSWERING MACHINE



### GENERAL INFORMATION

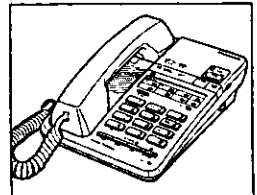

Features .....	I
Table of Contents .....	III
Included Accessories .....	V
<hr/>	
Location of Controls .....	1
Inserting the Tape .....	5
Connection .....	6
Initial Settings .....	7
Recording an Outgoing Message (OGM) .....	9
Checking your recorded OGM .....	10
<hr/>	
Making and Answering Calls .....	11
Making calls using the handset .....	11
Making calls using the SP-PHONE button (on-hook dialing) .....	11
Redialing, Answering calls .....	12
Automatic Dialing .....	13
Storing the telephone numbers .....	14
Correcting an error while storing .....	16
Confirming a stored number .....	16
Erasing a stored number .....	16
Other Operation .....	17
Hold .....	17
Flash, Mute, Tone, Pause, Combination dialing .....	18
<hr/>	
Setting up for Answering Calls .....	19
Recording from the beginning of the ICM part of the tape .....	20
Recording after the messages you want to save .....	20
Listening to Recorded Messages .....	21
Playing back the tape from the beginning .....	22
Remote Operation .....	23
The remote code number .....	23
Playing back all the messages .....	23
Resetting the tape for future message .....	24
Recording a marker message .....	24
Setting answer mode remotely .....	24
Other Features .....	25
Recording a memo message .....	25
Recording a conversation (2-Way Recording) .....	26
Screening incoming calls .....	26
<hr/>	
Troubleshooting Guide .....	27
Wall Mounting .....	29
Accessory Order Information .....	30
Maintenance .....	31
Precaution .....	33
Important Information .....	34
Referencia Rápida .....	35
Important safety instructions .....	43

# Included Accessories

AC adaptor ..... one  
KX-A11

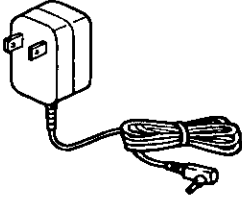

Handset ..... one

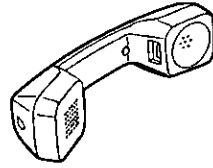

Telephone cord ..... one

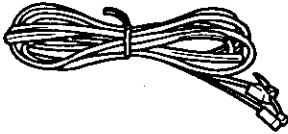

Microcassette tape ..... one

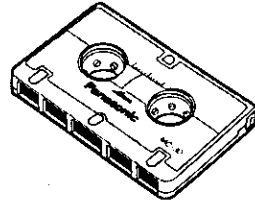

Handset cord ..... one

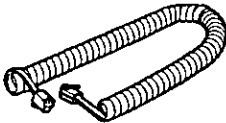

Wall mounting adaptor ..... one

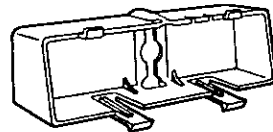

## Memory card

Use a pencil or a ball-point pen to fill in the station directory with station name. (You can use the reverse side for writing, too.)

Remove the cover using an instrument with a pointed end, like a pen.

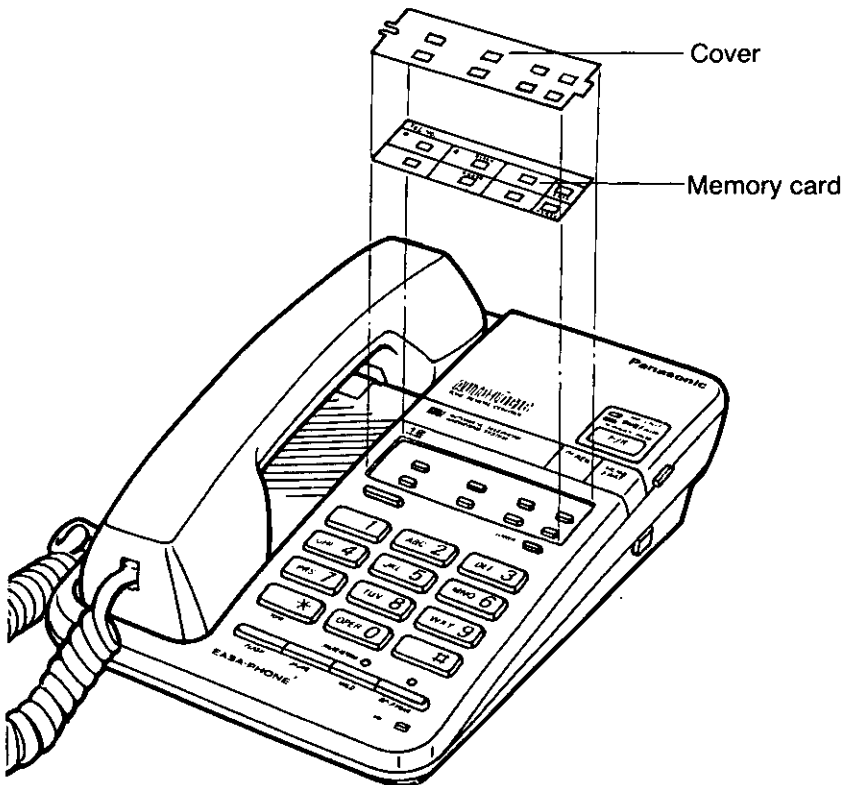
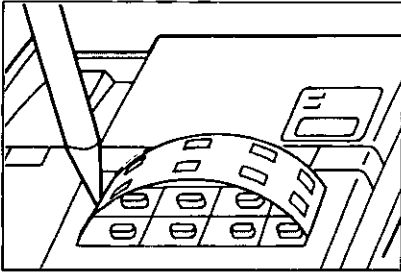

# Location of Controls

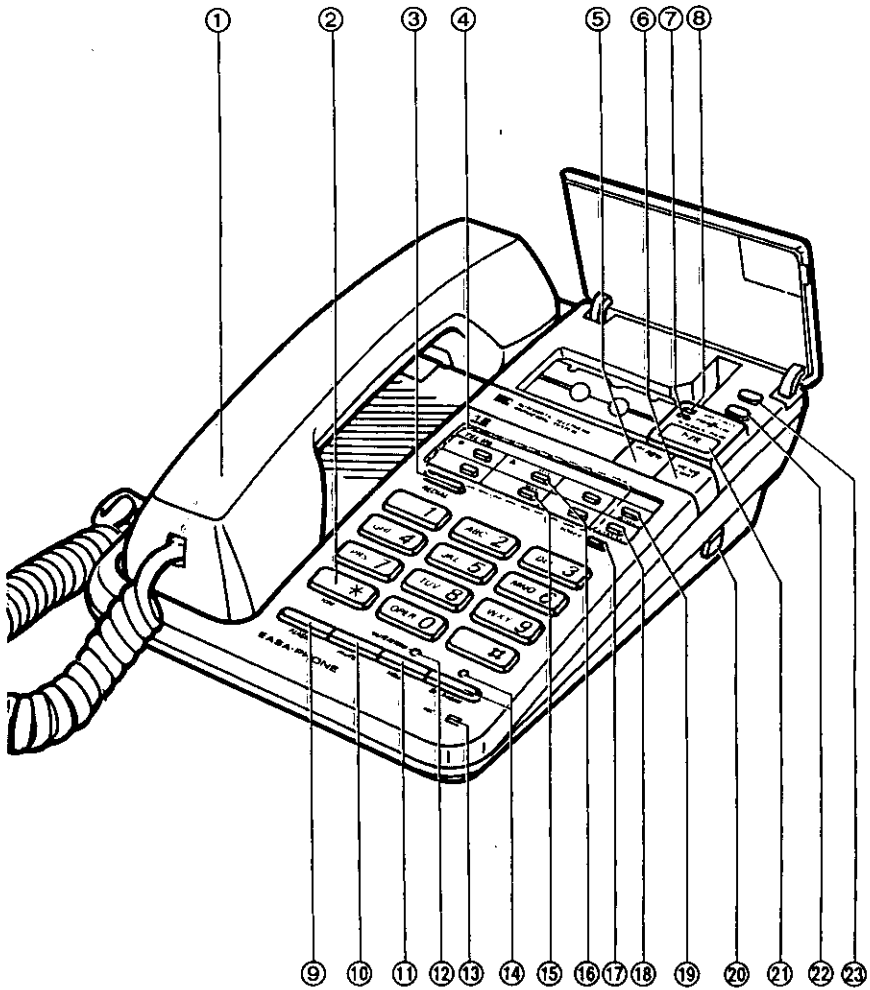



- ① Handset
- ② TONE Button:  
Used to change the dialing mode from pulse to tone during a dialing operation.
- ③ REDIAL Button:  
Used to redial the last dialed phone number.
- ④ DIRECT CALL Buttons:  
Used to store phone numbers and to make calls using one-touch dialing.
- ⑤ REW (Rewind) Button:  
Used to rewind the cassette tape.
- ⑥ MEMO/2 WAY Button:  
Used to record a memo message or a telephone conversation.
- ⑦ PWR/IN USE (Power/In use) Indicator
- ⑧ ANS/CALLS (Answer/calls) Indicator
- ⑨ FLASH Button:  
Used to access some of the feature of your host PBX.
- ⑩ MUTE Button:  
Used when you do not want your voice to be heard by the other party. The voice of the calling party will still be heard.
- ⑪ HOLD Button and Indicator:  
Used to put the calling party on hold during a conversation. While holding, the indicator flashes.
- ⑫ MUTE/STORE (HOLD) Indicator
- ⑬ MIC (Microphone)
- ⑭ SP-PHONE (Speakerphone) Button and Indicator:  
Used to make or answer a phone call without using the handset.
- ⑮ CLEAR Button:  
Used to clear the memory while storing telephone number.
- ⑯ PAUSE Button:  
Used to enter a pause in phone numbers when programming.
- ⑰ LOWER Button:  
Used to select the lower memory location.
- ⑱ STORE Button:  
Used to store phone numbers into memory.
- ⑲ PROG (Program) Button:  
Used to start and complete the programming procedures.
- ⑳ ANS SYS ON/OFF (Answer System On/Off) Switch:  
Used to turn on and off the unit. The PWR/IN USE indicator lights when the unit is turned on.
- ㉑ PLAYBACK/PAUSE Button:  
Used to play back the recorded Incoming Messages and to stop the ICM tape temporarily during ICM playback.
- ㉒ OGM PLAY Button:  
Used to play the recorded Outgoing Message.
- ㉓ OGM REC Button:  
Used to record the Outgoing Message.

# Location of Controls

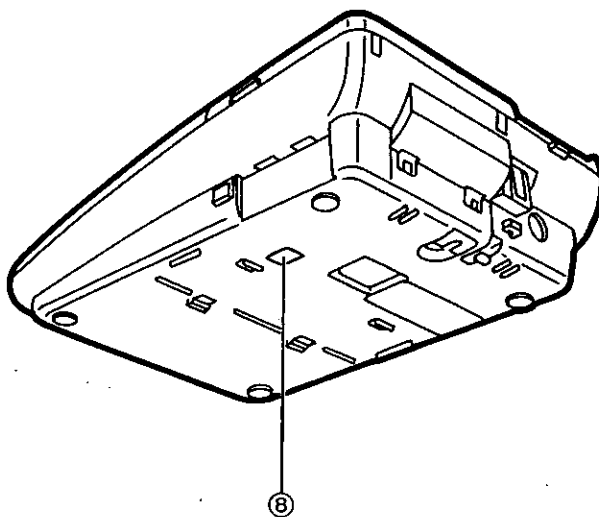
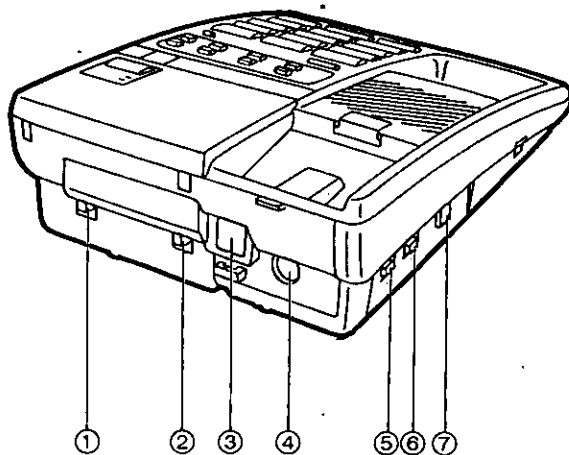

- ① **CPC Selector:**  
Selector for call waiting service.
- ② **RINGS (Number of Rings) Selector:**  
Used to select the number of rings that it takes for the unit to answer.
- ③ **Telephone Line Jack**
- ④ **DC IN Jack**
- ⑤ **DIALING MODE Selector:**  
Used to change the dialing mode TONE or PULSE.
- ⑥ **RINGER (Ringer volume) Selector:**  
Used to select the ringer volume HIGH, LOW or OFF.
- ⑦ **VOLUME Control:**  
Used to adjust the sound level for the built-in-speaker.
- ⑧ **REMOTE CODE**  
A remote code number is indicated on the label.

# Inserting the Tape

**1** Open the cover.

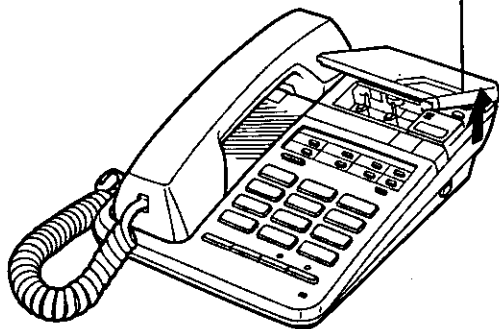

**2** Insert the cassette tape.  
(MC-30)

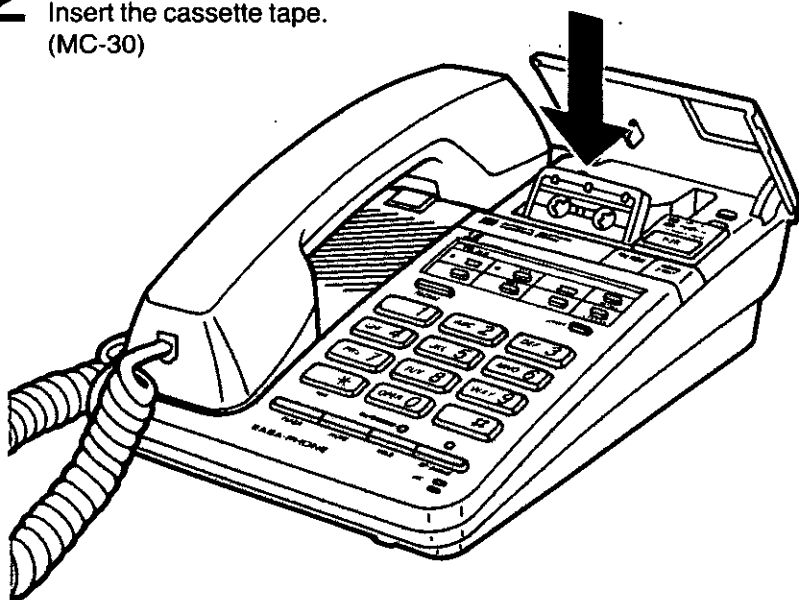

# Connection

Do not use any handset other than Panasonic handset for model KX-T2395/KX-T2395D-W.

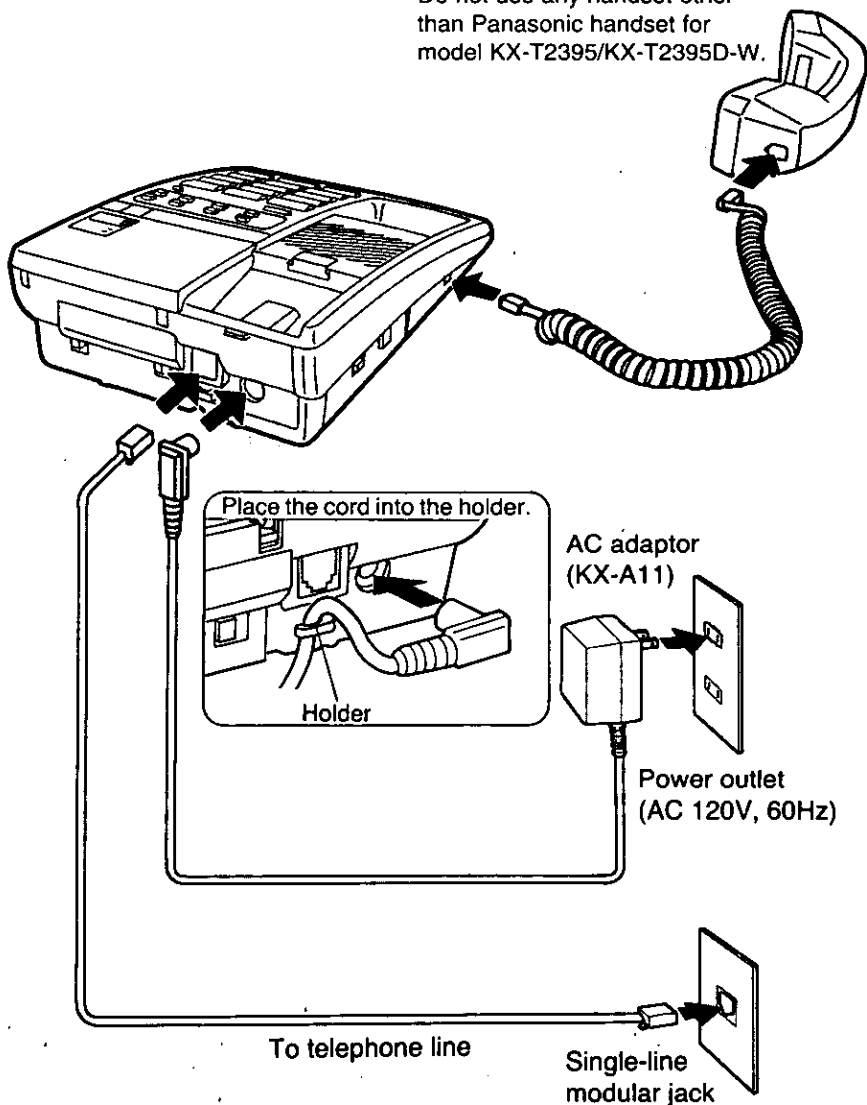

- Be sure to insert the tape before connecting the AC adaptor.
- USE ONLY Panasonic AC ADAPTOR KX-A11. If a power failure takes place, the unit can be used as a regular telephone.
- While operating the unit, the case of the AC adaptor may feel warm. This is a normal condition.

# Initial Settings

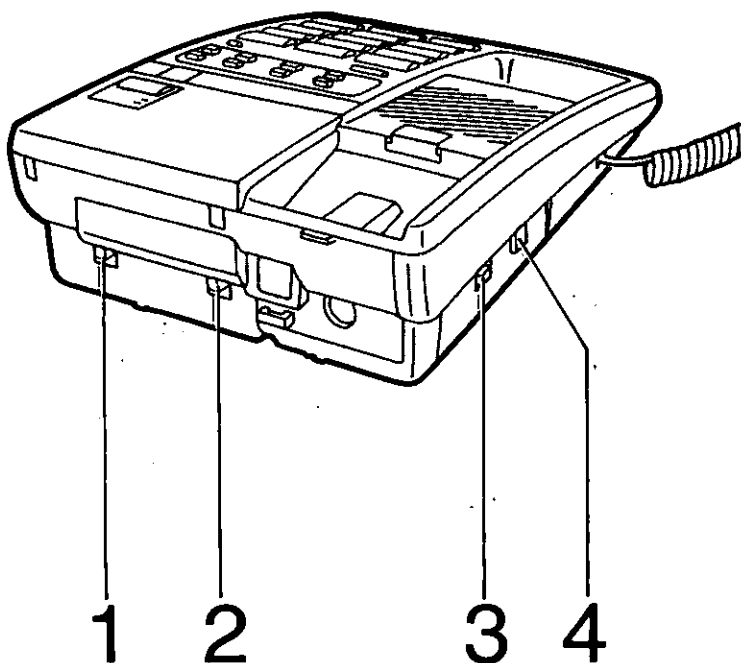

## Function of the AUTO setting (TOLL SAVER)

When you call the unit from an outside phone, the number of rings that it takes for the unit to answer tells you if there are any new messages.

- If the unit answers on the 3rd ring: There is at least one new message.
- If the unit answers on the 5th ring: There are no new messages. Hang up immediately when you hear the 4th ring. Because the 4th ring indicates there are no new messages. This will save you the toll charge for the call.

1

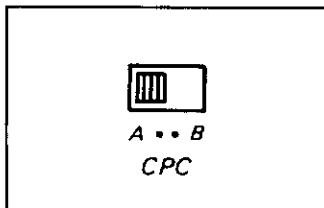

**CPC Selector**

- A:** Use this setting if your telephone line does not have call waiting service.
- B:** Use this setting if your telephone line has call waiting service.

If some Incoming Messages are cut off in position A, set to position B.

2

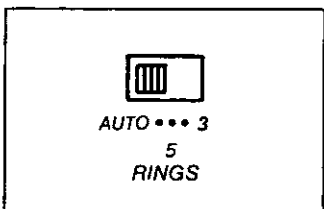

**RINGS Selector**

- AUTO:** See AUTO setting.
- 3:** The unit answers on the 3rd ring.
- 5:** The unit answers on the 5th ring.

3

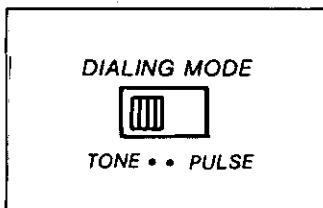

**DIALING MODE Selector**

Set to "TONE".  
Set to "PULSE" when you have rotary telephone service.

4

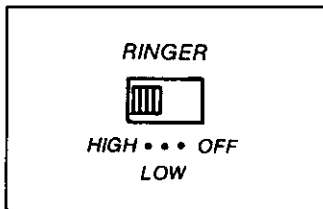

**RINGER Selector**

- HIGH:** The ringing sound will be high.
- LOW:** The ringing sound will be low.
- OFF:** The telephone will not ring.

# Recording an Outgoing Message (OGM)

The OGM tells the caller that you are out, and asks to leave a message.

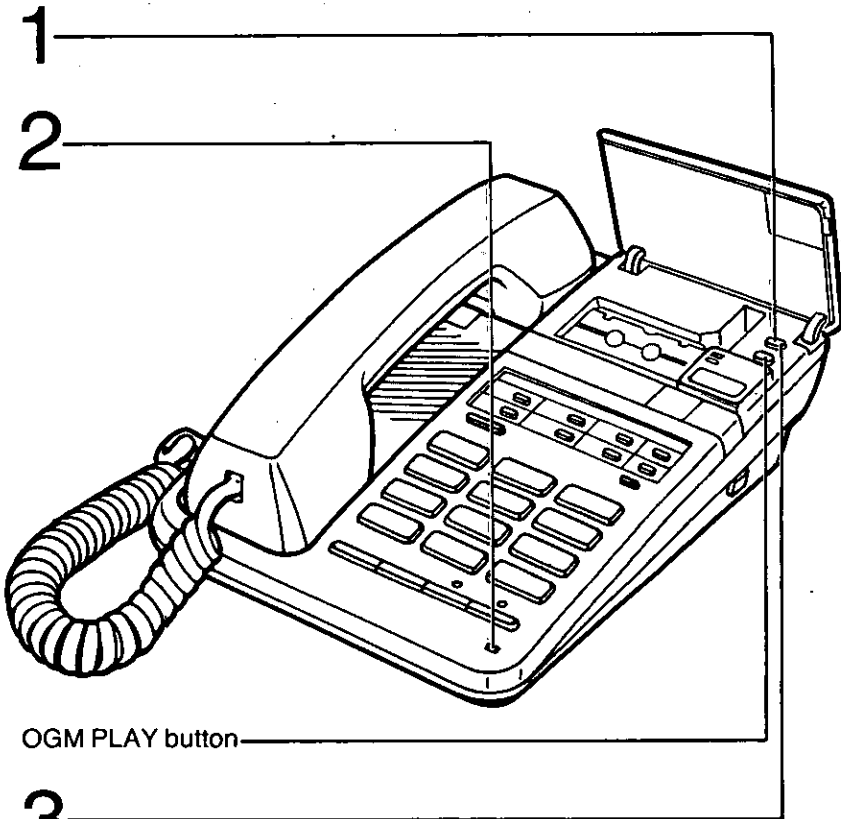

OGM PLAY button

3

### When recording your OGM:

- Please record the bold-faced sentence surely on the OGM.
- The caller's recording time is up to 60 seconds.
- A series of short beeps will be heard while the tape is preparing for recording, and a long beep means the tape is ready.

### Sample OGM

"Hello, this is Dick Smith. I'm out now, but if you leave a message I'll call you back. **You will hear a series of short beeps then a long beep will be heard. Speak after the long beep. You have 60 seconds.**"



Press the ANS SYS ON/OFF switch to turn on the unit.  
 (The PWR/IN USE indicator light is on.)  
 Your OGM can be up to 30 seconds long.

1

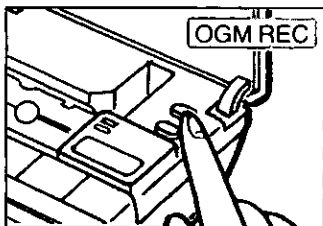

Press the OGM REC button, then release it.

A series of short beeps will be heard, followed by a long beep and the PWR/IN USE indicator flashes.

2



Speak loudly and clearly right after the long beep, about 20 cm (8") away from the microphone.

Do not pause for over 2 seconds. If 6 beeps sound, start over from step 1 again.

3

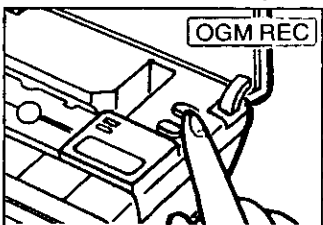

Press the OGM REC button again when you finish recording. The tape rewinds, and the unit will be ready to answer incoming calls after 10 seconds.

## Checking your recorded OGM

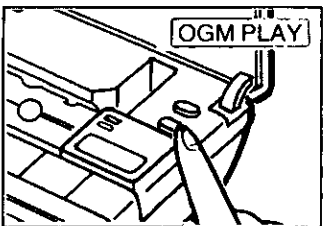

Press the OGM PLAY button to listen to your recorded OGM.

Press the OGM PLAY button again if you want to stop the operation halfway. The unit will be ready to answer incoming calls after 10 seconds.

### NOTE:

When you use the other side of the tape, please record the Outgoing Message again.

# Making and Answering Calls

## Making calls using the handset

1. Lift the handset.
2. Dial the telephone number.

You can switch to the speakerphone at any time by pressing the SP-PHONE button. You can place the handset on the cradle.

## Making calls using the SP-PHONE button (on-hook dialing)

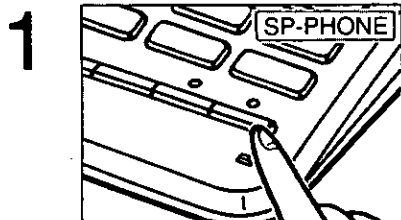

Press the SP-PHONE button, and dial the telephone number.

The SP-PHONE indicator light is on.

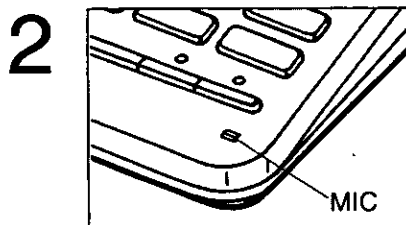

Speak to the other party through the microphone.

Press the SP-PHONE button again when you finish. The SP-PHONE indicator light is off.

You can also switch to the handset at any time by lifting the handset.

### Helpful hints

- **When the other party finds it difficult to hear your voice:** Lower the sound level using the speaker volume control or speak louder.
- **Absorbing echo:** Use in a room which has curtain or carpeting.
- **Avoiding lost or broken conversation:** If you and the caller speak at the same time, parts of your conversation will be lost. To avoid this, speak alternately.

## Redialing

Your telephone can redial the last dialed phone number . This number may be up to 30 digits.

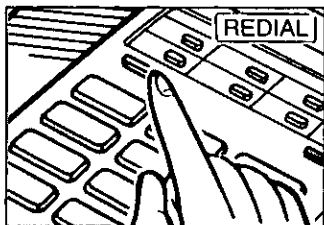

Lift the handset or press the SP-PHONE button, then press the REDIAL button.

You can redial once.

## Answering calls

When the telephone rings, lift the handset or press the SP-PHONE button and speak to the calling party.

# Automatic Dialing

Before using the automatic dialing feature, store the telephone numbers into memory. Refer to "Storing the telephone numbers" on pages 14 to 15.

## Making calls using the upper memory location:

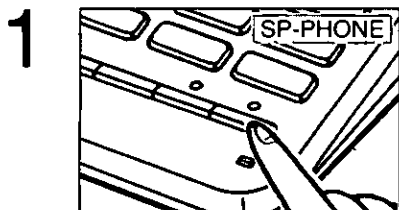

Lift the handset or press the SP-PHONE button.



Press the direct call button (one-touch key) in which the number you want to dial is stored.

## Making calls using the lower memory location:

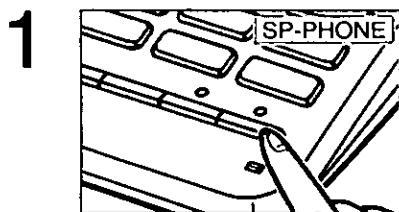

Lift the handset or press the SP-PHONE button.

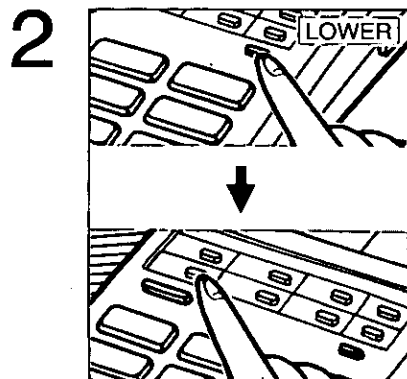

Press the LOWER button, then press the direct call button (one-touch key) in which the number you want to dial is stored.

If you press the LOWER button by mistake when you want to use the upper location, you must hang up and then dial again.

## Storing the telephone numbers

There are 6 direct call buttons. Each button consists of upper and lower memory locations. Each location (upper and lower) is capable of storing 16 digits. Be sure that the handset is on the cradle, the SP-PHONE indicator is off and the AC adaptor is connected. When you store a telephone number into memory, pressing the #, \*, PAUSE, or FLASH button counts as 1 digit.

### Into the upper memory location

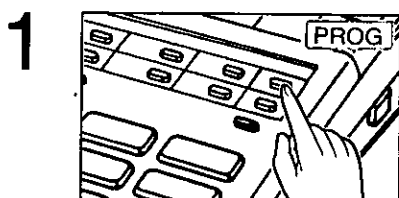

Press the PROG button.

The STORE indicator light is on.



Press the direct call button (one-touch key) in which you want to store the telephone number.

The STORE indicator light goes out.

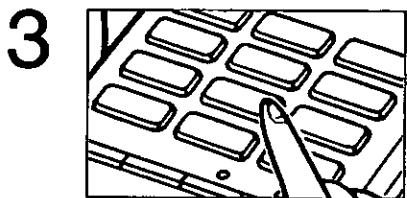

Dial the telephone number that you want to store, up to 16 digits.

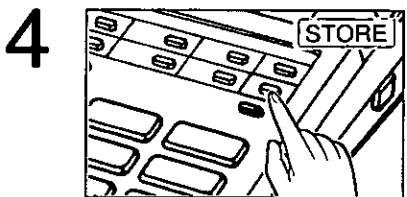

Press the STORE button.

The STORE indicator light is on. To store other numbers in succession, repeat from step 2.



Press the PROG button after storing all the numbers.

The STORE indicator light goes out.

# TELEPHONE

## Into the lower memory location

1

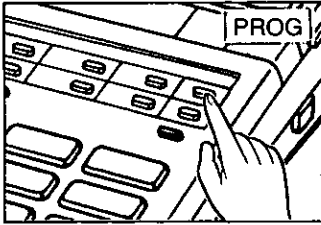

Press the PROG button.

The STORE indicator light is on.

2

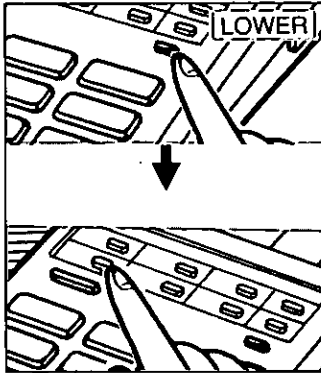

Press the LOWER button, then press the direct call button (one-touch key) in which you want to store the telephone number.

The STORE indicator light goes out.

3

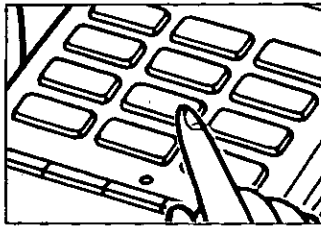

Dial the telephone number that you want to store, up to 16 digits.

4

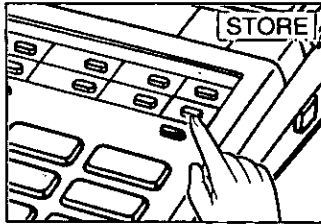

Press the STORE button.

The STORE indicator light is on. To store other numbers in succession, repeat from step 2.

5

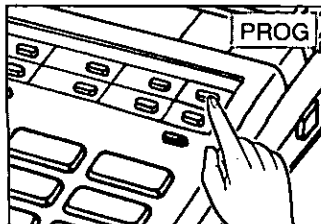

Press the PROG button after storing all the numbers.

The STORE indicator light goes out.

## Correcting an error while storing

If you notice an error before pressing the STORE button;

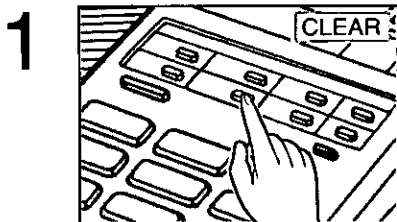

Press the CLEAR button.

The new entry will be cleared and previous storage will remain untouched.

Start over again from step 2 of the storing procedure.

## Confirming a stored number

Repeat storing the same number into the same station. When the STORE button is pressed, the MEMORY indicator flashes and you hear a beep.

- Twice: The entry is the same as what was previously stored.
- Once: The entry is different from the one that was previously stored.  
Repeat the storing procedure.

### NOTE:

In case that the AC adaptor is unplugged for more than 10 minutes, the stored telephone numbers should be confirmed before dialing.

## Erasing a stored number

1. Press the PROG button.
2. Press the direct call button where the telephone number to be erased is stored.
3. Press the STORE button.
4. Press the PROG button.

# Other Operation

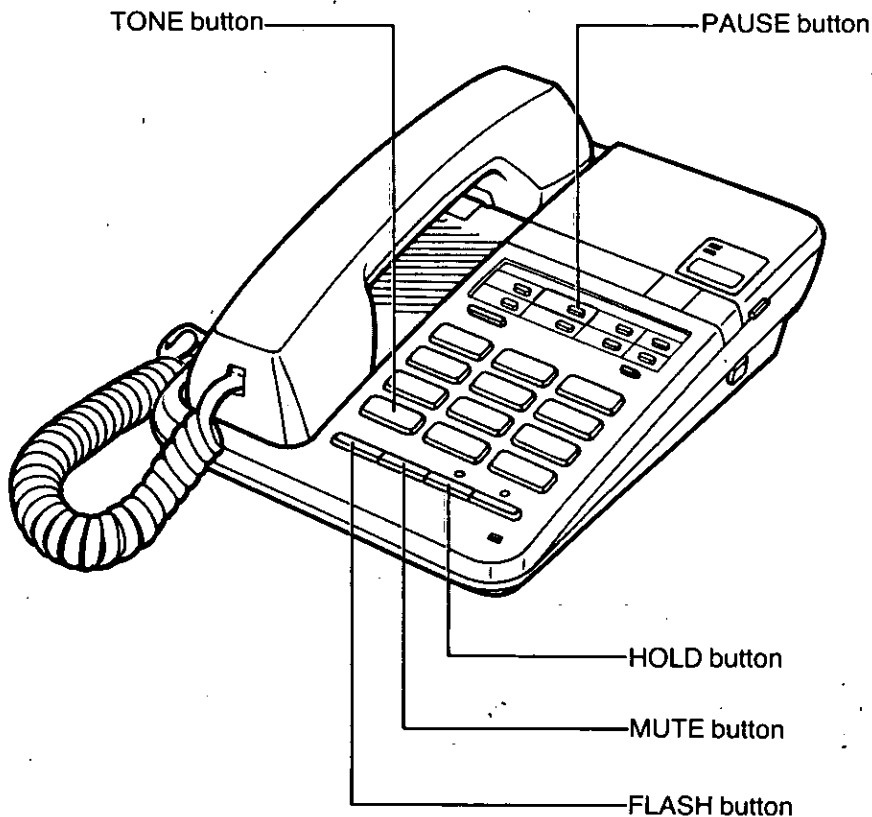

## Hold

The HOLD button is used to place a call on hold while having a conversation.

Press the HOLD button while having a conversation.  
The HOLD indicator flashes.

You may place the handset on the cradle.

## Releasing a hold

- If the handset is off-hook, press the HOLD button again.
- If the handset is on the cradle (on-hook), lift the handset or press the SP-PHONE button.
- When using another telephone connected on the same line; Lift the handset of the other telephone. If the hold is not released, press the hookswitch of the other telephone for about one second.



## Flash

The FLASH button is used to access special telephone services such as call waiting service or call forwarding. While having a conversation, another party calls and you hear a tone, press the FLASH button. The first conversation is placed on hold and the second call can be answered. To speak to the first caller again, press the FLASH button again. (The second caller is placed on hold.)

You may access some of features of your host PBX using the FLASH button in a dialing operation.

## Mute

The MUTE button is used when you do not want your voice to be heard by the other party. The other party's voice can be heard.

Press the MUTE button. The MUTE/STORE indicator light is on. To resume the conversation, press the MUTE button again.

## Tone

Use the TONE button when you have rotary telephone service. Pressing it will allow you to change from pulse to tone mode during a dialing operation, and enter special tones and codes to operate answering machines, electronic banking services and other special services.

## Pause

The pause button is helpful in the automatic dialing when accessing an outside line. To use this function, store "PAUSE" with the telephone number into the memory station beforehand.

While storing the telephone number into the memory, **one pause is required when waiting for an outside dial tone.**

### Example:

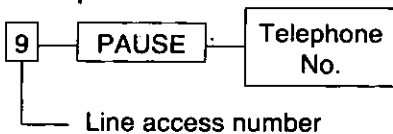

Press once (3.5-second pause)  
Press twice (7-second pause)

## Combination dialing

A telephone number with more than 30 digits can be stored into two memory stations. Dialing is done as follows:

1. Lift the handset.
2. Press the direct call button "1".
3. Press the direct call button "2".

Instead of using two memory stations, you can store a part of the telephone number into one memory station, and the other part can be dialed manually.

1. Lift the handset.
2. Press the station key, wait for dialing to stop, then dial manually.

# Setting up for Answering Calls

Press the ANS SYS ON/OFF switch to turn on the unit.  
The PWR/IN USE indicator light is on. After 10 seconds, the ANS/CALLS indicator light is on and the unit will be set to answer the calls. (Answer mode)

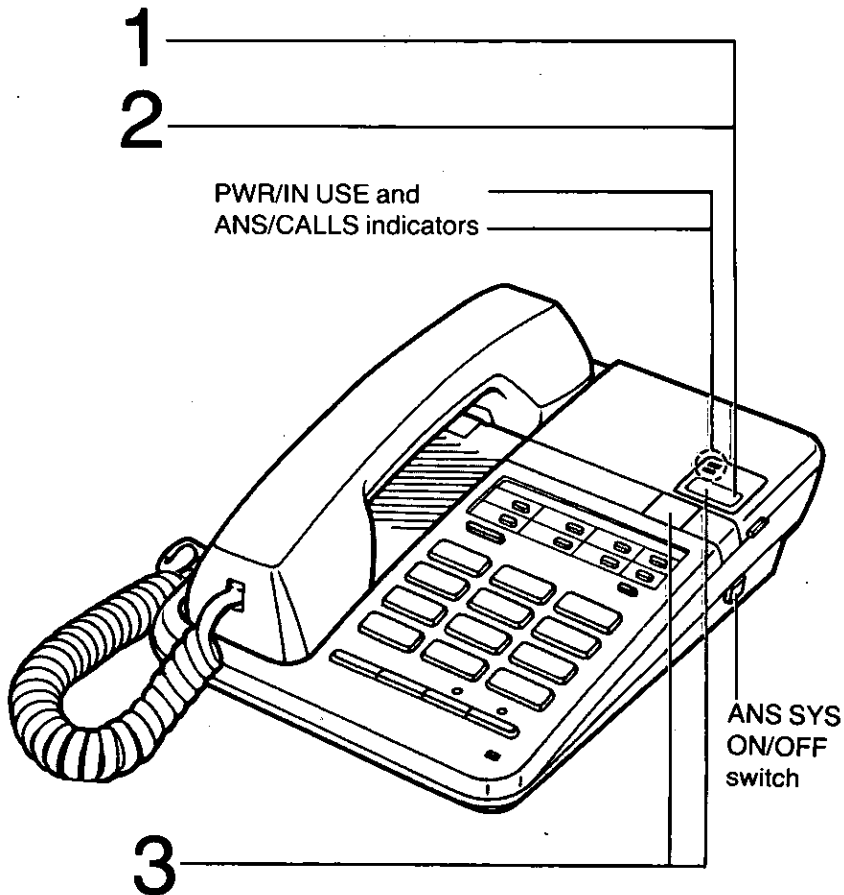

- **Answer mode**  
When a call is received, the unit answers the call and record the Incoming Message.
- If you do not want the unit to answer the calls, press the ANS SYS ON/OFF button to turn off the unit. The ANS/CALLS indicator light goes out.
- The caller's recording time is limited up to 60 seconds.

## Recording from the beginning of the ICM part of the tape

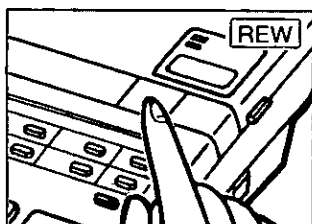

Press the REW button until the unit stops rewinding (a beep sounds), then release it  
or  
after ICM playback, leave the unit as it is.  
The unit has been reset to the answer mode.

## Recording after the messages you want to save

When you want to record the next Incoming Messages (ICMs) after the last recorded message, or after a desired position of the tape:

1

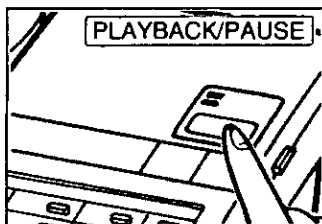

Press the PLAYBACK/PAUSE button to play back the tape to the end of the message you want to save.

2

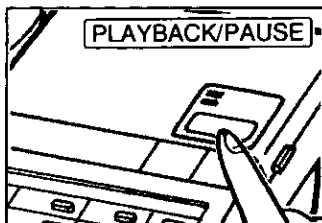

Press the PLAYBACK/PAUSE button again to pause the unit.

The PWR/IN USE indicator flashes. (pause mode)

3

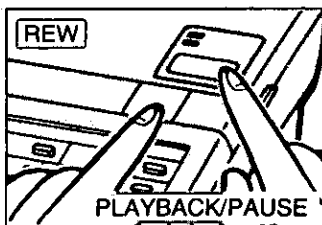

Press the REW button and the PLAYBACK/PAUSE button simultaneously.

The PWR/IN USE indicator and the ANS/CALLS indicator lights are on. New calls will be recorded after the message(s) you have saved.

# Listening to Recorded Messages

When an Incoming Message has been recorded, the ANS/CALLS indicator will flash in groups. The amount of flashes indicates the number of calls received up to 15 times. (Three flashes followed by a pause means that 3 messages were received.)

In case of power interruption, the indicator will flash slowly.

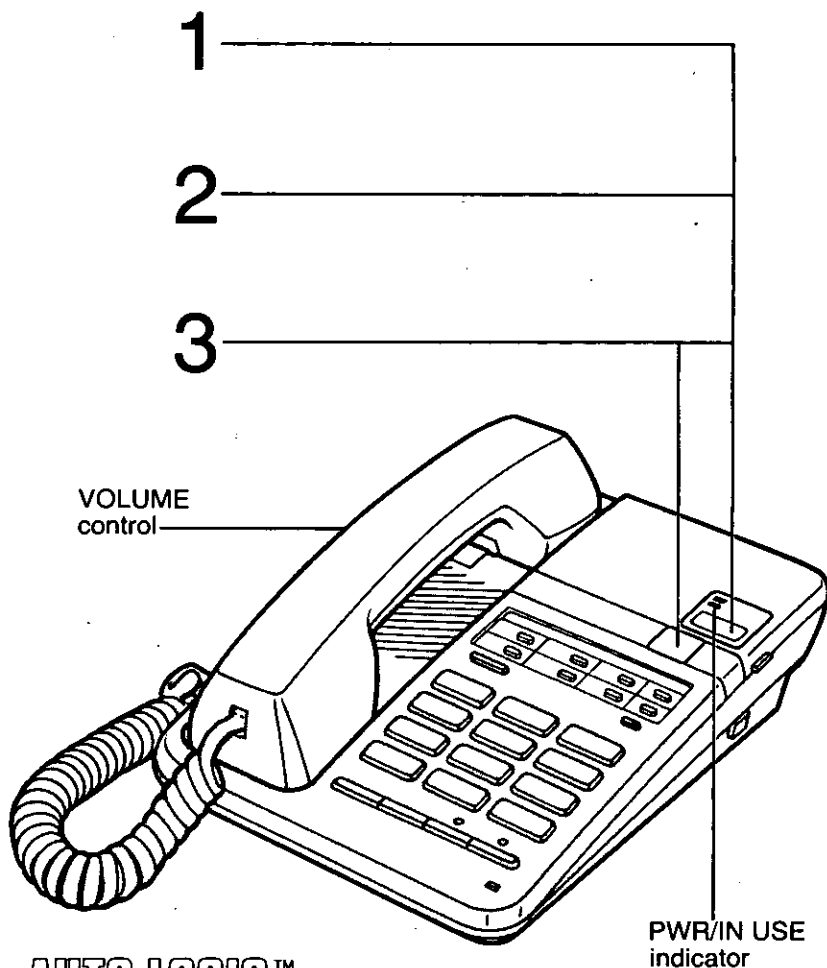

## **AUTO-LOGIC™ (One-Touch Operation)**

At the touch of the **PLAYBACK/PAUSE** button, the unit will automatically rewinds and play back all the recorded messages. 10 seconds after playback, the unit will rewind, reset the tape and record incoming calls automatically.

## Playing back the tape from the beginning

1

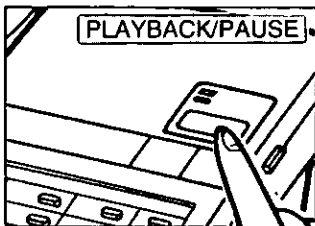

Press the PLAYBACK/PAUSE button to play back the messages from the beginning.

Adjust volume, if needed. 3 beeps will be heard indicating the end of the last message. After 10 seconds, the unit will rewind the tape and the next Incoming Message will be recorded from the beginning of the ICM part of the tape.

2

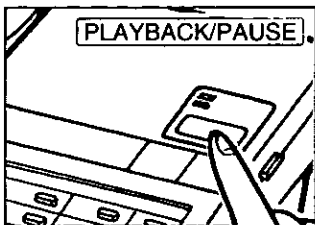

Press the PLAYBACK/PAUSE button to stop the tape (pause mode).

The PWR/IN USE indicator flashes. Press the PLAYBACK/PAUSE button again to restart playback.

3

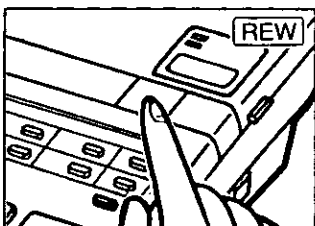

Press the REW button to rewind the tape to the desired location.

The unit will play back the message again after you release the REW button.

If you keep pressing the REW button until the unit rewinds to the beginning of the tape, a beep will be heard. In this case, the unit has been reset to the answer mode.

# Remote Operation

You can retrieve the recorded Incoming Messages from a remote location with a tone phone by simply pressing your own remote code number.

## The remote code number

A remote code number for you is preset and indicated on the bottom of the unit.

## Playing back all the messages

1



Call your unit.

2

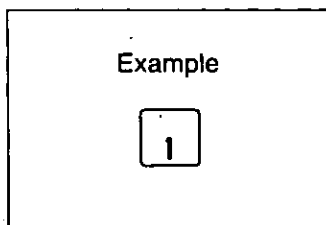

Dial your code number for 1~2 seconds while the OGM is playing.

The unit plays back all the recorded messages.  
To rewind during playback, dial the code number for 1~2 seconds. The tape will rewind for approximately 15 seconds corresponding to the playback time.  
After the last message, 3 beeps will sound and you may hang up. Messages are automatically saved after hanging up.

## Resetting the tape for future message

After listening to the messages, you can reset the tape and record new messages from the beginning of the ICM part of the tape.

1



Wait for 3 beeps after the last message.

2

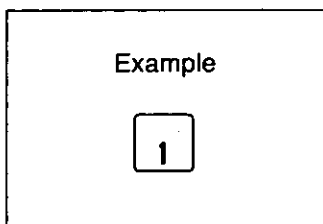

Dial the code number within 10 seconds of hearing 3 beeps.

The unit will rewind the tape to the beginning. Future messages will be recorded and the old messages will be erased.

## Recording a marker message

After listening to all your messages, you can record a message on the same call. When replay is finished, wait for 3 beeps indicating the end of the last message. Then wait about 10 seconds for another 2 beeps indicating that the tape is ready for recording. Record your message after the last 2 beeps.

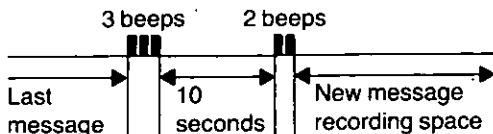

Hang up when finished:

## Setting answer mode remotely

You can easily set the unit to answer mode from a remote telephone.

1. Call your unit and let the telephone ring 15 times.
2. The unit will answer, and the OGM will be heard. You may hang up. The unit will be ready to answer the next phone call.

# Other Features

## Recording a memo message

If you want to leave a memo message for someone, you can record it on the tape. It can then be played back either manually or remotely just like any other Incoming Messages.



1

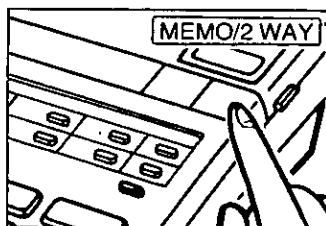

Press the MEMO/2 WAY button until a beep sounds.

A series of short beeps will be heard, followed by a long beep, and the PWR/IN USE indicator flashes.

2



Speak loudly and clearly right after the long beep, about 20 cm (8") away from the microphone.

3

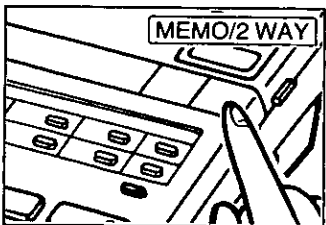

Press the MEMO/2 WAY button again when you finish recording.

The PWR/IN USE indicator light is on and the ANS/CALLS indicator flashes to show that your message was recorded, and the unit will be ready to answer incoming calls.



## Recording a conversation (2-Way Recording)

You can record a telephone conversation.

Many states have imposed regulations on the manner in which 2-Way telephone conversations may be recorded. Consult your local public utility agency (your telephone company).

1

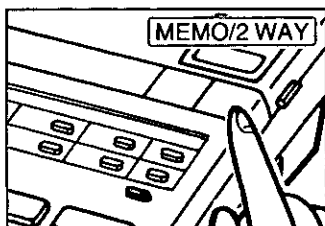

Press the MEMO/2 WAY button until a beep sounds, and continue speaking.

The PWR/IN USE indicator flashes and the ANS/CALLS indicator light is on.

A beep will be heard every 15 seconds.

2

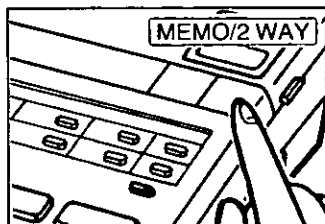

Press the MEMO/2 WAY button again when you finish recording.

The PWR/IN USE indicator light is on and the ANS/CALLS indicator flashes to show that the conversation was recorded, and the unit will be ready to answer incoming calls.

The recorded conversation can be played back with other Incoming Messages by pressing the PLAYBACK/PAUSE button.

## Screening incoming calls

You may leave the unit in answer mode even when you are around. In this case, after the unit has answered, you will screen the caller speaking. You can interrupt the recording and speak to the caller by simply lifting the handset or pressing the SP-PHONE button.

The unit will automatically stop recording.

- Adjust the VOLUME control if needed.
- After hanging up, the unit will be ready to answer the next phone call.

# Troubleshooting Guide

<b>Problem</b>	<b>Cause &amp; Remedy</b>
The unit does not work when I press any buttons.	<ul style="list-style-type: none"> <li>● Plug in the AC adaptor.</li> <li>● Press the ANS SYS ON/OFF switch to turn on the unit.</li> </ul>
I try to store the telephone number into memory station, but the storing procedure cannot be done.	<ul style="list-style-type: none"> <li>● Be sure that the AC adaptor is connected.</li> </ul>
The unit has been set to answer mode, but no Incoming Messages are recorded.	<ul style="list-style-type: none"> <li>● The cassette tape is cut or is not inserted. Insert the tape or replace it with a new one.</li> </ul>
The OGM is recorded improperly. Record a new OGM. The unit does not function. However a beep sounds six times and the ANS /CALLS indicator flashes.	<ul style="list-style-type: none"> <li>● The cassette tape might be broken. Replace it with a new one.</li> <li>● Clean the heads. (See page 31.)</li> </ul>
While recording an OGM, a beep sounds six times.	<ul style="list-style-type: none"> <li>● Re-record your OGM. Speak clearly and loudly, and do not pause for over 2 seconds while recording.</li> </ul>
When the cassette tape is played back, the sound level is low, even if the VOLUME control is turned up fully.	<ul style="list-style-type: none"> <li>● Clean the heads. (See page 31.)</li> </ul>
I have played back all the recorded messages and I want to record the next phone call after the last previously recorded messages.	<ul style="list-style-type: none"> <li>● Save the recorded messages. (See page 20.)</li> <li>● In case of remote operation, just hang up.</li> </ul>

---

<b>Problem</b>	<b>Cause &amp; Remedy</b>
I press the button from a remote touch tone telephone, but the unit does not respond.	<ul style="list-style-type: none"><li>• Make sure that you are entering your correct remote code number.</li><li>• Record the OGM in a quiet place.</li><li>• In some areas, a remote touch tone phone may not function due to telephone line conditions such as line noise, echo, etc.</li><li>• The unit may not respond if a touch tone telephone produces tones that are too short to activate the unit. When you press any button, press firmly.</li></ul>
Some ICMs have not been recorded up to their end.	<ul style="list-style-type: none"><li>• Set the CPC switch to "B". (See page 8.)</li></ul>
The unit does not ring.	<ul style="list-style-type: none"><li>• Ringer volume selector is set to "OFF". Set to "HIGH" or "LOW".</li></ul>

---

# Wall Mounting

The unit can be mounted on a wall phone plate. If you do not have a modular wall phone plate installed, we recommend that you consult with your telephone company or an installer.

1

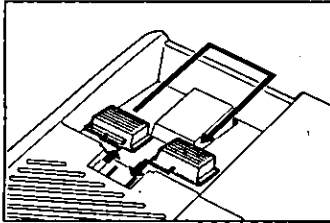

Turn around the handset hook.

2

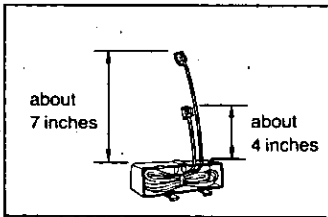

Insert the telephone cord as shown.

3

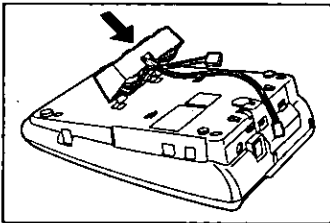

Place the wall mount adaptor as shown.

4

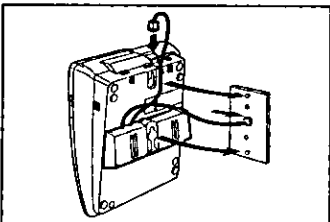

Mount the unit eyelets as shown.

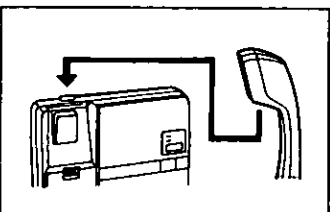

To temporarily place the handset down during a conversation, place as shown.

# Accessory Order Information

Replacement parts and accessories are available through your local authorized parts distributor.

For accessory order, call toll free 1-800-332-5368.

Part No.	Description	Comment
RT-MC30 RT-MC60	Microcassette	
KX-J07W KX-J15W KX-J25W	Handset Cord	7 feet 15 feet 25 feet
KX-J66	T-adaptor	Parallel connection for single line



**KX-T2395**  
**QUICK REFERENCE CARD**  
 FOR TONE REMOTE CONTROL

- To set to the answer mode remotely.
1. Dial the phone number and wait for 15 rings.
    - The unit will set to the answer mode, and will play the OGM.
  2. Hang up the handset.

# Maintenance

Because the head and capstan assemblies are in contact with the tape, dirt and residue from the tape can easily adhere to these parts, causing distortion. These parts should be cleaned periodically in the manner described below.

**Clean the head surface, pinch roller and capstan with a cotton swab.** If these surfaces are extremely dirty, dampen the cotton swab with alcohol.

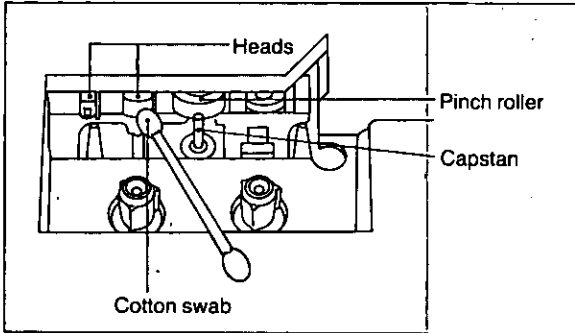

- Do not place magnetic or metal objects, such as a screwdriver, near the head assemblies, as such objects could magnetize the heads.
- Do not oil any part of the unit.

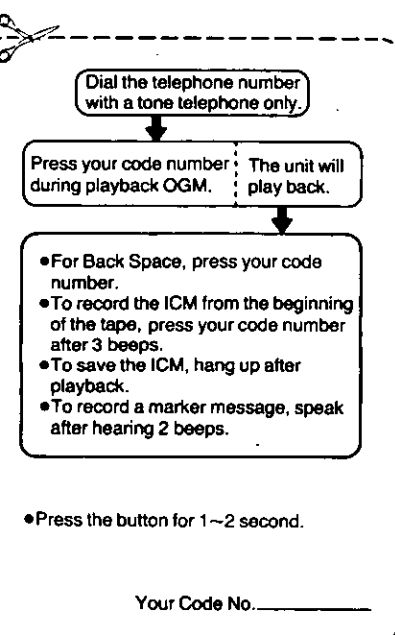

• Press the button for 1~2 second.

Your Code No. \_\_\_\_\_

### Cassette tape

- For optimum sound quality and performance, we recommend that you **use side two after six months and replace the tape every year** assuming that the unit answers about ten calls a day.
- Never place a cassette tape near a magnetic source, such as a magnet or a TV set, because it may erase the tape.
- Slack in the tape can be tightened by rotating the tape reel with an instrument like a pencil, as shown.

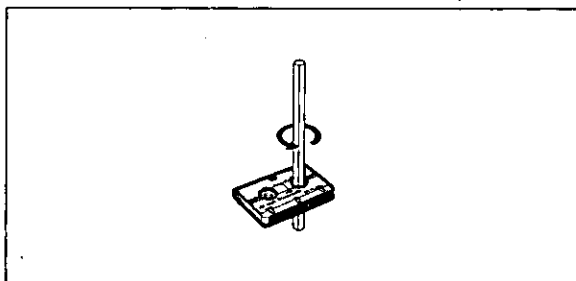

### Cassette panel installation

If the panel comes off, place it back it by pushing as shown.

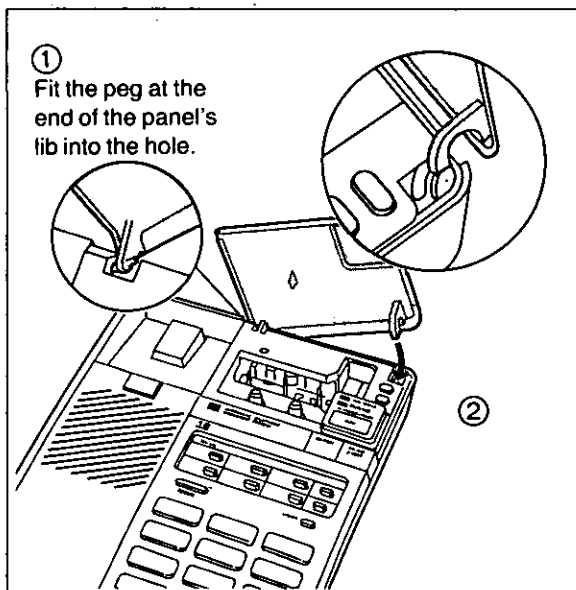

# Precaution

## Note:

This equipment has been tested and found to comply with the limits for a Class B digital device, pursuant to Part 15 of the FCC Rules. These limits are designed to provide reasonable protection against harmful interference in a residential installation. This equipment generates, uses, and can radiate radio frequency energy and, if not installed and used in accordance with the instructions, may cause harmful interference to radio communications. However, there is no guarantee that interference will not occur in a particular installation. If this equipment does cause harmful interference to radio or television reception, which can be determined by turning the equipment off and on, the user is encouraged to try to correct the interference by one or more of the following measures:

- Reorient or relocate the receiving antenna.
- Increase the separation between the equipment and receiver.
- Connect the equipment into an outlet on a circuit different from that to which the receiver is connected.
- Consult the dealer or an experienced radio/TV technician for help.

- **Environment**—do not place the unit in rooms where the temperature is less than 5°C (41°F) or greater than 40°C (104°F). Allow 10 cm (4") clearance around the unit for proper ventilation. Avoid excessive smoke, dust, mechanical vibration, shock, or direct sunlight.
- **Routine care**—wipe the unit with a soft cloth. Do not use benzene, thinner, or any abrasive powder. When you left the unit unused for long time, unplug the AC adaptor from the outlet.
- **If there is any trouble**—disconnect the unit from the telephone line and connect a known working phone. If the known working phone operates properly, have your unit repaired by one of the authorized Panasonic Factory Service Centers. If the known working phone does not operate properly, consult with your telephone company.



# Important Information

If requested by the telephone company, inform them as follows:

- FCC Registration No.  
(found on the bottom of the unit)
- Ringer Equivalence . . . . . 1.0B
- The particular telephone line to which the equipment is connected.

This unit must not be connected to a coin operated line.

If you are on a party line, check with your local telephone company.

## **Ringer Equivalence No. (REN):**

The REN is useful in determining the quantity of devices you may connect to your telephone line and still have all of those devices ring when your telephone number is called. In most, but not all areas, the sum of the REN's of all devices connected to one line should not exceed five (5.0). To be certain of the number of devices you may connect to your line, as determined by the REN, you should contact your local telephone company to determine the maximum REN for your calling area.

In the event terminal equipment causes harm to the telephone network, the telephone company should notify the customer, if possible, that service may be stopped.

However, where prior notice is impractical, the company may temporarily cease service providing that they:

- (a) Promptly notify the customer.
- (b) Give the customer an opportunity to correct the problem with their equipment.
- (c) Inform the customer of the right to bring a complaint to the Federal Communication Commission pursuant to procedures set out in FCC Rules and Regulations Subpart E of Part 68.

The Telephone Company may make changes in its communications facilities, equipment, operations or procedures, where such action is reasonably required in the operation of its business and is not inconsistent with the rules and regulations in FCC Part 68.

If such changes can be reasonably expected to render any customer terminal equipment incompatible with telephone company communications facilities, or require modification or alteration of such terminal equipment, or otherwise materially affect its use or performance, the customer shall be given adequate notice in writing, to allow the customer an opportunity to maintain uninterrupted service.

## **CAUTION:**

Any changes or modifications not expressly approved by the party responsible for compliance could void the user's authority to operate this device.

When programming emergency numbers and/or making test calls to emergency numbers:

1. Remain on the line and briefly explain to the dispatcher the reason for the call before hanging up.
2. Perform such activities in the off-peak hours, such as early morning hours or late evenings.

## **WARNING:**

**TO PREVENT FIRE OR SHOCK HAZARD, DO NOT EXPOSE THIS PRODUCT TO RAIN OR ANY TYPE OF MOISTURE.**

**This telephone provides magnetic coupling to hearing aids.**

# Referencia Rápida

## Localización de controles

Botón de Grabación del OGM  
(OGM REC)

Botón de Reproducción del OGM  
(OGM PLAY)

Botón de Reproducción/Pausa  
(PLAYBACK/PAUSE)

Botón de Memoria/Bidireccional  
(MEMO/2 WAY)

Botón de Rebobinado (REW)

Botón de Rediscado  
(REDIAL)

Conmutador de SIST. DE  
RESPUESTAS  
ENCENDIDO/APAGADO  
(ANS SYS ON/OFF)

Botón de Programa  
(PROG)

Botón de Almacenamiento  
(STORE)

Botón INFERIOR  
(LOWER)

Botón de Pausa  
(PAUSE)

Botón de Despeje  
(CLEAR)

Botón de Destello  
(FLASH)

Botón de silenciador  
(MUTE)

Botón de Retención  
(HOLD)

Botón del altavoz  
(SP-PHONE)

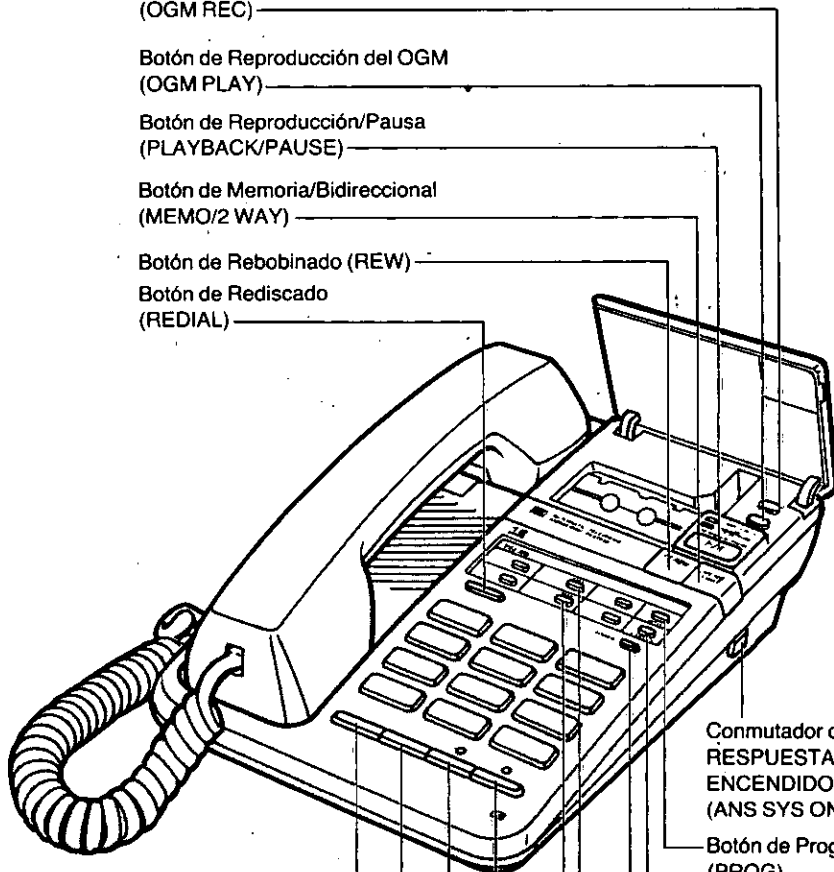

## Conexión

Introduzca la cinta de casete.

Microteléfono

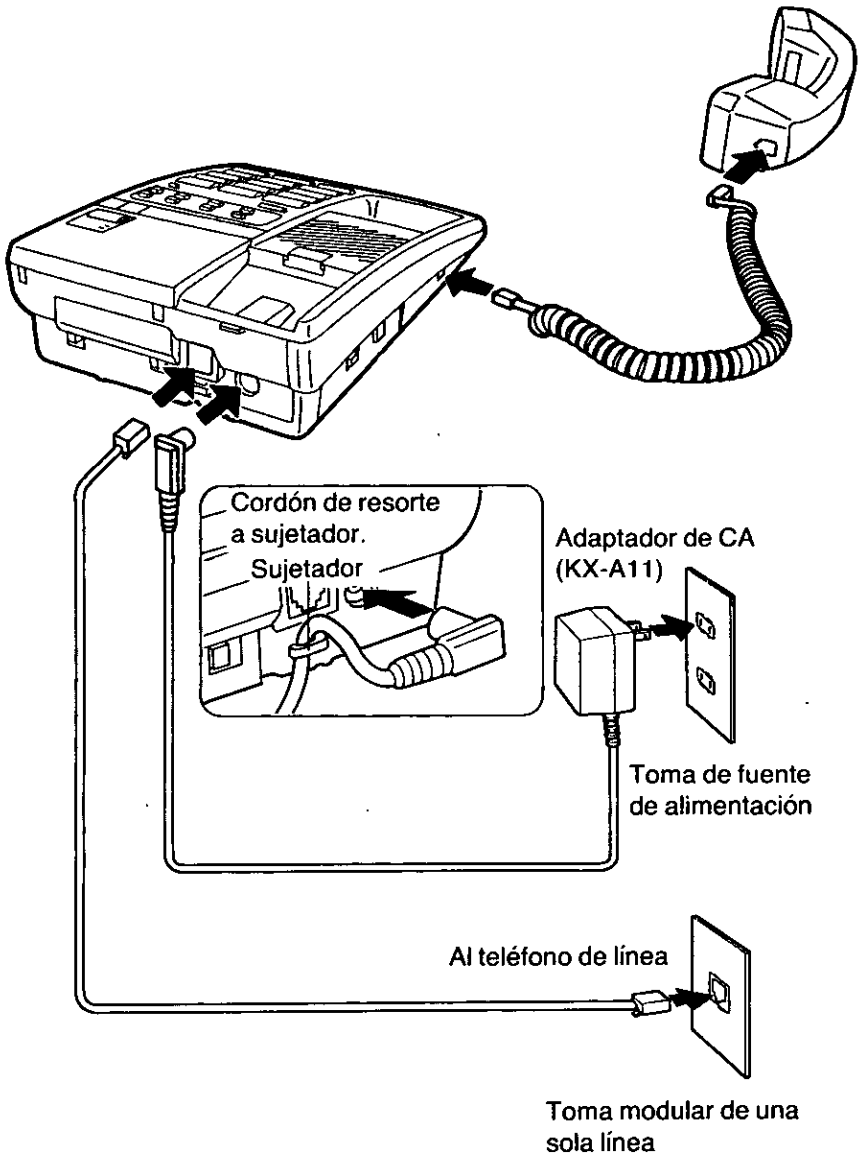

■ Utilice sólo Adaptador de CA KX-A11, Panasonic.

## Procedimiento inicial

1. Conmutador de Alimentación (ANS SYS ON/OFF)  
Presione el conmutador ANS SYS ON/OFF para encender el aparato.  
(El indicador de Alimentación/En Uso se enciende.)
2. Selector CPC (Control del Usuario que Llama)  
**A:** Seleccione esta posición si su teléfono de línea no tiene servicio de espera de llamadas.  
**B:** Seleccione esta posición si su teléfono de línea tiene servicio de espera de llamadas.
3. Número de repiques  
**AUTO:** Vea la casilla de "Economizador de llamadas".  
**3:** Contesta al (tercer) repique.  
**5:** Contesta al (quinto) repique.
4. Selector de Modalidad de Discado  
Colocar en "**TONE**".  
Colocar en la posición de pulso si su servicio es de teléfono rotatorio.
5. Selector de Volumen de Timbre  
**HIGH (ALTO):** El volumen del timbre será alto.  
**LOW (BAJO):** El volumen del timbre será bajo.  
**OFF (APAGADO):** El teléfono no sonará.
6. Código Remoto  
Está pre-seleccionado un número de código remoto para las operaciones remotas e impreso en la base del aparato.

### Economizador de llamadas

La función de ahorro de llamadas le permite ahorrar en la cuenta de llamadas cuando Ud. llame a su propio aparato, en el caso de que no hayan sido grabados mensajes. Coloque el número de llamadas en "AUTO".

- respuesta al tercer timbre . . . . por lo menos un nuevo mensaje ha sido grabado.
  - respuesta al quinto timbre . . . . no ha sido grabado ningún mensaje.
- Cuando Ud. llame a su aparato y no haya mensaje grabado, Ud. puede ahorrar en la cuenta de llamadas telefónicas. Después de escuchar el cuarto timbre, cuelgue inmediatamente. Habrá ahorrado una llamada.

## Grabación del OGM (Mensaje de Salida)

El OGM le comunica a la persona que llama que Ud. ha salido y le pide que deje un mensaje.

1

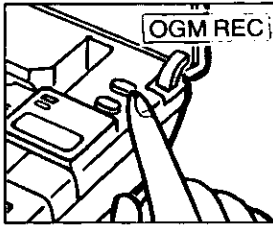

Presione el botón de Grabación del OGM y luego déjelo de presionar.

Se escuchará una serie de "bips" cortos seguidos de un "bip" prolongado y el indicador de Alimentación/En Uso destella.

2



Hable con voz alta y claramente inmediatamente después del "bip" a una distancia aproximada de 20 cm (8") del micrófono.

No haga pausas de más de 2 segundos durante la grabación. Si lo hace, sonará un "bip" seis veces. En este caso, vuelva al paso 1 y repita el procedimiento de nuevo.

3

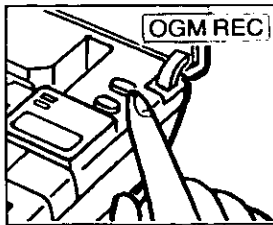

Presione el botón de Grabación del OGM de nuevo cuando haya terminado de grabar.

La cinta se rebobinará y el aparato estará listo para responder las llamadas de entrada después de 10 segundos.

## Llamadas

1. Levante el microteléfono o presione el botón SP-PHONE.
2. Marque el número telefónico.

## Contestación de Llama

Cuando el teléfono suene, levante el microteléfono y conteste la llamada.

## Rediscado

El botón REDIAL siempre almacena en la memoria el último número marcado, hasta un máximo de 30 dígitos. Para marcar el mismo número de nuevo, emplee esta función.

1. Levante el microteléfono o presione el botón SP-PHONE.
2. Presione el botón REDIAL.  
Ud. puede rediscar una vez.

## Retención

El botón HOLD es útil para mantener una llamada en retención durante el transcurso de una conversación.

Presione el botón HOLD mientras esté conversando.

### Para liberar la retención

- **Si el microteléfono está descolgado; presione HOLD y empiece a hablar.**
- **Se el microteléfono está colgado;** levante el microteléfono y empiece a hablar.
- **Cuando emplee otro teléfono conectado a la misma línea;** Levante el microteléfono del otro teléfono. Si no se libera la retención, presione el conmutador del otro teléfono por un segundo aproximadamente.

## Discado Automático

Discado de un solo toque (12 estaciones de memoria):

Hay 6 botones para llamada directas, cada uno con dos funciones. Son localizaciones de memoria superior e inferior (hasta 16 dígitos).

Asegúrese de que el microteléfono esté colgado y de que el botón del altavoz esté desconectado.

Levante el microteléfono y presione el botón de llamadas directas en la cual está almacenado el número que desea.

### Almacenamiento con discado de un-solo-toque

1. Presione el botón PROG.  
El indicador MUTE/STORE se ilumina.
2. Presione el botón de la estación.  
El indicador MUTE/STORE se apaga.
3. Marque el número telefónico que desee almacenar.  
Hasta un máximo de 16 dígitos.
4. Presione el botón STORE para almacenar el número en la memoria.  
El indicador MUTE/STORE se ilumina.  
Para almacenar otro número, repita el procedimiento desde el paso 2.
5. Después de almacenar todos los números, presione el botón PROG.  
El indicador MUTE/STORE se apaga.

### Empleo de la localización de la memoria LOWER (INFERIOR)

Otro número telefónico puede ser almacenado en la localización de la memoria LOWER de la misma estación de llamada directa. En este caso, Ud. debe modificar el paso 2 del procedimiento anterior.

Presione el botón LOWER, y luego presione el botón de llamada directa.

## Reproducción de los mensajes grabados

Cuando el teléfono suene, la unidad reproducirá el mensaje de salida (OGM) y luego grabará el mensaje de la persona que llama en la cinta. Presione el botón **PLAYBACK/PAUSE**.

### **AUTO-LÓGICO (Función de un solo toque)**

Un solo toque del botón **PLAYBACK/PAUSE** hace posible que la unidad reproduzca los mensajes y suene 3 pitidos después del último mensaje. Luego, después de diez segundos, la unidad rebobinará la cinta y estará lista para grabar nuevos mensajes desde el comienzo de la sección ICM de la cinta.

## Memorización del mensaje

Para grabar un mensaje que va a ser oído por alguien usando el control remoto.

1. Presione el botón **MEMO/2 WAY** hasta que suene un pitidos.
2. Hable por el **MIC**.
3. Cuando termine, pulse el botón **MEMO/2 WAY**.

## Para escuchar mensajes desde otro telefono a distancia

Ud. puede escuchar los mensajes grabados mediante la simple presión del número de código.

1. Marque el número de su teléfono y presione el número de código por uno o dos segundos en la modalidad de grabación **OGM**. La unidad rebobinará la cinta y Ud. escuchará todos los mensajes en la cinta. Se escucharán tres pitidos después del último mensaje.
2. Cuelgue. Los próximos mensajes de entrada serán grabados después del último mensaje.



**Attach your purchase receipt here.**

**For your future reference**

Serial No. \_\_\_\_\_ Date of purchase \_\_\_\_\_  
(found on the bottom of the unit)

Name and address of dealer \_\_\_\_\_

**For product service**

- Panasonic Servicenters are listed in the servicenter directory.
- Call 1-800-545-2672 for the location of an authorized servicenter.

**When you ship the product**

- Carefully pack your unit, preferably in the original carton.
- Attach a letter, detailing the symptom, to the outside of the carton.

Symptom \_\_\_\_\_

\_\_\_\_\_

- Send the unit to an authorized servicenter, prepaid and adequately insured.
- Do not send your unit to the Matsushita Consumer Electronics Company listed below or to executive or regional sales offices. These locations do not repair consumer products.

# Important safety instructions

When using this unit, basic safety precautions should always be followed to reduce the risk of fire, electric shock, or personal injury.

1. Read and understand all instructions.
2. Follow all warnings and instructions marked on this unit.
3. Unplug this unit from AC outlets before cleaning. Do not use liquid or aerosol cleaners. Use a damp cloth for cleaning.
4. Do not use this unit near water, for example, near a bath tub, wash bowl, kitchen sink, or the like.
5. Place this unit securely on a stable surface. Serious damage and/or injury may result if the unit falls.
6. Do not cover slots and openings on the unit. They are provided for ventilation and protection against overheating. Never place the unit near radiators, or in a place where proper ventilation is not provided.
7. Use only the power source marked on the unit. If you are not sure of the type of power supplied to your home, consult your dealer or local power company.
8. Do not place objects on the power cord. Install the unit where no one can step or trip on the cord.
9. Do not overload wall outlets and extension cords. This can result in the risk of fire or electric shock.
10. Never push any objects through slots in this unit. This may result in the risk of fire or electric shock. Never spill any liquid on the unit.
11. To reduce the risk of electric shock, do not disassemble this unit. Take the unit to an authorized servicer when service is required. Opening or removing covers may expose you to dangerous voltages or other risks. Incorrect reassembly can cause electric shock when the unit is subsequently used.
12. Unplug this unit from the wall outlet and refer servicing to an authorized servicer when the following conditions occur:
  - A. When the power supply cord or plug is damaged or frayed.
  - B. If liquid has been spilled into the unit.
  - C. If the unit has been exposed to rain or water.
  - D. If the unit does not work normally by following the operating instructions. Adjust only controls covered by the operating instructions. Improper adjustment may require extensive work by an authorized servicer.
  - E. If the unit has been dropped or physically damaged.
  - F. If the unit exhibits a distinct change in performance.

13. During thunderstorms, avoid using telephones except cordless types. There may be a remote risk of an electric shock from lightning.
14. Do not use this unit to report a gas leak, when in the vicinity of the leak.

**SAVE THESE  
INSTRUCTIONS**

**Matsushita Consumer Electronics Company,  
Division of Matsushita Electric Corporation of America**  
One Panasonic Way, Secaucus, New Jersey 07094

**Panasonic Sales Company ("PSC"),  
Division of Matsushita Electric of Puerto Rico, Inc.**  
Ave. 65 de Infantería, Km. 9.5, San Gabriel Industrial Park,  
Carolina, Puerto Rico 00985

## PRODUCT INFORMATION • OPERATION ASSISTANCE • LITERATURE REQUESTS • DEALER LOCATIONS

Customer Satisfaction Center 2F-3, One Panasonic Way, Secaucus, NJ 07094 (Headquarters)  
201-348-9090 (9:00am-8:00pm Monday-Friday, EST)

### ACCESSORY PURCHASES

1-800-332-5368 (Consumer Orders Only)  
Matsushita Services Company 20421 84th Avenue South Kent, WA 98032  
(6 am to 6 pm Monday-Friday; 6 am to 10:30 am Saturday; PST)  
(Visa, Mastercard, Discover card, American Express, Check)

### AUTHORIZED SERVICENTERS • PARTS DISTRIBUTOR LOCATIONS

To locate an independent authorized servicenter or parts distributor in your area, within the USA dial toll free  
1-800-545-2672, 24 hours a day, 7 days a week.

### PRODUCT REPAIRS

#### CALIFORNIA

6550 Katella Avenue  
Cypress, CA 90630  
Phone (714) 373-7425  
Fax (714) 694-8534

8000 Dubuque Avenue  
S. San Francisco, CA 94080  
Phone (415) 871-6373  
Fax (415) 871-6840

20201 Sherman Way  
Suite 102  
Canoga Park, CA 91306  
Phone (818) 709-1775  
Fax (818) 709-2165

3878 Ruffin Road Suite A  
San Diego, CA 92123  
Phone (619) 560-9200  
Fax (619) 560-1831

#### COLORADO

1640 South Abilene Suite D  
Aurora, CO 80012  
Phone (303) 752-2024  
Fax (303) 752-0610

#### FLORIDA

3700 North 29th Avenue  
Suite 102  
Hollywood, FL 33020  
Phone (954) 925-2880  
Fax (954) 925-5224

4710 Eisenhower Boulevard  
Suite A1 Tampa, FL 33634  
Phone (813) 884-4746  
Fax (813) 886-4564

#### GEORGIA

8655 Roswell Road  
Suite 100  
Atlanta, GA 30350  
Phone (770) 518-6301  
Fax (770) 518-6306

#### HAWAII

99-859 Iwailua Street  
Aiea, Hawaii 96701  
Phone (808) 468-1996  
Fax (808) 468-4369

#### ILLINOIS

\*1703 North Randall Road  
Elgin, IL 60123  
\*12:30 to 4:30, Mon-Fri\*  
Phone (847) 468-5464  
Fax (847) 468-5465

#### INDIANA

9060 Golf Road  
Niles, IL 60714  
Phone (847) 608-1010  
Fax (847) 299-1710

#### MARYLAND

Sulphur Springs  
Business Park  
1638 Sulphur Springs Road  
Baltimore, MD 21227  
Phone (410) 242-2607  
Fax (410) 247-3047

#### MASSACHUSETTS

60 Glacier Drive, Suite G  
Westwood, MA 02090  
Phone (617) 329-4280  
Fax (617) 329-0586

\*pick-up/drop-off only

### Factory Servicenters

#### MICHIGAN

37048 Van Dyke Avenue  
Sterling Heights, MI 48312  
Phone (810) 939-2060  
Fax (810) 939-2638

#### MINNESOTA

7850-12th Avenue South  
Airport Business Center  
Bloomington, MN 55425  
Phone (612) 854-8624  
Fax (612) 854-2089

#### OHIO

2236 Waycross Road  
Cincinnati, OH 45240  
Phone (513) 851-4180  
Fax (513) 851-8443

#### PENNSYLVANIA

2221 Cabot Boulevard  
West Suite B  
Langhorne, PA 19047  
Phone (215) 741-0661  
Fax (215) 741-0521

#### PENNSYLVANIA

Chartiers Valley  
Shopping Center  
1025 Washington Pike  
Bridgeville, PA 15017  
Phone (412) 257-4522  
Fax (412) 257-4650

#### TENNESSEE

919-8th Avenue South  
Nashville, TN 37203  
Phone (615) 244-4434  
Fax (615) 244-6713

#### TEXAS

7482 Harwin Drive  
Houston, TX 77036  
Phone (713) 781-1528  
Fax (713) 781-0643

13615 Welch Road  
Suite 101 Farmers Branch,  
TX 75244  
Phone (214) 385-1975  
Fax (214) 960-7626

#### WASHINGTON

20425-84th Avenue South  
Kent, WA 98032  
Phone (206) 872-7922  
Fax (206) 872-0918

### Service in Puerto Rico

Matsushita Electric  
of Puerto Rico, Inc.  
Panasonic Sales Company/  
Factory Servicenter

Ave. 65 de Infantería, Km. 9.5  
San Gabriel Industrial Park  
Carolina, Puerto Rico 00985  
Phone (809) 750-4300  
Fax (809) 768-2910

### REPAIR INQUIRIES

#### EAST (PCE)

2221 Cabot Boulevard  
West Suite A  
Langhorne, PA 19047  
Phone (215) 741-0676  
Fax (215) 750-6492

#### Covers:

CT, DE, ME, MD, MA,  
NH, NJ, NY, PA, RI, VT,  
VA, DC, WV

#### EAST (PCE)

1225 Northbrook Parkway  
Suite 2-390  
Suwanee, GA 30174  
Phone (404) 338-6860  
Fax (404) 338-6548

#### Covers:

AL, FL, GA, MS, NC, SC,  
TN

#### CENTRAL (PCC)

1707 North Randall Road  
Elgin, IL 60123  
Phone (847) 468-5530  
Fax (847) 468-5528

#### Covers:

AR, IL, IN, IA, KS, KY, LA,  
MI, MN, MO, NE, ND, OK,  
SD, TX, WI, OH

#### WEST (PCW)

6550 Katella Avenue  
Cypress, CA 90630  
Phone (714) 373-7440  
Fax (714) 373-7447

#### Covers:

AK, AZ, CA, CO, ID, MT,  
NV, NM, OR, UT, WA, WY,  
HI

### Regional Customer Care Department

# PANASONIC

## Telephone Products

### Limited Warranty

Matsushita Consumer Electronics Company or Panasonic Sales Company (collectively referred to as "the warrantor") will repair this product with new or refurbished parts, free of charge, in the USA or Puerto Rico for one (1) year from the date of original purchase in the event of a defect in materials or workmanship.

**This Limited Warranty Excludes both Labor and Parts for:** batteries, antennas, and cosmetic parts (cabinet).

Carry-in or mail-in service in the USA or Puerto Rico can be obtained during the warranty period by contacting a Matsushita Services Company (MSC) Factory Servicenter listed in the Servicenter Directory. Or call, toll free, 1-800-545-2672 to locate a MSC authorized Servicenter. Carry-in or mail-in service in Puerto Rico can be obtained during the warranty period by calling the local telephone number in the Servicenter Directory.

This warranty is extended only to the original purchaser. A purchase receipt or other proof of date of original purchase will be required before warranty service is rendered.

This warranty only covers failures due to defects in materials and workmanship which occur during normal use. The warranty does not cover damages which occurred in shipment, or failures which are caused by products not supplied by the warrantor, or failures which result from accident, misuse, abuse, neglect, mishandling, faulty installation, misapplication, set-up adjustments, improper operation or maintenance, alteration, modification, introduction of sand, humidity or liquids, line power surge, improper voltage supply, lightning damage, signal reception problems, commercial use such as hotel, office, restaurant, or other business or rental use of the product, or serviced by anyone other than a MSC Factory Servicenter or a MSC authorized Servicenter, or damage that is attributable to acts of God.

#### **LIMITS AND EXCLUSIONS**

There are no express warranties except as listed above.

**THE WARRANTOR SHALL NOT BE LIABLE FOR INCIDENTAL OR CONSEQUENTIAL DAMAGES RESULTING FROM THE USE OF THIS PRODUCT, OR ARISING OUT OF ANY BREACH OF THIS WARRANTY. ALL EXPRESS AND IMPLIED WARRANTIES, INCLUDING THE WARRANTIES OF MERCHANTABILITY, AND FITNESS FOR A PARTICULAR PURPOSE, ARE LIMITED TO THE APPLICABLE WARRANTY PERIOD SET FORTH ABOVE.**

Some states do not allow the exclusion or limitation of incidental or consequential damages, or limitations on how long an implied warranty lasts, so the above exclusions or limitations may not apply to you.

This warranty gives you specific legal rights and you may also have other rights which vary from state to state. If a problem with this product develops during or after the warranty period, you may contact your dealer or Servicenter. If the problem is not handled to your satisfaction, then write to the Customer Satisfaction Center at the company address indicated above.