

# Panasonic

Integrated Telephone System

Model No. **KX-TSC14W**

Pulse-or-tone dialing capability

## Operating Instructions



**2 LINE**

**Data Port** 

**Caller ID Compatible**

**PLEASE READ BEFORE USE AND SAVE.**

Panasonic World Wide Web address: <http://www.panasonic.com>  
for customers in the USA or Puerto Rico

Preparation

Basic Operation

Advanced Operation

Useful Information

# Before Initial Use

---

Please read **IMPORTANT SAFETY INSTRUCTIONS** on pages 48–49 before use. Read and understand all instructions.

*Thank you for purchasing your new Panasonic integrated telephone.*

Caller ID and Call Waiting Service, where available, are telephone company services. After subscribing to Caller ID, this phone will display a caller's name and phone number. Call Waiting Caller ID, which displays a second caller's name and phone number while the user is on another call, requires a subscription to both Caller ID and Call Waiting.

**Attach your purchase receipt here.**

## For your future reference

Serial No. \_\_\_\_\_  
(found on the bottom of the unit)

Date of purchase \_\_\_\_\_

Name and address of dealer \_\_\_\_\_

---

**Accessories (included)** To order, call 1-800-332-5368.

- AC Adaptor . . . . . one  
(p. 8)  
Order No. KX-TCA1-G

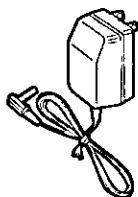

- Handset . . . . . one  
(p. 8)  
Order No. PQJXE0211Z

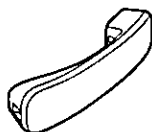

- 4-Wire Telephone Line Cord  
with Green Plugs . . . . . one  
(p. 9, 10)

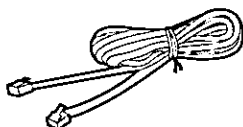

- Handset Cord . . . . . one  
(p. 8)  
Order No. PQJA10126Z

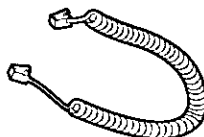

- 2-Wire Telephone Line Cord  
with Transparent Plugs. . . . one  
(p. 10)

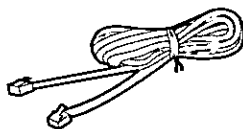

# Contents

---

## *Preparation*

<b>Location of Controls</b> .....	6
<b>Display</b> .....	7
<b>Settings</b> .....	8
Connecting the Handset/AC Adaptor .....	8
Connecting the Telephone Line Cord .....	9
Connecting a Communication Device .....	11
Setting the LCD Contrast .....	12
Selecting the Dialing Mode .....	13
Selecting the Line Mode .....	14
Programming Summary of Preparations .....	15
Time and Date Adjustment .....	16
Selecting the Ringer Volume .....	18

## *Basic Operation*

<b>Making Calls</b> .....	19
<b>Answering Calls</b> .....	21

## *Advanced Operation*

<b>Using the Other Line During a Conversation</b> .....	22
<b>Conference Call</b> .....	23
<b>Caller ID Service</b> .....	24
<b>Using the Caller List</b> .....	26
Viewing the Caller List .....	26
Calling Back from the Caller List .....	28
Editing a Caller's Phone Number .....	29
Storing Caller List Phone Number in the Speed Dialer Memory .....	30
Erasing Caller List Information .....	31
<b>Speed Dialer</b> .....	32
Storing Phone Numbers in the Speed Dialer Memory .....	32
Dialing a Stored Number .....	33
<b>Voice Mail Service</b> .....	34
Storing an Access Number in Your Voice Mail .....	35
Setting the Voice Mail Tone .....	36
Listening to Voice Mail Message(s) .....	37

---

<b>Special Features</b> .....	38
For Call Waiting Service Users .....	38
FLASH Button .....	39
Temporary Tone Dialing (For Rotary or Pulse Service Users) .....	40
How to Use the PAUSE Button (For Analog PBX Line/Long Distance Service Users) .....	40
Line Selection .....	41
Incoming Call Tone .....	42

*Preparation*

### *Useful Information*

<b>Using an Optional Headset</b> .....	43
Connecting an Optional Headset to the Unit .....	43
Making/Answering Calls .....	44
<b>Wall Mounting</b> .....	45
<b>Before Requesting Help</b> .....	46
<b>Important Safety Instructions</b> .....	48
<b>FCC and Other Information</b> .....	50

*Basic Operation*

*Advanced Operation*

*Useful Information*

# Location of Controls

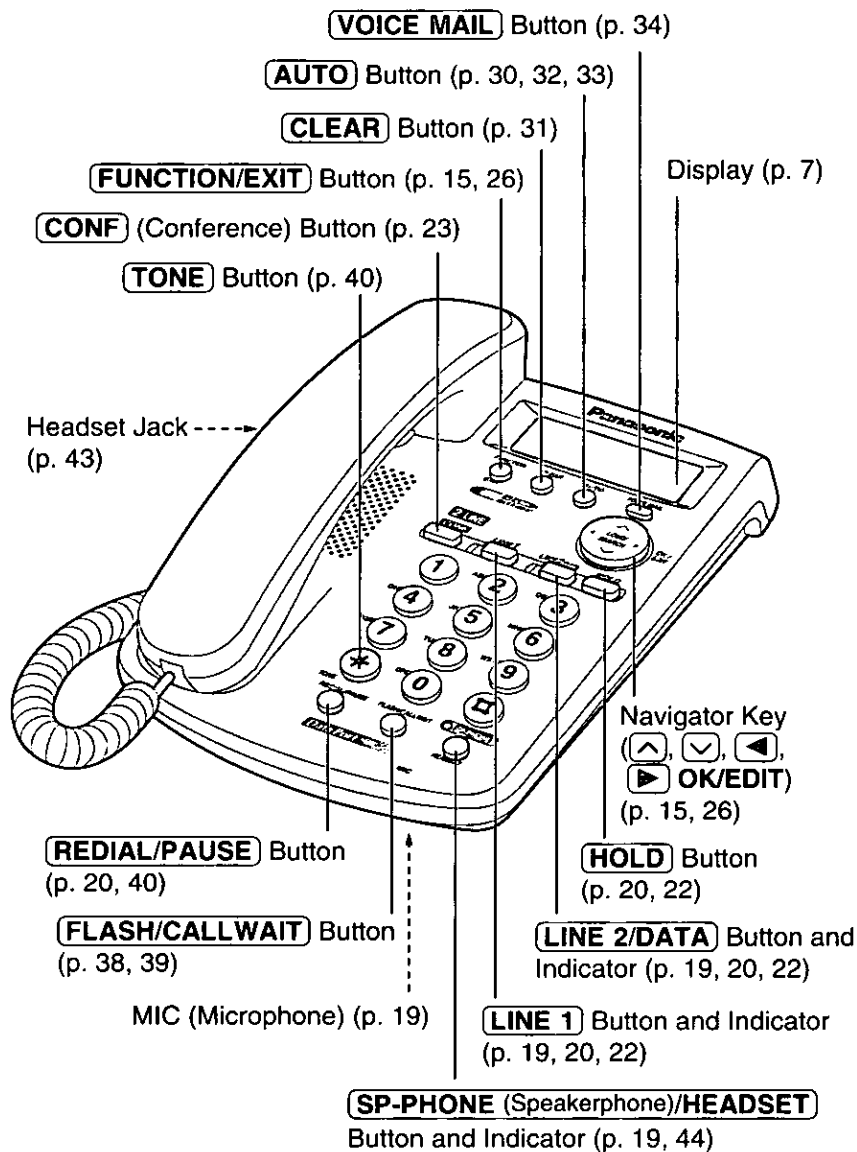

# Display

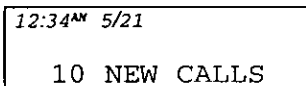

In the standby mode, the display shows the current time and date, and the number of new calls.

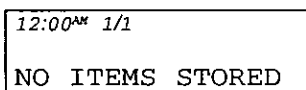

If the display continuously shows "12:00<sup>AM</sup> 1/1" or "0:00 1/1", the clock needs adjusting (p. 16, 17).

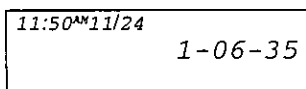

During a conversation, the display shows the length of the call (Ex. 1 hour, 6 minutes and 35 seconds).

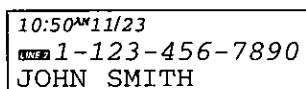

When a call is received, the display shows the caller's number, name and the called line after the first ring.

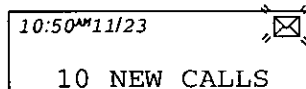

The display shows the voice mail message(s) is/are received.

Ex. Handset volume level: 4

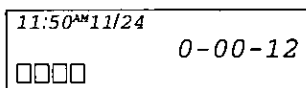

Ex. Speaker volume level: 8

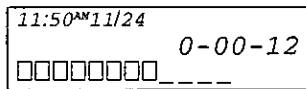

The display shows the volume level.

You can select:

- 4 levels (1–4) while using the handset (p. 20).
- 12 levels (1–12) while using the speakerphone (p. 20).

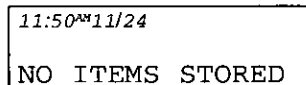

The Caller List is empty.

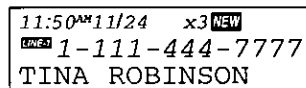

This is a display from the Caller List.

The display shows:

- the time and date of the last call (Ex. Nov. 24, 11:50 AM),
- the number of times called (Ex. 3 times),
- the caller information is new and has not been viewed ("NEW" is displayed),
- the called line,
- the caller's number and
- the caller's name.

# Settings

## Connecting the Handset/AC Adaptor

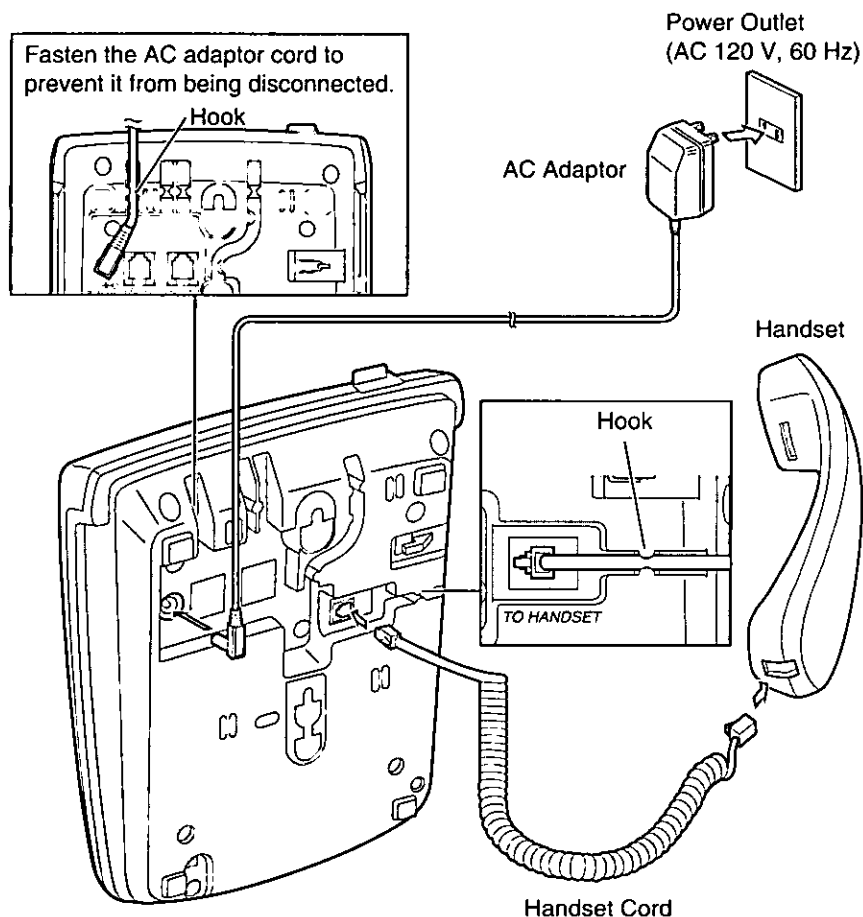

- USE ONLY WITH Panasonic AC ADAPTOR KX-TCA1 (Order No. KX-TCA1-G).
- Use only a Panasonic Handset for the KX-TSC14W.
- The AC adaptor must remain connected at all times. (It is normal for the adaptor to feel warm during use.)
- During a power failure the unit will work as a standard telephone on the Line 1, but the following features will not work.
  - Caller ID services
  - speakerphone
  - line indicators
  - LCD display





## Connecting the Telephone Line Cord

Connect the telephone line cord(s) to the unit as follows.

### To connect a two-line telephone jack

Preparation

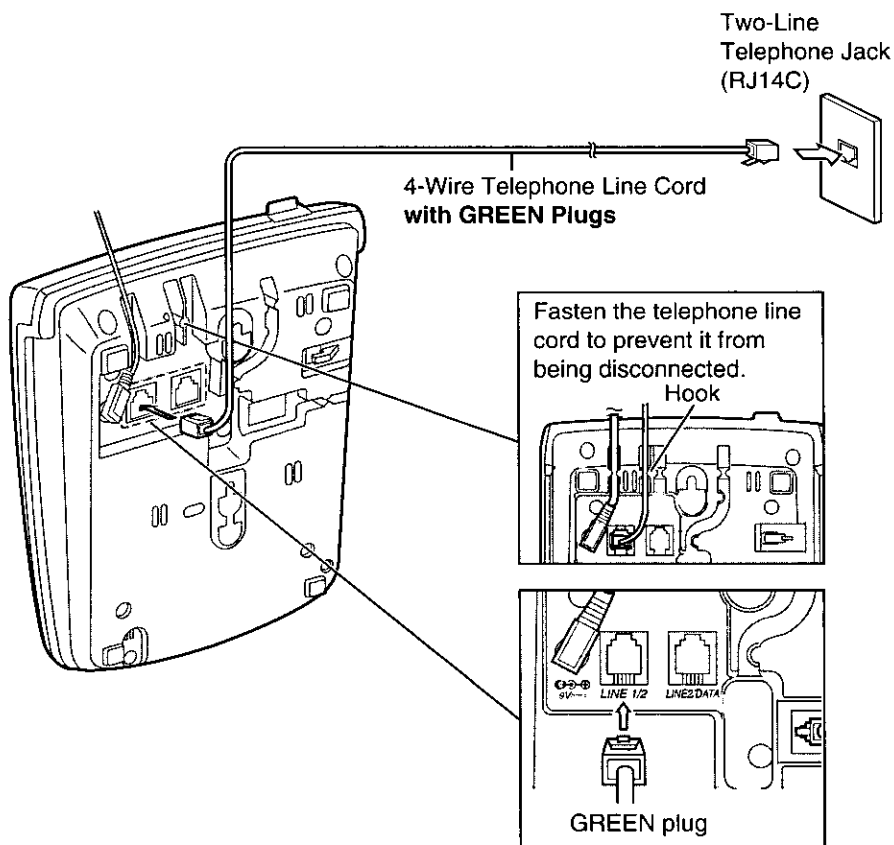

## To connect two single-line telephone jacks

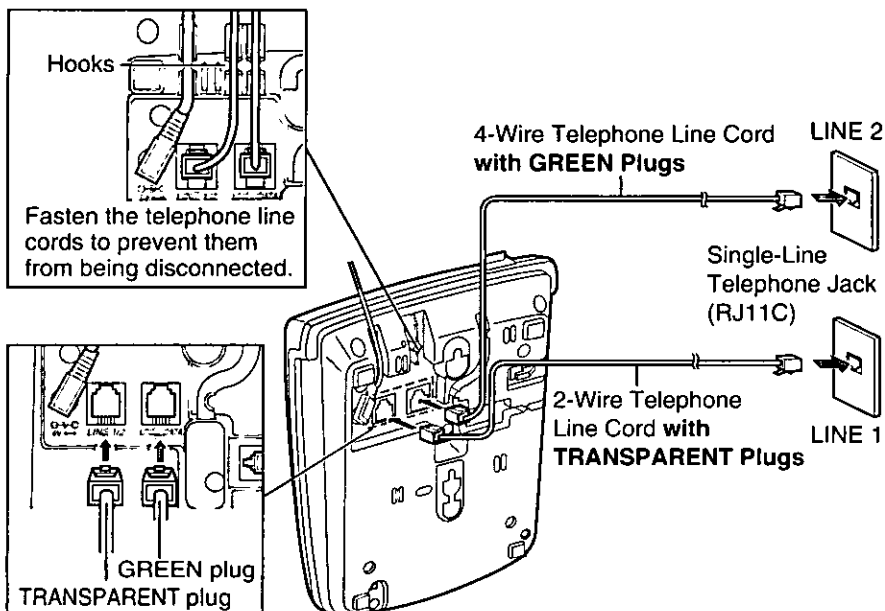

## If you use the unit only as a single-line telephone

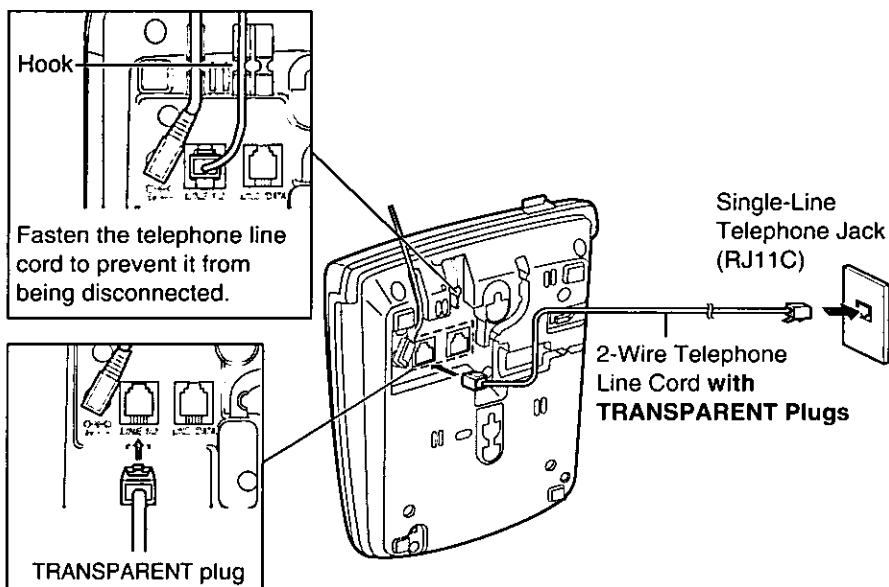

•For this connection, you can only use LINE 1.



## Connecting a Communication Device

After connecting the telephone line cord to a two-line telephone jack, you can connect a communication device (computer, modem, fax, answering machine, etc.) through this unit using the LINE 2/DATA jack (**—Data Port**).

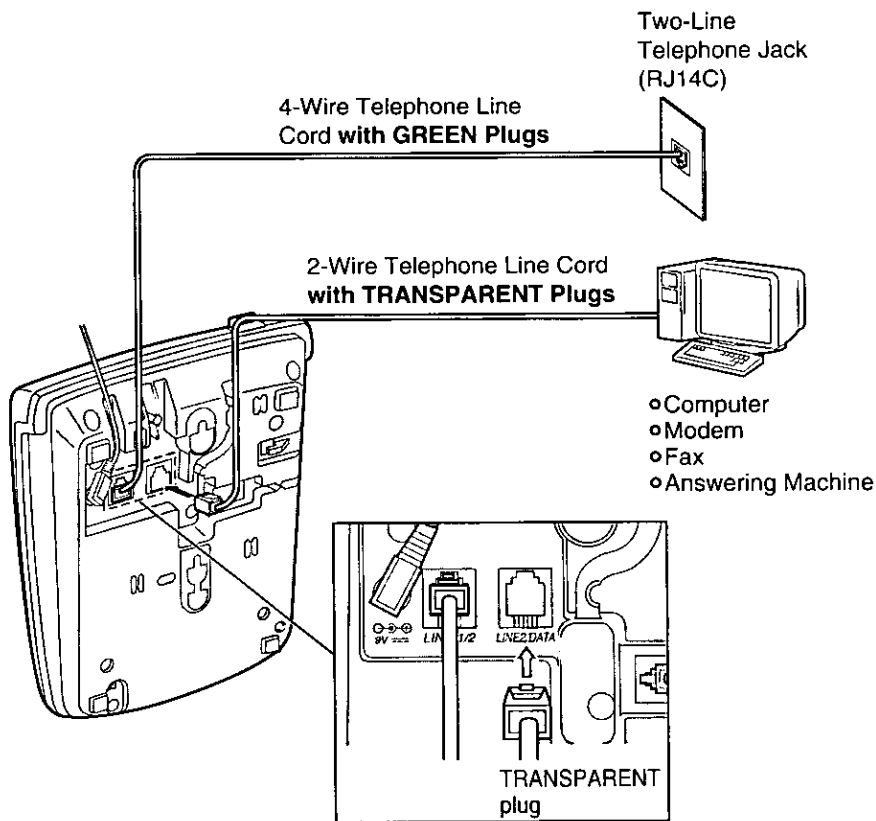

◦ If the LINE 2/DATA indicator lights, the communication device is in use. Use LINE 1 to make a call. Otherwise the communication device may not operate properly.

### Setting the LCD Contrast

You can select the LCD contrast level from 1 to 6 by programming. Your phone comes from the factory set to 3.

**Make sure that the handset is on the cradle, the AC adaptor is connected and the SP-PHONE/HEADSET indicator light is off.**

1 Press **FUNCTION/EXIT**.

9:30 PM 12/27

SAVE AUTO# ?

2 Press  or  repeatedly until "LCD CONTRAST ?" is displayed.

9:30 PM 12/27

LCD CONTRAST ?

3 Press  **OK/EDIT**.  
•The current setting is displayed.

9:30 PM 12/27

□□□\_

4 Press  or  to select the desired LCD contrast level.

•Each time you press  or , the level will change on the display.

5 Press  **OK/EDIT**.  
•The display will return to step 2. To return to the standby mode, press **FUNCTION/EXIT** or wait for 60 seconds.



## Selecting the Dialing Mode

You can select the dialing mode by programming. If you have touch tone service, set to "TONE". If rotary or pulse service is used, set to "PULSE". Your phone comes from the factory set to "TONE".

**Make sure that the handset is on the cradle, the AC adaptor is connected and the SP-PHONE/HEADSET indicator light is off.**

Preparation

1 Press **FUNCTION/EXIT**.

11:50<sup>AM</sup>11/24  
SAVE AUTO# ?

2 Press **▼** or **▲** repeatedly until "SET DIAL MODE ?" is displayed.

11:50<sup>AM</sup>11/24  
SET DIAL MODE ?

3 Press **▶** **OK/EDIT**.

11:50<sup>AM</sup>11/24  
TONE           ▶=SAVE

4 Press **▼** or **▲** to select "TONE" or "PULSE".

5 Press **▶** **OK/EDIT** (SAVE key).  
◦A beep sounds.  
◦The display will return to step 2. To return to the standby mode, press **FUNCTION/EXIT** or wait for 60 seconds.

◦You can exit the programming mode any time by pressing **FUNCTION/EXIT**.

### Selecting the Line Mode

If a line is connected to a low voltage system such as a PBX, set to "B". If not, the line indicator will not operate properly. Both lines are preset to "A".

**Make sure that the handset is on the cradle, the AC adaptor is connected and the SP-PHONE/HEADSET indicator light is off.**

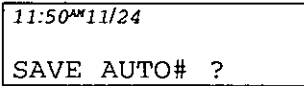
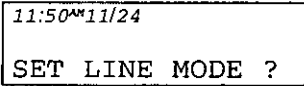
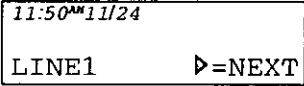
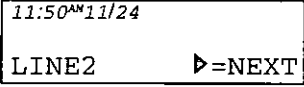
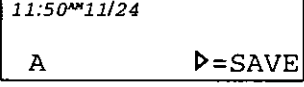
- 1 Press **FUNCTION/EXIT**.  

- 2 Press  or  repeatedly until "SET LINE MODE ?" is displayed.  

- 3 Press  **OK/EDIT**.  

- 4 Press  or  to select the desired line, "LINE1" or "LINE2".  

- 5 Press  **OK/EDIT** (NEXT key).  

- 6 Press  or  to select the desired line mode.
- 7 Press  **OK/EDIT** (SAVE key).
  - A beep sounds.
  - The display will return to step 2. To program the other line, start from step 3. To return to the standby mode, press **FUNCTION/EXIT** or wait for 60 seconds.

◦You can exit the programming mode any time by pressing **FUNCTION/EXIT**.



## Programming Summary of Preparations

You can program the following functions. The display shows the programming instructions. See the corresponding pages for function details.

**Make sure that the handset is on the cradle, the AC adaptor is connected and the SP-PHONE/HEADSET indicator light is off.**

Press **FUNCTION/EXIT**.



- Press or repeatedly until the desired function is displayed.
- **To store phone numbers in the speed dialer memory**, see page 32.
  - **To adjust the time and date**, see page 16.
  - **To store a voice mail access number**, see page 35.
  - **To set the voice mail tone**, see page 36.
  - **To change the line selection**, see page 41.
  - **To select the dialing mode**, see page 13.
  - **To turn on/off the incoming call tone**, see page 42.
  - **To select the flash time**, see page 39.
  - **To select the ringer volume**, see page 18.
  - **To select the line mode**, see page 14.
  - **To change the LCD contrast setting**, see page 12.



Press **OK/EDIT** to go to the next step.

◦ You can exit the programming mode any time by pressing **FUNCTION/EXIT**.

## Time and Date Adjustment

You can select AM/PM or military time by programming.  
**Make sure that the handset is on the cradle, the AC adaptor is connected and the SP-PHONE/HEADSET indicator light is off.**

- 1 Press **[FUNCTION/EXIT]**.

12:00<sup>AM</sup> 1/1  
 SAVE AUTO# ?

- 2 Press **[v]** or **[^]** repeatedly until "SET CLOCK ?" is displayed.

12:00<sup>AM</sup> 1/1  
 SET CLOCK ?

- 3 Press **[>] OK/EDIT**.

12:00<sup>AM</sup> 01/01  
 0000  
 ENTER TIME

- 4 Enter the current time (hour and minute) using a 4-digit number. (Ex. To set 9:30, enter "0930".)

09:30<sup>AM</sup> 01/01  
 0000  
 ENTER TIME

- For AM/PM setting: Enter numbers between 0100 and 1259.
- For military time: Enter numbers between 0000 and 2359.

- 5 Press **[>] OK/EDIT**.

- If numbers between 0000 and 0059, or 1300 and 2359 are entered, the time will automatically be set using the military time. Skip steps 6 and 7 and go to step 8.

09:30<sup>AM</sup> 01/01  
 0000  
 # = AM / PM

- 6 Press **[#]** to select "AM", "PM" or military time. (Ex. You select "PM".)

09:30<sup>PM</sup> 01/01  
 0000  
 # = AM / PM

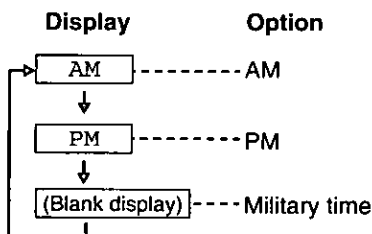

AM/PM	Military Time
12:00 <sup>AM</sup> –11:59 <sup>AM</sup>	0:00–11:59
12:00 <sup>PM</sup> –11:59 <sup>PM</sup>	12:00–23:59

- Each time you press **[#]**, the selection will change on the display.





7 Press **▶** **OK/EDIT**.

09:30<sup>m</sup> 01/01  
0000  
ENTER MONTH/DATE

8 Enter the current month and day using a 4-digit number.  
(Ex. To set Dec. 27, enter "1227".)

09:30<sup>m</sup> 12/27  
0000  
ENTER MONTH/DATE

9 Press **▶** **OK/EDIT**.

09:30<sup>m</sup> 12/27  
0000  
ENTER YEAR

10 Enter the current year using a 4-digit number.  
(Ex. To set the year 2001, enter "2001".)

09:30<sup>m</sup> 12/27  
2001  
ENTER YEAR

◦ You can set the year 2000 to 2099.

11 Press **▶** **OK/EDIT**.

- A beep sounds.
- The clock starts working.
- The display will return to step 2. To return to the standby mode, press **FUNCTION/EXIT** or wait for 60 seconds.

9:30<sup>m</sup> 12/27  
SET CLOCK ?

- You can go back to the previous screen by pressing **◀**, when setting the time and date.
- If 3 beeps sound when entering the time and date, the time and date entered are not correct. Enter the correct time and date.

If a power failure occurs, the incorrect time and date will be shown on the display. Reprogram the current time and date.

#### For Caller ID service users (p. 24)

- The Caller ID information will re-set the clock after the first ring if the adjusted time and/or date is incorrect. However, if the time has not previously been set, the Caller ID information will not adjust the clock.
- The Caller ID information will automatically adjust the clock for daylight saving time.

## ◇ Settings

### Selecting the Ringer Volume

You can select the ringer volume for each line by programming. Set to HIGH or LOW. When set to OFF, the selected line(s) will not ring. Both lines are preset to HIGH.

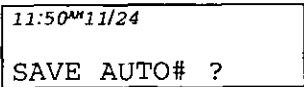
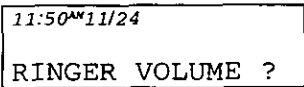
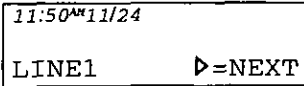
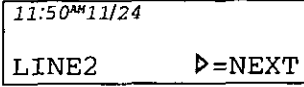
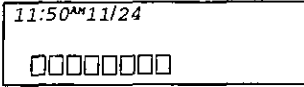
- 1 Press **FUNCTION/EXIT**.  

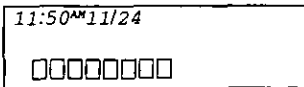
- 2 Press  or  repeatedly until "RINGER VOLUME ?" is displayed.  

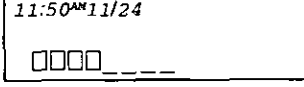
- 3 Press  **OK/EDIT**.  

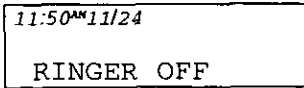
- 4 Press  or  to select the desired line, "LINE1" or "LINE2".  

- 5 Press  **OK/EDIT** (NEXT key).  

- 6 Press  or  to select the desired volume.
  - The selected volume rings.

HIGH 

LOW 

OFF 

  - To turn the ringer OFF, press and hold  until 2 beeps sound.
- 7 Press  **OK/EDIT**.
  - The display will return to step 2. To program the other line, start from step 3.
  - To return to the standby mode, press **FUNCTION/EXIT** or wait for 60 seconds.

- You can exit the programming mode any time by pressing **FUNCTION/EXIT**.
- You can adjust the ringer volume while the unit is ringing. Press  or  to increase or decrease, or press and hold  to turn the ringer OFF.



The unit will automatically select a free line which is not being used by a parallel connected telephone when you lift the handset to make a call. (To change the line selection, see page 41.) To hang up, place the handset on the cradle.

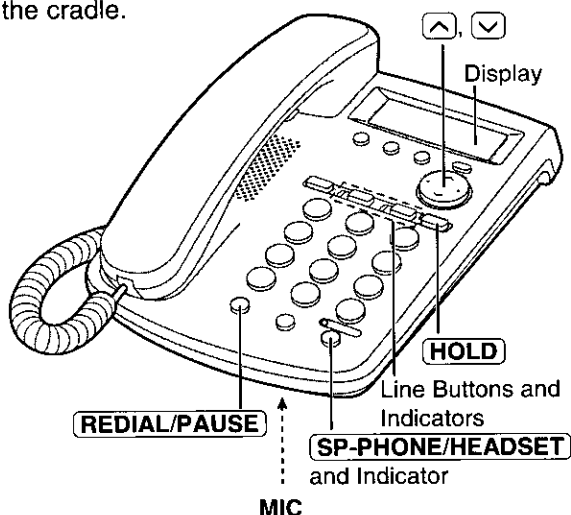

## Using the speakerphone

- 1 Press **SP-PHONE/HEADSET**.
  - The indicator lights.
  - A free line is automatically selected and the line indicator lights.
- 2 Dial a phone number.
  - The dialed number is displayed.
  - If you misdial, hang up and start again from step 1.
  - After a few seconds, the display will show the length of the call.
- 3 When the other party answers, talk into the **MIC** (microphone).
- 4 To hang up, press **SP-PHONE/HEADSET**.
  - The indicator lights go out.
  - The display will return to the standby mode.

11:50AM 11/24

11:50AM 11/24  
1234567890

11:50AM 11/24  
0-00-00

◦In step 1, you may select a line manually by pressing the line button instead of **SP-PHONE/HEADSET**.

## ☞ Making Calls

---

### To redial the last number dialed

**Using the handset:** Lift the handset ⇒ press **REDIAL/PAUSE**.

**Using the speakerphone:** Press **SP-PHONE/HEADSET** ⇒  
⇒ press **REDIAL/PAUSE**.

### To adjust the handset volume (4 levels) or the speaker volume (12 levels) while talking

To increase, press **∧**. To decrease, press **∨**.

Ex. Handset volume level: 2

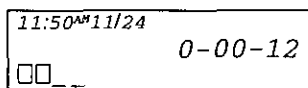

Ex. Speaker volume level: 3

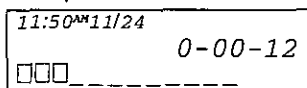

◦The display shows the volume level for a few seconds.

### To put a call on hold

Press **HOLD**.

◦The line indicator flashes.

◦If you are using the handset, you may place it on the cradle.

### To release the hold

Press the line button.

◦If another phone is connected on the same line, you can also release the hold by lifting its handset.

#### During speakerphone operation

For best performance, please note the following:

- Talk alternately with the other party in a quiet room.
- If the other party has difficulty hearing you, press **∨** to decrease the speaker volume.
- You can switch to the handset by lifting it up. To switch back to the speakerphone, press **SP-PHONE/HEADSET**.

### What the line indicator means

Off	The line is free.
On	You are using the line.
Flashing twice every 2 seconds	Someone else is using the line on a parallel connected telephone.
Flashing	A call is on hold.
Flashing quickly	A call is being received.

# Answering Calls

When a call is being received, the unit rings and the called line indicator flashes quickly. You can answer a call by simply lifting the handset. The line is automatically selected, when you answer the call. (To change the line selection, see page 41.)

If you subscribe to a Caller ID service, the calling party information will be displayed after the first ring (p. 24). In order to view the Caller ID information, please wait until the second ring to answer a call.

## Using the speakerphone

- 1 Press **SP-PHONE/HEADSET**.
  - The indicator lights.
  - The called line indicator lights.
- 2 Talk into the **MIC** (microphone).
- 3 To hang up, press **SP-PHONE/HEADSET**.
  - The indicator lights go out.

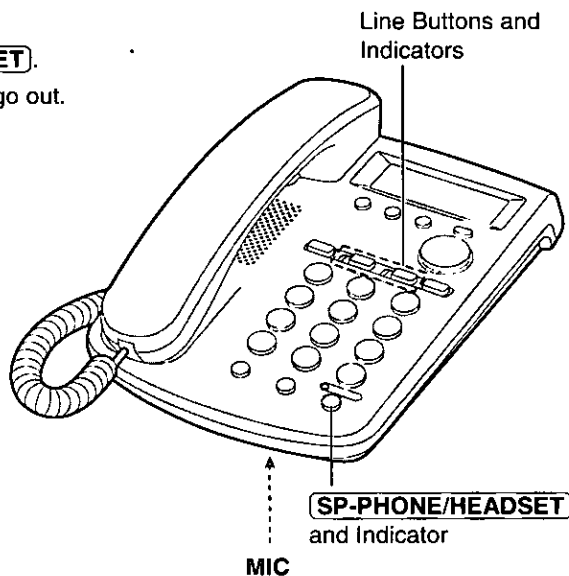

◦In step 1, you may answer a call by pressing the line button or any dialing button (**1** to **0**, **\*** or **#**) instead of **SP-PHONE/HEADSET**.

◦When the ringer volume is set to "OFF", the selected line(s) will not ring (p. 18).

# Using the Other Line During a Conversation

During a conversation, if the other line indicator flashes quickly, an incoming call is being received on the line. You can answer the second call while holding the first call. You can also make a call without terminating the first call. If you subscribe to a Caller ID service, the second caller's information will be displayed when a call is being received on the other line (p. 24).

Ex: If you are using LINE 1

- 1 Press **HOLD** to put the first call (LINE 1) on hold.
  - The LINE 1 indicator flashes.
- 2 Press the other line button (LINE 2/DATA) to make or answer a second call.
  - The LINE 2 indicator lights.
- 3 To return to the first call (LINE 1); press the line button for the first call (LINE 1).

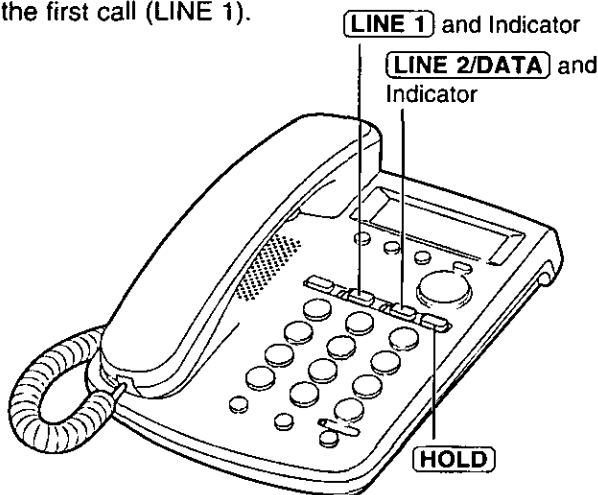

- To hold the second call in step 3, press **HOLD** before pressing the line button for the first call.
- You may be informed if another call arrives on the other line during a conversation by two tones (incoming call tone). For this setting, see page 42.

# Conference Call

While having a conversation on one line, you can make or answer a second call on the other line and then combine both calls together to make a conference call.

Ex: If you are using LINE 1

- 1 Press **HOLD** to put the first call (LINE 1) on hold.
  - The LINE 1 indicator flashes.
- 2 Press the other line button (LINE 2/DATA) to make or answer a second call.
  - The LINE 2 indicator lights.
- 3 When the second call is connected, press **CONF** to make a conference call.
  - Both line indicators light.

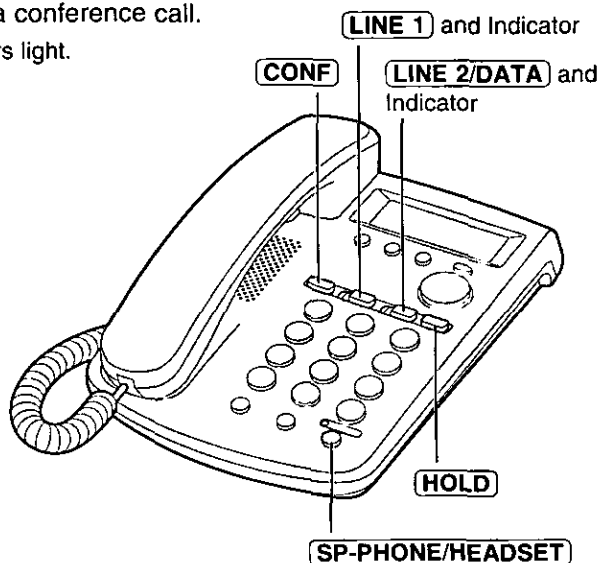

## During a conference call:

- To hang up both lines, place the handset on the cradle or press **SP-PHONE/HEADSET**.
- To hang up only one line, press the line button you want to continue talking with.
- To put both lines on hold, press **HOLD**.  
To talk with only one caller, press the corresponding line button.  
To resume both lines, press **CONF**.

# Caller ID Service

This unit is compatible with a Caller ID service offered by your telephone company. If you subscribe to a Caller ID service, the calling party's information will be displayed after the first ring.

The unit can record information of up to 50 different callers, including the time and date received, the number of times called and the called line, in the Caller List. The Caller List information is sorted from the most recent to the oldest call. When the 51st call is received, the 1st call is deleted.

Using the list, you can automatically call back a caller. You can store the callers' numbers from the Caller List in the Speed Dialer memory.

If you subscribe to a Call Waiting Caller ID Feature, when a second call is received on the same line, the new caller's name and phone number will be displayed (p. 38).

## How caller information is displayed when a call is received

The display shows the caller's name, number and the called line after the first ring.

11:50<sup>AM</sup> 11/24  
1-111-444-7777  
TINA ROBINSON

After you answer the call, the display will show the length of the call.

11:50<sup>AM</sup> 11/24  
0-00-00

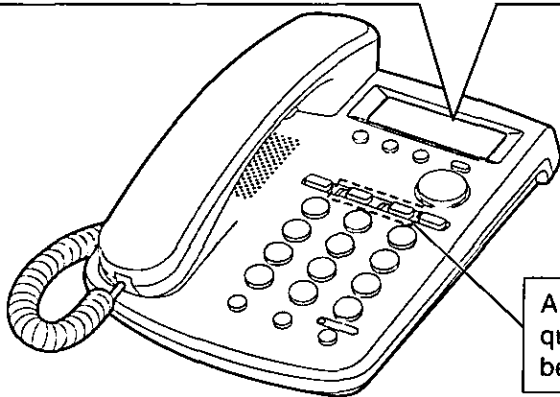

A line indicator will flash quickly when a call is being received.

◦When both lines are receiving calls, each caller's information will be displayed alternately.



- 
- Caller information will not be displayed in the following cases:
    - If the caller dialed from an area which does not provide a Caller ID service, the display will show "OUT OF AREA".
    - If the caller has requested not to display his/her information, the display will show "PRIVATE CALLER".
    - If a long distance call cannot be identified, "LONG DISTANCE" will be displayed.
  - If your unit is connected to a PBX which does not support Caller ID services, you cannot access those services.
  - If a power failure occurs, Caller ID services will not be available.
  - The name display service may not be available in some areas. For more information, please contact your telephone company.

## To check the number of new calls

The display shows the number of new calls in the standby mode.

For example, if you have received 10 new calls, the display on the right will be shown.

11:50<sup>AM</sup> 11/24

10 NEW CALLS

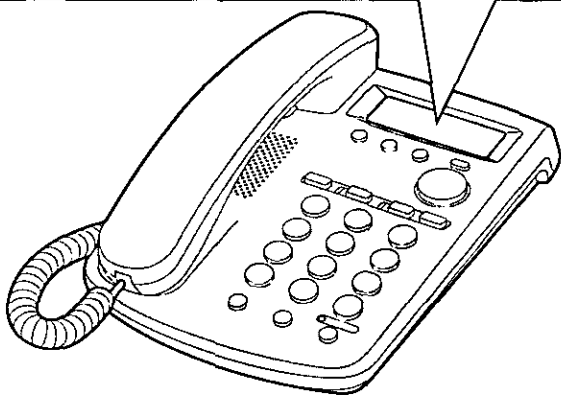

# Using the Caller List

## Viewing the Caller List

To check who has called, follow the steps below.

- 1** Press  or  to enter the list.
- If you press , the display will show the most recent caller information.
  - If you press , the display will show the oldest caller information.

11:50 <sup>AM</sup> 11/24
<b>NEW</b> 1-111-444-7777
TINA ROBINSON

- 2** To search from the most recent call, press .
- To search from the oldest call, press .
- To scroll between callers, press  or .
  - To return to the standby mode, press **FUNCTION/EXIT** or wait for 60 seconds.

10:50 <sup>AM</sup> 11/23	x4 <b>NEW</b>
<b>NEW</b> 1-222-333-4444	
JOHN SMITH	

- 3** To exit the list, press **FUNCTION/EXIT** or wait for 60 seconds.
- The display will return to the standby mode.

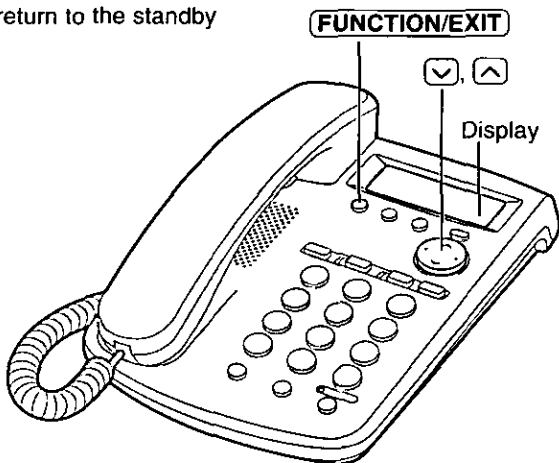

- Once NEW calls have been checked, "**NEW**" will disappear from the display.
- If "NO ITEMS STORED" is displayed in step 1, the Caller List is empty.
- If more than one call is received from the same caller, the date and time of the most recent call will be recorded.



## Ex. When you search from the most recent call:

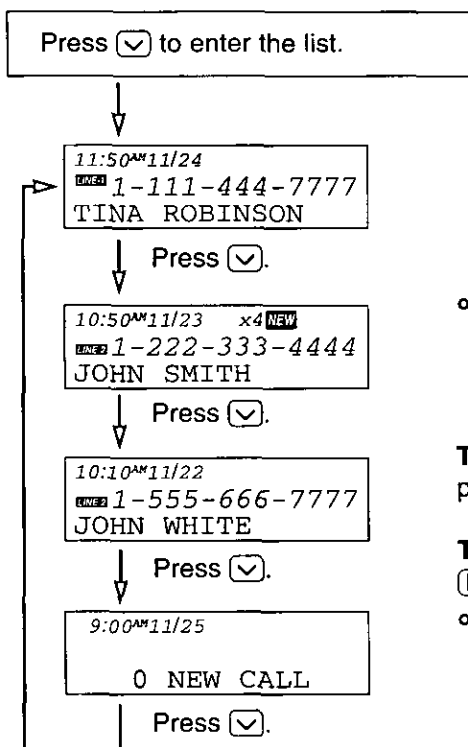

• If there is no name information for a caller, the display will only show the phone number.

**To return to the previous caller,** press **[^]**.

**To exit the Caller List,** press **[FUNCTION/EXIT]**.

• The display will return to the standby mode.

### Display meaning:

**NEW** : You have not checked the caller information, answered the call or called back the caller.

x2-x9 : The number of times the same caller called (up to 9).

## ➤ Using the Caller List

### Calling Back from the Caller List

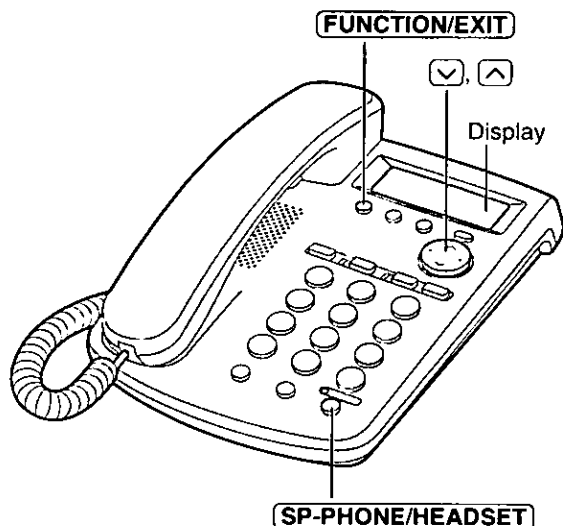

- 1 Press or to enter the list.

11:50 <sup>AM</sup> 11/24
<b>LINE1</b> 1-111-444-7777
TINA ROBINSON

- 2 Press or repeatedly to find the desired caller.
- To return to the standby mode, press **FUNCTION/EXIT** or wait for 60 seconds.

10:50 <sup>AM</sup> 11/23	x4 <b>NEW</b>
<b>LINE1</b> 1-222-333-4444	
JOHN SMITH	

- 3 Lift the handset or press **SP-PHONE/HEADSET**.

11:00 <sup>AM</sup> 11/26
12223334444

- The displayed phone number is dialed automatically.
- You may also press a line button instead of **SP-PHONE/HEADSET**.
- After a few seconds, the display will show the length of the call.

11:00 <sup>AM</sup> 11/26	0-00-00
---------------------------	---------

- In some cases, you may have to edit the number before dialing (p. 29).
- If a phone number is not displayed in the caller information, you cannot call back that caller.



## Editing a Caller's Phone Number

You can edit a phone number recorded in the Caller List.

1 Press  or  to enter the list.

11:50AM11/24
LINE 1 1-111-444-777
TINA ROBINSON

2 Press  or  repeatedly to find the desired caller.

10:50AM11/23 x4NEW
LINE 1 1-222-333-4444
JOHN SMITH

3 Press  **OK/EDIT** to select a pattern.

Each time you press  **OK/EDIT**, the number is rearranged into one of 4 different patterns.

(a)

(b)  -

(c) 1 -

(d) 1 -  -

The order in which patterns (a)-(d) are displayed depends on how the telephone number is displayed in step 2.

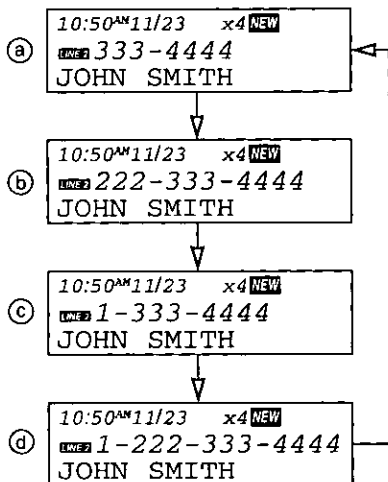

4 After editing the number, you can continue with calling back or storing procedures.

To call back, lift the handset or press **SP-PHONE/HEADSET** (p. 28).

To store the number in the Speed Dialer memory, see page 30.

## ➤ Using the Caller List

### Storing Caller List Phone Number in the Speed Dialer Memory

You can store numbers that are in the Caller List in the Speed Dialer memory.

**Make sure that the handset is on the cradle, the AC adaptor is connected and the SP-PHONE/HEADSET indicator light is off.**

- 1 Press **▼** or **▲** to enter the list.

```
11:50AM 11/24
LINE 1 1-111-444-7777
TINA ROBINSON
```

- 2 Press **▼** or **▲** repeatedly to find the caller you want to store in memory.

◦ If the number requires editing, see page 29.

```
10:50AM 11/23 x4 NEW
LINE 1 1-222-333-4444
JOHN SMITH
```

- 3 Press **AUTO**.

```
10:50AM 11/23 x4 NEW
LINE 1 1-222-333-4444
PRESS 0-9
```

- 4 Press a memory station number (**0** to **9**).  
(Ex. **1** is pressed as a memory station number.)

◦ A beep sounds.

◦ The display will return to step 2. You can continue storing other items. To return to the standby mode, press

**FUNCTION/EXIT** or wait for 60 seconds.

```
10:50AM 11/23 x4 NEW
LINE 1 1-222-333-4444
SAVE IN AUTO 1
```

```
10:50AM 11/23 x4 NEW
LINE 1 1-222-333-4444
JOHN SMITH
```

- To cancel during programming, press **FUNCTION/EXIT**. Start again from step 1.
- You cannot store caller information in the Speed Dialer memory if a phone number is not displayed.

## Erasing Caller List Information

After checking the Caller List, you can erase some or all of the entries. **Make sure that the handset is on the cradle, the AC adaptor is connected and the SP-PHONE/HEADSET indicator light is off.**

### To erase a specific caller from the Caller List

- 1 Press **▼** or **▲** to enter the list.
- 2 Press **▼** or **▲** repeatedly to find the caller you want to erase from the Caller List.

11:50<sup>AM</sup>11/24  
LINE1 1-111-444-7777  
TINA ROBINSON

10:50<sup>AM</sup>11/23 x4<sup>NEW</sup>  
LINE1 1-222-333-4444  
JOHN SMITH

- 3 Press **CLEAR**.
  - A beep sounds and the information is erased.
  - After a few seconds, the display will show the previous caller information.
  - To return to the standby mode, press **FUNCTION/EXIT** or wait for 60 seconds.

10:50<sup>AM</sup>11/23  
CLEAR

10:00<sup>AM</sup>11/21  
LINE1 1-555-666-7777  
JOHN WHITE

### To erase all entries in the Caller List

Make sure that the unit is in the standby mode.

- 1 Press **CLEAR**.
  - To stop erasing procedures, press **FUNCTION/EXIT**.
- 2 Press **▶ OK/EDIT**.
  - A beep sounds and all entries are erased.
  - "NO ITEMS STORED" is displayed, and the unit returns to the standby mode.

11:50<sup>AM</sup>11/24  
ALL CLEAR ?

11:50<sup>AM</sup>11/24  
ALL CLEAR

11:50<sup>AM</sup>11/24  
NO ITEMS STORED

# Speed Dialer

---

## Storing Phone Numbers in the Speed Dialer Memory

You can store up to 10 phone numbers in the Speed Dialer memory. The dialing buttons (0) to (9) function as memory stations. Do not press any memory stations before storing to prevent misoperation.

**Make sure that the handset is on the cradle, the AC adaptor is connected and the SP-PHONE/HEADSET indicator light is off.**

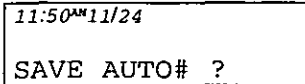
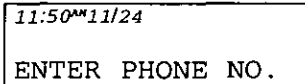
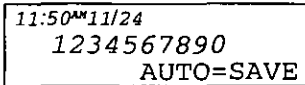
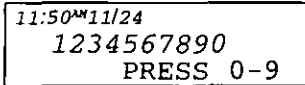
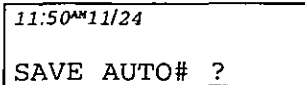
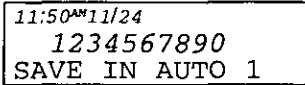
- 1 Press **FUNCTION/EXIT**.  

- 2 Press **OK/EDIT**.  

- 3 Enter a phone number, up to 22 digits.  
If you enter a wrong number, press **CLEAR** and enter the correct number.  

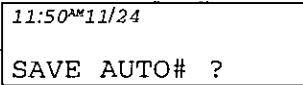
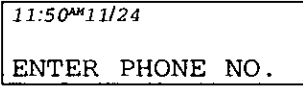
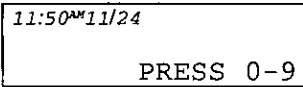
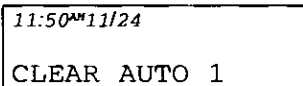
- 4 Press **AUTO**.  

- 5 Press a memory station number (0) to (9). (Ex. 1 is pressed.)
  - o A beep sounds.
  - o The display will return to step 1. You can continue storing other numbers after pressing **OK/EDIT**.
  - o To return to the standby mode, press **FUNCTION/EXIT** or wait for 60 seconds.
  - o You can exit the programming mode any time by pressing **FUNCTION/EXIT**.
  - o If a pause is required for dialing, press **REDIAL/PAUSE** where needed. Pressing **REDIAL/PAUSE** counts as one digit (p. 40).



## To erase a stored number

- 1 Press **FUNCTION/EXIT**.  

- 2 Press **OK/EDIT**.  

- 3 Press **AUTO**.  

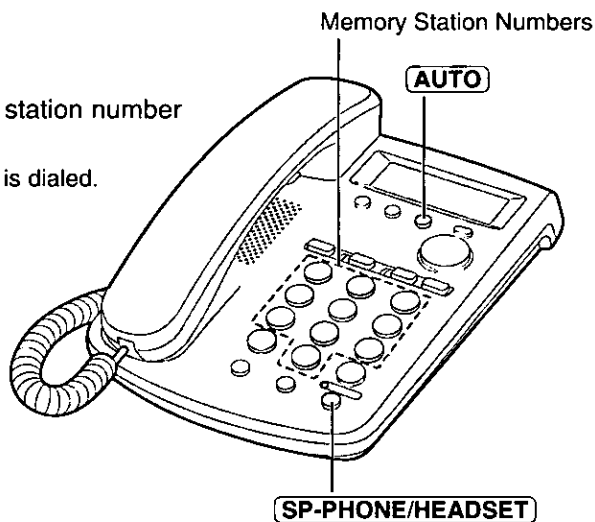
- 4 Press a memory station number (**0** to **9**) for the phone number to be erased.  
(Ex. **1** is pressed.)  

  - A beep sounds.
  - The display will return to step 1.

## Dialing a Stored Number

- 1 Lift the handset or press **SP-PHONE/HEADSET**.
- 2 Press **AUTO**.
- 3 Press the memory station number (**0** to **9**).
  - The stored number is dialed.



# Voice Mail Service

---

Voice mail service is an electronic on-line answering system offered by your telephone company. After you subscribe, the voice mail system can answer calls automatically when the line is busy or if calls are not answered. Callers can leave messages by following the pre-recorded instructions. When voice mail messages are recorded, "☒" will flash. You can access the voice mail system quickly by using the **VOICE MAIL** button.

To use the **VOICE MAIL** button, you must store your access phone number for the line first.

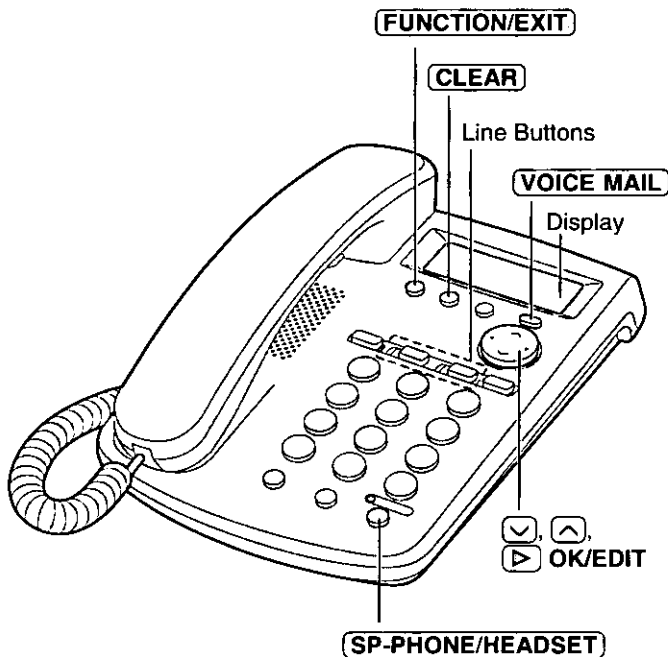



# Storing an Access Number in Your Voice Mail

Make sure that the handset is on the cradle, the AC adaptor is connected and the SP-PHONE/HEADSET indicator light is off.

1 Press **FUNCTION/EXIT**.

11:50<sup>AM</sup>11/24

SAVE AUTO# ?

2 Press **↓** or **↑** repeatedly until "SAVE MAILBOX# ?" is displayed.

11:50<sup>AM</sup>11/24

SAVE MAILBOX# ?

3 Press **▶** **OK/EDIT**.

11:50<sup>AM</sup>11/24

LINE1 ▶=NEXT

4 Press **↓** or **↑** to select the desired line, "LINE1" or "LINE2".

11:50<sup>AM</sup>11/24

LINE2 ▶=NEXT

5 Press **▶** **OK/EDIT** (NEXT key).

◦ "ENTER MAILBOX#" is displayed.

◦ The current number will be displayed, if it was stored beforehand.

11:50<sup>AM</sup>11/24

ENTER MAILBOX#

6 Enter your access phone number up to 32 digits.

◦ You may enter pauses\*.

◦ If you misdial, press **CLEAR**. Digits are erased from the right.

11:50<sup>AM</sup>11/24

1234567PPP8901

▶=SAVE

7 Press **▶** **OK/EDIT** (SAVE key).

◦ A beep sounds and the number is saved.

◦ The display will return to step 2. To program the other line, start from step 3. To return to the standby mode, press **FUNCTION/EXIT**.

11:50<sup>AM</sup>11/24

1234567PPP8901

SAVE MAILBOX#

◦ You can exit the programming mode any time by pressing **FUNCTION/EXIT**.

\*For quick access to your voice mail box by using **VOICE MAIL**, you may add pauses between your voice mail box access number and your mail box password in step 6.

Ex. 1-222-333-4444 PPPP 8888

Your voice mail box access number | Pauses | Your mail box password

Pressing **REDIAL/PAUSE** once creates a 3.5 second delay and counts as one digit. The delay time depends on a telephone company.

Advanced Operation

### Setting the Voice Mail Tone

If your voice mail service sends a voice mail tone after a new message has finished recording, set to "ON". "☒" icon will flash on the display if a message was recorded in your mailbox. You will hear a series of voice mail tones then a dial tone after lifting the handset or pressing **(SP-PHONE/HEADSET)**. (Contact your service provider about your service.)  
Set to "OFF" when:

- you do not subscribe to a voice mail service.
- your voice mail service does not send a voice mail tone, or
- the unit is connected to a PBX.

Your phone comes from the factory set to "ON".

**Make sure that the handset is on the cradle, the AC adaptor is connected and the SP-PHONE/HEADSET indicator light is off.**

1 Press **(FUNCTION/EXIT)**.

11:50<sup>AM</sup>11/24

SAVE AUTO# ?

2 Press  or  repeatedly until "VOICE MAIL TONE?" is displayed.

11:50<sup>AM</sup>11/24

VOICE MAIL TONE?

3 Press  **OK/EDIT**.

11:50<sup>AM</sup>11/24

LINE1      ▷=NEXT

4 Press  or  to select the desired line, "LINE1" or "LINE2".

11:50<sup>AM</sup>11/24

LINE2      ▷=NEXT

5 Press  **OK/EDIT** (NEXT key).

11:50<sup>AM</sup>11/24

ON      ▷=SAVE

6 Press  or  to select the desired mode.

7 Press  **OK/EDIT** (SAVE key).

- A beep sounds and the setting is saved.
- The display will return to step 2. To program the other line, start from step 3. To return to the standby mode, press

**(FUNCTION/EXIT)**.

◦You can exit the programming mode any time by pressing **(FUNCTION/EXIT)**.

## Listening to Voice Mail Message(s)

After receiving a voice mail message, "☒" icon will flash on the display. To listen to your voice mail, perform the following steps.

- 1 Press **VOICE MAIL**.
  - An icon of the line which has received voice mail messages will flash.
- 2 Lift the handset or press **SP-PHONE/HEADSET**.
  - The unit is connected to the telephone line and automatically dials the number.
- 3 Follow the pre-recorded instructions.
- 4 When finished, place the handset on the cradle or press **SP-PHONE/HEADSET**.
  - The display will return to the standby mode.

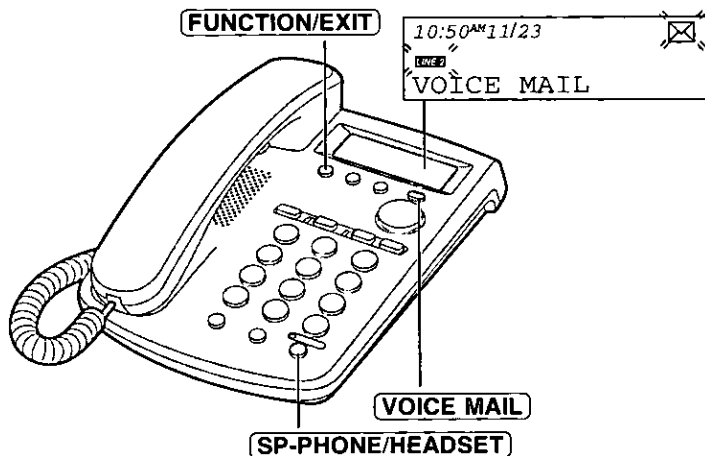

- The line which calls your voice mail service has priority over the line set using the "Line Selection" (p. 41).
- If "☒" icon still flash after you have listened to your voice mail message(s), press **VOICE MAIL**, and then press and hold **CLEAR**. "☒" icon will disappear.
- If your voice mail service uses a voice mail tone and the recorded message is over 3 minutes long, "☒" icon may not flash.
- If your voice mail service uses a voice mail tone, the tone will be heard from any parallel connected phone on the same line. If you use another phone to retrieve messages, you have to dial your access number manually.

# Special Features

---

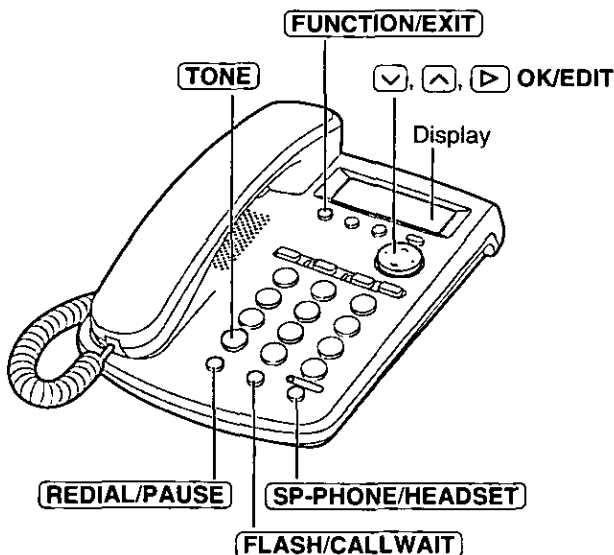

## For Call Waiting Service Users

During a conversation, if another call is being received on the same line, you will hear a call-waiting tone.

Press **FLASH/CALLWAIT** to answer the second call.

- The first call is put on hold and you can answer the second call.
- To return to the first caller, press **FLASH/CALLWAIT** again.
- The call waiting service is not available when:
  - you are having a conference call (p. 23), or
  - a parallel connected telephone on the same line is in use.
- If this function does not operate properly, consult your telephone company.

## Call Waiting Caller ID Feature

Call Waiting Caller ID Feature allows the unit to display the second caller's information. After you hear a call-waiting tone while talking, the unit will display "CALL", and the caller's name and phone number.

10:50 <sup>AM</sup> 11/23 <b>CALL</b>
<b>NUMBER</b> 1-222-333-4444
JOHN SMITH

- Please contact your telephone company for details and availability in your area.



## FLASH Button

Pressing **FLASH/CALLWAIT** allows you to use special features of your host PBX such as transferring an extension call or accessing special telephone services (optional) such as call waiting.

### Selecting the flash time

The flash time depends on your telephone exchange or host PBX. You can select the following flash times: "90, 100, 110, 250, 300, 400, 600, 700 ms (milliseconds)". Your phone comes from the factory set to "700 ms".

**Make sure that the handset is on the cradle, the AC adaptor is connected and the SP-PHONE/HEADSET indicator light is off.**

1 Press **FUNCTION/EXIT**.

11:50<sup>AM</sup>11/24

SAVE AUTO# ?

2 Press  or  repeatedly until "SET FLASH TIME ?" is displayed.

11:50<sup>AM</sup>11/24

SET FLASH TIME ?

3 Press  **OK/EDIT**.

11:50<sup>AM</sup>11/24

LINE1      ▷=NEXT

4 Press  or  to select the desired line, "LINE1" or "LINE2".

11:50<sup>AM</sup>11/24

LINE2      ▷=NEXT

5 Press  **OK/EDIT** (NEXT key).

11:50<sup>AM</sup>11/24

700MS      ▷=SAVE

6 Press  or  repeatedly until the desired time is displayed.

7 Press  **OK/EDIT** (SAVE key) to set the flash time.

◦A beep sounds.

◦The display will return to step 2. To program the other line, start from step 3. To return to the standby mode, press **FUNCTION/EXIT** or wait for 60 seconds.

◦You can exit the programming mode any time by pressing **FUNCTION/EXIT**.

◦If you are connected via a PBX, a longer flash time may be necessary to use PBX functions (transferring a call, etc.). Consult your PBX installer for the correct setting.

### Temporary Tone Dialing (For Rotary or Pulse Service Users)

Press **TONE** before entering access numbers which require tone dialing.

- The dialing mode changes to tone. You can enter numbers to access an answering service, electronic banking service, etc. When you hang up, the mode will return to pulse.

### How to Use the PAUSE Button (For Analog PBX Line/Long Distance Service Users)

We recommend you press **REDIAL/PAUSE** if a pause is required for dialing with a PBX or to access a long distance service.

Ex. Line access number **9** (PBX)

**9** ⇒ **REDIAL/PAUSE** ⇒ Phone number

- Pressing **REDIAL/PAUSE** once creates a 3.5 second pause. This prevents misdialing when you redial or dial a stored number.
- Pressing **REDIAL/PAUSE** more than once increases the length of the pause between numbers.





## Line Selection

The unit will automatically select a free line which is not being used by a parallel connected telephone when you make a call. Also the unit will select the called line when you answer a call. To change the selection, program as follows.

**Make sure that the handset is on the cradle, the AC adaptor is connected and the SP-PHONE/HEADSET indicator light is off.**

1 Press **FUNCTION/EXIT**.

11:50<sup>AM</sup>11/24

SAVE AUTO# ?

2 Press  or  repeatedly until "LINE SELECTION ?" is displayed.

11:50<sup>AM</sup>11/24

LINE SELECTION ?

3 Press  **OK/EDIT**.

11:50<sup>AM</sup>11/24

AUTO                   ▶=SAVE

◦The current selection is displayed.

**LINE1:** Line 1 will be selected.

**LINE2:** Line 2 will be selected.

**AUTO:** A free line will be selected (LINE 1 has priority) when making a call. The called line will be automatically selected when answering a call (factory preset).

4 Press  or  to select the desired setting.

5 Press  **OK/EDIT** (SAVE key).

◦A beep sounds.

◦The display will return to step 2. To return to the standby mode, press

**FUNCTION/EXIT** or wait for 60 seconds.

◦You can exit the programming mode any time by pressing **FUNCTION/EXIT**.

◦Any line can be selected manually regardless of the mode selected in step 4 by pressing the line button.

### Incoming Call Tone

While one line is being used, you may be informed by two tones if another call has arrived on the other line. This incoming call tone can be set/deleted by programming. Your phone comes from the factory set to "2".

**Make sure that the handset is on the cradle, the AC adaptor is connected and the SP-PHONE/HEADSET indicator light is off.**

1 Press **FUNCTION/EXIT**.

11:50<sup>AM</sup>11/24  
SAVE AUTO# ?

2 Press **↓** or **↑** repeatedly until "INCOMING TONE ?" is displayed.

11:50<sup>AM</sup>11/24  
INCOMING TONE ?

3 Press **▶ OK/EDIT**.

11:50<sup>AM</sup>11/24  
ON ▶=SAVE

◦The current setting is displayed.

**ON:** The incoming call tone will be heard as long as the other line rings.

**2:** The incoming call tone will only be heard 2 times (factory preset).

**OFF:** The incoming call tone will not be heard.

4 Press **↓** or **↑** to select the desired setting.

5 Press **▶ OK/EDIT** (SAVE key).

◦A beep sounds.

◦The display will return to step 2. To return to the standby mode, press

**FUNCTION/EXIT** or wait for 60 seconds.

◦You can exit the programming mode any time by pressing **FUNCTION/EXIT**.

◦If the ringer volume is set to "OFF", the incoming call tone will not be heard even if the incoming call tone is set to "ON" or "2".

# Using an Optional Headset



Plugging an optional headset into the unit provides a hands-free phone conversation.

Please use only a Panasonic KX-TCA87 or KX-TCA90 headset. To order, call the accessories telephone number on page 3.

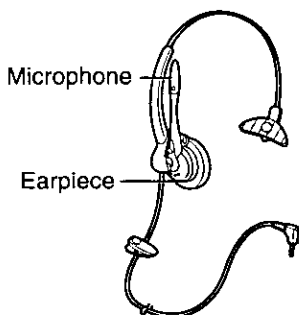

The illustration headset is a KX-TCA90.

## Connecting an Optional Headset to the Unit

Connect an optional headset to the headset jack as shown below.

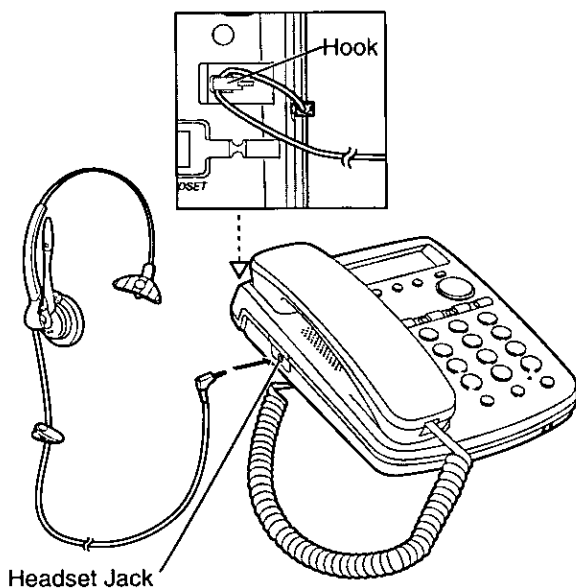

## ➤ Using an Optional Headset

### Making/Answering Calls

- 1 Press **SP-PHONE/HEADSET** to make or answer a call.
- The SP-PHONE/HEADSET indicator light flashes quickly.
  - You may also press the line button.
  - If you misdial when making a call, press **SP-PHONE/HEADSET** twice and dial again.

- 2 To hang up, press **SP-PHONE/HEADSET**.
- The indicator lights go out.

◦ While using an optional headset, you can switch to the speakerphone by pressing **▶ OK/EDIT**. Each time you press the button, the call will switch to the optional headset or speakerphone.

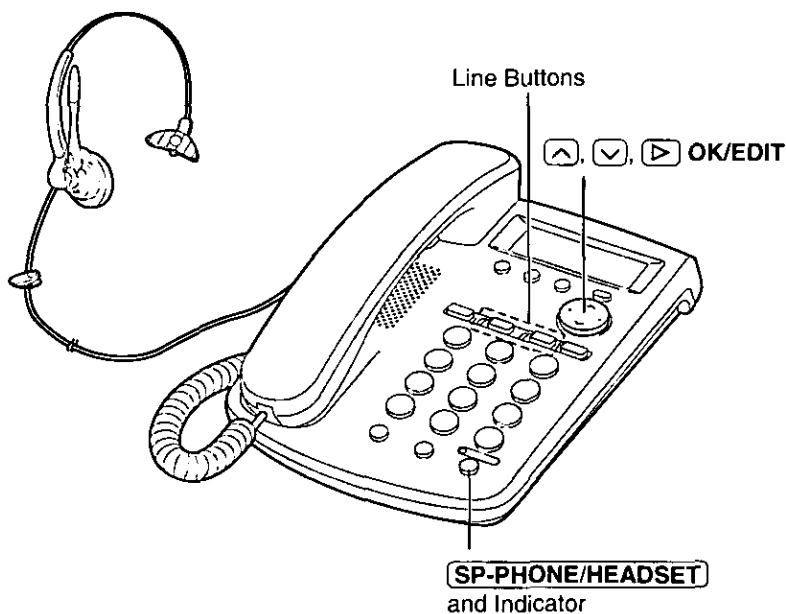

#### To adjust the headset receiver volume (4 levels):

While using the headset, press **↕** or **↗**.

#### During a conversation with an optional headset:

- The SP-PHONE/HEADSET indicator light flashes quickly.
- To switch the call to the handset during a conversation using the optional headset, lift the handset off the cradle and disconnect the optional headset.
- If you disconnect the optional headset, you can continue the conversation with the speakerphone.

# Wall Mounting

The unit can be mounted on a wall phone plate.

- 1 Connect the AC adaptor.

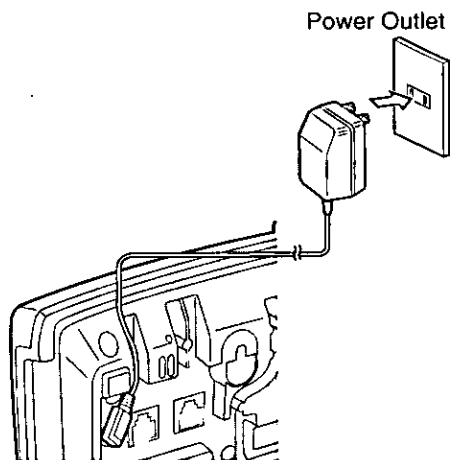

- 2 Connect the telephone line cord. Mount the unit, then slide down.

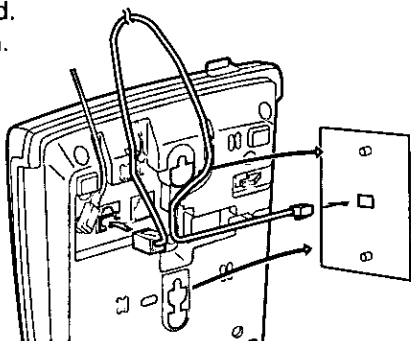

- 3 Adjust the LCD contrast level to make the display distinct (p. 12).

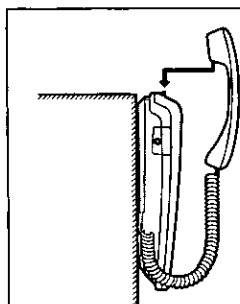

To temporarily set the handset down during a conversation, place it as shown here.

# Before Requesting Help

---

Problem	Remedy
The unit does not work.	<ul style="list-style-type: none"><li>◦ Check the settings (p. 8–18).</li><li>◦ Unplug the AC adaptor to reset. Plug in, and try again.</li></ul>
The unit does not ring.	<ul style="list-style-type: none"><li>◦ The ringer volume(s) is/are set to OFF. Set to HIGH or LOW (p. 18).</li></ul>
The line indicators do not work properly.	<ul style="list-style-type: none"><li>◦ Check the setting (p. 8–18).</li><li>◦ The line mode selection is incorrect. See page 14.</li></ul>
The line indicator(s) light never go(es) out.	<ul style="list-style-type: none"><li>◦ Unplug the AC adaptor, then plug in.</li></ul>
You cannot program function items, such as the dialing mode.	<ul style="list-style-type: none"><li>◦ Programming is not possible when the handset is off the cradle, or the SP-PHONE/HEADSET indicator lights.</li><li>◦ Do not pause for over 60 seconds while programming.</li></ul>
You cannot store a phone number in memory.	<ul style="list-style-type: none"><li>◦ Do not pause for over 60 seconds while storing.</li></ul>
While programming or searching, the unit starts to ring and stops the program/search.	<ul style="list-style-type: none"><li>◦ To answer the call, lift the handset or press <b>(SP-PHONE/HEADSET)</b>. Start again from the beginning after hanging up.</li></ul>
During a conversation, the other line indicator flashes and the display shows another caller's information.	<ul style="list-style-type: none"><li>◦ Someone is calling you on the other line. To answer, press <b>(HOLD)</b> to put the current call on hold. Then press the line button whose indicator is flashing quickly (p. 22).</li></ul>

Problem	Remedy
The unit does not display the caller's name and/or phone number.	<ul style="list-style-type: none"> <li>◦ Other telephone equipment may be interfering with your phone. Disconnect it and try again.</li> <li>◦ Other electrical appliances connected to the same outlet may be interfering with the Caller ID information.</li> <li>◦ Telephone line noise may be interfering with the Caller ID information.</li> </ul>
A caller called you, but the caller's information was not recorded in the Caller List.	◦ If you receive two calls at the same time, only one of the Caller ID information can be recorded.
The display goes to the standby mode while viewing the Caller List.	◦ Do not pause for over 60 seconds while searching.
<b>REDIAL/PAUSE</b> does not function properly.	◦ The button has a double function as either redial or pause. It will redial the last number dialed if pressed at the outset of a call (p. 20). If another number has been dialed first, it will operate as a pause button (p. 40).
You cannot have a conversation using the optional headset.	<ul style="list-style-type: none"> <li>◦ Make sure that the optional headset is connected properly (p. 43).</li> <li>◦ Press <b>SP-PHONE/HEADSET</b> to make or answer a call.</li> </ul>
Previously programmed information is erased.	◦ If a power failure occurs, programmed information may be erased. Reprogram if necessary.
If you cannot solve your problem	<ul style="list-style-type: none"> <li>◦ Call our customer call center at 1-800-211-PANA(7262).</li> <li>◦ Panasonic's e-mail address for customer inquiries: consumerproducts@panasonic.com for customers in the USA or Puerto Rico ONLY</li> </ul>

# Important Safety Instructions

---

When using this unit, basic safety precautions should always be followed to reduce the risk of fire, electric shock, or personal injury.

1. Read and understand all instructions.
2. Follow all warnings and instructions marked on this unit.
3. Unplug this unit from AC outlets before cleaning. Do not use liquid or aerosol cleaners. Use a damp cloth for cleaning.
4. Do not use this unit near water, for example, near a bathtub, washbowl, kitchen sink, or the like.
5. Place this unit securely on a stable surface. Serious damage and/or injury may result if the unit falls.
6. Do not cover slots and openings on the unit. They are provided for ventilation and protection against overheating. Never place the unit near radiators, or in a place where proper ventilation is not provided.
7. Use only the power source marked on the unit. If you are not sure of the type of power supplied to your home, consult your dealer or local power company.
8. Do not place objects on the power cord. Install the unit where no one can step or trip on the cord.
9. Do not overload wall outlets and extension cords. This can result in the risk of fire or electric shock.
10. Never push any objects through slots in this unit. This may result in the risk of fire or electric shock. Never spill any liquid on the unit.
11. To reduce the risk of electric shock, do not disassemble this unit. Take the unit to an authorized servicer when service is required. Opening or removing covers may expose you to dangerous voltages or other risks. Incorrect reassembly can cause electric shock when the unit is subsequently used.
12. Unplug this unit from the wall outlet and refer servicing to an authorized servicer when the following conditions occur:
  - A. When the power supply cord or plug is damaged or frayed.
  - B. If liquid has been spilled into the unit.
  - C. If the unit has been exposed to rain or water.



- 
- D. If the unit does not work normally by following the operating instructions. Adjust only controls covered by the operating instructions. Improper adjustment may require extensive work by an authorized servicer.
  - E. If the unit has been dropped or physically damaged.
  - F. If the unit exhibits a distinct change in performance.
13. During thunderstorms, avoid using telephones except cordless types. There may be a remote risk of an electric shock from lightning.
14. Do not use this unit to report a gas leak, when in the vicinity of the leak.

## SAVE THESE INSTRUCTIONS

**WARNING:**

TO PREVENT FIRE OR SHOCK HAZARD, DO NOT EXPOSE THIS PRODUCT TO RAIN OR ANY TYPE OF MOISTURE.

# FCC and Other Information

---

If requested by the telephone company, inform them as follows:

FCC Registration No. ....(found on the bottom of the unit)  
Ringer Equivalence .....1.0B (Line 1)  
0.2B (Line 2)

The particular telephone lines to which the equipment is connected.

This unit must not be connected to a coin operated line.

If you are on a party line, check with your local telephone company.

## **Ringer Equivalence No. (REN):**

The REN is useful in determining the quantity of devices you may connect to your telephone line and still have all of those devices ring when your telephone number is called. In most, but not all areas, the sum of the REN's of all devices connected to one line should not exceed five (5.0). To be certain of the number of devices you may connect to your line, as determined by the REN, you should contact your local telephone company to determine the maximum REN for your calling area.

In the event terminal equipment causes harm to the telephone network, the telephone company should notify the customer, if possible, that service may be stopped.

However, where prior notice is impractical, the company may temporarily cease service providing that they:

- (a) Promptly notify the customer.
- (b) Give the customer an opportunity to correct the problem with their equipment.
- (c) Inform the customer of the right to bring a complaint to the Federal Communication Commission pursuant to procedures set out in FCC Rules and Regulations Subpart E of Part 68.

The Telephone Company may make changes in its communications facilities, equipment, operations or procedures, where such action is reasonably required in the operation of its business and is not inconsistent with the rules and regulations in FCC Part 68.

If such changes can be reasonably expected to render any customer terminal equipment incompatible with telephone company communications facilities, or require modification or alteration of such terminal equipment, or otherwise materially affect its use or performance, the customer shall be given adequate notice in writing, to allow the customer an opportunity to maintain uninterrupted service.

When programming emergency numbers and/or making test calls to emergency numbers:

1. Remain on the line and briefly explain to the dispatcher the reason for the call before hanging up.
2. Perform such activities in the off-peak hours, such as early morning hours or late evenings.

---

This device complies with Part 15 of the FCC Rules. Operation is subject to the following two conditions:

(1) This device may not cause harmful interference, and (2) this device must accept any interference received, including interference that may cause undesired operation.

**CAUTION:**

Any changes or modifications not expressly approved by the party responsible for compliance could void the user's authority to operate this device.

**Note:**

This equipment has been tested and found to comply with the limits for a Class B digital device, pursuant to Part 15 of the FCC Rules. These limits are designed to provide reasonable protection against harmful interference in a residential installation. This equipment generates, uses, and can radiate radio frequency energy and, if not installed and used in accordance with the instructions, may cause harmful interference to radio communications. However, there is no guarantee that interference will not occur in a particular installation. If this equipment does cause harmful interference to radio or television reception, which can be determined by turning the equipment off and on, the user is encouraged to try to correct the interference by one or more of the following measures:

- Reorient or relocate the receiving antenna.
- Increase the separation between the equipment and receiver.
- Connect the equipment into an outlet on a circuit different from that to which the receiver is connected.
- Consult the dealer or an experienced radio/TV technician for help.

- **Environment**—do not place the unit in a room where the temperature is less than 5°C (41°F) or greater than 40°C (104°F). Allow 10 cm (4") clearance around the unit for proper ventilation. Avoid excessive smoke, dust, mechanical vibration, shock, or direct sunlight.
- **Routine care**—wipe the unit with a soft cloth. Do not use benzine, thinner, or any abrasive powder. When you leave the unit unused for a long period of time, unplug the AC adaptor from the outlet.
- **If there is any trouble**—disconnect the unit from the telephone line and connect a known working phone. If the known working phone operates properly, have your unit repaired by one of the authorized Panasonic Factory Service Centers. If the known working phone does not operate properly, consult your telephone company.

## **For product service**

- Call 1-800-211-PANA(7262) or 1-800-833-9626 for the location of an authorized servicer.
- Panasonic's e-mail address for customer inquiries:  
consumerproducts@panasonic.com  
for customers in the USA or Puerto Rico ONLY

## **When you ship the product**

- Carefully pack your unit, preferably in the original carton.
- Attach a letter, detailing the symptom, to the outside of the carton.

### Symptom

---

- Send the unit to an authorized servicer, prepaid and adequately insured.
- Do not send your unit to the Panasonic Consumer Electronics Company listed below or to executive or regional sales offices. These locations do not repair consumer products.

**Panasonic Consumer Electronics Company,  
Division of Matsushita Electric Corporation of America**  
One Panasonic Way, Secaucus, New Jersey 07094

**Panasonic Sales Company,  
Division of Matsushita Electric of Puerto Rico, Inc.**  
Ave. 65 de Infantería, Km. 9.5, San Gabriel Industrial Park  
Carolina, Puerto Rico 00985