

Panasonic

Digital Answering System

KX-TM85-B

Model No. **KX-TM85-W**

Operating Instructions



KX-TM85-B

DIGITAL

PLEASE READ BEFORE USE AND SAVE.

Before Initial Use

Please read **IMPORTANT SAFETY INSTRUCTIONS** on pages 30–32 before use.

Read and understand all instructions.

Thank you for purchasing the Panasonic automatic telephone answering system with full-digital memory.

Attach your purchase receipt here.

For your future reference

Serial No. _____ Date of purchase _____
(found on the bottom of the unit)

Name and address of dealer _____

Accessories

AC Adaptor (p. 7)
Part No. KX-A17

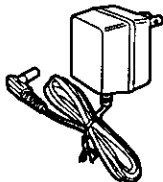

one

Telephone Line Cord
(p. 7)



one

9V Battery (p. 6)

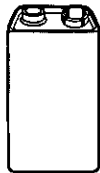

one

•To order accessories, call 1-800-211-PANA(7262).

Contents

Location of Controls	4
Display	5
Settings	6
Battery Installation	6
Connections	7
Recording a Greeting Message	8
Day and Time Adjustment	10
Selecting the Number of Rings	12
Automatic Answering Operation	13
Setting the Unit to Answer Calls	13
Listening to Messages	14
Erasing Messages	16
Recording a Memo Message	17
Remote Operation	18
Setting the Security Code	19
Voice Menu Operation	20
Direct Remote Operation	22
Battery Replacement	25
Before Requesting Help	26
FCC and Other Information	28
Important Safety Instructions	30

Location of Controls

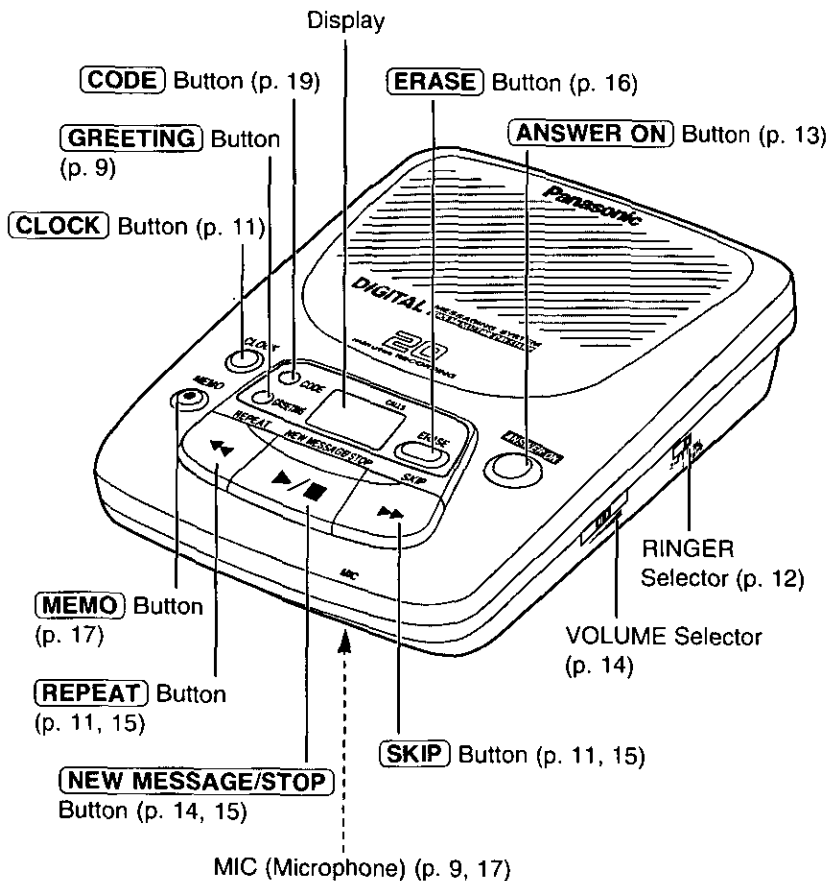

Display

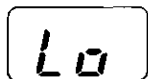

The battery is not installed or battery power is low. Install a new battery (p. 6, 25).



The answering function is turned on and no messages are recorded.



The answering function is turned off.

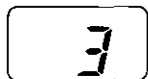

3 messages have been recorded.

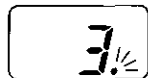

3 messages, **including new message(s)**, have been recorded. (p. 14)

↑ Flashing

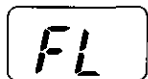

Memory is full. Erase some or all of the messages (p. 16).

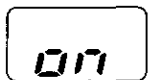

The unit is answering a call.

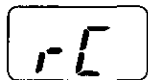

The unit is being operated from a remote phone.

Settings

Battery Installation

Install the included 9V battery in the unit.

After a new battery has been installed, the unit will retain recorded messages and maintain the correct time (p. 10) for approximately one day during a power failure.

- 1 Open the cover by pushing the tab.

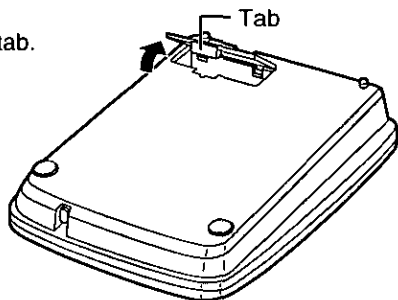

- 2 Install the battery in the battery compartment.

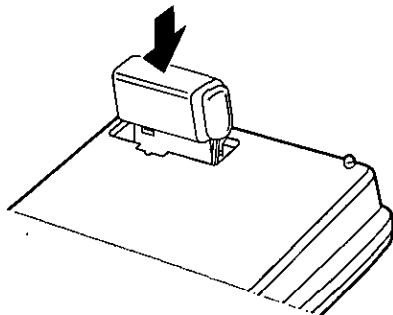
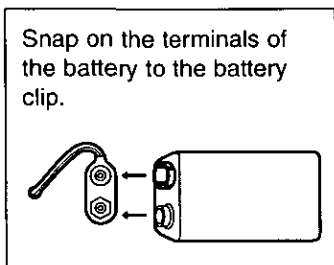

- 3 Close the cover.

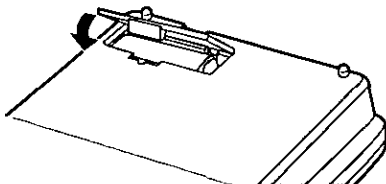

Connections

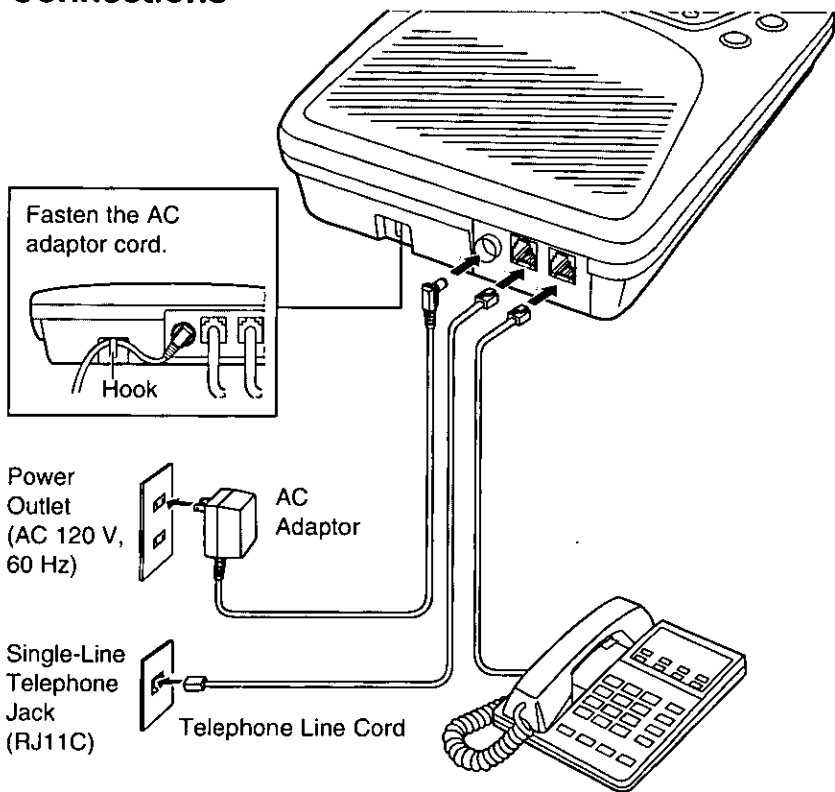

- **USE ONLY Panasonic AC ADAPTOR KX-A17.**
- The AC adaptor must remain connected at all times. (It may feel warm during use. This is normal.)
- If "Lo" flashes for over 10 seconds, the battery is not installed or battery power is low. Install a new battery (p. 25).
- If "Lo" flashes for over 10 seconds after installing a new battery, disconnect the AC adaptor and reinsert it again without removing the battery. It will disappear after 10 seconds.

▶ Settings

Recording a Greeting Message

A greeting message (announcement) must be recorded. **If a greeting message is not recorded, the unit will not answer calls.**

All of the messages (greeting, incoming, memo, etc.) are stored in digital memory. Total recording time is **about 20 minutes**. (The maximum recording time per call is 3 minutes.)

We recommend you record a **brief greeting message** leaving more time in memory.

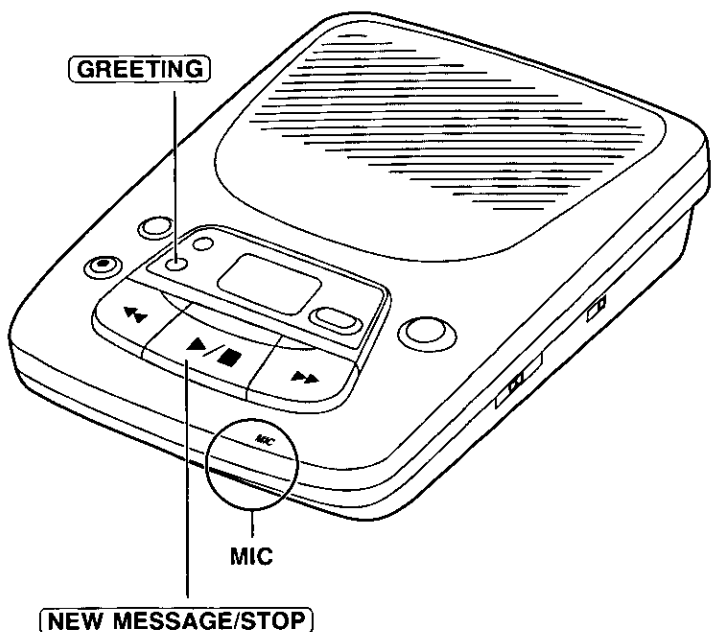



- 1 Press and hold **GREETING**.
- 2 After the long beep, continue pressing **GREETING** and speak clearly about 8 inches (20 cm) away from the **MIC** (microphone).
 - The display counts up the recording time.
- 3 When finished, release **GREETING**.
 - A short beep sounds and the recorded greeting message is played.
 - To change the greeting message, repeat from step 1.

To check the greeting message

Press and release **GREETING**.

- The recorded greeting is played.
- Press **GREETING** again or **NEW MESSAGE/STOP** to stop playback.
- If a greeting message has not been recorded, "No announcement" will be heard.

Sample of greeting message

"Hello, this is (your name and/or number). Sorry, I cannot take your call. Please leave a message after the long beep. (Your recording time is 3 minutes.) Thank you."

▶ Settings

Day and Time Adjustment

Voice Day/Time Stamp: During playback a synthesized voice will announce the day and time when each message was recorded.

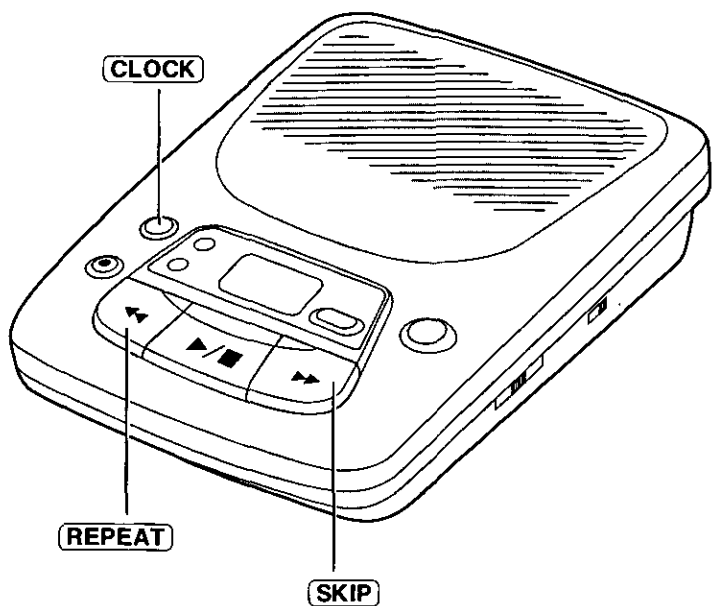



Please complete each step within 30 seconds. If not, you will have to start from the beginning (step 1).

- 1 Press and hold **CLOCK** until you hear a long beep.
- 2 Press **SKIP** or **REPEAT** until you hear the current day.
- 3 Press **CLOCK** to set the hour.
- 4 Press **SKIP** or **REPEAT** until you see the current hour displayed.
 - The unit will announce AM or PM.
- 5 Press **CLOCK** to set the minute.
- 6 Press **SKIP** or **REPEAT** until you see the current minute displayed.
 - Pressing and holding **SKIP** or **REPEAT** will change the minute display quickly.
- 7 Press **CLOCK** to set the clock.

- The clock accuracy is approximately ± 60 seconds a month at room temperature.

To check the day/time

Press **CLOCK**.

◆ Settings

Selecting the Number of Rings

You can select the number of rings before your answering system answers a call, "2", "4" or "TOLL SAVER (Factory preset)".

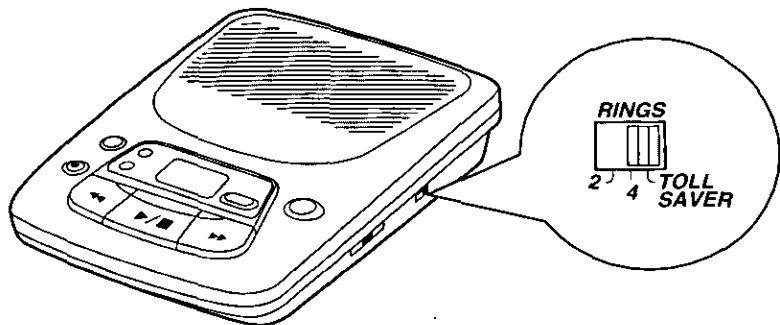

Set the **RINGER Selector** to 2, 4 or TOLL SAVER.

- 2:** The unit answers a call after the 2nd ring.
4: The unit answers a call after the 4th ring.
TOLL SAVER: Toll Saver function is selected.

Toll Saver

When you call the unit from a touch tone telephone:

If the unit answers after the 2nd ring, there is at least one new message.

If the unit answers after the 4th ring, there are no new messages.

Hang up immediately when you hear the 3rd ring. This saves you the toll charge for the call.

Automatic Answering Operation

When a call is received, the unit plays back your greeting message and records the caller's incoming message.

The maximum recording time per call is 3 minutes. (The unit will send a short beep 5 seconds before the time out, then 3 short beeps at the end of 3 minutes to alert the caller.)

- If a greeting message has not been recorded, the unit will not answer calls. Record a greeting message (p. 9).
- The total recording time (including the greeting message) is about 20 minutes.
- A maximum of 62 messages can be recorded.
- If the remaining recording time is less than 10 seconds or the unit records 62 messages, the display will show "FL". The unit will answer a call after 15 rings and announce "Memory is full." The call will be terminated after 8 seconds. Erase some or all of the messages (p. 16).

Setting the Unit to Answer Calls

Press **ANSWER ON** to turn on the answering function.

- The display shows "0" and "Answer function is on." is heard.
- If you do not want the unit to answer calls, press **ANSWER ON** again to turn off. The display shows "—" and "Answer function is off." is heard.
- You can turn on the answering function by using a touch tone phone (p. 24).

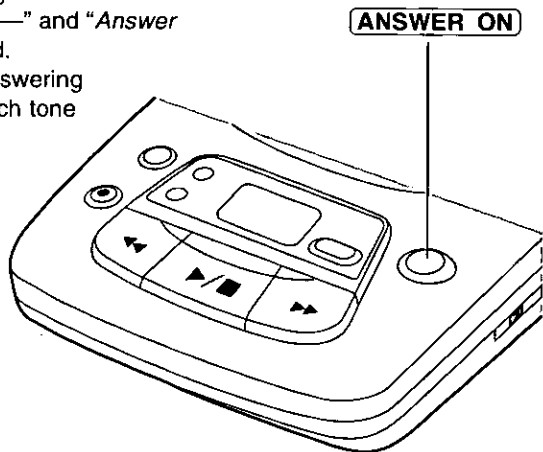

Listening to Messages

When new incoming messages have been recorded, the display shows the total number of recorded messages and the NEW MESSAGE indicator flashes.

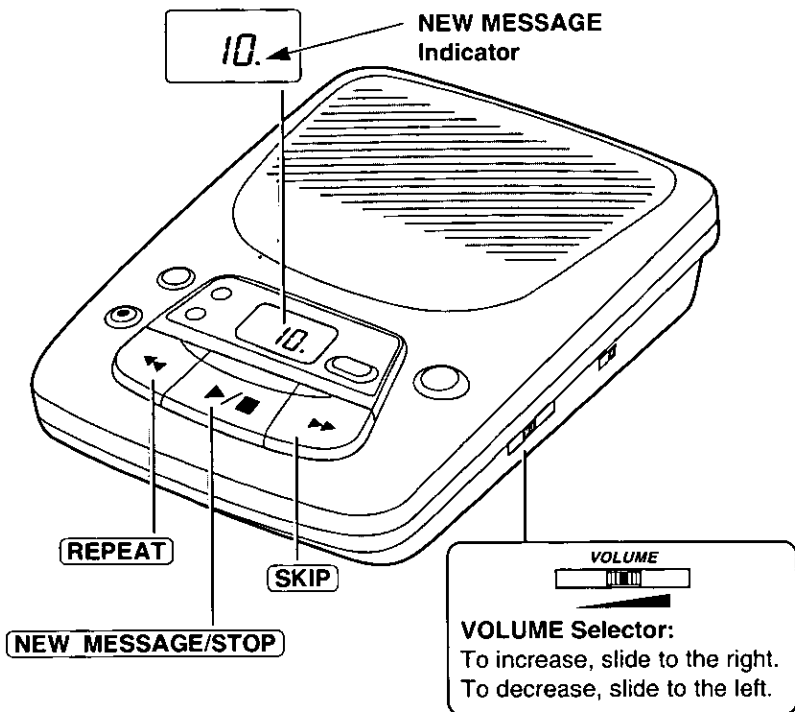

Press and release **NEW MESSAGE/STOP** to listen to the new messages.

- If there are no new messages, all of the recorded messages will be played back.
- The unit announces the number of new incoming messages or incoming messages and plays them back.
- All of the recorded messages are saved until you erase them (p. 16).
- If there are no messages, "No message" is heard.
- At the end of the last message, "End of message(s)" is heard.

During playback:

To repeat the message	Press and release REPEAT to repeat the current message. Press and hold REPEAT for 2 seconds to repeat the previous message.
To skip the message	Press and release SKIP to skip to the next message.
To stop the operation	Press and release NEW MESSAGE/STOP to stop playback.

- A tone is heard after you press any of the keys above.
- If you skip or stop a new message during playback, the message will not be treated as a new message.

Monitoring incoming calls

While a call is being recorded, you can monitor it through the speaker. To answer the call, lift the handset of the telephone connected to the same line.

- You can adjust the volume by using the VOLUME selector (p. 14).
- If the answering machine does not stop working when you answer the call, press **NEW MESSAGE/STOP**. You can also stop it by pressing **0** on the touch tone telephone.

Erasing Messages

Erasing a specific message

You may erase a specific message in memory.

Press and release **ERASE** while the message you want to erase is being played.

- A tone is heard.
- The unit erases the message.
- The unit continues to play the next message.

Erasing all of the messages

You may erase all of the recorded messages in memory after listening to them. If there are any messages in memory you have not listened to, the unit will announce "New messages" and you cannot erase them.

Press and hold **ERASE** until a long beep is heard while the message is not being played.

- The display shows "0".

*If the NEW MESSAGE indicator flashes, there is a new message.

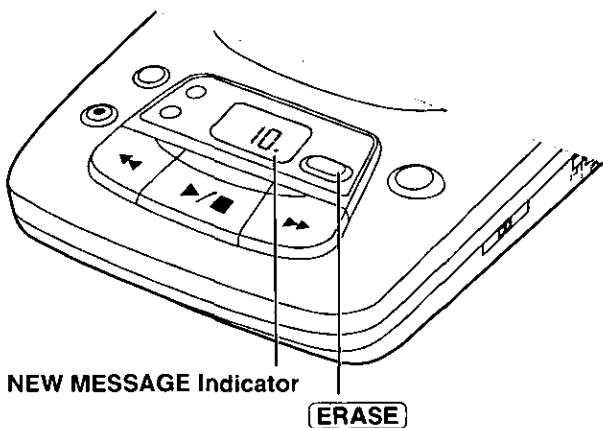

Recording a Memo Message

You may record a personal message in memory.

- 1 Press and release **MEMO**.
 - A long beep is heard.
 - 2 After the long beep, speak clearly about 8 inches (20 cm) away from the **MIC** (microphone).
 - The display counts up the recording time.
 - 3 When finished recording, press **MEMO** or **NEW MESSAGE/STOP**.
 - A beep is heard.
- If your memo message is less than 1 second, 3 beeps will be heard and it can not be recorded.

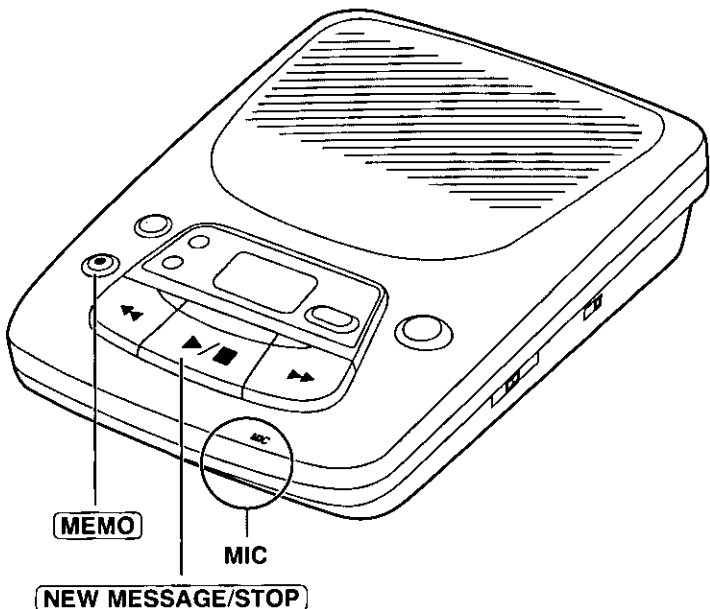

Remote Operation

You can operate the answering function from any outside touch tone phone. The synthesized voice menu will guide you on how to operate the unit (p. 20).

Remote operation summary

- 1 Call your unit from a touch tone phone.
 - The greeting message is heard.



- 2 Enter your security code number after the greeting message is played back (p. 19).
 - Press each button **firmly**. After pressing the 3rd digit, a long beep is heard and the voice menu starts.



- 3 The voice menu starts (p. 20).
Follow the menu or enter a direct command (p. 22).
If the voice menu does not start, enter the security code number again within 8 seconds.



- 4 To end the remote operation, hang up.
 - The messages are saved.

- Do not press the “#” button for a few seconds. Some long distance services use “#” for other purposes and these services may take priority over the remote operation.
- For your convenience, you can use the dial card on pages 33–34.
- Even if the voice menu has started, other command buttons can be used.
- During message playback, only the 7, 8, 9, 0 and * keys can be used.

Setting the Security Code

The security code prevents unauthorized persons from accessing and listening to your messages remotely. Choose any 3-digit number (111–999). The factory preset is "888".

Please complete each step within 30 seconds. If not, you will have to start from the beginning (step 1).

- 1 Press and hold **CODE** until a long beep is heard.
 - The display flashes the 1st preset digit.
- 2 Press **SKIP** or **REPEAT** until the desired number is displayed.
- 3 Press and release **CODE**.
 - A beep is heard.
 - The display flashes the 2nd preset digit.
- 4 Repeat steps 2 and 3 to set the 2nd digit.
 - A beep is heard.
 - The display flashes the 3rd preset digit.
- 5 Repeat steps 2 and 3 to set the 3rd digit.
 - A beep is heard.

To check the security code

Press and release **CODE**.

- The current security code is displayed digit by digit.

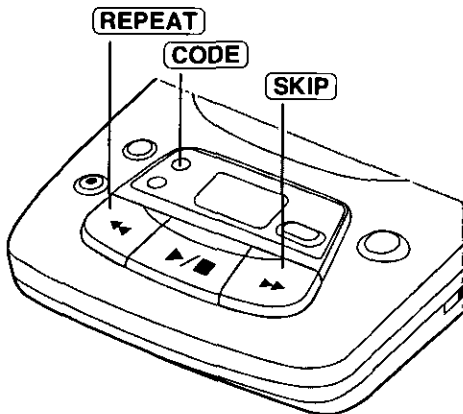

▶ Remote Operation

Voice Menu Operation

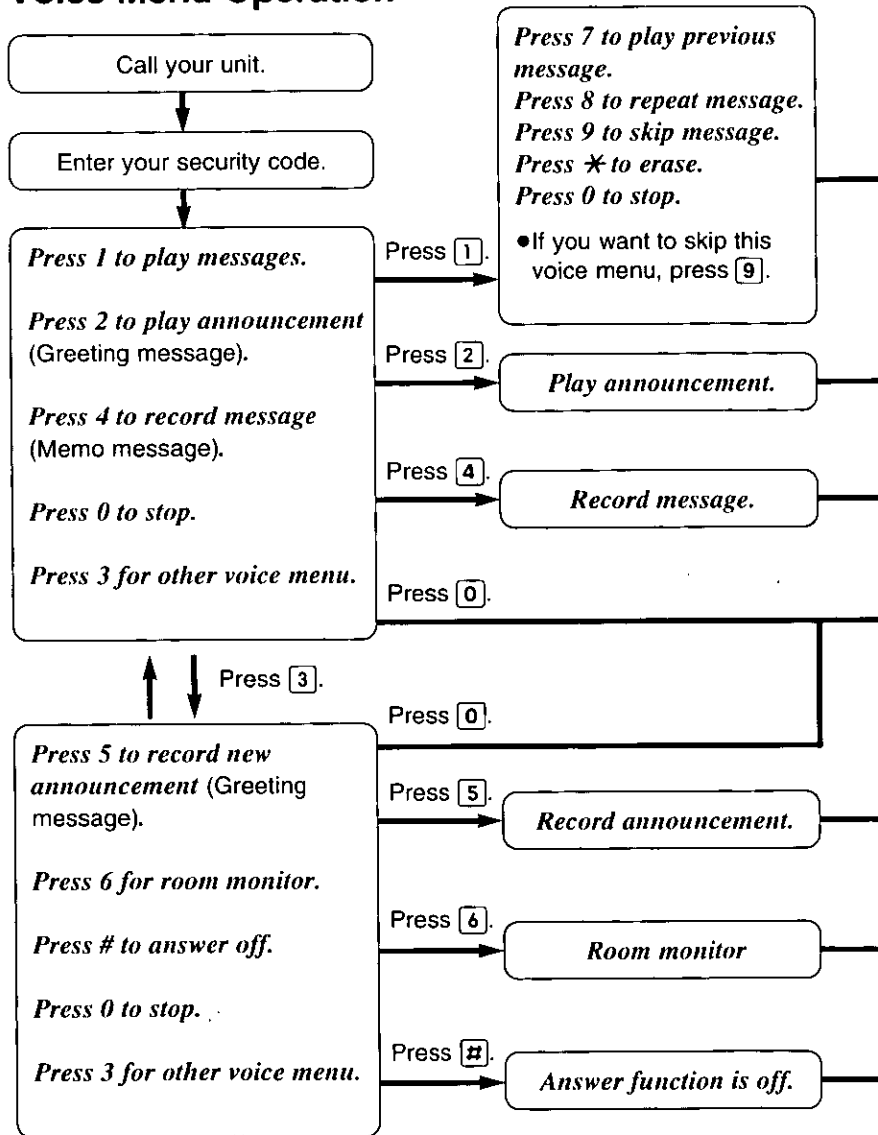

**Message playback**

The unit plays back the new messages. (If there are no new messages, all of the recorded messages will be played back.) At the end of the last message, "*End of messages*" is heard.

Greeting Message (announcement) playback

The unit plays back the greeting message.

Recording a Memo Message

Record your personal message. When finished, press **0**.

Current operation stop

The unit stops the current operation. Press another function key.

Recording a Greeting Message (announcement)

Re-record your greeting message. When finished, press **0**.

Room Monitor

You can monitor the sound around the unit for about 15 seconds.

Turning off the answering system.

The unit is turned off and will not record messages.

▶ Remote Operation

Direct Remote Operation

Once you have entered your security code, you can also control your unit by direct remote commands instead of using the voice menu. To end the remote operation, hang up.

List of the direct commands

MESSAGE PLAYBACK	1	• New messages are played back. (If there are no new messages, all of the recorded messages will be played back.)
GREETING MESSAGE PLAYBACK	2	• The current greeting message (announcement) is played.
NEXT VOICE MENU	3	• The next voice menu is played.
MEMO MESSAGE RECORDING	4	• You can leave your own message (up to 3 minutes) after "Record Message." and a long beep is heard. When finished press 0.
GREETING MESSAGE RECORDING	5	• You can record a new greeting message after "Record announcement." and a long beep is heard. When finished press 0.
ROOM MONITOR	6	• After "Room monitor" is heard you can monitor the sound around the unit for 15 seconds. To continue, press 6 again.



PREVIOUS
MESSAGE
PLAYBACK
(During
playback)

7

- The previous message is played back.

REPEAT
(During
playback)

8

- The current message is repeated from the beginning.

SKIP
(During
playback)

9

- The current message is skipped and the next message is played.

STOP

0

- The current operation is stopped. Press another function key.

ERASE
(During
playback)

*

- The current message is erased.

ANSWERING
FUNCTION
OFF

#

- The answering function is turned off.
"Answer function is off." is heard.
-

► Remote Operation

Turning on the answering function

- ① Call your unit and wait for 15 rings.
 - The unit answers and “*Answer function is off.*” is heard. (If a greeting message has not been recorded, 3 beeps are heard. Record a greeting message*.)
- ② Enter your security code within 8 seconds.
- ③ When you hear the voice menu, hang up or enter the direct command.

—*If a greeting message has not been recorded,

- ① Call your unit and wait for 15 rings.
 - The unit answers and 3 beeps are heard.
- ② Enter your security code within 8 seconds.
 - The voice menu starts.
- ③ Press **[5]**.
- ④ After “*Record announcement.*” and a long beep is heard, record a greeting message.
- ⑤ Press **[0]**.
- ⑥ Hang up.

When memory is full

The unit will answer after the 15th ring and announce “*Memory is full.*”. After 8 seconds, the unit will automatically terminate the call.

To record new incoming messages;

- ① Call your unit and wait for 15 rings.
 - “*Memory is full.*” is heard.
- ② Enter your security code within 8 seconds.
 - The voice menu starts.
- ③ Press **[1]** to play back recorded messages.
- ④ Press **[*]** to erase messages.
- ⑤ Hang up.

Battery Replacement

If "Lo" flashes on the display, the battery power is low and needs to be replaced. Once you have installed a new battery, the unit will retain recorded messages and maintain the correct time (p. 10) for approximately one day during a power failure.

To avoid losing your greeting and messages saved in memory, the AC adaptor must remain connected.

Open the cover and install a new battery. Then close the cover (p. 6).

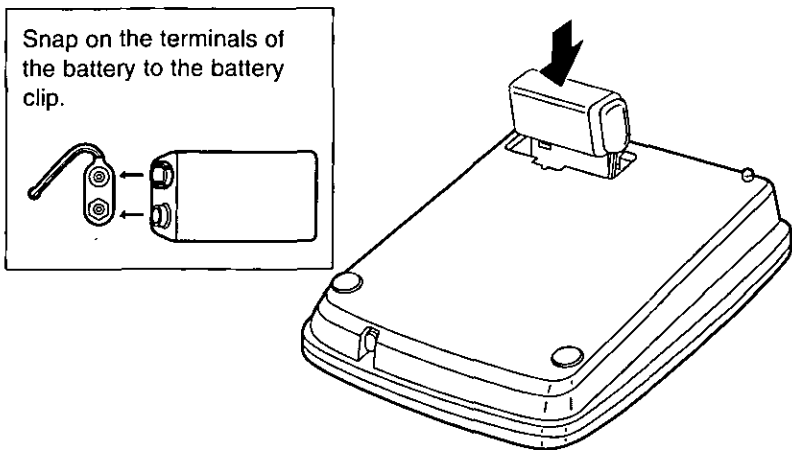

- If "Lo" flashes for over 10 seconds after installing a new battery, disconnect the AC adaptor and reinsert it again without removing the battery. It will disappear after 10 seconds.

Precautions:

The battery should be used correctly, otherwise the unit may be damaged due to battery leakage.

- Do not charge, short-circuit, disassemble, heat or dispose in fire.
- Disconnect the telephone line cord before opening the battery compartment cover.
- Replace the battery once a year to prevent operation failures.
- Do not install a Nickel-Cadmium battery in the unit.

Before Requesting Help

Problem	Remedy
The unit does not work.	<ul style="list-style-type: none">● Check the settings (p. 6–9).● Check the power source.
During message playback or monitoring a call, nothing is heard.	<ul style="list-style-type: none">● Adjust the VOLUME selector.
You can not record a greeting message. Nothing (announcement, beep, etc.) is heard from the unit.	<ul style="list-style-type: none">● Connect ONLY Panasonic AC ADAPTOR KX-A17.
3 short beeps are heard when operating the unit.	<ul style="list-style-type: none">● The unit rejected your code or operation. Try again.
The answering function is on, but messages were not recorded.	<ul style="list-style-type: none">● Record a greeting message (p. 8, 24).● Memory is full. Erase some or all of the messages (p. 16).
You cannot erase all of the messages and “New messages” is heard.	<ul style="list-style-type: none">● Listen to all of the messages.
When you lift the handset of the connected telephone after the unit answers a call, the greeting does not stop.	<ul style="list-style-type: none">● Press NEW MESSAGE/STOP or 0 on the touch tone telephone, then you can answer the call (p. 15).
The unit stops working during operation.	<ul style="list-style-type: none">● Unplug the AC adaptor to reset. Plug in, then try again.

Problem	Remedy
You cannot operate the answering function from a touch tone phone.	<ul style="list-style-type: none"> ● Turn the answering function on (p. 24). ● Enter your correct security code. ● Enter the remote command after the greeting message playback and a long beep. ● Press each button for more than 1 second to produce a long tone. ● In some areas, the remote operation may not function due to telephone line conditions.
"Lo" is flashing on the display.	<ul style="list-style-type: none"> ● A battery is not installed in the unit or battery power is low. Install a new battery (p. 6, 25).
After a power failure, the greeting message is lost.	<ul style="list-style-type: none"> ● If a power failure occurs while "Lo" is displayed, the greeting message will be erased. Install a new battery, then record the greeting message again (p. 8).
"Lo" flashes for over 10 seconds even after installing a new battery.	<ul style="list-style-type: none"> ● Disconnect the AC adaptor and then reinsert it without removing the battery. "Lo" will disappear after 10 seconds.
<p>While operating the unit, the AC adaptor feels warm.</p> <p>I cannot use the unit during a power failure.</p>	<ul style="list-style-type: none"> ● These are normal conditions.
If you cannot solve your problem.	<ul style="list-style-type: none"> ● Call our customer call center at 1-800-211-PANA(7262).

FCC and Other Information

If requested by the telephone company, inform them as follows:
FCC Registration No.

(found on the bottom of the unit)
Ringer Equivalence0.1B

The particular telephone line to which the equipment is connected.

This unit must not be connected to a coin operated line.
If you are on a party line, check with your local telephone company.

Ringer Equivalence No. (REN):
The REN is useful in determining the quantity of devices you may connect to your telephone line and still have all of those devices ring when your telephone number is called. In most, but not all areas, the sum of the REN's of all devices connected to one line should not exceed five (5.0). To be certain of the number of devices you may connect to your line, as determined by the REN, you should contact your local telephone company to determine the maximum REN for your calling area.

In the event terminal equipment causes harm to the telephone network, the telephone company should notify the customer, if possible, that service may be stopped.
However, where prior notice is impractical, the company may temporarily cease service providing that they:

- (a) Promptly notify the customer.
- (b) Give the customer an opportunity to correct the

- problem with their equipment.
- (c) Inform the customer of the right to bring a complaint to the Federal Communication Commission pursuant to procedures set out in FCC Rules and Regulations Subpart E of Part 68.

The Telephone Company may make changes in its communications facilities, equipment, operations or procedures, where such action is reasonably required in the operation of its business and is not inconsistent with the rules and regulations in FCC Part 68.

If such changes can be reasonably expected to render any customer terminal equipment incompatible with telephone company communications facilities, or require modification or alteration of such terminal equipment, or otherwise materially affect its use or performance, the customer shall be given adequate notice in writing, to allow the customer an opportunity to maintain uninterrupted service.

CAUTION:

Any changes or modifications not expressly approved by the party responsible for compliance could void the user's authority to operate this device.

This device complies with Part 15 of the FCC Rules. Operation is subject to the following two conditions: (1) This device may not cause harmful interference, and (2) this device must accept any interference received, including interference that may cause undesired operation.

Note:

This equipment has been tested and found to comply with the limits for a Class B digital device, pursuant to Part 15 of the FCC Rules. These limits are designed to provide reasonable protection against harmful interference in a residential installation. This equipment generates, uses, and can radiate radio frequency energy and, if not installed and used in accordance with the instructions, may cause harmful interference to radio communications. However, there is no guarantee that interference will not occur in a particular installation. If this equipment does cause harmful interference to radio or television reception, which can be determined by turning the equipment off and on, the user is encouraged to try to correct the interference by one or more of the following measures:

- Reorient or relocate the receiving antenna.
 - Increase the separation between the equipment and receiver.
 - Connect the equipment into an outlet on a circuit different from that to which the receiver is connected.
 - Consult the dealer or an experienced radio/TV technician for help.
- **Environment**—do not place the unit in rooms where the temperature is less than 5°C (41°F) or greater than 40°C (104°F). Allow 10 cm (4") clearance around the unit for proper ventilation. Avoid excessive smoke, dust, mechanical vibration, shock, or direct sunlight.
 - **Routine care**—wipe the unit with a soft cloth. Do not use benzine, thinner, or any abrasive powder. When you leave the unit unused for a long period of time, unplug the AC adaptor from the outlet.
 - **If there is any trouble**—disconnect the unit from the telephone line and connect a known working phone. If the known working phone operates properly, have your unit repaired by one of the authorized Panasonic Factory Service Centers. If the known working phone does not operate properly, consult with your telephone company.

Important Safety Instructions

When using this unit, basic safety precautions should always be followed to reduce the risk of fire, electric shock, or personal injury.

1. Read and understand all instructions.
2. Follow all warnings and instructions marked on this unit.
3. Unplug this unit from AC outlets before cleaning. Do not use liquid or aerosol cleaners. Use a damp cloth for cleaning.
4. Do not use this unit near water, for example, near a bathtub, washbowl, kitchen sink, or the like.
5. Place this unit securely on a stable surface. Serious damage and/or injury may result if the unit falls.
6. Do not cover slots and openings on the unit. They are provided for ventilation and protection against overheating. Never place the unit near radiators, or in a place where proper ventilation is not provided.
7. Use only the power source marked on the unit. If you are not sure of the type of power supplied to your home, consult your dealer or local power company.
8. Do not place objects on the power cord. Install the unit where no one can step or trip on the cord.
9. Do not overload wall outlets and extension cords. This can result in the risk of fire or electric shock.
10. Never push any objects through slots in this unit. This may result in the risk of fire or electric shock. Never spill any liquid on the unit.
11. To reduce the risk of electric shock, do not disassemble this unit. Take the unit to an authorized servicer when service is required. Opening or removing covers may expose you to dangerous voltages or other risks. Incorrect reassembly can cause electric shock when the unit is subsequently used.
12. Unplug this unit from the wall outlet and refer servicing to an authorized servicer when the following conditions occur:
 - A. When the power supply cord or plug is damaged or frayed.
 - B. If liquid has been spilled into the unit.



- C. If the unit has been exposed to rain or water.
 - D. If the unit does not work normally by following the operating instructions. Adjust only controls covered by the operating instructions. Improper adjustment may require extensive work by an authorized servicenter.
 - E. If the unit has been dropped or physically damaged.
 - F. If the unit exhibits a distinct change in performance.
13. During thunderstorms, avoid using telephones except cordless types. There may be a remote risk of an electric shock from lightning.
14. Do not use this unit to report a gas leak, when in the vicinity of the leak.

SAVE THESE INSTRUCTIONS

CAUTION:

To reduce the risk of fire or injury to persons, read and follow these instructions.

1. Use only the battery(ies) specified.
2. Do not dispose of the battery(ies) in a fire. It (they) may explode. Check with local waste management codes for special disposal instructions.
3. Do not open or mutilate the battery(ies). Released electrolyte is corrosive and may cause burns or injury to the eyes or skin. The electrolyte may be toxic if swallowed.
4. Exercise care in handling the battery(ies) in order not to short the battery(ies) to conductive materials such as rings, bracelets, and keys. The battery(ies) and/or conductor may overheat and cause burns.
5. Do not recharge the battery(ies) provided with or identified for use with this product. The battery(ies) may leak corrosive electrolyte or explode.
6. Do not attempt to rejuvenate the battery(ies) provided with or identified for use with this

► Important Safety Instructions

product by heating. Sudden release of battery electrolyte may occur causing burns or irritation to the eyes or skin.

7. Remove the battery(ies) from this product if the product will not be used for a long period of time (several months or more). During this time the battery(ies) could leak in the product.
8. Discard the “dead” battery(ies) as soon as possible. The “dead” battery(ies) may leak in the product.
9. Do not store this product, or the battery(ies) provided with or identified for use with this product, in high temperature areas. Batteries that are stored in a freezer or refrigerator for the purpose of extending shelf life should be protected from condensation during storage and defrosting. Batteries should be stabilized at room temperature prior to use after cold storage.

WARNING:

TO PREVENT FIRE OR SHOCK HAZARD, DO NOT EXPOSE THIS PRODUCT TO RAIN OR ANY TYPE OF MOISTURE.

OPERATION FROM TONE PHONE

Call your unit.



Enter your security code _____.



Enter the direct command.
OR
Follow the voice menu.



To end the remote operation,
hang up.

To record your memo message (up to 3 minutes)

- ① Press **[4]**.
- ② Speak after the long beep.
- ③ When finished, press **[0]**.

To re-record the greeting message

- ① Press **[5]**.
- ② Speak after the long beep.
- ③ When finished, press **[0]**.

- When you press a button, press firmly for more than 1 second.

No.	Remote Command
1	Playing a Message
2	Playing Back Greeting Message
3	Playing the Next Voice Menu
4	Recording a Memo Message
5	Recording a New Greeting Message
6	Room Monitor
7	Previous Message Playback
8	Repeat a Message
9	Skip a Message
0	Stop the Operation
*	Erasing a Message
#	Answer Off

To turn the answering function on

- ① Call your unit and wait for 15 rings.
- ② Enter your security code.
- ③ When you hear the voice menu, hang up or enter the direct command.
 - If a greeting message is not recorded, record it before hanging up.

For product service

- Panasonic Servicenters are listed in the servicenter directory.
- Call 1-800-211-PANA(7262) for the location of an authorized servicenter.

When you ship the product

- Carefully pack your unit, preferably in the original carton.
- Attach a letter, detailing the symptom, to the outside of the carton.

Symptom

- Send the unit to an authorized servicenter, prepaid and adequately insured.
- Do not send your unit to the Panasonic Consumer Electronics Company listed on the next page or to executive or regional sales offices. These locations do not repair consumer products.

Panasonic Consumer Electronics Company,
Division of Matsushita Electric Corporation of America
One Panasonic Way, Secaucus, New Jersey 07094

Panasonic Sales Company,
Division of Matsushita Electric of Puerto Rico, Inc.
Ave. 65 de Infantería, Km. 9.5, San Gabriel Industrial Park
Carolina, Puerto Rico 00985