

Panasonic

Cordless Answering System

Model No. **KX-TC1040W**
KX-TC1500B
KX-TC1500W
KX-TC1507B

Pulse-or-tone dialing capability

Operating Instructions

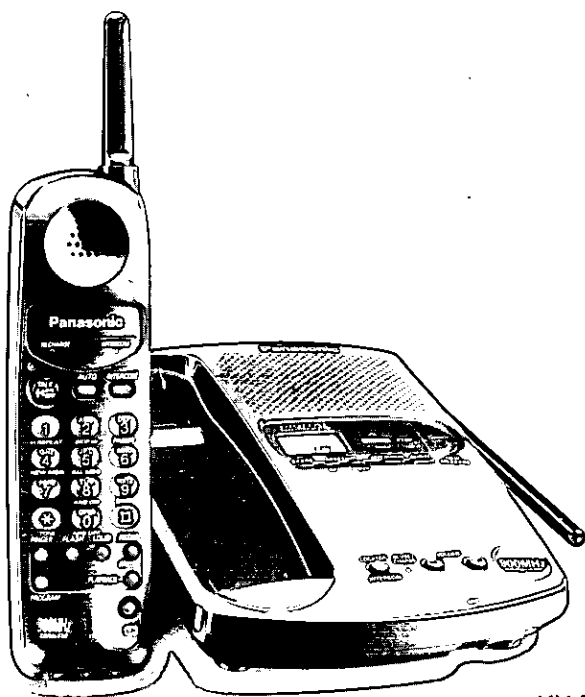

KX-TC1500B

PLEASE READ BEFORE USE AND SAVE.

Charge the battery fully before initial use.
KX-TC1040W: for 10 hours
KX-TC1500B/W, KX-TC1507B: for 4 hours

Preparation

Cordless Telephone

Answering System

Useful Information

For Best Performance

Battery Charge

A rechargeable Ni-Cd battery powers the handset. Charge the battery fully before initial use (p. 11).

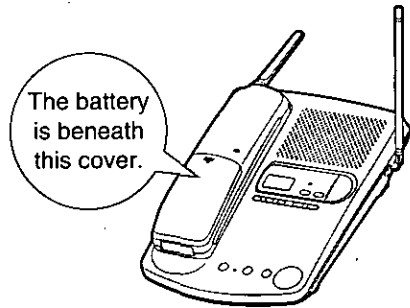

Base Unit Location

Calls are transmitted between the base unit and the handset using wireless radio waves. **For maximum distance and noise-free operation**, the recommended base unit location is:

Away from electrical appliances such as a TV, radio or personal computer.

In a **HIGH** and **CENTRAL** location with no obstructions such as walls.

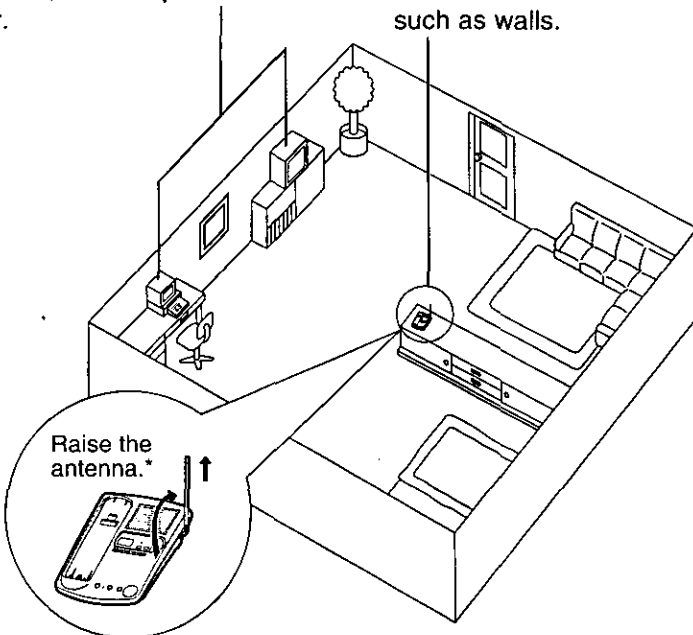

* For KX-TC1040W users:
Raise the antenna and extend it fully.

Contents

Preparation

Location of Controls	6
Settings	10
Connections	10
Battery Charge	11
Selecting the Dialing Mode	12
Selecting the Handset Ringer Volume	13
Preparing the Answering System	14
Greeting Message	14
Programming Summary for the Answering System	16
Time and Day Adjustment	17
Selecting the Caller's Recording Time	18
Selecting the Number of Rings	19

Cordless Telephone

Making Calls	20
Answering Calls	21
Speed Dialer	22
Storing Phone Numbers in Memory	22
Dialing a Stored Number	23
Intercom	24
Special Features	25
FLASH Button	25
For Call Waiting Service Users	26
Temporary Tone Dialing (For Rotary or Pulse Service Users) ..	26
Automatic Security Code Setting	27
How to Use the PAUSE Button (For Analog PBX Line/Long Distance Service Users)	27

Answering System

Automatic Answering Operation	28
Setting the Unit to Answer Calls	28
Listening to Messages	29
From the Handset	31
Erasing Messages	32
Pager Call	33
Storing a Pager Number	33
Setting the Unit to Call a Pager	35
Remote Operation from a Touch Tone Phone	36
Setting the Remote Code	37
Voice Menu	38
Direct Remote Operation	40
Remote Operation with the Handset	42

Useful Information

Battery Replacement	45
Wall Mounting	46
Adding Another Phone	47
Before Requesting Help	48
Important Safety Instructions	52
FCC and Other Information	54

Preparation

Cordless Telephone

Answering System

Useful Information

Location of Controls

Base unit

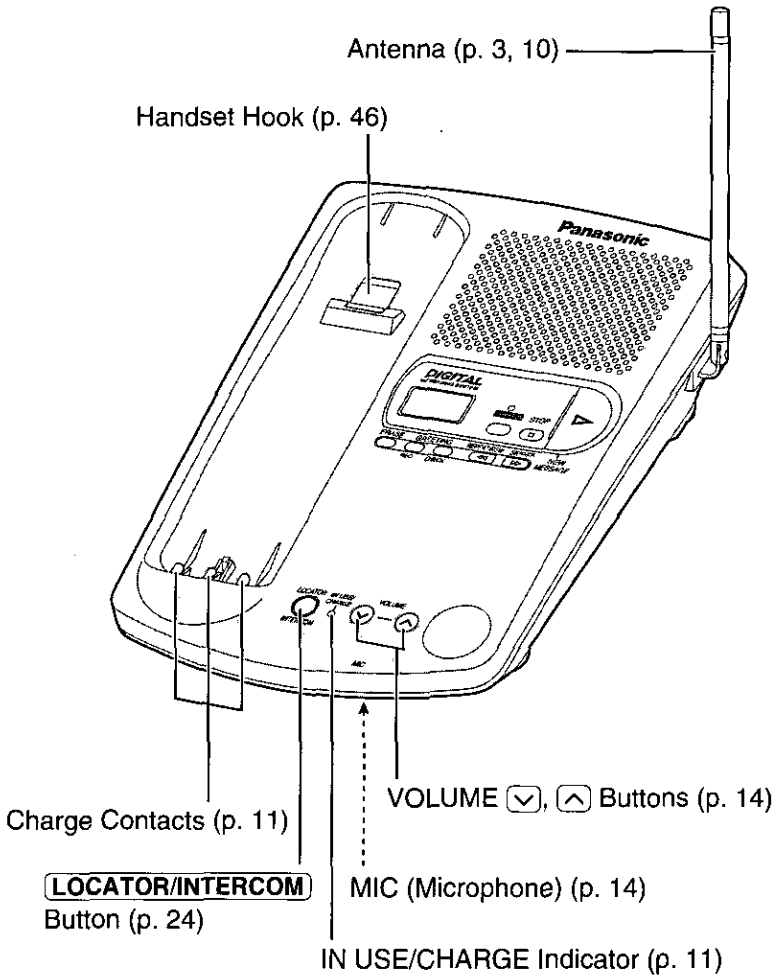

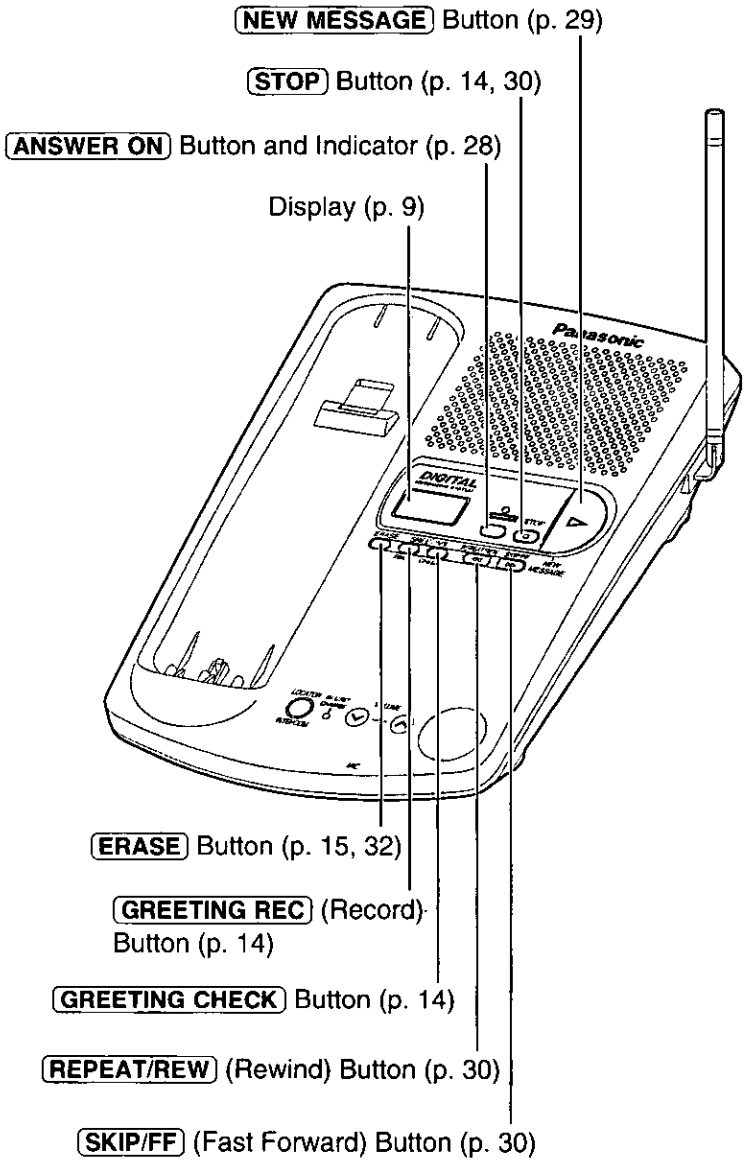

► Location of Controls

Handset

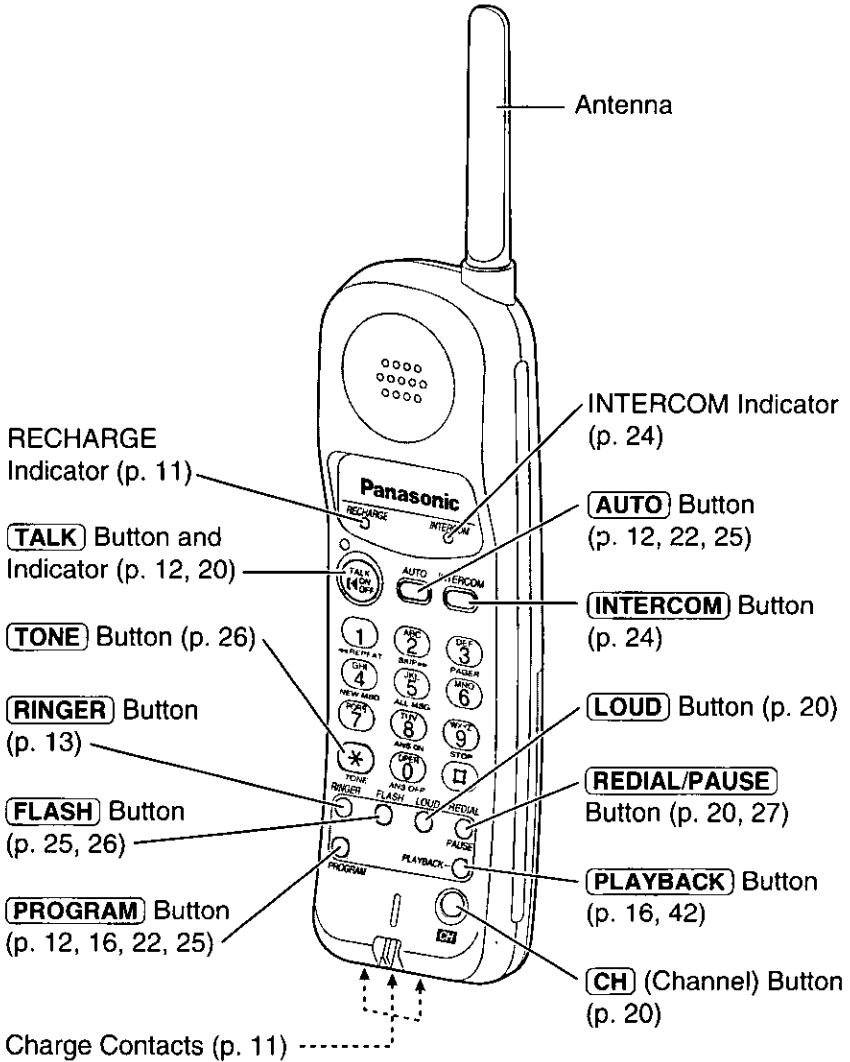

Base unit display



The clock needs adjusting (p. 17).

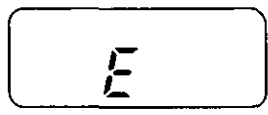

Your greeting message was not recorded correctly. Record it again (p. 14).

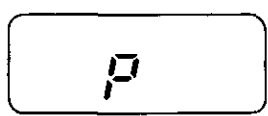

The unit is in the answering system programming mode.

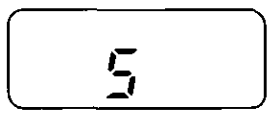

The speaker volume level is set to "5". You can select 9 levels (0-8) while using the answering system (p. 14, 29).

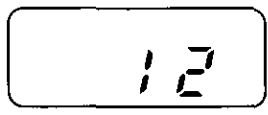

12 messages have been recorded.

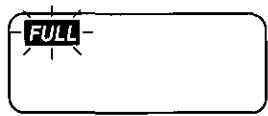

Memory is full. Erase some or all of the messages (p. 32).



The recording time is set to "greeting only" (p. 18). (The display is blank.)



The pager call mode is set to ON (p. 35).

Settings

Connections

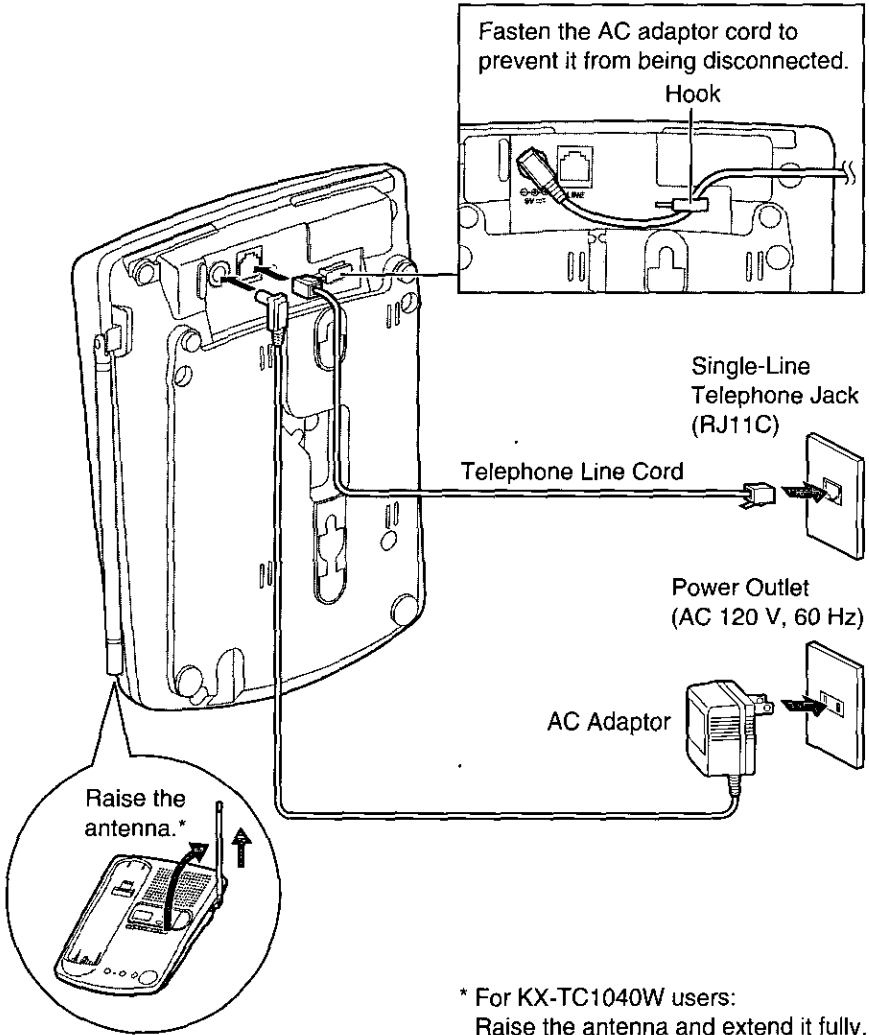

- USE ONLY WITH Panasonic AC ADAPTOR PQLV1 (Order No. PQLV1Z).
- The AC adaptor must remain connected at all times. (It is normal for the adaptor to feel warm during use.)
- To connect a standard telephone on the same line, see page 47.



Battery Charge

Place the handset on the base unit and charge the battery fully before initial use.

KX-TC1040W: for 10 hours

KX-TC1500B/W, KX-TC1507B: for 4 hours

- The IN USE/CHARGE indicator lights.

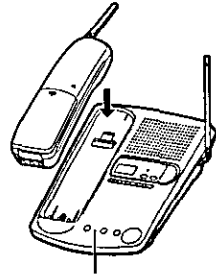

IN USE/CHARGE Indicator

Recharge

When the RECHARGE indicator flashes, or the unit beeps intermittently, recharge the battery as shown above.

- If you DO NOT recharge the handset battery
 - for more than 15 minutes (KX-TC1500B/W, KX-TC1507B),
 - for more than 30 minutes (KX-TC1040W),
 the RECHARGE indicator will continue to flash.

Battery information

After your Panasonic battery is fully charged:

Operation	Approx. battery life
While in use (TALK)	Up to about 8 hours
While not in use (Stand-By)	Up to about 30 days (KX-TC1040W) Up to about 21 days (KX-TC1500B/W, KX-TC1507B)

- Battery life may vary depending on usage conditions and ambient temperature.
- Clean the handset and the base unit charge contacts with a soft, dry cloth once a month. Clean more often if the unit is subject to grease, dust or high humidity.** Otherwise the battery may not charge properly.
- If the battery is fully charged, you do not have to place the handset on the base unit until the RECHARGE indicator flashes. This will maximize the battery life.
- The battery cannot be overcharged.

► Settings

Selecting the Dialing Mode

You can program the dialing mode **using the handset near the base unit**. If you have touch tone service, set to TONE. If rotary or pulse service is used, set to PULSE. Your phone comes from the factory set to TONE. **The TALK indicator light must be off before programming.**

- 1 Press **PROGRAM**.
 - The TALK indicator flashes.
- 2 Press **AUTO**.
- 3 To select PULSE, press **#** twice.
OR
To select TONE, press ***** twice.
- 4 Press **PROGRAM**.
 - A beep sounds.

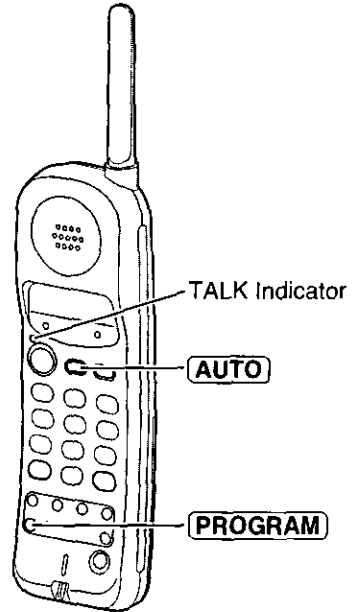

- To cancel during programming, press **PROGRAM**. Start again from step 1.
- If 3 beeps sound during programming,
 - a wrong key was pressed. Start again from step 1.
 - the handset is too far from the base unit. Move closer to the base unit or place the handset on the base unit. Start again from step 1.

If a power failure occurs, the mode will return to the factory preset (TONE). Reprogram if necessary.

Selecting the Handset Ringer Volume

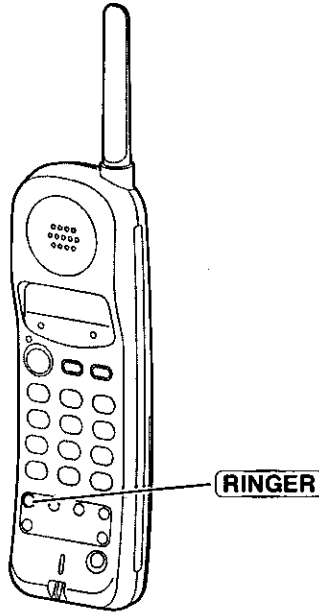

The TALK indicator light must be off.

- To select **HIGH (preset) or LOW**, press **RINGER**.
(Each time you press the button, the ringer volume will change and the selected volume will ring.)
- To turn the ringer **OFF**, press and hold **RINGER** until 2 beeps sound.
- To turn the ringer **ON**, press **RINGER**. The ringer will sound at the HIGH level.

Preparing the Answering System

Greeting Message

You can record a personal greeting message of **up to 2 minutes**. If a greeting message is not recorded, one of two pre-recorded greetings will be played when a call is received (p. 15).

All messages (greeting, incoming, etc.) are stored in digital memory (p. 15). The **total recording time is about 15 minutes**.

We recommend you record a **brief greeting message** (see sample on next page) in order to leave more time for recording new messages.

To record a greeting message

1 Press **[GREETING REC]** to start the recording mode.

- "Press RECORD again to record greeting" is heard.

2 Within 5 seconds, press **[GREETING REC]** again to record your greeting.

- A long beep sounds.

3 After the long beep, talk clearly, about 8 inches (20 cm) away from the **MIC** (microphone).

- The display shows the elapsed recording time.
- If you record for over 2 minutes, the unit will stop recording automatically.

4 When finished, press **[STOP]**.

- **To check** the recorded greeting, press **[GREETING CHECK]**.
- **To change** the message, repeat from step 1.

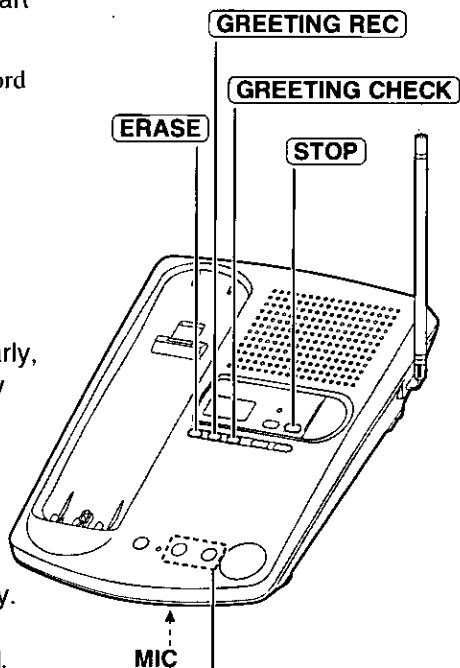

To increase the volume, press **VOLUME** .
To decrease, press **VOLUME** .



Greeting message sample

“Hello, this is (your name and/or number). Sorry I cannot take your call. Please leave a message after the beep. Thank you.”

- If the unit starts to ring while recording a greeting message, press **TALK** or lift the handset off the base unit to answer the call. The recording will stop. Start again from the beginning after hanging up.

To erase the recorded greeting message

Press **GREETING CHECK** → press **ERASE** while the message is being played.

- The unit will answer a call with a pre-recorded greeting.

Pre-recorded greeting message

If you do not record a greeting message (p. 14), one of two messages will be played when a call is received, depending on the caller's recording time (p. 18).

To check the pre-recorded greeting, press **GREETING CHECK**.

- A pre-recorded greeting will be played as follows:
 - When the recording time is set to “1 minute” or “3 minutes”;
“Hello, we are not available now. Please leave your name and phone number after the beep. We will return your call.”
 - When the recording time is set to “greeting only”;
“Hello, we are not available now. Please call again. Thank you for your call.”

Flash Memory Message Backup

Messages are stored indefinitely on a “flash memory” IC chip and will not be affected by power failures. All messages are saved until you erase them.

► Preparing the Answering System

Programming Summary for the Answering System

You can program the following functions **using the handset near the base unit**. See the page numbers below for details.

The TALK indicator light must be off before programming.

Lift the handset, and press **PROGRAM**.



Press **PLAYBACK**.



- If an alarm tone sounds, move closer to the base unit and try again.

To adjust **the time and day**, press **0**. (page 17)

To set **the remote code**, press **1**. (page 37)

To select **the number of rings**, press **2**. (page 19)

To select **the caller's recording time**, press **5**. (page 18)

To store a **pager number**, press **#**. (page 33, 34)

- The display shows numbers or characters related to the adjustment or settings.



Press **PROGRAM**.

- A beep sounds.
- If 6 beeps sound, the setting is not correct. Start again from the beginning.

- To cancel during programming, press **PROGRAM**. Start again from the beginning.
- If 6 beeps sound during programming, a wrong key was pressed. Enter the correct number.

If a power failure occurs, the setting may return to the factory preset. Reprogram if necessary.



Time and Day Adjustment

Voice Time/Day Stamp: During playback, a synthesized voice will announce the time and day that each message was recorded.

- 1 Press **PROGRAM**.
 - The TALK indicator flashes.
- 2 Press **PLAYBACK**.
 - “P” is displayed on the base unit.
- 3 Press **0**.
 - “Set time” is announced.
If previously adjusted, the time/day will be heard.
- 4 Enter the current time (hour and minute) using a 4-digit number. (Ex. To set 9:30, enter “0930”).
 - The entered number is displayed.
- 5 Press ***** to select “AM” or “PM”.
Press **#** repeatedly to set the day.
- 6 Press **PROGRAM**.
 - The unit announces the time/day.
The clock starts working.

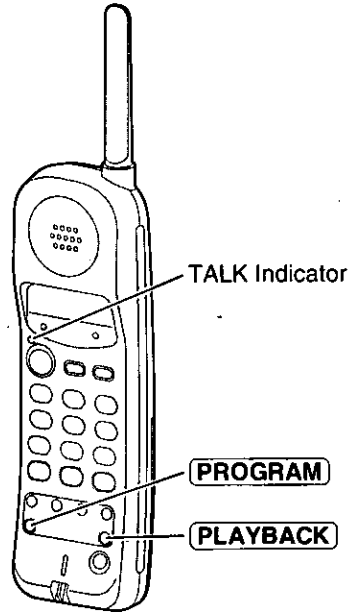

- In step 4, you cannot enter numbers greater than 12. **Do not use military time.** (To set 13:00 hours, enter “0100” and select “PM” by pressing *****.)
- The accuracy of the clock is approximately ± 60 seconds a month at room temperature.

To check the time/day

Press **PROGRAM** → **PLAYBACK** → **0**.

- The current time/day is heard. When finished, press **PROGRAM**.

If a power failure occurs, the adjusted time/day will be erased.
Reprogram the current time/day.

► Preparing the Answering System

Selecting the Caller's Recording Time

You can select "1 minute", "3 minutes" or "greeting only" for the caller's recording time. Your phone comes from the factory set to "3 minutes".

- 1 Press **PROGRAM**.
 - The TALK indicator flashes.
- 2 Press **PLAYBACK**.
 - "P" is displayed on the base unit.
- 3 Press **5**.
 - The current setting is displayed.
 - 1: 1 minute
 - 2: 3 minutes (factory preset)
 - 3: greeting only
- 4 Press **1**, **2** or **3** to select the recording time.
 - The setting is displayed.
- 5 Press **PROGRAM**.
 - A beep sounds.

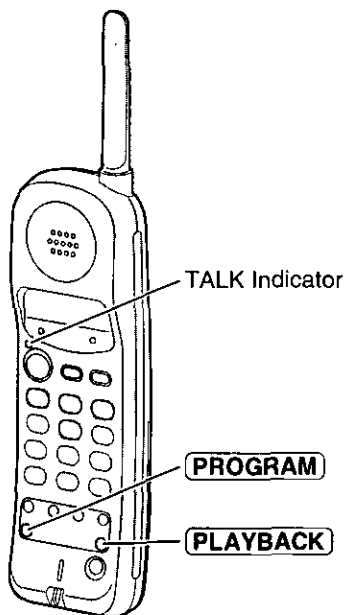

If you select "greeting only", the unit will answer a call with the greeting message, and then hang up. The unit will not record any incoming messages.

Selecting the Number of Rings

You can select the number of times the unit rings before the answering system answers a call, from "2" to "7" or "AUTO (for Toll Saver)". Your phone comes from the factory set to "AUTO".

- 1 Press **PROGRAM**.
 - The TALK indicator flashes.

- 2 Press **PLAYBACK**.
 - "P" is displayed on the base unit.

- 3 Press **2**.
 - The current setting is displayed.

- 4 Press **0**, or **2** to **7** to set the number of rings.
 - 0: Selects "AUTO".
"A" is displayed.
 - 2-7: The unit will answer after the selected number of rings.

- 5 Press **PROGRAM**.
 - A beep sounds.

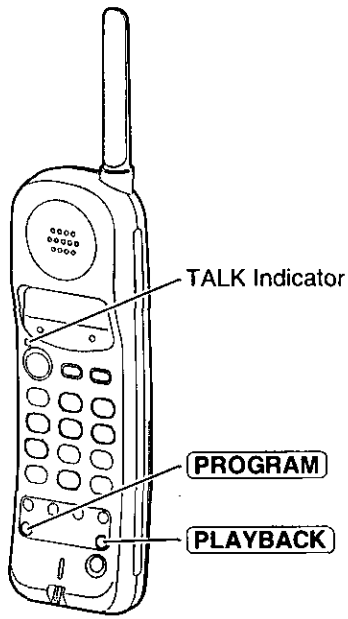

*** Toll Saver (When set to "AUTO")**

When you call the unit from a touch tone telephone:
If the unit answers on the 2nd ring, there is at least one new message.
If the unit answers on the 4th ring, there are no new messages.
Hang up when you hear the 3rd ring. This will save you the toll charge for the call.

Making Calls

- 1 Press **TALK**.
 - The TALK indicator lights.
- 2 Dial a telephone number.
- 3 To hang up, press **TALK** or place the handset on the base unit.
 - The indicator light goes out.

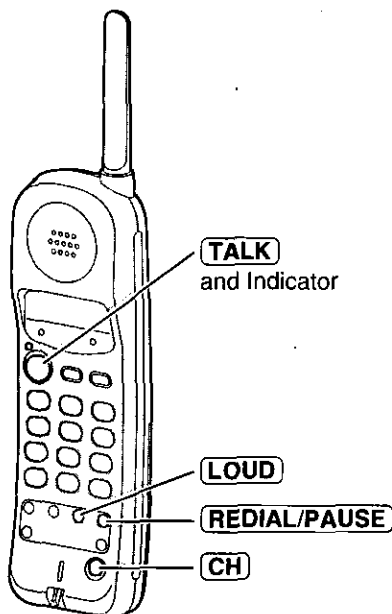

- If an alarm tone sounds in step 1, move closer to the base unit or place the handset on the base unit, and try again.

To redial the last number dialed

Press **TALK** → **REDIAL/PAUSE**.

To select the receiver volume

Press **LOUD** while talking.

- Each time you press the button, the volume level will change from MEDIUM (preset) to HIGH to LOW.

If noise interferes with the conversation

Press **CH** to select a clearer channel or move closer to the base unit.

Answering Calls

If the handset is off the base unit, press **TALK**.

- You can also answer a call by pressing any dialing button **0** to **9**, ***** or **#** (—Any Key Talk).



OR

If on the base unit, just lift up.

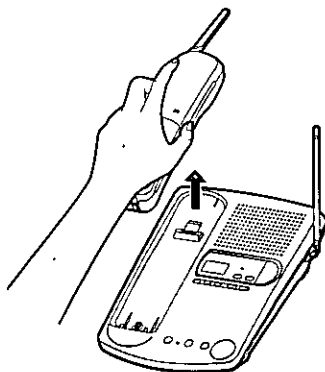

Cordless Telephone

Speed Dialer

Storing Phone Numbers in Memory

You can store up to 10 phone numbers in the handset. The dialing buttons (0 to 9) function as memory stations.

The TALK indicator light must be off before programming.

1 Press **PROGRAM**.
•The TALK indicator flashes.

2 Enter a phone number up to 22 digits.
•If you misdial, press **PROGRAM** to end storing, and start again from step 1.

3 Press **AUTO**.

4 Press a memory station number (0 to 9).
•A beep sounds.
•To store other numbers, repeat steps 1 through 4.

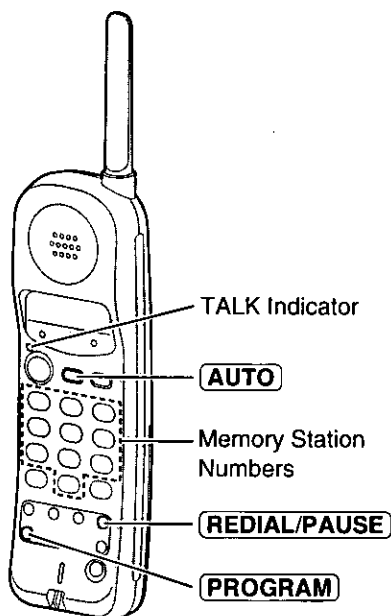

•If a pause is required for dialing, press **REDIAL/PAUSE** where needed. Pressing **REDIAL/PAUSE** counts as one digit (p. 27).

To erase a stored number

Press **PROGRAM** → **AUTO** → the memory station number (0 to 9) for the phone number to be erased.

Dialing a Stored Number

- 1 Press **TALK**.
- 2 Press **AUTO**.
- 3 Press the memory station number (0 to 9).
 - The stored number is dialed.

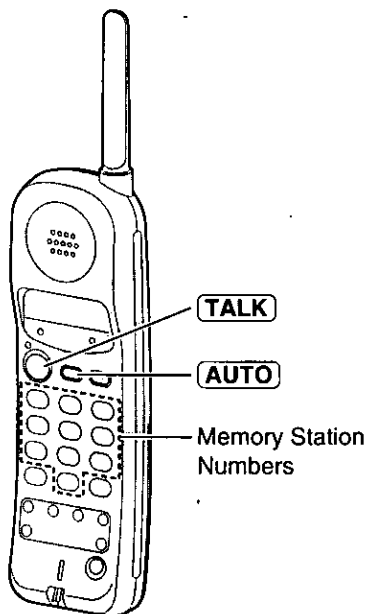

Cordless Telephone

- If your line has rotary or pulse service, any access numbers stored after pressing **TONE** will not be dialed.

Intercom

A 2-way intercom is available between the handset and the base unit.

Paging the base unit from the handset

- 1 Handset:**
Press **INTERCOM**.
Talk to the paged party after the beeps.
 - The indicator lights.
- 2 Base unit:**
When the other party's voice is heard, answer using the **MIC**.
- 3 Handset:**
To end the intercom, press **INTERCOM**.

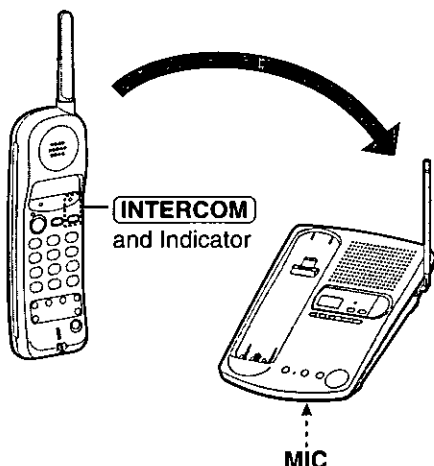

Paging the handset from the base unit (Handset locator)

Using this feature, you can locate a misplaced handset.

- 1 Base unit:**
Press **LOCATOR/INTERCOM**.
 - The handset beeps for 1 minute.
 - To stop paging, press **LOCATOR/INTERCOM** again.
- 2 Handset:**
Press **INTERCOM** to answer.
- 3 Base unit:**
Talk into the **MIC**.
- 4 Handset:**
To end the intercom, press **INTERCOM**.

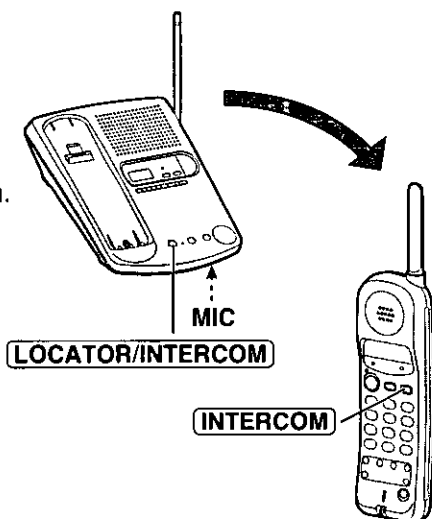

During the intercom call:

- Intercom calls can only be ended with the handset.
- If an incoming call is received, the intercom call stops and the unit starts to ring. To answer, press **TALK**.

Special Features



FLASH Button

Pressing **(FLASH)** allows you to use special features of your host PBX such as transferring an extension call or accessing special telephone services (optional) such as call waiting.

Selecting the flash time

The flash time depends on your telephone exchange or host PBX. You can select the following flash times: "90, 100, 110, 250, 300, 400, 600, 700 msec (milliseconds)", **using the handset near the base unit**. Your phone comes from the factory set to "700 msec".

The TALK indicator light must be off before programming.

- 1 Press **(PROGRAM)**.
 - The TALK indicator flashes.

- 2 Press a dialing button (**(1)** to **(8)**).

(1) : 90 msec	(2) : 100 msec
(3) : 110 msec	(4) : 250 msec
(5) : 300 msec	(6) : 400 msec
(7) : 600 msec	(8) : 700 msec

- 3 Press **(AUTO)**.

- 4 Press **(FLASH)**.
 - A beep sounds.

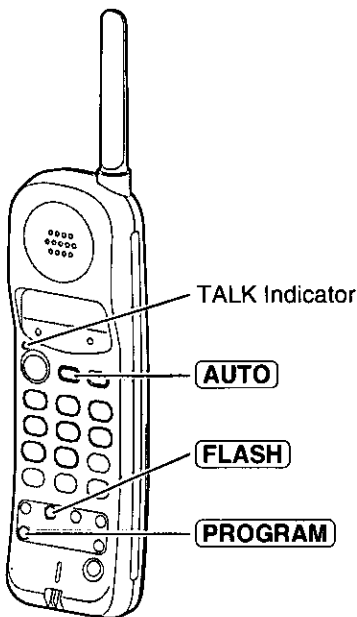

Cordless Telephone

- If 3 beeps sound in step 4,
 - a wrong key was pressed. Start again from step 1.
 - the handset is too far from the base unit. Move closer to the base unit or place the handset on the base unit. Start again from step 1.
- If you are connected via a PBX, a longer flash time may be necessary to use PBX functions (transferring a call, etc.). Consult your PBX installer for the correct setting.

If a power failure occurs, the setting will return to the factory preset (700 msec). Reprogram if necessary.

► Special Features

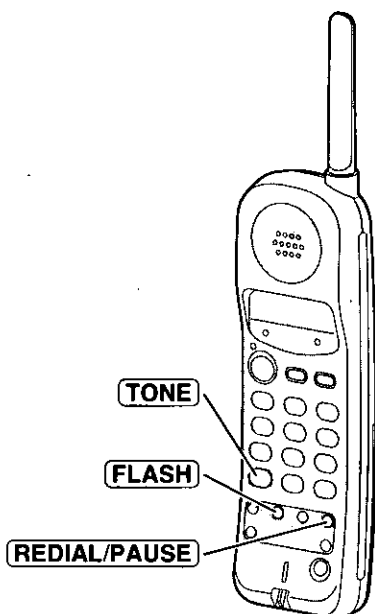

For Call Waiting Service Users

Press **FLASH** if you hear a call-waiting tone while talking.

- The first call is put on hold and you can answer the second call.
- To return to the first caller, press **FLASH** again.
- If this function does not operate properly, the flash time may not be set correctly. Consult your telephone company for details. See page 25 for how to adjust the flash time.

Temporary Tone Dialing (For Rotary or Pulse Service Users)

Press **TONE** before entering access numbers which require tone dialing.

- The dialing mode changes to tone. You can enter numbers to access an answering service, electronic banking service, etc. When you hang up, the mode will return to pulse.
- Access numbers entered after pressing **TONE** will not be included when redialing.

Automatic Security Code Setting

Whenever you place the handset on the base unit, the unit automatically selects one of a million security codes. These codes help prevent the unauthorized use of your telephone line by another cordless telephone user.

How to Use the PAUSE Button (For Analog PBX Line/Long Distance Service Users)

We recommend you press **REDIAL/PAUSE** if a pause is required for dialing with a PBX or to access a long distance service.

Ex. Line access number **9** (PBX)

9 → **REDIAL/PAUSE** → Phone number

- Pressing **REDIAL/PAUSE** once creates a 3.5 second pause. This prevents misdialing when you redial or dial a stored number.
- Pressing **REDIAL/PAUSE** more than once increases the length of the pause between numbers.

Automatic Answering Operation

When the unit answers a call, a greeting message is played and the caller's message is recorded.

- The total recording time (including greeting message) is **about 15 minutes**. If messages are recorded in noisy rooms, the time may be shortened by up to 3 minutes.
- A maximum of 64 messages (including greeting message) can be recorded.

Setting the Unit to Answer Calls

Press **ANSWER ON** to turn on the answering system.

- The indicator lights and "Answer set" is heard.
- The unit will announce the remaining recording time if it is less than 5 minutes.
- If you hear "Memory full", "**FULL**" is displayed and the ANSWER ON indicator flashes rapidly, erase some or all of the messages (p. 32).

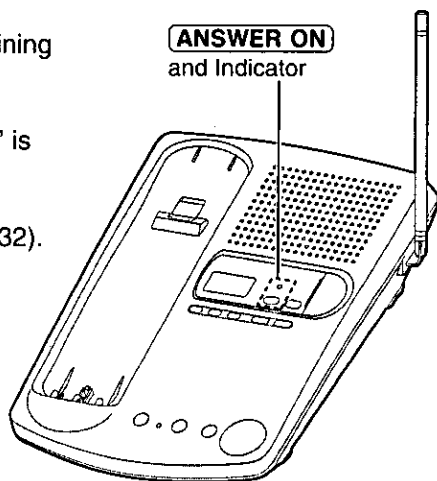

- If you do not want the unit to answer calls, press **ANSWER ON** again to turn off the answering system. The indicator light goes out and "Answer off" is heard.
- You can also turn on the answering system remotely using any other phone (p. 41).

Monitoring incoming calls

While a call is being recorded, you can monitor it through the speaker. To answer the call, lift the handset off the base unit or press **TALK** on the handset. The unit stops recording.

Listening to Messages



You can see the total number of recorded messages on the display. If the ANSWER ON indicator flashes, new messages have been recorded.

Listening to only new messages

Press **NEW MESSAGE** briefly.

- The unit announces the number of new messages and plays them back.

Listening to all recorded messages

Press and hold **NEW MESSAGE** firmly until playback starts.

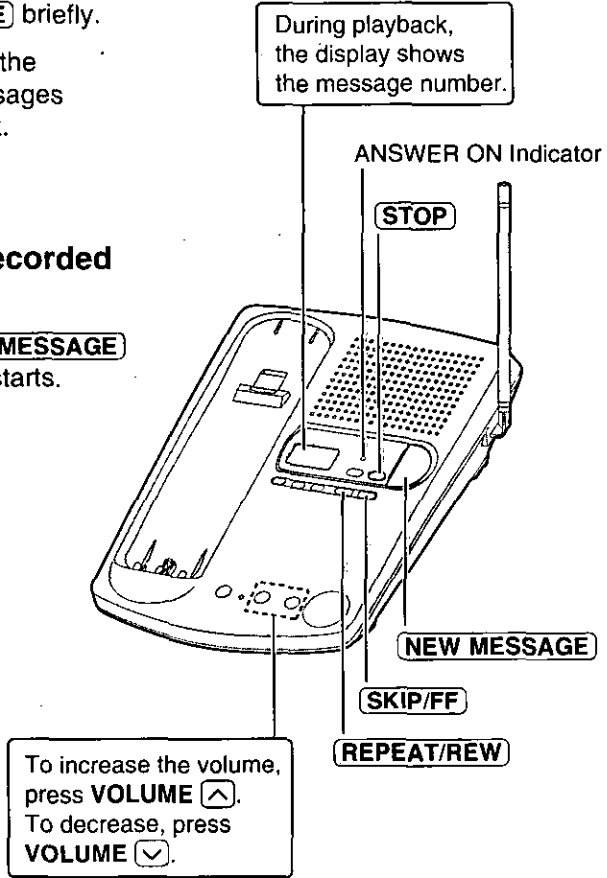

- At the end of the last message, "End of final message" is heard. The unit will announce the remaining recording time if it is less than 5 minutes.

▶ Listening to Messages

During playback

<p>To repeat/ rewind message</p>	<p>To repeat from the beginning of the message Press REPEAT/REW briefly. (If you press within 5 seconds of playback, the previous message will be played.)</p> <p>To rewind part of the message Press and hold REPEAT/REW until you reach the desired place.</p> <ul style="list-style-type: none">●At the beginning of the message, 3 beeps will sound.
<p>To skip/cue message</p>	<p>To skip to the next message Press SKIP/FF briefly.</p> <p>To cue to part of the message Press and hold SKIP/FF until you reach the desired place.</p> <ul style="list-style-type: none">●The message will be heard at twice the normal speed.●At the end of the message, 3 beeps will sound.
<p>To stop operation</p>	<p>Press STOP.</p> <ul style="list-style-type: none">●To resume playback, press NEW MESSAGE.●If you do not press any button for 60 seconds or if you press STOP again, the unit will return to the stand-by mode.

From the Handset

If someone else is in the room and you want to listen to the recorded messages privately, you can use the handset.

- 1** Handset:
Press **PLAYBACK**.

- The number of new messages is heard on the handset.

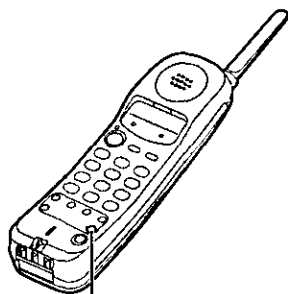

PLAYBACK

- 2** Base unit:
To listen to new messages, press **NEW MESSAGE** briefly.
To listen to all messages, press and hold **NEW MESSAGE** until playback starts.

- The messages will be heard on the handset.
- **REPEAT/REW**, **SKIP/FF** and **STOP** are also available during playback (p. 30).

- 3** When finished, press **PLAYBACK** or place the handset on the base unit.

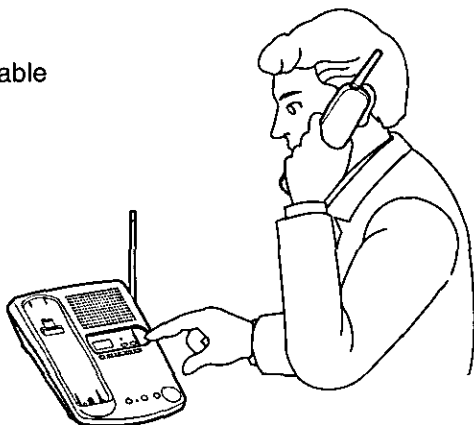

Answering System

- You can also listen to messages without using the base unit. See page 42.

Erasing Messages

The unit will announce the remaining recording time after playback, if it is less than 5 minutes. New messages cannot be recorded when:

- “Memory full” is heard.
- “**FULL**” is displayed.
- the ANSWER ON indicator flashes rapidly.

Erase some or all of the messages. We recommend you erase unnecessary messages after each playback.

Erasing a specific message

Press **ERASE** while the message you want to erase is being played.

- The unit erases the message.
- A short beep will sound and the unit will continue to play the next message.

Erasing all messages

All recorded messages, except the greeting message, can be erased at one time.

- 1 Press **ERASE**.
 - “Press ERASE again to erase all messages” is heard.

- 2 Within 5 seconds, press **ERASE** again.
 - A long beep sounds and “No messages” is heard. The display shows “0”.

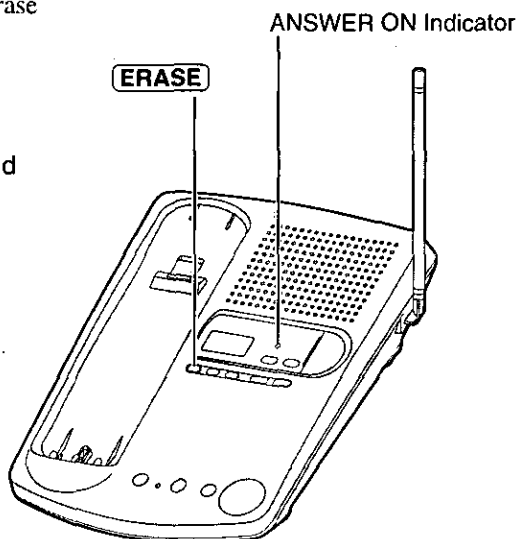

Pager Call



This feature allows you to alert your pager when the unit records an incoming message. You can retrieve the message from a touch tone telephone (p. 36). First store the pager number, then set the unit to call the pager.

The TALK indicator light must be off before programming.

Storing a Pager Number

If you use a 1-800 pager number, see the next page for the storing procedure.

- 1 Press **PROGRAM**.
 - The TALK indicator flashes.
- 2 Press **PLAYBACK**.
 - “P” is displayed on the base unit.
- 3 Press **#**.
 - “-” is displayed on the base unit.
- 4
 - ① Enter your pager number, and press **REDIAL/PAUSE** twice.* Enter the access code, if required by your pager company, and then press **REDIAL/PAUSE** twice again.*
 - ② Enter the call back number to be displayed on the pager (the telephone number where your unit is connected).
 - ③ Press **#** if required by your pager company.
 - If you misdial, press **PROGRAM** and start again from step 1.
 - You can enter a total of 48 digits.
- 5 Press **PROGRAM**.
 - A beep sounds.

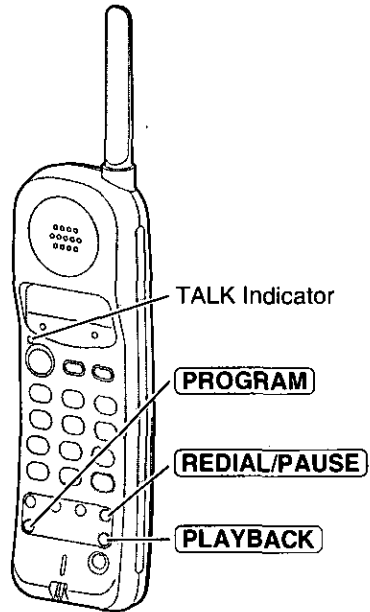

* Pager companies require a delay after the pager number and/or the access code is dialed. Contact your pager company regarding the required pause time. Pressing **REDIAL/PAUSE** once creates a 3.5 second delay and counts as one digit.

- If the line has rotary or pulse service, press **-tone** between the pager number and **REDIAL/PAUSE** in step 4.

► Pager Call

Storing a 1-800 pager number

If you use a 1-800 pager number with a PIN code, store the pager number as follows.

- 1 Press **PROGRAM**.
 - The TALK indicator flashes.
- 2 Press **PLAYBACK**.
 - “P” is displayed on the base unit.
- 3 Press **#**.
 - “-” is displayed on the base unit.
- 4
 - ① Enter the 1-800 pager number, and press **REDIAL/PAUSE** 3 times.*
 - ② Enter the PIN code, and press **REDIAL/PAUSE** twice.*
 - ③ Enter the call back number to be displayed on the pager (the telephone number where your unit is connected).
 - ④ Press **#** if required by your pager company.
 - If you misdial, press **PROGRAM** and start again from step 1.
 - You can enter a total of 48 digits.

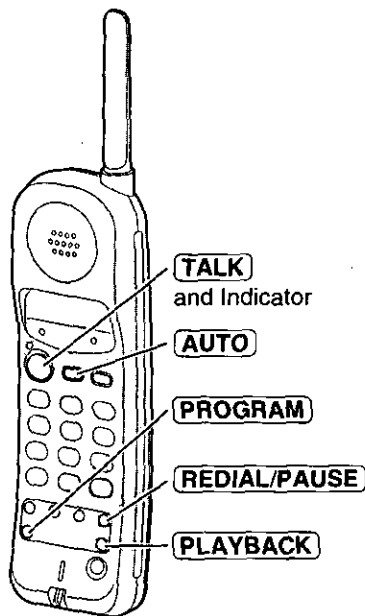

- 5 Press **PROGRAM**.
 - A beep sounds.

* Pager companies require a delay after the pager number and the PIN code are dialed. Contact your pager company regarding the required pause time. Pressing **REDIAL/PAUSE** once creates a 3.5 second delay and counts as one digit.

- If the line has rotary or pulse service, press **TONE** between the pager number and **REDIAL/PAUSE** in step 4.
- Alphanumeric voice dispatch pager services will not work with this function.

To confirm the stored pager number

Press **TALK** → **AUTO** → **#**.

- The unit dials the stored pager number.
- If the pager does not beep, check your pager by calling it manually to ensure it works. Then start again from step 1 to store the pager number.

To erase the stored pager number

Press **PROGRAM** → **PLAYBACK** → **#** → **PROGRAM**.

- The pager call mode will automatically return to OFF.

Setting the Unit to Call a Pager

- 1 Press **PLAYBACK**.
 - The number of new messages is heard on the handset.

- 2 Press **3**.
 - "**PAGER**" is displayed on the base unit.
 - If "**PAGER**" is not displayed, the pager number is not stored. Store the number (p. 33, 34), and try again.

- 3 Press **PLAYBACK**.

To turn off the pager call mode, repeat steps 1 through 3.

- "**PAGER**" will disappear.
- Each time you press **3** in step 2, the mode will turn on or off.

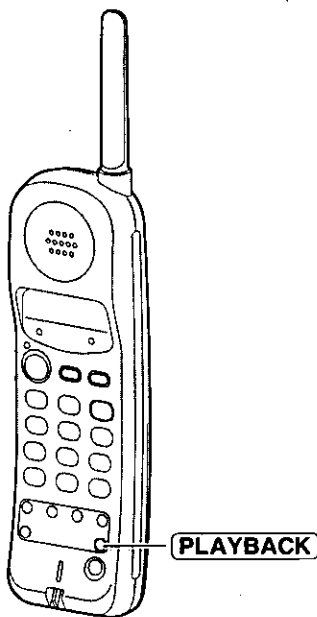

Answering System

Remote Operation from a Touch Tone Phone

You can operate the answering system from any touch tone phone. A synthesized voice menu will guide you on how to operate the unit (p. 38).

- To skip the voice menu and operate the unit directly, see page 40.

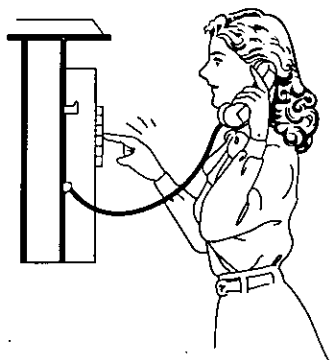

Summary of the remote operation

Call your unit from a touch tone phone.



During or after the greeting message, enter your remote code (p. 37).
• The number of new messages is heard.



After 3 seconds, the voice menu will start (p. 38).
Follow the menu or enter the direct commands (p. 40, 41).



To end remote operation, hang up.
• The messages are saved.

- The unit will announce the remaining recording time after playback, if it is less than 5 minutes.



Setting the Remote Code

The remote code prevents unauthorized people from accessing your unit and listening to your messages. Choose any **2-digit number (00–99)**. The factory preset remote code number is “11”. If you do not program your own remote code number, you can use “11”.

The TALK indicator light must be off before programming.

- 1 Press **PROGRAM**.
 - The TALK indicator flashes.
- 2 Press **PLAYBACK**.
 - “P” is displayed on the base unit.
- 3 Press **1**.
 - The current remote code is displayed.
- 4 Enter a remote code using a **2-digit number (00–99)**.
 - The entered number is displayed.
- 5 Press **PROGRAM**.
 - A beep sounds.

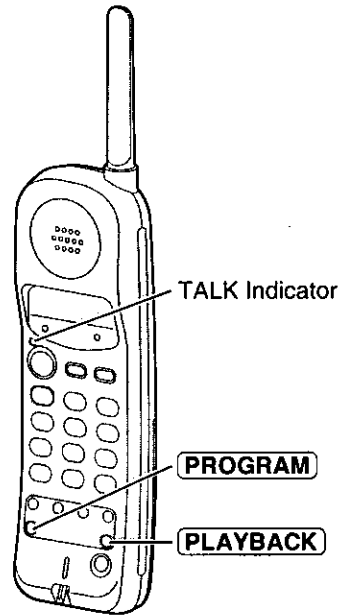

- If 6 beeps sound during programming, a wrong key was pressed. Enter the correct number.

To check the remote code

Press **PROGRAM** → **PLAYBACK** → **1**.

- The current remote code is displayed. When finished, press **PROGRAM**.

► Remote Operation from a Touch Tone Phone

Voice Menu

The shaded boxes are voice prompts.

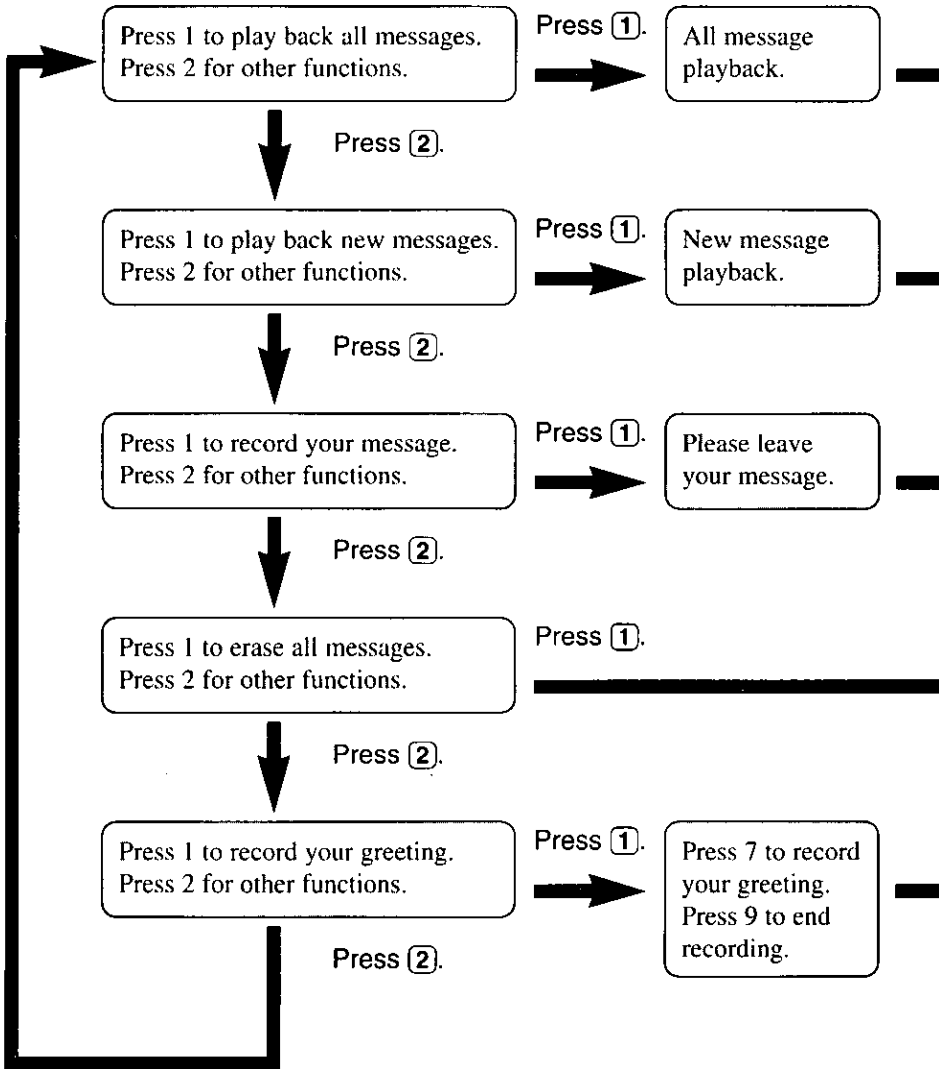



All Message Playback

All recorded messages are played back. At the end of the last message, "End of final message" is heard. The unit will announce the remaining recording time if it is less than 5 minutes.

New Message Playback

Only new messages are played back. At the end of the last message, "End of final message" is heard. The unit will announce the remaining recording time if it is less than 5 minutes.

Recording a Memo Message

You can leave a personal message.

1. Talk after you hear "Please leave your message".
2. When you finish recording, hang up.

Erasing All Messages

All recorded messages (except greeting message) are erased.

Recording a Greeting Message

You can re-record your greeting message.

1. Press **(7)**.
You hear a voice prompt followed by a long beep.
2. After the beep, talk for up to 2 minutes.
3. When you finish recording, press **(9)**.
4. Your greeting will be played back for confirmation.

- 3 seconds after playback, the voice menu will start again from the beginning.
- If you hear "Memory full" after playback, erase some or all of the messages (p. 40).

► Remote Operation from a Touch Tone Phone

Direct Remote Operation

Once you have entered the remote code, you can also control your unit by direct commands instead of using the voice menu. To end the remote operation, hang up anytime.

Direct commands

NEW MESSAGE PLAYBACK	4	• Only new messages are played back.
-------------------------	----------	--------------------------------------

ALL MESSAGE PLAYBACK	5	• All messages are played back.
-------------------------	----------	---------------------------------

REPEAT (During playback)	1	• The current message is repeated.
-----------------------------	----------	------------------------------------

SKIP (During playback)	2	• The current message is skipped. The next message is played.
---------------------------	----------	--

STOP	9	• Operation is stopped temporarily. • To resume operation, enter a direct command within 15 seconds, or the voice menu will start.
------	----------	---

GREETING MESSAGE RECORDING	7	• A long beep sounds.
----------------------------------	----------	-----------------------

↓
RECORD

• After the beep, talk immediately for up to 2 minutes.

↓
9

• The recording is stopped.
• The recorded message is played.

ERASING A SPECIFIC MESSAGE (During playback)	* 4	• The current message is erased. • A short beep will sound and the next message will be played.
---	-------------------	--

ERASING ALL MESSAGES	* 5	• All recorded messages are erased. • A long beep sounds and "No messages" is heard.
-------------------------	-------------------	---

PAGER CALL
ON/OFF

3

- Each time you press 3, "On/Off" is heard and the mode will turn on/off.
- If you have not stored a pager number, 6 beeps will sound and the mode will not turn on.

ANSWERING
SYSTEM OFF

0

- The unit hangs up and will not answer calls until turned on again.
-

Turning on the answering system

Call your unit and wait for 15 rings.

- The unit will answer and the greeting message will be played.
- The answering system will turn on. Hang up or enter the remote code for other options.
- When turning on the answering system using a rotary or pulse service telephone, you cannot enter the remote code for other options.

Skipping the greeting message

After calling your unit, press * during the greeting message.

- The unit skips the rest of the greeting message and you can start recording your message after the long beep.

Remote Operation with the Handset

You can operate your answering system with the handset. The announcements and recorded messages can only be heard with the handset.

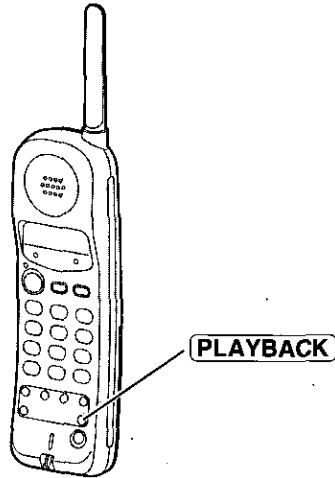

Summary of the remote operation

Press **PLAYBACK**.

- The number of new messages is heard.



Enter the desired direct commands (p. 43, 44).

- If you do not enter a command, the voice menu will start (p. 43).
- After the voice menu, all message playback will start.



To end remote operation, press **PLAYBACK**.

- The messages are saved.

- The unit will announce the remaining recording time after playback, if it is less than 5 minutes.
- If the unit starts to ring during the remote operation, press **TALK** to answer the call. The remote operation is ended.
- If you hear "Memory full" after playback, erase some or all of the messages (p. 43).



Voice menu

If no commands are entered after you press **PLAYBACK**, the unit will start the following voice menu.

“Press 4 to play back new messages. Press 5 to play back all messages.”

- You can enter direct commands even when the voice menu has started.

Direct commands

NEW MESSAGE PLAYBACK	4	• Only new messages are played back.
-------------------------	----------	--------------------------------------

ALL MESSAGE PLAYBACK	5	• All messages are played back.
-------------------------	----------	---------------------------------

REPEAT (During playback)	1	• The current message is repeated.
-----------------------------	----------	------------------------------------

SKIP (During playback)	2	• The current message is skipped. The next message is played.
---------------------------	----------	--

STOP	9	• Operation is stopped temporarily. • To resume operation, enter a direct command within 15 seconds, or the above voice menu will start.
------	----------	---

ERASING A SPECIFIC MESSAGE (During playback)	* 4	• The current message is erased. • A short beep will sound and the next message will be played.
---	-------------------	--

ERASING ALL MESSAGES	* 5	• All recorded messages are erased. • A long beep sounds and “No messages” is heard.
-------------------------	-------------------	---

(continued →)

► Remote Operation with the Handset

PAGER CALL
ON/OFF

3

- Each time you press 3, the mode will turn on/off.
- If you have not stored a pager number, "PAGER" will not be displayed on the base unit, and the mode will not turn on.

ANSWERING
SYSTEM OFF

0

- "Answer off" is heard and the answering system is turned off.

ANSWERING
SYSTEM ON

8

- "Answer set" is heard and the answering system is turned on.

Battery Replacement

If the RECHARGE indicator flashes after being fully charged, replace the battery with a new Panasonic battery.

Order No. P-P305 (for KX-TC1040W)

Order No. P-P501 (KX-A36) (for KX-TC1500B/W, KX-TC1507B)

To order, call the accessories telephone number on page 2. To avoid loss of memory, replace within 3 minutes.

- 1 Remove the cover by sliding while pressing the arrow.

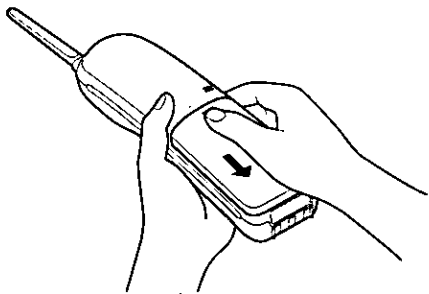

- 2 Replace the battery, and close the cover.

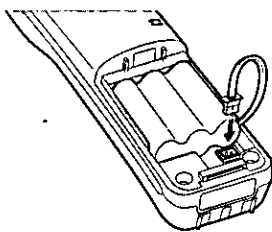

- 3 Be sure to charge the new battery fully.

KX-TC1040W: for 10 hours

KX-TC1500B/W,

KX-TC1507B: for 4 hours

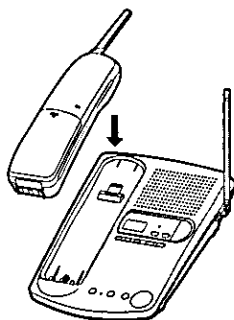

Attention:

The product you have purchased is powered by a nickel cadmium battery which is recyclable. At the end of its useful life, under various state and local laws, it is illegal to dispose of this battery into your municipal waste stream. Please call 1-800-8-BATTERY for information on how to recycle this battery.



Wall Mounting

This unit can be mounted on a wall phone plate.

- 1 Pull down the handset hook until it locks, **so the tab holds the handset.**

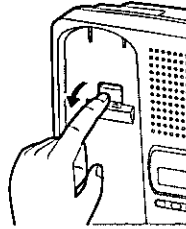

- 2 Connect the AC adaptor.

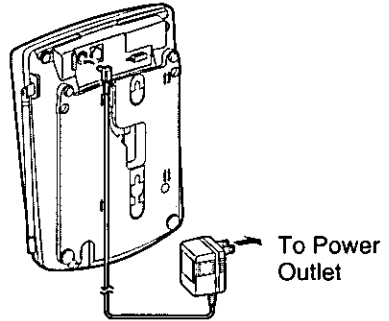

- 3 Connect the telephone line cord. Mount the unit, then slide down.

- Raise the antenna.

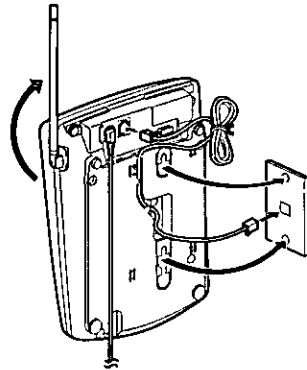

- 4 **To charge the battery:** Place the handset on the handset hook as shown.

- The IN USE/CHARGE indicator lights.

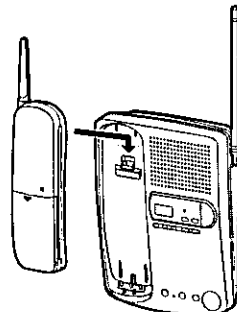

Adding Another Phone

This unit will not function during a power failure. To connect a standard telephone on the same line, use the Panasonic T-adaptor KX-J66. To order, call the accessories telephone number on page 2.

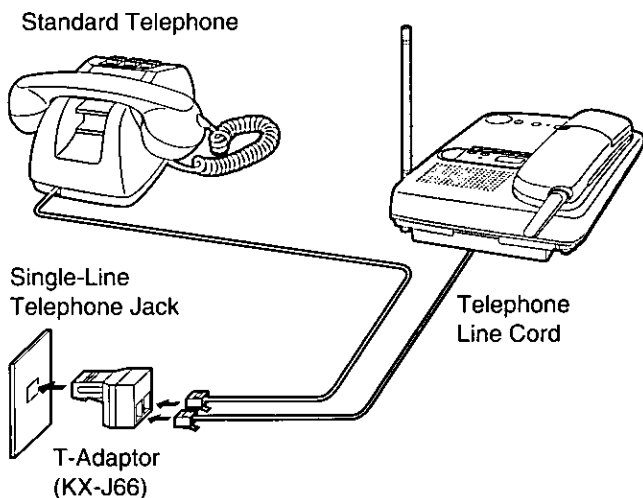

Before Requesting Help

Cordless Telephone

Problem	Remedy
An alarm tone sounds when you press TALK , INTERCOM or PLAYBACK .	<ul style="list-style-type: none">• You are too far from the base unit. Move closer and try again.• Place the handset on the base unit and try again.• Plug in the AC adaptor.• Raise the base unit antenna.
Static, sound cuts in/out, fades. Interference from other electrical units.	<ul style="list-style-type: none">• Locate the handset and the base unit away from other electrical appliances (p. 3).• Move closer to the base unit.• Raise the base unit antenna.• Press CH to select a clearer channel.
The handset does not ring.	<ul style="list-style-type: none">• The ringer volume is set to OFF. Press RINGER while the TALK indicator light is off (p. 13).
You cannot store a phone number in memory.	<ul style="list-style-type: none">• You cannot store a number while the unit is in the talk or intercom mode.• Do not pause for over 60 seconds while storing.
While storing a phone number, the unit starts to ring.	<ul style="list-style-type: none">• To answer the call, press TALK. The program will be canceled. Store the number again.
LOCATOR/INTERCOM does not function.	<ul style="list-style-type: none">• The handset is too far from the base unit or is engaged in an outside call.
REDIAL/PAUSE does not function properly.	<ul style="list-style-type: none">• The button has a double function as either redial or pause. It will redial the last number dialed if pressed at the outset of a call (p. 20). If another number has been dialed first, it will operate as a pause button (p. 27).



Problem	Remedy
You cannot redial by pressing REDIAL/PAUSE .	<ul style="list-style-type: none">• The redial function does not work right after programming the flash time (p. 25) and storing phone numbers in the speed dialer (p. 22).• Access numbers entered after pressing STONE will not be included when redialing (p. 26).• If the last number dialed was more than 32 digits long, the number will not be redialed.

► Before Requesting Help

Answering System

Problem	Remedy
The answering system is on, but incoming messages are not recorded.	<ul style="list-style-type: none">•The recording time is set to “greeting only”: Select “1 minute” or “3 minutes” (p. 18).•Memory is full. Erase some or all of the messages (p. 32).
“ FULL ” is displayed and the ANSWER ON indicator flashes rapidly, and no new messages are recorded.	<ul style="list-style-type: none">•Memory is full. Erase some or all of the messages (p. 32).
You cannot operate the answering system at the base unit.	<ul style="list-style-type: none">•The handset user is operating the answering system. Wait until the IN USE/CHARGE indicator light goes out.
You cannot operate the answering system from a touch tone phone.	<ul style="list-style-type: none">•Make sure you enter the correct remote code.•The answering system may not respond if the tones are too short to activate the unit. Press each button firmly.•The answering system is off. Turn it on (p. 41).
You cannot operate the answering system with the handset.	<ul style="list-style-type: none">•Someone is operating the answering system.•You are too far from the base unit. Move closer to the base unit.•The unit is recording a message. To answer the call, press TALK.

General

Problem	Remedy
The unit does not work.	<ul style="list-style-type: none">• Check the settings (p. 10–13).• Charge the battery fully (p. 11).• Clean the charge contacts and charge again (p. 11).• Install the battery properly (p. 45).• Place the handset on the base unit and unplug the AC adaptor to reset. Plug in and try again.• Re-insert the handset battery within 3 minutes to avoid loss of memory and place the handset on the base unit. Try again.
You cannot program items such as the dialing mode (p. 12) or the time/day adjustment etc (p. 16).	<ul style="list-style-type: none">• Programming is not possible while the unit is in the talk or intercom mode, or while the answering system is in use.• Move closer to the base unit.
Previously programmed information is erased.	<ul style="list-style-type: none">• If a power failure occurs, programmed information may be erased. Reprogram if necessary.
The RECHARGE indicator flashes or the unit beeps intermittently.	<ul style="list-style-type: none">• Charge the battery fully (p. 11).
You charged the battery fully, but the RECHARGE indicator flashes.	<ul style="list-style-type: none">• Clean the charge contacts and charge again (p. 11).• Install a new battery (p. 45).
The IN USE/CHARGE indicator light does not go out while charging.	<ul style="list-style-type: none">• This is normal.
If you cannot solve your problem	<ul style="list-style-type: none">• Call our customer call center at 1-800-211-PANA(7262).

Important Safety Instructions

When using this unit, basic safety precautions should always be followed to reduce the risk of fire, electric shock, or personal injury.

1. Read and understand all instructions.
2. Follow all warnings and instructions marked on this unit.
3. Unplug this unit from AC outlets before cleaning. Do not use liquid or aerosol cleaners. Use a damp cloth for cleaning.
4. Do not use this unit near water, for example, near a bathtub, washbowl, kitchen sink, or the like.
5. Place this unit securely on a stable surface. Serious damage and/or injury may result if the unit falls.
6. Do not cover slots and openings on the unit. They are provided for ventilation and protection against overheating. Never place the unit near radiators, or in a place where proper ventilation is not provided.
7. Use only the power source marked on the unit. If you are not sure of the type of power supplied to your home, consult your dealer or local power company.
8. Do not place objects on the power cord. Install the unit where no one can step or trip on the cord.
9. Do not overload wall outlets and extension cords. This can result in the risk of fire or electric shock.
10. Never push any objects through slots in this unit. This may result in the risk of fire or electric shock. Never spill any liquid on the unit.
11. To reduce the risk of electric shock, do not disassemble this unit. Take the unit to an authorized servicer when service is required. Opening or removing covers may expose you to dangerous voltages or other risks. Incorrect reassembly can cause electric shock when the unit is subsequently used.
12. Unplug this unit from the wall outlet and refer servicing to an authorized servicer when the following conditions occur:
 - A. When the power supply cord or plug is damaged or frayed.
 - B. If liquid has been spilled into the unit.
 - C. If the unit has been exposed to rain or water.
 - D. If the unit does not work normally by following the operating instructions. Adjust only controls covered by the operating instructions. Improper adjustment may require extensive work by an authorized servicer.
 - E. If the unit has been dropped or physically damaged.
 - F. If the unit exhibits a distinct change in performance.
13. During thunderstorms, avoid using telephones except cordless types. There may be a remote risk of an electric shock from lightning.
14. Do not use this unit to report a gas leak, when in the vicinity of the leak.

SAVE THESE INSTRUCTIONS

CAUTION:

To reduce the risk of fire or injury to persons, read and follow these instructions.

1. Use only the battery(ies) specified.
2. Do not dispose of the battery(ies) in a fire. They may explode. Check with local waste management codes for special disposal instructions.
3. Do not open or mutilate the battery(ies). Released electrolyte is corrosive and may cause burns or injury to the eyes or skin. The electrolyte may be toxic if swallowed.
4. Exercise care in handling batteries in order not to short the battery to conductive materials such as rings, bracelets, and keys. The battery and/or conductor may overheat and cause burns.
5. Charge the battery(ies) provided with or identified for use with this product only in accordance with the instructions and limitations specified in this manual.

WARNING:

TO PREVENT FIRE OR SHOCK HAZARD, DO NOT EXPOSE THIS PRODUCT TO RAIN OR ANY TYPE OF MOISTURE.

FCC and Other Information

If requested by the telephone company, inform them as follows:

FCC Registration No. (found on the bottom of the unit)

Ringer Equivalence. 0.1B

The particular telephone line to which the equipment is connected.

This unit must not be connected to a coin operated line.

If you are on a party line, check with your local telephone company.

Ringer Equivalence No. (REN):

The REN is useful in determining the quantity of devices you may connect to your telephone line and still have all of those devices ring when your telephone number is called. In most, but not all areas, the sum of the REN's of all devices connected to one line should not exceed five (5.0). To be certain of the number of devices you may connect to your line, as determined by the REN, you should contact your local telephone company to determine the maximum REN for your calling area.

In the event terminal equipment causes harm to the telephone network, the telephone company should notify the customer, if possible, that service may be stopped.

However, where prior notice is impractical, the company may temporarily cease service providing that they:

- (a) Promptly notify the customer.
- (b) Give the customer an opportunity to correct the problem with their equipment.
- (c) Inform the customer of the right to bring a complaint to the Federal Communication Commission pursuant to procedures set out in FCC Rules and Regulations Subpart E of Part 68.

The Telephone Company may make changes in its communications facilities, equipment, operations or procedures, where such action is reasonably required in the operation of its business and is not inconsistent with the rules and regulations in FCC Part 68.

If such changes can be reasonably expected to render any customer terminal equipment incompatible with telephone company communications facilities, or require modification or alteration of such terminal equipment, or otherwise materially affect its use or performance, the customer shall be given adequate notice in writing, to allow the customer an opportunity to maintain uninterrupted service.

When programming emergency numbers and/or making test calls to emergency numbers:

- 1. Remain on the line and briefly explain to the dispatcher the reason for the call before hanging up.
- 2. Perform such activities in the off-peak hours, such as early morning hours or late evenings.

This device complies with Part 15 of the FCC Rules. Operation is subject to the following two conditions: (1) This device may not cause harmful interference, and (2) this device must accept any interference received, including interference that may cause undesired operation.

Privacy of communications may not be ensured when using this phone.

CAUTION:

Any changes or modifications not expressly approved by the party responsible for compliance could void the user's authority to operate this device.

Note:

This equipment has been tested and found to comply with the limits for a Class B digital device, pursuant to Part 15 of the FCC Rules. These limits are designed to provide reasonable protection against harmful interference in a residential installation. This equipment generates, uses, and can radiate radio frequency energy and, if not installed and used in accordance with the instructions, may cause harmful interference to radio communications. However, there is no guarantee that interference will not occur in a particular installation. If this equipment does cause harmful interference to radio or television reception, which can be determined by turning the equipment off and on, the user is encouraged to try to correct the interference by one or more of the following measures:

- Reorient or relocate the receiving antenna.
- Increase the separation between the equipment and receiver.
- Connect the equipment into an outlet on a circuit different from that to which the receiver is connected.
- Consult the dealer or an experienced radio/TV technician for help.

Some cordless telephones operate at frequencies that may cause interference to nearby TVs and VCRs. To minimize or prevent such interference, the base of the cordless telephone should not be placed near, or on top of, a TV or VCR. If interference is experienced, move the cordless telephone farther away from the TV or VCR. This will often reduce, or eliminate, interference.

- **Environment**—do not place the unit in a room where the temperature is less than 5°C (41°F) or greater than 40°C (104°F). Allow 10 cm (4") clearance around the unit for proper ventilation. Avoid excessive smoke, dust, mechanical vibration, shock, or direct sunlight.
- **Routine care**—wipe the unit with a soft cloth. Do not use benzine, thinner, or any abrasive powder. When you leave the unit unused for a long period of time, unplug the AC adaptor from the outlet.
- **If there is any trouble**—disconnect the unit from the telephone line and connect a known working phone. If the known working phone operates properly, have your unit repaired by one of the authorized Panasonic Factory Service Centers. If the known working phone does not operate properly, consult your telephone company.

For product service

- Panasonic Servicenters are listed in the servicenter directory.
- Call 1-800-211-PANA(7262) for the location of an authorized servicenter.

When you ship the product

- Carefully pack your unit, preferably in the original carton.
- Attach a letter, detailing the symptom, to the outside of the carton.

Symptom

- Send the unit to an authorized servicenter, prepaid and adequately insured.
- Do not send your unit to the Panasonic Consumer Electronics Company listed below or to executive or regional sales offices. These locations do not repair consumer products.

- This cordless telephone is designed for use in the United States of America. Sale or use of this product in other countries may violate local laws.
- Ce téléphone sans fil est conçu pour être utilisé aux États-Unis d'Amérique. La vente ou l'emploi de cet appareil dans certains autres pays peut constituer une infraction à la législation locale.
- Este teléfono sin cordón fue elaborado para uso en los Estados Unidos de América. La venta o el empleo de este producto en ciertos países puede constituir violación de la legislación local.
- このコードレス電話機は、日本国外での使用を目的として設計されており、日本国内での使用は法律違反となります。従って、当社では日本国内においては原則として修理などのサービスは致しかねます。

**Panasonic Consumer Electronics Company,
Division of Matsushita Electric Corporation of America**
One Panasonic Way, Secaucus, New Jersey 07094

**Panasonic Sales Company,
Division of Matsushita Electric of Puerto Rico, Inc.**
Ave. 65 de Infantería, Km. 9.5, San Gabriel Industrial Park
Carolina, Puerto Rico 00985