

# Panasonic

900MHz Digital Cordless Phone

Model No. **KX-TC1723B**

Pulse-or-tone dialing capability

## Operating Instructions



**2 LINE**

**PLEASE READ BEFORE USE  
AND SAVE.**

**Caller ID Compatible**

**Charge the battery for about 15 hours before initial use.**

**Panasonic World Wide Web address: <http://www.panasonic.com>  
for customers in the USA or Puerto Rico**

*Preparation*

*Basic Operation*

*Advanced Operation*

*Useful Information*

# Before Initial Use

Please read **IMPORTANT SAFETY INSTRUCTIONS** on page 64 before use.  
Read and understand all instructions.

**Thank you for purchasing your new Panasonic cordless telephone.**

Caller ID, Call Waiting and Voice Mail Service, where available, are telephone company services. After subscribing to Caller ID, this phone will display the caller's name and phone number. Call Waiting Caller ID, which displays a second caller's name and phone number while the user is on another call, requires a subscription to both Caller ID and Call Waiting. After subscribing to Voice Mail Service, this phone's message-waiting indicator will flash when there are messages in the mail box.

Attach your purchase receipt here.

## For your future reference

Serial No. \_\_\_\_\_  
(found on the bottom of the unit)

Date of purchase \_\_\_\_\_

Name and address of dealer \_\_\_\_\_

## Accessories (Included)

For extra orders, call 1-800-332-5368.

- AC Adaptor (p. 11)  
Order No.  
PQLV2Z

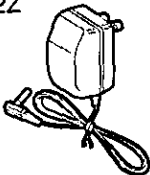

one

- 4-Wire Telephone  
Line Cord with Green  
Plugs (p. 12, 13)

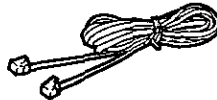

one

- 2-Wire Telephone  
Line Cord with  
Transparent Plugs  
(p. 13)



one

- Wall Mounting Adaptor (p. 54)  
Order No.  
PQKL10035Z1

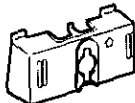

one

- Belt Clip (p. 56)  
Order No.  
PQKE10130Z1



one

# For Best Performance

---

## Battery Charge

A rechargeable Ni-Cd battery powers the handset. Charge the battery for about **15 hours** before initial use (p 14)

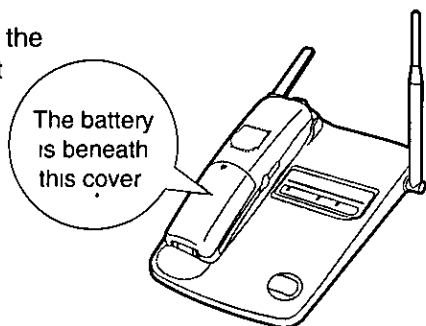

## Base Unit Location

Calls are transmitted between the base unit and the handset using wireless radio waves. **For maximum distance and noise-free operation**, the recommended base unit location is

Away from electrical appliances such as a TV or personal computer

In a **HIGH** and **CENTRAL** location with no obstructions such as walls

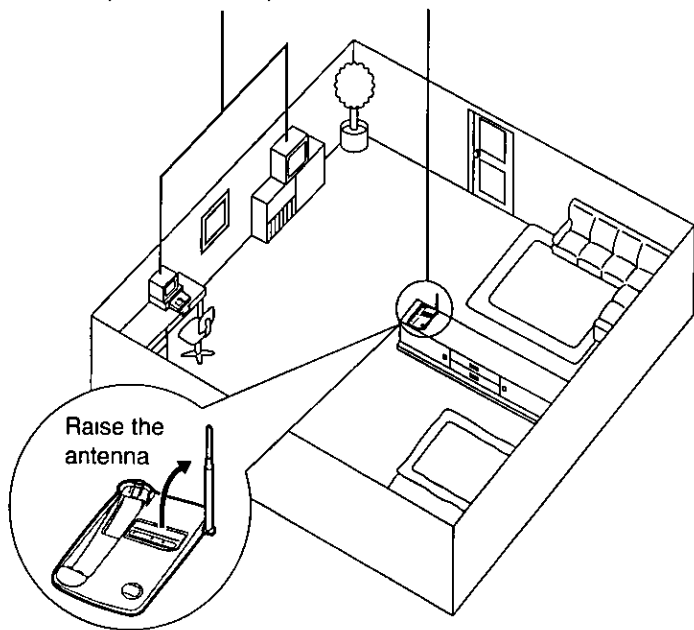

# Contents

---

## *Preparation*

<b>Location of Controls</b> .....	6
<b>Display</b> .....	8
<b>Settings</b> .....	11
Connecting the AC Adaptor .....	11
Connecting the Telephone Line Cord .....	12
Battery Charge .....	14
Selecting the Dialing Mode .....	16
Selecting the Line Mode .....	17
<b>Programmable Functions</b> .....	18
Setting the Auto Talk Feature .....	19
Selecting the Ringer Volume .....	20
Selecting the LCD Contrast .....	21

## *Basic Operation*

<b>Making Calls</b> .....	22
<b>Answering Calls</b> .....	26
<b>Caller ID Service</b> .....	27
<b>Using the Caller List</b> .....	29
Viewing the Caller List .....	29
Calling Back from the Caller List .....	31
Editing the Caller's Phone Number .....	32
Storing Caller List Information in the Directory .....	33
Erasing Caller List Information .....	34

## *Advanced Operation*

<b>Using the Directory</b> .....	35
Storing Names and Numbers in the Directory .....	35
Steps for Entering Names and Symbols .....	37
Finding Items in the Directory .....	39
Dialing from the Directory .....	40
Editing an Item in the Directory .....	41
Erasing an Item from the Directory .....	42

<b>Voice Mail Service</b> .....	43
Storing a Voice Mail Access Number .....	43
Setting the Voice Mail Tone .....	45
Listening to Voice Mail Messages .....	46
<b>Using the Other Line During a Conversation</b> .....	47
<b>Conference Call</b> .....	48
<b>Special Features</b> .....	49
Automatic Security Code Setting .....	49
Handset Locator .....	49
Temporary Tone Dialing (For Rotary or Pulse Service Users) .....	50
How to Use the PAUSE Button (For Analog PBX Line/Long Distance Service Users) .....	50
For Call Waiting Service Users .....	50
FLASH Button .....	51
Line Selection .....	52
Incoming Call Tone .....	53

### *Useful Information*

<b>Wall Mounting</b> .....	54
<b>Using the Belt Clip</b> .....	56
<b>Using an Optional Headset</b> .....	56
<b>Battery Replacement</b> .....	58
<b>Adding Another Phone</b> .....	59
<b>Before Requesting Help</b> .....	60
<b>Important Safety Instructions</b> .....	64
<b>FCC and Other Information</b> .....	66

*Preparation*

*Basic Operation*

*Advanced Operation*

*Useful Information*

# Location of Controls

---

## Base unit

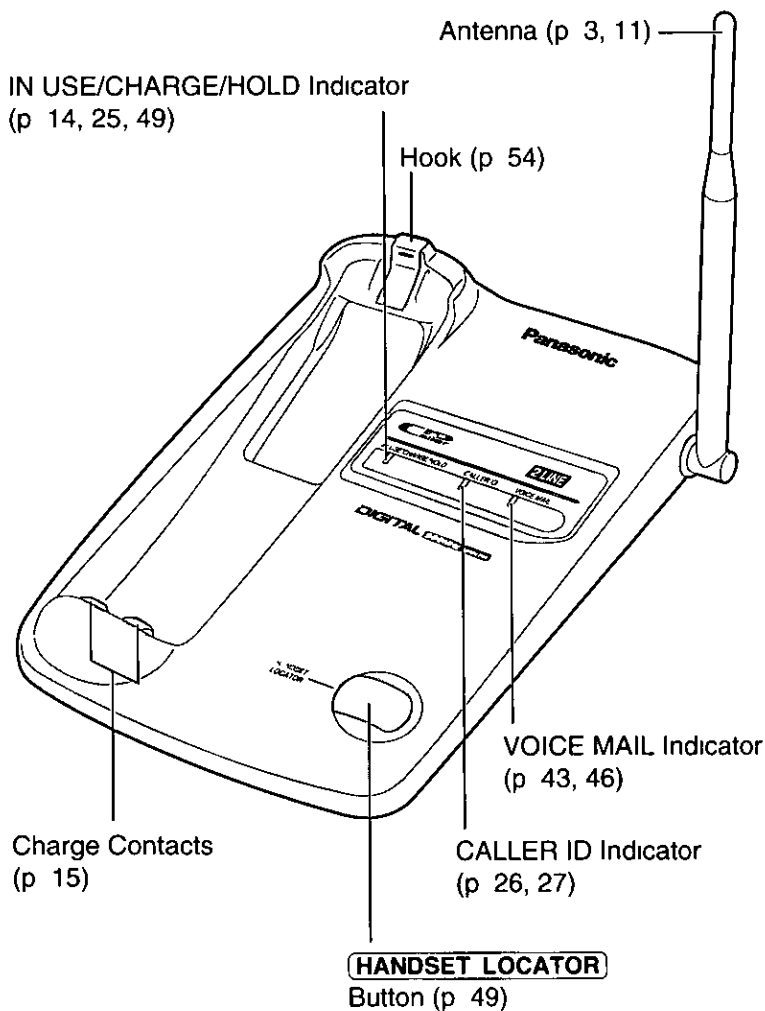

# Handset

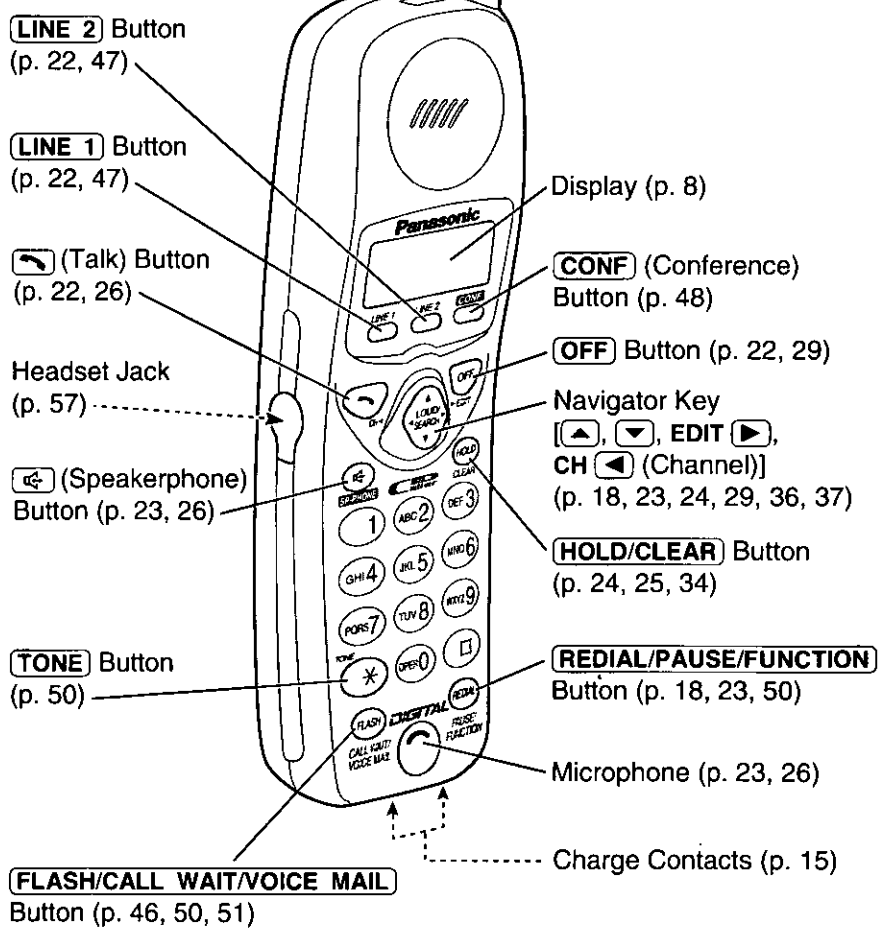
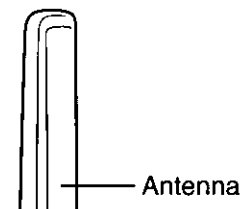
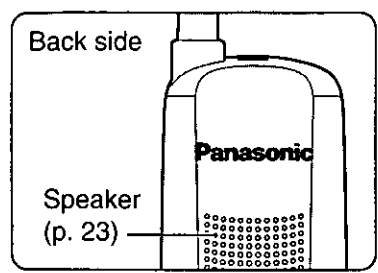

# Display

---

The handset shows you instructions and information on the display. These display prompts are shown below.

No items stored

The Caller List is empty or there are no stored items in the directory.

Recharge  
[ ] [ ] [ ] [ ]

The battery needs to be charged. Place the handset on the base unit to charge the battery (p. 14).

12 new calls  
[ ] [ ] [ ] [ ]

The display shows the number of new calls and the battery strength (p. 14) while the handset is on the base unit.

12 new calls  
▼▲ ▶=Directory

The display shows the number of new calls when ▼ or ▲ is pressed while the handset is off the base unit.

To search from the most recent call, press ▼.  
To search from the oldest call, press ▲ (p. 29).  
To go to the directory list, press EDIT ▶ (Directory key).

Voicemail 12

The display shows the voice mail message(s) is/are recorded (p. 43). (While the handset is off the base unit.)

Ringer off  
[ ] [ ] [ ] [ ]

When the ringer volume is set to OFF (p. 20), "Ringer off" will flash for about 45 seconds before the unit returns to the standby mode (p. 15).

[L1]  
ROBINSON, TINA  
1-000-222-3333

When a call is received, the display shows the caller's name, number and the called line after the first ring.  
The called line status indication flashes.





[L1]  
Talk Line1  
01-06-35 [■■■■]

During a conversation, the display shows the length of the call (ex 1 hour, 6 minutes and 35 seconds) The battery strength is also displayed (p 14)

No link to base  
Place on cradle  
and try again

The handset has lost communication with the base unit Place the handset on the base unit and try again

SMITH, JACK  
1-222-333-4444  
11 20A JAN12 x3

This is a name from the Caller List  
The display shows  
—the caller's name,  
—the caller's number and the called line,  
—the time and date of the last call  
(ex Jan 12, 11 20 AM), and  
—the number of times called (ex 3 times)

Ann  
1234567890

This is a name from the directory The stored name and phone number are displayed

Directory full

When trying to store an item or Caller List information in the directory, the directory memory is full (p 33, 36)

Save error

During a programming procedure, the handset has lost communication with the base unit Move closer to the base unit

## ► Display

---

Paging

The base unit is paging the handset (p. 49).

[L1]  
Hold

{■■■■}

An outside call has been put on hold by the handset user (p. 25). The called line status indication flashes.

To release the hold, press the line button whose status indication is flashing.

BROWN, NANCY  
1-000-333-4444  
----Waiting----

A second call is received during a conversation (p. 50).

Please lift up  
and try again.

▼, ▲, CH ◀ or EDIT ▶ was pressed while the handset was on the base unit.

Lift the handset and press the button again.

Not available

▼, ▲, CH ◀ or EDIT ▶ was pressed while the base unit was not in the standby mode.



## Connecting the AC Adaptor

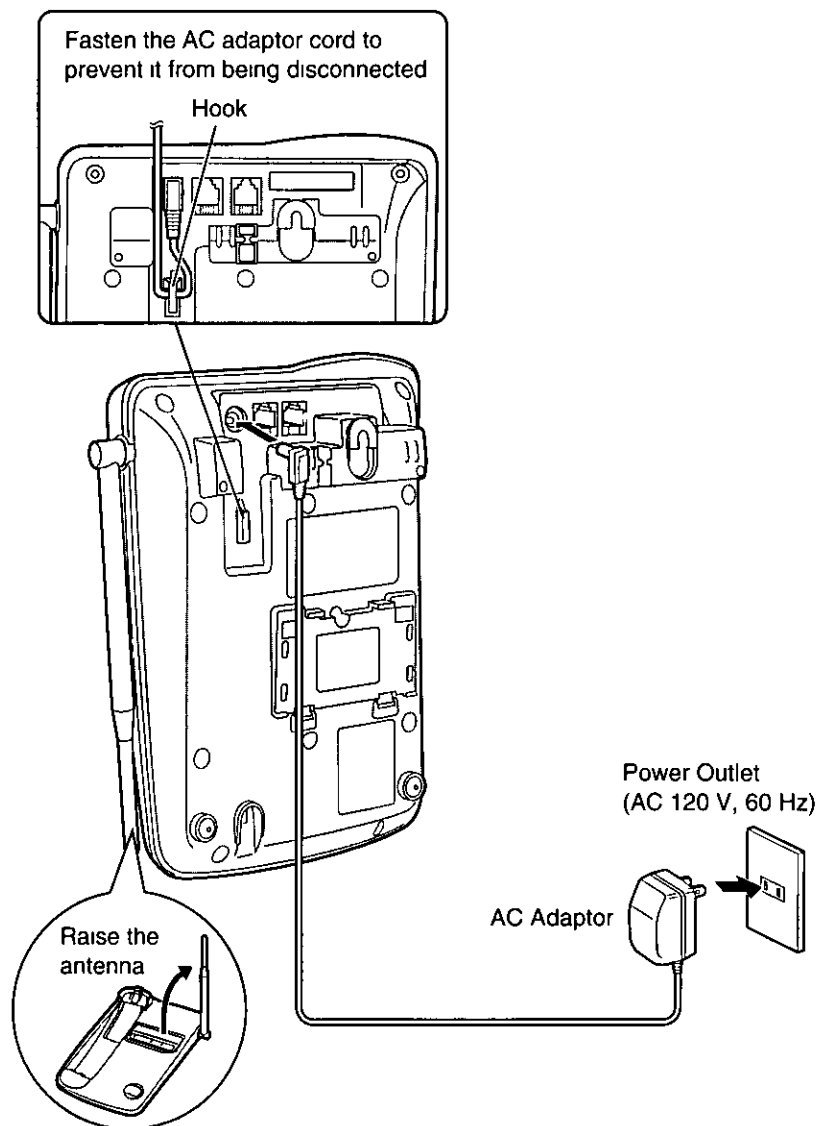

- USE ONLY WITH Panasonic AC ADAPTOR PQLV2 (Order No. PQLV2Z)
- The AC adaptor must remain connected at all times (It is normal for the adaptor to feel warm during use)
- To connect a standard telephone on the same line, see page 59
- If your unit is connected to a PBX which does not support Caller ID and voice mail services, you cannot access those services

## ► Settings

# Connecting the Telephone Line Cord

Connect the telephone line cord(s) to the unit as follows.

### To connect a two-line telephone jack

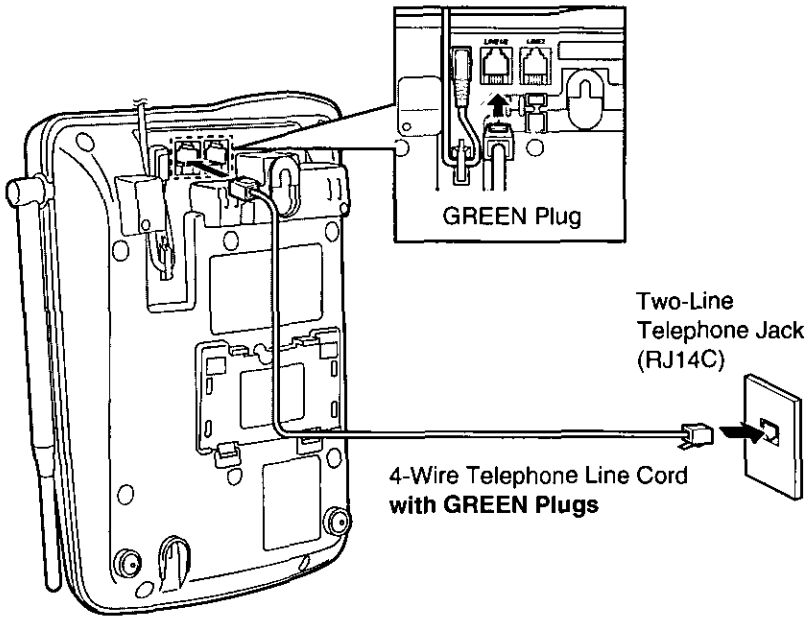



### To connect two single-line telephone jacks

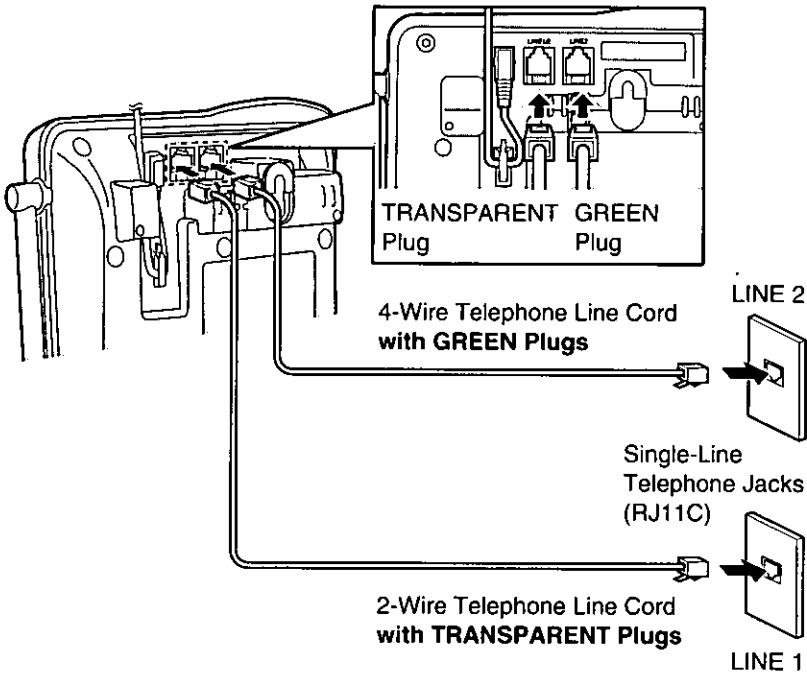

### If you use the unit as a single-line telephone only

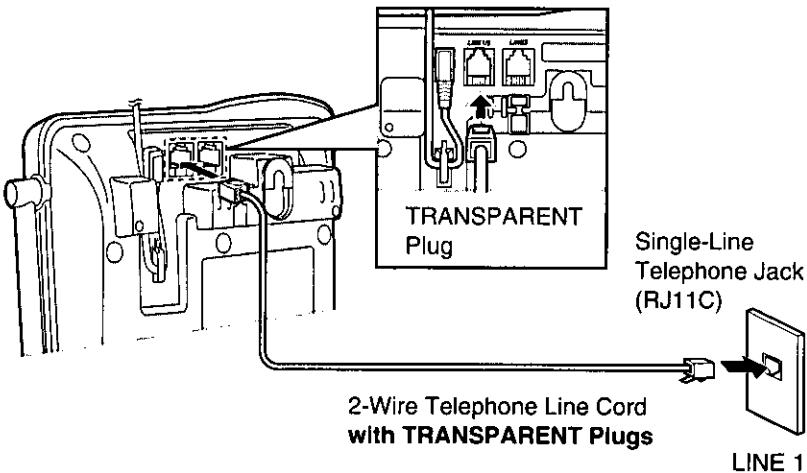

### Battery Charge

Place the handset on the base unit and charge for about **15 hours** before initial use.

- The IN USE/CHARGE/HOLD indicator lights.

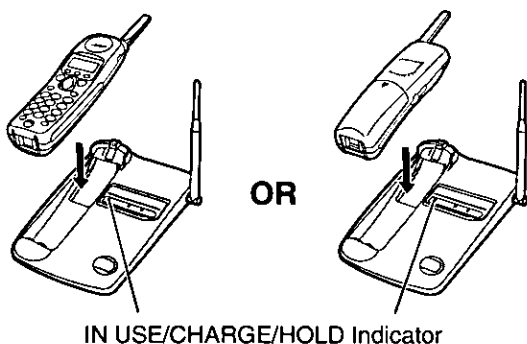

### Battery strength

You can check the battery strength on the display while the handset is on the base unit, while it is in use (making/answering a call etc.), or after viewing the Caller List or directory items, programming etc.

The battery strength will remain on the display for a few seconds after using the handset, then the display will return to the standby mode (see next page).

The battery strength is as shown in the chart below.

Display prompt	Battery strength
{ ■■■ }	Fully charged
{ ■■ }	Medium
{ ■ }	Low
⚡ { ■ } ⚡ (flashing)	Needs to be recharged.



## Recharge

Recharge the battery when

- “Recharge” is displayed,
- “{ ■}” flashes on the display, or
- the handset beeps intermittently while it is in use

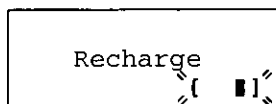

- If you DO NOT recharge the handset battery for more than 15 minutes, the display will keep indicating “Recharge” and/or “{ ■}” will continue to flash

## Battery information

After your Panasonic battery is fully charged (p 14)

Operation	Approx. battery life
While in use (TALK)	Up to about 6 hours
While not in use (Standby)	Up to about 14 days

- Battery life may be shortened depending on usage conditions, such as viewing the Caller ID Caller List or directory list, and ambient temperature
- Clean the handset and the base unit charge contacts with a soft, dry cloth once a month Clean more often if the unit is subject to grease, dust or high humidity** Otherwise the battery may not charge properly
- If the battery is fully charged, you do not have to place the handset on the base unit until “Recharge” is displayed and/or “{ ■}” flashes This will maximize the battery life
- The battery cannot be overcharged

## Standby Mode (While the handset is off the base unit)

The handset goes into the standby mode after you finish using the handset (making/answering a call, viewing the Caller List or directory list etc ) The display is blank, but the handset can receive calls

The battery life is conserved in this mode

## ► Settings



---

### Selecting the Dialing Mode



If you have touch tone service, set to "Tone" If rotary or pulse service is used, set to "Pulse" Your phone comes from the factory set to "Tone"

**Make sure the unit is in the standby mode.**



- 1 Press **REDIAL/PAUSE/FUNCTION**

Program
►Save directory
Ringer volume
  
- 2 Press  or  repeatedly until the arrow points to "Program"

Ringer volume
►Program
Save directory
  
- 3 Press **EDIT** 

Talk switching
►LCD contrast
Set flash time
  
- 4 Press  or  repeatedly until the arrow points to "Set dial mode"

Set line mode
►Set dial mode
Line selection
  
- 5 Press **EDIT** 

Dial mode
Tone
▼▲ <span style="margin-left: 100px;">►=Save</span>
  
- 6 Press  or  to select "Pulse" or "Tone"
  
- 7 Press **EDIT**  (Save key)
  - A beep sounds
  - To return to the standby mode, press **OFF**

Dial mode
Pulse

•You can exit the programming mode any time by pressing **OFF**



## Selecting the Line Mode

If the line is connected to a low voltage system such as a PBX, set to "B". Both lines are preset to "A".

Make sure the unit is in the standby mode.

- 1 Press **REDIAL/PAUSE/FUNCTION**.
 

Program  
 ▶Save directory  
 Ringer volume
- 2 Press **▼** or **▲** repeatedly until the arrow points to "Program".
 

Ringer volume  
 ▶Program  
 Save directory
- 3 Press **EDIT** **▶**.
 

Talk switching  
 ▶LCD contrast  
 Set flash time
- 4 Press **▼** or **▲** repeatedly until the arrow points to "Set line mode".
 

Voicemail tone  
 ▶Set line mode  
 Set dial mode
- 5 Press **EDIT** **▶**.
 

Line mode  
 ▼=Line1 ▲=Line2
- 6 Press **▼** (Line1) or **▲** (Line2) to select the desired line.
 

Line mode  
 Line1:A  
 ▼▲ ▶=Save
- 7 Press **▼** or **▲** to select "B" or "A".
- 8 Press **EDIT** **▶** (Save key).
 

Line mode  
 Line1:B

  - A beep sounds.
  - To program the other line, start again from step 4.
  - To return to the standby mode, press **OFF**.

•You can exit the programming mode any time by pressing **OFF**.

# Programmable Functions

You can program the following function items **using the handset near the base unit**. The display shows the programming instructions. See the corresponding pages for function details.

**Make sure the unit is in the standby mode.**

Press **REDIAL/PAUSE/FUNCTION**



<Function menu>\*

▶Save directory
Ringer volume
Program

To store an item in the directory (p 36)

To select the ringer volume (p 20)

Press **EDIT** 

<Function menu>\*

▶LCD contrast
Set flash time
Save mailbox#
Voicemail tone
Set line mode
Set dial mode
Line selection
Incoming call
Talk switching

To select the LCD contrast (p 21)

To select the flash time (p 51)

To store a voice mail access number (p 43, 44)

To set the voice mail tone (p 45)

To select the line mode (p 17)



To select the dial mode (p 16)

To change the line selection (p 52)

To set the incoming call tone (p 53)

To set the auto talk feature (p 19)

## During programming

\*To select a desired function item, press  or  repeatedly until the arrow points to the item. Then press **EDIT**  to go to the next step.

- If the handset displays "No link to base. Place on cradle and try again" and an alarm tone sounds, move closer to the base unit and try again.
- You can exit the programming mode any time by pressing **OFF**.
- If you do not press any buttons for 60 seconds, the unit will return to the standby mode.



## Setting the Auto Talk Feature

The Auto Talk feature allows you to answer a call by lifting the handset off the base unit without pressing or . If you want to use this feature, turn the feature ON by programming. Your phone comes from the factory set to OFF.

**Make sure the unit is in the standby mode.**

1 Press **REDIAL/PAUSE/FUNCTION**.

2 Press or repeatedly until the arrow points to "Program".

```
Ringer volume
▶Program
Save directory
```

3 Press **EDIT** .

```
Talk switching
▶LCD contrast
Set flash time
```

4 Press or repeatedly until the arrow points to "Talk switching".

```
Incoming call.
▶Talk switching
LCD contrast
```

5 Press **EDIT** .

```
Auto talk
:Off
▼▲ ▶=Save
```

6 Press or to select "On" or "Off".

7 Press **EDIT** (Save key).

- A beep sounds.
- To return to the standby mode, press **OFF**.

```
Auto talk
:On
```

- You can exit the programming mode any time by pressing **OFF**.
- To answer a call when the Auto Talk feature is OFF, lift the handset off the base unit and press or .

## ► Programmable Functions

### Selecting the Ringer Volume

You can program the ringer volume to HIGH, LOW or OFF. If set to OFF, the unit will not ring. Your phone comes from the factory set to HIGH.

**Make sure the unit is in the standby mode.**

1 Press **REDIAL/PAUSE/FUNCTION**.

2 Press **▼** or **▲** repeatedly until the arrow points to "Ringer volume".

```
Save directory
►Ringer volume
Program
```

3 Press **EDIT** **▶**.

```
Ringer volume
▼=Line1 ▲=Line2
```

4 Press **▼** (Line1) or **▲** (Line2) to select the desired line.

```
HIGH Ringer Line1
Low ██████ High
▼▲
▼ ▲
```

5 Press **▼** or **▲** to select the desired volume.

```
LOW Ringer Line1
Low ██ High
▼▲
```

- The selected volume is displayed and rings.

- The handset will return to the standby mode.

- To turn the ringer OFF**, press and hold **▼** until 2 beeps sound.

- To turn the ringer ON**, press **▲** or **▼**.

- The ringer for the selected line will sound at the LOW level.

```
OFF Ringer off
```

- When you replace the battery, the selected ringer volume setting will return to the factory set (HIGH). Reprogram if necessary.

## Selecting the LCD Contrast

You can program the LCD contrast (5 levels) To make the display clearer, set to high level Your phone comes from the factory set to level 3

**Make sure the unit is in the standby mode**

1 Press **REDIAL/PAUSE/FUNCTION**

2 Press **▼** or **▲** repeatedly until the arrow points to "Program"

```

Ringer volume
▶Program
Save directory
  
```

3 Press **EDIT** **▶**

```

Talk switching
▶LCD contrast
Set flash time
  
```

4 While the arrow points to "LCD contrast", press **EDIT** **▶**

```

LCD contrast
Low ■■■ High
▼▲          ▶=Save
  
```

5 Press **▼** or **▲** to select the desired contrast

- Each time you press **▼** or **▲**, the LCD contrast will change

6 Press **EDIT** **▶** (Save key)

- A beep sounds
- To return to the standby mode, press **OFF**

```

LCD contrast
Low ■■ High
  
```

- You can exit the programming mode any time by pressing **OFF**

# Making Calls

To have a hands-free conversation, connect an optional headset to the handset (p 57)

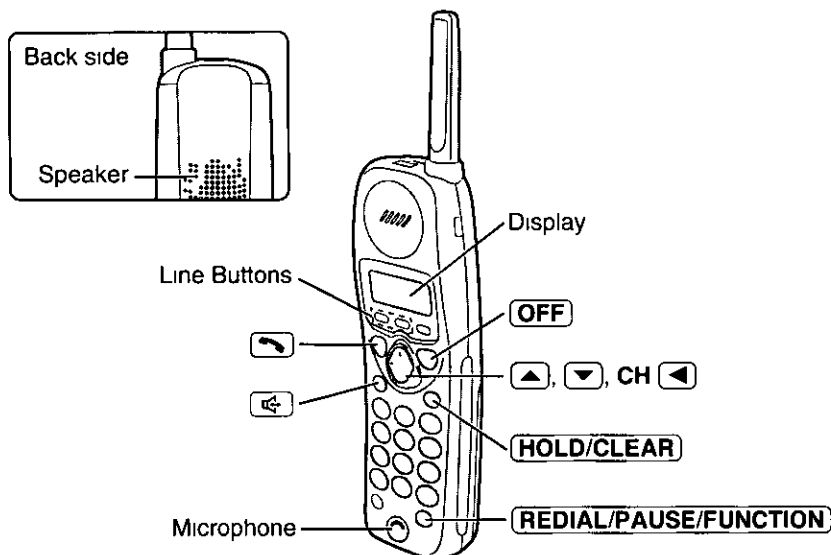

- 1** Press 
- A free line is automatically selected and the line status indication is displayed
  - To change the line selection, see page 52

[L1]	
Talk	Line1

- 2** Dial a phone number
- The dialed number is displayed
  - After a few seconds, the display will show the length of the call and the battery strength

[L1]	
1112222	

[L1]	
Talk	Line1
00-00-10	{■■■■}

- 3** To hang up, press **OFF** or place the handset on the base unit
- The line status indication goes out

Off	
00-01-08	{■■■■}

- If "No link to base Place on cradle and try again " is displayed and an alarm tone sounds in step 1, move closer to the base unit or place the handset on the base unit, and try again
- In step 1, you may select a line manually by pressing the line button instead of 



## To have a hands-free phone conversation (Using Digital Duplex Speakerphone)

- 1** Press .
- A free line is automatically selected and the line status indication is displayed.
  - To change the line selection, see page 52.

[L1]  
SP-phone Line1

- 2** Dial a phone number.
- The dialed number is displayed.
  - After a few seconds, the display will show the length of the call and the battery strength.

[L1]  
1112222

- 3** When the other party answers, talk into the microphone.

[L1]  
SP-phone Line1  
00-00-10 [■■■■]

- 4** To hang up, press **OFF** or place the handset on the base unit.
- The line status indication goes out.





Off  
00-01-08 [■■■■]

- If "No link to base Place on cradle and try again." is displayed and an alarm tone sounds in step 1, move closer to the base unit or place the handset on the base unit, and try again.
- In step 1, you may select a line manually by pressing the line button. To have a hands-free phone conversation, press  following the line button.

Basic operation

### Hands-free Digital Duplex Speakerphone

For best performance, please note the following:

- Talk alternately with the caller in a quiet room.
- If the other party has difficulty hearing you, press  to decrease the speaker volume.
- If the other party's voice from the speaker cuts in/out during a conversation, press  to decrease the speaker volume.
- While talking using , you can switch to the hands-free phone conversation by pressing . To switch back to the receiver, press .

### If noise interferes with the conversation

Press **CH**  to select a clearer channel in the talk or speakerphone mode, or move closer to the base unit.

### To redial the last number dialed

Press ,  or a line button → **REDIAL/PAUSE/FUNCTION**.

## ► Making Calls

### To dial after confirming the entered number

- 1** Enter a phone number.
- If you misdial, press **HOLD/CLEAR**. One digit is erased from the right. Dial the correct phone number.

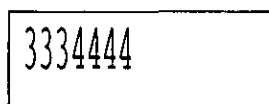

- 2** Press **[hook]** or a line button.
- OR
- To have a hands-free phone conversation, press **[phone]**, and when the other party answers, talk into the microphone.
- After a few seconds, the display will show the length of the call and the battery strength.

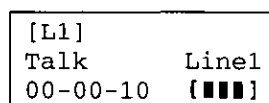
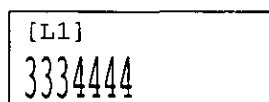

- 3** To hang up, press **OFF** or place the handset on the base unit.

### To adjust the receiver volume (HIGH, MEDIUM or LOW) or speaker volume (6 levels) while talking

Press **[up]** or **[down]** while talking.

#### Receiver volume

- Each time you press **[up]** or **[down]**, the volume level will change from MEDIUM (preset) to HIGH or LOW.
- The display will return to the length of the call.
- When you replace the battery, the selected receiver volume setting will return to the factory set (MEDIUM). Reprogram if necessary.

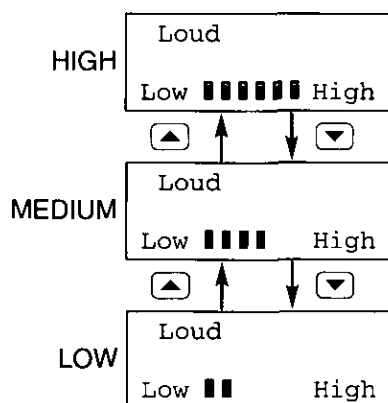

#### Speaker volume (While using **[phone]**)

- Each time you press **[up]** or **[down]**, the volume level will change from level 1 to 6. Your phone comes from the factory set to level 3.

Ex. Speaker volume:  
level 6

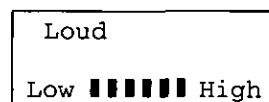



## To put a call on hold

Press **HOLD/CLEAR**

- "Hold" is displayed
- The called line status indication on the display and the IN USE/CHARGE/HOLD indicator on the base unit flash
- If you do not press any key more than 6 minutes, an alarm tone will sound
- If you do not press any key more than 10 minutes after holding a call, a line will be disconnected



## To release the hold

Press the line button whose status indication is flashing

- If another phone is connected on the same line (p 59), you can also release the hold by lifting its handset

## Backlit LCD display

The lighted handset display will stay on for a few seconds after pressing a handset button, lifting the handset off the base unit, hanging up a call or leaving the programming mode

## What the line status indications (“[L1]” and “[L2]”) on the display mean

Off	The line is free
On	You are using the line on the handset or parallel connected telephone
Flashing	A call is on hold
Flashing quickly	A call is being received

# Answering Calls



When a call is received, the unit rings, "Incoming call" is displayed on the display and the CALLED LINE STATUS indicator on the base unit flash quickly. The line is automatically selected when you answer the call. (To change the line selection, see page 52.) If you subscribe to a Caller ID service, the calling party information will be displayed after the first ring (p. 27). In order to view the Caller ID information, please wait until the second ring to answer a call.

If the handset is off the base unit,

Press 

OR

Press , and when the other party answers, talk into the microphone

- The called line status indication stops flashing
- You can also answer a call by pressing any dialing button (0) to (9), (\*), or (#) (—Any Key Talk)
- You may answer a call by pressing the called line button instead of  or 
- When the ringer volume is set to "OFF", the selected line(s) will not ring (p. 20)

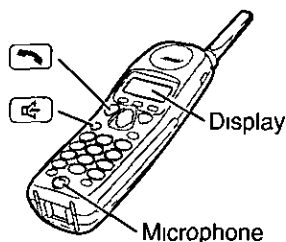

## Auto Talk

If you set the Auto Talk feature to ON (p. 19), you can answer a call by lifting the handset off the base unit without pressing

 or 

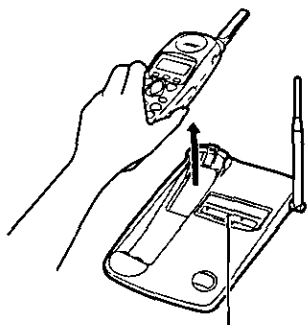

CALLER ID Indicator

When an optional headset is connected (p. 57), make sure to use the headset to talk with the caller. If you want to have a normal cordless phone conversation, disconnect the headset.

# Caller ID Service



This unit is compatible with a Caller ID service offered by your telephone company. If you subscribe to a Caller ID service, the calling party's information will be displayed on the handset after the first ring.

The unit can record information of up to 50 different callers for both lines combined, including the time and date received, the number of times called and the called line, in the Caller List. The Caller List information is sorted by the most recent to the oldest call. When the 51st call is received, the first call is deleted.

Using the list, you can automatically call back a caller. You can store the callers' numbers from the Caller List into the directory.

If you subscribe to a Call Waiting Caller ID Feature, when a second call is received while talking, the new caller's name and phone number will be displayed (p. 50).

## How caller information is displayed when a call is received

The display shows the caller's name, number and the called line after the first ring.

- The called line status indication will flash quickly.

After you answer the call, the display will show the length of the call and the battery strength.

[L1]  
ROBINSON, TINA  
1-000-222-3333

[L1]  
Talk                      Line1  
00-00-10              {■■■■}

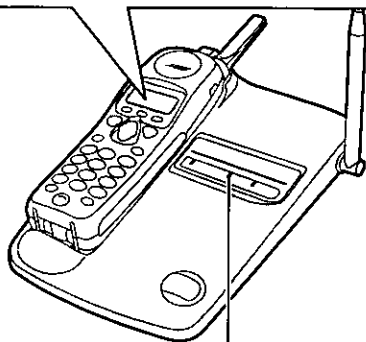

The CALLER ID indicator flashes quickly when a call is being received.

## ► Caller ID Service

- Caller information cannot be displayed in the following cases
  - If the caller dialed from an area which does not provide a Caller ID service, the display will show "Out of area"
  - If the caller has requested not to display his/her information, the display will show "Private caller"
- If your unit is connected to a PBX which does not support Caller ID services, you cannot access those services
- The name display service may not be available in some areas. For further information, please contact your telephone company

### To check the number of new calls

When new calls have been received, the CALLER ID indicator flashes slowly on the base unit

#### While the handset is on the base unit

If you have received 10 new calls, the display will show the following

10 new calls  
{■■■■}

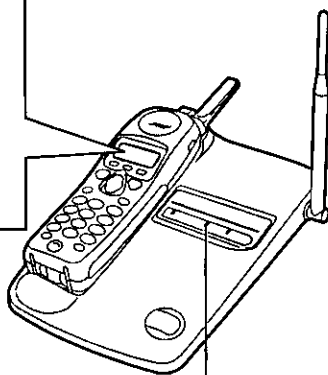

CALLER ID Indicator

#### While the handset is off the base unit:

The unit must be in the standby mode

Press ▼ or ▲ to turn the display on

If you have received 10 new calls, the display will show the following

10 new calls  
▼▲ ▶=Directory

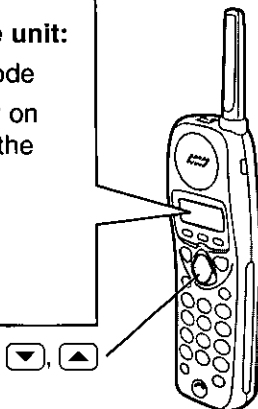

# Using the Caller List



## Viewing the Caller List

To check who has called, follow the steps below.

**Make sure the unit is in the standby mode.**

- 1** Lift the handset off the base unit and press or to enter the Caller List.

- The display will show, for example, the following:

```
2 new calls
▼▲ ▶=Directory
```

- You can go to the directory list by pressing **EDIT** (p. 39).

- 2** To search from the most recent call, press .  
To search from the oldest call, press .

- To scroll between callers, press or .

```
SMITH, JACK
1-222-333-4444
3:10P JUN10
```

- 3** To exit the list, press **OFF**.

- The handset will return to the standby mode.

- Once new calls have been checked, "✓" will be added.
- If "No items stored" is displayed in step 1, the Caller List is empty. Press or to return to the standby mode.
- If more than one call is received from the same caller, the date and time of the most recent call will be recorded. If the same caller calls again, the call entry with "✓" will be deleted.
- If you do not press any buttons for 60 seconds, the unit will return to the standby mode.

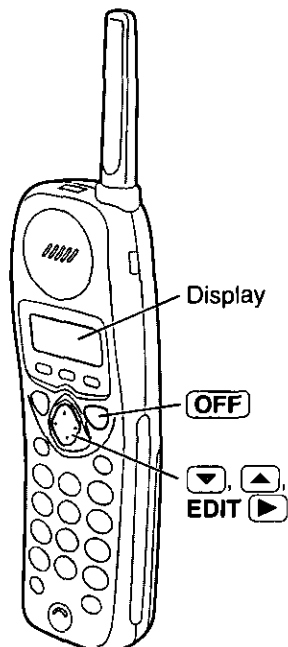

Basic operation

## ► Using the Caller List

**Ex. When you search from the most recent call:**

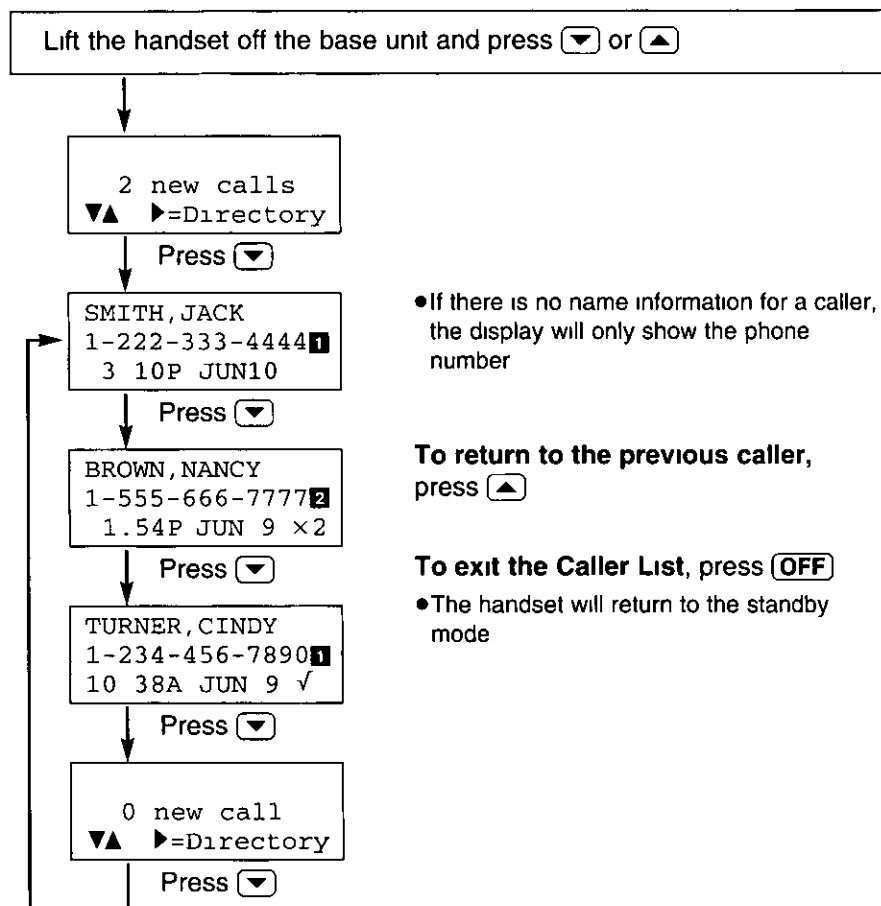

### Display meaning:

- ✓ You have checked this caller information, answered the call or called back the caller
- ×2-×9 The number of times the same caller called (up to 9)  
After checking, "×2"- "×9" will be replaced with "✓"
- 1, 2** Indication of the called line



## Calling Back from the Caller List

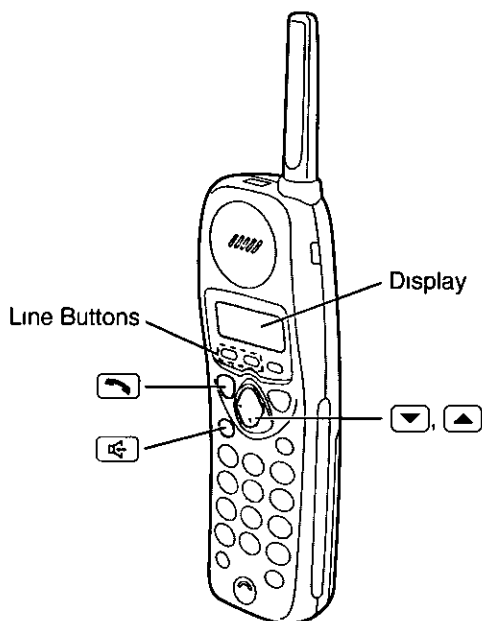

- 1** Lift the handset off the base unit and press or to enter the Caller List

3 new calls  
 =Directory

- 2** Press or repeatedly to find the desired caller

TURNER, CINDY  
 1-234-456-7890   
 11 20A JAN12 x3

- 3** Press or
  - The displayed phone number is dialed automatically
  - You can also press a line button instead of or

[L1]  
 12344567890



- In some cases, you may have to edit the number before dialing (p. 32)  
 (Ex You may have to delete "1" and the area code)
- If a phone number is not displayed in the caller information, you cannot call back that caller

## ► Using the Caller List

### Editing the Caller's Phone Number

The unit can edit a phone number into one of 4 patterns.

**Make sure the unit is in the standby mode.**

1 Lift the handset off the base unit and press  or  to enter the Caller List.

```
5 new calls
▼▲ ▶=Directory
```

2 Press  or  repeatedly to find the desired caller and press **EDIT** .

```
PARKER, FRED
1-234-321-5555 1
11:20A JAN12 ✓
```

```
▶Edit
Save directory
▼▲ ▶=Yes
```

3 While the arrow points to "Edit", press **EDIT**  (Yes key).

```
PARKER, FRED
1-234-321-5555 1
▼=Next ▶=Edit
```

4 Press **EDIT**  (Edit key) to select a pattern.

- Each time you press **EDIT** , the number is rearranged into one of 4 different patterns.

(a)

(b)  -

(c) 1 -

(d) 1 -  -

- The order in which patterns (a)–(d) are displayed depends on how the telephone number is displayed in step 2.

(a) 

```
PARKER, FRED
321-5555
▼=Next ▶=Edit
```

(b) 

```
PARKER, FRED
234-321-5555 1
▼=Next ▶=Edit
```



(c) 

```
PARKER, FRED
1-321-5555 1
▼=Next ▶=Edit
```

(d) 

```
PARKER, FRED
1-234-321-5555 1
▼=Next ▶=Edit
```

5 After editing the number, you can continue with calling back or storing procedures.

To call back, press  or  (p. 31).

To store the number in the directory, press  (Next key). Follow the instructions on the display (p. 33).

```
PARKER, FRED
321-5555 1
▲=Edit ▶=Save
```

- The number edited in step 4 will not be maintained in the Caller List.





## Storing Caller List Information in the Directory

You can store numbers that are in the Caller List in the directory

**Make sure the unit is in the standby mode.**

**1** Lift the handset off the base unit and press or to enter the Caller List

10 new calls  
 =Directory

**2** Press or repeatedly to find the caller you want to store in the directory  
Press **EDIT**

TURNER, CINDY  
1-234-456-7890   
11 20A JAN12 x3

• If the number requires editing, see page 32

Edit  
Save directory  
 =Yes

**3** Press or to select "Save directory", and press **EDIT** (Yes key)

Edit  
 Save directory  
 =Yes

**If there is no name information for the caller, "Enter name" will be displayed.**

Enter name  
 =Next

- If a name is not required, press (Next key) and **EDIT** (Save key)
- If a name is required, enter the name (p 37) When finished, press (Next key) and **EDIT** (Save key)

Enter name  
CINDY TURNER  
 =Next

- A beep sounds
- The display will return to step 2 You can continue storing other items  
To return to the standby mode, press **OFF**

CINDY TURNER  
12344567890  
=Edit =Save

Basic operation



- You can exit the programming mode any time by pressing **OFF**
- If the display shows "Directory full" in step 3, the display will return to step 2 Press **OFF** to exit the list To erase other stored items from the directory, see page 42
- You cannot store caller information in the directory if a phone number is not displayed
- If the display shows "Save error" or "No link to base Place on cradle and try again" in step 3, the item cannot be stored in the directory Try again from step 1

## ► Using the Caller List



### Erasing Caller List Information

After checking the Caller List, you can erase some or all of the entries. **Make sure the unit is in the standby mode.**

#### To erase a specific caller from the Caller List

- 1 Lift the handset off the base unit and press  or  to enter the Caller List.

10 new calls  
▼▲ ▶=Directory

- 2 Press  or  repeatedly to find the caller you want to erase from the Caller List.



REAGAN, TOM  
1-888-777-6666  
12:20A JAN12 ✓

- 3 Press **HOLD/CLEAR**.
- A beep sounds and the information is erased.
  - To erase other items, repeat from step 2.
  - To return to the standby mode, press **OFF**.

Clear

#### To erase all entries in the Caller List



Before erasing all entries, make sure that "0 new call" is displayed.

- 1 Lift the handset off the base unit and press  or  to enter the Caller List.

0 new call  
▼▲ ▶=Directory

- 2 Press **HOLD/CLEAR**.

▶Exit  
All clear  
▼▲ ▶=Yes

- 3 Press  or  to select "All clear".

Exit  
▶All clear  
▼▲ ▶=Yes

- 4 Press **EDIT**  (Yes key) or **HOLD/CLEAR**.

All clear

- A beep sounds and all entries are erased.
- The handset will return to the standby mode.

# Using the Directory



You can store up to 50 names and phone numbers in the directory. All directory items are sorted by the first word in alphabetical order. Using the directory, you can make a call by selecting a name on the handset display.

## Storing Names and Numbers in the Directory



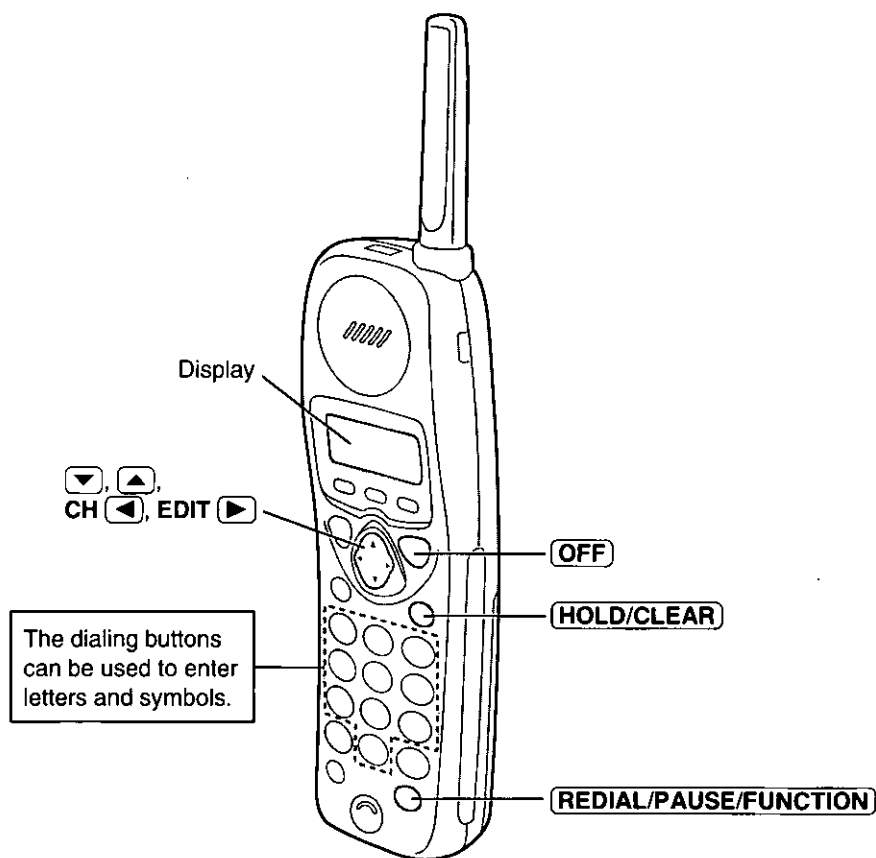





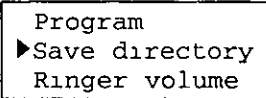

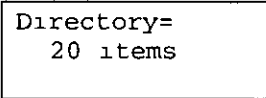
Make sure the unit is in the standby mode.

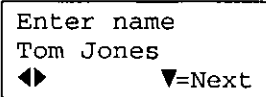
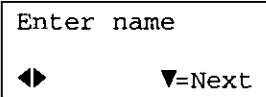

(continued ▶)

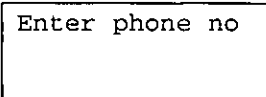
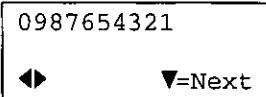
## ► Using the Directory

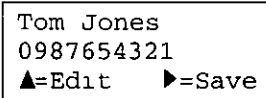
- 1 Press **REDIAL/PAUSE/FUNCTION**  

Program  
► Save directory  
Ringer volume
- 2 While the arrow points to "Save directory", press **EDIT** 
  - The display shows the number of stored items in the directory
- 3 Enter a name, up to 15 characters, with the dialing buttons, **CH**  or **EDIT** 
  - See the steps for entering names and symbols (p 37)
  - If a name is not required, press  (Next key) and go to step 5
- 4 Press  (Next key)  

- 5 Enter a phone number, up to 22 digits
  - Each time you press **HOLD/CLEAR**, a character is erased from the right. To erase all of the digits, press and hold **HOLD/CLEAR**
- 6 Press  (Next key)  

- 7 Press **EDIT**  (Save key)
  - A beep sounds
  - To continue storing other items, repeat from step 2
  - To return to the standby mode, press **OFF**

- If a pause is required for dialing, **REDIAL/PAUSE/FUNCTION** can be stored in a phone number counting as one digit (p 50) in step 5
- You can exit the programming mode any time by pressing **OFF**
- If the display shows "Directory full" in step 2, the display will return to step 1. Press **OFF** to exit the list. To erase other stored items from the directory, see page 42
- If the display shows "save error" in step 7, the item cannot be stored in the directory. Try again from step 1

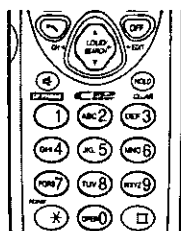
## Steps for Entering Names and Symbols

The handset dialing buttons (0 to 9), CH ◀ and EDIT ▶ can be used to enter letters and symbols. Each button selects a character as shown below.



Keys	Number of times key is pressed										
	1	2	3	4	5	6	7	8	9	10	11
①	#	&	'	(	)	*	,	-		/	1
②	A	B	C	a	b	c	2				
③	D	E	F	d	e	f	3				
④	G	H	I	g	h	i	4				
⑤	J	K	L	j	k	l	5				
⑥	M	N	O	m	n	o	6				
⑦	P	Q	R	S	p	q	r	s	7		
⑧	T	U	V	t	u	v	8				
⑨	W	X	Y	Z	w	x	y	z	9		
⑩	0	Blank									
CH ◀	To move the cursor to the left										
EDIT ▶	To move the cursor to the right										

Advanced Operation





- To enter another character using the same dialing button, press EDIT ▶ to move the cursor to the next space.

### If you make a mistake while entering a name



Use CH ◀ or EDIT ▶ to move the cursor to the incorrect character, press **HOLD/CLEAR** to delete and enter the correct character. Each time you press **HOLD/CLEAR**, a character is erased from the right. To erase all characters, press and hold **HOLD/CLEAR**.

## ► Using the Directory

For example, to enter "Tom Jones":

- 1 Press **REDIAL/PAUSE/FUNCTION**.
- 2 While the arrow points to "Save directory", press **EDIT** .
- 3 Press **8**.
- 4 Press **6** six times, then press **EDIT**  to move the cursor to the right.
- 5 Press **6** four times.
- 6 Press **EDIT**  twice to enter a blank.
- 7 Press **5**.
- 8 Press **6** six times, then press **EDIT**  to move the cursor to the right.
- 9 Press **6** five times.
- 10 Press **3** five times.
- 11 Press **7** eight times.
- 12 When finished, press  (Next key).
  - Follow steps 5 to 7 on page 36 to complete the operation.

Directory=  
20 items

Enter name  
()  =Next

T

To

Tom



Tom (

Tom J

Tom Jo

Tom Jon

Tom Jones

Enter name  
Tom Jones  
 =Next

Enter phone no.

• While entering names, the cursor will flash on the display.



# Finding Items in the Directory

Make sure the unit is in the standby mode.

- 1 Press CH ◀ or EDIT ▶ to enter the directory list.

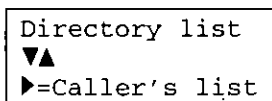

- In step 1, you can go to the Caller List by pressing EDIT ▶ (p. 29).

- 2 Press ▼ or ▲.

- The first item is displayed.

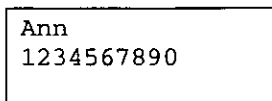

- 3 Press ▼ or ▲ repeatedly until the desired item is displayed.

- All directory items are stored in the order shown on the right.

To search for a name by the initial:

- ① Press the dialing button for the first letter of the desired name until any name with the same initial is displayed (see the Index table on page 40).

Ex. To find "Frank", press ③ repeatedly until the first item under "F" is displayed.

- ② Press ▼ until the name is displayed.

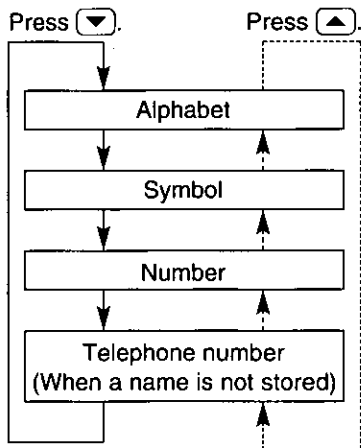
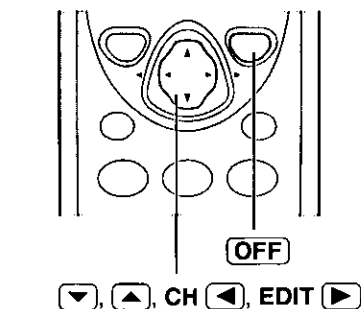

Advanced Operation

- You can exit the directory list any time by pressing OFF.
- If "No items stored" is displayed in step 2, the directory is empty. To return to the standby mode, press OFF.

## ► Using the Directory

### Index table

Keys	Index	Keys	Index
①	Other symbols, 1	⑥	M, N, O, 6
②	A, B, C, 2	⑦	P, Q, R, S, 7
③	D, E, F, 3	⑧	T, U, V, 8
④	G, H, I, 4	⑨	W, X, Y, Z, 9
⑤	J, K, L, 5	⑩	0

### Dialing from the Directory

- 1 Press **CH** (◀) or **EDIT** (▶) to enter the directory list.
- 2 Press (▼) or (▲).
  - The first item is displayed.
- 3 Press (▼) or (▲) repeatedly to find the directory item that you want to dial.
  - To search for the item by initial, see page 39.
- 4 Press (☎) or (☎).
  - The number is dialed automatically.
  - You can also press a line button instead of (☎) or (☎).
- 5 To hang up, press **OFF** or place the handset on the base unit.

Frank  
4567890

[L1]  
4567890

- You can exit the directory list any time by pressing **OFF**.





## Editing an Item in the Directory

Make sure the unit is in the standby mode.

1 Press **CH** (◀) or **EDIT** (▶) to enter the directory list.

2 Press (▼) or (▲).  
•The first item is displayed.

3 Press (▼) or (▲) repeatedly to find the directory item you want to change, and press **EDIT** (▶).

- To search for the item by initial, see page 39.
- If you do not need to change the name, go to step 5.

Jane 1234567
-----------------

Enter name Jane ◀▶ ▼=Next
---------------------------------

4 Edit the name using the dialing buttons, **CH** (◀) or **EDIT** (▶) (p. 37), up to 15 characters.

Enter name Jane Walker ◀▶ ▼=Next
--

5 Press (▼) (Next key).

1234567 ◀▶ ▼=Next
----------------------

6 Add a number to the current number.  
•If you do not need to change the number, press (▼) (Next key) and go to step 8.  
•Each time you press **HOLD/CLEAR**, a character is erased from the right. To erase all of the digits, press and hold **HOLD/CLEAR**.

0981234567 ◀▶ ▼=Next
-------------------------

7 Press (▼) (Next key).

Jane Walker 0981234567 ▲=Edit ▶=Save
--

8 When finished, press **EDIT** (▶) (Save key).  
•To continue editing other items, repeat steps 3 through 8.  
•To return to the standby mode, press **OFF**.

Jane Walker 0981234567
---------------------------

Advanced Operation

•You can exit the directory list any time by pressing **OFF**.

## ► Using the Directory

---

### Erasing an Item from the Directory

Make sure the unit is in the standby mode.

1 Press **CH** (◀) or **EDIT** (▶) to enter the directory list.

2 Press (▼) or (▲).  
•The first item is displayed.

3 Press (▼) or (▲) repeatedly to find the directory item you want to erase.  
•To search for the item by initial, see page 39.

Helen 1234567890
---------------------

4 Press **HOLD/CLEAR**.  
•To stop erasing, press **CH** (◀) (No key).

Clear?
◀=No      ▶=Yes

5 Press **EDIT** (▶) (Yes key) or **HOLD/CLEAR**.  
•A beep sounds.  
•To erase other items, repeat from step 3.  
•To return to the standby mode, press **OFF**.

Clear
-------

•You can exit the directory list any time by pressing **OFF**.

# Voice Mail Service



Voice mail service is an electronic on-line answering system offered by your telephone company. After subscribing, the voice mail system can answer calls automatically when your line is busy or if calls are not answered. Callers can leave messages by following the pre-recorded instructions. When voice mail messages will be recorded, "Voicemail" and the recording line(s) will be displayed while the handset is off the base unit and the VOICE MAIL indicator on the base unit will flash. To use this feature, you must first store your access number.

## Storing a Voice Mail Access Number

Make sure the unit is in the standby mode.

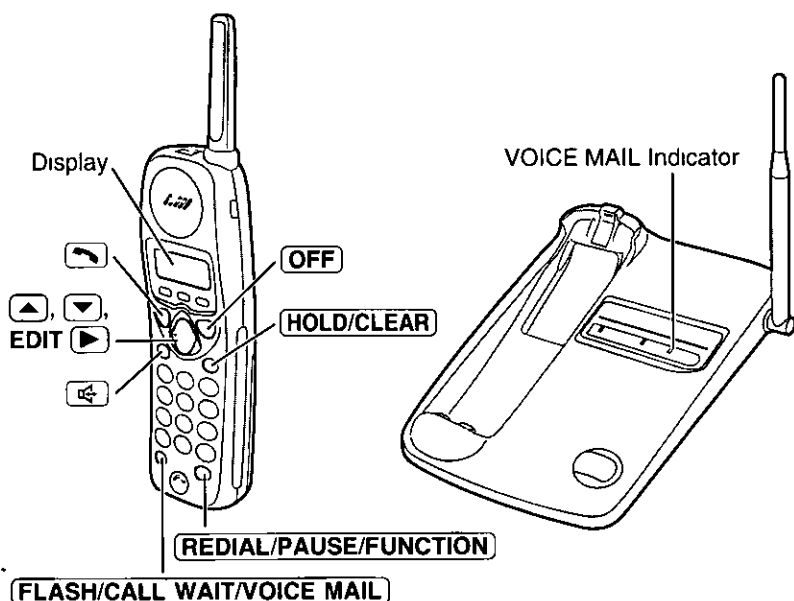



Advanced Operation

- 1 Press **REDIAL/PAUSE/FUNCTION**
- 2 Press **▼** or **▲** repeatedly until the arrow points to "Program"
- 3 Press **EDIT ▶**

Ringer volume
▶ Program
Save directory

(continued ➡)



## ► Voice Mail Service

4 Press  or  repeatedly until the arrow points to "Save mailbox#"

Set flash time  
► Save mailbox#  
Voicemail tone

5 Press EDIT 

Save mailbox#  
▼=Line1 ▲=Line2

6 Press  (Line1) or  (Line2) to select the desired line

◀▶                      ▼=Next

7 Enter your access number, up to 32 digits

- You may enter pauses\*
- If you enter a wrong number, press **HOLD/CLEAR**. Digits are erased from the right. To erase all of the digits, press and hold **HOLD/CLEAR**.

1234567PPP8901  
◀▶                      ▼=Next

8 Press  (Next key)

- If you want to edit the entered number, press  (Edit key) and return to step 7

1234567PPP8901  
▲=Edit    ▶=Save

9 Press EDIT  (Save key)

- A beep sounds
- To program the other line, start again from step 4
- To return to the standby mode, press **OFF**

1234567PPP8901  
Save mailbox#



\*For quick access to your voice mail box by using **FLASH/CALL WAIT/VOICE MAIL**, you may add pauses between your voice mail box access number and your mail box password in step 7

Ex 1-222-333-4444 PPP 8888

Your voice mail box access number | Pauses | Your mail box password

Pressing **REDIAL/PAUSE/FUNCTION** once creates a 3.5 second delay and counts as one digit. The delay time depends on a telephone company.

### To erase a stored number

Repeat steps 1 through 6 → press and hold **HOLD/CLEAR** until all of the digits are erased →  (Next key) → EDIT  (Save key)

- A beep sounds
- You can exit the programming mode any time by pressing **OFF**



## Setting the Voice Mail Tone

If your voice mail service sends a voice mail tone after a new message has been recorded, set to "On" "Voicemail" and the recording line(s) will be displayed while the handset is off the base unit and the VOICE MAIL indicator on the base unit will flash when a message has been recorded in your mailbox. You will hear a series of voice mail tones followed by a dial tone after pressing or (Contact your service provider for details about your service)

Set to "Off" if

- you do not subscribe to a voice mail service,
- your voice mail service does not send a voice mail tone, or
- the unit is connected to a PBX

Your phone comes from the factory set to "On"

**Make sure the unit is in the standby mode.**

- 1 Press **REDIAL/PAUSE/FUNCTION**
- 2 Press or repeatedly until the arrow points to "Program"
- 3 Press **EDIT**
- 4 Press or repeatedly until the arrow points to "Voicemail tone"
- 5 Press **EDIT**
- 6 Press (Line1) or (Line2) to select the desired line
- 7 Press or to select "Off" or "On"
- 8 Press **EDIT** (Save key)
  - A beep sounds
  - To program the other line, start again from step 4
  - To return to the standby mode, press **OFF**

Ringer volume
▶Program
Save directory

Save mailbox#
▶Voicemail tone
Set line mode

Voicemail tone
▼=Line1 ▲=Line2

Voicemail tone
Line1 · On
▼▲ ▶=Save

Voicemail tone
Line1 Off

Advanced Operation

•You can exit the programming mode any time by pressing **OFF**

## ► Voice Mail Service

---

### Listening to Voice Mail Messages

After receiving a voice mail message, "Voicemail" and the recording line(s) will be displayed while the handset is off the base unit and the VOICE MAIL indicator on the base unit will flash.

To listen to your voice mail message(s), follow the steps below.

1 Press **FLASH/CALL WAIT/VOICE MAIL**.

- The line(s) which has(have) received voice mail message(s) will flash on the display.

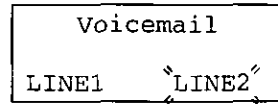

2 Press the line button(s) whose status indication(s) is(are) flashing on the display.

- The stored voice mail access number (p. 43, 44) is displayed and automatically dialed.
- The IN USE/CHARGE/HOLD indicator lights.

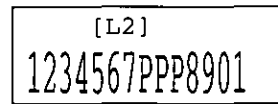

3 Follow the pre-recorded instructions.

4 When finished, press **OFF**.

- If "Voicemail" still remain on the display or the VOICE MAIL indicator still flashes even if you have listened to your voice mail message(s), press **REDIAL/PAUSE/FUNCTION**, and press and hold **HOLD/CLEAR** until the unit beeps. "Voicemail" will disappear and the VOICE MAIL indicator will turn off.
- If your voice mail service uses a voice mail tone and the recorded message is over 3 minutes long, "Voicemail" may not be displayed and the VOICE MAIL indicator may not flash.
- If your voice mail service uses a voice mail tone, the tone will be heard from any parallel connected phone. If you use another phone to retrieve messages, you have to dial your access number manually.

# Using the Other Line During a Conversation

During a conversation, if **two tones** sound and the other line status indication on the display flashes quickly, an incoming call is being received on that line. You can answer the second call while holding the first call. You can also make a call without terminating the first call. If you subscribe to a Caller ID service, the second caller's information will be displayed when a call is being received on the other line (p. 27)

You may delete the **two tones** (incoming call tone) by programming. See page 53.

## EX: If you are using LINE 1

### To make a second call

1 Press **HOLD/CLEAR** to put the first call (LINE 1) on hold.

- The LINE 1 status indication flashes.

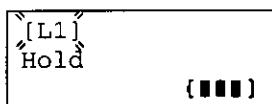

2 Press the other line button (LINE 2) and dial a phone number.

- The LINE 2 status indication is displayed.

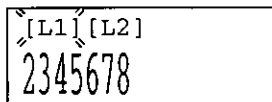

3 To return to the first call (LINE 1), press the line button for the first call (LINE 1).

- The second call is terminated.

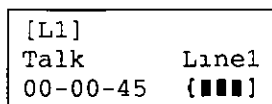

### To answer a second call

1 Press **HOLD/CLEAR** to put the first call (LINE 1) on hold.

- The LINE 1 status indication flashes and the unit rings.
- The LINE 2 status indication flashes quickly.

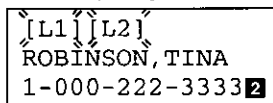

2 Press the other line button (LINE 2) to answer a second call.

- The LINE 1 status indication flashes and the LINE 2 status indication is displayed.

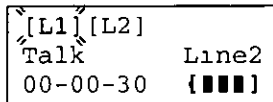

3 To return to the first call (LINE 1), press the line button for the first call (LINE 1).

- The second call is terminated.

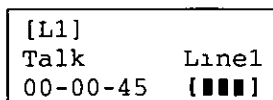

- To hold the second call in step 3, press **HOLD/CLEAR** before pressing the line button for the first call.

# Conference Call

While having a conversation on one line, you can make or answer a second call on the other line and then combine the calls to make a conference call

**EX: If you are using LINE 1**

## To make a second call

1 Press **HOLD/CLEAR** to put the first call (LINE 1) on hold

- The LINE 1 status indication flashes

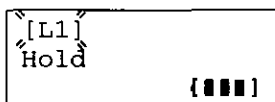

[L1]  
Hold {■■■■}

2 Press the other line button (LINE 2) and dial a phone number

- The LINE 2 status indication is displayed

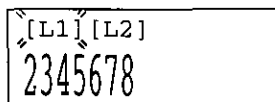

[L1] [L2]  
2345678

3 When the other party answers, press **CONF** to make a conference call

- Both line status indications are displayed

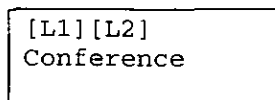

[L1] [L2]  
Conference

## To answer a second call

1 Press **HOLD/CLEAR** to put the first call (LINE 1) on hold

- The LINE 1 status indication flashes and the unit rings
- The LINE 2 status indication flashes quickly

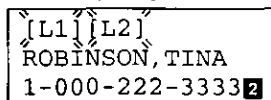

[L1] [L2]  
ROBINSON, TINA  
1-000-222-3333

2 Press the other line button (LINE 2) to answer a second call

- The LINE 1 status indication flashes and the LINE 2 status indication is displayed

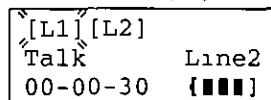

[L1] [L2]  
Talk Line2  
00-00-30 {■■■■}

3 When the second call is connected, press **CONF** to make a conference call

- Both line status indications are displayed

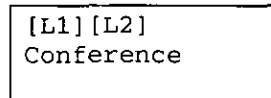

[L1] [L2]  
Conference

### During a conference call:

- To hang up both lines, press **OFF**
- To hang up only one line, press the line button for the party with which you want to continue talking
- To put both lines on hold, press **HOLD/CLEAR**  
To talk with only one caller, press the corresponding line button (The other caller is put on hold)  
To resume both lines, press **CONF**



# Special Features

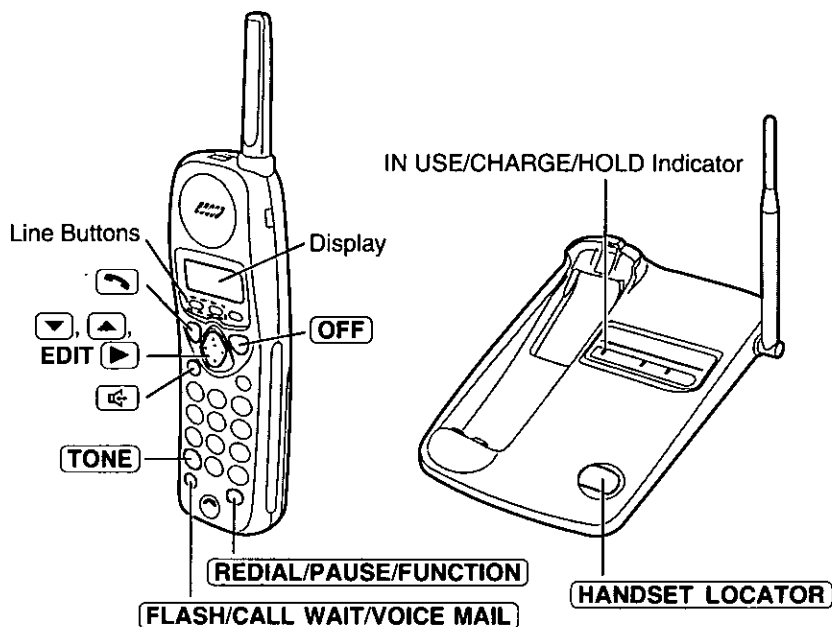

## Automatic Security Code Setting

Each time you place the handset on the base unit, the unit automatically selects one of more than a million security codes. These codes help prevent the unauthorized use of your telephone line by another cordless telephone user.

## Handset Locator

You can locate the handset or page the handset user with beep tones from the base unit.

1. Press **HANDSET LOCATOR**.

- The IN USE/CHARGE/HOLD indicator flashes. The handset beeps for 1 minute and "Paging" is displayed.

2. To stop paging, press **HANDSET LOCATOR** again or press and **OFF** on the handset.

- If an incoming call is received, the unit starts to ring. To answer, press , or the called line button.

## ► Special Features

---

### Temporary Tone Dialing (For Rotary or Pulse Service Users)

Press **[TONE]** before entering access numbers which require tone dialing.

- The dialing mode changes to tone. You can enter numbers to access an answering service, electronic banking service, etc. When you hang up, the mode will return to pulse.
- Access numbers entered after pressing **[TONE]** will not be included when redialing.

### How to Use the PAUSE Button (For Analog PBX Line/Long Distance Service Users)

We recommend you press **[REDIAL/PAUSE/FUNCTION]** if a pause is required for dialing with a PBX or to access a long distance service.

Ex. Line access number **[9]** (PBX)

**[9]** → **[REDIAL/PAUSE/FUNCTION]** → **[Phone number]**

- Pressing **[REDIAL/PAUSE/FUNCTION]** once creates a 3.5 second pause. This prevents misdialing when you redial or dial a stored number.
- Pressing **[REDIAL/PAUSE/FUNCTION]** more than once increases the length of the pause between numbers.

### For Call Waiting Service Users

Press **[FLASH/CALL WAIT/VOICE MAIL]** if you hear a call-waiting tone while talking.

- The first call is put on hold and you can answer the second call.
- To return to the first caller, press **[FLASH/CALL WAIT/VOICE MAIL]** again.
- The call waiting service cannot be used when:
  - a parallel connected telephone is in use, or
  - you are having a conference call (p. 48).
- If this function does not operate properly, consult your telephone company for details.

### Call Waiting Caller ID Feature

Call Waiting Caller ID Feature allows your handset to display the second caller's information. After you hear a call-waiting tone while talking, the handset will display the caller's name with the phone number, the called line and "----Waiting----".

BROWN, NANCY 1-000-333-4444 ----Waiting----
---

- Please contact your telephone company for details and availability in your area.



## FLASH Button

Pressing **FLASH/CALL WAIT/VOICE MAIL** allows you to use special features of your host PBX such as transferring an extension call or accessing special telephone services (optional) such as call waiting.

### Selecting the flash time

The flash time depends on your telephone exchange or host PBX. You can select the following flash times: "700, 600, 400, 300, 250, 110, 100 or 90 ms (milliseconds)". Your phone comes from the factory set to "700 ms".

**Make sure the unit is in the standby mode.**

1 Press **REDIAL/PAUSE/FUNCTION**.

2 Press **▼** or **▲** repeatedly until the arrow points to "Program".

```
Ringer volume
▶Program
Save directory
```

3 Press **EDIT ▶**.

4 Press **▼** or **▲** repeatedly until the arrow points to "Set flash time".

```
LCD contrast
▶Set flash time
Save mailbox#
```

5 Press **EDIT ▶**.

```
Flash time
▼=Line1 ▲=Line2
```

6 Press **▼** (Line1) or **▲** (Line2) to select the desired line.

```
Flash time
Line1:700ms
▼▲ ▶=Save
```

7 Press **▼** or **▲** repeatedly until the desired time is displayed.

8 Press **EDIT ▶** (Save key).

```
Flash time
Line1:110ms
```

- A beep sounds.
- To program the other line, start again from step 4.
- To return to the standby mode, press **OFF**.

- You can exit the programming mode any time by pressing **OFF**.
- If you are connected via a PBX, a longer flash time may be necessary to use PBX functions (transferring a call etc.). Consult your PBX supplier for the correct setting.



## ► Special Features

### Line Selection

The unit will automatically select a free line which is not being used by a parallel connected telephone when you make a call. The unit will select the called line when you answer a call. To change the line selection, program as follows.

**Make sure the unit is in the standby mode.**

1 Press **REDIAL/PAUSE/FUNCTION**.

2 Press  or  repeatedly until the arrow points to "Program".

```
Ringer volume
▶Program
Save directory
```

3 Press **EDIT** .

4 Press  or  repeatedly until the arrow points to "Line selection".

```
Set dial mode
▶Line selection
Incoming call.
```

5 Press **EDIT** .

•The current selection is displayed.

**Line1:** LINE 1 will be selected.

**Line2:** LINE 2 will be selected.

**Auto:** A free line will be selected (LINE 1 has priority) when making a call. The called line is automatically selected when answering a call (factory preset).

```
Line selection
:Auto
▼▲ ▶=Save
```

6 Press  or  repeatedly until the desired line selection is displayed.

```
Line selection
:Line2
▼▲ ▶=Save
```

7 Press **EDIT**  (Save key).

•A beep sounds.

•To return to the standby mode, press **OFF**.

```
Line selection
:Line2
```

•You can exit the programming mode any time by pressing **OFF**.

•Any line can be selected manually, regardless of the mode selected in step 6, by pressing the line button.

# Incoming Call Tone

While one line is being used, you can be informed if another call arrives on the other line by two tones. This incoming call tone can be set/deleted by programming. Your phone comes from the factory set to "2".

**Make sure the unit is in the standby mode.**

1 Press **REDIAL/PAUSE/FUNCTION**.

2 Press **▼** or **▲** repeatedly until the arrow points to "Program".

```
Ringer volume
▶Program
Save directory
```

3 Press **EDIT** **▶**.

4 Press **▼** or **▲** repeatedly until the arrow points to "Incoming call".

```
Line selection
▶Incoming call.
Talk switching
```

5 Press **EDIT** **▶**.

•The current setting is displayed.

**On:** The incoming call tone will be heard for as long as the other line rings.

**2:** The incoming call tone will only be heard 2 times (factory preset).

**Off:** The incoming call tone will not be heard.

```
Incoming call
tone:On
▼▲ ▶=Save
```

6 Press **▼** or **▲** repeatedly until the desired setting is displayed.

```
Incoming call
tone:2
▼▲ ▶=Save
```

7 Press **EDIT** **▶** (Save key).

•A beep sounds.

•To return to the standby mode, press **OFF**.

```
Incoming call
tone:2
```

•You can exit the programming mode any time by pressing **OFF**.

# Wall Mounting

This unit can be mounted on a wall phone plate

- 1 Push the hook and turn it around  
Turn the hook until a click is heard

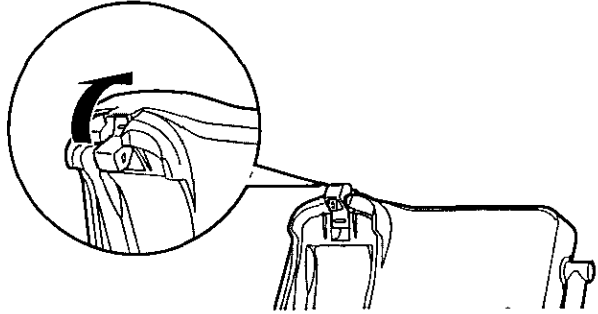

- 2 Connect the AC adaptor

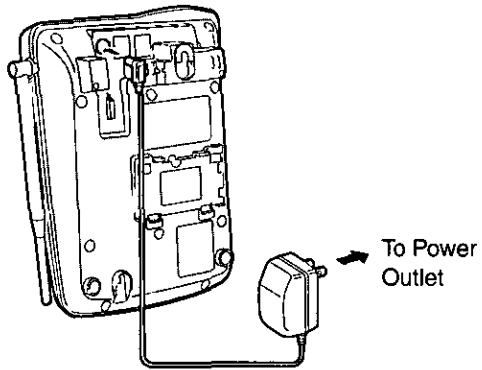

- 3 Tuck the telephone line cord inside the wall mounting adaptor, then push it in the direction of the arrow

- The word "UP" should face upward

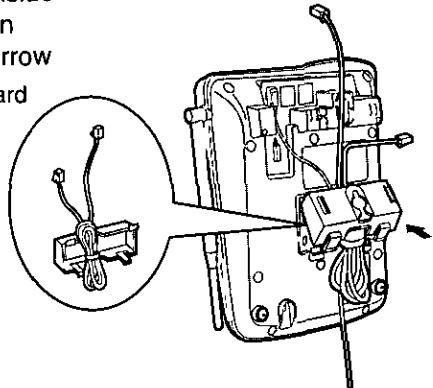

**4** Connect the telephone line cord  
Mount the unit, then slide down

- Raise the antenna
- Fasten the telephone line cord to prevent it from being disconnected

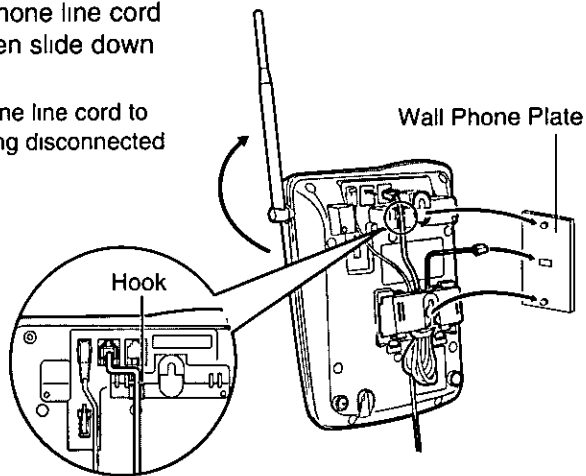

**5** To charge the battery:  
Fix the charge contacts (①) and insert  
the hook to the handset hole (②)

- The IN USE/CHARGE/HOLD indicator lights

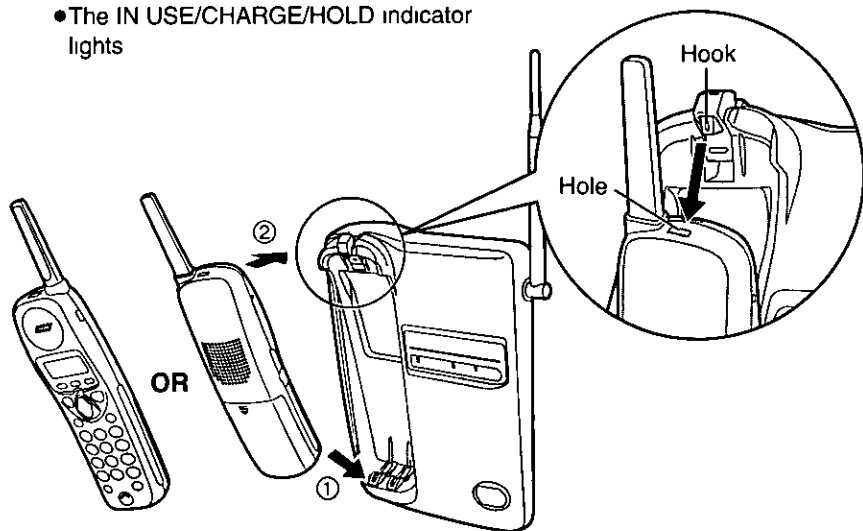

# Using the Belt Clip

---

You can hang the handset on your belt or pocket using the belt clip.

**To attach the belt clip**

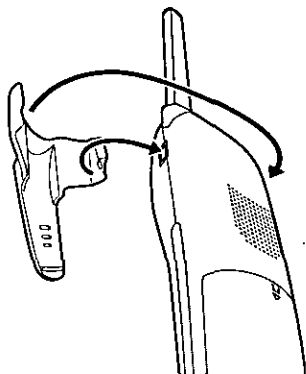

**To remove the belt clip**



# Using an Optional Headset

---

Plugging the headset into the handset allows a hands-free phone conversation.

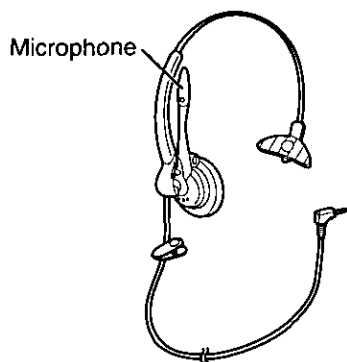

Please use only a Panasonic KX-TCA87 or KX-TCA90 headset.

To order, call the accessories telephone number on page 2.

The illustration headset is a KX-TCA90.



---

## Connecting an optional headset to the handset

Open the headset jack cover, and connect an optional headset to the headset jack as shown below

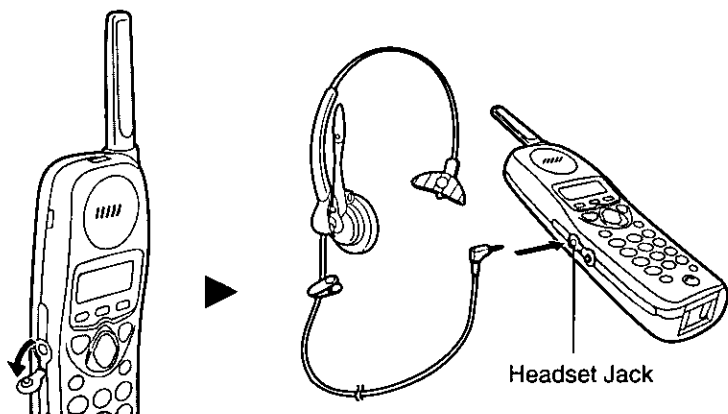

When an optional headset is connected to the handset, make sure to use the headset to talk with the caller. If you want to have a normal cordless phone conversation, disconnect the headset.

## How to wear the headset

- 1 Place the headset on your head and attach the clothing clip to the desired position
- 2 Adjust the microphone to a comfortable position
  - Place the microphone near your mouth



# Battery Replacement

---

If "Recharge" is displayed and/or "[ ■ ]" flashes after being fully charged, replace the battery with a new Panasonic P-P504 battery  
To order, call the accessories telephone number on page 2

- 1** Press the notch on the battery cover firmly and slide it as indicated by the arrow

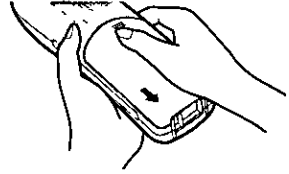

- 2** Remove the old battery  
Then install the new one

- Insert the battery plug into the connector as shown in the picture

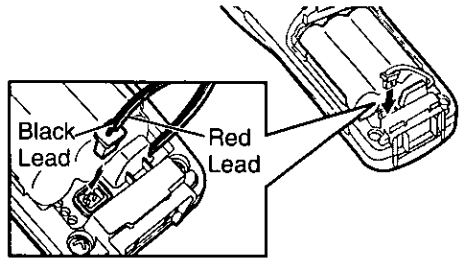

- 3** Close the cover Make sure you charge the new battery for about 15 hours in order to display the battery strength prompt correctly (p 14)

A nickel cadmium battery that is recyclable powers the product you have purchased. At the end of its useful life, under various state and local laws, it is illegal to dispose of this battery into your municipal waste stream. Please call 1-800-8-BATTERY for information on how to recycle this battery.



# Adding Another Phone





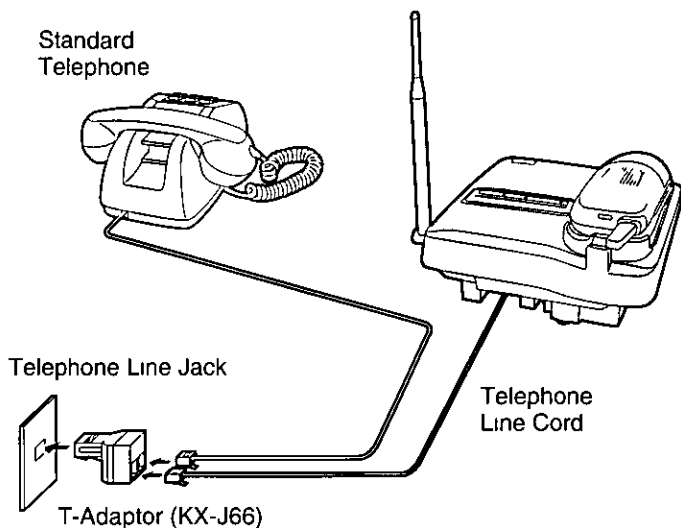



---

This unit will not function during a power failure To connect a standard telephone on the same line, use the Panasonic T-adaptor KX-J66  
To order, call the accessories telephone number on page 2



# Before Requesting Help

---

Problem	Cause and Remedy
The unit does not work	<ul style="list-style-type: none"><li>• Check the settings (p 11–17)</li><li>• Charge the battery fully (p 14)</li><li>• Clean the charge contacts and charge again (p 15)</li><li>• Install the battery properly (p 58)</li><li>• Place the handset on the base unit and unplug the AC adaptor to reset Plug in, and try again</li></ul>
“No link to base Place on cradle and try again ” is displayed and an alarm tone sounds	<ul style="list-style-type: none"><li>• You are too far from the base unit Move closer and try again</li><li>• Place the handset on the base unit and try again</li><li>• Plug in the AC adaptor</li><li>• Raise the base unit antenna</li></ul>
Static, sound cuts in/out, fades Interference from other electrical units	<ul style="list-style-type: none"><li>• Locate the handset and the base unit away from other electrical appliances (p 3)</li><li>• Move closer to the base unit</li><li>• Raise the base unit antenna</li><li>• Press CH  to select a clearer channel in the talk or speakerphone mode</li></ul>
The handset does not ring	<ul style="list-style-type: none"><li>• The ringer volume is set to OFF Set to HIGH or LOW (p 20)</li></ul>
The line status indications do not work properly	<ul style="list-style-type: none"><li>• Check the settings (p 11–17)</li><li>• The line mode selection is incorrect See page 17</li></ul>
The handset display is blank	<ul style="list-style-type: none"><li>• The handset is in the standby mode (p 15) Press , , CH  or EDIT  to turn the display on</li></ul>
The handset display is still blank after pressing  ,  , CH  or EDIT 	<ul style="list-style-type: none"><li>• Charge the battery fully (p 14)</li></ul>
Speech is cut off in places during a conversation using the speakerphone	<ul style="list-style-type: none"><li>• If another call is received on the other line, the conversation will be interrupted in order to receive the Caller ID information</li></ul>





Problem	Cause and Remedy
You cannot program items, such as the dialing mode.	<ul style="list-style-type: none"><li>• Programming is not possible while the unit is in the talk or speakerphone mode, or when viewing the Caller List/directory list.</li><li>• Do not pause for over 60 seconds while programming.</li><li>• Move closer to the base unit.</li><li>• <b>▼</b>, <b>▲</b>, <b>CH</b> <b>◀</b> or <b>EDIT</b> <b>▶</b> may have been pressed when you picked up the handset. Press <b>OFF</b> and try again.</li></ul>
Previously programmed information is erased.	<ul style="list-style-type: none"><li>• If a power failure occurs, programmed information may be erased. Reprogram if necessary.</li></ul>
You cannot store a name and phone number in the directory.	<ul style="list-style-type: none"><li>• You cannot store an item in the directory while the unit is in the talk mode.</li><li>• Do not pause for over 60 seconds while storing.</li></ul>
While programming or searching, the unit starts to ring and stops the program/search.	<ul style="list-style-type: none"><li>• To answer the call, press <b>📞</b>, <b>📞</b> or the relevant line button. Start again from the beginning after hanging up.</li></ul>
During a conversation, the other line status indication flashes quickly and the display shows another caller's information.	<ul style="list-style-type: none"><li>• Someone is calling you on the other line. To answer, press <b>HOLD/CLEAR</b> to put the current call on hold. Press the line button whose status indication is flashing <b>quickly</b> on the display (p. 47).</li></ul>
The unit does not display the caller's name and/or phone number.	<ul style="list-style-type: none"><li>• You do not subscribe to a Caller ID service.</li><li>• Other telephone equipment may be interfering with your phone. Disconnect it and try again.</li><li>• Other electrical appliances connected to the same outlet may be interfering with the Caller ID information.</li><li>• Telephone line noise may be affecting the Caller ID information.</li></ul>

## ► Before Requesting Help

---

Problem	Cause and Remedy
The display returns to the standby mode while viewing the Caller List.	● Do not pause for over 60 seconds while searching.
When a second call is received during a conversation, the unit does not display the new caller's name and/or phone number.	● The line mode selection is incorrect. See page 17. ● The caller requested not to send his/her information. See page 28.
<b>HANDSET LOCATOR</b> does not function.	● The handset is too far from the base unit. ● The handset is engaged in an outside call or is viewing the Caller List/directory list. Wait until the IN USE/CHARGE/HOLD indicator light goes out.
You cannot redial by pressing <b>REDIAL/PAUSE/FUNCTION</b> .	● If the last number dialed was more than 32 digits long, the number will not be redialed correctly. ● Access numbers entered after pressing <b>TONE</b> will not be included when redialing.
"Recharge" is displayed, "[ ■]" flashes or the unit beeps intermittently.	● Charge the battery fully (p. 14).
You charged the battery fully, but "Recharge" is still displayed and/or "[ ■]" continues to flash.	● Clean the charge contacts and charge again (p. 15). ● Install a new battery (p. 58).
The IN USE/CHARGE/HOLD indicator light does not go out while charging.	● This is normal.

Problem	Cause and Remedy
You cannot have a conversation using the handset	<ul style="list-style-type: none"> <li>● When an optional headset is connected (p 57), you must use the headset to talk with the caller To have a normal cordless phone conversation, disconnect the headset</li> </ul>
You cannot have a conversation using the headset	<ul style="list-style-type: none"> <li>● Make sure that an optional headset is connected properly (p 57)</li> <li>●  may have been pressed If "SP-phone" is displayed, press  to continue the conversation with the headset</li> </ul>
If you cannot solve your problem	<ul style="list-style-type: none"> <li>● Call our customer call center at 1-800-211-PANA(7262)</li> <li>● Panasonic's e-mail address for customer inquiries consumerproducts@panasonic.com for customers in the USA or Puerto Rico ONLY</li> </ul>

# Important Safety Instructions

---

When using this unit, basic safety precautions should always be followed to reduce the risk of fire, electric shock, or personal injury

- 1 Read and understand all instructions
- 2 Follow all warnings and instructions marked on this unit
- 3 Unplug this unit from AC outlets before cleaning Do not use liquid or aerosol cleaners Use a damp cloth for cleaning
- 4 Do not use this unit near water, for example, near a bathtub, washbowl, kitchen sink, or the like
- 5 Place this unit securely on a stable surface Serious damage and/or injury may result if the unit falls
- 6 Do not cover slots and openings on the unit They are provided for ventilation and protection against overheating Never place the unit near radiators, or in a place where proper ventilation is not provided
- 7 Use only the power source marked on the unit If you are not sure of the type of power supplied to your home, consult your dealer or local power company
- 8 Do not place objects on the power cord Install the unit where no one can step or trip on the cord
- 9 Do not overload wall outlets and extension cords This can result in the risk of fire or electric shock
- 10 Never push any objects through slots in this unit This may result in the risk of fire or electric shock Never spill any liquid on the unit
- 11 To reduce the risk of electric shock, do not disassemble this unit Take the unit to an authorized servicer when service is required Opening or removing covers may expose you to dangerous voltages or other risks Incorrect reassembly can cause electric shock when the unit is subsequently used
- 12 Unplug this unit from the wall outlet and refer servicing to an authorized servicer when the following conditions occur
  - A When the power supply cord or plug is damaged or frayed
  - B If liquid has been spilled into the unit
  - C If the unit has been exposed to rain or water
  - D If the unit does not work normally by following the operating instructions Adjust only controls covered by the operating instructions Improper adjustment may require extensive work by an authorized servicer
  - E If the unit has been dropped or physically damaged
  - F If the unit exhibits a distinct change in performance
- 13 During thunderstorms, avoid using telephones except cordless types There may be a remote risk of an electric shock from lightning
- 14 Do not use this unit to report a gas leak, when in the vicinity of the leak

## SAVE THESE INSTRUCTIONS



---

**CAUTION:**

To reduce the risk of fire or injury to persons, read and follow these instructions.

1. Use only the battery(ies) specified.
2. Do not dispose of the battery(ies) in a fire. They may explode. Check with local waste management codes for special disposal instructions.
3. Do not open or mutilate the battery(ies). Released electrolyte is corrosive and may cause burns or injury to the eyes or skin. The electrolyte may be toxic if swallowed.
4. Exercise care in handling batteries in order not to short the battery to conductive materials such as rings, bracelets, and keys. The battery and/or conductor may overheat and cause burns.
5. Charge the battery(ies) provided with or identified for use with this product only in accordance with the instructions and limitations specified in this manual.

**WARNING:**

TO PREVENT FIRE OR SHOCK HAZARD, DO NOT EXPOSE THIS PRODUCT TO RAIN OR ANY TYPE OF MOISTURE.

- The AC adaptor is used as the main disconnect device, ensure that the AC outlet is located/installed near the unit and is easily accessible.

# FCC and Other Information

---

If requested by the telephone company, inform them as follows:

FCC Registration No. . . . . (found on the bottom of the unit)

Ringer Equivalence . . . . . 0.2B

The particular telephone lines to which the equipment is connected.

This unit must not be connected to a coin operated line.

If you are on a party line, check with your local telephone company.

## **Ringer Equivalence No. (REN):**

The REN is useful in determining the quantity of devices you may connect to your telephone line and still have all of those devices ring when your telephone number is called. In most, but not all areas, the sum of the REN's of all devices connected to one line should not exceed five (5.0). To be certain of the number of devices you may connect to your line, as determined by the REN, you should contact your local telephone company to determine the maximum REN for your calling area.

In the event terminal equipment causes harm to the telephone network, the telephone company should notify the customer, if possible, that service may be stopped.

However, where prior notice is impractical, the company may temporarily cease service providing that they:

- (a) Promptly notify the customer.
- (b) Give the customer an opportunity to correct the problem with their equipment.
- (c) Inform the customer of the right to bring a complaint to the Federal Communication Commission pursuant to procedures set out in FCC Rules and Regulations Subpart E of Part 68.

The Telephone Company may make changes in its communications facilities, equipment, operations or procedures, where such action is reasonably required in the operation of its business and is not inconsistent with the rules and regulations in FCC Part 68.

If such changes can be reasonably expected to render any customer terminal equipment incompatible with telephone company communications facilities, or require modification or alteration of such terminal equipment, or otherwise materially affect its use or performance, the customer shall be given adequate notice in writing, to allow the customer an opportunity to maintain uninterrupted service.

When programming emergency numbers and/or making test calls to emergency numbers:

1. Remain on the line and briefly explain to the dispatcher the reason for the call before hanging up.
2. Perform such activities in the off-peak hours, such as early morning hours or late evenings.

This device complies with Part 15 of the FCC Rules. Operation is subject to the following two conditions: (1) This device may not cause harmful interference, and (2) this device must accept any interference received, including interference that may cause undesired operation.

Privacy of communications may not be ensured when using this phone.

---

**CAUTION:**

Any changes or modifications not expressly approved by the party responsible for compliance could void the user's authority to operate this device.

**Note:**

This equipment has been tested and found to comply with the limits for a Class B digital device, pursuant to Part 15 of the FCC Rules. These limits are designed to provide reasonable protection against harmful interference in a residential installation. This equipment generates, uses, and can radiate radio frequency energy and, if not installed and used in accordance with the instructions, may cause harmful interference to radio communications. However, there is no guarantee that interference will not occur in a particular installation. If this equipment does cause harmful interference to radio or television reception, which can be determined by turning the equipment off and on, the user is encouraged to try to correct the interference by one or more of the following measures:

- Reorient or relocate the receiving antenna.
- Increase the separation between the equipment and receiver.
- Connect the equipment into an outlet on a circuit different from that to which the receiver is connected.
- Consult the dealer or an experienced radio/TV technician for help.

●**Environment**—do not place the unit in a room where the temperature is less than 5°C (41°F) or greater than 40°C (104°F). Allow 10 cm (4") clearance around the unit for proper ventilation. Avoid excessive smoke, dust, mechanical vibration, shock, or direct sunlight.

●**Routine care**—wipe the unit with a soft cloth. Do not use benzine, thinner, or any abrasive powder. When you leave the unit unused for a long period of time, unplug the AC adaptor from the outlet.

●**If there is any trouble**—disconnect the unit from the telephone line and connect a known working phone. If the known working phone operates properly, have your unit repaired by one of the authorized Panasonic Factory Service Centers. If the known working phone does not operate properly, consult your telephone company.

## For product service

- Call 1-800-211-PANA(7262) for the location of an authorized servicenter
- Panasonic's e-mail address for customer inquiries  
consumerproducts@panasonic.com  
for customers in the USA or Puerto Rico ONLY

## When you ship the product

- Carefully pack your unit, preferably in the original carton
- Attach a letter, detailing the symptom, to the outside of the carton

### Symptom

---

- Send the unit to an authorized servicenter, prepaid and adequately insured
- Do not send your unit to the Panasonic Consumer Electronics Company listed below or to executive or regional sales offices. These locations do not repair consumer products

- This cordless telephone is designed for use in the United States of America. Sale or use of this product in other countries may violate local laws.
- Ce téléphone sans fil est conçu pour être utilisé aux États-Unis d'Amérique. La vente ou l'emploi de cet appareil dans certains autres pays peut constituer une infraction à la législation locale.
- Este teléfono sin cordón fue elaborado para uso en los Estados Unidos de América. La venta o el empleo de este producto en ciertos países puede constituir violación de la legislación local.
- このコードレス電話機は、日本国外での使用を目的として設計されており、日本国内での使用は法律違反となります。従って、当社では日本国内においては原則として修理などのサービスは致しかねます。

**Panasonic Consumer Electronics Company,  
Division of Matsushita Electric Corporation of America**  
One Panasonic Way, Secaucus, New Jersey 07094

**Panasonic Sales Company,  
Division of Matsushita Electric of Puerto Rico, Inc.**  
Ave 65 de Infantería, Km 9.5, San Gabriel Industrial Park  
Carolina, Puerto Rico 00985