

# Panasonic

900MHz Cordless Answering System

Model No. **KX-TCM938-B**

Pulse-or-tone dialing capability

## Operating Instructions

Preparation

Cordless Telephone

Answering System

Useful Information



**PLEASE READ BEFORE USE AND SAVE.**

Charge the battery for about 15 hours before initial use.

# Before Initial Use

Please read IMPORTANT SAFETY INSTRUCTIONS on pages 52-53 before use. Read and understand all instructions.

*Thank you for purchasing the Panasonic cordless telephone.*





Attach your purchase receipt here.

## For your future reference

Serial No \_\_\_\_\_ Date of purchase \_\_\_\_\_  
(found on the bottom of the unit)

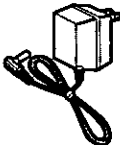
Name and address of dealer \_\_\_\_\_

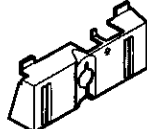
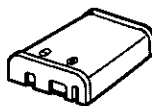
## Accessories

<input type="checkbox"/> AC Adaptor (p 11)  one	<input type="checkbox"/> Telephone Line Cord (p 11)  one	<input type="checkbox"/> Wall Mounting Adaptor (p 45)  one
<input type="checkbox"/> Battery (p 10)  one	<input type="checkbox"/> Handset Cover (p 10)  one	<input type="checkbox"/> Cradle Cover (p 10)  one

• To order accessories, call 1-800-332-5368

# For Best Performance

---

## Battery Charge

To power the handset, install the battery (p. 10) and charge it for about **15 hours** before initial use (p. 12).

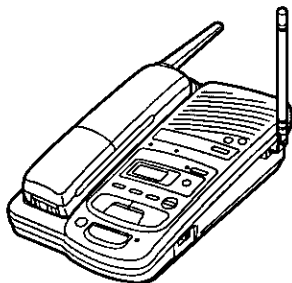

## Operating Distance/Noise

Calls are transmitted between the base unit and the handset using wireless radio waves. **For maximum distance and noise free operation**, the recommended base unit location is:

Away from electrical appliances such as a TV, radio, or personal computer.

In a **HIGH and CENTRAL** location with no obstructions such as walls.

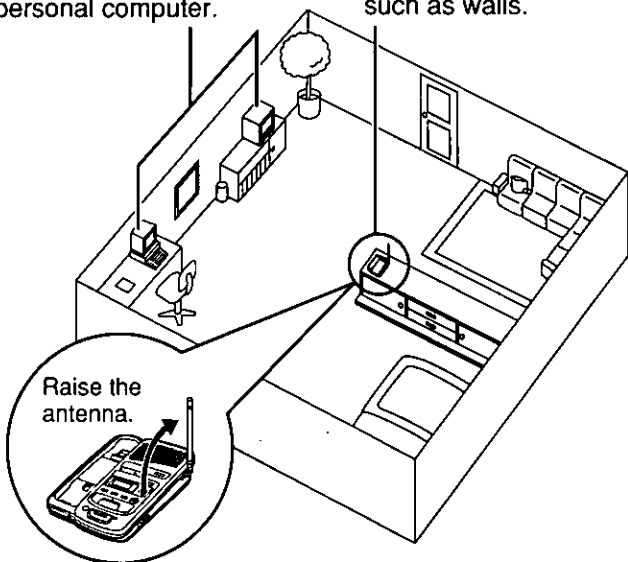

# Contents

---

## ***Preparation***

<b>Location of Controls</b> .....	6
<b>Setting Up</b> .....	10
Installing the Battery in the Handset .....	10
Installing the Cradle Cover on the Base Unit .....	10
Connection .....	11
<b>Battery Charge</b> .....	12
<b>Greeting Message</b> .....	13
<b>Programmable Preparations</b> .....	15
Time and Day Adjustment .....	16
Selecting the Caller's Recording Time .....	17
Selecting the Number of Rings .....	18
Setting the CPC (Calling Party Control) Function .....	19
Setting the Greeting Monitor Function .....	19

## ***Cordless Telephone***

<b>Making Calls</b> .....	20
<b>Answering Calls</b> .....	21
With the Handset .....	21
With the Base Unit (Digital Speakerphone) .....	22
<b>Automatic Dialing</b> .....	24
Storing Phone Numbers in Memory .....	24
Dialing a Stored Number .....	25
<b>Intercom</b> .....	26
Transferring a Call Using the Intercom .....	27
<b>Special Features</b> .....	28
For Call Waiting Service Users .....	28
Automatic Security Code Setting .....	28
Temporary Tone Dialing (For Rotary Service Users) .....	28
If Your Unit is Connected to a PBX .....	28

---

## ***Answering System***

<b>Automatic Answering Operation</b> .....	29
Setting the Unit to Answer Calls .....	29
<b>Listening to Messages</b> .....	30
<b>Erasing Messages</b> .....	31
<b>Pager Call</b> .....	32
Storing the Pager Number .....	32
Setting the Unit to Call the Pager .....	33
<b>Remote Operation from a Touch Tone Phone</b> .....	34
Setting the Remote Code .....	35
Voice Menu .....	36
Direct Remote Operation .....	38
<b>Remote Operation from the Handset</b> .....	40

## ***Useful Information***

<b>Wall Mounting</b> .....	45
<b>Optional Spare Battery</b> .....	46
<b>Before Requesting Help</b> .....	48
<b>Adding Another Phone</b> .....	51
<b>Important Safety Instructions</b> .....	52
<b>FCC and Other Information</b> .....	54

# Location of Controls

## Base unit

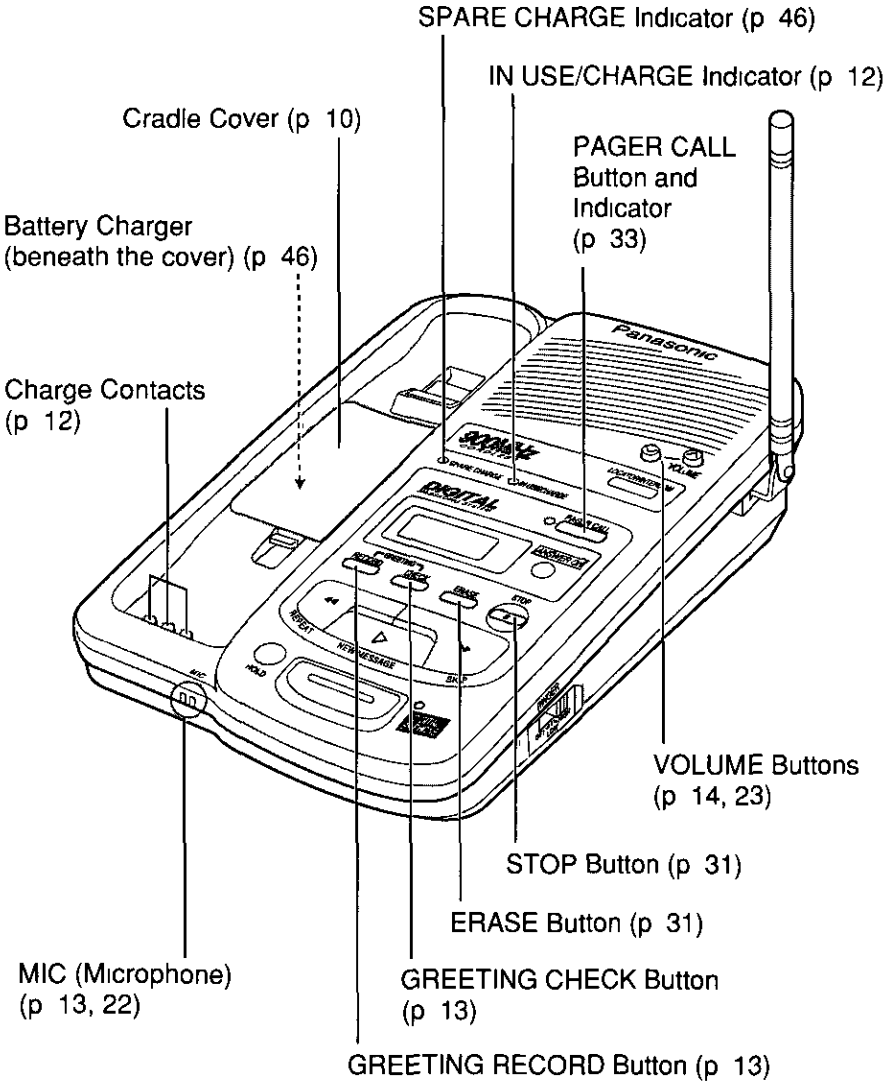

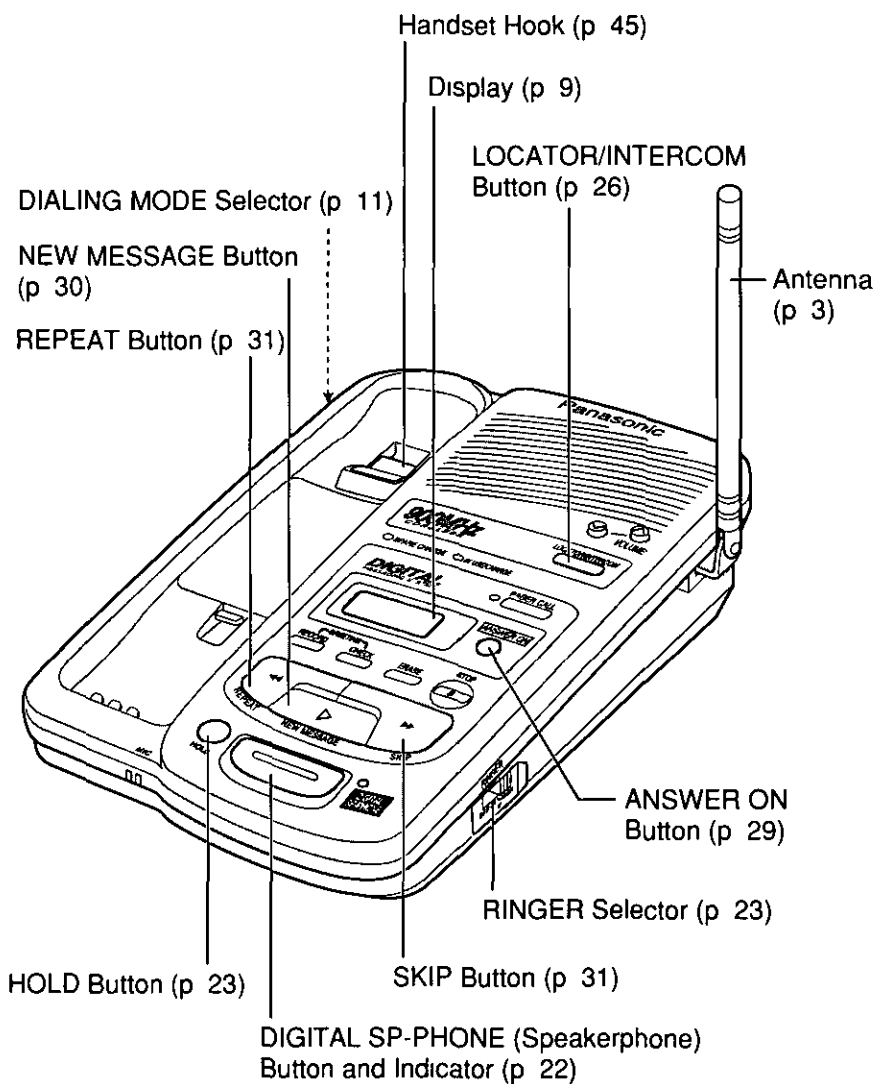

## ➔ Location of Controls

### Handset

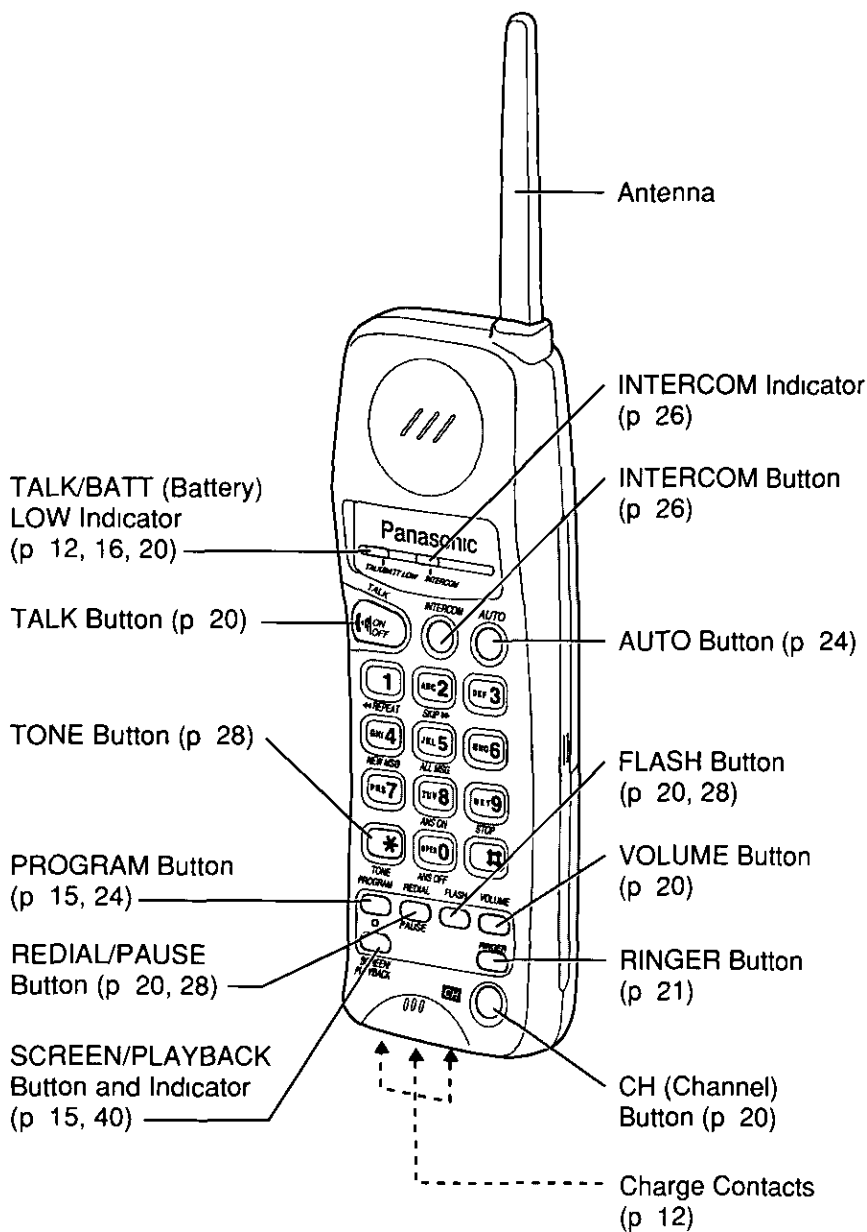



## Base unit display



The clock needs adjusting (p. 16).

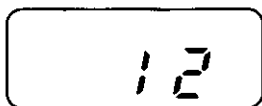

12 messages have been recorded.

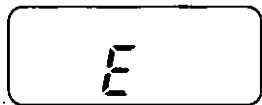

Your greeting message was not recorded correctly. Record it again (p. 13).

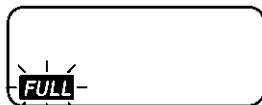

Memory is full. Erase some or all of the messages (p. 31).



The unit is in programming mode.

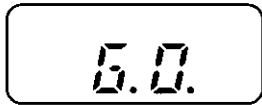

The recording time is set to "greeting only" (p. 17).

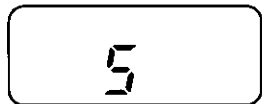

The speaker volume level is set to "5". You can select:

- 9 levels (0-8) while using the answering system.
- 8 levels (1-8) while using the speakerphone.

# Setting Up

---

## Installing the Battery in the Handset

Install the battery as shown observing the proper polarity.  
Then install the handset cover.

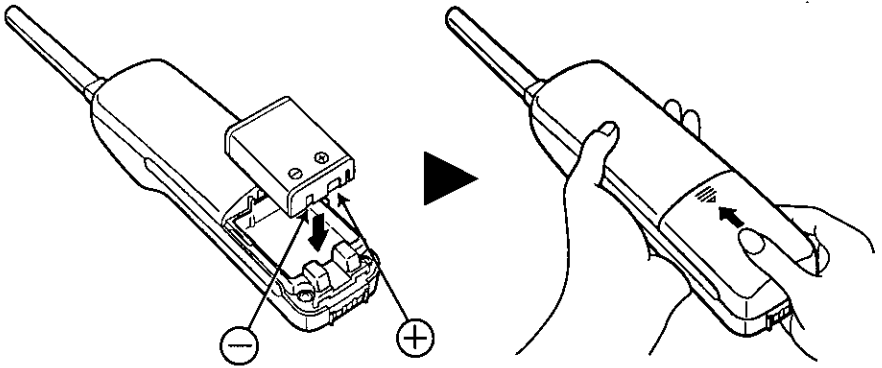

## Installing the Cradle Cover on the Base Unit

Close the cradle cover as shown.

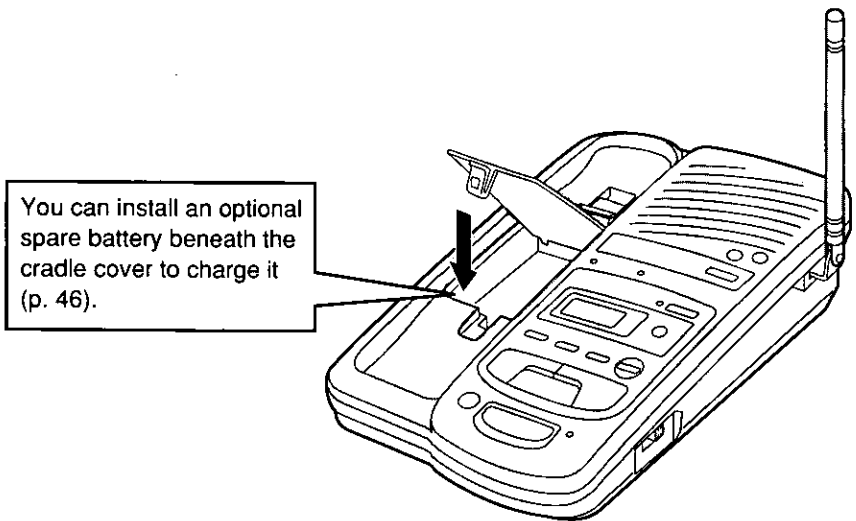

# Connection

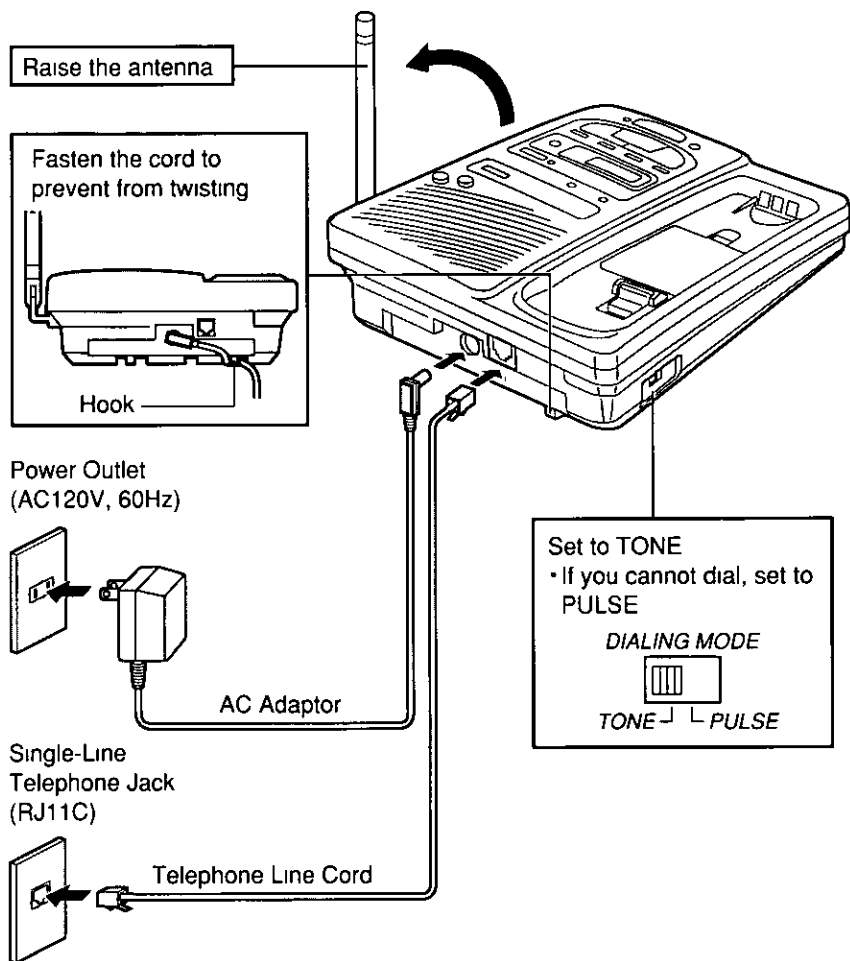

- USE ONLY Panasonic AC ADAPTOR KX-A11
- The AC adaptor must remain connected at all times (It may feel warm during use This is normal )
- If you connect a reserve telephone on the same line, see page 51

# Battery Charge

Place the handset on the base unit for about **15 hours**.

- The IN USE/CHARGE indicator lights.

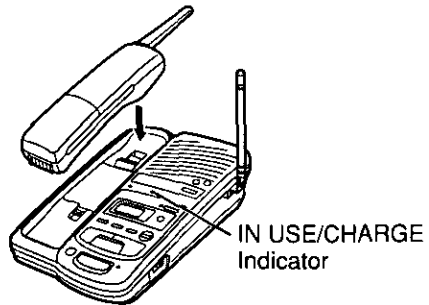

## Recharge

When the TALK/BATT LOW indicator flashes slowly or the unit beeps intermittently, recharge the battery.

If you do not want to wait until the battery is fully recharged, we recommend you purchase an optional spare battery (page 46).

TALK/BATT LOW Indicator

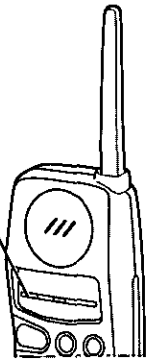

## Standard battery life

If your Panasonic battery is fully charged;

While in use (TALK)	Up to about 4.5 hours
While not in use (Stand-By)	Up to about 14 days

- Battery life may vary depending on usage conditions and ambient temperature.
- **Clean the handset and the base unit charge contacts with a soft dry cloth once a month**, or the battery may not charge properly.
- Once the battery is fully charged, you do not have to place the handset on the base unit until the TALK/BATT LOW indicator flashes slowly.
- The battery cannot be overcharged.

# Greeting Message



You can prepare a personal greeting message. If you do not, one of two pre-recorded greetings will be played when a call is received (p. 14).

Your greeting and the callers' messages are stored in digital memory (p. 30). The **total recording time is about 14 minutes**. We recommend you record a **brief greeting message** leaving more time in memory.

## To record a greeting message

- 1 Press **GREETING RECORD** to start the recording mode.
  - "Press RECORD again to record greeting" is heard.
- 2 Within 5 seconds, press **GREETING RECORD** again to record your greeting.
  - A long beep sounds.
- 3 After the long beep, speak clearly about 20 cm (8") away from the **MIC** (microphone).
  - The display shows the elapsed recording time.
- 4 When finished, press **STOP**.
  - **To check** the recorded greeting, press **GREETING CHECK**.
  - To change the message, repeat from step 1.

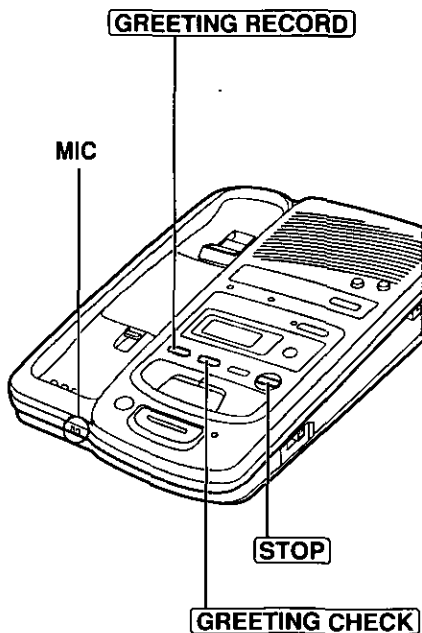

## Sample of greeting message

"Hello, this is (your name and/or number). Sorry, I cannot take your call. Please leave a message after the long beep. Thank you."

## ➔ Greeting Message

---

### To erase the recorded greeting message

Press **GREETING CHECK** ➔ press **ERASE** while the message is played.

- The unit will answer a call with the pre-recorded greeting.

### Pre-recorded greeting message

If you do not record a personal greeting message (p. 13), one of the following two messages will be played when a call is received. Which message will be played depends on the caller's recording time (p. 17).

To check the pre-recorded greeting, press **GREETING CHECK**.

- The pre-recorded greeting is played as below.
  - When the recording time is set to "1 minute" or "unlimited";  
"Hello, we are not available now. Please leave your name and phone number after the beep. We will return your call."
  - When the recording time is set to "greeting only";  
"Hello, we are not available now. Please call again. Thank you for your call."

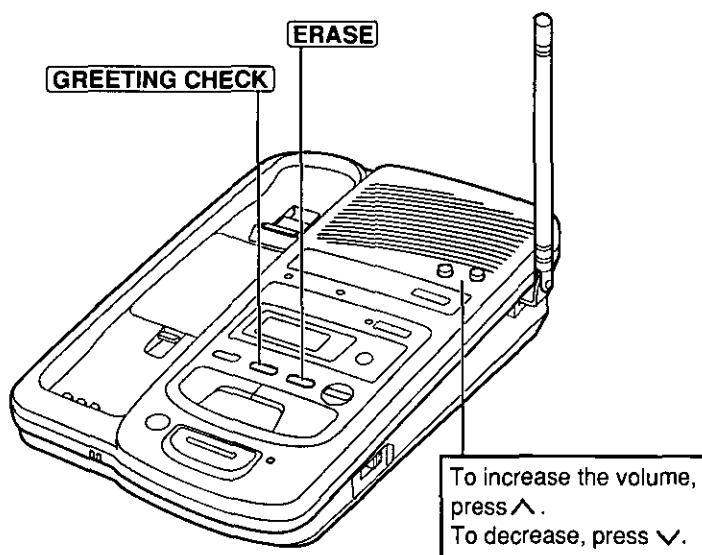

# Programmable Preparations



You can program the following functions by using the handset near the base unit. See the bracketed pages for detailed procedures.

Be sure that the TALK/BATT LOW and/or DIGITAL SP-PHONE indicator light is off.

Lift the handset, then press **PROGRAM**.



Press **SCREEN/PLAYBACK**.



• If an alarm tone sounds, move toward the base unit, then try again.

- To adjust the time and day, press "0". (page 16)
- To set the remote code, press "1". (page 35)
- To select the number of rings, press "2". (page 18)
- To set the CPC function, press "3". (page 19)
- To set the greeting monitor function, press "4". (page 19)
- To select the caller's recording time, press "5". (page 17)
- To set the pager number, press "#". (page 32)



When finished, press **PROGRAM**.  
A confirmation tone sounds.\*

- To cancel programming, press **PROGRAM**, then restart from the beginning.
- If 6 beeps sound during programming, it means you have pressed an invalid key. Enter the correct number again.

## \*What the confirmation tone means

- 1 beep: The new programmed number is stored.
- 2 beeps: The number is the same as a previously stored one.
- 6 beeps: The number is not correct. Try again from the beginning.

## ➔ Programmable Preparations

### Time and Day Adjustment

**Voice Time/Day Stamp:** During playback a synthesized voice will announce the time and day when each message was recorded.

- 1 Press **PROGRAM**.
  - The TALK/BATT LOW indicator flashes.
- 2 Press **SCREEN/PLAYBACK**.
  - The indicator lights.
  - "P" is displayed on the base unit to show the unit is in programming mode.
- 3 Press **0**.
  - "⓪" is displayed and the current time/day is heard.
- 4 Enter the current time (hour and minute) by using a 4-digit number. (Ex. To set "9:30", enter "0930".)
  - The entered number is displayed.
- 5 Press **ⓧ** to select "AM" or "PM".  
Press **#** repeatedly to set the day.
- 6 When finished, press **PROGRAM**.
  - The unit announces the time/day.  
The clock starts working.

TALK/  
BATT LOW Indicator



- In step 4, you cannot enter numbers greater than 12. (To set "13:00", enter "0100" and select "PM" by pressing **ⓧ**.)
- The accuracy of the clock is approximately  $\pm 45$  seconds a month at room temperature.



## To check the time/day

Press **PROGRAM** → **SCREEN/PLAYBACK** → **0**.

- The current time/day is heard. When finished, press **PROGRAM**.

## Selecting the Caller's Recording Time

You may select the caller's recording time as either "1 minute", "unlimited" or "greeting only". The factory preset is "unlimited".

- 1 Press **PROGRAM**.
  - The TALK/BATT LOW indicator flashes.
- 2 Press **SCREEN/PLAYBACK**.
  - The indicator lights.
  - "P" is displayed on the base unit.
- 3 Press **5**.
  - The current setting is displayed.
    - 1: 1 minute
    - 2: unlimited
    - 3: greeting only
- 4 Press **1**, **2** or **3** to select the recording time.
  - The setting is displayed.
- 5 When finished, press **PROGRAM**.
  - The indicator lights go out.

TALK/  
BATT LOW Indicator

**PROGRAM**

**SCREEN/PLAYBACK**  
and Indicator

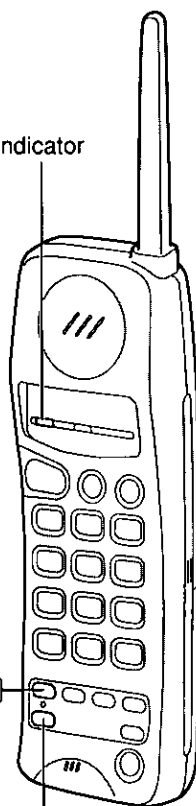

- If you select "greeting only", the unit answers a call with the greeting message, then hangs up. The unit will not record any messages.

## ➔ Programmable Preparations

### Selecting the Number of Rings

You may select the number of rings before the answering system answers a call, from "1" to "7" or "AUTO (for Toll Saver)". The factory preset is "AUTO".

- 1 Press **PROGRAM**.
  - The TALK/BATT LOW indicator flashes.
- 2 Press **SCREEN/PLAYBACK**.
  - The indicator lights.
  - "P" is displayed on the base unit.
- 3 Press **2**.
  - The current setting is displayed.
- 4 Press a dialing button **0** to **7** to set the number of rings.
  - 0**: Selects "AUTO". "A" is displayed.
  - 1-7**: The unit will answer on the selected number of rings.
- 5 When finished, press **PROGRAM**.
  - The indicator lights go out.

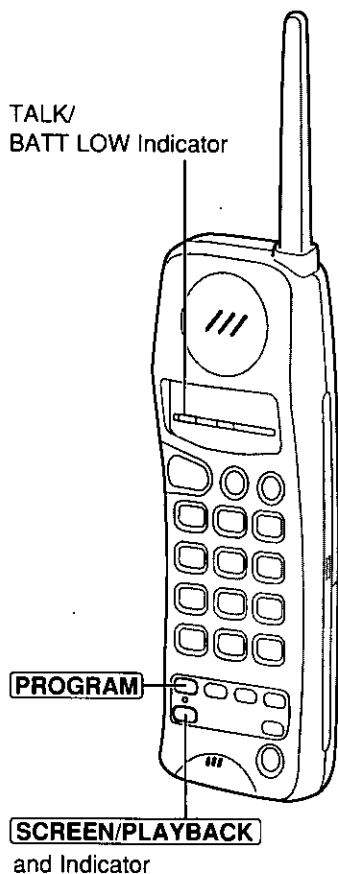

#### Toll Saver (When set to "AUTO")

When you call the unit from a touch tone telephone:

If the unit answers on the 2nd ring; there is at least one new message.

If the unit answers on the 4th ring; there are no new messages.

**Hang up when you hear the 3rd ring.** This will save you the toll charge for the call.

## Setting the CPC (Calling Party Control) Function

The CPC function is preset to "A". If you use a call waiting service, set to "b", or the call waiting tone will disconnect someone leaving a message.

1. Press **PROGRAM**.
2. Press **SCREEN/PLAYBACK**.
3. Press **3**.
  - The current setting "A" or "b" is displayed on the base unit.
4. To select "b", press **2**.  
OR  
To select "A", press **1**.
  - The setting is displayed.
5. When finished, press **PROGRAM**.

## Setting the Greeting Monitor Function

When your greeting message is being played to the caller, you can also listen to it through the speaker. To listen to your greeting, set to "2 (ON)". The factory preset is "1 (OFF)".

1. Press **PROGRAM**.
2. Press **SCREEN/PLAYBACK**.
3. Press **4**.
  - The current setting "1" or "2" is displayed on the base unit.
4. To set to "2 (ON)", press **2**.  
OR  
To set to "1 (OFF)", press **1**.
  - The setting is displayed.
5. When finished, press **PROGRAM**.

# Making Calls

- 1 Press **TALK**.
  - The TALK/BATT LOW indicator lights.
- 2 Dial a telephone number.
  - If you misdial, press **FLASH** firmly then dial again.
- 3 To hang up, press **TALK** or place the handset on the base unit.
  - The indicator light goes out.

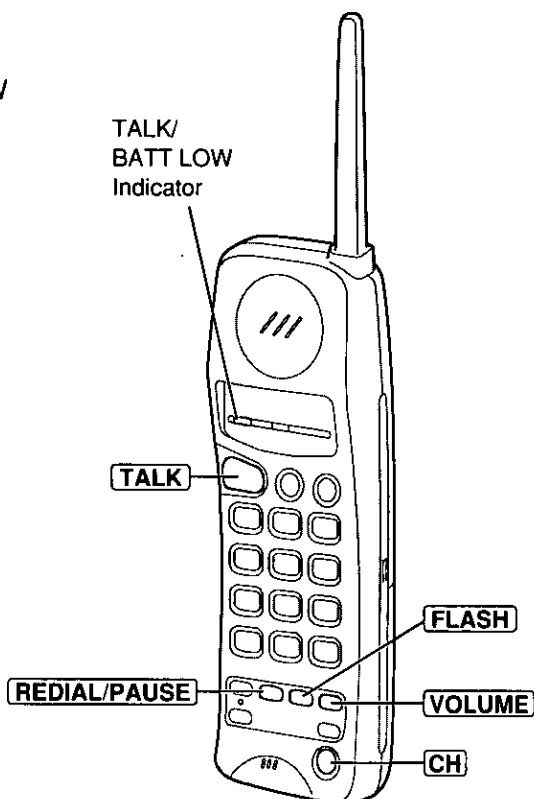

- If an alarm tone sounds in step 1, move toward the base unit or place the handset on the base unit. Then try again.

## To redial the last number

Press **TALK** ⇒ **REDIAL/PAUSE**.

## To select the receiver volume HIGH or NORMAL (preset)

Press **VOLUME** while talking.

- Each time you press, the volume level will change.

## If noise interferes with the conversation

Press **CH** to select a clear channel or move closer to the base unit.

# Answering Calls



## With the Handset

If the handset is off the base unit, press **TALK**.

- You can also answer a call by pressing any dialing button 0 to 9, \*, or # (— **Any Key Talk**).

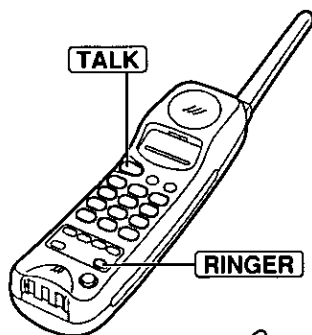

## OR

If on the base unit, just lift it.

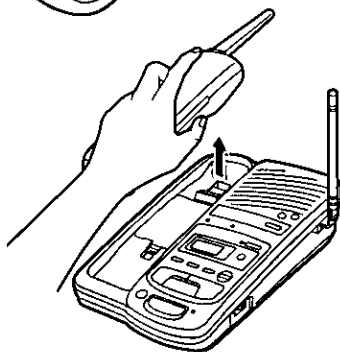

## Adjusting the ringer volume

Be sure the TALK/BATT LOW indicator light is off.

- To select **HIGH (preset) or LOW**, press **RINGER**.  
(Each time you press, the ringer volume will change.)
- To turn the ringer **OFF**, while pressing **RINGER**, press **0** until 2 beeps sound.
- To turn the ringer **ON**, press **RINGER**. The ringer sounds at the **HIGH** level.

## ➔ Answering Calls

### With the Base Unit (Digital Speakerphone)

1 Press **DIGITAL SP-PHONE**

- The indicator lights

2 Speak into the **MIC**  
(microphone)

3 To hang up, press  
**DIGITAL SP-PHONE**

- The indicator light goes out

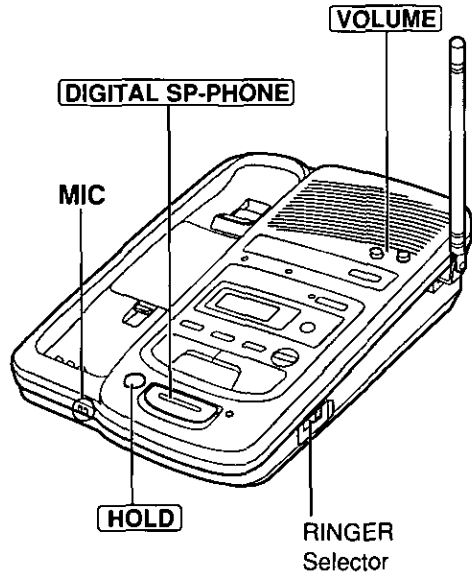

- While using the speakerphone, if the handset is on the base unit, you may switch to the handset by lifting it up
- The DIGITAL SP-PHONE button is designed only for answering calls. If you press it to make a call, a dial tone may not be heard. This is normal.

#### Hands-Free Digital Speakerphone

The digital speakerphone enhances your telephone conversation. For best performance, please note the following:

- Use the speakerphone in a quiet room
- Speak alternately with the caller
- If the caller complains that your voice is hard to hear, press **∨** to decrease the speaker volume

---

## To adjust the speaker volume (8 levels)

To increase, press  $\wedge$  To decrease, press  $\vee$

## To put a call on hold

Press **HOLD**

- The DIGITAL SP-PHONE indicator flashes
- If you put a call on hold for 6 minutes, a warning tone will sound  
The call will be disconnected after a total of 10 minutes

## To release the hold

Press **DIGITAL SP-PHONE** or lift the handset off the base unit

- If another phone is connected on the same line, you can also release the hold by lifting its handset

## To select the ringer volume

Set the RINGER selector to HIGH, LOW, or OFF

- When set to OFF, the base unit will not ring

# Automatic Dialing

## Storing Phone Numbers in Memory

You can store up to 10 phone numbers in the handset. The dialing buttons (0 to 9) function as memory stations. The TALK/BATT LOW indicator light must be off.

- 1 Press **PROGRAM**.
  - The TALK/BATT LOW indicator flashes.
- 2 Enter a phone number up to 16 digits.
  - If you misdial, press **PROGRAM** to end storing, then restart from step 1.
- 3 Press **AUTO**.
- 4 Press a memory station number (0 to 9).
  - A confirmation tone sounds. (See below.)
  - To store other numbers, repeat steps 1 through 4.

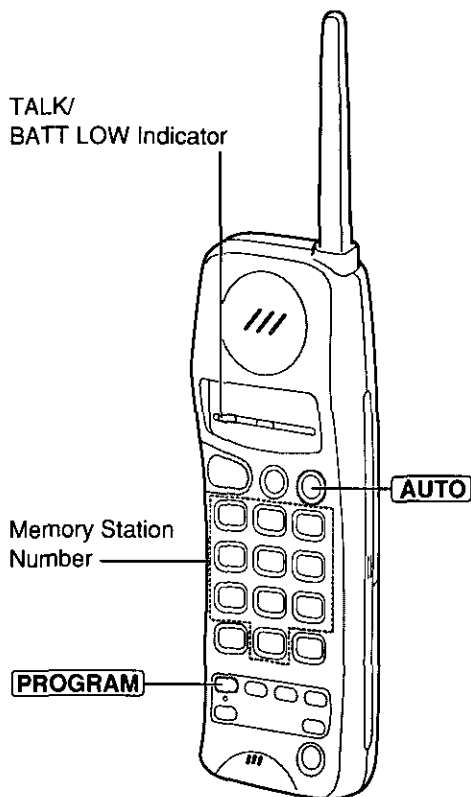

### What the confirmation tone means

- 1 beep: The new number is stored.
- 2 beeps: The number is the same as a previously stored one.



## To erase a stored number

Press **PROGRAM** ⇒ **AUTO** ⇒ the memory station number (for the phone number to be erased).

## Memory sticker

Use the included memory sticker as a name or phone number index for automatic dialing. Attach the sticker to the unit or in a convenient place.

10-STATION AUTOMATIC DIALER	
1	6
2	7
3	8
4	9
5	0
TEL NO.	

## Dialing a Stored Number

- 1 Press **TALK**.
- 2 Press **AUTO**.
- 3 Press the memory station number (0 to 9).
  - The stored number is dialed.

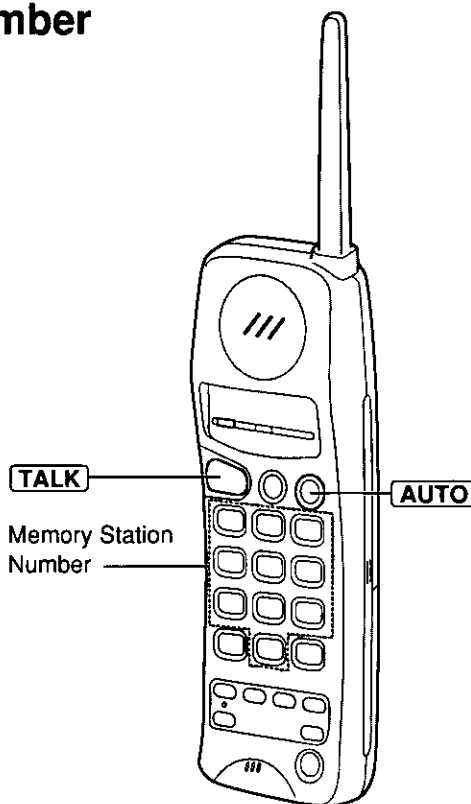

# Intercom

A 2-way intercom is available between the handset and the base unit.

## Paging the base unit from the handset

- 1 Handset:  
Press **INTERCOM**,  
then talk.
  - The indicator lights.
- 2 Base unit:  
When the other party's voice  
is heard, answer through the  
**MIC**.
- 3 Handset:  
To end the intercom, press  
**INTERCOM**.

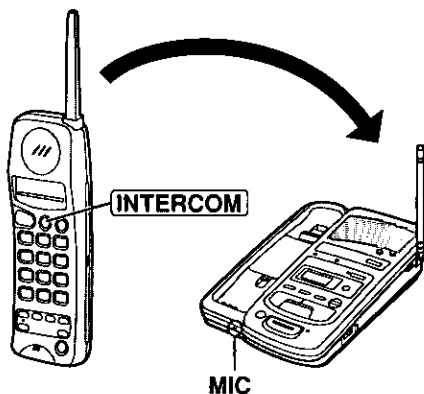

## Paging the handset from the base unit (Handset locator)

Using this feature, you can locate the handset if misplaced.

- 1 Base unit:  
Press  
**LOCATOR/INTERCOM**.
  - The handset beeps for  
1 minute.
  - To stop paging, press  
**LOCATOR/INTERCOM**  
again.
- 2 Handset:  
Press **INTERCOM** to  
answer.
- 3 Base unit:  
Speak into the **MIC**.
- 4 Handset:  
To end the intercom,  
press **INTERCOM**.

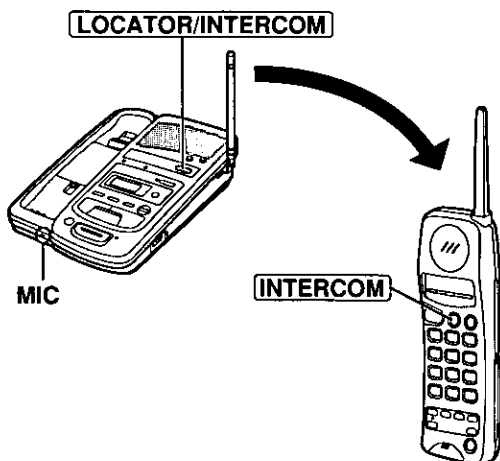

**During the intercom:**

- Intercom calls can only be ended by the handset.
- If the handset user has difficulty hearing the base unit user, decrease the speaker volume by pressing **∇**.
- If two tones sound, an incoming call has been received. To answer, press **TALK** or **DIGITAL SP-PHONE**. The intercom is ended.

## Transferring a Call Using the Intercom

The intercom can be used during a call. This feature enables you to transfer the call between the handset and the base unit.

### From the handset to the base unit

- 1 Handset:**  
During a call, press **INTERCOM** then talk.
  - The call is put on hold.
- 2 Base unit:**  
When the paging party's voice is heard, answer through the **MIC**.
- 3 Base unit:**  
To answer the call, press **DIGITAL SP-PHONE**.
  - The transfer is completed.
  - The handset user can join the conversation by pressing **TALK**.

### From the base unit to the handset

- 1 Base unit:**  
During a call, press **LOCATOR/INTERCOM**.
  - The call is put on hold.
- 2 Handset:**  
Press **INTERCOM** to answer the page.
- 3 Handset:**  
To answer the call, press **TALK**.
  - The transfer is completed.
  - The base unit user can join the conversation by pressing **DIGITAL SP-PHONE**.

# Special Features

---

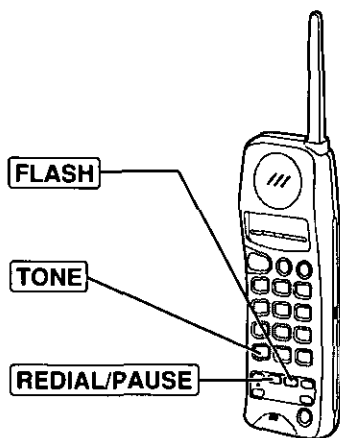

## For Call Waiting Service Users

Press **FLASH** lightly if you hear a call-waiting tone while talking.

- The first call is put on hold and you can answer the second call.
- To return to the first caller, press **FLASH** again.

## Automatic Security Code Setting

Whenever you place the handset on the base unit, the unit automatically selects one of a million security codes. These codes help to avoid unauthorized use of your telephone line by another cordless telephone.

## Temporary Tone Dialing (For Rotary Service Users)

Press **TONE** before entering access numbers which require tone dialing.

- The dialing mode changes to tone. You can enter numbers to access answering systems, electronic banking services, etc. When you hang up, the mode returns to pulse.

## If Your Unit is Connected to a PBX

We recommend you press **REDIAL/PAUSE** between the access number for an outside line and the phone number.

- Pressing **REDIAL/PAUSE** once creates a 3.5 second pause. This prevents misdialing when you redial or dial a stored number. (**REDIAL/PAUSE** counts as one digit.)

# Automatic Answering Operation

When a call is received, the unit plays back your greeting message and records the caller's message.

- The total recording time (including the greeting message) is **about 14 minutes**. If messages are recorded in noisy rooms, the time may be shortened up to 5 minutes.
- A maximum of 64 messages can be recorded.

## Setting the Unit to Answer Calls

Press **ANSWER ON** to turn on the answering system.

- The button lights.
- The unit will announce the remaining recording time if the time is less than 5 minutes. If you hear "Memory full", erase some or all of the messages (p. 31).

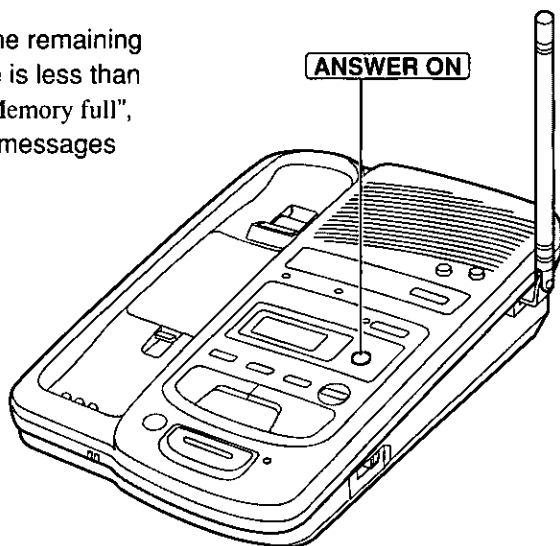

- If you do not want the unit to answer calls, press **ANSWER ON** to turn the answering system off. The button's light goes out.
- You can turn on the answering system by using a touch tone phone (p. 39).

## Monitoring incoming calls

While a call is being recorded, you can monitor it through the speaker. To answer the call, press **DIGITAL SP-PHONE** or **TALK**. The unit stops recording. (To use this feature with the handset, see page 42.)

# Listening to Messages

You can see the total number of recorded messages on the display. When new incoming messages have been recorded, the ANSWER ON button's light flashes while the answering system is on.

## Listening to new messages only

Press **NEW MESSAGE** lightly.

- The unit announces the number of new messages and plays them back.

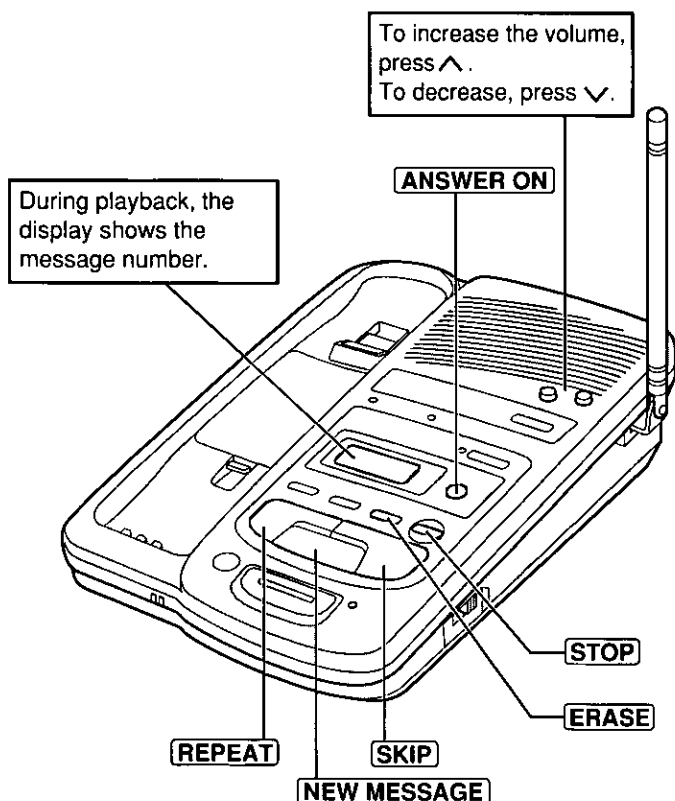

## Flash Memory Message Backup

Messages can be stored on a "flash memory" IC chip for long term storage — even in the event of a power failure. All of the messages are saved until you erase them.

---

## Listening to all of the recorded messages

Press **[NEW MESSAGE]** firmly until the playback starts.

### During playback

To <b>repeat</b> the message	Press <b>[REPEAT]</b> during playback. (If you press within 5 seconds of playback, the previous message is played.)
To <b>skip</b> the message	Press <b>[SKIP]</b> during playback. The next message is played.
To <b>stop</b> the operation	Press <b>[STOP]</b> .

---

## Erasing Messages

---

The unit will announce the remaining recording time after playback if the time is less than 5 minutes. If you hear "Memory full", new messages cannot be recorded. Erase some or all of the messages. We recommend you erase unnecessary messages after each playback.

### Erasing a specific message

Press **[ERASE]** while the message you want to erase is being played.

- The unit erases the message.
- A series of beeps will sound and the unit continues to play the next message.

### Erasing all of the messages

All of the recorded messages except the greeting message can be erased at one time.

- 1 Press **[ERASE]**.
  - "Press ERASE again to erase all messages" is heard.
- 2 Within 5 seconds, press **[ERASE]** again.
  - A series of beeps and "No message" are heard. The display shows "0".

# Pager Call

This feature allows you to alert your pager when the unit records an incoming message. You can retrieve the message from a touch tone telephone (p. 34). First store the pager number, then turn on the pager call mode.

## Storing the Pager Number

The TALK/BATT LOW and/or DIGITAL SP-PHONE indicator light must be off.

- 1 Press **PROGRAM**.
  - The TALK/BATT LOW indicator flashes.
- 2 Press **SCREEN/PLAYBACK**.
  - The indicator lights.
- 3 Press **#**.
- 4 Enter your pager number up to 46 digits.
  - If necessary, press **REDIAL/PAUSE** twice.\*
  - If you misdial, press **PROGRAM** then restart from step 1.
- 5 Enter the call back number you want to display on your pager. (Press # if required by your pager company.)
- 6 When finished, press **PROGRAM**.
  - The indicator lights go out.

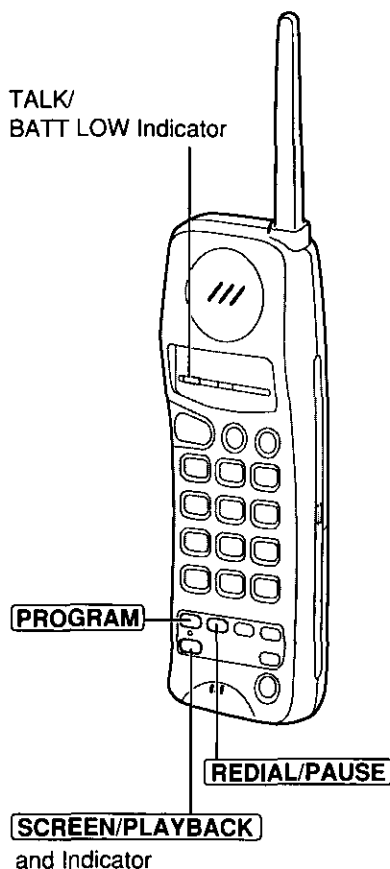

\* Your pager company may require a delay after the pager number is dialed. Contact your pager company regarding the required pause time. Pressing **REDIAL/PAUSE** once creates a 3.5 second delay.



## To confirm the stored number

Press **TALK** ⇒ **AUTO** ⇒ **#**.

- The unit dials the stored number.
- If the pager does not beep, restart from step 1 to store the correct number.

## To erase the stored number

Press **PROGRAM** ⇒ **SCREEN/PLAYBACK** ⇒ **#** ⇒ **PROGRAM**.

## Setting the Unit to Call the Pager

Press **PAGER CALL** to turn on the pager call mode.

- The indicator lights.
- If 6 beeps sound, the pager number is not stored. Store the number, then try again.

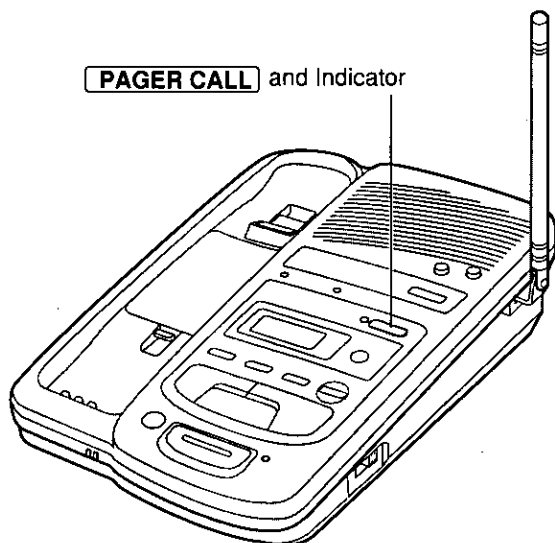

## To turn off the pager call mode

Press **PAGER CALL** again.

- The indicator light goes out.

# Remote Operation from a Touch Tone Phone

You can operate the answering system from any touch tone phone. The synthesized voice menu will guide you on how to operate the unit (p. 36).

- To skip the voice menu and directly operate the unit, see page 38.

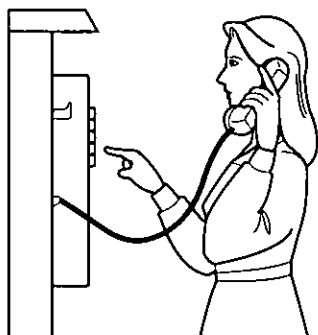

## Summary of remote operation

Call your unit from a touch tone phone.



Enter your remote code (p. 35) during the greeting message playback.



After 3 seconds, the voice menu starts (p. 36).  
Follow the menu or enter the direct remote commands (p. 38).



To end the remote operation, hang up.  
• The messages are saved.



## Setting the Remote Code

The remote code prevents unauthorized persons from accessing your unit and listening to your messages. Choose any **2-digit number (00-99)**.

The factory preset is "11".

**1** Make sure the TALK/BATT LOW indicator light is off, then press **PROGRAM**.

- The TALK/BATT LOW indicator flashes.

**2** Press **SCREEN/PLAYBACK**.

- The indicator lights.
- "P" is displayed on the base unit to show the unit is in programming mode.

**3** Press **1**.

- The current remote code is displayed.

**4** Enter a remote code by using a **2-digit number**.

- The entered number is displayed.

**5** When finished, press **PROGRAM**.

- The indicator lights go out.

- If 6 beeps sound in step 5, it means you entered an one digit number. Restart from step 1 to set a 2-digit number.

### To check the remote code

Press **PROGRAM** ⇒ **SCREEN/PLAYBACK** ⇒ **1**. ⇒ The current remote code is displayed. ⇒ When finished, press **PROGRAM**.

TALK/  
BATT LOW Indicator

**PROGRAM**

**SCREEN/PLAYBACK**  
and Indicator

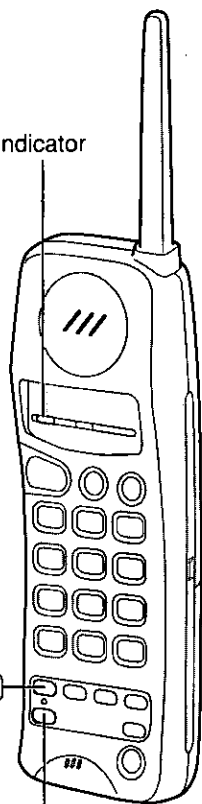

## ➔ Remote Operation from a Touch Tone Phone

---

### Voice Menu

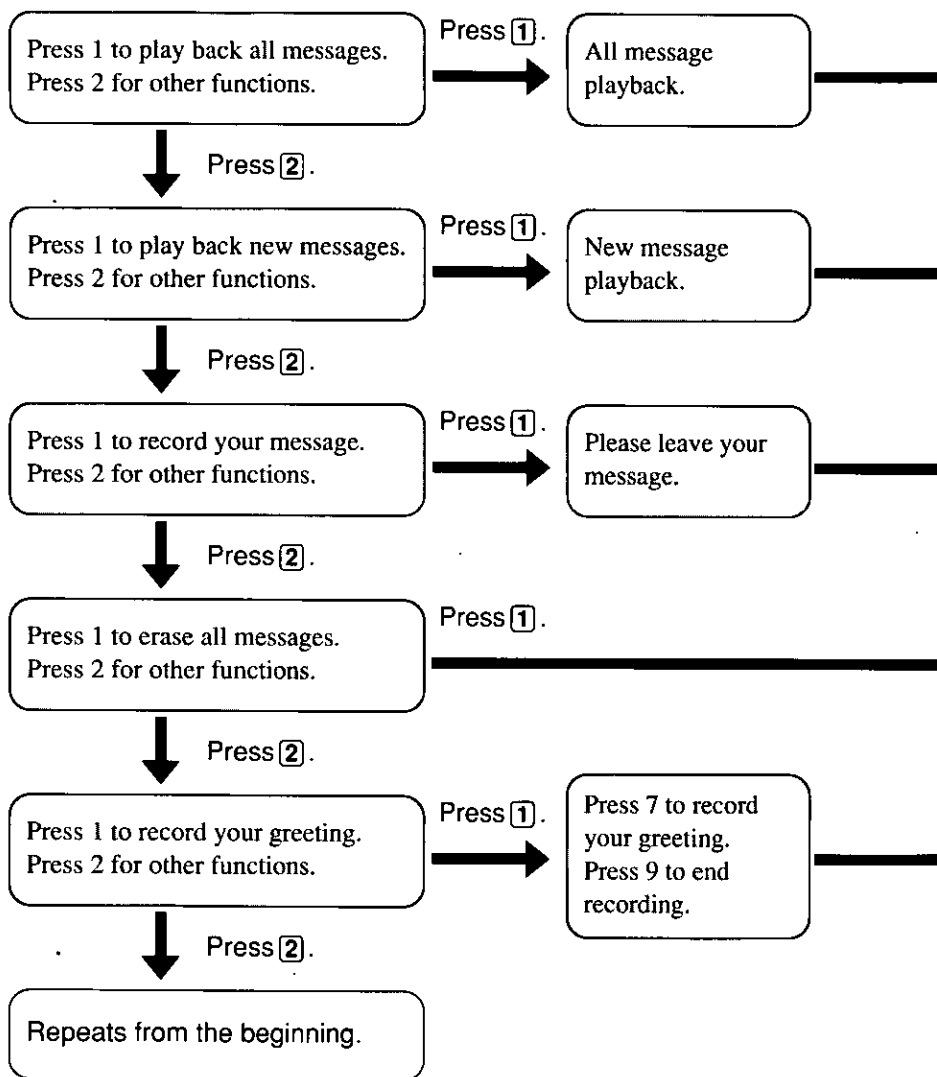



### All Message Playback

The unit plays back all of the recorded messages. At the end of the last message, "End of final message" and the remaining recording time are announced.



### New Message Playback

The unit plays back messages which have not been played.



### Recording a Memo Message

You can leave a personal message.

1. Speak after you hear "Please leave your message".
2. When you finish recording, hang up.



### Erase All Messages

All of the recorded messages (except the greeting message) are erased.



### Recording a Greeting Message

You can re-record your greeting message.

1. Press **7**.  
You hear a voice instruction, followed by a long beep.
2. Speak after the long beep.
3. When you finish recording, press **9**.
4. Your greeting will be played back for review.

- 3 seconds after playback, the voice menu will repeat from the beginning.
- If you hear "Memory full" after playback, erase some or all of the messages (p. 38).

## ➔ Remote Operation from a Touch Tone Phone

---

### Direct Remote Operation

Once you have entered the remote code, you can also control your unit by direct remote commands instead of using the voice menu. To end the remote operation, hang up anytime.

#### Direct commands

NEW MESSAGE PLAYBACK	<b>4</b>	<ul style="list-style-type: none"><li>• Only new messages are played back.</li></ul>
ALL MESSAGE PLAYBACK	<b>5</b>	<ul style="list-style-type: none"><li>• All of the messages are played back.</li></ul>
REPEAT (During playback)	<b>1</b>	<ul style="list-style-type: none"><li>• The current message is repeated.</li></ul>
SKIP (During playback)	<b>2</b>	<ul style="list-style-type: none"><li>• The current message is skipped. The next message is played.</li></ul>
STOP (During playback)	<b>9</b>	<ul style="list-style-type: none"><li>• Playback is stopped temporarily.</li><li>• To resume playback, press <b>9</b> again within 15 seconds. Or the voice menu will start.</li></ul>
GREETING MESSAGE RECORDING	<b>7</b> ↓ RECORD ↓ <b>9</b>	<ul style="list-style-type: none"><li>• A long beep sounds.</li><li>• Speak immediately after the long beep.</li><li>• Recording is stopped.</li><li>• The recorded message is played.</li></ul>
ERASE SPECIFIC MESSAGE (During playback)	<b>* 4</b>	<ul style="list-style-type: none"><li>• The current message is erased.</li><li>• A series of beeps will sound and the next message is played.</li></ul>
ERASE ALL MESSAGE	<b>* 5</b>	<ul style="list-style-type: none"><li>• All of the recorded messages are erased.</li><li>• A series of beeps and "No message" are heard.</li></ul>

---

PAGER CALL ON

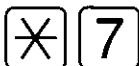

- A beep sounds and the mode turns on
- If you did not store a pager number, 6 beeps sound and a mode does not turn on

---

PAGER CALL OFF

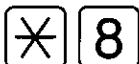

- The pager call mode is turned off

---

ANSWERING  
SYSTEM OFF



- The unit hangs up and will not answer calls until turned on again
- 

## Turning on the answering system

Call your unit and wait for 15 rings

- The unit will answer and the greeting message is played
- Hang up or enter the remote code for other options

## Skipping the greeting message (For outside callers)

After calling your unit, press during the greeting message playback

- The unit skips the rest of the greeting and callers can start recording their message after a long beep

# Remote Operation from the Handset

You can operate your answering system from the handset.

**SCREEN/PLAYBACK**  
and Indicator

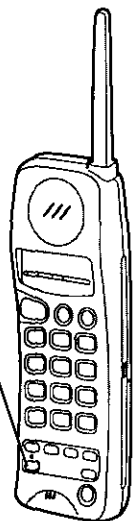

## Summary of remote operation

Press **SCREEN/PLAYBACK**.

- The indicator lights.
- The number of recorded messages is heard.

- ↓
- If the SCREEN/PLAYBACK indicator flashes, the answering system is off. To turn on, press **8**.

Press the desired command buttons (see the following pages).\*

- If you do not press any button, all message playback will start.

↓

To end the remote operation, press **SCREEN/PLAYBACK**.

- The messages are saved.

- If you hear "Memory full" after playback, erase some or all of the messages (p. 41).
- When an incoming message has been recorded, 4 short beeps sound twice on the handset.





## \*Voice menu

If no command is given after you press **SCREEN/PLAYBACK**, the unit starts the following voice menu

"Press 4 to playback new messages, Press 5 to play back all messages "

- Even if the voice menu has started, command buttons can be entered

## Direct Commands

NEW MESSAGE PLAYBACK	<b>4</b>	<ul style="list-style-type: none"><li>• Only new messages are played back</li></ul>
ALL MESSAGE PLAYBACK	<b>5</b>	<ul style="list-style-type: none"><li>• All of the messages are played back</li></ul>
REPEAT (During playback)	<b>1</b>	<ul style="list-style-type: none"><li>• The current message is repeated</li></ul>
SKIP (During playback)	<b>2</b>	<ul style="list-style-type: none"><li>• The current message is skipped The next message is played</li></ul>
STOP (During playback)	<b>9</b>	<ul style="list-style-type: none"><li>• Playback is stopped temporarily</li><li>• To resume playback, press <b>9</b> again within 15 seconds Or the voice menu will start</li></ul>
ERASE SPECIFIC MESSAGE (During playback)	<b>* 4</b>	<ul style="list-style-type: none"><li>• The current message is erased</li><li>• A series of beeps will sound and the next message is played</li></ul>
ERASE ALL MESSAGE	<b>* 5</b>	<ul style="list-style-type: none"><li>• All of the recorded messages are erased</li><li>• A series of beeps and "No message" are heard</li></ul>



(continued ➡ )

## ➔ Remote Operation from the Handset

---

### Direct Commands (continued)

---

PAGER CALL ON   • A beep sounds and the mode turns on  
• If you did not store a pager number, 6 beeps sound and the mode does not turn on

---

PAGER CALL OFF   • The pager call mode is turned off

---

ANSWERING SYSTEM OFF  • The SCREEN/PLAYBACK indicator flashes

---

ANSWERING SYSTEM ON  • The SCREEN/PLAYBACK indicator lights

---

### Monitoring incoming calls

When the SCREEN/PLAYBACK indicator flashes slowly, an incoming message is being recorded

- 1 Press **SCREEN/PLAYBACK**
  - The indicator lights steadily and you can listen to the incoming call
  - To answer the call, press **TALK** (Any Key Talk feature is not available ) The recording is ended
- 2 When finished, press **SCREEN/PLAYBACK**

## OPERATION FROM HANDSET

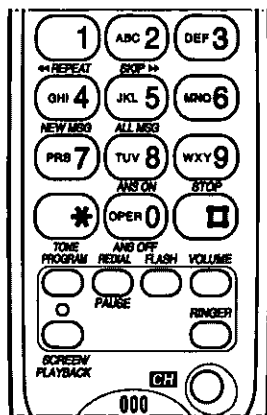

- If the SCREEN/PLAYBACK indicator flashes when you press SCREEN/PLAYBACK, the answering system is off. To turn it on, press "8".

Press **SCREEN/PLAYBACK**.

Press the desired command number as below.

- To play back new messages, press "4".
  - To play back all messages, press "5".
  - To repeat, press "1".
  - To skip, press "2".
- (For more functions, see the reverse side.)

To end the remote operation, press **SCREEN/PLAYBACK**.

## OPERATION FROM TONE PHONE

Call your unit.

Enter your remote code \_\_\_\_\_.

Press the desired direct command number as shown here.  
OR  
Wait for 3 seconds and the unit will start the voice menu. Follow the instructions. (See reverse side.)

To end the remote operation, hang up.

No.	Direct Commands
1	Repeat the message
2	Skip the message
4	New message playback
5	All message playback
7	Recording your greeting
9	Stop
0	Answer off
*	Greeting message skip
*4	Erasing specific message
*5	Erasing all messages
*7	Pager call on
*8	Pager call off

- When you press a button, press firmly.

Press **SCREEN/PLAYBACK**.



- To erase specific message, press "✖4" during the message playback.
- To erase all messages, press "✖5".
- To turn on the pager call feature, press "✖7".
- To turn off the pager call feature, press "✖8".
- To turn off the answering system, press "0".



To end the remote operation, press **SCREEN/PLAYBACK**.

- **To monitor incoming calls:**  
When the **SCREEN/PLAYBACK** indicator flashes slowly, press **SCREEN/PLAYBACK**. When finished, press the button again. To answer the call, press **TALK**.

- **To stop the playback temporarily:**  
Press **[9]** during playback. To resume playback, press **[9]** again within 15 seconds.

- **To use the voice menu :**

Call your unit.



Enter your remote code \_\_\_\_\_.



After 3 seconds, the unit starts the voice menu.



Press "1" to use the voice feature.  
OR  
Press "2" to proceed to other functions.



To end the remote operation, hang up.

- **To turn on the answering system:**  
Call your unit and wait for 15 rings. The unit will answer, then hang up.
- **To skip the greeting message (For outside callers):**  
After calling your unit, press **[✖]** during the greeting message playback. Callers can start recording their message after a long beep.

# Wall Mounting

This unit can be mounted on a wall phone plate.

- 1 Pull down the handset hook so the tab holds the handset.

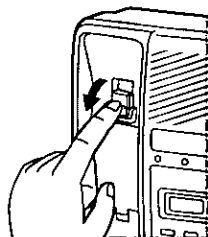

- 2 Connect the AC adaptor. Tuck the telephone line cord inside the wall mounting adaptor, then push it in the direction of the arrow.

- The word "UP" should face upward.

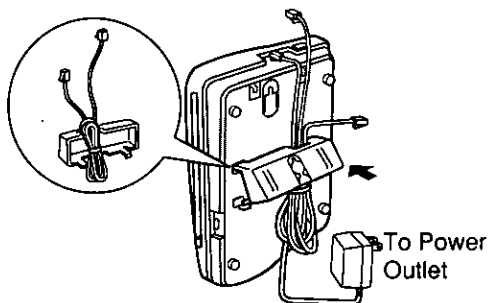

- 3 Connect the telephone line cord. Mount the unit, then slide down.

- Raise the antenna.

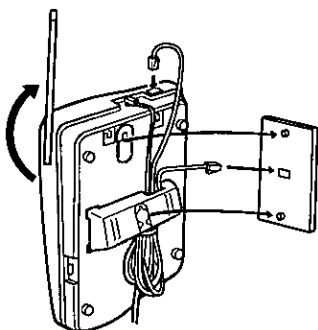

- 4 To charge the handset battery: Place the handset on the handset hook as shown.

- The IN USE/CHARGE indicator lights.

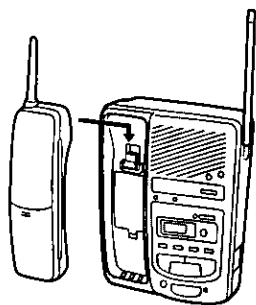

# Optional Spare Battery

When the handset battery needs charging, replace it with a fully charged optional spare battery. This eliminates having to wait for the handset battery to recharge. **Please purchase a Panasonic P-P592 (KX-A92) battery** and install it in the base unit to charge.

## Installing the spare battery in the base unit

- 1 Open the cradle cover by pushing the tab and lifting the cover.

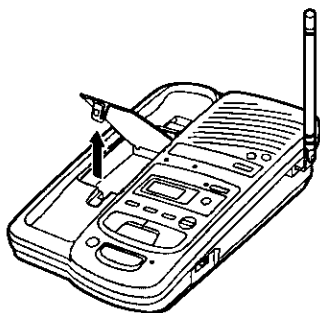

- 2 Install the spare battery as shown observing the proper polarity, then close the cradle cover.

- The SPARE CHARGE indicator lights.

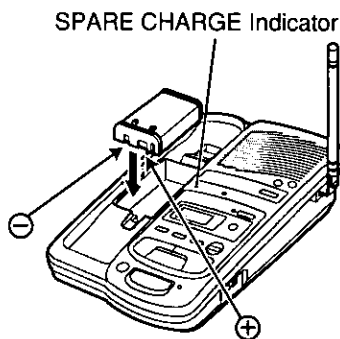

The spare battery is always being charged in the base unit while the AC adaptor is connected. The battery cannot be overcharged.

### Attention:

The product that you have purchased contains a rechargeable battery. The battery is recyclable. At the end of its useful life, under various state and local laws, it may be illegal to dispose of this battery into the municipal waste stream. Check with your local solid waste officials for details in your area for recycling options or proper disposal.



## Replacing the handset battery with the spare battery

To prevent memory loss, replace within 5 minutes.

- 1 Remove the handset cover, then remove the battery.

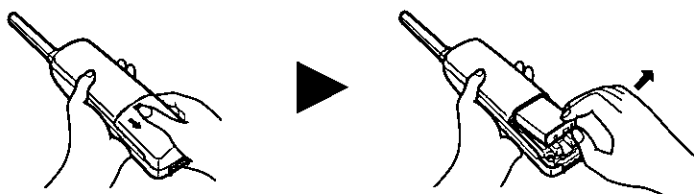

- 2 Replace the handset battery with the spare battery in the base unit.

- ① Remove the spare battery.
- ② Insert the handset battery in the base unit observing the proper polarity.

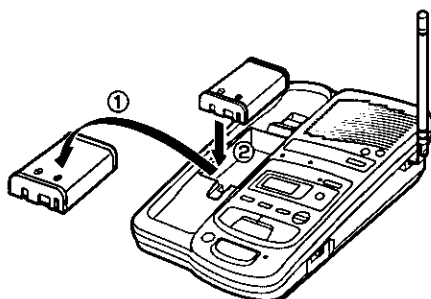

- 3 Install the spare battery in the handset observing the proper polarity.

- When finished, close the handset cover.

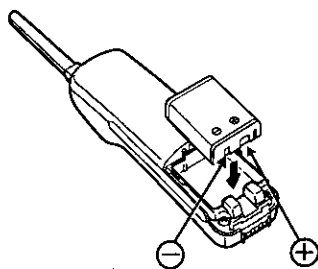

- If the TALK/BATT LOW indicator flashes slowly even when the handset battery has been fully charged, it is time to change the battery with a new one. Remember to fully charge the new battery after battery replacement.
- Please use only a Panasonic P-P592 (KX-A92) battery. For accessory order, call 1-800-332-5368.

# Before Requesting Help

## Cordless telephone

Problem	Remedy
An alarm tone sounds when you press <b>TALK</b> , <b>SCREEN/PLAYBACK</b> or <b>INTERCOM</b> .	<ul style="list-style-type: none"><li>• You are too far from the base unit. Move closer and try again.</li><li>• Place the handset on the base unit and try again.</li><li>• Plug in the AC adaptor.</li></ul>
An alarm tone sounds continuously while using the handset.	<ul style="list-style-type: none"><li>• Move closer to the base unit quickly, or the call will be terminated within 60 seconds.</li><li>• Plug in the AC adaptor.</li></ul>
Static, sound cuts in/out, fades. Interference from other electrical units.	<ul style="list-style-type: none"><li>• Set the handset and the base unit away from electrical appliances.</li><li>• Move closer to the base unit.</li><li>• Raise the base unit antenna.</li><li>• Press <b>CH</b> to change the channel.</li></ul>
The handset does not ring.	<ul style="list-style-type: none"><li>• The ringer volume is set to OFF. Press <b>RINGER</b> when the TALK/BATT LOW indicator light is off.</li></ul>
The base unit does not ring.	<ul style="list-style-type: none"><li>• The RINGER selector is set to OFF. Set to HIGH or LOW.</li></ul>
You cannot store a phone number in memory.	<ul style="list-style-type: none"><li>• You cannot store a number while the unit is in the talk or intercom mode.</li><li>• Do not pause for over 30 seconds while storing.</li></ul>
While storing a phone number, the unit starts to ring.	<ul style="list-style-type: none"><li>• To answer the call, press <b>TALK</b> or <b>SP-PHONE</b>. The program will be canceled; store the number again.</li></ul>
<b>LOCATOR/INTERCOM</b> does not function.	<ul style="list-style-type: none"><li>• The handset is too far from the base unit or is engaged in an outside call.</li></ul>
<b>REDIAL/PAUSE</b> does not function properly.	<ul style="list-style-type: none"><li>• It will redial the last number dialed if pressed at the outset of a call (p. 20). If another number has been dialed first, it will operate as a pause button (p. 28).</li></ul>





## Answering system

Problem	Remedy
The answering system is on, but no incoming messages are recorded.	<ul style="list-style-type: none"><li>• The recording time is set to "greeting only". Select "1 minute" or "unlimited" (p. 17).</li><li>• The memory is full. Erase some or all messages (p. 31).</li></ul>
"FULL" is displayed and no incoming messages are recorded.	<ul style="list-style-type: none"><li>• The memory is full. Erase some or all messages (p. 31). If "FULL" is still displayed, erase your greeting message and re-record a shorter greeting (p. 13, 14).</li></ul>
Some incoming messages have not been recorded up to the end.	<ul style="list-style-type: none"><li>• Set the CPC function to "b" (p. 19).</li></ul>
You cannot operate the answering system at the base unit.	<ul style="list-style-type: none"><li>• The handset user is operating the answering system. Wait until the IN USE/CHARGE indicator light goes out.</li></ul>
You cannot operate the answering system from a touch tone phone.	<ul style="list-style-type: none"><li>• Be sure to press the correct remote code.</li><li>• The answering system may not respond if the phone produces tones that are too short to activate the unit. Press each button firmly.</li><li>• The answering system is off. Turn it on (p. 39).</li></ul>
You cannot operate the answering system with the handset.	<ul style="list-style-type: none"><li>• Someone is operating the answering system.</li><li>• You are too far from the base unit. Move closer to the base unit.</li></ul>

## ➔ Before Requesting Help

---

### General

Problem	Remedy
The unit does not work	<ul style="list-style-type: none"><li>• Check the setting (p 10-12)</li><li>• Charge the battery fully</li><li>• Clean the charge contacts and charge again</li></ul>
The unit stops working during operation	<ul style="list-style-type: none"><li>• Place the handset on the base unit and unplug the AC adaptor to reset Plug in, then try again</li></ul>
You cannot program items such as the time/day adjustment (p 15)	<ul style="list-style-type: none"><li>• Programming is not available while the unit is in the talk, speakerphone or intercom mode</li><li>• Move closer to the base unit</li></ul>
The TALK/BATT LOW indicator flashes slowly or the unit beeps intermittently	<ul style="list-style-type: none"><li>• Charge the battery fully or replace with a fully charged optional spare battery (p 12, 46)</li></ul>
You charged the battery fully, but the TALK/BATT LOW indicator flashes slowly	<ul style="list-style-type: none"><li>• Clean the charge contacts and charge again</li><li>• It is time to change the battery Please purchase a new battery (p 46)</li></ul>
The IN USE/CHARGE indicator and/or the SPARE CHARGE indicator light never go out while charging	<ul style="list-style-type: none"><li>• This is normal</li></ul>
If you cannot solve your problem	<ul style="list-style-type: none"><li>• Call our customer satisfaction center at 201-348-9090</li></ul>

# Adding Another Phone

This unit will not function during a power failure To connect a standard telephone on the same line, use Panasonic T-adaptor KX-J66 (To order, call 1-800-332-5368 )

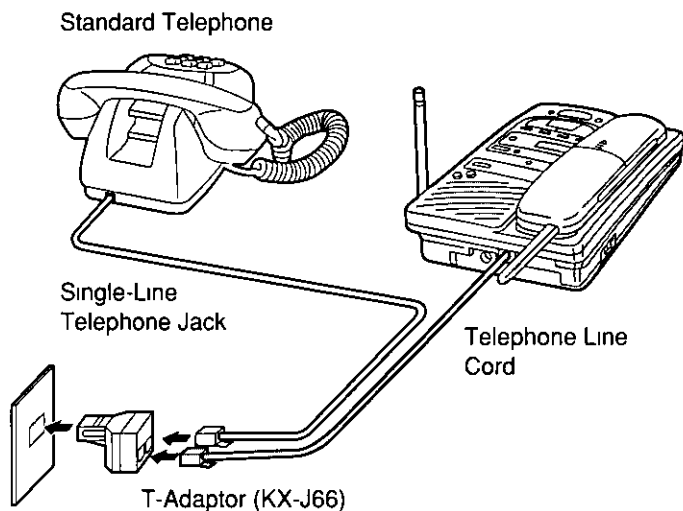

# Important Safety Instructions

---

When using this unit, basic safety precautions should always be followed to reduce the risk of fire, electric shock, or personal injury.

1. Read and understand all instructions.
2. Follow all warnings and instructions marked on this unit.
3. Unplug this unit from AC outlets before cleaning. Do not use liquid or aerosol cleaners. Use a damp cloth for cleaning.
4. Do not use this unit near water, for example, near a bath tub, wash bowl, kitchen sink, or the like.
5. Place this unit securely on a stable surface. Serious damage and/or injury may result if the unit falls.
6. Do not cover slots and openings on the unit. They are provided for ventilation and protection against overheating. Never place the unit near radiators, or in a place where proper ventilation is not provided.
7. Use only the power source marked on the unit. If you are not sure of the type of power supplied to your home, consult your dealer or local power company.
8. Do not place objects on the power cord. Install the unit where no one can step or trip on the cord.
9. Do not overload wall outlets and extension cords. This can result in the risk of fire or electric shock.
10. Never push any objects through slots in this unit. This may result in the risk of fire or electric shock. Never spill any liquid on the unit.
11. To reduce the risk of electric shock, do not disassemble this unit. Take the unit to an authorized servicer when service is required. Opening or removing covers may expose you to dangerous voltages or other risks. Incorrect reassembly can cause electric shock when the unit is subsequently used.
12. Unplug this unit from the wall outlet and refer servicing to an authorized servicer when the following conditions occur:
  - A. When the power supply cord or plug is damaged or frayed.
  - B. If liquid has been spilled into the unit.
  - C. If the unit has been exposed to rain or water.
  - D. If the unit does not work normally by following the operating instructions. Adjust only controls covered by the operating instructions. Improper adjustment may require extensive work by an authorized servicer.
  - E. If the unit has been dropped or physically damaged.
  - F. If the unit exhibits a distinct change in performance.
13. During thunderstorms, avoid using telephones except cordless types. There may be a remote risk of an electric shock from lightning.
14. Do not use this unit to report a gas leak, when in the vicinity of the leak.

## SAVE THESE INSTRUCTIONS

---

**CAUTION:**

To reduce the risk of fire or injury to persons, read and follow these instructions.

1. Use only the battery(ies) specified.
2. Do not dispose of the battery(ies) in a fire. They may explode. Check with local waste management codes for special disposal instructions.
3. Do not open or mutilate the battery(ies). Released electrolyte is corrosive and may cause burns or injury to the eyes or skin. The electrolyte may be toxic if swallowed.
4. Exercise care in handling batteries in order not to short the battery to conductive materials such as rings, bracelets, and keys. The battery and/or conductor may overheat and cause burns.
5. Charge the battery(ies) provided with or identified for use with this product only in accordance with the instructions and limitations specified in this manual.

**WARNING:**

TO PREVENT FIRE OR SHOCK HAZARD, DO NOT EXPOSE THIS PRODUCT TO RAIN OR ANY TYPE OF MOISTURE.

# FCC and Other Information

---

If requested by the telephone company, inform them as follows

FCC Registration No (found on the bottom of the unit)

Ringer Equivalence 0 2B

The particular telephone line to which the equipment is connected

This unit must not be connected to a coin operated line

If you are on a party line, check with your local telephone company

## **Ringer Equivalence No (REN)**

The REN is useful in determining the quantity of devices you may connect to your telephone line and still have all of those devices ring when your telephone number is called. In most, but not all areas, the sum of the REN's of all devices connected to one line should not exceed five (5.0). To be certain of the number of devices you may connect to your line, as determined by the REN, you should contact your local telephone company to determine the maximum REN for your calling area.

In the event terminal equipment causes harm to the telephone network, the telephone company should notify the customer, if possible, that service may be stopped.

However, where prior notice is impractical, the company may temporarily cease service providing that they

- (a) Promptly notify the customer
- (b) Give the customer an opportunity to correct the problem with their equipment
- (c) Inform the customer of the right to bring a complaint to the Federal Communication Commission pursuant to procedures set out in FCC Rules and Regulations Subpart E of Part 68

The Telephone Company may make changes in its communications facilities, equipment, operations or procedures, where such action is reasonably required in the operation of its business and is not inconsistent with the rules and regulations in FCC Part 68.

If such changes can be reasonably expected to render any customer terminal equipment incompatible with telephone company communications facilities, or require modification or alteration of such terminal equipment, or otherwise materially affect its use or performance, the customer shall be given adequate notice in writing, to allow the customer an opportunity to maintain uninterrupted service.

When programming emergency numbers and/or making test calls to emergency numbers

- 1 Remain on the line and briefly explain to the dispatcher the reason for the call before hanging up
- 2 Perform such activities in the off-peak hours, such as early morning hours or late evenings

---

This device complies with Part 15 of the FCC Rules. Operation is subject to the following two conditions: (1) This device may not cause harmful interference, and (2) this device must accept any interference received, including interference that may cause undesired operation.

**CAUTION:**

Any changes or modifications not expressly approved by the party responsible for compliance could void the user's authority to operate this device.

**Note:**

This equipment has been tested and found to comply with the limits for a Class B digital device, pursuant to Part 15 of the FCC Rules. These limits are designed to provide reasonable protection against harmful interference in a residential installation. This equipment generates, uses, and can radiate radio frequency energy and, if not installed and used in accordance with the instructions, may cause harmful interference to radio communications. However, there is no guarantee that interference will not occur in a particular installation. If this equipment does cause harmful interference to radio or television reception, which can be determined by turning the equipment off and on, the user is encouraged to try to correct the interference by one or more of the following measures:

- Reorient or relocate the receiving antenna.
- Increase the separation between the equipment and receiver.
- Connect the equipment into an outlet on a circuit different from that to which the receiver is connected.
- Consult the dealer or an experienced radio/TV technician for help.

Some cordless telephones operate at frequencies that may cause interference to nearby TVs and VCRs. To minimize or prevent such interference, the base of the cordless telephone should not be placed near or on top of a TV or VCR. If interference is experienced, move the cordless telephone further away from the TV or VCR. This will often reduce or eliminate interference.

Privacy of communications may not be ensured when using this phone.

- **Environment** — do not place the unit in room where the temperature is less than 5°C (41°F) or greater than 40°C (104°F). Allow 10 cm (4") clearance around the unit for proper ventilation. Avoid excessive smoke, dust, mechanical vibration, shock, or direct sunlight.
- **Routine care** — wipe the unit with a soft cloth. Do not use benzine, thinner, or any abrasive powder. When you left the unit unused for long time, unplug the AC adaptor from the outlet.
- **If there is any trouble** — disconnect the unit from the telephone line and connect a known working phone. If the known working phone operates properly, have your unit repaired by one of the authorized Panasonic Factory Service Centers. If the known working phone does not operate properly, consult with your telephone company.

## For product service

- Panasonic Servicenters are listed in the servicenter directory.
- Call 1-800-545-2672 for the location of an authorized servicenter.

## When you ship the product

- Carefully pack your unit, preferably in the original carton.
- Attach a letter, detailing the symptom, to the outside of the carton.

### Symptom

---

- Send the unit to an authorized servicenter, prepaid and adequately insured.
- Do not send your unit to the Matsushita Consumer Electronics Company listed below or to executive or regional sales offices. These locations do not repair consumer products.

- This cordless telephone is designed for use in the United States of America. Sale or use of this product in other countries may violate local laws.
- Ce téléphone sans fil est conçu pour être utilisé aux États-Unis d'Amérique. La vente ou l'emploi de cet appareil dans certains autres pays peut constituer une infraction à la législation locale.
- Este teléfono sin cordón fue elaborado para uso en los Estados Unidos de América. La venta o el empleo de este producto en ciertos países puede constituir violación de la legislación local.
- このコードレス電話機は、日本国外での使用を目的として設計されており、日本国内での使用は法律違反となります。従って、当社では日本国内においては原則として修理などのサービスは致しかねます。

**Matsushita Consumer Electronics Company,  
Division of Matsushita Electric Corporation of America**  
One Panasonic Way, Secaucus, New Jersey 07094

**Panasonic Sales Company ("PSC"),  
Division of Matsushita Electric of Puerto Rico, Inc.**  
Ave. 65 de Infantería, Km. 9.5, San Gabriel Industrial Park  
Carolina, Puerto Rico 00985