

Panasonic

900MHz Cordless Answering System

Model No. **KX-TCM947-B**

Pulse-or-tone dialing capability

Operating Instructions



2 LINE

PLEASE READ BEFORE USE AND SAVE.

Charge the battery for about 4 hours before initial use.

Preparation

Cordless Telephone

Answering System

Useful Information

Before Initial Use

Please read **IMPORTANT SAFETY INSTRUCTIONS** on pages 80–81 before use. Read and understand all instructions.

Thank you for purchasing your new Panasonic cordless telephone.

Attach your purchase receipt here.

For your future reference

Serial No. _____
(found on the bottom of the unit)

Date of purchase _____

Name and address of dealer _____

Accessories (Included) To order, call 1-800-332-5368.

- AC Adaptor (p. 11)
Order No. KX-A11-6

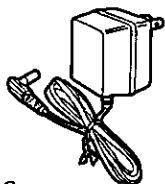

one

- 4-Wire Telephone
Line Cord with
Green Plugs
(p. 12, 13)



one

- 2-Wire Telephone
Line Cord with
Transparent Plugs
(p. 13)

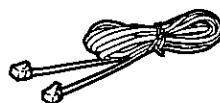

one

- Wall Mounting Adaptor
(p. 17)
Order No. PQKL24Z0

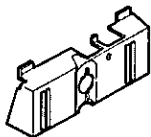

one

- Belt Clip (p. 18)
Order No. PQKE10074Z1



one

For Best Performance

Battery Charge

A rechargeable Ni-Cd battery powers the handset. Charge the battery for about **4 hours** before initial use (p. 14).

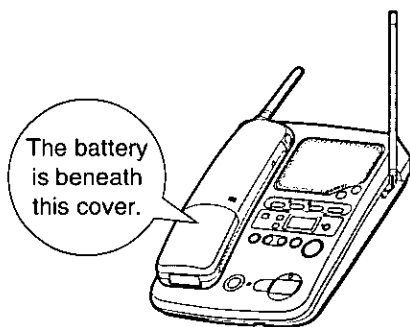

Base Unit Location

Calls are transmitted between the base unit and the handset using wireless radio waves. **For maximum distance and noise free operation**, the recommended base unit location is:

Away from electrical appliances such as a TV, radio, or personal computer.

In a **HIGH** and **CENTRAL** location with no obstructions such as walls.

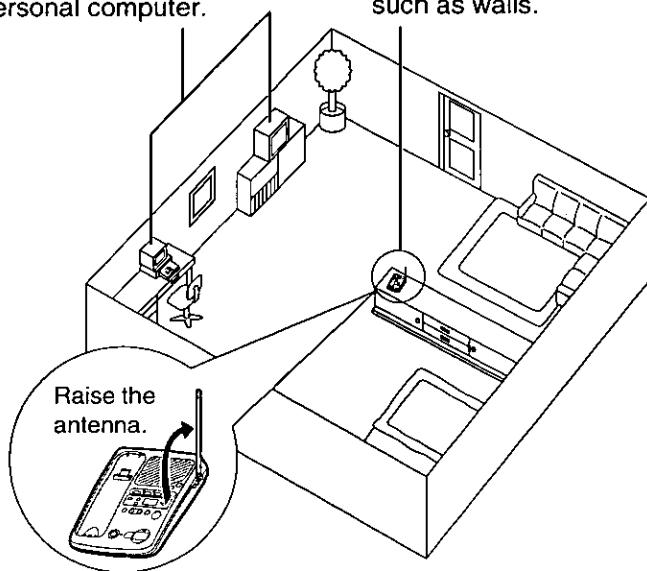

Contents

Preparation

Location of Controls	6
Settings	11
Connecting the AC Adaptor	11
Connecting the Telephone Line Cord	12
Battery Charge	14
Selecting the Dialing Mode	15
Selecting the Ringer Volume	16
Wall Mounting	17
Using the Belt Clip	18
Using an Optional Headset	19
Connecting an Optional Headset to the Handset	19
Preparing the Answering System	20
Greeting Message	20
Programming Summary for the Answering System	22
Time and Day Adjustment	23
Selecting the Caller's Recording Time	24
Selecting the Number of Rings	25
Setting the CPC (Calling Party Control) Function	26
Setting the Greeting Monitor Function	26

Cordless Telephone

Making Calls	27
Answering Calls	29
With the Handset	29
With the Base Unit (Digital Duplex Speakerphone)	30
Speed Dialer	32
Storing Phone Numbers in Memory	32
Dialing a Stored Number	33
Using the Other Line During a Conversation	34
While Someone Else is Using a Line (Simultaneous Base/Handset Operation)	34
While You are Using a Line	36
Conference Call	38
Intercom	40
Transferring a Call Using the Intercom	42

Special Features	43
For Call Waiting Service Users	43
Automatic Security Code Setting	43
Temporary Tone Dialing (For Rotary or Pulse Service Users) ..	43
How to Use the PAUSE Button (For Analog PBX Line/Long Distance Service Users)	43
Programmable Functions	44
Programming Summary for the Cordless Phone	44
Line Selection	45
Line Indicator	46
Incoming Call Tone	47
Line Mode Selection	47

Answering System

Automatic Answering Operation	48
Setting the Unit to Answer Calls	48
Listening to Messages	50
From the Handset	52
Erasing Messages	53
Pager Call	55
Storing the Pager Number	55
Setting the Unit to Call a Pager	57
Remote Operation from a Touch Tone Phone	58
Setting the Remote Code	59
Voice Menu	60
Direct Remote Operation	62
Remote Operation with the Handset	66
Remote Operation Card	71

Useful Information

Battery Replacement	73
Adding Another Phone	74
Before Requesting Help	75
Important Safety Instructions	80
FCC and Other Information	82

Location of Controls

Base unit

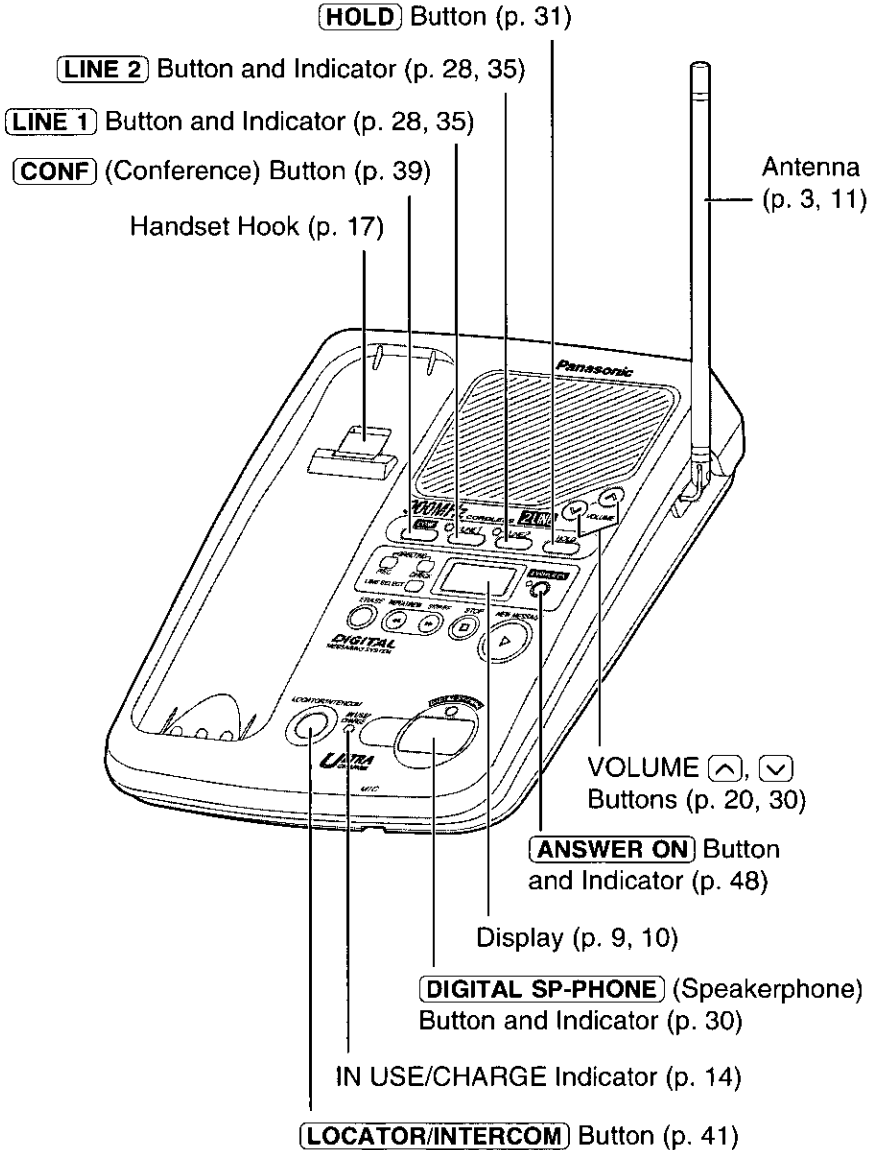

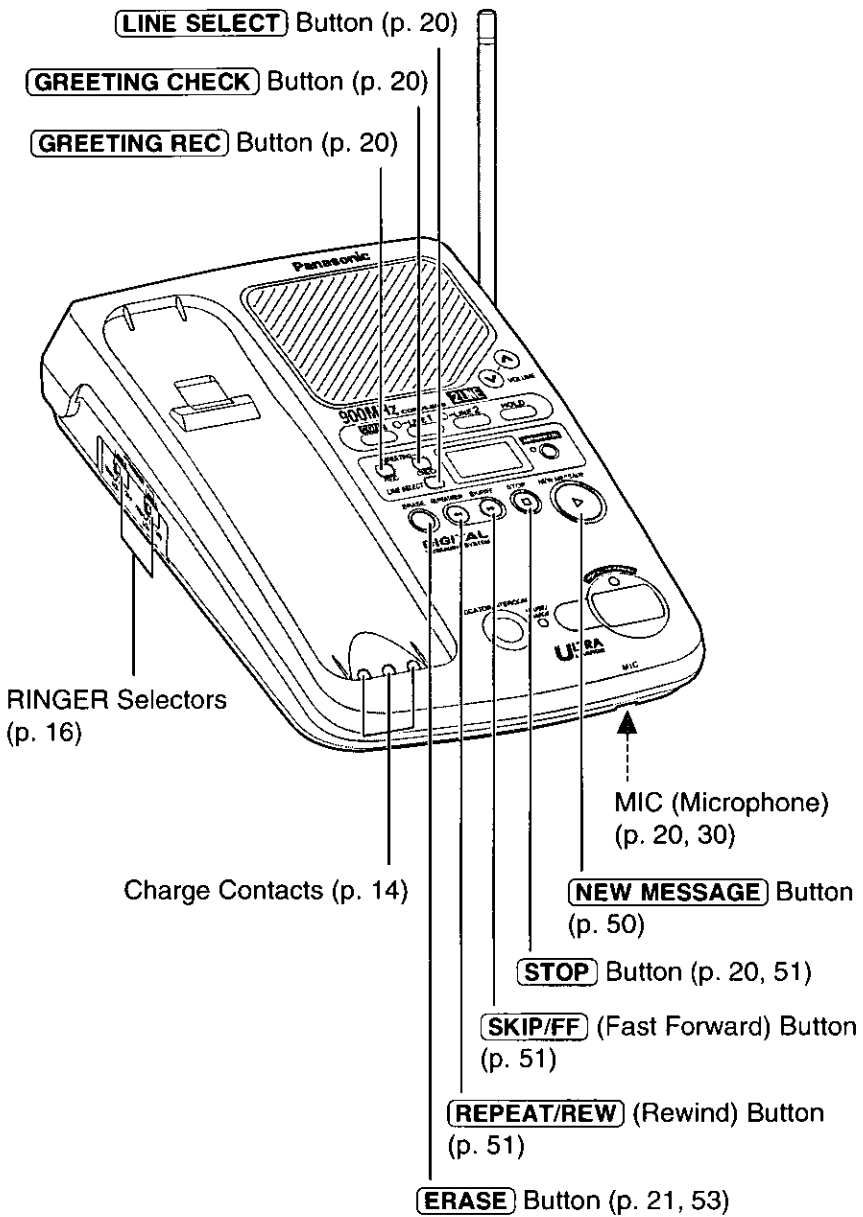

► Location of Controls

Handset

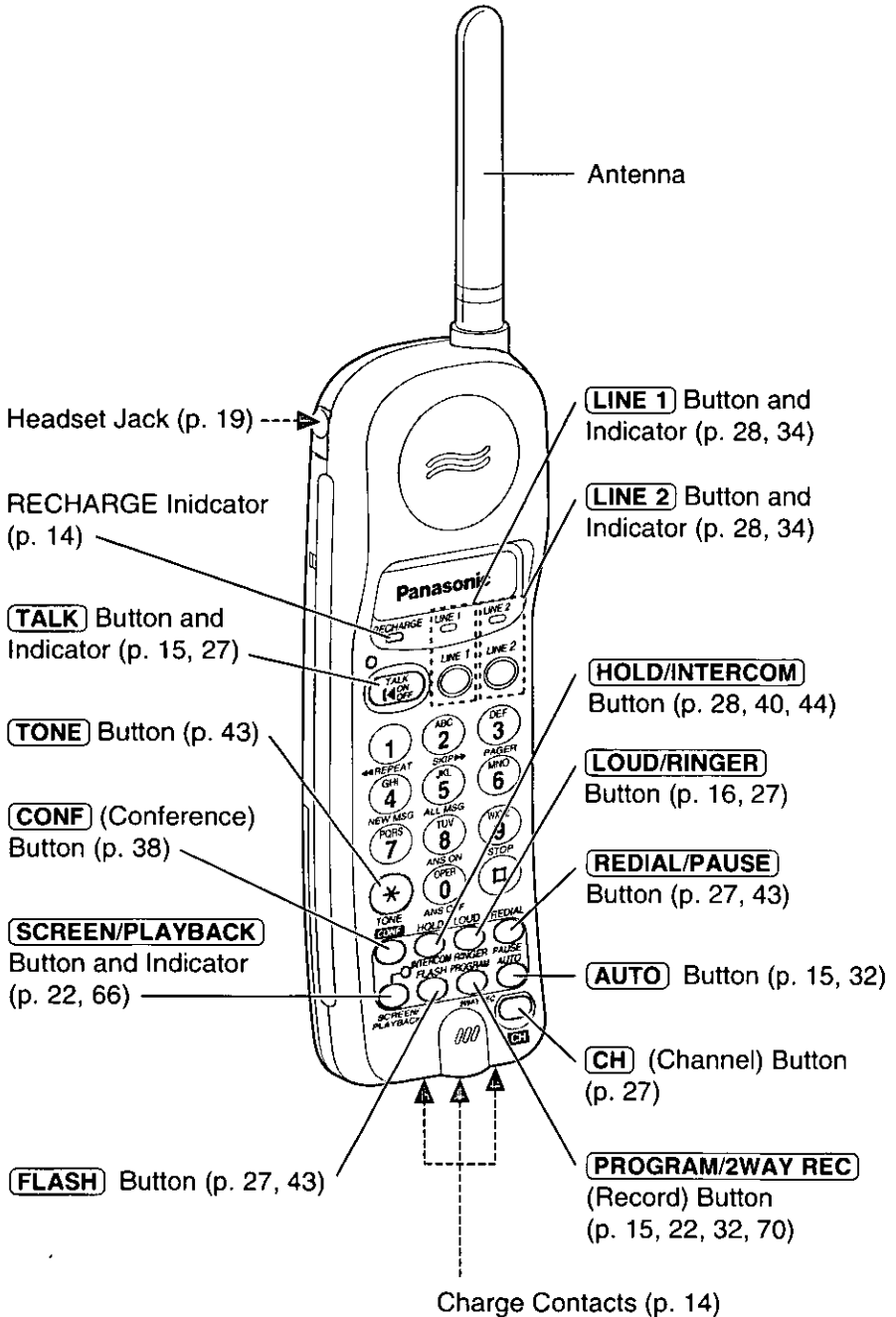



Base unit display



The clock needs adjusting (p. 23).



The unit is in programming mode.

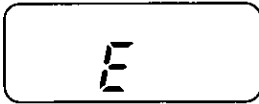

Your greeting message was not recorded correctly. Record it again (p. 20).



A pre-recorded message is being played (p. 21). The corresponding line display will flash.



The LINE 1 recording time is set to "greeting only" (p. 24).

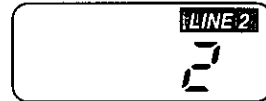
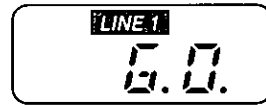

The speaker volume level is set to "5". You can select:

- 9 levels (0–8) while using the answering system (p. 20, 50).
- 8 levels (1–8) while using the speakerphone (p. 30).

The LINE 1 recording time is set to "greeting only" (p. 24) and 2 messages have been recorded on LINE 2. When both lines are selected, the display changes alternately.

(continued →)

► Location of Controls

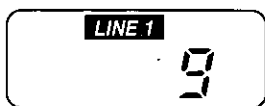

9 messages have been recorded on LINE 1. (LINE 1 is selected.)

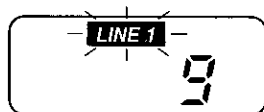

There are some new messages on LINE 1. (The LINE 1 display flashes.)

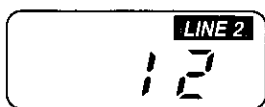

12 messages have been recorded on LINE 2. (LINE 2 is selected.)

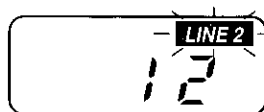

There are some new messages on LINE 2. (The LINE 2 display flashes.)

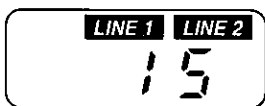

15 messages have been recorded on LINE 1 and LINE 2. (Both lines are selected.)



8 messages have been recorded on LINE 1 and LINE 2. There are some new messages on LINE 1. (The LINE 1 display flashes.)

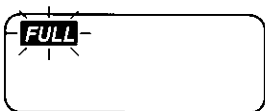

Memory is full. Erase some or all of the messages (p. 53, 54).



The pager call mode is set to ON (p. 57).



Connecting the AC Adaptor

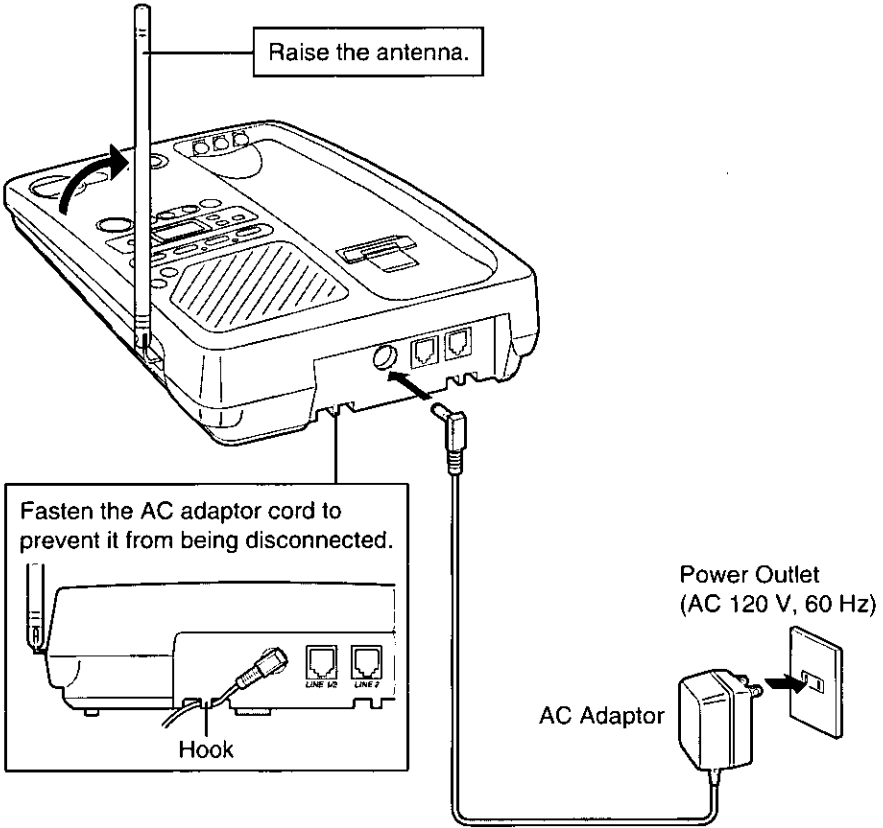

- USE ONLY WITH Panasonic AC ADAPTOR KX-A11 (Order No. KX-A11-6).
- The AC adaptor must remain connected at all times. (It is normal for the adaptor to feel warm during use.)
- To connect a standard telephone on the same line, see page 74.

► Settings

Connecting the Telephone Line Cord

Connect the telephone line cord(s) to the unit as follows.

To connect a two-line telephone jack

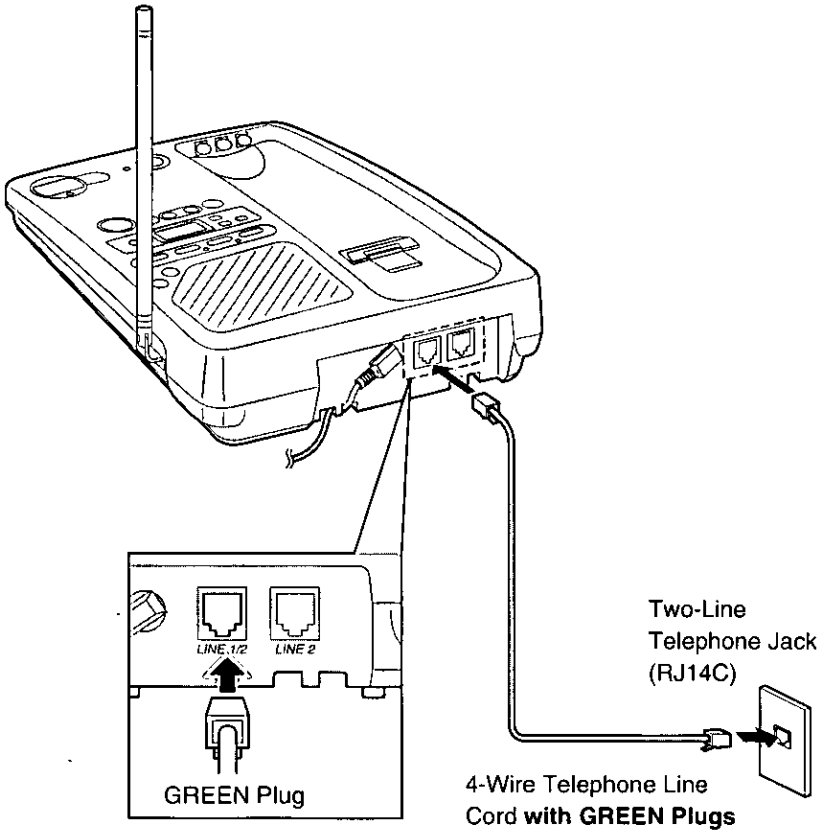



To connect two single-line telephone jacks

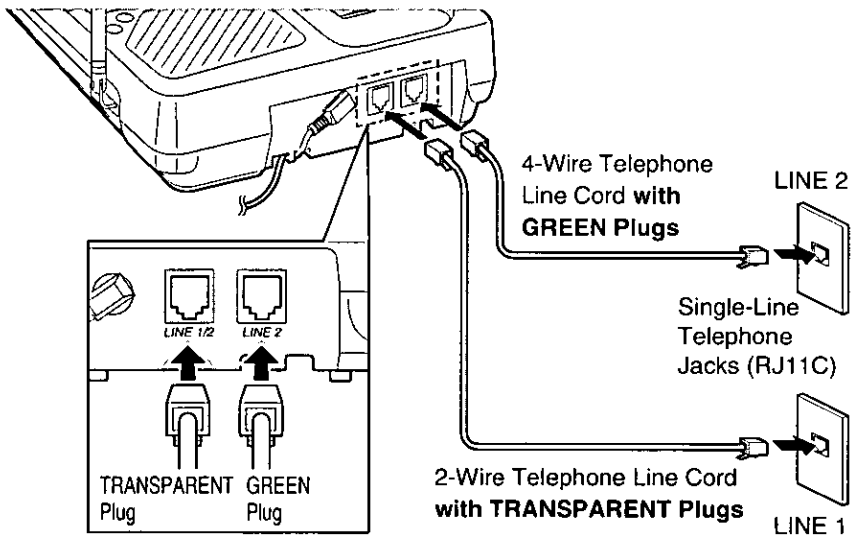

If you use the unit as a single-line telephone only

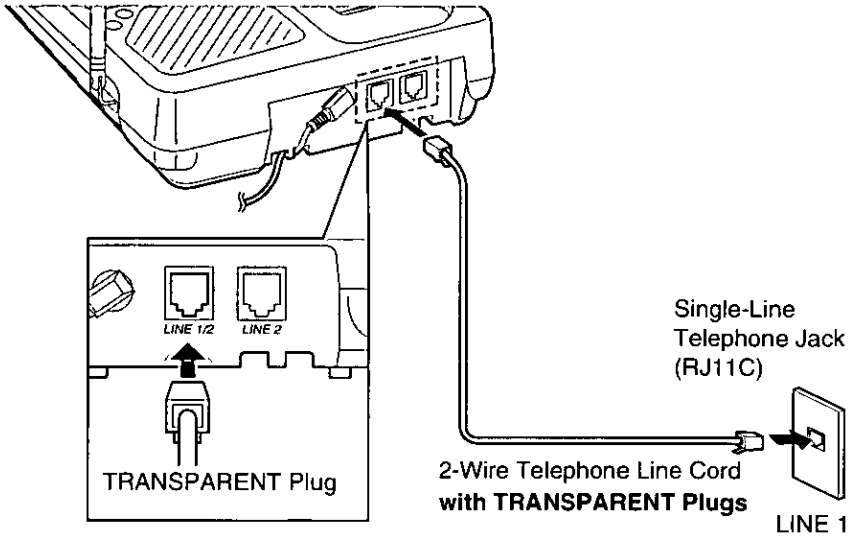

●With this connection, you can only use LINE 1. The LINE 2 indicator will not work properly. (It will continue to flash.) To turn off the line indicator, see page 46.

► Settings

Battery Charge

Place the handset on the base unit and charge for about **4 hours** before initial use.

- The IN USE/CHARGE indicator lights.

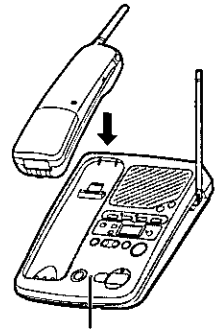

IN USE/CHARGE Indicator

Recharge

When the RECHARGE indicator flashes or the unit beeps intermittently, recharge the battery for about 4 hours.

- If you **DO NOT** recharge the handset battery for more than 30 minutes, the RECHARGE indicator will continue to flash.

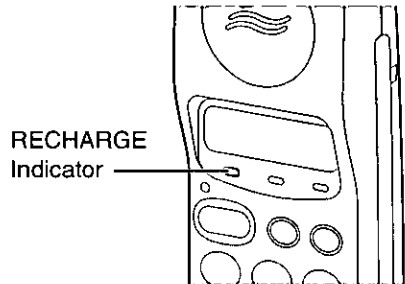

Battery information

After your Panasonic battery is fully charged:

Operation	Approx. battery life
While in use (TALK)	Up to about 6 hours
While not in use (Stand-By)	Up to about 21 days

- Battery life may vary depending on usage conditions and ambient temperature.
- Clean the handset and the base unit charge contacts with a soft dry cloth once a month. Clean more often if the unit is subject to grease, dust or high humidity.** If not, the battery may not charge properly.
- If the battery is fully charged, you do not have to place the handset on the base unit until the RECHARGE indicator flashes. This will maximize the battery life.
- The battery cannot be overcharged.



Selecting the Dialing Mode

You can program the dialing mode **by using the handset near the base unit**. If you have touch tone service, set to TONE. If rotary or pulse service is used, set to PULSE. Your phone comes from the factory set to TONE.

The TALK and DIGITAL SP-PHONE indicator lights must be off before programming.

- 1 Press **PROGRAM/2WAY REC**.
 - The TALK indicator flashes.
- 2 Press **AUTO**.
- 3 To select PULSE, press **#** twice.
OR
To select TONE, press ***** twice.
- 4 When finished, press **PROGRAM/2WAY REC**.
 - A confirmation tone sounds.*

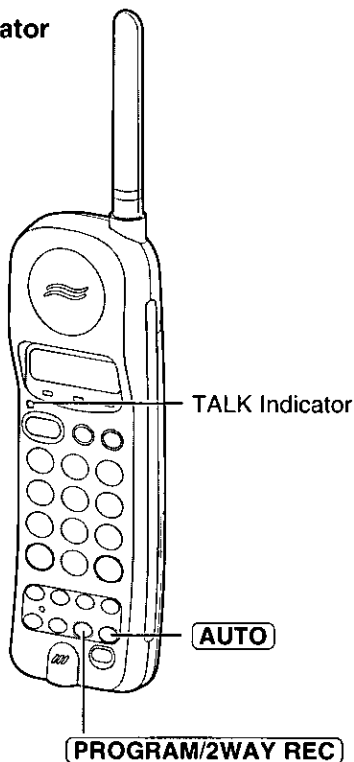

- To cancel during programming, press **PROGRAM/2WAY REC**, then start from step 1.
- If 3 beeps sound during programming, a wrong key was pressed. Restart from step 1.
- If either line has rotary or pulse service, set to PULSE. When making a call using the line which has touch tone service, press ***** first and then dial the number.

*What the confirmation tone means

- 1 beep: The mode is different from the previously selected one.
- 2 beeps: The mode is the same as the previously selected one.

Selecting the Ringer Volume

With the handset

The TALK indicator light must be off.

- **To select HIGH (preset) or LOW,** press **LOUD/RINGER** briefly. (Each time you press the button briefly, the selected volume will ring and the ringer volume will change.)
- **To turn the ringer OFF,** press and hold **LOUD/RINGER** until 2 beeps sound.
- **To turn the ringer ON,** press **LOUD/RINGER** briefly. The ringer will sound at the HIGH level.

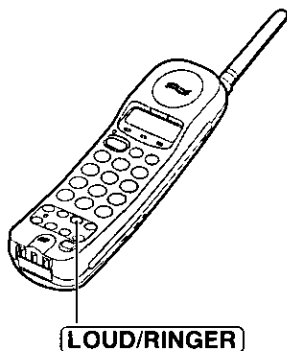

With the base unit

Set the RINGER selector for each line to HIGH, LOW, or OFF.

- When set to OFF, the selected line(s) will not ring.

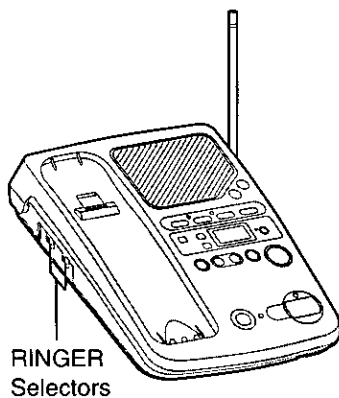



Wall Mounting

This unit can be mounted on a wall phone plate.

- 1** Pull down the handset hook until it locks, **so the tab holds the handset.**

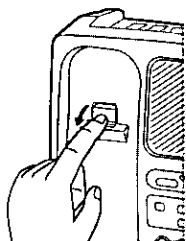

- 2** Connect the AC adaptor. Tuck the telephone line cord inside the wall mounting adaptor, then push it in the direction of the arrow.

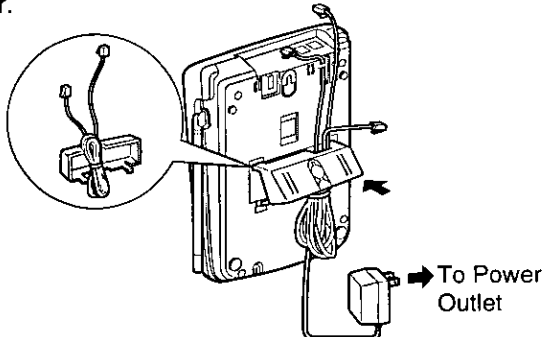

- "UP" should face upward.

- 3** Connect the telephone line cord. Mount the unit, then slide down.

- Raise the antenna.

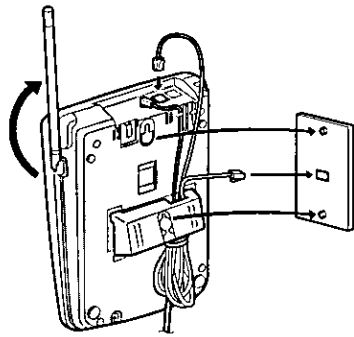

- 4** **To charge the battery:** Place the handset on the handset hook as shown.

- The IN USE/CHARGE indicator lights.

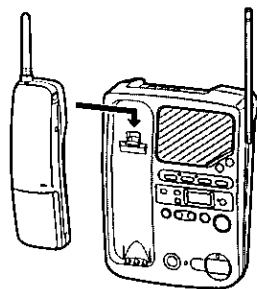

► Settings

Using the Belt Clip

You can hang the handset on your belt or pocket using the belt clip.

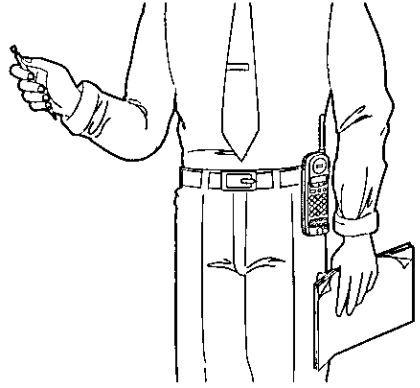

To install the belt clip

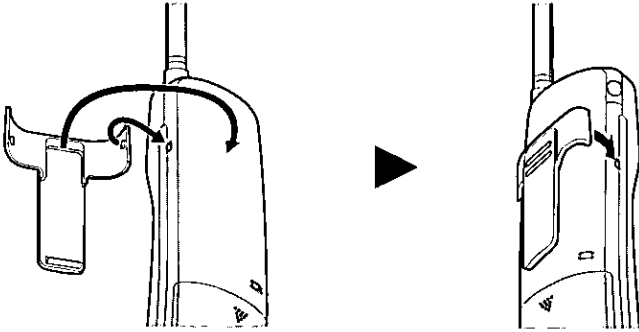

To remove the belt clip

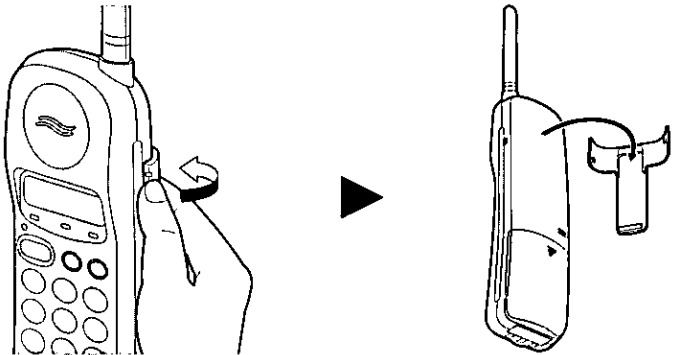

Using an Optional Headset

Plugging an optional headset into the handset provides a handsfree phone conversation. Please use only a Panasonic KX-TCA80 or KX-TCA90 headset. To order, call 1-800-332-5368.

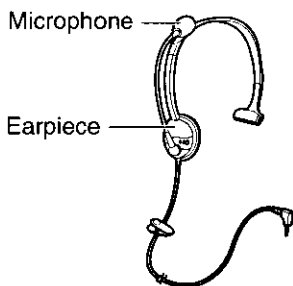

The headset illustration is a KX-TCA80.

When an optional headset is connected to the handset, be sure to use the headset to talk with the caller. If you want to have a normal cordless phone conversation, disconnect the headset.

Connecting an Optional Headset to the Handset

Open the headset jack cover, then connect an optional headset to the headset jack as shown below.

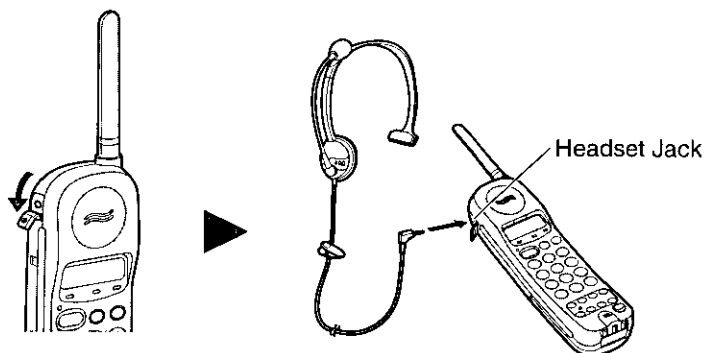

Preparing the Answering System

Greeting Message

You can record a common greeting message or personal greeting message for each line. If not, one of two pre-recorded greetings will be played when a call is received (p. 21).

All messages (greeting, incoming, etc.) are stored in digital memory (p. 21). The **total recording time is about 18 minutes**.

We recommend you record a **brief greeting message** (see the sample on the next page) in order to leave more time for recording new messages.

To record a greeting message

- To record a common greeting, press **LINE SELECT** repeatedly until "**LINE 1 LINE 2**" is displayed.
 - To record a greeting for each line, press **LINE SELECT** repeatedly until "**LINE 1**" or "**LINE 2**" is displayed.

- Press **GREETING REC** to start the recording mode.

- "Press RECORD again to record greeting." is heard.

- Within 5 seconds, press **GREETING REC** again to record your greeting.

- A long beep sounds.

- After the long beep, talk clearly about 8 inches (20 cm) away from the **MIC** (microphone).

- The display shows the elapsed recording time.

- When finished, press **STOP**.

- To check the recorded greeting, press **GREETING CHECK**.
- To change the message, repeat from step 1.

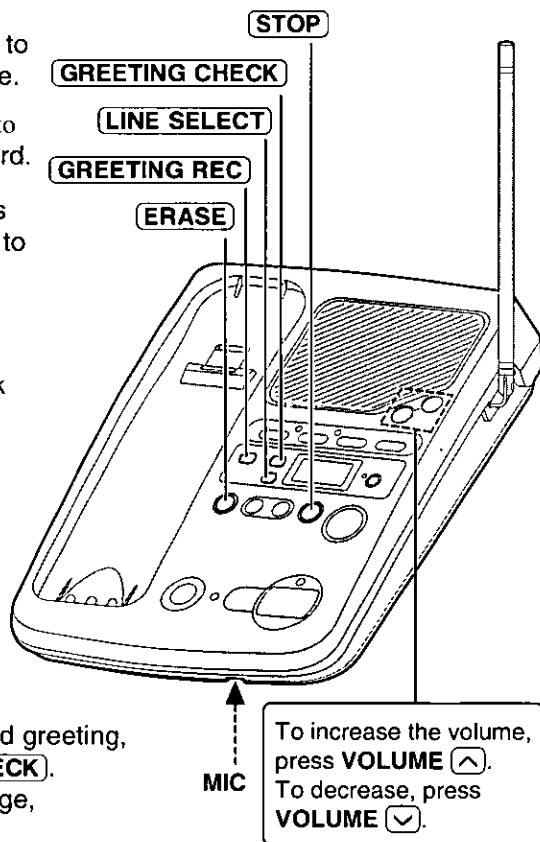



Greeting message sample

"Hello, this is (your name and/or number). Sorry I cannot take your call. Please leave a message after the beep. Thank you."

To erase the recorded greeting message

Press **[GREETING CHECK]** → press **[ERASE]** while the message is being played.

- The unit will answer a call with a pre-recorded greeting.

Pre-recorded greeting message

If you do not record a greeting message (p. 20), one of the following two messages will be played when a call is received depending on the caller's recording time (p. 24).

To check the pre-recorded greeting, press **[GREETING CHECK]**.

- A pre-recorded greeting will be played as below.

- When the recording time is set to "1 minute" or "unlimited";

"Hello, we are not available now. Please leave your name and phone number after the beep. We will return your call."

- When the recording time is set to "greeting only";

"Hello, we are not available now. Please call again. Thank you for your call."

To check the greeting message(s)

Press **[LINE SELECT]** repeatedly to select the desired line(s) → press **[GREETING CHECK]**.

- The selected greeting(s) is (are) played back.
- When the both lines are selected and there are recorded greetings for each line, the LINE 1 greeting will be played first.

Flash Memory Message Backup

Messages are stored indefinitely on a "flash memory" IC chip—even if a power failure occurs. All of the messages are saved until you erase them.

► Preparing the Answering System

Programming Summary for the Answering System

You can program the following functions by using the handset near the base unit. See the noted pages for details.

The TALK and DIGITAL SP-PHONE indicator lights must be off before programming.

Lift the handset, then press **PROGRAM/2WAY REC**.



Press **SCREEN/PLAYBACK**.



• If an alarm tone sounds, move closer to the base unit, then try again.

To adjust the time and day, press **0**. (page 23)

To set the remote code, press **1**. (page 59)

To select the number of rings, press **2**. (page 25)

To set the CPC function, press **3**. (page 26)

To set the greeting monitor function, press **4**. (page 26)

To select the caller's recording time, press **5**. (page 24)

To store the pager number, press **#**. (page 55)



When finished, press **PROGRAM/2WAY REC**.

• A confirmation tone sounds.*

- To cancel during programming, press **PROGRAM/2WAY REC**, then start from the beginning.
- If 6 beeps sound during programming, a wrong key was pressed. Enter the correct number again.

*What the confirmation tone means

1 beep: The new programmed setting or selection is done.

2 beeps: The setting or selection is the same as the previous one.

6 beeps: The setting or selection is not correct. Try again from the beginning.



Time and Day Adjustment

Voice Time/Day Stamp: During playback, a synthesized voice will announce the time and day when each message was recorded.

- 1 Press **PROGRAM/2WAY REC**.
 - The TALK indicator flashes.
- 2 Press **SCREEN/PLAYBACK**.
 - The indicator lights.
 - “P” is displayed on the base unit.
- 3 Press **0**.
 - “⌚” is displayed.
 - “Set time” is announced.
 - The time/day will be heard if it was adjusted beforehand.
- 4 Enter the current time (hour and minute) by using a 4-digit number. (Ex. To set 9:30, enter “0930”.)
 - The unit announces the time.
 - The entered number is displayed.
- 5 Press ***** to select “AM” or “PM”. Press **#** repeatedly to set the day.
- 6 When finished, press **PROGRAM/2WAY REC**.
 - The unit announces the time/day.
 - The clock starts working.

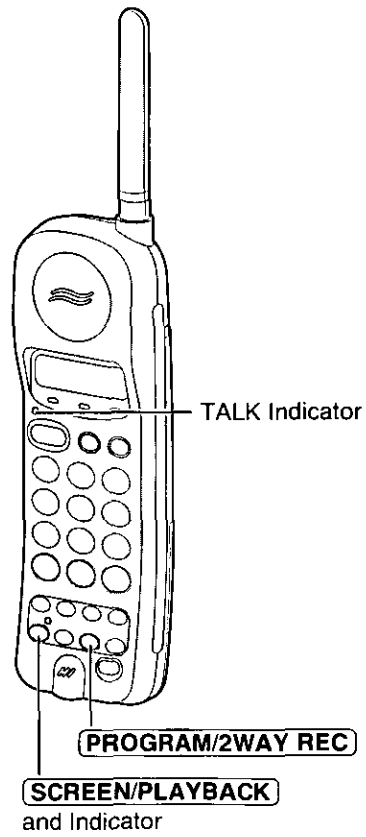

- In step 4, you cannot enter numbers greater than 12. **Do not use military time.** (To set 13:00 hours, enter “0100” and select “PM” by pressing *****.)
- The accuracy of the clock is approximately ± 45 seconds a month at room temperature.

If a power failure occurs, the adjusted time/day may be erased.

To check the time/day

- Press **PROGRAM/2WAY REC** → **SCREEN/PLAYBACK** → **0**.
- The current time/day is heard. When finished, press **PROGRAM/2WAY REC**.

► Preparing the Answering System

Selecting the Caller's Recording Time

You may select the caller's recording time of each line as either "1 minute", "unlimited" or "greeting only". Both lines are preset to "unlimited".

- 1 Press **PROGRAM/2WAY REC**.
 - The TALK indicator flashes.
- 2 Press **SCREEN/PLAYBACK**.
 - The indicator lights.
 - "P" is displayed on the base unit.
- 3 Press **5**.
- 4 To select LINE 1, press **1**.
To select LINE 2, press **2**.
 - The current setting of the selected line is displayed.
 - 1: 1 minute
 - 2: unlimited (factory preset)
 - 3: greeting only
- 5 Press **1**, **2** or **3** to select the recording time.
 - The setting is displayed.
- 6 When finished, press **PROGRAM/2WAY REC**.
 - The indicator lights go out.

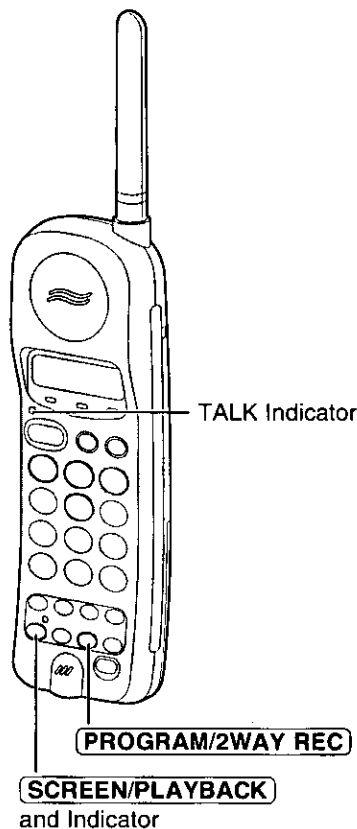

If you select "greeting only", the unit will answer a call with the greeting message, and then hang up. The unit will not record any incoming messages.



Selecting the Number of Rings

You may select the number of rings before the answering system answers a call, from "1" to "7" or "AUTO (for Toll Saver)". Your phone comes from the factory set to "AUTO".

- 1 Press **PROGRAM/2WAY REC**.
 - The TALK indicator flashes.
- 2 Press **SCREEN/PLAYBACK**.
 - The indicator lights.
 - "P" is displayed on the base unit.
- 3 Press **2**.
 - The current setting is displayed.
- 4 Press a dialing button **0** to **7** to set the number of rings.
 - 0**: Selects "AUTO".
"A" is displayed.
 - 1-7**: The unit will answer after the selected number of rings.
- 5 When finished, press **PROGRAM/2WAY REC**.
 - The indicator lights go out.

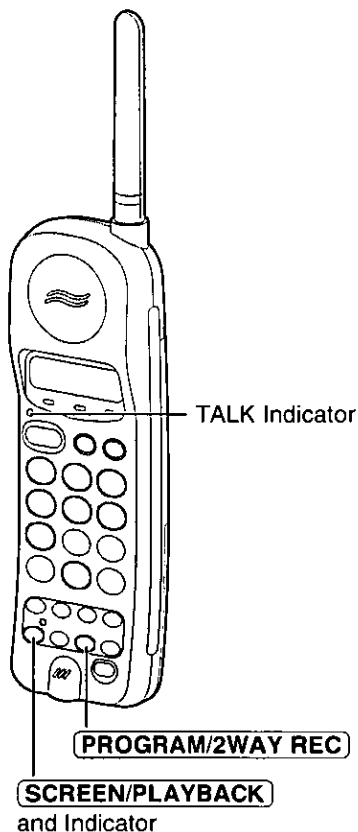

Toll Saver (When set to "AUTO")

When you call the unit from a touch tone telephone:

If the unit answers on the 2nd ring, there is at least one new message.

If the unit answers on the 4th ring, there are no new messages.

Hang up when you hear the 3rd ring. This will save you the toll charge for the call.

► Preparing the Answering System

Setting the CPC (Calling Party Control) Function

The CPC function is preset to "A". If you use a call waiting service, set to "b", or the call waiting tone will disconnect someone leaving a message.

1. Press **PROGRAM/2WAY REC**.
2. Press **SCREEN/PLAYBACK**.
3. Press **3**.
 - The current setting, "A" or "b", is displayed on the base unit.
4. To select "b", press **2**.
OR
To select "A", press **1**.
 - The setting is displayed.
5. When finished, press **PROGRAM/2WAY REC**.

Setting the Greeting Monitor Function

When your greeting message is being played to the caller, you can also listen to it through the base unit speaker. To listen to your greeting, set to "2 (ON)". Your phone comes from the factory set to "1 (OFF)".

1. Press **PROGRAM/2WAY REC**.
2. Press **SCREEN/PLAYBACK**.
3. Press **4**.
 - The current setting, "1" or "2", is displayed on the base unit.
4. To select "2 (ON)", press **2**.
OR
To select "1 (OFF)", press **1**.
 - The setting is displayed.
5. When finished, press **PROGRAM/2WAY REC**.

Making Calls



The unit will automatically select an idle line when you press **TALK** to make a call. (To change the line selection, see page 45.)

To have a handsfree conversation, connect the optional headset to the handset and wear it (p. 19).

- 1 Press **TALK**.
 - The TALK indicator and the selected line indicator light.
- 2 Dial a telephone number.
 - If you misdial, press **FLASH** firmly then dial again.
- 3 To hang up, press **TALK** or place the handset on the base unit.
 - The indicator lights go out.

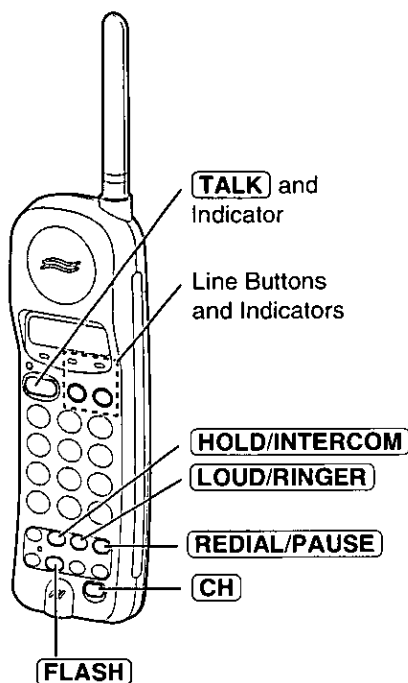

Cordless Telephone

- If an alarm tone sounds in step 1, move closer to the base unit or place the handset on the base unit. Then try again.
- In step 1, you may select a line manually by pressing the line button instead of **TALK**.

To redial the last number dialed

Press **TALK** (or a line button) → **REDIAL/PAUSE**.

To select the receiver volume

Press **LOUD/RINGER** while talking.

- Each time you press the button, the volume level will change from MEDIUM (preset) to HIGH to LOW.

If noise interferes with the conversation

Press **CH** to select a clearer channel or move closer to the base unit.

► Making Calls

To put a call on hold

Press **HOLD/INTERCOM**.

- The TALK indicator light goes out and the line indicator flashes.
- After 6 minutes, warning tones will sound every 10–15 seconds. After a total of 10 minutes, the call will be disconnected.

To release the hold

Press the line button.

- If another phone is connected on the same line (p. 74), you can also release the hold by lifting its handset.

You may make or answer a second call on the other line while keeping the present call on hold. See page 36.

What the line indicator means

Off	The line is free.
On	You are using the line on the handset or the base unit.
Flashing twice every 2 seconds	Someone else is using the line on the handset, base unit or parallel connected telephone.
Flashing	A call is on hold. The answering system is recording a message.
Flashing quickly	A call is being received.

Lighted handset keypad

The handset dialing buttons will light while dialing and flash when a call is received. The lights will go out about 10 seconds after dialing or answering a call.

Answering Calls



When a call is being received, the called line indicator flashes quickly. The line is automatically selected when you answer the call.

(To change the line selection, see page 45.)

To have a handsfree conversation, connect the optional headset to the handset and wear it (p. 19).

With the Handset

If the handset is off the base unit, press **TALK**.

- The called line indicator lights.
- You can also answer a call by pressing any dialing button **0** to **9**, ***** or **#**.
(—Any Key Talk).

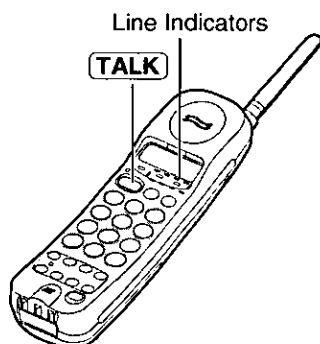

Cordless Telephone

OR

If on the base unit, just lift up.

- The called line indicator lights.

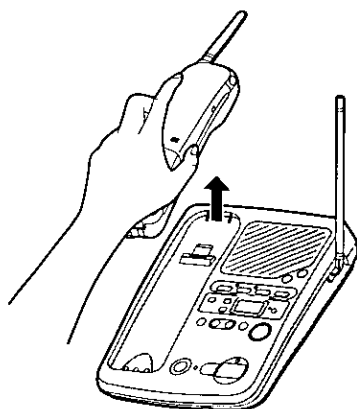

If the optional headset is connected to the handset, be sure to use the headset (p. 19) to talk with the caller. If you want to have a normal cordless phone conversation, disconnect the headset.

► Answering Calls

With the Base Unit (Digital Duplex Speakerphone)

1 Press **DIGITAL SP-PHONE**.

- The DIGITAL SP-PHONE indicator and the called line indicator lights.

2 Talk into the **MIC** (microphone).

3 To hang up, press **DIGITAL SP-PHONE**.

- The indicator lights go out.

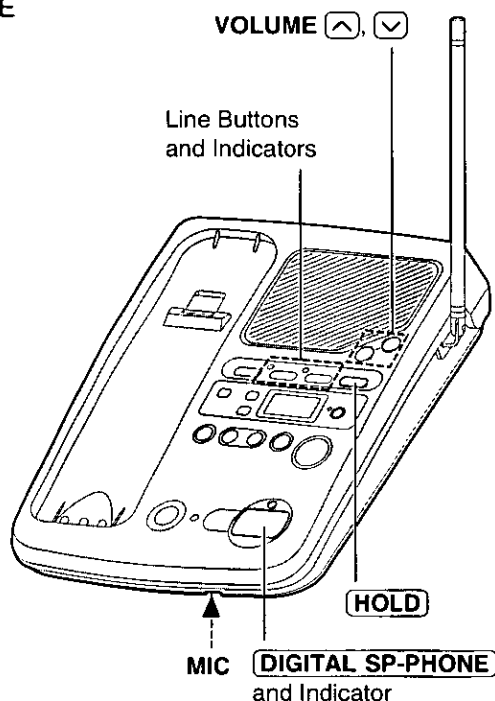

- While using the speakerphone, if the handset is on the base unit, you may switch to it by lifting it up.
- You cannot answer a call using the speakerphone while the answering system is recording a message on the other line. To answer, press **TALK** or press the line button on the handset whose indicator is flashing quickly.

To adjust the speaker volume (8 levels) while talking

To increase, press **VOLUME** . To decrease, press **VOLUME** .

Hands-Free Digital Duplex Speakerphone

The digital duplex speakerphone enhances your telephone conversation.

For best performance, please note the following:

- Use the speakerphone in a quiet room.
- Talk alternately with the caller.
- If the caller complains that your voice is hard to hear, press **VOLUME** to decrease the speaker volume.
- If the other party's voice from the speaker cuts in/out during a conversation, press **VOLUME** to decrease the speaker volume.
- The line indicator shows the line condition (p. 28).

To put a call on hold

Press **HOLD**.

- The DIGITAL SP-PHONE indicator light goes out and the line indicator flashes.
- After 6 minutes, warning tones will sound every 10–15 seconds. After a total of 10 minutes, the call will be disconnected.

To release the hold

Press the line button.

- If another phone is connected on the same line (p. 74), you can also release the hold by lifting its handset.

You may answer a second call on the other line while keeping the present call on hold. See page 37.

Speed Dialer

Storing Phone Numbers in Memory

You can store up to 10 phone numbers in the handset. The dialing buttons (0 to 9) function as memory stations.

The TALK indicator light must be off before programming.

- 1 Press **PROGRAM/2WAY REC**.
 - The TALK indicator flashes.
- 2 Enter a phone number up to 16 digits.
 - If you misdial, press **PROGRAM/2WAY REC** to end storing, then start from step 1.
- 3 Press **AUTO**.
- 4 Press a memory station number (0 to 9).
 - A confirmation tone sounds.*
 - To store other numbers, repeat steps 1 through 4.

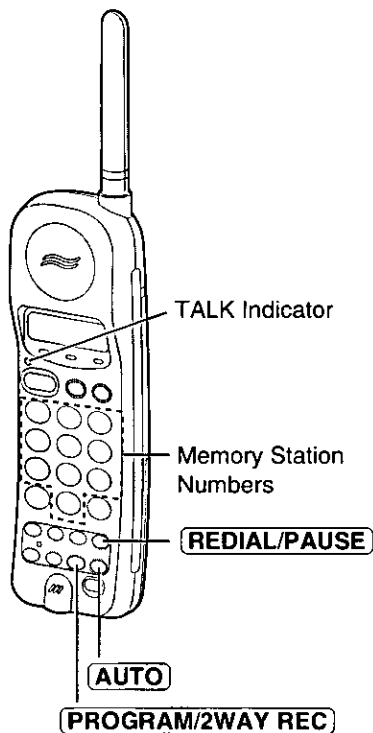

- If a pause is required for dialing, **REDIAL/PAUSE** can be stored in a phone number counting as one digit (p. 43).

*What the confirmation tone means

- 1 beep: The new number is stored.
- 2 beeps: The number is the same as the previously stored one.

To erase a stored number

Press **PROGRAM/2WAY REC** → **AUTO** → the memory station number (0 to 9) for the phone number to be erased.

Dialing a Stored Number

- 1 Press **TALK**.
- 2 Press **AUTO**.
- 3 Press the memory station number (0 to 9).
 - The stored number is dialed.

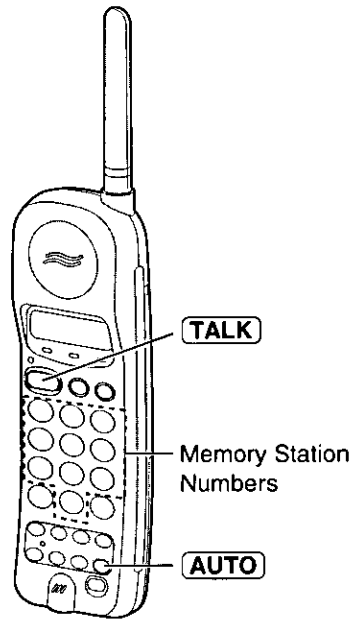

Cordless Telephone

Using the Other Line During a Conversation

While Someone Else is Using a Line (Simultaneous Base/Handset Operation)

The handset and base unit can be used at the same time on separate telephone lines.

To make a call with the handset

- 1** **Ex: If the base unit is using LINE 1**
Press the other line button (LINE 2) on the handset.
 - The LINE 2 indicator lights.

- 2** Dial a telephone number.

- 3** To hang up, press **TALK** or place the handset on the base unit.

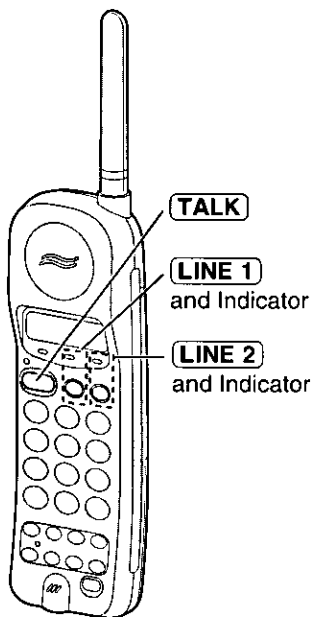



To answer a call with the handset

- 1 **Ex: If the base unit is using LINE 1**
Press the other line button (LINE 2) on the handset.
- 2 To hang up, press **TALK** or place the handset on the base unit.

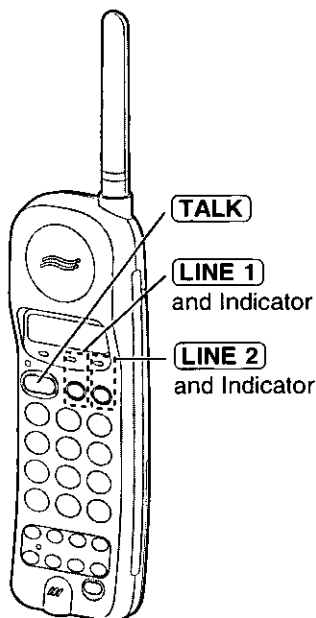

Cordless Telephone

To answer a call with the base unit

- 1 **Ex: If the handset is using LINE 1**
Press the other line button (LINE 2) on the base unit.
- 2 To hang up, press **DIGITAL SP-PHONE**.

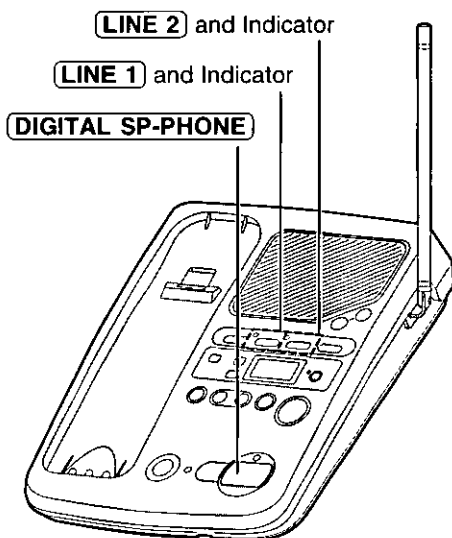

- If another phone is connected on either line, you can also use it while the handset or base unit is using the other line.

► Using the Other Line During a Conversation

While You are Using a Line

During a conversation, if **two tones** sound and the other line indicator flashes quickly, an incoming call is being received on the line. You can answer the second call while holding the first call. You can also make a call without terminating the first call using the handset.

You may delete the **two tones** (incoming call tone) by programming. See page 47.

With the handset

1 Ex: If you are using LINE 1

Press **HOLD/INTERCOM** to put the first call (LINE 1) on hold.

- The LINE 1 indicator flashes.

2 Press the other line button (LINE 2) to make or answer the second call.

- The LINE 2 indicator lights.

3 To return to the first call (LINE 1), press the line button of the first call (LINE 1).

- The second call is terminated.

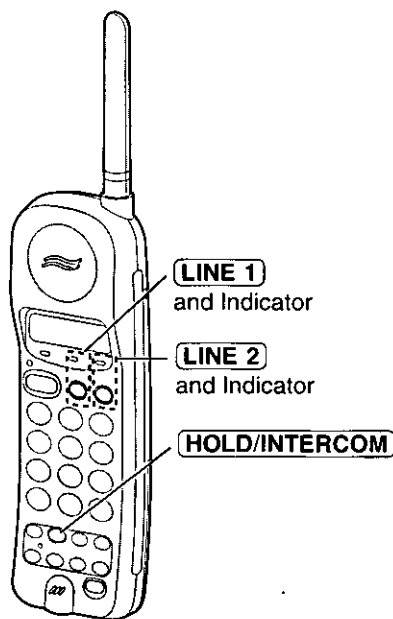

- To hold the second call in step 3, press **HOLD/INTERCOM** before pressing the line button of the first call.

With the base unit

1 **Ex: If you are using LINE 1**
Press **HOLD** to put the first call (LINE 1) on hold.

- The LINE 1 indicator flashes.

2 Press the other line button (LINE 2) to answer the second call.

- The LINE 2 indicator lights.

3 To return to the first call (LINE 1), press the line button of the first call (LINE 1).

- The second call is terminated.

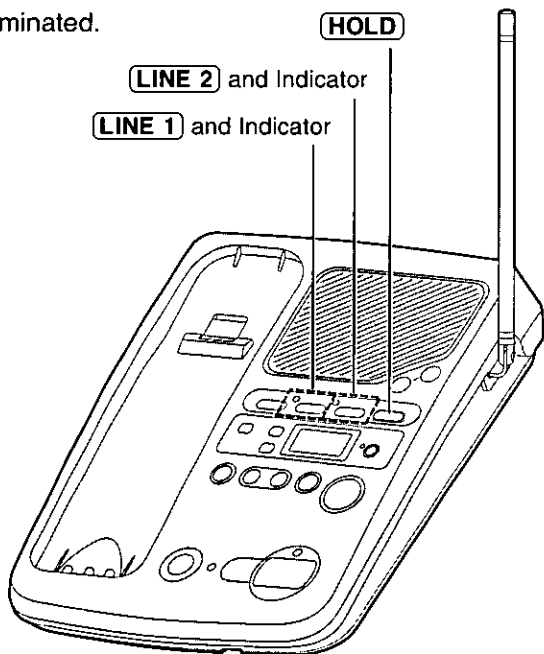

- To hold the second call in step 3, press **HOLD** before pressing the line button of the first call.

Conference Call

While having a conversation on one line, you can make or answer a second call on the other line and then combine both lines together to make a conference call.

With the handset

- 1 Ex: If you are using LINE 1**
Press **(HOLD/INTERCOM)** to put the first call (LINE 1) on hold.
 - The LINE 1 indicator flashes.
- 2** Press the other line button (LINE 2) to make or answer a second call.
 - The LINE 2 indicator lights.
- 3** When the second call is connected, press **(CONF)** to make a conference call.
 - Both line indicators light.

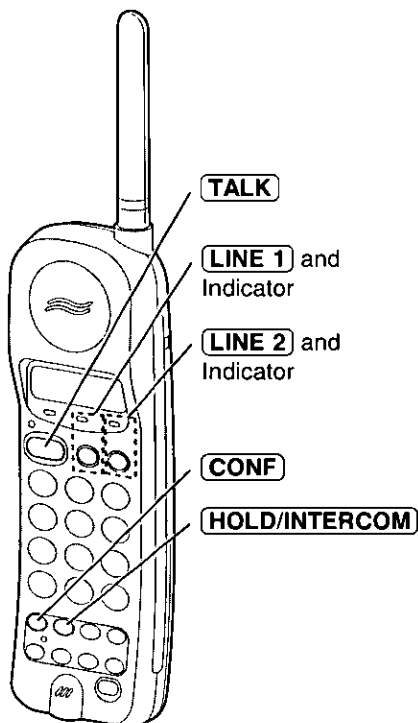

During a conference call:

- To hang up both lines, press **(TALK)**.
- To hang up only one line, press the line button you want to continue talking with.
- To put both lines on hold, press **(HOLD/INTERCOM)**.
To talk with only one caller, press the corresponding line button.
To resume both lines, press **(CONF)**.
- The base unit user can join a conference call on the handset by pressing **(LINE 1)** or **(LINE 2)**.

With the base unit

1 **Ex: If you are using LINE 1**
Press **HOLD** to put the first call (LINE 1) on hold.

- The LINE 1 indicator flashes.

2 Press the other line button (LINE 2) to answer the second call.

- The LINE 2 indicator lights.

3 When the second call is connected, press **CONF** to make a conference call.

- Both line indicators light.

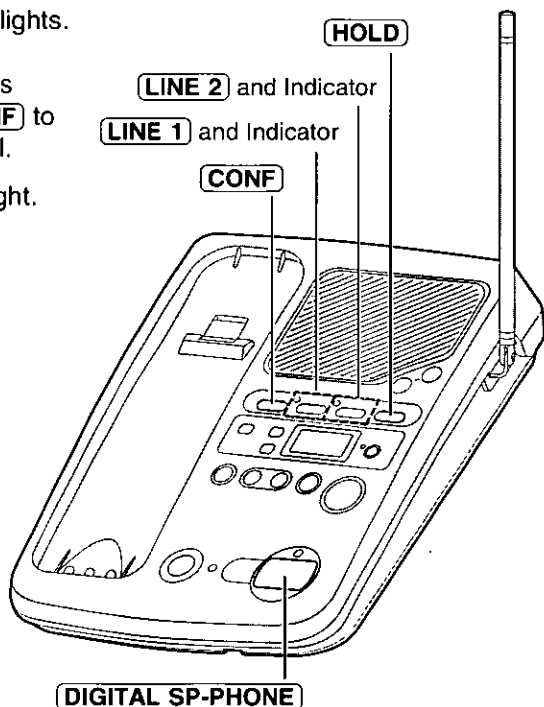

Cordless Telephone

During a conference call:

- To hang up both lines, press **DIGITAL SP-PHONE**.
- To hang up only one line, press the line button you want to continue talking with.
- To put both lines on hold, press **HOLD**.
To talk with only one caller, press the corresponding line button.
To resume both lines, press **CONF**.
- The handset user can join a conference call on the base unit by pressing **LINE 1** or **LINE 2**.

Intercom

A 2-way intercom is available between the handset and the base unit.

Paging the base unit from the handset

- 1** Handset:
Press **HOLD/INTERCOM**. Talk to the paged party after the beeps.
 - The TALK indicator flashes.
- 2** Base unit:
When the other party's voice is heard, answer using the **MIC**.
- 3** Handset:
To end the intercom, press **HOLD/INTERCOM**.
 - The TALK indicator light goes out.

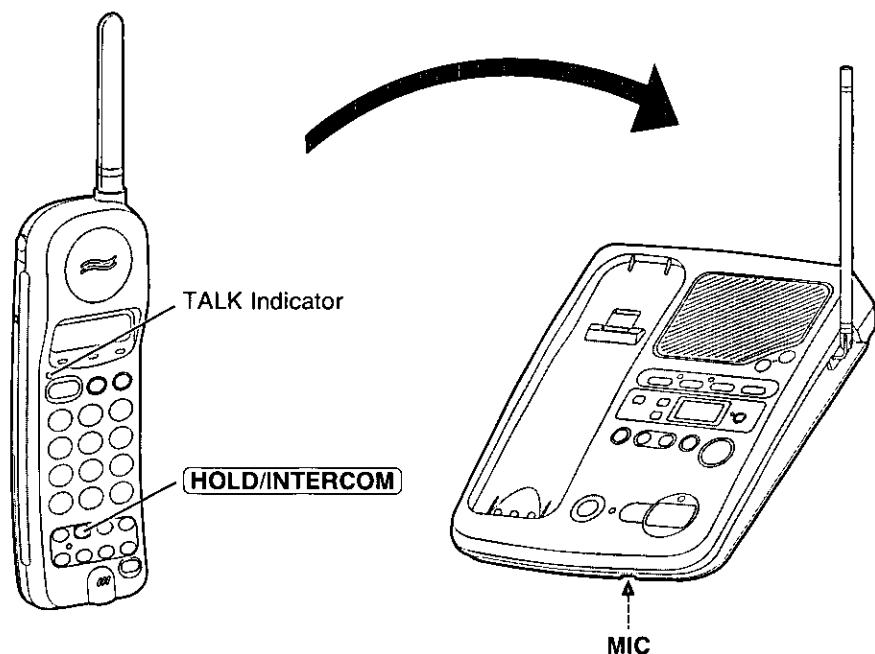



Paging the handset from the base unit (Handset locator)

Using this feature, you can locate the handset, if misplaced.

- 1 Base unit:
Press **LOCATOR/INTERCOM**.
 - The handset beeps for 1 minute.
 - To stop paging, press **LOCATOR/INTERCOM** again.
- 2 Handset:
Press **HOLD/INTERCOM** to answer.
 - The TALK indicator flashes.
- 3 Base unit:
Talk into the **MIC**.
- 4 Handset:
To end the intercom, press **HOLD/INTERCOM**.
 - The TALK indicator light goes out.

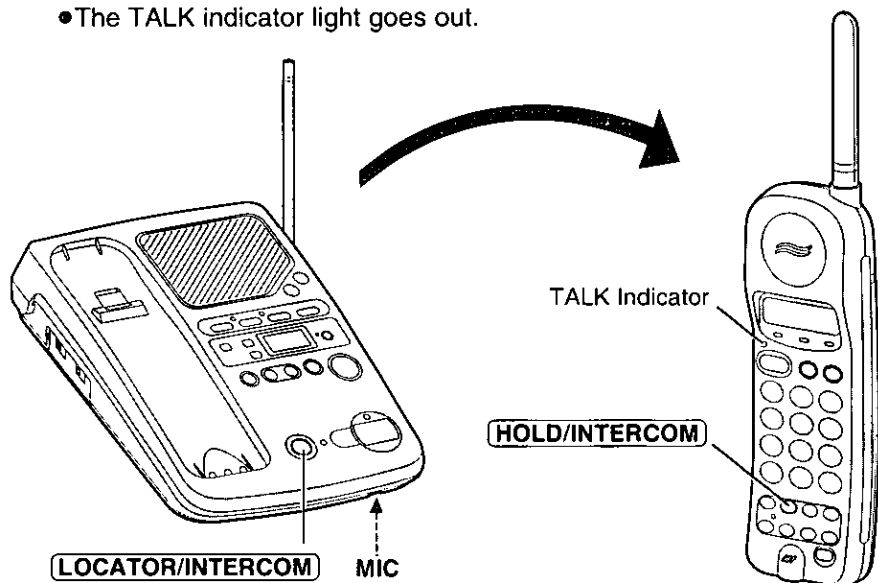

During the intercom:

- Intercom calls can only be ended by the handset.
- If two tones sound, an incoming call has been received.
To answer, press the line button whose indicator is flashing quickly.
The intercom is ended.

Transferring a Call Using the Intercom

The intercom can be used during a call. This feature enables you to transfer the call between the handset and the base unit.

From the handset to the base unit

- 1** Handset:
During a call, press **HOLD/INTERCOM**.
 - The call is put on hold.
- 2** Handset:
Press **HOLD/INTERCOM** again. Talk to the paged party after the beeps.
 - If the base unit user does not answer, press the line button whose indicator is flashing.
- 3** Base unit:
When the paging party's voice is heard, answer using the **MIC**.
- 4** Base unit:
To answer the call, press the line button whose indicator is flashing.
 - The transfer is completed.
 - The handset user can join the conversation by pressing the line button whose indicator light is flashing.

From the base unit to the handset

- 1** Base unit:
During a call, press **LOCATOR/INTERCOM**.
 - The call is put on hold.
 - If the handset user does not answer, press the line button whose indicator is flashing.
- 2** Handset:
Press **HOLD/INTERCOM** to answer the page.
- 3** Handset:
To answer the call, press the line button whose indicator is flashing.
 - The transfer is completed.
 - The base unit user can join the conversation by pressing the line button whose indicator light is flashing.

Special Features

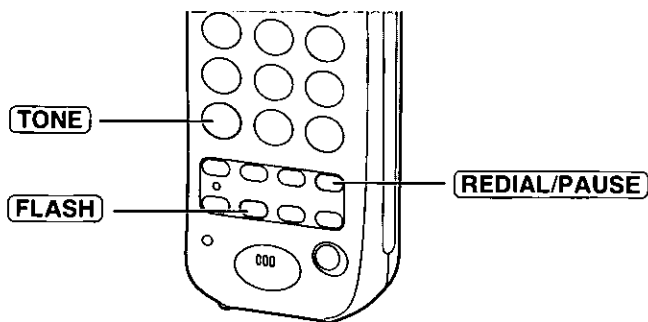

For Call Waiting Service Users

Press **FLASH** briefly if you hear a call-waiting tone while talking.

- The first call is put on hold and you can answer the second call.
- To return to the first caller, press **FLASH** again.

Automatic Security Code Setting

Whenever you place the handset on the base unit, the unit automatically selects one of 65,000 security codes. These codes help prevent the unauthorized use of your telephone line by another cordless telephone.

Temporary Tone Dialing

(For Rotary or Pulse Service Users)

Press **TONE** before entering access numbers which require tone dialing.

- The dialing mode changes to tone. You can enter numbers to access an answering service, electronic banking service, etc. When you hang up, the mode will return to pulse.

How to Use the PAUSE Button

(For Analog PBX Line/Long Distance Service Users)

We recommend you press **REDIAL/PAUSE** if a pause is required for dialing with a PBX or to access a long distance service.

Ex: Line access number **9** (PBX)

9 → **REDIAL/PAUSE** → Phone number

- Pressing **REDIAL/PAUSE** once creates a 3.5 second pause. This prevents misdialing when you redial or dial a stored number.
- Pressing **REDIAL/PAUSE** more than once increases the length of the pause between numbers.

Programmable Functions

Programming Summary for the Cordless Phone

You can program the following functions by using the handset near the base unit. See the noted pages for details.

The TALK and DIGITAL SP-PHONE indicator lights must be off before programming.

Lift the handset, then press **PROGRAM/2WAY REC**.



Press **HOLD/INTERCOM**.



- If an alarm tone sounds, move closer to the base unit, then try again.

To change the line selection, press **1**. (page 45)

To turn the line indicator on/off, press **2**. (page 46)

To set the incoming call tone on/off, press **3**. (page 47)

To change the line mode selection, press **4**. (page 47)



When finished, press **PROGRAM/2WAY REC**.

- A confirmation tone sounds.*

- To cancel during programming, press **PROGRAM/2WAY REC**, then start from the beginning.
- If 6 beeps sound during programming, a wrong key was pressed. Enter the correct number again.

*What the confirmation tone means

1 beep: The new programmed setting or selection is done.

2 beeps: The setting or selection is the same as the previous one.



Line Selection

The unit will automatically select an idle line when you make a call. Also the unit will select the called line when you answer a call.

To change the line selection, program as follows.

1 Press **PROGRAM/2WAY REC**.

- The TALK indicator flashes.

2 Press **HOLD/INTERCOM**.

3 Press **1**.

4 Press **1**, **2**, or **3** to select the desired line selection.

- 1:** LINE 1 will be selected first.
- 2:** LINE 2 will be selected first.
- 3:** An idle line will be selected (LINE 1 has priority) when making a call. The called line is automatically selected when answering a call (factory preset).

5 When finished, press **PROGRAM/2WAY REC**.

- The TALK indicator light goes out.

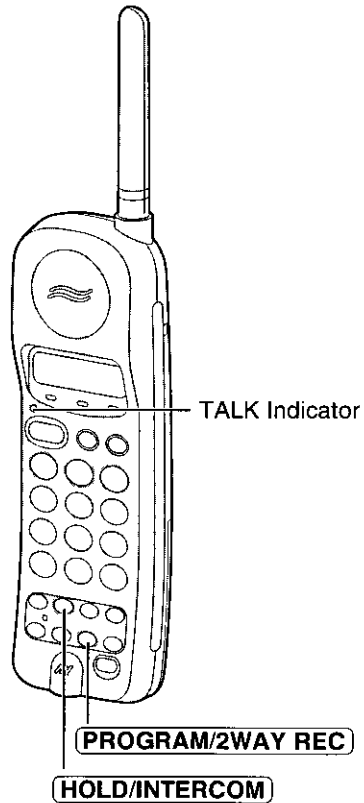

Cordless Telephone

- Any line can be selected manually regardless of the mode selected in step 4 by pressing the line button.

► Programmable Functions

Line Indicator

If you only connect this unit to one single telephone line, the unused line's indicator will continue to flash. To turn off the indicator, set to OFF. Both of the line indicators are preset to ON.

- 1 Press **PROGRAM/2WAY REC**.
 - The TALK indicator flashes.
- 2 Press **HOLD/INTERCOM**.
- 3 Press **2**.
- 4 To select the LINE 1 indicator, press **1**.
To select the LINE 2 indicator, press **2**.
- 5 To deactivate the line indicator, press **2** (OFF).
OR
To activate the line indicator, press **1** (ON).
- 6 When finished, press **PROGRAM/2WAY REC**.
 - The TALK indicator light goes out.

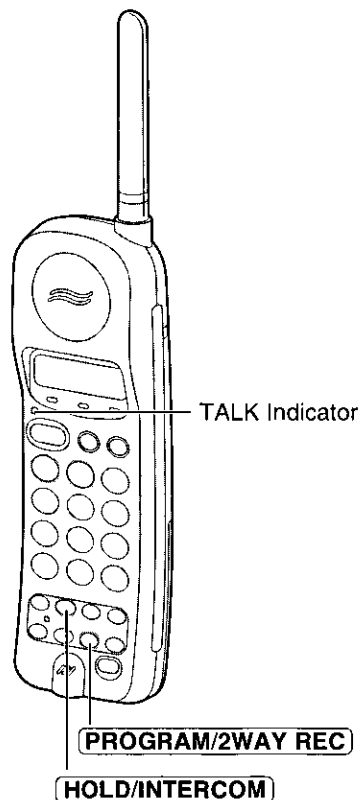

Incoming Call Tone

When a line is being used and another call arrives on the other line, the unit will sound two tones (and the line indicator will flash quickly). This incoming call tone (and flashing indicator on the handset) can be deleted/set as follows:

1. Press **PROGRAM/2WAY REC**.
 2. Press **HOLD/INTERCOM**.
 3. Press **3**.
 4. Press **1**, **2**, or **3**.
 - 1: The incoming call tone will be heard as long as the other line rings. (factory preset)
 - 2: The incoming call tone will only be heard 2 times.
 - 3: The incoming call tone will not be heard.
 5. When finished, press **PROGRAM/2WAY REC**.
- When the RINGER selector(s) is set to OFF, the incoming call tone will not be heard on the base unit.
 - The two tones you hear when a call is received during an intercom call or remote operation with the handset cannot be deleted by programming.

Line Mode Selection

If the line is connected to a low voltage system such as a PBX, set to b. Otherwise, the line indicator will not operate properly. The unit will not ring and you will not hear the incoming call tone. Your phone comes from the factory set to A.

1. Press **PROGRAM/2WAY REC**.
2. Press **HOLD/INTERCOM**.
3. Press **4**.
4. To select the LINE 1 indicator, press **1**.
To select the LINE 2 indicator, press **2**.
5. To set to "b", press **2**.
OR
To set to "A", press **1**.
6. When finished, press **PROGRAM/2WAY REC**.

Automatic Answering Operation

When the unit answers a call, a greeting message is played and the caller's message is recorded.

- The total recording time (including the greeting message) is **about 18 minutes**. If messages are recorded in noisy rooms, the memory time may be shortened up to 5 minutes.
- A maximum of 64 messages (including the greeting message) can be recorded.

Setting the Unit to Answer Calls

Answering a call on LINE 1 and LINE 2

- 1 Press **LINE SELECT** repeatedly until "**LINE1 LINE2**" is displayed.
- 2 Press **ANSWER ON** to turn on the answering system.
 - The indicator lights and "Answer set line 1 and line 2" is heard.

Answering a call on LINE 1 only

- 1 Press **LINE SELECT** repeatedly until "**LINE1**" is displayed.
- 2 Press **ANSWER ON** to turn on the answering system.
 - The indicator lights and "Answer set line 1" is heard.

Answering a call on LINE 2 only

- 1 Press **LINE SELECT** repeatedly until "**LINE 2**" is displayed.
- 2 Press **ANSWER ON** to turn on the answering system.
 - The indicator lights and "Answer set line 2" is heard.

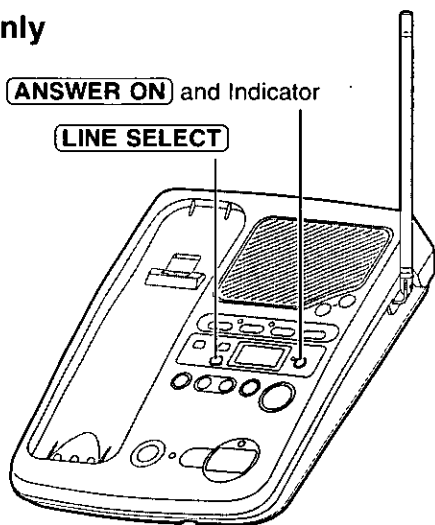

- If another button is pressed between steps 1 and 2, the selected line(s) may not be turned on.
- The unit will announce the remaining recording time if it is less than 5 minutes.
- If you hear "Memory full" and the indicator flashes rapidly, erase some or all of the messages (p. 53).
- You can also turn on the answering system remotely using any other phone (p. 65).

The unit will not answer an incoming call while:

- you are answering the other line with the speakerphone, or
- the answering system is in use (recording a message, playing back a message, etc.).

To let the unit answer the incoming call, you must hang up the first caller or stop using the answering system.

To turn off the answering system

Press **ANSWER ON** to turn the answering system off.

- The indicator light goes out and "Answer off" is heard.

To turn off the answering system on either line when the both lines are turned on

1. Press **LINE SELECT** repeatedly until the line which you want to leave on is displayed.
2. Press **ANSWER ON**.

Monitoring incoming calls

While a call is being recorded, you can monitor it through the speaker.

To monitor incoming calls with the handset, see page 70.

To answer the call, press the line button whose indicator is flashing on the base unit or the handset. The unit will stop recording.

Listening to Messages

You can see the total number of recorded messages on the display. If the ANSWER ON indicator and the line display(s) flash, new messages have been recorded.

Listening to only the new messages

Press **NEW MESSAGE** briefly.

- The unit announces the number of new messages on either or both lines (which you set to record) and plays them back.

Listening to all of the recorded messages

Press and hold **NEW MESSAGE** firmly until a short beep sounds.

- The unit announces the number of messages on either or both lines (which you set to record) and plays them back.

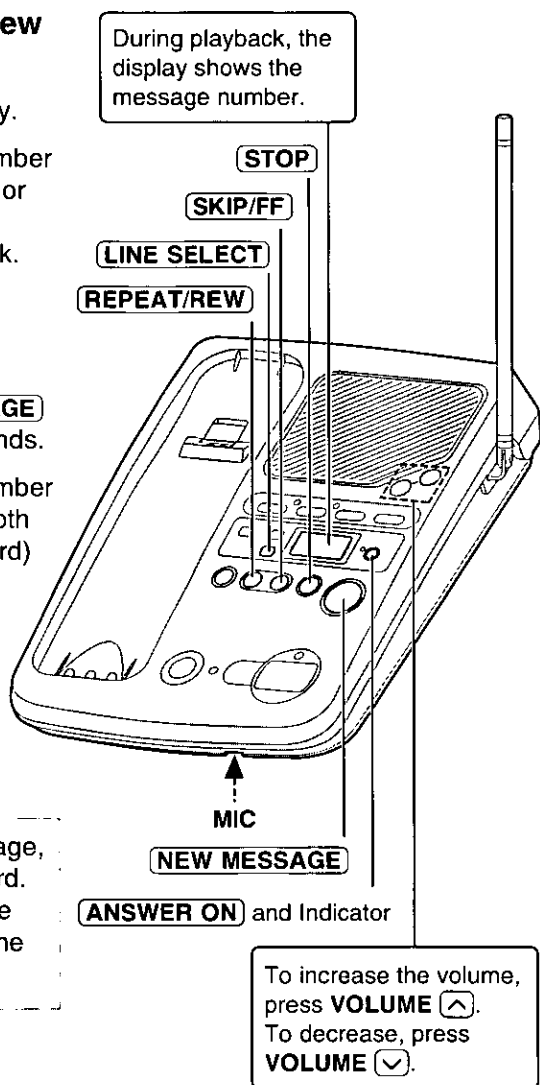

At the end of the last message, "End of final message" is heard. After the announcement, the unit will automatically turn the answering system back on.

When the both lines are set to turn on the answering system:

- The messages are played back in chronological order.
- The corresponding line display will flash when a message on that line is being played.



During playback

<p>To repeat/ rewind the message</p>	<p>To repeat from the beginning of the message Press (REPEAT/REW) briefly. (If you press within 5 seconds of playback, the previous message will be played.)</p> <p>To rewind part of the message Press and hold (REPEAT/REW) until you reach the desired place.</p> <ul style="list-style-type: none">●At the beginning of the message, 3 beeps will sound.
<p>To skip/cue the message</p>	<p>To skip to the next message Press (SKIP/FF) briefly.</p> <p>To cue to part of the message Press and hold (SKIP/FF) until you reach the desired place.</p> <ul style="list-style-type: none">●The message will be heard twice as fast.●At the end of the message, 3 beeps will sound.
<p>To stop the operation</p>	<p>Press (STOP).</p> <ul style="list-style-type: none">●To resume playback, press (NEW MESSAGE). To turn on the answering system, press (ANSWER ON).

Listening to messages on either line when both lines are turned on

1. Press **(LINE SELECT)** repeatedly to select the desired line.
 2. To listen to new messages, press **(NEW MESSAGE)** briefly.
To listen to all of the messages, press and hold **(NEW MESSAGE)** firmly until a short beep sounds.
- The unit will automatically turn the answering system back on for both lines.

Listening to messages on the line which is not turned on

1. Press **(LINE SELECT)** repeatedly to select the desired line.
2. To listen to new messages, press **(NEW MESSAGE)** briefly.
To listen to all of the messages, press and hold **(NEW MESSAGE)** firmly until a short beep sounds.

► Listening to Messages

From the Handset

If someone else is in the room and you want to listen to the recorded messages privately, you can listen to them using the handset.

1 Handset:
Press **SCREEN/PLAYBACK**.

- The number of new messages on either or both lines (which you set to record) is heard on the handset.

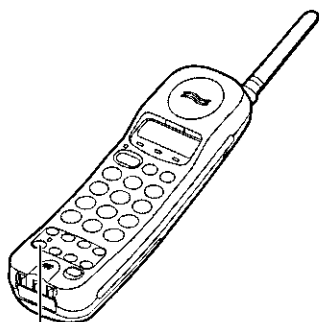

2 Base unit:
To listen to new messages, press **NEW MESSAGE** briefly.
To listen to all of the messages, press and hold **NEW MESSAGE** firmly.

- The messages will be heard on the handset.
- **REPEAT/REW**, **SKIP/FF** and **STOP** are also available during playback (p. 45).



3 When finished, press **SCREEN/PLAYBACK** or place the handset on the base unit.



- You can also listen to messages without using the base unit. See page 66.

Erasing Messages



The unit will announce the remaining recording time after playback, if it is less than 5 minutes. New messages cannot be recorded when:

- “Memory full” is heard.
- “**FULL**” is displayed.
- the ANSWER ON indicator flashes rapidly.

Erase some or all of the messages. We recommend you erase unnecessary messages after each playback.

Erasing a specific message

Press **ERASE** while the message you want to erase is being played.

- The unit erases the message.
- A short beep will sound and the unit will continue to play the next message.

Erasing all of the messages

All of the recorded messages except the greeting message(s) can be erased at one time.

1 Press **LINE SELECT** repeatedly until “**LINE 1 LINE 2**” is displayed.

2 Press **ERASE**.

- “Press ERASE again to erase all messages.” is heard.

3 Within 5 seconds, press **ERASE** again.

- A long beep and “Line 1, no messages Line 2, no messages” are heard.
- The display shows “0” on both lines.

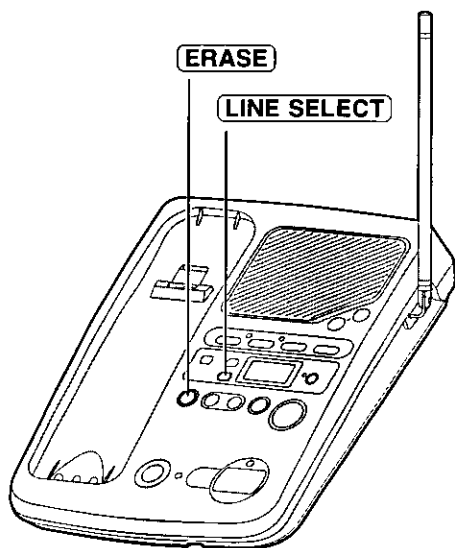

Answering System

► Erasing Messages

Erasing all of the messages on a line

All of the recorded messages on a line, except the greeting message, can be erased at one time.

- 1 Press **LINE SELECT** repeatedly until the desired line display ("**LINE 1**" or "**LINE 2**") appears.
- 2 Press **ERASE**.
 - "Press ERASE again to erase all messages." is heard.
- 3 Within 5 seconds, press **ERASE** again.
 - A long beep and "Line 1, no messages" or "Line 2, no messages" are heard.
 - The display shows "0" on the selected line.

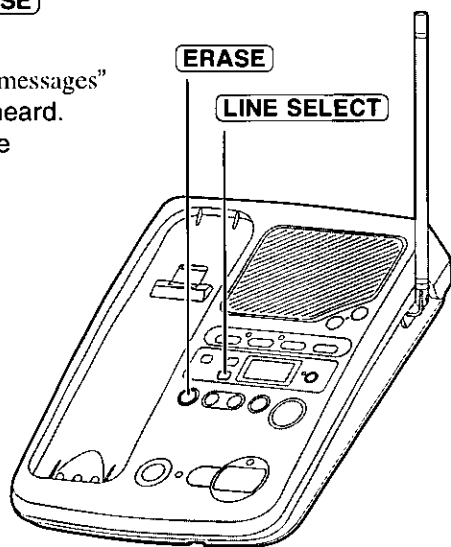

Pager Call



This feature allows you to alert your pager when the unit records an incoming message. You can retrieve the message from a touch tone telephone (p. 58). First store the pager number, then set the unit to call a pager.

The TALK and DIGITAL SP-PHONE indicator lights must be off before programming.

Storing the Pager Number

If you use a 1-800 pager number, see the next page for the storing procedure.

- 1 Press **PROGRAM/2WAY REC**.
 - The TALK indicator flashes.
- 2 Press **SCREEN/PLAYBACK**.
 - The indicator lights.
 - “P” is displayed on the base unit.
- 3 Press **#**.
- 4
 - a) Enter your pager number and then press **REDIAL/PAUSE** twice.* Enter the access code, if required by your pager company, and then press **REDIAL/PAUSE** twice again.*
 - b) Enter the call back number to be displayed on the pager (the telephone number where your unit is connected).
 - c) Press **#** if required by your pager company.
 - If you misdial, press **PROGRAM/2WAY REC** then start from step 1.
 - You can enter a total of 48 digits.
- 5 When finished, press **PROGRAM/2WAY REC**.
 - The indicator lights go out.

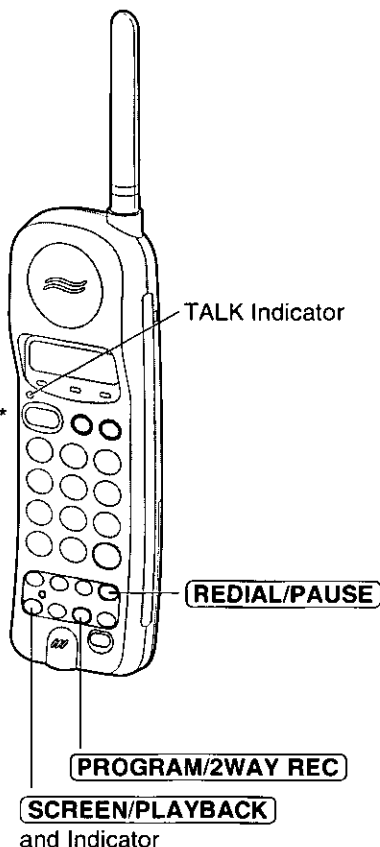

Answering System

*Pager companies require a delay after the pager number and/or the access code is dialed. Contact your pager company regarding the required pause time. Pressing **REDIAL/PAUSE** once creates a 3.5 second delay and counts as one digit.

► Pager Call

Storing the 1-800 pager number

If you use a 1-800 pager number with your PIN code, store the pager number as follows.

- 1 Press **PROGRAM/2WAY REC**.
 - The TALK indicator flashes.
- 2 Press **SCREEN/PLAYBACK**.
 - The indicator lights.
 - “P” is displayed on the base unit.
- 3 Press **#**.
- 4
 - a) Enter the 1-800 pager number and then press **REDIAL/PAUSE** 3 times.*
 - b) Enter the PIN code and then press **REDIAL/PAUSE** twice.*
 - c) Enter the call back number to be displayed on the pager (the number where your unit is connected).
 - d) Press **#** if required by your pager company.
 - If you misdial, press **PROGRAM/2WAY REC** then start from step 1.
 - You can enter a total of 48 digits.
- 5 When finished, press **PROGRAM/2WAY REC**.
 - The indicator lights go out.

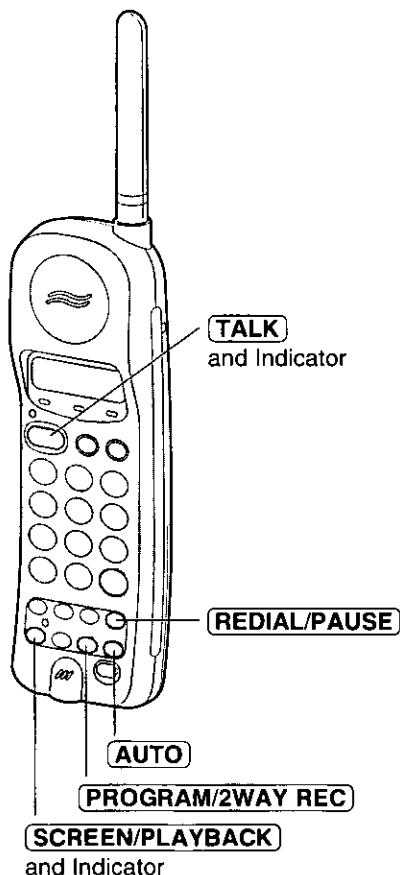

*Pager companies require a delay after the pager number and the PIN code are dialed. Contact your pager company regarding the required pause time. Pressing **REDIAL/PAUSE** once creates a 3.5 second delay and counts as one digit.

•Alphanumeric voice dispatch pager service will not work with this function.

To confirm the stored pager number

Press **TALK** → **AUTO** → **#**.

- The unit dials the stored number.
- If the pager does not beep, check your pager by calling it manually to ensure it works. Then restart from step 1 to store the pager number.

To erase the stored pager number

Press **PROGRAM/2WAY REC** → **SCREEN/PLAYBACK** → **#** → **PROGRAM/2WAY REC**.

Setting the Unit to Call a Pager

1 Press **SCREEN/PLAYBACK**.

- The indicator lights.
- The number of new messages on either or both lines (which you set to record) is heard.

2 Press **3**.

- "**PAGER**" is displayed on the base unit and "on" is heard.
- If 6 beeps sound, the pager number is not stored. Store the number, then try again.

3 When finished, press **SCREEN/PLAYBACK**.

- The indicator light goes out.

To turn off the pager call mode, repeat steps 1 through 3.

- "**PAGER**" will disappear and "off" is heard.
- Each time you press **3** in step 2, "on/off" is heard and the mode will turn on or off.

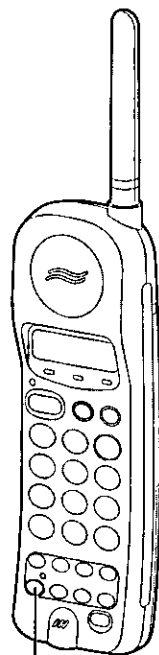

SCREEN/PLAYBACK
and Indicator

- The unit always calls your pager on line 1, even if a message has been recorded on line 2.
- While the unit is dialing to alert your pager, the handset cannot be used.

Remote Operation from a Touch Tone Phone

You can operate the answering system from any touch tone phone. A synthesized voice menu will guide you on how to operate the unit (p. 60).

- To skip the voice menu and operate the unit directly, see page 62.

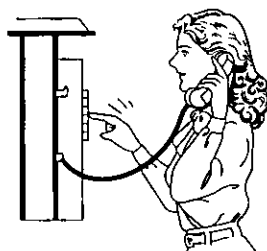

Summary of the remote operation

Call your unit from a touch tone phone.

During/after the greeting message playback, enter your remote code (p. 59).

- The unit announces the line(s) which you set to record and the number of new messages on the line(s).

After 3 seconds, the voice menu will start. Follow the voice menu (p. 60).

- You can only operate the answering system for either or both lines (which you set to record).

Enter the direct remote operation (p. 62).

- You can control the unit by direct commands (p. 63, 64).
- The direct remote operation is available even when the voice menu has started.
- You can also choose the line(s) that you want to operate (p. 62).

To end the remote operation, hang up.

- The messages are saved.



Setting the Remote Code

The remote code prevents unauthorized people from accessing your unit and listening to your messages. Choose any **2-digit number (00–99)**. The factory preset remote code number is “11”. If you do not program your own remote code number, you can use “11”.

The TALK and DIGITAL SP-PHONE indicator lights must be off before programming.

1 Press **PROGRAM/2WAY REC**.
•The TALK indicator flashes.

2 Press **SCREEN/PLAYBACK**.
•The indicator lights.
•“P” is displayed on the base unit.

3 Press **1**.
•The current remote code is displayed.

4 Enter a remote code by using a **2-digit number (00–99)**.
•The entered number is displayed.

5 When finished, press **PROGRAM/2WAY REC**.
•The indicator lights go out.

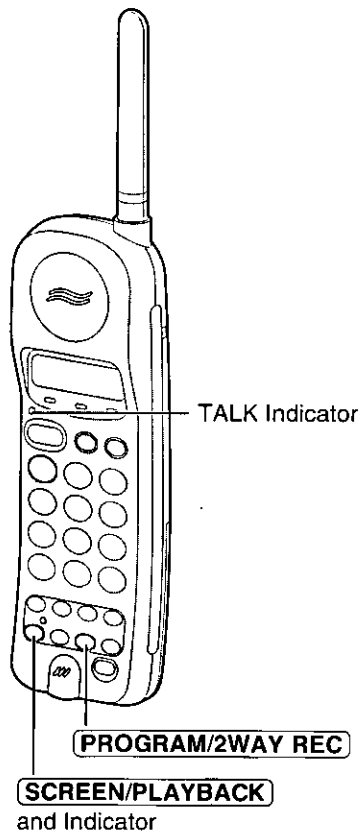

Answering System

•If 6 beeps sound in step 5, you entered a one digit number. Restart from step 1 to program a 2-digit number.

To check the remote code

Press **PROGRAM/2WAY REC** → **SCREEN/PLAYBACK** → **1**.
The current remote code is displayed. When finished, press **PROGRAM/2WAY REC**.

► Remote Operation from a Touch Tone Phone

Voice Menu

You can only operate the answering system for either or both lines (which you set to record) by following the voice menu. The shaded boxes are voice prompts.

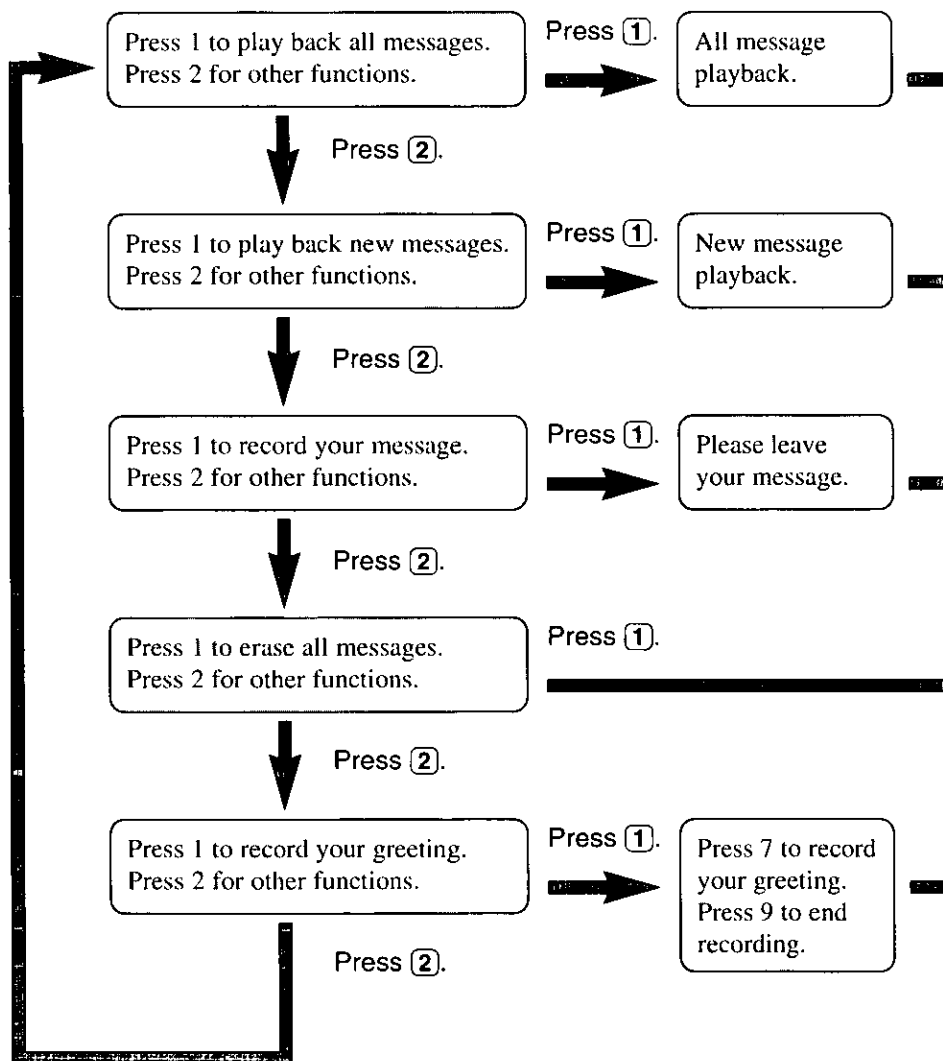



All Message Playback

All of the recorded messages on either or both lines (which you set to record) are played back in chronological order. At the end of the last message, "End of final message" and the remaining recording time are announced.

New Message Playback

Only new messages on either or both lines (which you set to record) are played back in chronological order.

Recording a Memo Message

You can leave a personal message.

1. Talk after you hear "Please leave your message".
2. When you finish recording, hang up.

Erasing All Messages

All of the recorded messages on either or both lines (which you set to record) are erased.

Recording a Greeting Message

You can re-record your greeting message for either or both lines (which you set to record).

1. Press **(7)**.
You hear a voice prompt followed by a long beep.
2. Talk after the long beep.
3. When you finish recording, press **(9)**.
4. Your greeting will be played back for confirmation.

- 3 seconds after playback, the voice menu will start from the beginning.
- If you hear "Memory full" after playback, erase some or all of the messages (p. 63).

➔ Remote Operation from a Touch Tone Phone

Direct Remote Operation

Once you have entered the remote code, you can also control your unit by direct commands instead of using the voice menu. To end the remote operation, hang up anytime.

Summary of the direct remote operation

- 1 Select the desired line(s) after entering your remote code.
If you want to operate the answering system for either or both lines (which you set to record), skip to step 2.
Press **# 1** to select "LINE 1".
Press **# 2** to select "LINE 2".
Press **# 0** to select "LINE 1 and LINE 2".
 - The number of new messages on the selected line(s) is heard.



- 2 Enter the desired direct commands (p. 63, 64).
 - If you do not enter any commands, the voice menu will start (p. 60). You can also follow the voice menu to operate the answering system for the line(s) selected in step 1.
 - If you want to operate another line, repeat from step 1.



- 3 To end the remote operation, hang up.
 - The messages are saved.
 - The unit will turn the answering system back on for the previous set line(s).*

- * If the answering system on for the line(s) programming was changed during the remote operation (p. 64), then the set line(s) will be turned on.
- Do not press **#** for a few seconds. Some long distance services use **#** for other purposes and these services may take priority over the remote operation.



Direct commands

NEW MESSAGE PLAYBACK	4	<ul style="list-style-type: none">• Only new messages on the selected line(s) are played back in chronological order.
ALL MESSAGE PLAYBACK	5	<ul style="list-style-type: none">• All of the messages on the selected line(s) are played back in chronological order.
REPEAT (During playback)	1	<ul style="list-style-type: none">• The current message is repeated.
SKIP (During playback)	2	<ul style="list-style-type: none">• The current message is skipped. The next message is played.
STOP (During playback)	9	<ul style="list-style-type: none">• Playback is stopped temporarily.• To resume playback, press 9 again within 15 seconds, or the voice menu will start.
GREETING MESSAGE RECORDING	You can re-record your greeting message for the selected line(s).	
	7	<ul style="list-style-type: none">• A long beep sounds.
	↓	
	RECORD	<ul style="list-style-type: none">• Talk immediately after the long beep.
	↓	
	9	<ul style="list-style-type: none">• The recording is stopped.• The recorded message is played.
ERASING A SPECIFIC MESSAGE (During playback)	* 4	<ul style="list-style-type: none">• The current message is erased.• A short beep will sound and the next message is played.
ERASING ALL MESSAGES	* 5	<ul style="list-style-type: none">• All of the recorded messages on the selected line(s) are erased.• A long beep and "Line 1, no messages" and/or "Line 2, no messages" are/is heard.

(continued →)

► Remote Operation from a Touch Tone Phone

PAGER CALL
ON/OFF

3

- Each time you press **3**, "on/off" is heard and the mode will turn on/off.
 - If you did not store a pager number, 6 beeps will sound and the mode will not turn on.
-

ANSWERING
SYSTEM OFF

0

- "Answer off" is heard.
 - The answering system for the selected line(s) is turned off.
 - The voice menu will start. To end the remote operation, hang up. To operate another line or both lines, select the line(s) (see below). Then enter the desired direct commands.
-

SELECTING
ANOTHER
LINE

1

- LINE 1 is selected and the number of new messages on LINE 1 is heard.

2

- LINE 2 is selected and the number of new messages on LINE 2 is heard.

0

- LINE 1 and LINE 2 are selected and the number of new messages on both lines is heard.
-

ANSWERING
SYSTEM ON
FOR THE
LINE(S)

1 8

- "Answer set line 1" is heard and the LINE 1 answering system is turned on.

2 8

- "Answer set line 2" is heard and the LINE 2 answering system is turned on.

0 8

- "Answer set line 1 and line 2" is heard and the answering system for both lines is turned on.

- If the LINE 1 (LINE 2) answering system is on and you also want to turn on the LINE 2 (LINE 1) answering system, press **# 0 8**.
-

Turning on the answering system on the line you are calling

Call your unit and wait for 15 rings.

- The unit will answer and the greeting message will be played.
- The answering system on the line which you are calling will turn on.
Hang up or enter the remote code for other options.
- When turning on the answering system using a rotary or pulse service telephone, you cannot enter the remote code for other options.

Skipping the greeting message

After calling your unit, press ***** during the greeting message playback.

- The unit skips the rest of the greeting and callers can start recording their message after the long beep.

Remote Operation with the Handset

You can operate your answering system with the handset.

The announcement and recorded messages can only be heard from the handset.

SCREEN/PLAYBACK
and Indicator

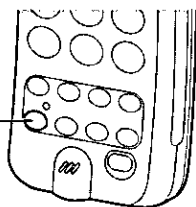

Summary of the remote operation

Press **SCREEN/PLAYBACK**.

- The indicator lights.
- The unit announces the line(s) which you set to record and the number of new messages on the line(s).



- If the SCREEN/PLAYBACK indicator flashes, the answering system is off. To turn it on, press **8**.

1. Select the desired line(s).

If you want to operate the answering system for either or both lines (which you set to record), skip to step 2.

Press **# 1** to select "LINE 1".

Press **# 2** to select "LINE 2".

Press **# 0** to select "LINE 1 and LINE 2".

- The number of new messages on the selected line(s) is heard.

2. Enter the desired direct commands (p. 67–69).

- If you want to operate another line, repeat from step 1.

- If you do not press any command, the voice menu will start (p. 67).
- After the voice menu, all message playback on the selected line(s) will start.



To end the remote operation, press **SCREEN/PLAYBACK**.

- The messages are saved.
- The unit will turn the answering system back on for the previous set line(s).*

* If the answering system on for the line(s) programming was changed during the remote operation (p. 69), then the set line(s) will be turned on.

- If you hear "Memory full" after playback, erase some or all of the messages (p. 67).
- If two tones sound during the remote operation, an incoming call has been received. To answer, press the line button whose indicator is flashing quickly. The remote operation is ended.



Voice menu

If no commands are entered after you press **SCREEN/PLAYBACK**, the unit will start the following voice menu.

"Press 4 to playback new messages. Press 5 to playback all messages."

- You can operate the answering system for the selected line(s) by following the voice menu.
- You can enter direct commands even when the voice menu has started.

Direct commands

NEW MESSAGE PLAYBACK	4	• Only new messages on the selected line(s) are played back in chronological order.
-------------------------	----------	---

ALL MESSAGE PLAYBACK	5	• All of the messages on the selected line(s) are played back in chronological order.
-------------------------	----------	---

REPEAT (During playback)	1	• The current message is repeated.
-----------------------------	----------	------------------------------------

SKIP (During playback)	2	• The current message is skipped. The next message is played.
---------------------------	----------	--

STOP (During playback)	9	• Playback is stopped temporarily. • To resume playback, press 9 again within 15 seconds, or the above voice menu will start.
---------------------------	----------	---

ERASING A SPECIFIC MESSAGE (During playback)	* 4	• The current message is erased. • A short beep will sound and the next message is played.
---	-------------------	---

ERASING ALL MESSAGES	* 5	• All of the recorded messages on the selected line(s) are erased. • A long beep will sound and "Line 1, no messages" and/or "Line 2, no messages" are/is heard.
-------------------------	-------------------	---

(continued →)

► Remote Operation with the Handset

PAGER CALL
ON/OFF

3

- Each time you press **3**, “on/off” is heard and the mode will turn on/off.
 - If you did not store a pager number, 6 beeps will sound and the mode will not turn on.
-

ANSWERING
SYSTEM OFF

0

- “Answer off” is heard and the SCREEN/PLAYBACK indicator flashes.
 - The answering system for the selected line(s) is turned off.
 - The voice menu will start. To end the remote operation, press **SCREEN/PLAYBACK**.
To operate another line or both lines, select the line(s) (see below). Then enter the desired direct commands.
-

ANSWERING
SYSTEM ON

8

- The answering system for the selected line(s) turns on.
 - The SCREEN/PLAYBACK indicator lights.
-

SELECTING
ANOTHER LINE

1

- LINE 1 is selected and the number of new messages on LINE 1 is heard.

2

- LINE 2 is selected and the number of new messages on LINE 2 is heard.

0

- LINE 1 and LINE 2 are selected and the number of new messages on both lines is heard.
-



ANSWERING
SYSTEM ON
FOR THE
LINE(S)

1 8

•“Answer set line 1” is heard and the
LINE 1 answering system is turned
on.

2 8

•“Answer set line 2” is heard and the
LINE 2 answering system is turned
on.

0 8

•“Answer set line 1 and line 2” is heard
and the answering system for both
lines is turned on.

•If the LINE 1 (LINE 2) answering system is on and you also want to turn
on the LINE 2 (LINE 1) answering system, press # 0 8.

► Remote Operation with the Handset

Monitoring incoming calls with the handset

When an incoming message is being recorded, the SCREEN/PLAYBACK indicator flashes slowly.

1. Press **SCREEN/PLAYBACK**.
 - The indicator lights and you can listen to the incoming call.
 - To answer the call, press the line button whose indicator lights. The recording is stopped.
2. When finished monitoring the call, press **SCREEN/PLAYBACK**.

Recording your telephone conversation with the handset

1. During a conversation with the handset, press **PROGRAM/2WAY REC**.
 - The SCREEN/PLAYBACK indicator lights.
 2. Continue your conversation.
 3. When finished recording the conversation, press **PROGRAM/2WAY REC**.
 - The SCREEN/PLAYBACK indicator light goes out.
- The conversation is recorded on the line you were using.
 - If you record a conference call (p. 38), the conversation is saved on LINE 1.

Many states have imposed regulations on the manner in which 2-way telephone conversations may be recorded, so you should inform the other party that the conversation is being recorded. Consult your local telephone company for further information.

Remote Operation Card



OPERATION WITH THE HANDSET

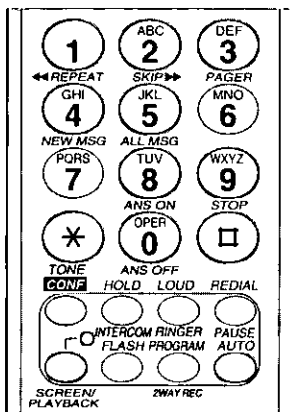

Press **SCREEN/PLAYBACK**.

To select LINE 1, press **# 1**.
To select LINE 2, press **# 2**.
To select LINE 1 and LINE 2,
press **# 0**.

Enter the desired direct
commands (see the reverse side).

To end the remote operation,
press **SCREEN/PLAYBACK**.

- If the **SCREEN/PLAYBACK** indicator flashes when you press **SCREEN/PLAYBACK**, the answering system is off. To turn it on, press **8**.

OPERATION FROM A TOUCH TONE PHONE

Call your unit.

Enter your remote code _____.

After 3 seconds, the voice menu
will start.

Press **1** to use the voice feature.
OR
Press **2** to proceed with other
functions.

To end the remote operation,
hang up.

- When you press a button, press firmly.

Enter the direct remote operation.
1. To select LINE 1, press **# 1**.
To select LINE 2, press **# 2**.
To select LINE 1 and LINE 2,
press **# 0**.

2. Enter the desired direct
commands (see the reverse
side).

- If you want to operate another
line, repeat from step 1.

To end the remote operation,
hang up.

► Remote Operation Card

No.	Direct Command
1	Repeat the message
2	Skip the message
3	Pager call on/off
4	New message playback
5	All message playback
8	Answer on
9	Stop
0	Answer off
*4	Erasing a specific message
*5	Erasing all messages
#1	Selecting LINE 1
#2	Selecting LINE 2
#0	Selecting LINE 1 and LINE 2
#18	Answer on for LINE 1
#28	Answer on for LINE 2
#08	Answer on for both lines

No.	Direct Command
1	Repeat the message
2	Skip the message
3	Pager call on/off
4	New message playback
5	All message playback
7	Recording your greeting
9	Stop
0	Answer off
*	Greeting message skip
*4	Erasing a specific message
*5	Erasing all messages
#1	Selecting LINE 1
#2	Selecting LINE 2
#0	Selecting LINE 1 and LINE 2

● **To monitor incoming calls:**
When the SCREEN/PLAYBACK indicator flashes slowly, press **SCREEN/PLAYBACK**. When finished, press **SCREEN/PLAYBACK** again. To answer the call, press the line button whose indicator lights.

● **To record a telephone conversation:**
Press **PROGRAM/2WAY REC**. When finished, press **PROGRAM/2WAY REC** again.

No.	Direct Command
#18	Answer on for LINE 1
#28	Answer on for LINE 2
#08	Answer on for both lines

● **To turn on the answering system on the line you are calling:**
Call your unit and wait for 15 rings. The unit will answer, then hang up.

Battery Replacement

If the RECHARGE indicator flashes after being fully charged, replace the battery with a new Panasonic P-P501 (KX-A36) battery. To order, call 1-800-332-5368. To prevent memory loss, replace within 5 minutes.

- 1 Remove the cover by sliding it while pressing the arrow.

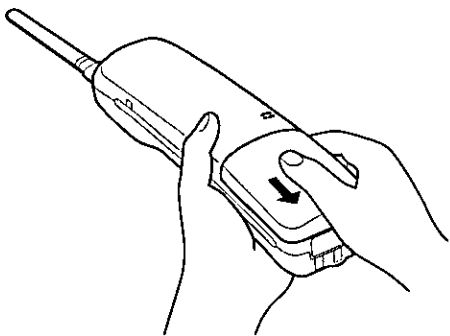

- 2 Replace the battery, then close the cover.

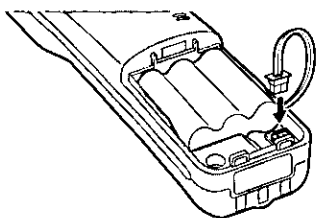

- 3 Be sure to charge the new battery for about 4 hours.

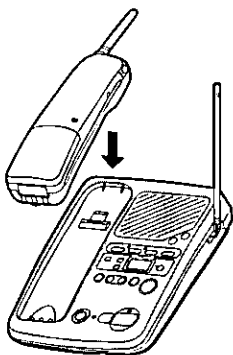

Attention:

The product you have purchased is powered by a nickel cadmium battery which is recyclable. At the end of its useful life, under various state and local laws, it is illegal to dispose of this battery into your municipal waste stream. Please call 1-800-8-BATTERY for information on how to recycle this battery.



Adding Another Phone

This unit will not function during a power failure. To connect a standard telephone on the same line, use the Panasonic T-adaptor KX-J66. To order, call 1-800-332-5368.

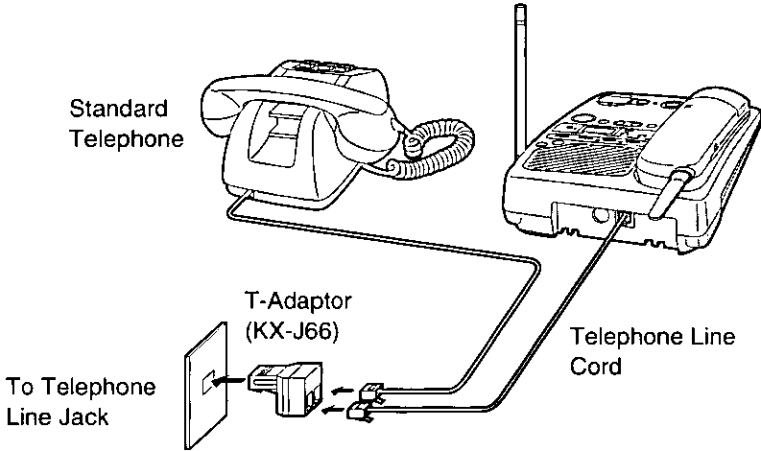

Before Requesting Help



Cordless Telephone

Problem	Remedy
An alarm tone sounds when you press TALK , LINE 1 , LINE 2 , SCREEN/PLAYBACK or HOLD/INTERCOM on the handset.	<ul style="list-style-type: none">• You are too far from the base unit. Move closer and try again.• Place the handset on the base unit and try again.• Plug in the AC adaptor.• Raise the base unit antenna.
Static, sound cuts in/out, fades. Interference from other electrical units.	<ul style="list-style-type: none">• Locate the handset and the base unit away from other electrical appliances (p. 3).• Move closer to the base unit.• Raise the base unit antenna.• Press CH to select a clearer channel.
The handset does not ring.	<ul style="list-style-type: none">• The ringer volume is set to OFF. Press LOUD/RINGER briefly while the TALK indicator light is off (p. 16).
The base unit does not ring.	<ul style="list-style-type: none">• The RINGER selectors are set to OFF. Set to HIGH or LOW (p. 16).
Both the handset and the base unit do not ring.	<ul style="list-style-type: none">• When the line is connected to a low voltage system such as a PBX, the unit will not ring. Set the line mode to b (p. 47).
You cannot make a call with the handset.	<ul style="list-style-type: none">• While dialing with the handset, the base unit user pressed HOLD on the other line. This may interrupt the dialing. Press TALK to hang up and dial again.
You cannot answer a call with the base unit.	<ul style="list-style-type: none">• When the answering system is recording a message on one line, you cannot answer a call with the base unit on the other line. To answer the call, press the line button on the handset whose indicator is flashing quickly.

► Before Requesting Help

Problem	Remedy
You cannot have a conversation using the handset.	<ul style="list-style-type: none">◦ When the optional headset is plugged into the handset, you must use the headset (p. 19) to talk with the caller. To have a normal cordless phone conversation, disconnect the optional headset.
You cannot have a conversation using the optional headset.	<ul style="list-style-type: none">◦ Make sure that the optional headset is plugged into the headset jack properly (p. 19).
You cannot store a phone number in memory.	<ul style="list-style-type: none">◦ You cannot store a number while the unit is in the talk, hold or intercom mode.◦ Do not pause for over 30 seconds while storing.
While storing a phone number, the unit starts to ring.	<ul style="list-style-type: none">◦ To answer the call, press the line button whose indicator is flashing quickly. The program will be canceled. Store the number again.
During an outside call, two tones sound and the other line indicator flashes quickly.	<ul style="list-style-type: none">◦ Someone is calling you on the other line. To answer, press HOLD/INTERCOM or HOLD to put the current call on hold. Then press the line button whose indicator is flashing quickly (p. 36, 37).
LOCATOR/INTERCOM does not function.	<ul style="list-style-type: none">◦ The handset is too far from the base unit or is engaged in an outside call.
REDIAL/PAUSE does not function properly.	<ul style="list-style-type: none">◦ It will redial the last number dialed if pressed at the outset of a call (p. 27). If another number has been dialed first, it will operate as a pause button (p. 43).



Answering System

Problem	Remedy
The answering system is on, but incoming messages are not recorded.	<ul style="list-style-type: none">◦The recording time is set to “greeting only”. Select “1 minute” or “unlimited” (p. 24).◦Memory is full. Erase some or all of the messages (p. 53).
“ FULL ” is displayed and the ANSWER ON indicator flashes rapidly, and no new messages are recorded.	<ul style="list-style-type: none">◦Memory is full. Erase some or all of the messages (p. 53). If “FULL” is still displayed and the ANSWER ON indicator flashes rapidly, erase your greeting message and re-record a shorter greeting (p. 20, 21).
Some incoming messages have not been recorded completely.	<ul style="list-style-type: none">◦Set the CPC function to “b” (p. 26).
You cannot operate the answering system at the base unit.	<ul style="list-style-type: none">◦The handset user is operating the answering system. Wait until the IN USE/CHARGE indicator light goes out.
You cannot operate the answering system from a touch tone phone.	<ul style="list-style-type: none">◦Be sure to enter the correct remote code.◦The answering system may not respond if the tones are too short to activate the unit. Press each button firmly.◦The answering system is off. Turn it on (p. 65).
You cannot operate the answering system with the handset by pressing SCREEN/PLAYBACK .	<ul style="list-style-type: none">◦Someone is operating the answering system.◦You are too far from the base unit. Move closer to the base unit.◦The unit is recording a message. To answer the call, press the line button whose indicator lights.

► Before Requesting Help

Problem	Remedy
You cannot record your telephone conversation with the handset.	<ul style="list-style-type: none">• The conversation cannot be recorded when:<ul style="list-style-type: none">—the base unit user is answering a call on the other line, or—the answering system is in use (recording a message, playing back a message, etc.), or—the base unit user joins the conversation.

General

Problem	Remedy
The unit does not work.	<ul style="list-style-type: none">● Check the settings (p. 11–15).● Charge the battery fully (p. 14).● Clean the charge contacts and charge again (p. 14).● Install the battery properly (p. 73).● Place the handset on the base unit and unplug the AC adaptor to reset. Plug in, then try again.● Re-insert the handset battery within 5 minutes to avoid memory loss and place the handset on the base unit. Then try again.
The line indicators do not work properly.	<ul style="list-style-type: none">● Check the settings (p. 11–15).● See page 46 for proper operation of the line indicators.● The line mode selection is incorrect. See page 47.
You cannot program items such as the time/day adjustment (p. 22, 44).	<ul style="list-style-type: none">● Programming is not available while the unit is in the talk, speakerphone, hold or intercom mode.● Move closer to the base unit.
The RECHARGE indicator flashes or the unit beeps intermittently.	<ul style="list-style-type: none">● Charge the battery fully (p. 14).
You charged the battery fully, but the RECHARGE indicator flashes.	<ul style="list-style-type: none">● Clean the charge contacts and charge again (p. 14).● Install a new battery (p. 73).
The IN USE/CHARGE indicator light never goes out while charging.	<ul style="list-style-type: none">● This is normal.
If you cannot solve your problem.	<ul style="list-style-type: none">● Call our customer call center at 1-800-211-PANA(7262).

Important Safety Instructions

When using this unit, basic safety precautions should always be followed to reduce the risk of fire, electric shock, or personal injury.

1. Read and understand all instructions.
2. Follow all warnings and instructions marked on this unit.
3. Unplug this unit from AC outlets before cleaning. Do not use liquid or aerosol cleaners. Use a damp cloth for cleaning.
4. Do not use this unit near water, for example, near a bathtub, washbowl, kitchen sink, or the like.
5. Place this unit securely on a stable surface. Serious damage and/or injury may result if the unit falls.
6. Do not cover slots and openings on the unit. They are provided for ventilation and protection against overheating. Never place the unit near radiators, or in a place where proper ventilation is not provided.
7. Use only the power source marked on the unit. If you are not sure of the type of power supplied to your home, consult your dealer or local power company.
8. Do not place objects on the power cord. Install the unit where no one can step or trip on the cord.
9. Do not overload wall outlets and extension cords. This can result in the risk of fire or electric shock.
10. Never push any objects through slots in this unit. This may result in the risk of fire or electric shock. Never spill any liquid on the unit.
11. To reduce the risk of electric shock, do not disassemble this unit. Take the unit to an authorized servicer when service is required. Opening or removing covers may expose you to dangerous voltages or other risks. Incorrect reassembly can cause electric shock when the unit is subsequently used.
12. Unplug this unit from the wall outlet and refer servicing to an authorized servicer when the following conditions occur:
 - A. When the power supply cord or plug is damaged or frayed.
 - B. If liquid has been spilled into the unit.
 - C. If the unit has been exposed to rain or water.
 - D. If the unit does not work normally by following the operating instructions. Adjust only controls covered by the operating instructions. Improper adjustment may require extensive work by an authorized servicer.
 - E. If the unit has been dropped or physically damaged.
 - F. If the unit exhibits a distinct change in performance.
13. During thunderstorms, avoid using telephones except cordless types. There may be a remote risk of an electric shock from lightning.
14. Do not use this unit to report a gas leak, when in the vicinity of the leak.

SAVE THESE INSTRUCTIONS

CAUTION:

To reduce the risk of fire or injury to persons, read and follow these instructions.

1. Use only the battery(ies) specified.
2. Do not dispose of the battery(ies) in a fire. They may explode. Check with local waste management codes for special disposal instructions.
3. Do not open or mutilate the battery(ies). Released electrolyte is corrosive and may cause burns or injury to the eyes or skin. The electrolyte may be toxic if swallowed.
4. Exercise care in handling batteries in order not to short the battery to conductive materials such as rings, bracelets, and keys. The battery and/or conductor may overheat and cause burns.
5. Charge the battery(ies) provided with or identified for use with this product only in accordance with the instructions and limitations specified in this manual.

WARNING:

TO PREVENT FIRE OR SHOCK HAZARD, DO NOT EXPOSE THIS PRODUCT TO RAIN OR ANY TYPE OF MOISTURE.

FCC and Other Information

If requested by the telephone company, inform them as follows:

FCC Registration No.(found on the bottom of the unit)

Ringer Equivalence0.3B

The particular telephone lines to which the equipment is connected.

This unit must not be connected to a coin operated line.

If you are on a party line, check with your local telephone company.

Ringer Equivalence No. (REN):

The REN is useful in determining the quantity of devices you may connect to your telephone line and still have all of those devices ring when your telephone number is called. In most, but not all areas, the sum of the REN's of all devices connected to one line should not exceed five (5.0). To be certain of the number of devices you may connect to your line, as determined by the REN, you should contact your local telephone company to determine the maximum REN for your calling area.

In the event terminal equipment causes harm to the telephone network, the telephone company should notify the customer, if possible, that service may be stopped.

However, where prior notice is impractical, the company may temporarily cease service providing that they:

- (a) Promptly notify the customer.
- (b) Give the customer an opportunity to correct the problem with their equipment.
- (c) Inform the customer of the right to bring a complaint to the Federal Communication Commission pursuant to procedures set out in FCC Rules and Regulations Subpart E of Part 68.

The Telephone Company may make changes in its communications facilities, equipment, operations or procedures, where such action is reasonably required in the operation of its business and is not inconsistent with the rules and regulations in FCC Part 68.

If such changes can be reasonably expected to render any customer terminal equipment incompatible with telephone company communications facilities, or require modification or alteration of such terminal equipment, or otherwise materially affect its use or performance, the customer shall be given adequate notice in writing, to allow the customer an opportunity to maintain uninterrupted service.

When programming emergency numbers and/or making test calls to emergency numbers:

1. Remain on the line and briefly explain to the dispatcher the reason for the call before hanging up.
2. Perform such activities in the off-peak hours, such as early morning hours or late evenings.

This device complies with Part 15 of the FCC Rules. Operation is subject to the following two conditions: (1) This device may not cause harmful interference, and (2) this device must accept any interference received, including interference that may cause undesired operation.

Privacy of communications may not be ensured when using this phone.

CAUTION:

Any changes or modifications not expressly approved by the party responsible for compliance could void the user's authority to operate this device.

Note:

This equipment has been tested and found to comply with the limits for a Class B digital device, pursuant to Part 15 of the FCC Rules. These limits are designed to provide reasonable protection against harmful interference in a residential installation. This equipment generates, uses, and can radiate radio frequency energy and, if not installed and used in accordance with the instructions, may cause harmful interference to radio communications. However, there is no guarantee that interference will not occur in a particular installation. If this equipment does cause harmful interference to radio or television reception, which can be determined by turning the equipment off and on, the user is encouraged to try to correct the interference by one or more of the following measures:

- Reorient or relocate the receiving antenna.
- Increase the separation between the equipment and receiver.
- Connect the equipment into an outlet on a circuit different from that to which the receiver is connected.
- Consult the dealer or an experienced radio/TV technician for help.

Some cordless telephones operate at frequencies that may cause interference to nearby TVs and VCRs. To minimize or prevent such interference, the base of the cordless telephone should not be placed near or on top of a TV or VCR. If interference is experienced, move the cordless telephone further away from the TV or VCR. This will often reduce or eliminate interference.

- **Environment**—do not place the unit in room where the temperature is less than 5°C (41°F) or greater than 40°C (104°F). Allow 10 cm (4") clearance around the unit for proper ventilation. Avoid excessive smoke, dust, mechanical vibration, shock, or direct sunlight.
- **Routine care**—wipe the unit with a soft cloth. Do not use benzine, thinner, or any abrasive powder. When you leave the unit unused for a long period of time, unplug the AC adaptor from the outlet.
- **If there is any trouble**—disconnect the unit from the telephone line and connect a known working phone. If the known working phone operates properly, have your unit repaired by one of the authorized Panasonic Factory Service Centers. If the known working phone does not operate properly, consult with your telephone company.

For product service

- Panasonic Servicenters are listed in the servicenter directory.
- Call 1-800-211-PANA(7262) for the location of an authorized servicenter.

When you ship the product

- Carefully pack your unit, preferably in the original carton.
- Attach a letter, detailing the symptom, to the outside of the carton.

Symptom _____

- Send the unit to an authorized servicenter, prepaid and adequately insured.
- Do not send your unit to the Panasonic Consumer Electronics Company listed below or to executive or regional sales offices. These locations do not repair consumer products.

- This cordless telephone is designed for use in the United States of America. Sale or use of this product in other countries may violate local laws.
- Ce téléphone sans fil est conçu pour être utilisé aux États-Unis d'Amérique. La vente ou l'emploi de cet appareil dans certains autres pays peut constituer une infraction à la législation locale.
- Este teléfono sin cordón fue elaborado para uso en los Estados Unidos de América. La venta o el empleo de este producto en ciertos países puede constituir violación de la legislación local.
- このコードレス電話機は、日本国外での使用を目的として設計されており、日本国内での使用は法律違反となります。従って、当社では日本国内においては原則として修理などのサービスは致しかねます。

Panasonic Consumer Electronics Company,
Division of Matsushita Electric Corporation of America
One Panasonic Way, Secaucus, New Jersey 07094

Panasonic Sales Company,
Division of Matsushita Electric of Puerto Rico, Inc.
Ave. 65 de Infantería, Km. 9.5, San Gabriel Industrial Park
Carolina, Puerto Rico 00985