

# Panasonic

2.4 GHz Digital Cordless Phone

## Operating Instructions

Model No. **KX-TG2216FV**  
**KX-TG2216RV**  
**KX-TG2216SV**

Pulse-or-tone dialing capability



KX-TG2216FV

Caller ID Compatible

**PLEASE READ BEFORE USE AND SAVE.**

**Charge the battery for about 6 hours before initial use.**

**Panasonic World Wide Web address: <http://www.panasonic.com>**  
for customers in the USA or Puerto Rico

Preparation

Basic Operation

Advanced Operation

Useful Information



**Thank you for purchasing your new Panasonic cordless telephone.**

Please read IMPORTANT SAFETY INSTRUCTIONS on page 46 before use. Read and understand all instructions.

Caller ID, Call Waiting and Voice Mail Service, where available, are telephone company services. After subscribing to Caller ID, this phone will display a caller's name and phone number. Call Waiting Caller ID, which displays a second caller's name and phone number while the user is on another call, requires a subscription to both Caller ID and Call Waiting. After subscribing to Voice Mail Service, this phone's VM indicator will flash when there are new messages left in the voice mail box at phone company.

**Attach your purchase receipt here.**

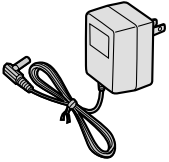
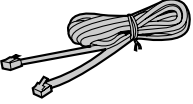
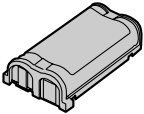
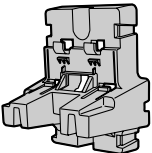
**Accessories (included)** For extra orders, call 1-800-332-5368.

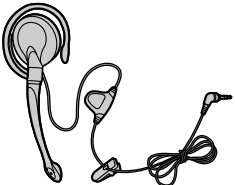
<p><input type="checkbox"/> AC Adaptor (p. 8) Order No. PQLV19Z (PQLV19)</p>  <p>one</p>	<p><input type="checkbox"/> Telephone Line Cord (p. 8) Order No. PQJA10075Z</p>  <p>one</p>	<p><input type="checkbox"/> Battery (p. 9) Order No. HHR-P513</p>  <p>one</p>
<p><input type="checkbox"/> Wall Mounting Adaptor (p. 38) Order No. PQKL10057Z1</p>  <p>one</p>	<p><input type="checkbox"/> Belt Clip (p. 40) Order No. PQKE10367Z1 (Red) PQKE10367Z2 (Blue, Silver)</p>  <p>one</p>	<p><input type="checkbox"/> Headset (p. 40) Order No. RP-TCA91P1-A (Blue) RP-TCA91P1-R (Red) RP-TCA91P1-S (Silver)</p>  <p>one</p>

# For Best Performance

## Battery Charge

A rechargeable Nickel-Metal Hydride (Ni-MH) battery powers the handset. Install the battery in the handset and charge the battery for about **6 hours** before initial use (p. 9).

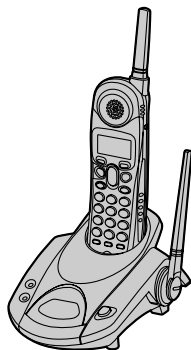

## Base Unit Location/Noise

Calls are transmitted between the base unit and the handset using wireless radio waves. **For maximum distance and noise-free operation**, the recommended base unit location is:

Away from electrical appliances such as a TV, personal computer or another cordless phone.

In a HIGH and CENTRAL location with no obstructions such as walls.

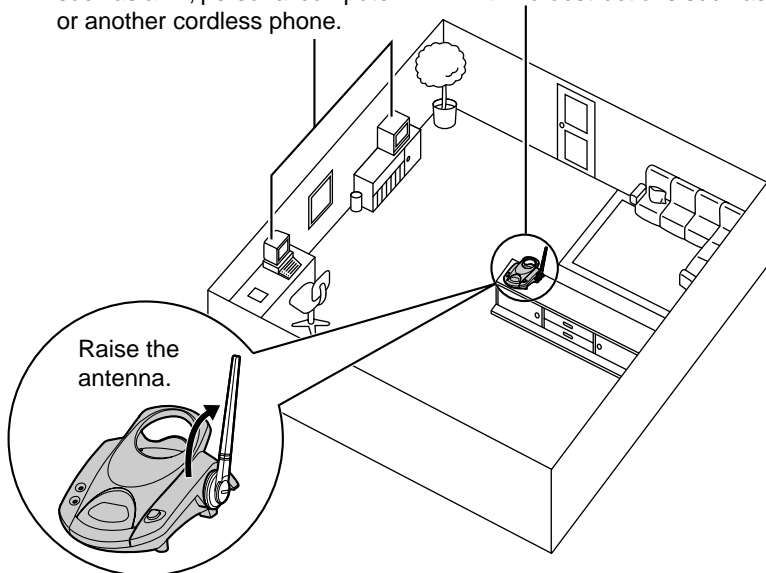

### Note:

- If you use the handset near a microwave oven which is being used, noise may be heard from the receiver or the speaker. Move away from the microwave oven and closer to the base unit.
- If you use the handset near another cordless phone, noise may be heard. Move away from the other cordless phone and closer to your base unit.

# Contents

---

## *Preparation*

<b>Location of Controls</b> .....	<b>6</b>
<b>Settings</b> .....	<b>8</b>
Connections .....	8
Installing the Battery in the Handset .....	9
Battery Charge .....	9
<b>Programmable Functions</b> .....	<b>11</b>
Programming Guidelines .....	11
Function Menu Table .....	12
Display Language .....	13
Dialing Mode .....	13
Voice Enhancer Technology .....	14
Auto Talk .....	15
LCD Contrast .....	15
Ringer Volume .....	16
Ringer Tone .....	17
Line Mode .....	17

## *Basic Operation*

<b>Making Calls</b> .....	<b>18</b>
<b>Answering Calls</b> .....	<b>20</b>
<b>Caller ID Service</b> .....	<b>21</b>
<b>Using the Caller List</b> .....	<b>22</b>
Viewing the Caller List .....	22
Calling Back from the Caller List .....	23
Editing the Caller's Phone Number .....	24
Caller ID Number Auto Edit Feature .....	25
Storing Caller Information in the Phone Book .....	26
Erasing Caller Information .....	27

## *Advanced Operation*

<b>Phone Book</b> .....	<b>28</b>
Storing Names and Numbers .....	28
Dialing from the Phone Book .....	30
Editing an Item in the Phone Book .....	31
Erasing an Item in the Phone Book .....	31
<b>Voice Mail Service</b> .....	<b>32</b>
Storing a Voice Mail Access Number .....	32
Setting Voice Mail (VM) Tone Detection .....	33
Listening to Voice Mail Messages .....	34
<b>Special Features</b> .....	<b>35</b>
Automatic Security Code Setting .....	35
Handset Locator .....	35
Temporary Tone Dialing (For Rotary or Pulse Service Users) .....	35
Muting Your Conversation .....	35
For Call Waiting Service Users .....	36
Using the PAUSE Key (For PBX Line/Long Distance Calls) .....	36
FLASH Button .....	37

## *Useful Information*

<b>Wall Mounting</b> .....	<b>38</b>
<b>Belt Clip</b> .....	<b>40</b>
<b>Headset</b> .....	<b>40</b>
<b>Direct Commands</b> .....	<b>42</b>
<b>Troubleshooting</b> .....	<b>43</b>
<b>Important Safety Instructions</b> .....	<b>46</b>
<b>FCC and Other Information</b> .....	<b>48</b>
<b>Index</b> .....	<b>51</b>
<b>Warranty</b> .....	<b>53</b>
<b>Specifications</b> .....	<b>55</b>

# Location of Controls

## Base unit

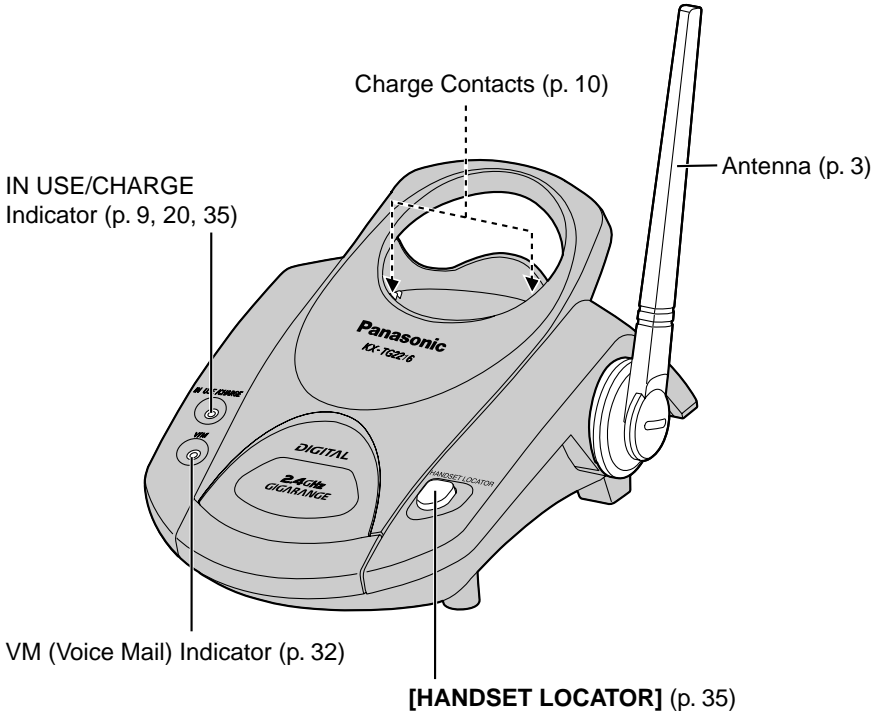

# Location of Controls

## Handset

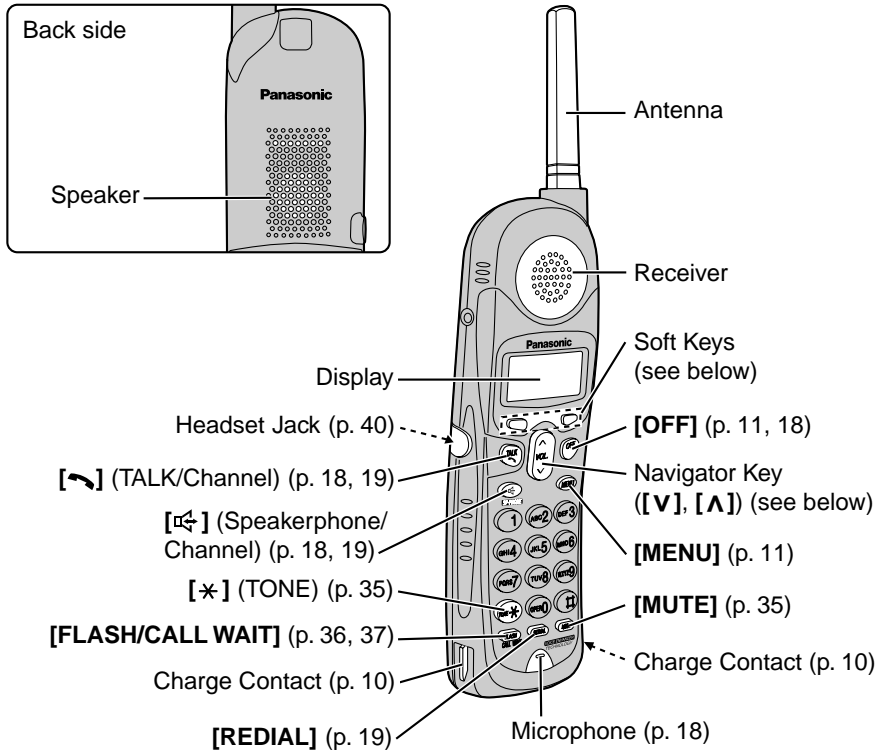

### How to use the soft keys/navigator key

#### ① Soft keys:

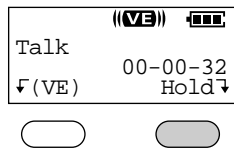

Two soft keys are used to select functions displayed directly above the keys. Functions displayed above the keys will change depending on the state of use.

For example, to operate “Hold”, press the right soft key.

- When a function does not appear above a soft key, the soft key will not work.

#### ② Navigator key:

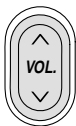

Scrolls through the function menu, the Caller List and the phone book (works as a scroll key).

Adjusts the handset ringer and receiver/speaker volumes (works as a volume key).

Throughout these Operating Instructions:

- The soft keys are indicated with the display above the keys.  
Ex. “Press Hold.” indicates “Press the soft key below Hold”.
- The navigator key is indicated by the arrows [V] or [A].

# Settings

## Connections

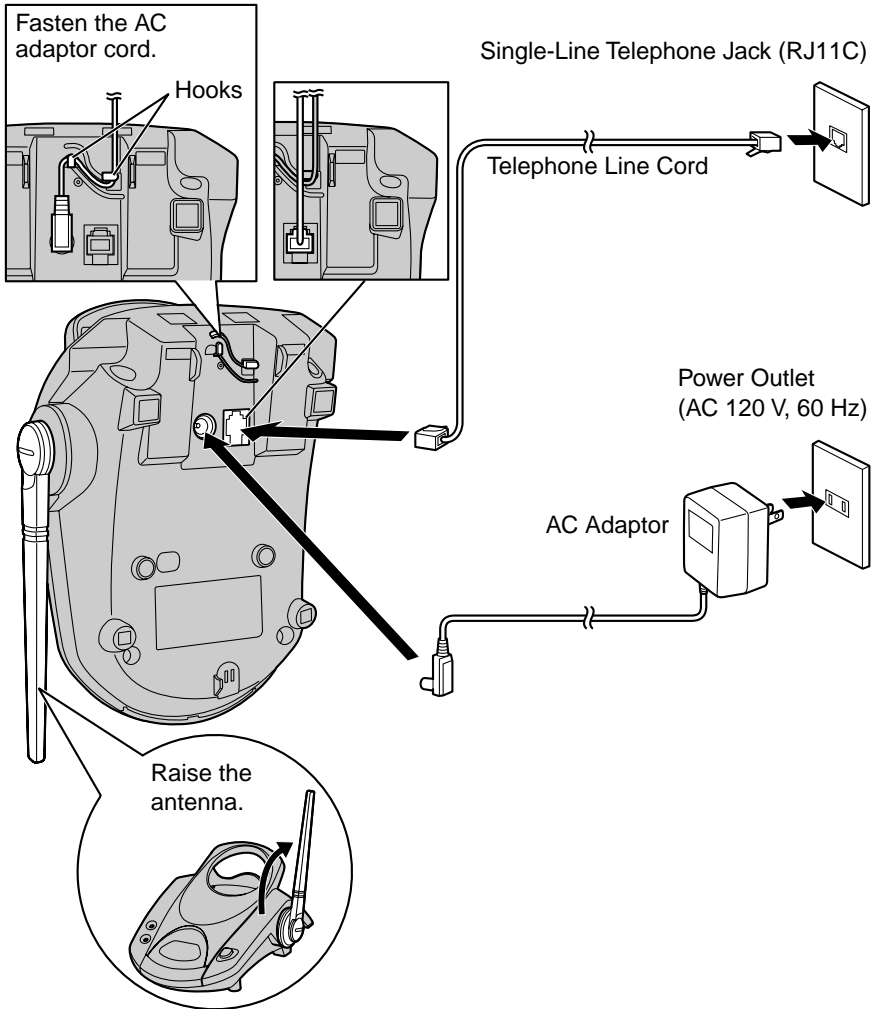

- USE ONLY WITH Panasonic AC ADAPTOR PQLV19 (Order No. PQLV19Z).
- The AC adaptor must remain connected at all times. (It is normal for the adaptor to feel warm during use.)
- If your unit is connected to a PBX which does not support Caller ID, you cannot access Caller ID services.
- The unit will not work during a power failure. If you want to connect a standard telephone on the same line, use the Panasonic T-adaptor KX-J66.



## Installing the Battery in the Handset

- 1 Pull down the latch (①), and remove the cover (②).

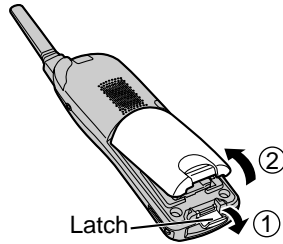

- 2 Insert the battery (③), and press it down until it snaps into the compartment (④).

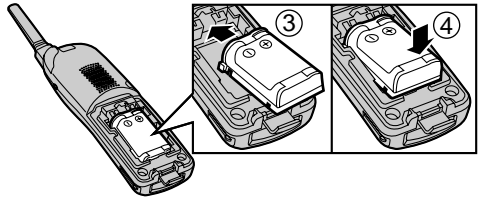

- 3 Close the cover (⑤ and ⑥).

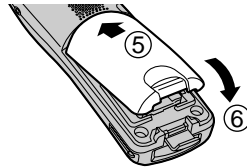

- 4 Push the latch upward until it snaps shut.

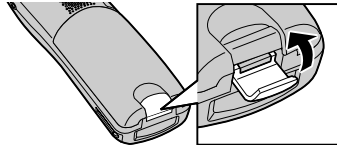

### To replace the battery:

Pull down the latch, and remove the cover. Replace the old battery with a new one (p. 10). Close the cover and charge the battery for about 6 hours.

## Battery Charge

Place the handset on the base unit and charge for about **6 hours** before initial use.



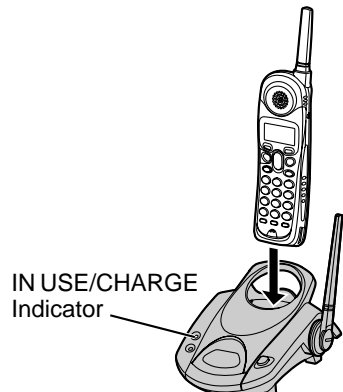

- The IN USE/CHARGE indicator lights and the unit beeps once.
- It is normal for the back on the handset to feel warm during battery charge.



# Settings

## Battery strength

You can check the battery strength on the handset display. The battery strength is as shown in the chart on the right.

Display prompt	Battery strength
	Fully charged
	Medium
	Low
 (flashing)	Needs to be recharged.

## Recharge

Recharge the battery when:

- “Recharge battery” is displayed on the handset,
- “” flashes, or
- the handset beeps intermittently while it is in use.

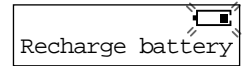

- If you DO NOT recharge the handset battery for more than 15 minutes, the display will continually indicate “Recharge battery” and/or “” will flash when the handset is lifted off the base unit.

### Battery replacement:

If you cleaned the charge contacts and fully charged the battery, but after a few telephone calls, “Recharge battery” is displayed and/or “” continues to flash, the battery needs to be replaced. Please order a new Panasonic HHR-P513 battery at the telephone number shown on page 2. To replace the battery, see page 9.

A nickel metal hydride battery that is recyclable powers the product you have purchased. Please call 1-800-8-BATTERY for information on how to recycle this battery.



## Battery information

After your Panasonic battery is fully charged:

Operation	Operating time
While in use (TALK)	Up to 5 hours
While not in use (Standby)	Up to 11 days

- The battery operating time may be shortened depending on usage conditions and ambient temperature.
- **Clean the charge contacts of the handset and the base unit with a soft, dry cloth once a month. Clean more often if the unit is subject to grease, dust or high humidity.** Otherwise the battery may not charge properly.
- If the battery is fully charged, you do not have to place the handset on the base unit until “Recharge battery” is displayed and/or “” flashes. This will maximize the battery life.
- The battery cannot be overcharged.

# Programmable Functions

## Programming Guidelines

This unit has programmable functions. They are selected from the function menu on the display (p. 12).

### Buttons/Keys

**Soft keys** : work as function keys when a function is displayed above a soft key.

When “**V**” or “**Λ**” is displayed, you can use the navigator key [**V**] or [**Λ**] as a scroll key.

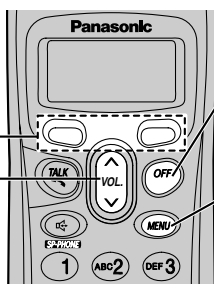

**[OFF]** : allows you to exit programming mode any time.

**[MENU]** : allows you to enter the menu by pressing while the handset is not being used.

## How to select a function item from the menu

**Make sure the unit is not being used and the handset is lifted off the base unit before programming.**

Operation	Display
<b>1</b> Press <b>[MENU]</b> to enter menu mode. <ul style="list-style-type: none"><li>The main menu is displayed (p. 12).</li></ul>	
<b>2</b> Scroll to the desired item by pressing [ <b>V</b> ] or [ <b>Λ</b> ]. <ul style="list-style-type: none"><li><b>How to use the Exit key:</b> Press <b>Exit</b> to exit programming mode.</li></ul>	A screenshot of the handset display showing the text "Initial setting" at the top. Below it, there are two options: "Exit" and "Select", each preceded by a downward-pointing arrow. The text "VA" is centered between the two options.
<b>3</b> Press <b>select</b> at your desired menu.	A screenshot of the handset display showing a menu with two options: "Exit" and "Select", each preceded by a downward-pointing arrow. The text "VA" is centered between the two options.
<b>4</b> If your selected menu has a sub-menu, it will be displayed. Repeat steps 2 and 3 until your desired menu is displayed.	
<b>5</b> Select your desired setting by pressing [ <b>V</b> ] or [ <b>Λ</b> ]. <ul style="list-style-type: none"><li><b>How to use the Back key:</b> Press <b>Back</b> to go back to the previous menu.</li></ul>	A screenshot of the handset display showing a menu with two options: "Back" and "Save", each preceded by a downward-pointing arrow. The text "VA" is centered between the two options.
<b>6</b> Press <b>save</b> to save your setting. <ul style="list-style-type: none"><li>A confirmation tone will be heard and the setting will be saved.</li></ul>	
<b>7</b> Press <b>[OFF]</b> to exit programming mode.	

# Programmable Functions

## Useful information:

- If **select** is pressed while “---(Go back)---” is displayed, the unit will go back to the previous menu mode. If you press the key in the main menu, the unit will exit programming mode.
- After programming is complete, the display will return to the main menu or the sub-menu depending on which menu the selected item is located. (See the menu table below.)
- You can exit programming mode any time by pressing **[OFF]**.
- If you do not press any buttons for 60 seconds, the handset will exit programming mode.
- If the handset has lost communication with the base unit, the handset beeps 3 times and “No link to base. Place on cradle and try again.” is displayed.
- If **[↶]**, **[↷]** or any other buttons except **[MUTE]** and **[OFF]** is pressed while the handset is on the base unit, the handset beeps 3 times and “Please lift up and try again.” is displayed. Lift the handset and press the button again.

## Function Menu Table

You can use the following functions to customize your unit. See the corresponding pages for function details.

- After pressing **[MENU]**, you can also program menu items by direct commands (**[0]** to **[9]**) instead of using the soft keys (p. 42).

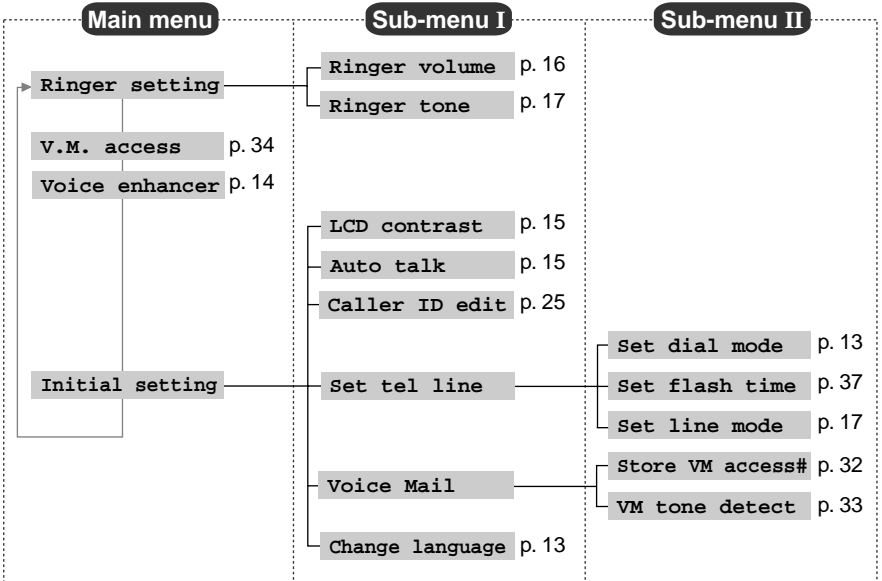

## Display Language

You can select either ENGLISH or SPANISH as the display language. The factory preset is ENGLISH.

1 Press **[MENU]**.

2 Scroll to "Initial setting" by pressing **[V]** or **[Λ]**, then press **Select**.

```
Initial setting
┆Exit  VΛ  Select┆
```

3 Scroll to "Change language" by pressing **[V]** or **[Λ]**, then press **Select**.

```
Change language
┆Back  VΛ  Select┆
```

4 Select the language by pressing **Español** or **English**.

```
Change language
      :English
┆Español  Save┆
```

5 Press **Guard.** or **Save**, then press **[OFF]**.

## Dialing Mode

If you have touch tone service, set to "Tone". If rotary or pulse service is used, set dialing mode to "Pulse". The factory preset is "Tone".

1 Press **[MENU]**.

2 Scroll to "Initial setting" by pressing **[V]** or **[Λ]**, then press **Select**.

```
Initial setting
┆Exit  VΛ  Select┆
```

3 Scroll to "Set tel line" by pressing **[V]** or **[Λ]**, then press **Select**.

```
Set tel line
┆Back  VΛ  Select┆
```

4 Press **select** at "Set dial mode".

```
Set dial mode
┆Back  VΛ  Select┆
```

5 Select "Pulse" or "Tone" by pressing **[V]** or **[Λ]**.

```
Set dial mode
      :Tone
┆Back  VΛ  Save┆
```

6 Press **save**, then press **[OFF]**.

# Programmable Functions

## Voice Enhancer Technology

Voice Enhancer Technology ((VE)) helps clarify and improve sound reception creating a natural-sounding voice that is easy to hear and understand.

This is accomplished by enhancing the frequency that is narrowed through the telephone line and comes pre-set to OFF at the factory.

Under normal conditions, cordless phones are limited to a narrowed frequency bandwidth (300Hz to 3.5KHz). Panasonic's new Voice Enhancer Technology cordless phones are able to simulate a band signal above and below the normal bandwidth limitations. As a result, a clearer, crisp sound much closer to the actual voice is achieved.

- “((VE))” is displayed when the Voice Enhancer Technology is set to ON.

**1** Press [MENU].

**2** Scroll to “Voice enhancer” by pressing [V] or [A], then press **select**.

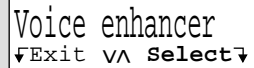

Voice enhancer  
↓Exit V^ Select↓

**3** Select “On” or “Off” by pressing [V] or [A].

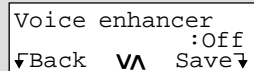

Voice enhancer :Off  
↓Back V^ Save↓

**4** Press **save**, then press [OFF].

### Helpful hint:

Depending on the condition and quality of your telephone line, Voice Enhancer may emphasize the noise already on the line. If it becomes difficult to hear the caller, please set Voice Enhancer mode to OFF.

**To turn the mode ON while talking, press (VE).**

- “((VE))” is displayed.
- Each time you press (VE), the mode will change to ON or OFF.
- If you store a voice mail access number (p. 32), “VM” will be displayed instead of “(VE)” for 15 seconds after pressing [hook] or [hook].

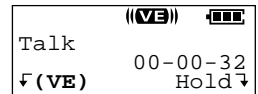

Talk ((VE)) [signal strength]  
↓(VE) 00-00-32 Hold↓

## Auto Talk

The Auto Talk feature allows you to answer a call by lifting the handset off the base unit without pressing [↶] or [↷]. To use this feature, turn the feature ON. The factory preset is OFF.

1 Press [MENU].

2 Scroll to "Initial setting" by pressing [V] or [Λ], then press **select**.

```
Initial setting
↓Exit  VΛ  Select↓
```

3 Scroll to "Auto talk" by pressing [V] or [Λ], then press **select**.

```
Auto talk
↓Back  VΛ  Select↓
```

4 Select "On" or "Off" by pressing [V] or [Λ].

```
Auto talk           :Off
↓Back  VΛ  Save↓
```

5 Press **save**, then press [OFF].

- In order to view Caller ID information after you lift up the handset to answer a call, leave the Auto Talk feature OFF.

## LCD Contrast

You can select the handset LCD contrast (5 levels). The factory preset is level 3.

1 Press [MENU].

2 Scroll to "Initial setting" by pressing [V] or [Λ], then press **select**.

```
Initial setting
↓Exit  VΛ  Select↓
```

3 Press **select** at "LCD contrast".

```
LCD contrast
↓Back  VΛ  Select↓
```

4 Select the desired contrast by pressing [V] or [Λ].

- Each time you press [V] or [Λ], the LCD contrast will change.

```
LCD contrast
Low  ■■■■  High
↓Back  VΛ  Save↓
```

5 Press **save**, then press [OFF].

# Programmable Functions

## Ringer Volume

You can select the handset ringer volume HIGH, MEDIUM, LOW or OFF. The factory preset is HIGH. If set to OFF, the handset will not ring.

1 Press **[MENU]**.

2 Press **select** at “Ringer setting”.

```
Ringer setting
┆Exit v∧ Select┆
```

3 Press **select** at “Ringer volume”.

```
Ringer volume
┆Back v∧ Select┆
```

4 Select the desired volume level by pressing **[V]** or **[∧]**.

- The volume will change and ring.
- The number of steps indicates the volume level.
- **To turn the ringer OFF**, press **[V]** repeatedly until “Ringer off” is displayed.

Ex. HIGH

```
Ringer volume
Low ████████ High
┆Back v∧ Save┆
```

5 Press **save**, then press **[OFF]**.

- If set to OFF, the handset displays “Ringer off” while not in use. But if there are missed calls and the handset is off the base unit, the handset will not display “Ringer off”.
- You can select the ringer volume while an external call is being received. Press **[V]** or **[∧]** while the unit is just ringing. To set to OFF, press and hold **[V]**. “Ringer off” is displayed.



## Ringer Tone

You can select one of 6 ringer tones for external calls on the handset.  
The factory preset is 1.

1 Press **[MENU]**.

2 Press **select** at “Ringer setting”.

```
Ringer setting
┆Exit v^ Select┆
```

3 Scroll to “Ringer tone” by pressing **[V]** or **[^]**, then press **select**.

```
Ringer tone
┆Back v^ Select┆
```

4 Select the desired tone by pressing **[V]** or **[^]**.

- If the handset ringer volume has been set to OFF, the unit will not ring (p. 16).
- You can also select a ringer tone by pressing dialing buttons **[1]** to **[6]**.

```
Ringer tone           :1
┆Back   v^ Save┆
```

5 Press **save**, then press **[OFF]**.

## Line Mode

The line mode is preset at the factory to “B”. Generally leave the line mode “B”.  
If a change of the line mode setting is required by our customer call center or service person, change the line mode to “A”.

1 Press **[MENU]**.

2 Scroll to “Initial setting” by pressing **[V]** or **[^]**, then press **select**.

```
Initial setting
┆Exit v^ Select┆
```

3 Scroll to “Set tel line” by pressing **[V]** or **[^]**, then press **select**.

```
Set tel line
┆Back v^ Select┆
```

4 Scroll to “Set line mode” by pressing **[V]** or **[^]**, then press **select**.

```
Set line mode
┆Back v^ Select┆
```

5 Select “A” or “B” by pressing **[V]** or **[^]**.

```
Set line mode           :B
┆Back   v^ Save┆
```

6 Press **save**, then press **[OFF]**.

# Making Calls

---

## 1 Press [📞].

- “Talk” is displayed.

---

## 2 Dial a phone number.

- The dialed number is displayed.
- After a few seconds, the display will show the length of the call.

---

## 3 To hang up, press [OFF] or place the handset on the base unit.

---

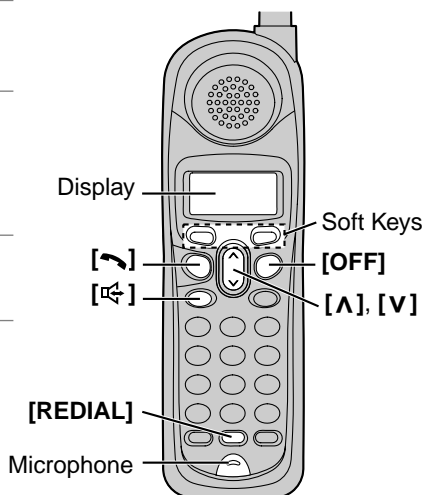

---

## To have a hands-free phone conversation

---

### 1 Press [📞].

- “SP-phone” is displayed.

---

### 2 Dial a phone number.

- The dialed number is displayed.
- After a few seconds, the display will show the length of the call.

---

### 3 When the other party answers, talk into the microphone.

---

### 4 To hang up, press [OFF] or place the handset on the base unit.

---

#### Hands-free Digital Duplex Speakerphone

For best performance, please note the following:

- Talk alternately with the other party in a quiet room.
  - If you or the other party has hearing difficulty, press [V] to decrease the speaker volume.
  - While talking using [📞], you can switch to the hands-free phone conversation by pressing [📞]. To switch back to the receiver, press [📞].
- 
- If the handset has lost communication with the base unit, the handset beeps 3 times and “No link to base. Place on cradle and try again.” is displayed.
  - If [📞], [📞] or any other buttons except [MUTE] and [OFF] is pressed while the handset is on the base unit, the handset beeps 3 times and “Please lift up and try again.” is displayed. Lift the handset and press the button again.

## To dial after confirming the entered number

1 Enter a phone number.

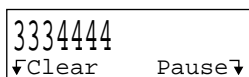

- If you misdial, press **Clear**. Enter the correct number.
- If a pause is required for dialing, press **Pause** where needed (p. 36).
- To cancel, press **[OFF]**.

2 Press **[↶]** or **[↷]**.

3 To hang up, press **[OFF]** or place the handset on the base unit.

## If noise interferes with the conversation

Have the unit select a clearer channel by doing one of the following:

Press **[↶]** (Channel) if talking using **[↶]**,

press **[↷]** (Channel) if talking using **[↷]**, or

press **CH**, which is displayed when you adjust receiver or speaker volume (p. 20).

OR

Walk closer to the base unit.

## To redial the last number dialed

Press **[↶]** or **[↷]**, then press **[REDIAL]**.

## To redial using the redial list (Memory Redial)

The last 5 phone numbers dialed with the handset are stored in the redial list.

1 Press **[REDIAL]**.

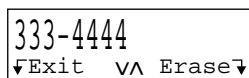

- The last number dialed is displayed.

2 Scroll to the desired number by pressing **[v]** or **[Λ]**.

- You can also scroll through the list by pressing **[REDIAL]**.
- To exit the list, press **[OFF]** or **Exit**.

3 Press **[↶]** or **[↷]**.

- **To erase an item**, scroll to the desired item then press **Erase**.
- If “No items stored” is displayed, the list is empty.

## To put a call on hold

Press **Hold** during a conversation.

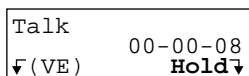

- “Hold” is displayed.

**To return to the call**, press **[↶]** or **[↷]**.

- If another phone is connected on the same line, you can also return to the call by lifting its handset.
- If a call is kept holding for 6 minutes, an alarm tone will start to sound. After 4 additional minutes on hold, the call will be disconnected.
- The alarm volume corresponds to the ringer volume level (p. 16). If the ringer is OFF, the alarm will sound at the LOW level.

# Making Calls

## To adjust the receiver/speaker volume while talking

3 levels (HIGH, MEDIUM and LOW) are available for the receiver and 6 levels for the speaker.

To increase volume, press [**▲**].

To decrease volume, press [**▼**].

- The display shows the current volume setting.
- If you try to increase/decrease volume when it is at the maximum/minimum level, the handset will beep 3 times.

Ex. Receiver volume: HIGH  
Speaker volume: level 6

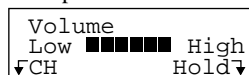

## Backlit LCD display

The lighted display of the handset will stay on for a few seconds after pressing a button or lifting the handset off the base unit.

## Lighted handset keypad

The handset dialing buttons will light when you press a button or lift the handset off the base unit. The light will go out after a few seconds.

# Answering Calls

When a call is received, the unit rings and "Incoming call" is displayed, and the IN USE/CHARGE indicator on the base unit flashes rapidly. If you subscribe to a Caller ID service, see page 21.

1 Press [**↶**] or [**↷**].

- You can also answer a call by pressing any button except [**▼**], [**▲**] and [**OFF**].

2 To hang up, press [**OFF**] or place the handset on the base unit.

### Auto Talk:

If you set the Auto Talk feature to ON (p. 15), you can answer a call by lifting the handset off the base unit.

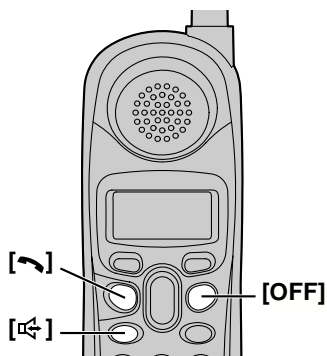

- When the ringer volume is set to OFF, the unit will not ring (p. 16).

# Caller ID Service

This unit is compatible with Caller ID services offered by your telephone company. If you subscribe to Caller ID, the caller's name and phone number will be displayed and recorded in the Caller List.

## How caller information is displayed when a call is received

When a call comes in, the unit will ring and caller ID information will be received. Once caller ID information is received, the handset display shows the caller's information.

Example

ROBINSON, TINA 1-555-222-3333
----------------------------------

- After you answer the call, the display will show the length of the call.
- If the unit does not receive caller ID information, one of the following will be displayed:

Display	Meaning
Out of area	The caller dialed from an area which does not provide Caller ID service.
Private caller	The caller requested not to send his/her information.
Long distance	The caller made a long distance call.

- If your unit is connected to a PBX which does not support Caller ID, you cannot access Caller ID service.
- The name display service may not be available in some areas. For further information, please contact your telephone company.
- If you subscribe to both Caller ID and Call Waiting, when talking on the phone as another call comes in, the second caller's name and phone number will be displayed (p. 36).

# Using the Caller List

The unit can record information up to 30 different callers and store this information in the Caller List. Caller information is sorted by the most recent call to the oldest. When the 31<sup>st</sup> call is received, the information from the 1<sup>st</sup> call is deleted.

The unit will also tell you how many calls you missed while you were out or unavailable to answer the phone.

Handset off the base unit

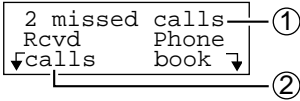

Handset on the base unit

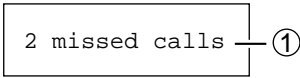

- ① The display will show the number of calls you missed.
  - After viewing the missed call entries, "missed calls" will disappear from the display.
  - When your voice mail box has received message(s);
    - When the handset is off the base unit, "Voice Mail" will be displayed in place of missed calls display.
    - When the handset is on the base unit, "Voice Mail" will be also displayed on the first line.
- ② Press **Rcvd calls** to review other calls logged in the Caller List.
  - If there are no items in the Caller List, "Rcvd calls" will not be displayed.

## Viewing the Caller List

**1** Press **Rcvd calls** to enter the Caller List.

- You can also enter by pressing [**V**] or [**Λ**].

```

2 missed calls
Rcvd      Phone
↓calls   book ↓
    
```

```

2 missed calls
VΛ=Scroll list
    
```

**2** To search from the most recent call, press [**V**].  
To search from the oldest call, press [**Λ**].

- The caller's name, number and the time and date received are displayed. Name and phone number are alternately displayed as shown on the right.

Example

```

SMITH, JACK
3:10P JUN.29
↓Erase  Select↓
    
```

```

1-555-333-4444
3:10P JUN.29
↓Erase  Select↓
    
```

**3** To exit the list, press [**OFF**].

- If there is no name information of a caller, the display will only show the phone number.
- If you do not press any buttons for 60 seconds, the unit will exit the Caller List.

## What “√” means

“√” indicates you have already viewed this calling information, answered the call or called back the caller. If the same caller calls again, the call entry with “√” will be replaced with the new call entry.

SMITH, JACK 3:10P JUN.29 √
-------------------------------

## If a caller calls more than once

The number of times the same caller called is displayed (“x2” to “x9”). The date and time of the most recent call will be recorded. After viewing a caller’s information, “x2” to “x9” will be replaced with “√”.

TURNER, CINDY 11:20A JUN.12 x2
-----------------------------------

## Calling Back from the Caller List

---

**1** Press **Rcvd calls** to enter the Caller List.

- You can also enter by pressing [**V**] or [**Λ**].

---

**2** Scroll to the desired caller by pressing [**V**] or [**Λ**].

---

**3** Press [**↶**] or [**↷**].

- The phone number is dialed.

- 
- In some cases, you may have to edit the number before dialing (p. 24). (Ex. You may have to delete “1” and the area code.)
  - If a phone number is not displayed in the caller information, you cannot call back that caller from the Caller List.

# Using the Caller List

## Editing the Caller's Phone Number

You can edit a phone number in the Caller List to call it back or store it in the phone book.

### Caller ID Number Auto Edit Feature (p. 25)

This feature allows the unit to edit a Caller ID number into one of 3 patterns automatically in the Caller List. For details and activation, see page 25.

#### 1 Press **Rcvd calls** to enter the Caller List.

- You can also enter by pressing [**V**] or [**Λ**].

2 missed calls  
Rcvd Phone  
↓calls book ↓

2 missed calls  
VΛ=Scroll list

#### 2 Scroll to the desired caller by pressing [**V**] or [**Λ**].

- Name and phone number are alternately displayed as shown on the right.

PARKER, FRED  
11:20A JAN.12  
↓Erase Select ↓

1-555-321-5555  
11:20A JAN.12  
↓Erase Select ↓

#### 3 Press **Select**.

#### 4 Press **Edit**.

- Each time you press **Edit**, the number is rearranged into one of 3 patterns.

- Ⓐ Phone no.
- Ⓑ Area code — Phone no.
- Ⓒ 1—Area code — Phone no.

- The order in which patterns Ⓐ—Ⓒ are displayed depends on how the telephone number is displayed in step 2.

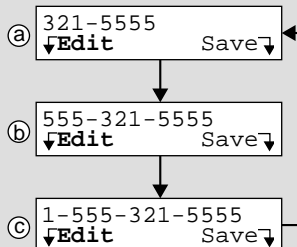

#### 5 To continue with making a call from the Caller List, press [**↶**] or [**↷**].

To continue with storing the number in the phone book, press **Save**.

- If there is no name information, see page 26.



## Caller ID Number Auto Edit Feature

There are 3 patterns of phone number (Ⓐ, Ⓑ and Ⓒ, p. 24). This feature allows your phone to automatically edit an in-coming Caller ID number into a pattern of your choice, and display the Caller ID number with that pattern.

After this feature is activated, Caller ID numbers coming from specific area codes (201, for example), from which the Caller ID numbers have been chosen to follow the desired pattern (7-digit pattern, for example), will be automatically edited from other patterns (11-digit pattern, for example) into the same pattern you have previously selected (which is 7-digit pattern, in this example).

Up to 4 area codes can be designated for this feature for pattern Ⓐ, Ⓑ and Ⓒ (p. 24).

To activate this feature, you must (1) set this feature to ON, and (2) make an outgoing call from Caller List (p. 23) with a number which has one of the 3 patterns that you have edited with specific area codes, and that you prefer to be followed by future Caller ID numbers, so that in the future all the Caller ID numbers coming from the same area code will be displayed in the same pattern.

The Caller ID number Auto Edit feature is preset at the factory to ON.

- If a call does not go through, the phone number you dialed may have an incorrect pattern. Please edit the phone number with another pattern (p. 24).

For example, if you move to another area, you may need to turn this feature OFF to erase previously edited area codes. Then, if still necessary, you may activate this feature again.

**1** Press **[MENU]**.

**2** Scroll to "Initial setting" by pressing **[V]** or **[Λ]**, then press **select**.

Initial setting  
↓Exit VΛ select↓

**3** Scroll to "Caller ID edit" by pressing **[V]** or **[Λ]**, then press **select**.

Caller ID edit  
↓Back VΛ select↓

**4** Select "Off" or "On" by pressing **[V]** or **[Λ]**.

Auto edit :On  
↓Back VΛ Save↓

**5** Press **save**, then press **[OFF]**.

- When the feature is set to OFF, the unit will still be able to display Caller ID, but the in-coming Caller ID number will not be edited by a pattern or area codes.

# Using the Caller List

## Storing Caller Information in the Phone Book

Callers' names and phone numbers that are in the Caller List can be stored in the phone book.

### 1 Press **Rcvd calls** to enter the Caller List.

- You can also enter by pressing **[V]** or **[Λ]**.

```
2 missed calls
Rcvd      Phone
↓calls   book ↓
```

```
2 missed calls
VΛ=Scroll list
```

### 2 Scroll to the desired caller by pressing **[V]** or **[Λ]**.

- If the number requires editing, see page 24.
- Name and phone number are alternately displayed as shown on the right.

```
TURNER, CINDY
11:00A JUN.12 X3
↓Erase   Select↓
```

```
1-555-456-7890
11:00A JUN.12 X3
↓Erase   Select↓
```

### 3 Press **Select**.

### 4 Press **Save**.

- To continue storing other items, repeat from step 2.

**If there is no name information for the caller, "Enter name" will be displayed.**

- If a name is not required, press **[V]** then press **Save**.
  - If a name is required, enter the name (p. 29). When finished, press **[V]** then press **Save**.
- To continue storing other items, repeat from step 2.

```
TURNER, CINDY
1-555-456-7890
↓Edit     Save↓
```

```
Enter name
V=Next   ▶↓
```

```
CINDY TURNER
↓◀      V=Next ▶↓
```

### 5 Press **[OFF]**.

- If the handset beeps 3 times and "Phone book full" is displayed in step 4, press **[OFF]** to exit the list. To erase other stored items from the phone book, see page 31.
- You cannot store caller information in the phone book if a phone number is not displayed.
- If the handset beeps 3 times and "Save error" is displayed in step 4, the item cannot be stored in the phone book. Place the handset on the base unit and try again from step 1.

## Erasing Caller Information

### To erase a specific caller

**1** Press **Rcvd calls** to enter the Caller List.

- You can also enter by pressing **[V]** or **[Λ]**.

```

2 missed calls
Rcvd      Phone
↓calls    book ↓
    
```

```

2 missed calls
VΛ=Scroll list
    
```

**2** Scroll to the desired caller by pressing **[V]** or **[Λ]**, then press **Erase**.

- To erase other items, repeat step 2.
- To exit the Caller List, press **[OFF]**.

```

REAGAN, TOM
12:20A JUN.12
↓Erase    Select↓
    
```

Erased

### To erase all entries

If the display shows that you have “missed calls”, you cannot erase all Caller List entries. Before erasing all entries, make sure that you have viewed all missed calls.

**1** Press **Rcvd calls** to enter the Caller List.

- You can also enter by pressing **[V]** or **[Λ]**.

```

Rcvd      Phone
↓calls    book ↓
    
```

**2** Press **All erase**.

```

0 missed call
VΛ=Scroll list
↓All erase
    
```

**3** Press **Yes**.

- A beep sounds and all entries in your Caller List are erased.

```

All erase?
↓No          Yes↓
    
```

All erased

- To cancel erasing, press **No** after step 2.

# Phone Book

You can store up to 50 names and phone numbers in the handset phone book. All phone book items are sorted alphabetically. You can make a call by selecting a name on the handset display.

## Storing Names and Numbers

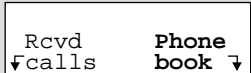
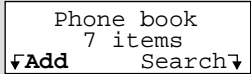
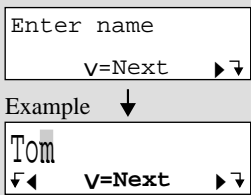
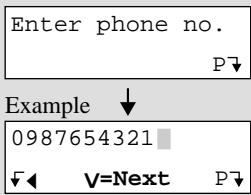
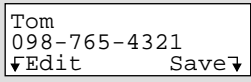
<b>1</b> Press <b>Phone book</b> .	 A rectangular menu box with a light gray background. It contains two items: "Rcvd" with a downward arrow on the left and "Phone" with a downward arrow on the right. Below "Rcvd" is the text "calls" and below "Phone" is the text "book".
<b>2</b> Press <b>Add</b> . <ul style="list-style-type: none"><li>When 50 items are stored in the phone book, "Add" is not displayed. To erase an item, see page 31.</li></ul>	 A rectangular menu box with a light gray background. It contains the text "Phone book" at the top, followed by "7 items". Below this are two items: "Add" with a downward arrow on the left and "Search" with a downward arrow on the right.
<b>3</b> Enter a name, up to 15 characters with the dialing buttons ([0] to [9]) (p. 29), then press [V]. <ul style="list-style-type: none"><li>If a name is not required, press [V] then go to step 4.</li></ul>	 Two rectangular input boxes with light gray backgrounds. The top box contains the text "Enter name" at the top and "v=Next" with a right arrow and a downward arrow at the bottom. Below it is the text "Example" with a downward arrow. The bottom box contains the text "Tom" at the top and "v=Next" with a left arrow and a right arrow at the bottom.
<b>4</b> Enter a phone number, up to 32 digits. <ul style="list-style-type: none"><li>Each time you press ◀, a digit is erased. To erase all of the digits, press and hold ◀.</li><li>If a pause is required for dialing, press P. A pause is stored in a phone number as one digit (p. 36).</li></ul>	 Two rectangular input boxes with light gray backgrounds. The top box contains the text "Enter phone no." at the top and "P" with a downward arrow at the bottom. Below it is the text "Example" with a downward arrow. The bottom box contains the text "0987654321" with a gray square cursor at the end, and "v=Next" with a left arrow and a right arrow at the bottom.
<b>5</b> Press [V]. <ul style="list-style-type: none"><li>If you want to change the name, press <b>Edit</b> then change it.</li><li>If you want to change the number, press [A] then change it.</li></ul>	 A rectangular menu box with a light gray background. It contains the text "Tom" at the top, followed by "098-765-4321". Below this are two items: "Edit" with a downward arrow on the left and "Save" with a downward arrow on the right.
<b>6</b> Press <b>Save</b> . <ul style="list-style-type: none"><li>To continue storing other items, repeat from step 2.</li><li>When you store the 50th item, "Phone book full" is displayed.</li></ul>	
<b>7</b> Press [OFF]. <ul style="list-style-type: none"><li>If the handset beeps 3 times when you press <b>Save</b>, the item cannot be stored in the phone book. Place the handset on the base unit and try again from step 1.</li></ul>	

## Selecting characters to enter names

Enter names using the dialing buttons. Press each button until the desired character is displayed.

- Pressing each button selects a character in the order shown below.

Keys	Characters	Keys	Characters
[1]	# & ' ( ) * , - . / 1	[6]	m n o M N O 6
[2]	a b c A B C 2	[7]	p q r s P Q R S 7
[3]	d e f D E F 3	[8]	t u v T U V 8
[4]	g h i G H I 4	[9]	w x y z W X Y Z 9
[5]	j k l J K L 5	[0]	0 Space
◀	Erases the character to the left.		
▶	Moves the cursor to the right. (To enter another character using the same number key, move the cursor to the next space.)		

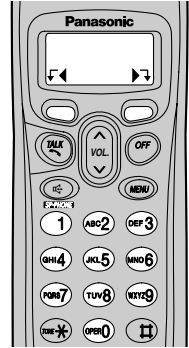

**For example, to enter “Tom”:**

**1** Press [8] four times.

T

**2** Press [6] three times, then press ▶ to move the cursor.

To

**3** Press [6].

Tom

## If you make a mistake when entering a name or number

Use ◀ to erase the incorrect character. Each time you press ◀, a character is erased. Then re-enter the correct character.

To erase all characters, press and hold ◀.

# Phone Book

## Dialing from the Phone Book

1 Press **Phone book** to enter the phone book.

2 Press **Search**.

Phone book  
7 items  
↓Add Search↓

3 Scroll to the desired item. To scroll down, press **[V]**. To scroll up, press **[Λ]**.

0-9=Name search  
VΛ=Scroll list

Phone book items are sorted in the following order:

1	Alphabet letters (Alphabetical)
2	Space & ' ( ) , - . /
3	Numbers 0 to 9
4	# *
5	Telephone numbers (If no name is stored)

4 Press **Call**, **[↶]** or **[↷]**.

- The displayed phone number is dialed.

Frank  
444-5555  
↓Call Select↓

5 To hang up, press **[OFF]** or place the handset on the base unit.

- To exit the phone book list, press **[OFF]**.
- If “No items stored” is displayed in step 2, the phone book is empty.
- To view a phone number over 16 digits, repeat steps 1 to 3, then press **Select**, **Edit** and then **[V]**. When finished, press **[OFF]**.

### To search for a name by initial

1. Repeat the steps 1 and 2 above.

2. Press the dialing button for the first letter of the desired name until any name with the same initial is displayed (see the Index table below).

Ex. To find “Frank”, press **[3]** repeatedly until the first item under “F” is displayed.

- If there are no items in the index you selected, the first entry in the next alphabetical index will be displayed.

3. Press **[V]** repeatedly until the desired name is displayed.

### Index table

Keys	Index	Keys	Index
[1]	Other symbols, 1	[6]	M, N, O, 6
[2]	A, B, C, 2	[7]	P, Q, R, S, 7
[3]	D, E, F, 3	[8]	T, U, V, 8
[4]	G, H, I, 4	[9]	W, X, Y, Z, 9
[5]	J, K, L, 5	[0]	0, Space

## Editing an Item in the Phone Book

1 Press **Phone book** to enter the phone book.

2 Press **search**.

3 Scroll to the desired item by pressing [**V**] or [**▲**], then press **select**.

- To search for the item by initial, see page 30.

Jane  
345-6789  
↓Call      **Select**↓

4 Press **Edit**.

Jane  
345-6789  
↓Erase      **Edit**↓

5 Edit the name (p. 29), then press [**V**].

- If you do not need to change the name, press [**V**] then go to step 6.

Jane Walker  
↙◀      **V=Next**      ▶→

6 Edit the phone number, then press [**V**].

- If you do not need to change the number, press [**V**] then go to step 7.
- If a pause is required for dialing, press **P**. A pause is stored in a phone number as one digit (p. 36).

5553456789■  
↙◀      **V=Next**      **P**↓

7 Press **save**.

- To continue editing other items, repeat from step 2.

8 Press [**OFF**].

## Erasing an Item in the Phone Book

1 Press **Phone book** to enter the phone book.

2 Press **search**.

3 Scroll to the desired item by pressing [**V**] or [**▲**], then press **select**.

- To search for the item by initial, see page 30.

Helen  
666-777-8888  
↓Call      **Select**↓

4 Press **Erase**.

Helen  
666-777-8888  
↓Erase      **Edit**↓

5 Press **Yes**.

- A beep sounds and the item is erased.
- To erase other items, repeat from step 3.

Erase?  
↓No      **Yes**↓

6 Press [**OFF**].

- To cancel erasing, press **No** after step 4.

# Voice Mail Service

Voice mail service is an electronic on-line answering system offered by your telephone company. After subscribing, the voice mail system can answer calls automatically for you when your line is busy or if calls are not answered, and callers can leave their messages in your voice mail box virtually located at the telephone company. After the voice mail box has received messages, "Voice Mail" will be displayed on the handset and the VM (Voice Mail) indicator on the base unit will flash.

To use this feature, you must first store your voice mail access number.

## Storing a Voice Mail Access Number

1 Press **[MENU]**.

2 Scroll to "Initial setting" by pressing **[V]** or **[^]**, then press **select**.

Initial setting  
↓Exit v^ Select↓

3 Scroll to "Voice Mail" by pressing **[V]** or **[^]**, then press **select**.

Voice Mail  
↓Back v^ Select↓

4 Press **select** at "Store VM access#".

Store VM access#  
↓Back v^ Select↓

5 Enter your access number, up to 32 digits.

- Each time you press **◀**, a digit is erased.  
To erase all of the digits, press and hold **◀**.
- If a pause is required for dialing, press **P\***.

Example  
1234567PPP890  
↓◀ MENU=Save P↓

6 Press **[MENU]** to save your setting, then press **[OFF]**.

\*For quick access to your voice mail box, you may add pauses between your voice mail box access number and your mail box password in step 5.

Ex. 1-222-333-4444 PPPP 8888  
Your voice mail box access number      Pauses      Your mail box password

Pressing **P** once creates a 3.5 second delay and counts as one digit. The delay time depends on your telephone company.

## To erase a stored voice mail access number

Repeat steps 1 to 4, then press and hold **◀** until all of the digits are erased. Press **[MENU]**, then press **[OFF]**.



## Setting Voice Mail (VM) Tone Detection

Your telephone company sends special signals (Voice mail tones) to activate the VM indicator.

Press [↶] or [↷] to listen to the dial tone. If you hear a pulsating tone followed by a continuous dial tone, this is an indication that a new message was recorded.

Your phone comes set to detect these tones (set to ON). After you hang up or the phone stops ringing, your unit will seize the phone line and check if a message has been recorded. If a new message was recorded at your telephone company, "Voice Mail" will be displayed on the handset and the VM indicator on the base unit will flash.

Set this programming to OFF when:

- you do not subscribe to a voice mail service,
- your telephone company does not send a pulsating tone, followed by a continuous dial tone, or
- your unit is connected to a business or office telephone system (PBX).

If you are not sure which setting is required, consult your local telephone company or contact the Panasonic Customer Call Center.

**1** Press [MENU].

**2** Scroll to "Initial setting" by pressing [V] or [▲], then press **Select**.

Initial setting  
 ↓Exit ▼▲ Select↓

**3** Scroll to "Voice Mail" by pressing [V] or [▲], then press **Select**.

Voice Mail  
 ↓Back ▼▲ Select↓

**4** Scroll to "VM tone detect" by pressing [V] or [▲], then press **Select**.

VM tone detect  
 ↓Back ▼▲ Select↓

**5** Select "Off" or "On" by pressing [V] or [▲].

VM tone detect  
 :On  
 ↓Back ▼▲ Save↓

**6** Press **save**, then press [OFF].

# Voice Mail Service

## Listening to Voice Mail Messages

After the voice mail box has received messages, the unit will indicate it in two ways:

- (a) "Voice Mail" will be displayed on the handset, and
- (b) the VM indicator on the base unit will flash.

Ex. Handset on the base unit

Voice Mail

## To listen to your voice mail message(s)

1 Press **[MENU]**.

2 Scroll to "V.M. access" by pressing **[V]** or **[Λ]**, then press **select**.

- The unit is connected to the telephone line and dials the access number (p. 32) in speakerphone mode.
- If 3 beeps sound and "Store VM access#" is displayed, a voice mail access number is not stored. To store the number, see page 32.

V.M. access  
↓Exit vΛ select↓

Example ↓

1234567PPP890  
↓(VE) Hold↓

3 Follow the pre-recorded instructions.

4 When finished, press **[OFF]**.

• You can also listen to your voice mail message(s) by using **[↶]** or **[↷]**.

1. Press **[↶]** or **[↷]**.

2. Press **VM** within 15 seconds.

- After 15 seconds, "VM" will disappear and "(VE)" will be displayed.
- If a voice mail access number is not stored, "VM" will not be displayed. To store the number, see page 32.

3. Follow steps 3 and 4 of "To listen to your voice mail message(s)" above.

Talk 00-00-08  
↓VM Hold↓

- If "Voice Mail" still remains on the display and the VM indicator still flashes even if you have listened to your voice mail message(s), press and hold **[OFF]** until the unit beeps. "Voice Mail" will disappear and the VM indicator will go out.
- If your voice mail service uses a voice mail tone and the recorded message is over 3 minutes long, "Voice Mail" may not be displayed and the VM indicator may not flash.
- If your voice mail service uses a voice mail tone, the tone will be heard from any parallel connected phone. If you use another phone to retrieve messages, you have to dial your access number manually.

# Special Features

## Automatic Security Code Setting

Each time you place the handset on the base unit, the unit automatically selects one of a million security codes. These codes help prevent the unauthorized use of your telephone line by another cordless telephone user.

## Handset Locator

You can locate the handset or page the handset user with beep tones from the base unit.

**1** Press **[HANDSET LOCATOR]**.

- The IN USE/CHARGE indicator flashes. The handset beeps for 1 minute and displays "Paging".

**2** To stop paging, press **[HANDSET LOCATOR]** again or press **[OFF]** on the handset.

## Temporary Tone Dialing (For Rotary or Pulse Service Users)

Press **[\*]** (TONE) before entering access numbers which require tone dialing.

- The dialing mode changes to tone. You can enter numbers to access an answering service, electronic banking service, etc. When you hang up, the dialing mode will return to pulse.

## Muting Your Conversation

During a call, you can mute your phone so the other party cannot listen to you. When muting your conversation, you can hear the other party.

Press **[MUTE]**.

- "<Mute>" will flash.

• To release the mute, press **[MUTE]**, **[↶]** or **[↷]**.

Talk	
<Mute>	00-00-30
↓ (VE)	Hold ↓

# Special Features

---

## For Call Waiting Service Users

Press **[FLASH/CALL WAIT]** if you hear a call-waiting tone while talking.

- The first call is put on hold and you can answer the second call.
- To return to the first caller, press **[FLASH/CALL WAIT]** again.
- Call waiting service cannot be used when:
  - the first call is placed on hold, or
  - a parallel connected telephone is in use.
- If this function does not operate properly, consult your telephone company for details.

## Call Waiting Caller ID

If you subscribe to both Caller ID and Call Waiting, when talking on the phone as another call comes in, the second caller's name and phone number will be displayed.

After you hear a call-waiting tone while talking, the display shows the caller's name with the phone number and "----Waiting-----".

BROWN, NANCY 1-555-666-7777 ----Waiting-----
----------------------------------------------------

- Contact your telephone company for details and availability in your area.

## Using the PAUSE Key (For PBX Line/Long Distance Calls)

We recommend you press **Pause** or **P** if a pause is required to dial with a PBX or to make a long distance call.

Ex. Line access number **[9]** (PBX)

**[9]** → **Pause** or **P** → 

Phone number
--------------

Example

9P15556667777
↓Clear                  Pause↓

OR

9P1234567890
↓◀                  v=Next                  P↓

- Pressing **Pause** or **P** once creates a 3.5 second pause. This prevents misdialing when you dial after confirming the entered number (p. 19) or dial a stored number (p. 30).
- Pressing **Pause** or **P** more than once increases the length of the pause between numbers.

## FLASH Button

Pressing **[FLASH/CALL WAIT]** allows you to use special features of your host PBX such as transferring an extension call, or access optional telephone services such as call waiting.

- Pressing **[FLASH/CALL WAIT]** cancels following operations:
  - temporary tone dialing, or
  - muting your conversation.

## Selecting the flash time

The flash time required depends on your telephone exchange or host PBX. You can select the following flash times: “700, 600, 400, 300, 250, 110, 100 or 90 ms (milliseconds)”. The factory preset is “700 ms”.

- If PBX functions do not work correctly, consult your PBX supplier for the correct settings.

**1** Press **[MENU]**.

**2** Scroll to “Initial setting” by pressing **[V]** or **[Λ]**, then press **Select**.

```
Initial setting
↓Exit VΛ Select↓
```

**3** Scroll to “Set tel line” by pressing **[V]** or **[Λ]**, then press **Select**.

```
Set tel line
↓Back VΛ Select↓
```

**4** Scroll to “Set flash time” by pressing **[V]** or **[Λ]**, then press **Select**.

```
Set flash time
↓Back VΛ Select↓
```

**5** Select the desired time by pressing **[V]** or **[Λ]**.

```
Set flash time
      :700ms
↓Back VΛ Save↓
```

**6** Press **save**, then press **[OFF]**.

# Wall Mounting

This unit can be mounted on a wall phone plate.

- 1 Feed the AC adaptor cord through the wall mounting adaptor. Connect the AC adaptor.

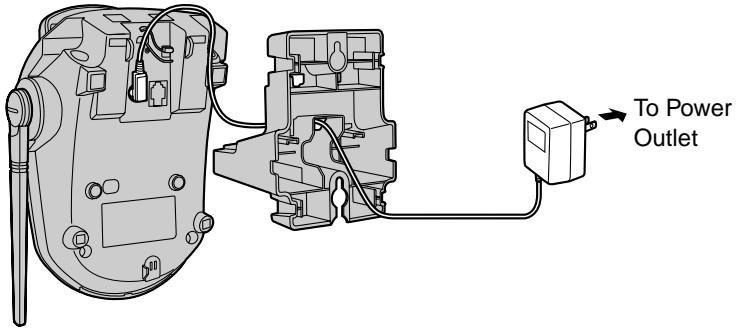

- 2 Tuck the telephone line cord inside the wall mounting adaptor (①). Connect the telephone line cord (②) to the unit.

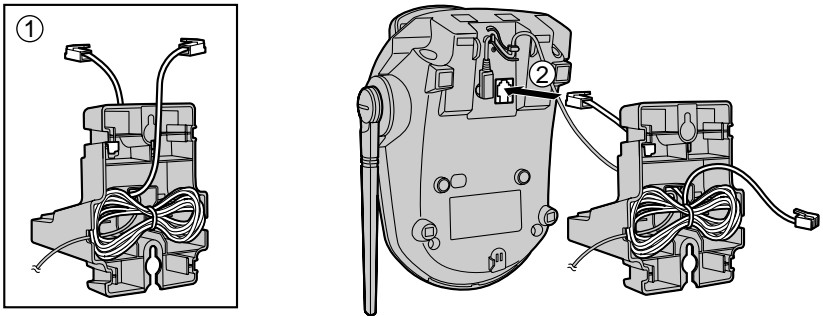

- 3 Insert (A) and (B) hooks on the wall mounting adaptor into the holes on the base unit.

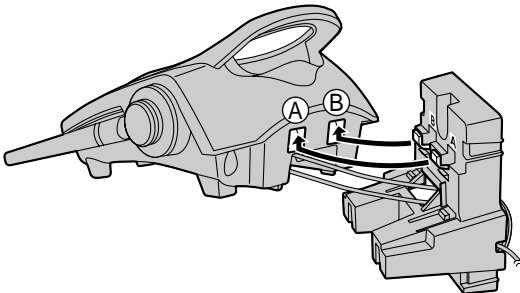

## Wall Mounting

- 4 Adjust the adaptor to hold the base unit, then push it in the direction of the arrow until it clicks into place.

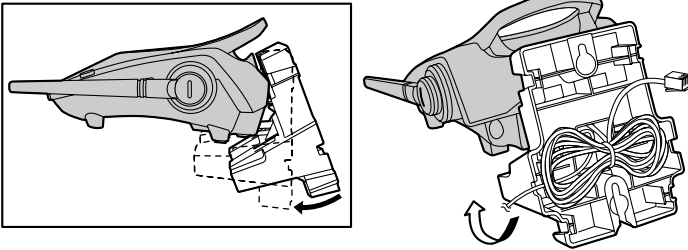

- 5 Connect the telephone line cord. Mount the unit, then slide down.  
• Raise the antenna.

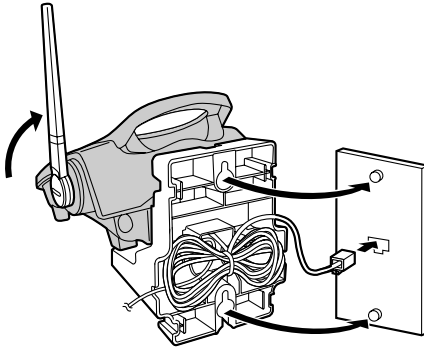

### 6 To charge the handset battery:

Place the handset on the base unit.

- The IN USE/CHARGE indicator lights and the unit beeps once.

### To remove the wall mounting adaptor

While pushing down the levers (①), remove the adaptor (②).

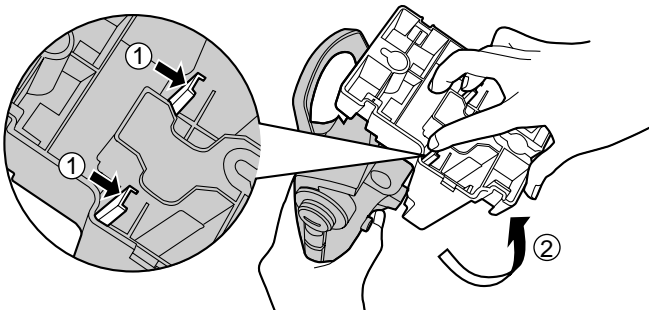

# Belt Clip

You can hang the handset on your belt or pocket using the included belt clip.

## To attach the belt clip

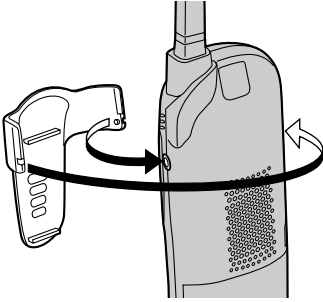

## To remove the belt clip

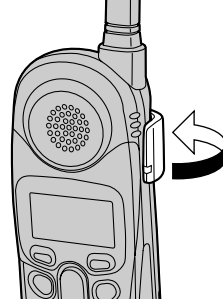

# Headset

Connecting the headset to the handset allows hands-free phone conversation.

## Connecting the headset to the handset

Open the headset jack cover, and insert the headset plug into the headset jack as shown below.

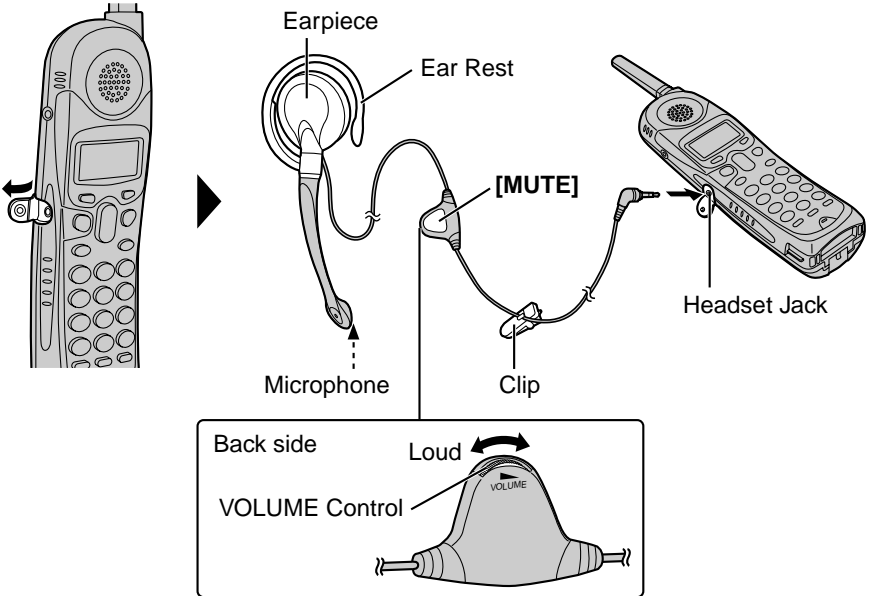



## How to wear the headset

**1** Adjust the ear rest for left side or right side use.

- Rotate the ear rest as shown depending on which ear you will wear the headset on.
- If you wear the headset on the right ear, (R) should face away from you.
- If you wear the headset on the left ear, (L) should face away from you.

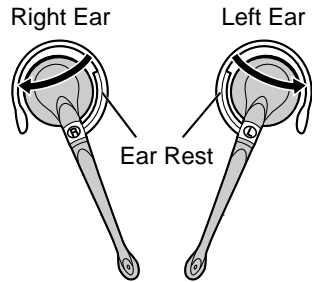

**2** Wrap the ear rest around your ear and position the microphone near your mouth.

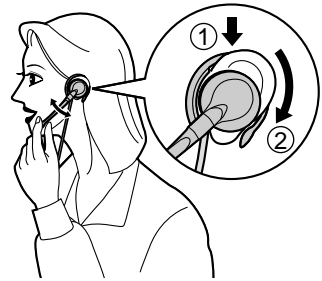

**3** Attach the clothing clip to keep the headset cord out of your way.

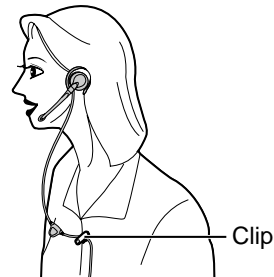

## Making/Answering Calls

**1** Press [] to make or answer a call.

**2** To hang up, press [OFF].

### To switch to the speakerphone while using the headset:

Press []. To return to the headset, press [].

### To adjust the headset receiver volume:

Rotate the VOLUME control to the desired level.

### To mute the conversation:

Press and hold [MUTE] on the headset.

- While holding [MUTE] on the headset, the other party cannot listen to you.
- You can also mute the conversation by pressing [MUTE] on the handset (p. 35). To release the mute, press [MUTE] or [] on the handset.

# Direct Commands

After pressing **[MENU]**, you can also program menu items by direct commands (**[0]** to **[9]**) instead of using the soft keys.

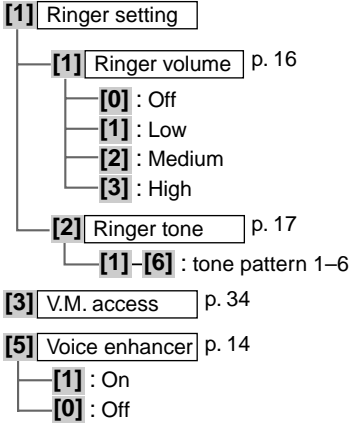

## During programming:

To save the setting, press the right soft key (**save**).

To exit the programming, press **[OFF]**.

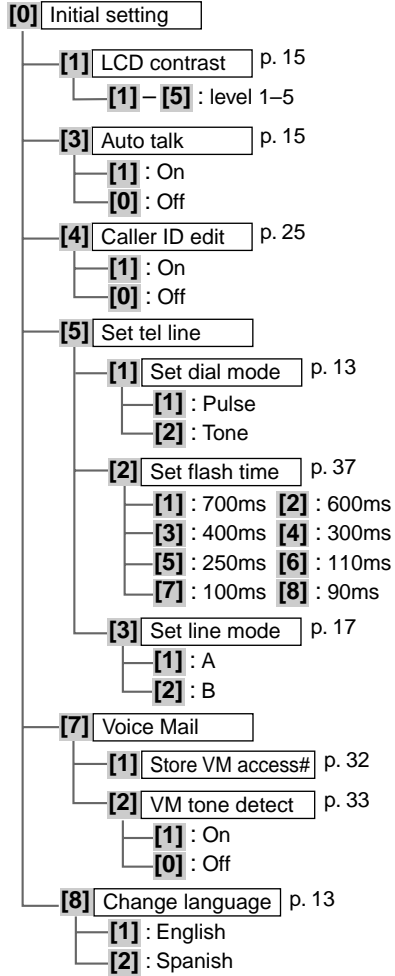

- If you press the direct command incorrectly, exit the programming. Then re-enter the programming by pressing **[MENU]**.
- For function details, see the corresponding pages.



# Troubleshooting

Problem	Cause & Remedy
The unit does not work.	<ul style="list-style-type: none"><li>• Check the settings (p. 8–10).</li><li>• Check whether the dialing mode setting is correct (p. 13).</li><li>• Charge the battery fully (p. 9).</li><li>• Clean the charge contacts and charge again (p. 10).</li><li>• Install the battery properly (p. 9).</li><li>• Place the handset on the base unit and unplug the AC adaptor to reset it. Plug in, and try again.</li><li>• Re-install the battery (p. 9) and charge it fully.</li></ul>
“No link to base. Place on cradle and try again.” is displayed and an alarm tone sounds.	<ul style="list-style-type: none"><li>• You are too far from the base unit. Walk closer and try again.</li><li>• Place the handset on the base unit and try again.</li><li>• Plug in the AC adaptor.</li><li>• Raise the base unit antenna.</li></ul>
Static, sound cuts in/out, fades. Interference from other electrical units.	<ul style="list-style-type: none"><li>• Move the handset and the base unit away from other electrical appliances (p. 3).</li><li>• Walk closer to the base unit.</li><li>• Raise the base unit antenna.</li><li>• Select a clearer channel (p. 19).</li></ul>
The handset does not ring.	<ul style="list-style-type: none"><li>• The ringer volume is set to OFF. Set to HIGH, MEDIUM or LOW (p. 16).</li></ul>
The handset display is blank.	<ul style="list-style-type: none"><li>• Charge the battery fully (p. 9).</li></ul>
You cannot program function items.	<ul style="list-style-type: none"><li>• Programming is not possible while the unit is being used.</li><li>• Do not pause for over 60 seconds while programming.</li><li>• Walk closer to the base unit.</li></ul>
While programming or searching, the unit starts to ring and stops the program/search.	<ul style="list-style-type: none"><li>• A call is coming in. To answer the call, press <b>[↶]</b> or <b>[↷]</b>. Start again from the beginning after hanging up.</li></ul>

# Troubleshooting

Problem	Cause & Remedy
Previously programmed information is erased.	<ul style="list-style-type: none"><li>• If a power failure occurs, programmed information may be erased. Reprogram if necessary.</li></ul>
The unit does not display the caller's name and/or phone number.	<ul style="list-style-type: none"><li>• You need to subscribe to a Caller ID service.</li><li>• Other telephone equipment may be interfering with your phone. Disconnect it and try again.</li><li>• Other electrical appliances connected to the same outlet may be interfering with Caller ID.</li><li>• Telephone line noise may be affecting Caller ID.</li><li>• The caller requested not to send his/her Caller ID information (p. 21).</li><li>• If a Caller ID box is connected between the unit and the telephone wall jack, disconnect the Caller ID box or plug the unit directly into the wall jack.</li></ul>
The handset display exits the Caller List or phone book.	<ul style="list-style-type: none"><li>• Do not pause for over 60 seconds while searching.</li></ul>
You cannot page the handset.	<ul style="list-style-type: none"><li>• The handset is too far from the base unit.</li><li>• The handset user is making an outside call or viewing the Caller List/phone book. Wait until the IN USE/CHARGE indicator light goes out.</li><li>• The handset is in use. Try again later.</li></ul>
You cannot redial.	<ul style="list-style-type: none"><li>• If the last number dialed was more than 32 digits long, the number will not be redialed correctly.</li></ul>
"Recharge battery" is displayed, "  " flashes or the unit beeps intermittently.	<ul style="list-style-type: none"><li>• Charge the battery fully (p. 9).</li></ul>
You charged the battery fully, but "Recharge battery" is still displayed and/or "  " continues to flash.	<ul style="list-style-type: none"><li>• Clean the charge contacts and charge again (p. 10).</li><li>• Install a new battery (p. 9).</li></ul>

Problem	Cause & Remedy
The IN USE/CHARGE indicator light does not go out after the battery has been charged.	<ul style="list-style-type: none"><li>• This is normal.</li></ul>
You cannot have a conversation using the headset.	<ul style="list-style-type: none"><li>• Make sure the headset is connected properly (p. 40).</li><li>• If "SP-phone" is displayed on the handset, press  to switch to the headset.</li></ul>
If you cannot solve your problem	<ul style="list-style-type: none"><li>• Call our customer call center at 1-800-211-PANA(7262).</li><li>• Panasonic's e-mail address for customer inquiries: consumerproducts@panasonic.com for customers in the USA or Puerto Rico ONLY</li></ul>

# Important Safety Instructions

---

When using this unit, basic safety precautions should always be followed to reduce the risk of fire, electric shock, or personal injury.

1. Read and understand all instructions.
2. Follow all warnings and instructions marked on this unit.
3. Unplug this unit from AC outlets before cleaning. Do not use liquid or aerosol cleaners. Use a damp cloth for cleaning.
4. Do not use this unit near water, for example, near a bathtub, washbowl, kitchen sink, or the like.
5. Place this unit securely on a stable surface. Serious damage and/or injury may result if the unit falls.
6. Do not cover slots and openings on the unit. They are provided for ventilation and protection against overheating. Never place the unit near radiators, or in a place where proper ventilation is not provided.
7. Use only the power source marked on the unit. If you are not sure of the type of power supplied to your home, consult your dealer or local power company.
8. Do not place objects on the power cord. Install the unit where no one can step or trip on the cord.
9. Do not overload wall outlets and extension cords. This can result in the risk of fire or electric shock.
10. Never push any objects through slots in this unit. This may result in the risk of fire or electric shock. Never spill any liquid on the unit.
11. To reduce the risk of electric shock, do not disassemble this unit. Take the unit to an authorized servicer when service is required. Opening or removing covers may expose you to dangerous voltages or other risks. Incorrect reassembly can cause electric shock when the unit is subsequently used.
12. Unplug this unit from the wall outlet and refer servicing to an authorized servicer when the following conditions occur:
  - A. When the power supply cord or plug is damaged or frayed.
  - B. If liquid has been spilled into the unit.
  - C. If the unit has been exposed to rain or water.
  - D. If the unit does not work normally by following the operating instructions. Adjust only controls covered by the operating instructions. Improper adjustment may require extensive work by an authorized servicer.
  - E. If the unit has been dropped or physically damaged.
  - F. If the unit exhibits a distinct change in performance.
13. During thunderstorms, avoid using telephones except cordless types. There may be a remote risk of an electric shock from lightning.
14. Do not use this unit to report a gas leak, when in the vicinity of the leak.

## SAVE THESE INSTRUCTIONS

# Important Safety Instructions

## CAUTION:

To reduce the risk of fire or injury to persons, read and follow these instructions.

1. Use only the battery(ies) specified.
2. Do not dispose of the battery(ies) in a fire. They may explode. Check with local waste management codes for special disposal instructions.
3. Do not open or mutilate the battery(ies). Released electrolyte is corrosive and may cause burns or injury to the eyes or skin. The electrolyte may be toxic if swallowed.
4. Exercise care in handling batteries in order not to short the battery to conductive materials such as rings, bracelets, and keys. The battery and/or conductor may overheat and cause burns.
5. Charge the battery(ies) provided with or identified for use with this product only in accordance with the instructions and limitations specified in this manual.

## WARNING:

TO PREVENT FIRE OR SHOCK HAZARD, DO NOT EXPOSE THE BASE UNIT TO RAIN OR ANY TYPE OF MOISTURE. ONLY THE HANDSET IS SHOCK AND SPLASH RESISTANT.

- The AC adaptor is used as the main disconnect device, ensure that the AC outlet is located/installed near the unit and is easily accessible.

## Splash-Resistant (HANDSET ONLY)

The handset is designed to be splash resistant.

You can use the handset with wet hands.

## CAUTION:

- **Do not immerse in water or leave under running water.**
- Keep the handset away from salt water.
- Avoid exposure to prolonged high humidity.
- Since water in the headset jack may cause damage, close the headset jack cover when the headset is not in use. When the headset is connected, do not use the handset with wet hands.
- If the handset is wet, wipe with a soft dry cloth.
- The base unit is not designed to be splash resistant. Do not place the wet handset on the base unit.

## Shock-Resistant (HANDSET ONLY)

Although the handset is designed to be shock resistant, do not throw or step on the handset.

# FCC and Other Information

---

This equipment complies with Part 68 of the FCC rules and the requirements adopted by the ACTA. On the bottom of this equipment is a label that contains, among other information, a product identifier in the format US:ACJ-----. If requested, this number must be provided to the telephone company.

Registration No. .... (found on the bottom of the unit)  
Ringer Equivalence No. (REN).....0.1B

A plug and jack used to connect this equipment to the premises wiring and telephone network must comply with the applicable FCC Part 68 rules and requirements adopted by the ACTA. A compliant telephone cord and modular plug is provided with this product. It is designed to be connected to a compatible modular jack that is also compliant.

The REN is used to determine the number of devices that may be connected to a telephone line. Excessive RENs on a telephone line may result in the devices not ringing in response to an incoming call. In most but not all areas, the sum of RENs should not exceed five (5.0). To be certain of the number of devices that may be connected to a line, as determined by the total RENs, contact the local telephone company. For products approved after July 23, 2001, the REN for this product is part of the product identifier that has the format US:AAAEQ##TXXXX. The digits represented by ## are the REN without a decimal point (e.g., 03 is a REN of 0.3).

If this equipment causes harm to the telephone network, the telephone company will notify you in advance that temporary discontinuance of service may be required. But if advance notice isn't practical, the telephone company will notify the customer as soon as possible. Also, you will be advised of your right to file a complaint with the FCC if you believe it is necessary.

The telephone company may make changes in its facilities, equipment, operations or procedures that could affect the operation of the equipment. If this happens the telephone company will provide advance notice in order for you to make necessary modifications to maintain uninterrupted service.

If trouble is experienced with this equipment, for repair or warranty information, please contact a Factory Servicenter or other Authorized Servicer. If the equipment is causing harm to the telephone network, the telephone company may request that you disconnect the equipment until the problem is resolved.

Connection to party line service is subject to state tariffs. Contact the state public utility commission, public service commission or corporation commission for information.

If your home has specially wired alarm equipment connected to the telephone line, ensure the installation of this equipment does not disable your alarm equipment. If you have questions about what will disable alarm equipment, consult your telephone company or a qualified installer.

**WHEN PROGRAMMING EMERGENCY NUMBERS AND(OR) MAKING TEST CALLS TO EMERGENCY NUMBERS:**

- 1) Remain on the line and briefly explain to the dispatcher the reason for the call.
- 2) Perform such activities in the off-peak hours, such as early morning or late evenings.



## FCC and Other Information

---

This device complies with Part 15 of the FCC Rules. Operation is subject to the following two conditions: (1) This device may not cause harmful interference, and (2) this device must accept any interference received, including interference that may cause undesired operation.

Privacy of communications may not be ensured when using this phone.

### **CAUTION:**

Any changes or modifications not expressly approved by the party responsible for compliance could void the user's authority to operate this device.

### **Note:**

This equipment has been tested and found to comply with the limits for a Class B digital device, pursuant to Part 15 of the FCC Rules. These limits are designed to provide reasonable protection against harmful interference in a residential installation. This equipment generates, uses, and can radiate radio frequency energy and, if not installed and used in accordance with the instructions, may cause harmful interference to radio communications. However, there is no guarantee that interference will not occur in a particular installation. If this equipment does cause harmful interference to radio or television reception, which can be determined by turning the equipment off and on, the user is encouraged to try to correct the interference by one or more of the following measures:

- Reorient or relocate the receiving antenna.
- Increase the separation between the equipment and receiver.
- Connect the equipment into an outlet on a circuit different from that to which the receiver is connected.
- Consult the dealer or an experienced radio/TV technician for help.

Some cordless telephones operate at frequencies that may cause interference to nearby TVs and VCRs. To minimize or prevent such interference, the base of the cordless telephone should not be placed near or on top of a TV or VCR. If interference is experienced, move the cordless telephone further away from the TV or VCR. This will often reduce, or eliminate, interference.

Operating near 2.4GHz electrical appliances may cause interference. Move away from the electrical appliances and/or press the TALK or SP-PHONE button, or CH (Channel) key.

### **CAUTION:**

To comply with FCC RF exposure requirements, the base unit should be installed with its antenna located at 20 cm or more from persons and handset should be carried with the specific belt-clip provided for the handset to ensure compliance. Other non-tested belt-clips or similar body-worn accessories may not comply, therefore, should be avoided.

## FCC and Other Information

---

This equipment is hearing aid compatible as defined by the FCC in 47 CFR Section 68.316.

When you hold the phone to your ear, noise might be heard in your Hearing Aid. Some Hearing Aids are not adequately shielded from external RF (radio frequency) energy. If noise occurs, use an optional headset accessory or the speakerphone option (if applicable) when using this phone. Consult your audiologist or Hearing Aid manufacturer about the availability of Hearing Aids which provide adequate shielding to RF energy commonly emitted by digital devices.

A TIA/EIA-IS-968 compliant telephone cord and modular plug is provided with this equipment. This equipment is designed to be connected to the telephone network or premises wiring using a compatible modular jack that is also TIA/EIA-IS-968 compliant.

- **Environment** — do not place the unit in a room where the temperature is less than 5°C (41°F) or greater than 40°C (104°F). Allow 10 cm (4") clearance around the unit for proper ventilation. Avoid excessive smoke, dust, mechanical vibration, shock, or direct sunlight.
- **Medical** — consult the manufacturer of any personal medical devices, such as pacemakers or hearing aids, to determine if they are adequately shielded from external RF (radio frequency) energy. (The unit operates in the frequency range of 2402MHz to 2480MHz, and the power output level can range 0.01 watts.) Do not use the unit in health care facilities if any regulations posted in the area instruct you not to do so. Hospitals or health care facilities may be using equipment that could be sensitive to external RF (radio frequency) energy.
- **Routine care** — wipe the unit with a soft cloth. Do not use benzine, thinner, or any abrasive powder. When you leave the unit unused for a long period of time, unplug the AC adaptor from the outlet.
- **If there is any trouble** — disconnect the unit from the telephone line and connect a known working phone. If the known working phone operates properly, have your unit repaired by one of the authorized Panasonic Factory Service Centers. If the known working phone does not operate properly, consult your telephone company.

# Index

<b>A</b>		<b>I</b>	
Accessories . . . . .	2	Installation, AC adaptor . . . . .	8
Answering Calls . . . . .	20	Installation, Battery . . . . .	9
Auto Talk . . . . .	15, 20	Installation, Headset . . . . .	40
Automatic Security Code Setting . . . . .	35	Installation, Telephone Line Cord . . . . .	8
<b>B</b>		<b>L</b>	
Backlit LCD . . . . .	20	LCD Contrast . . . . .	15
Base Unit Location . . . . .	3	Lighted handset keypad . . . . .	20
Battery Charge . . . . .	3, 9	Line Mode . . . . .	17
Battery information . . . . .	10	Location of Controls . . . . .	6, 7
Battery replacement . . . . .	10	<b>M</b>	
Battery strength . . . . .	10	Making Calls . . . . .	18, 19
Belt Clip . . . . .	40	Microphone . . . . .	18
<b>C</b>		MUTE . . . . .	35, 41
Call Waiting Caller ID . . . . .	36	<b>N</b>	
Call Waiting Tone . . . . .	36	Navigator key . . . . .	7
Caller ID Number Auto Edit Feature . . . . .	25	Noise . . . . .	3
Caller ID service . . . . .	21	<b>P</b>	
Caller List, editing . . . . .	24	PAUSE . . . . .	36
Caller List, erasing . . . . .	27	Phone Book, dialing . . . . .	30
Caller List, storing . . . . .	26	Phone Book, editing . . . . .	31
Caller List, viewing . . . . .	22	Phone Book, erasing . . . . .	31
Calling Back from the Caller List . . . . .	23	Phone Book, name . . . . .	29
Channel (CH) . . . . .	19	Phone Book, storing . . . . .	28
<b>D</b>		Power failure . . . . .	8
Dialing Mode . . . . .	13	Pulse service . . . . .	35
Display Language . . . . .	13	<b>R</b>	
<b>F</b>		Redial . . . . .	19
FCC and Other Information . . . . .	48	Redial list . . . . .	19
FLASH Button . . . . .	37	Ringer Off . . . . .	16
Flash time . . . . .	37	Ringer Tone . . . . .	17
Function Menu, Direct Commands . . . . .	42	Ringer Volume . . . . .	16
Function Menu, Selection . . . . .	11	Rotary service, Tone dialing . . . . .	35
Function Menu, Table . . . . .	12	<b>S</b>	
<b>H</b>		Safety Instructions . . . . .	46
Handset Locator . . . . .	35	Shipping product for service . . . . .	Back Cover
Headset . . . . .	40	Soft keys . . . . .	7
Hold . . . . .	19	Specifications . . . . .	55
		SP-phone . . . . .	18

# Index

---

## T

Troubleshooting . . . . . 43

## V

VM (Voice Mail Service). . . . . 32

Voice Enhancer Technology . . . . . 14

Volume control. . . . . 20, 41

## W

Wall Mounting . . . . . 38

Warranty . . . . . 53

PANASONIC CONSUMER  
ELECTRONICS COMPANY, DIVISION  
OF MATSUSHITA ELECTRIC  
CORPORATION OF AMERICA  
One Panasonic Way  
Secaucus, New Jersey 07094

PANASONIC SALES COMPANY,  
DIVISION OF MATSUSHITA  
ELECTRIC OF PUERTO RICO, INC.,  
Ave. 65 de Infanteria, Km. 9.5  
San Gabriel Industrial Park  
Carolina, Puerto Rico 00985

## Panasonic Telephone Products Limited Warranty

### Limited Warranty Coverage

If your product does not work properly because of a defect in materials or workmanship, Panasonic Consumer Electronics Company or Panasonic Sales Company (collectively referred to as "the warrantor") will, for the length of the period indicated on the chart below, which starts with the date of original purchase ("warranty period"), at its option either (a) repair your product with new or refurbished parts, or (b) replace it with a new or a refurbished product. The decision to repair or replace will be made by the warrantor.

Parts	Labor
One (1) Year	One (1) Year

During the "Labor" warranty period there will be no charge for labor. During the "Parts" warranty period, there will be no charge for parts. You must mail-in your product during the warranty period. This Limited Warranty excludes both parts and labor for batteries, antennas, and cosmetic parts (cabinet). This Limited warranty only applies to products purchased and serviced in the United States or Puerto Rico. This Limited warranty is extended only to the original purchaser and only covers products purchased as new.

### Mail-In Service

For assistance in the continental U.S.A. in obtaining repairs please ship the product to:

**Panasonic Services Company**  
**Customer Servicenter**  
**Suite B**  
**4900 George McVay Drive**  
**McAllen, TX 78503**

For assistance in Puerto Rico call Panasonic Sales Company (787)-750-4300 or fax (787)-768-2910.

For warranty service for headsets if a headset is included with this product please call Panasonic Call Center at 1-800-211-PANA (7262).

When shipping the unit carefully pack, include all accessories, and send it prepaid, adequately insured and preferably in the original carton. Include a letter detailing the complaint and provide a day time phone number where you can be reached.

**IF REPAIR IS NEEDED DURING THE WARRANTY PERIOD THE PURCHASER WILL BE REQUIRED TO FURNISH A SALES RECEIPT/PROOF OF PURCHASE INDICATING DATE OF PURCHASE, AMOUNT PAID AND PLACE OF PURCHASE. CUSTOMER WILL BE CHARGED FOR THE REPAIR OF ANY UNIT RECEIVED WITHOUT SUCH PROOF OF PURCHASE.**

### Limited Warranty Limits And Exclusions

This warranty ONLY COVERS failures due to defects in materials or workmanship, and DOES NOT COVER normal wear and tear or cosmetic damage. The warranty ALSO DOES NOT COVER damages which occurred in shipment, or failures which are caused by products not supplied by the warrantor, or failures which result from accidents, misuse, abuse, neglect, mishandling, misapplication, alteration, faulty installation, set-up adjustments, misadjustment of consumer controls, improper maintenance, power line surge, lightning damage, modification, introduction of sand, humidity or liquids, commercial use such as hotel, office, restaurant, or other business or rental use of the product, or service by anyone other than a Factory Servicenter or other Authorized Servicer, or damage that is attributable to acts of God.

**THERE ARE NO EXPRESS WARRANTIES EXCEPT AS LISTED UNDER "LIMITED WARRANTY COVERAGE". THE WARRANTOR IS NOT LIABLE FOR INCIDENTAL OR CONSEQUENTIAL DAMAGES RESULTING FROM THE USE OF THIS PRODUCT, OR ARISING OUT OF ANY BREACH OF THIS WARRANTY.** (As examples, this excludes damages for lost time, lost calls or messages, cost of having someone remove or re-install an installed unit if applicable, travel to and from the servicer. The items listed are not exclusive, but are for illustration only.) **ALL EXPRESS AND IMPLIED WARRANTIES, INCLUDING THE WARRANTY OF MERCHANTABILITY, ARE LIMITED TO THE PERIOD OF THE LIMITED WARRANTY.**

Some states do not allow the exclusion or limitation of incidental or consequential damages, or limitations on how long an implied warranty lasts, so the exclusions may not apply to you.

This warranty gives you specific legal rights and you may also have other rights which vary from state to state. If a problem with this product develops during or after the warranty period, you may contact your dealer or Servicenter. If the problem is not handled to your satisfaction, then write to the warrantor's Consumer Affairs Department at the addresses listed for the warrantor.

**PARTS AND SERVICE, WHICH ARE NOT COVERED BY THIS LIMITED WARRANTY, ARE YOUR RESPONSIBILITY.**

## ***Customer Services Directory***

***For Product Information, Operating Assistance, Literature Request, Dealer Locations, and all Customer Service inquiries please contact: 1-800-211-PANA (7262), Monday-Friday 9 am-9 pm; Saturday-Sunday 10 am-7 pm, EST.***

***or send e-mail :***

***consumerproducts@panasonic.com***

***For hearing or speech impaired TTY users, TTY : 1-877-833-8855***

***Web Site: <http://www.panasonic.com>***

***You can purchase parts, accessories or locate your nearest servicenter by visiting our Web Site.***

### ***Accessory Purchases:***

**1-800-332-5368 (Customer Orders Only)**

**For hearing or speech impaired TTY users, TTY : 1-866-605-1277**

**Panasonic Services Company 20421 84th Avenue South, Kent, WA 98032**

**(6 am to 5 pm Monday - Friday; 6 am to 10:30 am Saturday; PST)**

**(Visa, MasterCard, Discover Card, American Express, Check)**

### ***Service in Puerto Rico***

***Matsushita Electric of Puerto Rico, Inc. Panasonic Sales Company/  
Factory Servicenter:***

***Ave. 65 de Infantería, Km. 9.5, San Gabriel Industrial Park,  
Carolina, Puerto Rico 00985***

***Phone (787)750-4300 Fax (787)768-2910***

# Specifications

---

## ■ Base unit

<b>Power Supply:</b>	AC Adaptor (120 V AC, 60 Hz)
<b>Power Consumption:</b>	Standby: Approx. 2.6 W Maximum: Approx. 3.9 W
<b>Frequency:</b>	2.402 GHz – 2.480 GHz
<b>Dimensions (H x W x D):</b>	Approx. 91 mm x 136 mm x 184 mm (3 <sup>19</sup> / <sub>32</sub> " x 5 <sup>11</sup> / <sub>32</sub> " x 7 <sup>1</sup> / <sub>4</sub> "
<b>Mass (Weight):</b>	Approx. 290 g (0.64 lb.)

## ■ Handset

<b>Power Supply:</b>	Ni-MH battery (2.4 V, 1,500 mAh)
<b>Frequency:</b>	2.402 GHz – 2.480 GHz
<b>Dimensions (H x W x D):</b>	Approx. 246 mm x 54 mm x 39 mm (9 <sup>11</sup> / <sub>16</sub> " x 2 <sup>1</sup> / <sub>8</sub> " x 1 <sup>17</sup> / <sub>32</sub> "
<b>Mass (Weight):</b>	Approx. 230 g (0.51 lb.)
<b>Security Codes:</b>	1,000,000

■ **Dialing Mode:** Tone (DTMF)/Pulse

■ **Operating Environment:** 5 °C – 40 °C (41 °F – 104 °F)

Specifications are subject to change without notice.

## For your future reference

Serial No. \_\_\_\_\_

Date of purchase \_\_\_\_\_

(found on the bottom of the unit)

Name and address of dealer \_\_\_\_\_

## Energy Star:

- As an ENERGY STAR® Partner, Panasonic has determined that this product meets the ENERGY STAR guidelines for energy efficiency. ENERGY STAR is a U.S. registered mark.



## For product service

- Call 1-800-211-PANA(7262) for the location of an authorized servicer.
- Panasonic's e-mail address for customer inquiries:  
consumerproducts@panasonic.com  
for customers in the USA or Puerto Rico ONLY

## When you ship the product

- Carefully pack your unit, preferably in the original carton.
- Attach a letter, detailing the symptom, to the outside of the carton.

### Symptom

---

- Send the unit to an authorized servicer, prepaid and adequately insured.
- Do not send your unit to the Panasonic Consumer Electronics Company listed below or to executive or regional sales offices. These locations do not repair consumer products.

- This cordless telephone is designed for use in the United States of America. Sale or use of this product in other countries may violate local laws.
- Ce téléphone sans fil est conçu pour être utilisé aux États-Unis d'Amérique. La vente ou l'emploi de cet appareil dans certains autres pays peut constituer une infraction à la législation locale.
- Este teléfono sin cordón fue elaborado para uso en los Estados Unidos de América. La venta o el empleo de este producto en ciertos países puede constituir violación de la legislación local.
- このコードレス電話機は、日本国外での使用を目的として設計されており、日本国内での使用は法律違反となります。従って、当社では日本国内においては原則として修理などのサービスは致しかねます。

**If you need assistance with the set-up or operation,  
please call 1-800-211-PANA(7262)**

**Panasonic Consumer Electronics Company,  
Division of Matsushita Electric Corporation of America**  
One Panasonic Way, Secaucus, New Jersey 07094

**Panasonic Sales Company,  
Division of Matsushita Electric of Puerto Rico, Inc.**  
Ave. 65 de Infantería, Km. 9.5, San Gabriel Industrial Park  
Carolina, Puerto Rico 00985