

Panasonic®

2.4 GHz Digital Cordless Phone

Operating Instructions

Model No. **KX-TG2335**

Pulse-or-tone dialing capability

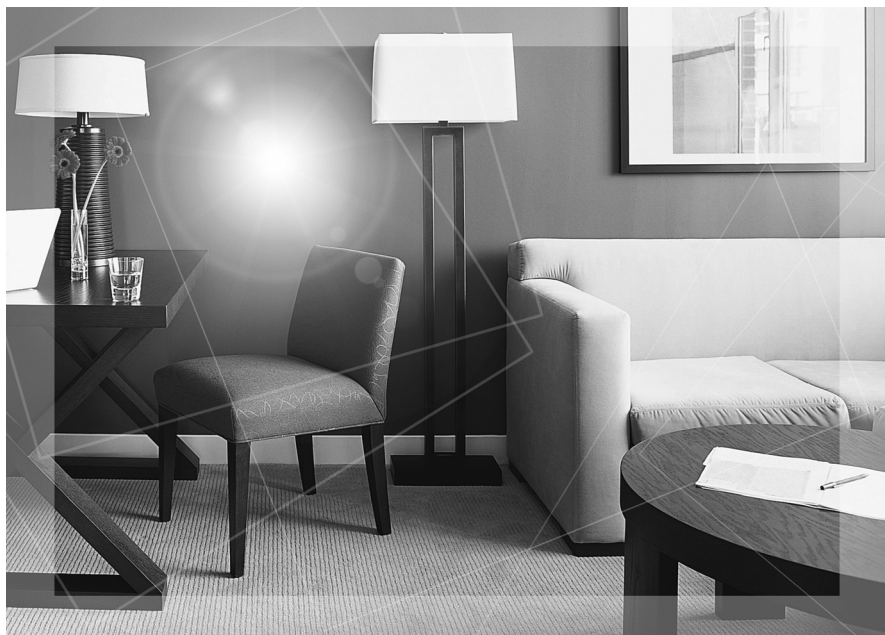

The unit is Caller ID compatible. To display the caller's name and phone number, you must subscribe to Caller ID service.

PLEASE READ BEFORE USE AND SAVE.

Charge the battery for 6 hours before initial use.

Panasonic World Wide Web address: <http://www.panasonic.com>
for customers in the USA or Puerto Rico

Thank you for purchasing your new Panasonic cordless telephone.

Please read the IMPORTANT SAFETY INSTRUCTIONS on page 59 before use. Read and understand all instructions.

Caller ID, Call Waiting and Voice Mail Service, where available, are telephone company services. After subscribing to Caller ID this phone will display a caller's name and phone number. Call Waiting Caller ID, which displays a second caller's name and phone number while the user is on another call, requires a subscription to both Caller ID and Call Waiting with Caller ID Services (CWID). After subscribing to Voice Mail Service, this unit will give you visual indication to let you know when there are messages in the mailbox.

Attach your purchase receipt here.

Accessories (included)

For extra orders, call 1-800-332-5368.

For hearing or speech impaired TTY users, call 1-866-605-1277.

- AC Adaptor (p. 8)
Order No. PQLV1Z (PQLV1)

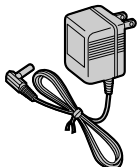

one

- Telephone Line Cord (p. 8)
Order No. PQJA10075Z

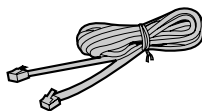

one

- Battery (p. 9)
Order No. HHR-P104



one

- Handset Cover (p. 9)
Order No. PQKK10141Z1

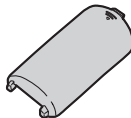

one

- Belt Clip (p. 50)
Order No. PQKE10375Z3



one

- Shoulder Rest Attachment (p. 50)
Order No. PQKE10364Z1



one

For Best Performance

Battery Charge

The handset is powered by a rechargeable Nickel-Metal Hydride (Ni-MH) battery. Charge the battery for **6 hours** before initial use (p. 9).



Base Unit Location/Noise

Calls are transmitted between the base unit and handset using wireless radio waves. **For maximum distance and noise-free operation**, the recommended base unit location is:

Away from electrical appliances such as a TV, personal computer or another cordless phone.

In a **HIGH** and **CENTRAL** location with no obstructions such as walls.

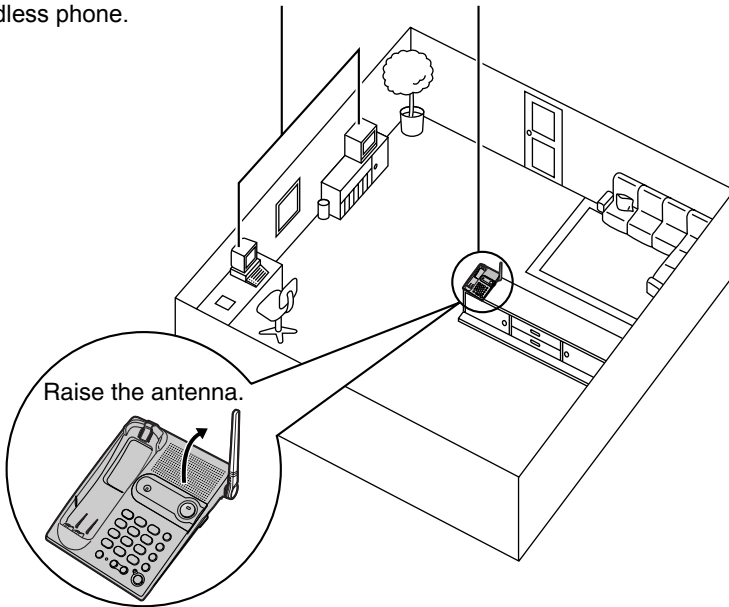

Note:

- If you use the handset near a microwave oven which is being used, noise may be heard from the receiver or the speaker. Move away from the microwave oven and closer to the base unit.
- If you use the handset near another cordless phone's base unit, noise may be heard. Move away from the other cordless phone's base unit and closer to your base unit.

Contents

Preparation

Location of Controls	6
Installation	8
Connections	8
Installing the Battery in the Handset	9
Battery Charge	9
Programmable Settings	11
Programming Guidelines ..	11
Function Menu Table	12
Display Language	13
Dialing Mode	13
Line Mode	14
Auto Talk	14
Ringer Volume	15
Ringer Tone	16
LCD Contrast	18
Message Alert	18

Basic Operation

Making Calls	19
Using the Handset	19
Using the Base Unit	22
Answering Calls	23
Caller ID Service	24
Talking Caller ID	25
Using the Caller List	26
Viewing the Caller List	27
Calling Back from the Caller List	27
Editing the Caller's Phone Number	28
Caller ID Number Auto Edit	29
Storing Caller Information in the Phone Book	30
Erasing Caller Information ..	31

Advanced Operation

Phone Book	32
Storing Names and Numbers	32
Dialing from the Phone Book	34
Chain Dial	35
Editing an Item in the Phone Book	36
Erasing an Item in the Phone Book	36
Intercom	37
Making Intercom Calls	37
Answering Intercom Calls ..	38
Transferring a Call	39
Conference Calls	41
Call Share	41
Voice Mail Service	42
Storing a Voice Mail Access Number	42
Setting Voice Mail (VM) Tone Detection	43
Listening to Voice Mail Messages	44
Special Features	46
Temporary Tone Dialing (For Rotary or Pulse Service Users)	46
Muting Your Conversation ..	46
For Call Waiting Service Users	46
Using the PAUSE Key (For PBX Line/Long Distance Calls)	47
FLASH Button	47
Incoming Call Tone	48
Key Tone	49
Re-registering the Handset	49

Useful Information

Belt Clip	50
Shoulder Rest Attachment ..	50
Wall Mounting	51
Optional Headset	52
Direct Commands	53
If the Following Appear on Your Display... ..	55
Troubleshooting	56
Important Safety	
Instructions	59
FCC and Other Information ..	60
Index	63
Warranty	65
Specifications	67

Important:

Throughout these Operating Instructions, **Handset** and **Base Unit** are used to indicate with which unit an operation can be performed.

Handset : Perform with the handset.

Base Unit : Perform with the base unit.

Handset Base Unit : Perform with the handset and base unit separately.

Handset & Base Unit : Perform with the handset and base unit together.

Location of Controls

Base unit

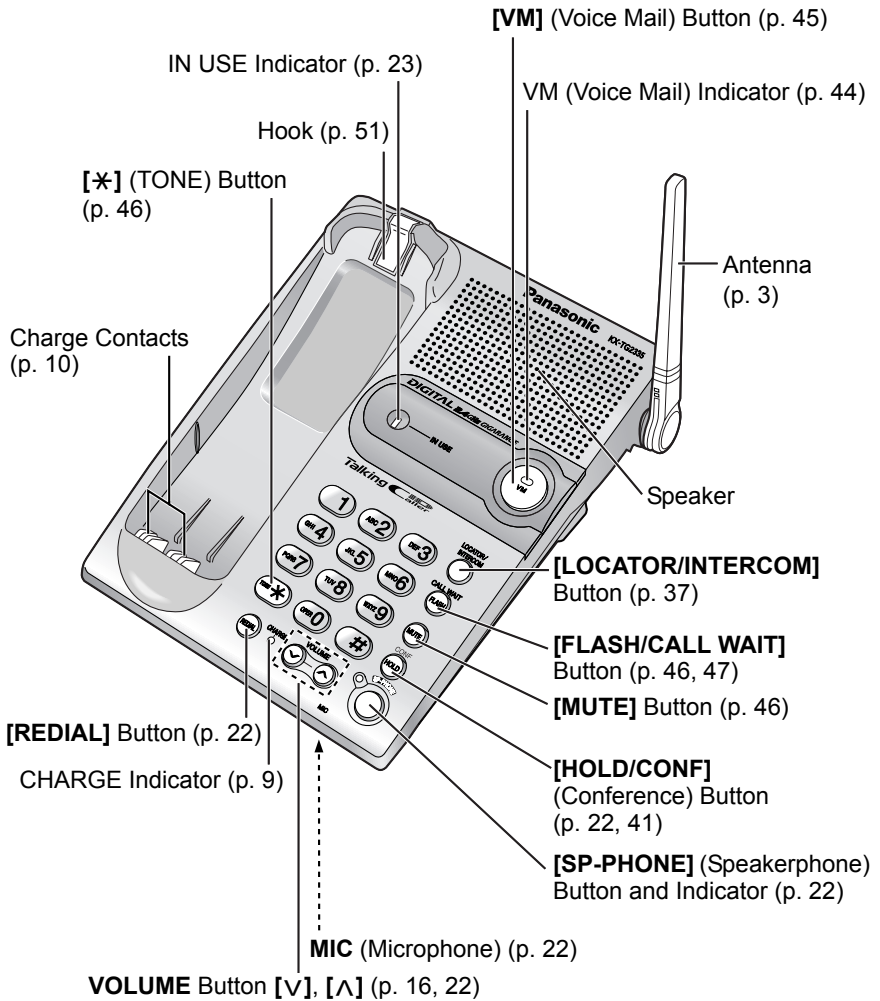

Location of Controls

Handset

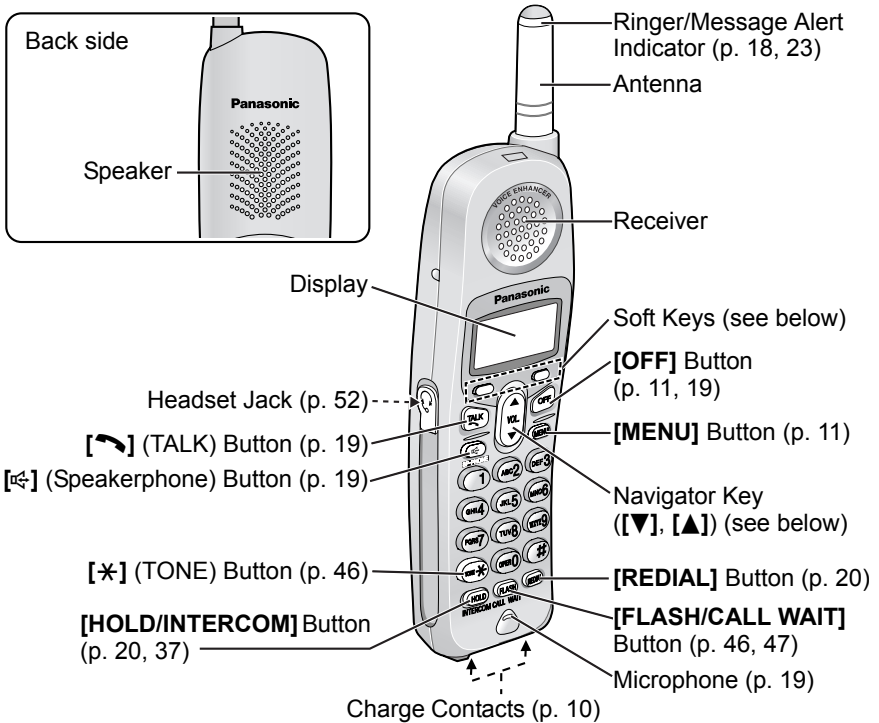
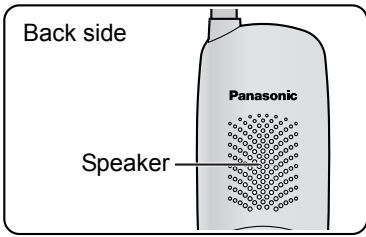

Handset soft keys

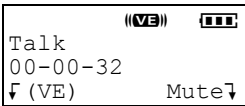

Two soft keys are used to select functions displayed directly above each key. Functions displayed above the keys will change depending on the state of use.

On this sample display, “↓ (VE)” and “Mute↓” are displayed above soft keys.

Pressing the right soft key selects mute “Mute↓”.

Pressing the left soft key selects Voice Enhancer “↓ (VE)”.

- When a function name does not appear above a soft key, the soft key has no function.

Handset navigator key



Scrolls up [▲] and down [▼] the function menu, the Caller List and the phone book.

Increases [▲] or decreases [▼] the handset ringer and receiver/speaker volumes.

Throughout these Operating Instructions:

- The soft keys are indicated by what is displayed above the keys.
Ex. “Press Mute.” indicates “Press the soft key below Mute↓”.
- The navigator key is indicated by the arrows [▼] or [▲].

Installation

Connections

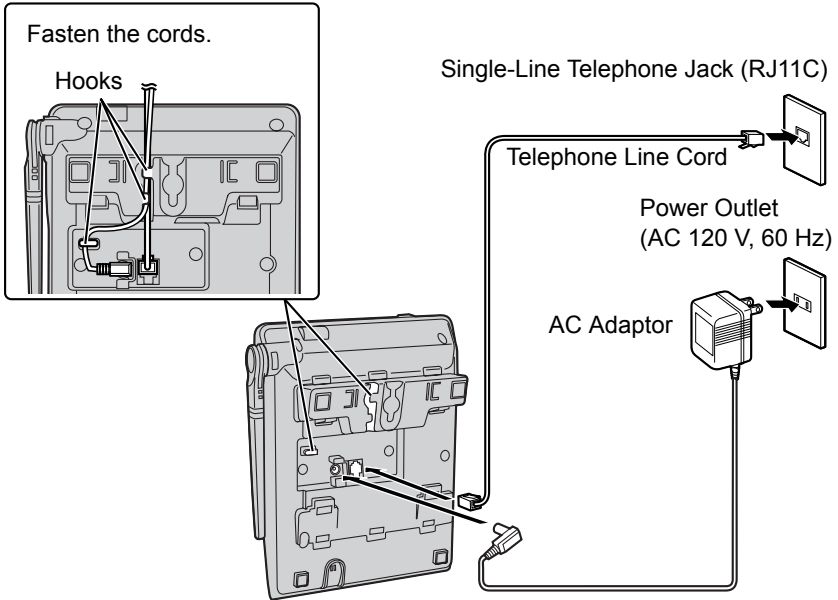

- USE ONLY WITH Panasonic AC ADAPTOR PQLV1 (Order No. PQLV1Z).
- The AC adaptor must remain connected at all times. (It is normal for the adaptor to feel warm during use.)
- If your unit is connected to a PBX which does not support Caller ID and voice mail services, you cannot access those services.
- The unit will not work during a power failure. We recommend connecting a standard telephone to the same telephone line or to the same telephone jack using the Panasonic KX-J66 T-adaptor.

Installing the Battery in the Handset

Insert the battery (①), and press it down until it snaps into the compartment (②). Close the cover.

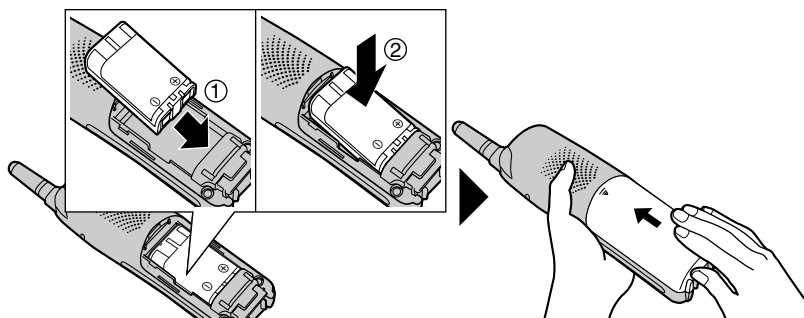

To replace the battery:

Press the notch on the cover firmly and slide it as indicated by the arrow. Replace the old battery with a new one (p. 10). Close the cover and charge the battery for 6 hours.

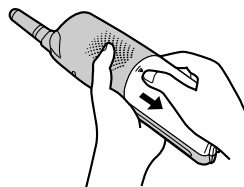

Battery Charge

Place the handset on the base unit.
Charge for **6 hours** before initial use.

- The unit beeps once, the CHARGE indicator lights, and “Charging” is displayed.
- When the battery is fully charged, “Charge completed” is displayed.

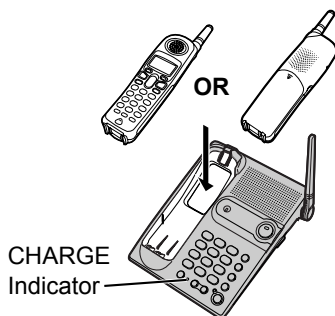

Battery strength

You can confirm battery strength on the handset display. Battery strength is indicated by the icons shown in the chart to the right.

Display prompt	Battery strength
	Fully charged
	Medium
	Low
(flashing)	Needs to be recharged.
	Discharged



Installation

Recharge

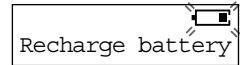

Recharge the battery when:

- “Recharge battery” is displayed on the handset,
- “” flashes, or
- the handset beeps intermittently while it is in use.



- The display will continually indicate “Recharge battery” and/or “” will flash when the handset battery is charged for less than 15 minutes and the handset is lifted off the base unit.
- If the battery has been discharged, the handset will display “Charge for 6h” and “” when you place the handset on the base unit. The handset will not work unless the battery is charged. Continue charging.

Battery replacement:

If you cleaned the charge contacts and fully charged the battery, but after a few telephone calls, “Recharge battery” is displayed and/or “” continues to flash, or “Charge for 6h” and “” are displayed, the battery may need to be replaced. Please order a new Panasonic HHR-P104 battery at the telephone number shown on page 2. To replace the battery, see page 9.

A nickel metal hydride battery that is recyclable powers the product you have purchased. Please call 1-800-8-BATTERY for information on how to recycle this battery.



Battery information

After your Panasonic battery is fully charged, you can expect the following performance:

Operation	Operating time
While in use (TALK)	Up to 5 hours
While not in use (Standby)	Up to 11 days

- A fully charged battery will give you up to 5 hours of continuous talk time, or keep your handset in Standby mode to receive incoming calls for up to 11 days (if no phone calls are made). Battery power is consumed whenever the handset is off of the base unit, even when the handset is not in use. The longer you leave the handset off of the base unit, the time you can actually talk on the handset will be shortened. Actual battery performance depends on a combination of how often the handset is in TALK mode and how often it is in Standby mode.
- If the battery is fully charged, you do not have to place the handset on the base unit until “Recharge battery” is displayed and/or “” flashes. This will maximize the battery life.
- If you want to keep the battery fully charged at all times, place the handset on the base unit when the handset is not used. The battery cannot be overcharged.
- **Clean the charge contacts of the handset and the base unit with a soft, dry cloth once a month. Clean more often if the unit is subject to grease, dust or high humidity.** Otherwise the battery may not charge properly.

Programmable Settings

Programming Guidelines **Handset**

This unit has several programmable functions which can be selected from the function menu on the display (p. 12).

The **soft keys** selects the functions displayed above each soft key.

When “▼” or “▲” is displayed, navigator key scrolls through the menu.

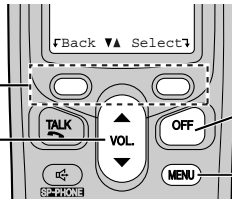

[OFF] exits programming.

[MENU] enters the function menu.

How to select a function item from the menu

Make sure the handset and base unit are not being used. The handset must be operated near the base unit and while off the base unit.

1 Press **[MENU]**.

- The main menu is displayed (p. 12).

2 Scroll to the desired item by pressing **[▼]** or **[▲]**.



3 Press **select** to select the desired item.



4 If the item has a sub-menu, select the menu item (p. 12). Repeat steps 2 and 3 until the desired item is displayed. If the item has no sub-menu, go to step 5.

5 Select the desired setting by pressing **[▼]** or **[▲]**, then press **save** to save your setting.

- A confirmation tone will be heard and the setting will be saved.



6 Press **[OFF]** to exit programming mode.

- To go back to the previous menu, press **Back**, or press **Select** while “--- (Go back) ---” is displayed. If you press this key in the main menu, the unit will exit programming mode.
- After programming is complete, the display will return to the main menu or the sub-menu depending on which menu the selected item is located. (See the menu table on page 12.)
- You can exit programming mode at any time by pressing **[OFF]**.
- If you do not press any buttons for 60 seconds, the handset will exit programming mode.
- If the unit detects a problem, an error message will be displayed (p. 55) and/or error beeps will sound.

Programmable Settings

Function Menu Table **Handset**

You can use the following functions to customize your unit. See the corresponding pages for function details.

- After pressing **[MENU]**, you can also program menu items directly by pressing (**[0]** to **[9]**, **[*]** and **[#]**) instead of using the soft keys (p. 53–54).

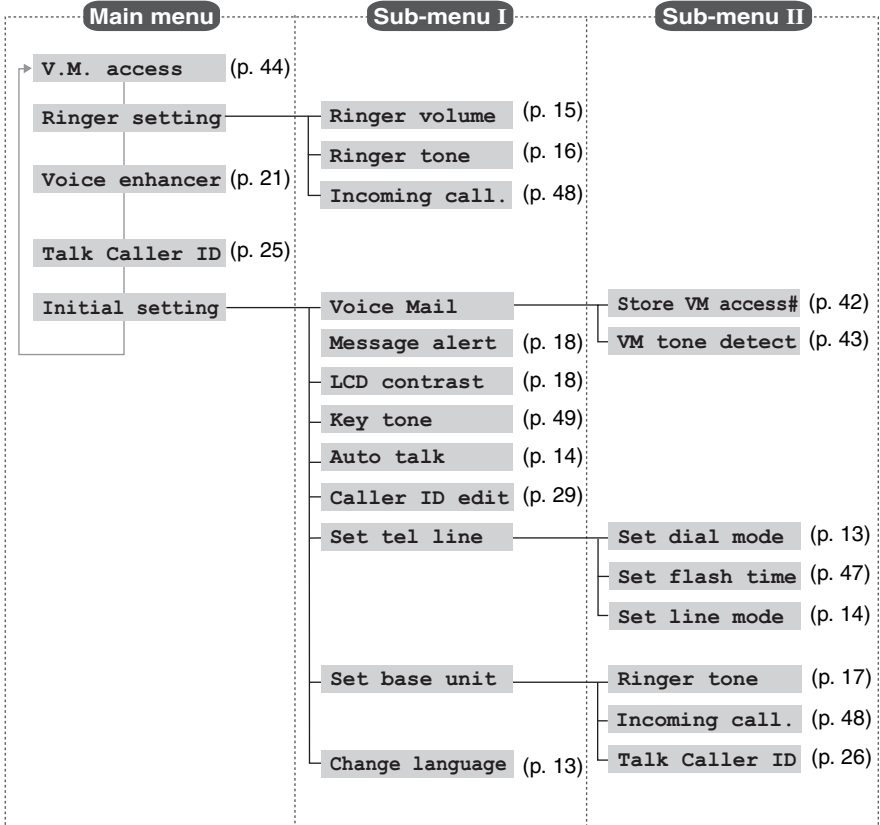

Display Language **Handset**

You can select either “English” or “Spanish” as the display language. The factory preset is “English”.

1 Press **[MENU]**.

2 Scroll to “Initial setting” by pressing **[▼]** or **[▲]**, then press **Select**.

Initial setting
 ⌵Back ▼▲ Select⌵

3 Scroll to “Change language” by pressing **[▼]** or **[▲]**, then press **Select**.

Change language
 ⌵Back ▼▲ Select⌵

4 To change from English to Spanish, press **Español**.

To change from Spanish to English, press **English**.

- The display changes to the selected language.
- You can also select a language by pressing **[▼]** or **[▲]**.

Display
 :English
 ⌵Español Save⌵

5 When Spanish is selected, press **salvar**, then press **[OFF]**.
 When English is selected, press **save**, then press **[OFF]**.

- If you select a language you cannot read, change the display language again using direct commands (p. 53).

Dialing Mode **Handset**

If you have touch tone service, set the dialing mode to “Tone”. For rotary or pulse service, set to “Pulse”. The factory preset is “Tone”.

1 Press **[MENU]**.

2 Scroll to “Initial setting” by pressing **[▼]** or **[▲]**, then press **Select**.

Initial setting
 ⌵Back ▼▲ Select⌵

3 Scroll to “Set tel line” by pressing **[▼]** or **[▲]**, then press **Select**.

Set tel line
 ⌵Back ▼▲ Select⌵

4 Press **select** at “Set dial mode”.

Set dial mode
 ⌵Back ▼▲ Select⌵

5 Select “Pulse” or “Tone” by pressing **[▼]** or **[▲]**.

Set dial mode
 :Tone
 ⌵Back ▼▲ Save⌵

6 Press **save**, then press **[OFF]**.

Programmable Settings

Line Mode **Handset**

The line mode is preset to “B” and generally should not be adjusted. If “Line in use” on the handset is not displayed properly or the IN USE indicator on the base unit does not light properly, the line mode selection is incorrect. Set line mode to “A”.

1 Press **[MENU]**.

2 Scroll to “Initial setting” by pressing **[▼]** or **[▲]**, then press **Select**.

```
Initial setting
↓Back ▼▲ Select↓
```

3 Scroll to “Set tel line” by pressing **[▼]** or **[▲]**, then press **Select**.

```
Set tel line
↓Back ▼▲ Select↓
```

4 Scroll to “Set line mode” by pressing **[▼]** or **[▲]**, then press **Select**.

```
Set line mode
↓Back ▼▲ Select↓
```

5 Select “A” or “B” by pressing **[▼]** or **[▲]**.

```
Set line mode
: B
↓Back ▼▲ Save↓
```

6 Press **save**, then press **[OFF]**.

Auto Talk **Handset**

The Auto Talk feature allows you to answer calls by simply lifting the handset off the base unit. You do not need to press **[📞]** or **[📞]**. The factory preset is OFF.

1 Press **[MENU]**.

2 Scroll to “Initial setting” by pressing **[▼]** or **[▲]**, then press **Select**.

```
Initial setting
↓Back ▼▲ Select↓
```

3 Scroll to “Auto talk” by pressing **[▼]** or **[▲]**, then press **Select**.

```
Auto talk
↓Back ▼▲ Select↓
```

4 Select “On” or “Off” by pressing **[▼]** or **[▲]**.

```
Auto talk
: Off
↓Back ▼▲ Save↓
```

5 Press **save**, then press **[OFF]**.

- In order to view Caller ID information after you lift the handset to answer a call, leave the Auto Talk feature turned off.

Ringer Volume

You can select the handset or base unit ringer volumes to high, medium, low, or off. The factory preset is HIGH. If the handset and base unit ringer is turned off, the handset or base unit will ring at the low level for intercom calls, and will not ring for outside calls. Caller names will not be announced even if the Talking Caller ID feature is turned on (p. 25, 26).

Handset ringer volume **Handset**

1 Press **[MENU]**.

2 Scroll to “Ringer setting” by pressing **[▼]** or **[▲]**, then press **Select**.

Ringer setting
⌄Back ▼▲ Select⌄

3 Press **Select** at “Ringer volume”.

Ringer volume
⌄Back ▼▲ Select⌄

4 Select the desired volume level by pressing **[▼]** or **[▲]**.

- The volume will change and ring.
- The number of steps indicates the volume level.
- **To turn the ringer off**, press **[▼]** repeatedly until “Off ?” is displayed.

Ex. High
Ringer volume
Low ■■■■■■ High
⌄Back ▼▲ Save⌄

5 Press **Save**.

- If the handset ringer is turned off, “Ringer off” will be displayed while not in use. If the handset is off the base unit when there are missed calls or new messages in your voice mailbox (p. 44), “Ringer off” is not displayed.
- You can adjust the ringer volume while an outside call is ringing. Press **[▼]** or **[▲]** while the handset is ringing.

Temporary ringer off

While the handset is ringing for an outside call, you can turn the ringer off temporarily by pressing **[OFF]**. The handset will ring again as normal the next time a call is received.

Programmable Settings

Base unit ringer volume **Base Unit**

Make sure the base unit is not being used.

To set the ringer volume to high (preset), medium, or low, press **VOLUME [V]** or **[^]**.

- To increase volume, press **VOLUME [^]**.
To decrease volume, press **VOLUME [V]**.
- To stop ringing, press **[0]**.

To turn the ringer off, press and hold **VOLUME [V]** until 2 beeps sound.

To turn the ringer on, press **VOLUME [V]** or **[^]**.

- The base unit will ring at the low level.
- You can adjust the ringer volume while an outside call is ringing. Press **VOLUME [V]** or **[^]** while the base unit is ringing.
To turn the ringer off, press and hold **VOLUME [V]** until 2 beeps sound.

Ringer Tone

You can set the handset and base unit ringers to use one of 7 ringer patterns for outside calls. “Tone 1” to “Tone 3” are bell ringer patterns. “Melody 1” to “Melody 4” are melody patterns. The factory preset is “Tone 1”.

- You cannot change the ringer tone for intercom calls.
- If you subscribe to a Distinctive Ring Service (such as IDENT-A-RING) from your telephone company with 2 or 3 consecutive rings, select a bell ringer pattern (Tone 1 to 3). If you select a melody pattern, you will not be able to distinguish lines by their ringers.
- If you select one of the melody ringer patterns, the ringer will continue to sound for several seconds if:
 - the caller hangs up before you answer the call, or
 - another person answers the call using another phone connected on the same line.

Handset ringer tone **Handset**

1 Press **[MENU]**.

2 Scroll to “Ringer setting” by pressing **[▼]** or **[▲]**, then press **Select**.



Ringer setting
↓Back ▲ Select↓

3 Scroll to “Ringer tone” by pressing **[▼]** or **[▲]**, then press **Select**.



Ringer tone
↓Back ▲ Select↓

4 Select the desired ringer tone by pressing [▼] or [▲].

- The handset will ring and the ringer tone will change. If the ringer volume has been turned off, the handset will not ring (p. 15).
- You can also select the ringer tone by pressing [1] to [7].

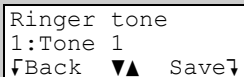

```
Ringer tone
1: Tone 1
↓Back  ▼▲  Save↓
```

5 Press **save**, then press [OFF].

Base unit ringer tone (use either the handset or the base unit)

Base Unit

Make sure the base unit is not being used.

Press **VOLUME** [V] or [^], then select the desired ringer tone by pressing [1] to [7].

[1] to [3] : Bell ringer patterns [4] to [7] : Melody patterns

- After pressing **VOLUME** [V] or [^], the base unit will ring using the current ringer tone.
- The base unit will ring and the ringer tone will change.
- To stop ringing, press [0].

Setting the base unit ringer tone by using the **Handset**

1 Press [MENU].

2 Scroll to “Initial setting” by pressing [▼] or [▲], then press **Select**.

3 Scroll to “Set base unit” by pressing [▼] or [▲], then press **Select**.

4 Press **select** at “Ringer tone”.

5 Select the desired ringer tone by pressing [▼] or [▲].

- The base unit will ring and the ringer tone will change. If the base unit ringer volume has been turned off, the base unit will not ring (p. 16).
- You can also select the ringer tone by pressing [1] to [7].

6 Press **save**, then press [OFF].

Programmable Settings

LCD Contrast **Handset**

There are 6 levels of LCD contrast. The factory preset is "level 3".

1 Press **[MENU]**.

2 Scroll to "Initial setting" by pressing **[▼]** or **[▲]**, then press **Select**.

Initial setting
↓Back ▼▲ Select↓

3 Scroll to "LCD contrast" by pressing **[▼]** or **[▲]**, then press **Select**.

LCD contrast
↓Back ▼▲ Select↓

4 Select the desired contrast by pressing **[▼]** or **[▲]**.
• The contrast will change.

Ex. Level 3
LCD contrast
Low ■■■ High
↓Back ▼▲ Save↓

5 Press **save**, then press **[OFF]**.

Message Alert **Handset**

You can select whether or not the Ringer/Message Alert indicator on the handset will flash slowly when new messages in your voice mailbox have been recorded (p. 44). The factory preset is OFF.

1 Press **[MENU]**.

2 Scroll to "Initial setting" by pressing **[▼]** or **[▲]**, then press **Select**.

Initial setting
↓Back ▼▲ Select↓

3 Scroll to "Message alert" by pressing **[▼]** or **[▲]**, then press **Select**.

Message alert
↓Back ▼▲ Select↓

4 Select "On" or "Off" by pressing **[▼]** or **[▲]**.

Message alert
:Off
↓Back ▼▲ Save↓

5 Press **save**, then press **[OFF]**.

- The Ringer/Message Alert indicator will not flash for new messages while the handset is in use.
- The Ringer/Message Alert indicator acts both as a ringer indicator and as a message alert indicator. This indicator will flash rapidly when a call is received whether this feature is on or off.
- Battery operating time may be shortened when using this feature (p. 10).

Making Calls

Using the Handset **Handset**

1 Press [].

- “Talk” is displayed.

2 Dial a phone number.

- The dialed number is displayed.
- After a few seconds, the display will show the length of the call.

3 To hang up, press **[OFF]** or place the handset on the base unit.

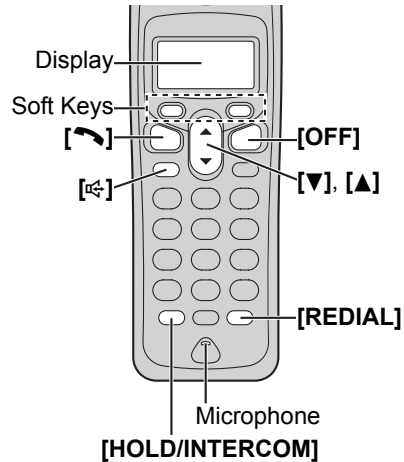

To have a hands-free phone conversation

1 Press [].

- “SP-phone” is displayed.

2 Dial a phone number.



- The dialed number is displayed.
- After a few seconds, the display will show the length of the call.

3 When the other party answers, talk into the microphone.

4 To hang up, press **[OFF]** or place the handset on the base unit.

Hands-free Digital Duplex Speakerphone

For best performance, please note the following:

- Talk alternately with the other party in a quiet room.
- If you or the other party has difficulty hearing, press [▼] to decrease the speaker volume.
- While talking using [, you can switch to a hands-free phone conversation by pressing []. To switch back to the receiver, press [].

Making Calls

To dial after confirming the entered number

- 1 Enter a phone number.



- If you misdial, press **Clear**. Enter the correct number.
- If a pause is required when dialing, press **Pause** where needed (p. 47).
- To cancel, press **[OFF]**.

- 2 Press **[↶]** or **[↷]**.

- 3 To hang up, press **[OFF]** or place the handset on the base unit.

To adjust the receiver/speaker volume during a conversation

There are 3 volume levels for the receiver and 6 volume levels for the speaker.

- To increase volume, press **[▲]**.
To decrease volume, press **[▼]**.

Ex. Receiver volume: High
Speaker volume: Level 6



- The display shows the current volume setting.
- If you try to increase/decrease volume when it is at the maximum/minimum level, the handset will beep 3 times.

To redial the last number dialed

Press **[↶]** or **[↷]**, then press **[REDIAL]**.

To redial using the redial list (Memory Redial)

The last 5 phone numbers dialed are stored in the redial list.

- 1 Press **[REDIAL]**.

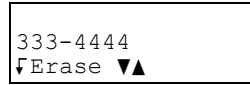

- The last number dialed is displayed.

- 2 Scroll to the desired number by pressing **[▼]** or **[▲]**.

- You can also scroll down through the list by pressing **[REDIAL]**.
- To exit the list, press **[OFF]**.

- 3 Press **[↶]** or **[↷]**.

- To **erase an item**, scroll to the item then press **Erase**.
- If "No items stored" is displayed, the list is empty.

To put a call on hold

- 1 Press **[HOLD/INTERCOM]** during a conversation.

- "Line on hold." is displayed.
- To transfer the call to the base unit, see page 39.

- 2 Press **[HOLD/INTERCOM]** again.

- "Hold" is displayed.

To return to the call, press **[↶]** or **[↷]**.

- The base unit user can also take the call by pressing **[SP-PHONE]**.
- If another phone is connected on the same line (p. 8), you can also take the call by lifting its handset.
- If a call is kept on hold for 6 minutes, an alarm tone will start to sound and the Ringer/Message Alert indicator will start to flash rapidly. After 4 additional minutes on hold, the call will be disconnected.

Voice Enhancer Technology

Panasonic's Voice Enhancer Technology clarifies the voice of the person you are talking to, reproducing a more natural-sounding voice that is easier to hear and understand.

Voice Enhancer Technology can be turned on or off. The factory preset is OFF.

- Depending on the condition and quality of your telephone line, this feature may emphasize existing line noise. If it becomes difficult to hear, turn this feature off.

To turn this feature on, press **(VE)** during a conversation.

- “**(VE)**” is displayed.
- **To turn this feature off**, press **(VE)** again. “**(VE)**” disappears from the display.
- After hanging up a call, the on/off setting will be retained.

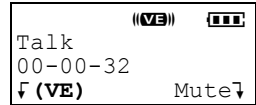

- If you store a voice mail access number (p. 42), “**VM**” will be displayed instead of “**(VE)**” for 15 seconds after pressing **[]** or **[]**.

When the handset is not in use, you can also turn this feature on or off by programming as follows:

1. Press **[MENU]**.
2. Scroll to “Voice enhancer” by pressing **[▼]** or **[▲]**, then press **Select**.
3. Select “On” or “Off” by pressing **[▼]** or **[▲]**.
4. Press **save**, then press **[OFF]**.

Backlit LCD display/Lighted handset keypad

The handset display and dialing buttons will light for a few seconds after pressing a button or lifting the handset off the base unit.

Making Calls

Using the Base Unit **Base Unit**

- 1 Press **[SP-PHONE]**.
 - The SP-PHONE indicator lights.
- 2 Dial a phone number.
- 3 When the other party answers, talk into the **MIC** (microphone).
- 4 To hang up, press **[SP-PHONE]**.
 - The indicator light goes out.

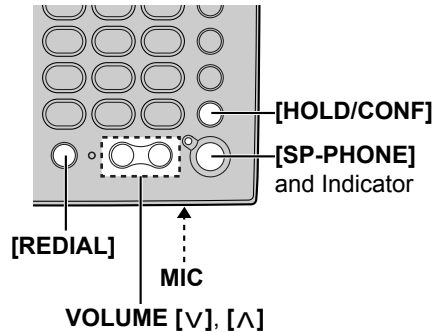

- To switch to the handset while using the base unit speakerphone:
 - If the handset is off the base unit, press **[📞]** or **[📞]** on the handset, then press **[SP-PHONE]** on the base unit.
 - If the handset is on the base unit, just lift up.

Hands-free Digital Duplex Speakerphone

For best performance, please note the following:

- Talk alternately with the other party in a quiet room.
- If you or the other party has difficulty hearing, press **VOLUME [V]** to decrease the speaker volume.

To adjust the speaker volume during a conversation

To increase volume, press **VOLUME [^]**.

To decrease volume, press **VOLUME [V]**.

- There are 8 volume levels. If you try to increase/decrease volume when it is at the maximum/minimum level, the base unit will beep 3 times.

To redial the last number dialed

Press **[SP-PHONE]**, then press **[REDIAL]**.

To put a call on hold

Press **[HOLD/CONF]** during a conversation.

- The SP-PHONE indicator flashes.

To return to the call, press **[SP-PHONE]**.

- The handset user can also take the call by pressing **[📞]** or **[📞]**.
- If another phone is connected on the same line (p. 8), you can also take the call by lifting its handset.
- If a call is kept on hold for 6 minutes, an alarm tone will start to sound. After 4 additional minutes on hold, the call will be disconnected.

Answering Calls

When a call is received, the unit rings, "Incoming call" is displayed, and the Ringer/Message Alert indicator on the handset and the IN USE indicator on the base unit flash rapidly. If you subscribe to Caller ID, see page 24.

Handset

- 1 Press [] or [].
 - You can also answer a call by pressing any button except [▼], [▲] or [OFF].
- 2 To hang up, press [OFF] or place the handset on the base unit.

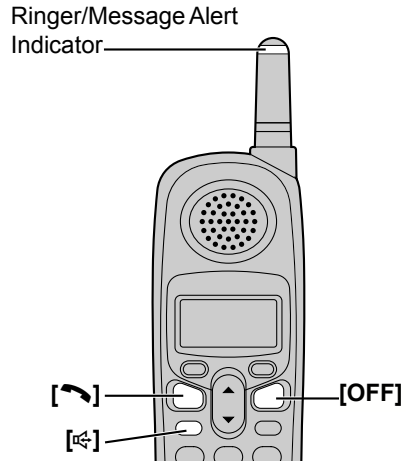

Auto Talk

If the Auto Talk feature is turned on (p. 14), you can answer a call by simply lifting the handset off the base unit.

Temporary ringer off

You can turn the ringer off temporarily by pressing [OFF], while the handset is ringing for an outside call. The handset will ring again as normal the next time a call is received.

Base Unit

- 1 Press [SP-PHONE].
- 2 Talk into the MIC.
- 3 To hang up, press [SP-PHONE].

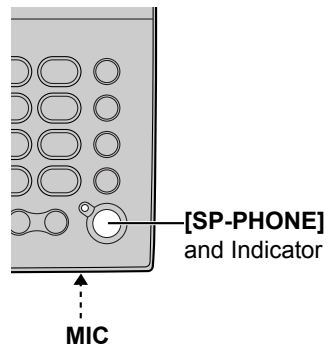

- To transfer the call to another person, see page 39.
- If the ringer volume is turned off, the unit will not ring (p. 15, 16).

Caller ID Service

This unit is compatible with Caller ID services offered by your telephone company. If you subscribe to Caller ID, caller names and phone numbers will be displayed and recorded in the Caller List.

How Caller ID information is displayed and announced

When a call comes in, the unit will ring and Caller ID information will be received. The handset display will show the caller's information, then the handset and base unit will announce the displayed name (ex. "Call from ROBINSON, TINA") following every ring (**Talking Caller ID feature**, p. 25).

Example

ROBINSON, TINA 1-555-222-3333

- After you answer the call, the display will show the length of the call.
- The handset and base unit announce the caller's name repeatedly until the call is answered.
- If the unit does not receive Caller ID information, one of the following will be displayed:

Display	Meaning
Out of area	The caller dialed from an area which does not provide Caller ID service.
Private caller	The caller requested not to send his/her information.
Long distance	The caller made a long distance call.

- Depending on the radio communications with the base unit, the handset may not display Caller ID information immediately after the first ring.
- If your unit is connected to a PBX which does not support Caller ID, you cannot access Caller ID service.
- Name display service may not be available in some areas. For further information, please contact your telephone company.
- If you subscribe to both Caller ID and Call Waiting with Caller ID services (CWID), when a second call is received while talking, a call waiting tone will be heard and the second caller's information will be displayed on the handset in use (p. 46). Contact your telephone company for details about availability in your area, and to verify that CWID service is activated on your telephone line.

Talking Caller ID

To use this feature, you need to subscribe to Caller ID. For further information, please contact your telephone company.

- If the unit does not receive Caller ID information, the unit will announce “Call from out of area”, “Call from private caller”, or “Call from long distance”. If a call is received from an area where name display service is not available, “Number available” will be announced.
- If the ringer volume of the handset and base unit is off, caller names will not be announced. The announcement is heard at the handset or base unit ringer volume (p. 15, 16).
- If this feature is not turned on, caller names will not be announced (see below and page 26).
- If you have Call Waiting service, the second caller’s information will be displayed but not announced (For Call Waiting Service Users, page 46).
- Name pronunciation may vary. Name pronunciation quality is based on names most commonly used in the United States.
- The unit will announce each letter of abbreviations, such as “Co.” and “Inc.”.
- Caller ID supports names of up to 15 letters. If the caller’s name has more than 15 letters, the name will not be displayed or announced correctly.
- If you subscribe to a Distinctive Ring Service (such as IDENT-A-RING) from your telephone company with 2 or 3 consecutive rings, your unit may mute one or more of the rings in order to announce the name of the caller.

To turn Talking Caller ID on or off

You can turn Talking Caller ID on or off for the handset and base unit separately. If this feature is off, the unit will not announce caller names. The factory preset is ON.

Handset Talking Caller ID feature **Handset**

1 Press **[MENU]**.

2 Scroll to “Talk Caller ID” by pressing **[▼]** or **[▲]**, then press **Select**.



Talk Caller ID
↓Back ▼▲ Select↓

3 Select “Off” or “On” by pressing **[▼]** or **[▲]**.

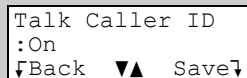

Talk Caller ID
:On
↓Back ▼▲ Save↓

4 Press **save**, then press **[OFF]**.

Caller ID Service

Base unit Talking Caller ID feature **Handset**

This feature must be turned on or off for the base unit by using the handset.

1 Press **[MENU]**.

2 Scroll to "Initial setting" by pressing **[▼]** or **[▲]**, then press **Select**.

```
Initial setting
┆Back ▼▲ Select┆
```

3 Scroll to "Set base unit" by pressing **[▼]** or **[▲]**, then press **Select**.

```
Set base unit
┆Back ▼▲ Select┆
```

4 Scroll to "Talk Caller ID" by pressing **[▼]** or **[▲]**, then press **Select**.

```
Talk Caller ID
┆Back ▼▲ Select┆
```

5 Select "Off" or "On" by pressing **[▼]** or **[▲]**.

```
Talk Caller ID
:On
┆Back ▼▲ Save┆
```

6 Press **save**, then press **[OFF]**.

Using the Caller List

The unit can record information up to 50 different callers and store this information in the Caller List. Caller information is sorted by the most recent call to the oldest. When the 51st call is received, the information from the 1st call is deleted.

The unit will also tell you how many calls you missed while you were out or unavailable to answer the phone.

Handset on the base unit

```
2 missed calls — ①
Charging
```

Handset off the base unit

```
2 missed calls — ①
Rcvd Phone — ②
┆calls book ┆
```

① The display will show the number of calls you missed.

② Press **Rcvd calls** to review other calls logged in the Caller List.

- If there are no items in the Caller List, "Rcvd calls" will not be displayed.
- After viewing the missed call entries, "missed calls" will disappear from the display.
- When your voice mailbox has received message(s), "Voice Mail" will be displayed in place of missed calls display (p. 44).

Viewing the Caller List **Handset**

1 Press **Rcvd calls**, [**▼**], or [**▲**] to enter the Caller List.

Ex. 2 calls missed.

```

2 missed calls
Rcvd      Phone
↓calls    book ↓
    
```

```

2 missed calls
▼▲=Scroll list
↓All erase
    
```

2 To search from the most recent call, press [**▼**]. To search from the oldest call, press [**▲**].

- The caller's name, number and the time and date of the call are displayed. Name and phone number are alternately displayed as shown on the right.

Example

```

SMITH, JACK
3:10P JUN.29
↓Erase Select↓
    
```



```

1-555-333-4444
3:10P JUN.29
↓Erase Select↓
    
```

3 Press [**OFF**] to exit the list.

- If there is no name information for a caller, the display will only show the phone number.
- If you do not press any buttons for 60 seconds, the unit will exit the Caller List.

What “√” means

“√” indicates you have already viewed this calling information or answered the call. If the same caller calls again, the call entry with the “√” will be replaced with the new call entry.

```

SMITH, JACK
3:10P JUN.29 √
    
```

If a caller calls more than once

The number of times the same caller called is displayed (“x2” to “x9”). The date and time of the most recent call will be recorded. After viewing a caller's information, “x2” to “x9” will be replaced with “√”.

Ex. Called 2 times.

```

TURNER, CINDY
11:20A JUN.12 x2
    
```

Calling Back from the Caller List **Handset**

1 Press **Rcvd calls**, [**▼**], or [**▲**] to enter the Caller List.

2 Scroll to the desired caller by pressing [**▼**] or [**▲**].

3 Press [**↶**] or [**☎**].

- The phone number is dialed.

- In some cases, you may have to edit the number before dialing (p. 28). (Ex. You may have to delete “1” and the area code.)
- If a phone number is not displayed in the caller information, you cannot call that caller back from the Caller List.

Using the Caller List

Editing the Caller's Phone Number **Handset**

You can edit a phone number in the Caller List by removing its area code and/or the long distance code "1".

Once you call back an edited number, this unit can automatically edit incoming phone numbers from the same area code in the Caller List and each time you receive a call (**Caller ID Number Auto Edit**, page 29).

1 Press **Rcvd calls**, [**▼**], or [**▲**] to enter the Caller List.

2 Scroll to the desired caller by pressing [**▼**] or [**▲**].

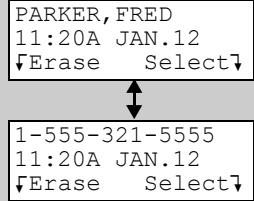

3 Press **Select**.

4 Press **Edit** repeatedly until the number is shown in the desired format.

- Each time you press **Edit**, the number is rearranged into one of 3 patterns.

- (a)
- (b) -
- (c) 1- -

- The order in which patterns (a)–(c) are displayed depends on how the telephone number is displayed in step 2.

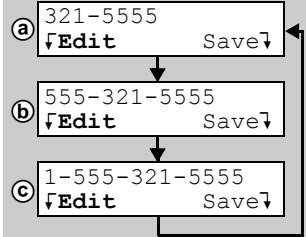

5 To call the edited number, press [**↶**] or [**↷**].

- If Caller ID Number Auto Edit is turned on (factory preset is on), phone numbers with the same area code as the number you edited will now be edited in the Caller List and each time you receive a call.
- You can press [**OFF**] immediately after pressing [**↶**] or [**↷**] if you wish to activate the Auto Edit feature without actually dialing the number you just edited.

To save the edited number into the phone book, press **Save.**

- If there is no name information, see "Storing Caller Information in the Phone Book" on page 30, from step 4.
- Even if the Auto Edit feature is turned on, this feature will not be activated by saving the edited number in the phone book.

Caller ID Number Auto Edit **Handset**

Once you call back an edited number (p. 28), this unit can automatically edit incoming phone numbers from the same area code in the Caller List and each time you receive a call. For example, it can ignore the area code of calls originating from your area code, so that you can call these numbers from the Caller List without dialing the area code.

To activate this feature, you must edit a caller's phone number in the Caller List (p. 28) by selecting pattern **(a)**, **(b)**, or **(c)**, then make a call to that number. Calls from numbers in that area code will be edited automatically. The unit can remember up to 4 area codes to be edited according to patterns **(a)** and **(b)**.

When more than 5 area codes are edited, older area codes are reset to pattern **(c)**. Phone numbers from the 4 most recently edited area codes will be automatically edited.

You can turn this feature on or off using the handset. The factory preset is ON.

To turn Caller ID Number Auto Edit on or off

1 Press **[MENU]**.

2 Scroll to "Initial setting" by pressing **[▼]** or **[▲]**, then press **Select**.

Initial setting
 ↓Back ▼▲ Select↓

3 Scroll to "Caller ID edit" by pressing **[▼]** or **[▲]**, then press **Select**.

Caller ID edit
 ↓Back ▼▲ Select↓

4 Select "Off" or "On" by pressing **[▼]** or **[▲]**.

Auto edit
 :On
 ↓Back ▼▲ Save↓

5 Press **save**, then press **[OFF]**.

- If you fail to reach your destination when making a call, the phone number you dialed might have an incorrect pattern. Edit the phone number with another pattern (p. 28).
- When this feature is turned off, the unit will still be able to display Caller ID, but incoming Caller ID numbers will not be automatically edited.
- If you move to another area, you may need to turn this feature off to erase the previously edited area codes. To use this feature again, turn it on and reprogram the area codes you want to edit once again.

Using the Caller List

Storing Caller Information in the Phone Book

Handset

Caller names and phone numbers that are in the Caller List can be stored in the phone book.

- 1** Press **Rcvd calls**, **[▼]**, or **[▲]** to enter the Caller List.

```
2 missed calls
Rcvd      Phone
└calls    book┘
```

```
2 missed calls
▼▲=Scroll list
└All erase┘
```

- 2** Scroll to the desired caller by pressing **[▼]** or **[▲]**.

```
TURNER, CINDY
11:00A JUN.12 x3
└Erase  Select┘
```



```
1-555-456-7890
11:00A JUN.12 x3
└Erase  Select┘
```

- 3** Press **Select**.

- If the number requires editing, see page 28.

- 4** Press **Save**.

```
TURNER, CINDY
1-555-456-7890
└Edit      Save┘
```

- If there is no name information for the caller, "Enter name" will be displayed.
 - You can enter a name by performing the following steps:
 - (1) enter the name (p. 33),
 - (2) press **[▼]**, and
 - (3) press **Save**.
 - If a name is not required, press **[▼]**, then press **Save**.
- To continue storing other items, repeat from step 2.
- To exit programming mode, press **[OFF]**.

```
Enter name
█
      ▼=Next  ▶┘
```

```
CINDY TURNER
└◀  ▼=Next  ▶┘
```

- You cannot store Caller List item in the phone book if a phone number is not displayed.

Erasing Caller Information **Handset**

To erase a specific caller

<p>1 Press Rcvd calls, [▼], or [▲] to enter the Caller List.</p>	<div style="border: 1px solid black; padding: 5px; margin-bottom: 5px;"> 2 missed calls Rcvd Phone ↓calls book ↓ </div> <div style="border: 1px solid black; padding: 5px;"> 2 missed calls ▼▲=Scroll list ↓All erase </div>
<p>2 Scroll to the desired caller by pressing [▼] or [▲], then press Erase.</p> <ul style="list-style-type: none"> • To erase other items, repeat step 2. • To exit the Caller List, press [OFF]. 	<div style="border: 1px solid black; padding: 5px; margin-bottom: 5px;"> REAGAN, TOM 12:20A JUN.12 ↓Erase Select↓ </div> <div style="border: 1px solid black; padding: 5px; text-align: center;"> Erased </div>

To erase all entries

Before erasing all entries, make sure that you have viewed all missed calls.

<p>1 Press Rcvd calls, [▼], or [▲] to enter the Caller List.</p>	<div style="border: 1px solid black; padding: 5px;"> Rcvd Phone ↓calls book ↓ </div>
<p>2 Press All erase.</p>	<div style="border: 1px solid black; padding: 5px;"> 0 missed call ▼▲=Scroll list ↓All erase </div>
<p>3 Press Yes.</p> <ul style="list-style-type: none"> • All entries in your Caller List are erased. 	<div style="border: 1px solid black; padding: 5px; margin-bottom: 5px;"> All erase? ↓No Yes↓ </div> <div style="border: 1px solid black; padding: 5px; text-align: center;"> All erased </div>

• To cancel erasing, press **No** after step 2.

Phone Book

The handset can store up to 50 names and phone numbers in its phone book. You can make a call by selecting a name or number from the phone book.

Storing Names and Numbers **Handset**

1 Press **Phone book**.



Rcvd Phone
↵calls book ↵

2 Press **Add**.

- The display will show the number of stored items.

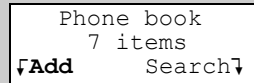

Phone book
7 items
↵Add Search↵

3 Enter a name of up to 16 characters with the dialing buttons (**[0]** to **[9]**) (p. 33), then press **[▼]**.

- If a name is not required, press **[▼]** then go to step 4.

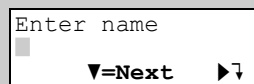

Enter name
█
▼=Next ▶↵

Example ↓
Tom
↵◀ ▼=Next ▶↵

4 Enter a phone number of up to 32 digits.

- Each time you press **◀**, a digit is erased. To erase all of the digits, press and hold **◀**.
- If a pause is required when dialing, press **P**. A pause is stored in a phone number as one digit (p. 47).

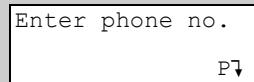

Enter phone no.
P↵

Example ↓
5557654321 █
↵◀ ▼=Next P↵

5 Press **[▼]**.

- If you want to change the name, press **Edit**. The display returns to step 3. Change the name.
- If you want to change the number, press **[▲]**. The display returns to step 4. Change the number.

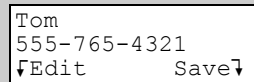

Tom
555-765-4321
↵Edit Save↵

6 Press **Save**.

- To continue storing other items, repeat from step 2.

7 Press **[OFF]**.

- To store numbers for calling card access (see “Chain Dial” on page 35), we recommend you add pauses after each item. Storing pauses with numbers will prevent misdialing (p. 47). The delay time necessary will depend on your telephone company.

Selecting characters to enter names

Enter names using the dialing buttons. Press each button until the desired character is displayed.

- Pressing each button selects a character in the order shown below.

Keys	Characters	Keys	Characters
[1]	# & ' () * , - . / 1	[6]	m n o M N O 6
[2]	a b c A B C 2	[7]	p q r s P Q R S 7
[3]	d e f D E F 3	[8]	t u v T U V 8
[4]	g h i G H I 4	[9]	w x y z W X Y Z 9
[5]	j k l J K L 5	[0]	0 Space
◀	Erases the character to the left.		
▶	Moves the cursor to the right. (To enter another character using the same number key, move the cursor to the next space.)		

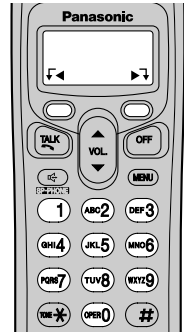

For example, to enter “Tom”:

1 Press [8] four times.

T

2 Press [6] three times, then press ▶ to move the cursor.

To

3 Press [6] once.

Tom

If you make a mistake when entering a name or number

Use ◀ to erase the incorrect character. Each time you press ◀, a character is erased. Re-enter the correct character. To erase all characters, press and hold ◀.

Phone Book

Dialing from the Phone Book **Handset**

1 Press **Phone book**.

2 Press **Search**.

Phone book
7 items
└Add Search┘

3 Scroll to the desired item. To scroll down, press [▼]. To scroll up, press [▲].

0-9=Name search
▼▲=Scroll list

Phone book items are sorted in the following order:

1	Alphabet letters (Alphabetical)
2	Space & ' () , - . /
3	Numbers 0 to 9
4	☎ *
5	Telephone numbers (If no name is stored)

4 Press [↶] or [↷].

- The dialed phone number is dialed.

Frank
444-5555
└Erase Edit┘

- If “No items stored” is displayed in step 1, the phone book is empty.
- To exit the phone book, press **[OFF]**.
- To view a phone number over 16 digits long, repeat steps 1 to 3, then press **Edit** and then [▼]. When finished, press **[OFF]**.
- To quickly search the desired item, press [▼] or [▲] after step 1.

To search for a name by initial

1. Press **Phone book**.

2. Press **Search**.

3. Press the dialing button for the first letter of the desired name until any name with the same initial is displayed (see the Index on page 35).
Ex. To find “Frank”, press **[3]** repeatedly until the first item under “F” is displayed.

- If there are no items beginning with the character you selected, the first item in the next alphabetical index will be displayed.

4. Press [▼] repeatedly until the desired name is displayed.

Index table

Keys	Index	Keys	Index
[1]	Symbols, 1	[6]	M, N, O, 6
[2]	A, B, C, 2	[7]	P, Q, R, S, 7
[3]	D, E, F, 3	[8]	T, U, V, 8
[4]	G, H, I, 4	[9]	W, X, Y, Z, 9
[5]	J, K, L, 5	[0]	0, Space

Chain Dial **Handset**

You can dial a combination of phone book or manual key pad entries while making a call. This feature can be used, for example, to first automatically dial a calling card access number that you have stored in the phone book, then manually or automatically dial your PIN and then automatically dial the destination number from the phone book.

Ex. Using a long distance calling card

- To prevent misdialing, we recommend you add pauses where needed when storing numbers. For example, add pauses after a calling card access number and your PIN when storing in the phone book (p. 32).
1. Search and dial from phone book: 1-800-012-3456 (Calling card access number)
 - The voice guidance may be announced.
 2. Search and dial from phone book: 1234 (Calling card PIN)
 3. Search and dial from phone book: 1-555-012-3456 (Destination number)

1 While you are on a call; Press [MENU].

2 Search for the desired item by pressing [▼] or [▲].

- To search for an item by initial, see page 34.

Phone book
▼▲=Scroll list
↵Back Search↵

3 Press Call.

- The phone number is dialed.
- If required, repeat steps 1 to 3 for any remaining numbers.

Alan
1-555-012-3456
↵Back Call↵

- If you have rotary or pulse service, you need to press [*] before pressing [MENU] in step 1 to change the dialing mode temporarily to tone.

Phone Book

Editing an Item in the Phone Book **Handset**

1 Press **Phone book**.

2 Press **Search**.

3 Scroll to the desired item by pressing [▼] or [▲], then press **Edit**.

- To search for the item by initial, see page 34.

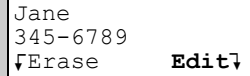

Jane
345-6789
↓Erase Edit↵

4 Edit the name (p. 33), then press [▼].

- If you do not need to change the name, press [▼] then go to step 5.



Jane Walker
↵◀ ▼=Next ▶↵

5 Edit the phone number, then press [▼].

- If you do not need to change the number, press [▼] then go to step 6.
- Each time you press ◀, a digit is erased. To erase all of the digits, press and hold ◀.

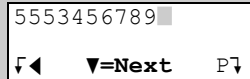

5553456789
↵◀ ▼=Next P↵

6 Press **Save**.

- To continue editing other items, repeat from step 3.

7 Press **[OFF]**.

Erasing an Item in the Phone Book **Handset**

1 Press **Phone book**.

2 Press **Search**.

3 Scroll to the desired item by pressing [▼] or [▲], then press **Erase**.

- To search for the item by initial, see page 34.

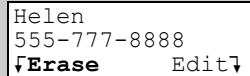

Helen
555-777-8888
↓Erase Edit↵

4 Press **Yes**.

- To erase other items, repeat from step 3.

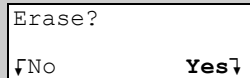

Erase?
↵No Yes↵

5 Press **[OFF]**.

- To cancel erasing, press **No** after step 3.

Intercom

Intercom calls can be made between the handset and the base unit.

Making Intercom Calls



From **Handset**

1 Press **[HOLD/INTERCOM]**.

- The base unit will ring for 1 minute.
- To stop paging, press **[OFF]**.

Calling Base

2 When the paged party answers, start talking.

- You can switch to the speaker by pressing **[]**. To switch back to the receiver, press **[]**.

Intercom
00-00-05
Mute 

3 To disconnect the intercom, press **[OFF]**.

From **Base Unit**

Using this feature, you can also locate a misplaced handset.

1 Press **[LOCATOR/INTERCOM]**.



- The SP-PHONE indicator lights.
- The handset will ring for 1 minute.
- To stop paging, press **[SP-PHONE]** or **[LOCATOR/INTERCOM]**.

2 When the paged party answers, talk into the **MIC**.

3 To disconnect the intercom, press **[SP-PHONE]** or **[LOCATOR/INTERCOM]**.

- The indicator light goes out.

During an intercom call:



- If you have difficulty hearing while using the handset speakerphone and base unit speaker, decrease the speaker volume by pressing **VOLUME [v]** on the base unit or **[v]** on the handset.
- If an incoming call is being received, you will hear two tones (incoming call tone, page 48) and the IN USE indicator will flash rapidly on the base unit. To answer the call;
 - if using the handset, press **[OFF]**, then **[]** or **[]**.
 - if using the base unit, press **[SP-PHONE]** twice.

Intercom

Answering Intercom Calls

Handset

When the handset is paged, it rings and the Ringer/Message Alert indicator flashes rapidly.

1 Press [, [, or [**HOLD/INTERCOM**].

- You can also answer a call by pressing any button except [**▼**], [**▲**] or [**OFF**].

Call from Base

2 To disconnect the intercom, press [**OFF**].

Base Unit

When the base unit is being paged, it rings.

1 Press [**SP-PHONE**] or [**LOCATOR/INTERCOM**].

2 To disconnect the intercom, press [**SP-PHONE**] or [**LOCATOR/INTERCOM**].

- When the ringer volume is turned off (p. 15, 16), the handset and the base unit will ring at the low level for intercom calls.
- You cannot change the ringer tone for intercom calls.

Transferring a Call

You can transfer an outside call to the base unit or the handset.

From the **Handset** to the **Base Unit**

1 *Handset:*

(1) During a call, press **[HOLD/INTERCOM]**.

- The call is put on hold.

(2) Press **Base**.

(3) Wait for the paged party to answer, then you can announce the transfer.

- If the paged party does not answer, press **[↶]** or **[↷]** to return to the outside call.
- After the paged party answers, "Intercom hold" is displayed.

Line on hold.
Transfer to
↓**Base**

Hold
Calling Base

2 *Base unit:*

Press **[SP-PHONE]** or **[LOCATOR/INTERCOM]** to answer the page.

3 *Handset:* To complete the transfer, press **[OFF]**.

From the **Base Unit** to the **Handset**

1 *Base unit:* During a call, press **[LOCATOR/INTERCOM]**.

- The call is put on hold.
- If the paged party does not answer, press **[LOCATOR/INTERCOM]** to return to the outside call.

2 *Handset:* Press **[↶]**, **[↷]** or **[HOLD/INTERCOM]** to answer the page.

- Any button except **[▼]**, **[▲]** or **[OFF]** can be pressed to answer the page.

3 *Base unit:* To complete the transfer, press **[SP-PHONE]**.

Transferring a Call

Quick call transfer







You can transfer a call without waiting for the paged party to answer.

Handset

- 1 During a call, press **[HOLD/INTERCOM]**, then press **Base**.
 - 2 Press **[OFF]** to hang up.
-

Base Unit

- 1 During a call, press **[LOCATOR/INTERCOM]**.
 - 2 Press **[SP-PHONE]** to hang up.
-

- The call will be transferred directly.
- The paged party can answer the transferred call by pressing [, [] or **[SP-PHONE]**.
- After the paged party answers, the transfer is complete.
- If the paged party does not answer:
 - for the handset, press [] or [] to return to the outside call.
 - for the base unit, press **[SP-PHONE]** to return to the outside call.
- If the paged party does not answer within 60 seconds after you hang up, your phone will ring and the call will be returned to your phone. You may speak to the caller again by pressing [, [] or **[SP-PHONE]**.
If you do not answer the call within 4 minutes, the call will be disconnected.

Conference Calls

While you are talking with an outside caller, the base unit user or the handset user can join the conversation and establish a conference call.

Handset

- 1 During a call, press **[HOLD/INTERCOM]**.
 - The call is put on hold.
- 2 Press **Base**.
- 3 When the paged party answers, press **Conf** on your unit to make a conference call.
 - “Conference” is displayed during a conference call.

Base Unit

- 1 During a call, press **[LOCATOR/INTERCOM]**.
 - The call is put on hold.
- 2 When the paged party answers, press **[HOLD/CONF]** on your unit to make a conference call.

- To leave the conference, press **[OFF]** on the handset or press **[SP-PHONE]** on the base unit. The two other parties can continue the conversation.
- During a conference, the outside call can be placed on hold by pressing **[HOLD/INTERCOM]** on the handset or **[HOLD/CONF]** on the base unit. Only the person who placed the call on hold can resume the full conference by pressing **Conf** on the handset or **[HOLD/CONF]** on the base unit.

Call Share

This feature allows the base unit or the handset to join an existing outside call.

To join a conversation (Call Share)

Handset

Press **[📞]** or **[📞]**.

- “Conference” is displayed.

Base Unit

Press **[SP-PHONE]**.

Voice Mail Service

Voice mail is an automatic answering service offered by your telephone company. If you subscribe to this service, your telephone company's voice mail system can answer calls for you when you are unavailable to answer the phone or when your line is busy. Callers can leave messages that are saved in virtual voice mailboxes, which are maintained for you at the phone company, allowing you to listen to your messages whenever you like. The unit will let you know that someone has left voice mail for you (p. 44). Once you have stored your voice mail access number, you can access your voice mailbox simply by pressing **[MENU]** on the handset, then selecting **select** at "V.M. access" or by pressing **[VM]** on the base unit.

Storing a Voice Mail Access Number **Handset**

1 Press **[MENU]**.

2 Scroll to "Initial setting" by pressing **[▼]** or **[▲]**, then press **select**.

Initial setting
↵Back ▼▲ Select↵

3 Press **select** at "Voice Mail".

Voice Mail
↵Back ▼▲ Select↵

4 Press **select** at "Store VM access#".

Store VM access#
↵Back ▼▲ Select↵

5 Enter your access number, up to 32 digits.

- If a pause is required for dialing, press **P***
- Each time you press **◀**, a digit is erased. To erase all of the digits, press and hold **◀**.

Example
1234567PPP890
↵◀ MENU=Save P↵

6 Press **[MENU]** to save your setting, then press **[OFF]**.

*To prevent misdialing, you may add pauses between your voice mail access number and your mailbox password in step 5.

Ex. 1-222-333-4444 PPPP 8888



Your voice mail access number Pauses Your mailbox password

Pressing **P** once creates a 3.5 second delay and counts as one digit. The delay time necessary between entering your access number and entering your mailbox password will depend on your telephone company.

To erase a stored voice mail access number

Repeat steps 1 to 4, then press and hold **◀** until all of the digits are erased. Press **[MENU]**, then press **[OFF]**.

Setting Voice Mail (VM) Tone Detection Handset

Your telephone company sends special signals (Voice mail tones) to the unit. Press **[]**, **[]** or **[SP-PHONE]** to listen to the dial tone. If you hear a series of dial tones followed by a continuous dial tone, this indicates that a new message was recorded. Voice Mail detection is preset at the factory to ON. Minutes after you hang up or after the phone stops ringing, your unit will seize the phone line and check if a message has been recorded. If a new message was recorded at your telephone company, "Voice Mail" will be displayed on the handset, the Ringer/Message Alert indicator on the handset will flash slowly if Message Alert is turned on (p. 18), and the VM indicator on the base unit will flash.

Turn off this programming when:

- you do not subscribe to a voice mail service,
- your telephone company does not send a series of tones, followed by a continuous tone to indicate you have new voice mail, or
- your phone is connected to a business or office telephone system (PBX).

See below to turn this setting off.

If you are not sure which setting is required, consult your local telephone company or contact the Panasonic Customer Call Center.

1 Press **[MENU]**.

2 Scroll to "Initial setting" by pressing **[▼]** or **[▲]**, then press **Select**.

```
Initial setting
┆Back ▼▲ Select┆
```

3 Press **Select** at "Voice Mail".

```
Voice Mail
┆Back ▼▲ Select┆
```

4 Scroll to "VM tone detect" by pressing **[▼]** or **[▲]**, then press **Select**.

```
VM tone detect
┆Back ▼▲ Select┆
```

5 Select "Off" or "On" by pressing **[▼]** or **[▲]**.

```
VM tone detect
:On
┆Back ▼▲ Save┆
```

6 Press **save**, then press **[OFF]**.

Voice Mail Service

Listening to Voice Mail Messages

Handset Base Unit

The unit will let you know that someone has left new voice mail for you:

- "Voice Mail" will be displayed on the handset, Ex. Handset on the base unit
- the Ringer/Message Alert indicator on the handset will flash slowly if Message Alert is turned on (p. 18) and the handset is not in use, and
- the VM indicator on the base unit will flash.

```
Voice Mail
Charging
```

Ex. Handset off the base unit

```
Voice Mail
Rcvd      Phone
↓calls    book ↓
```

To listen to your voice mail message(s)

Handset

1 Press **[MENU]**.

2 Press **Select** at "V.M. access".

- The handset is connected to the telephone line and dials the access number (p. 42) in speakerphone mode.
- If the handset beeps 3 times and "Store VM access#" is displayed, a voice mail access number is not stored. To store the number, see page 42.

```
V.M. access
↓Back ▼▲ Select↓
↓
Dial VM access#
↓(VE)           Mute↓
```

3 Follow the pre-recorded instructions.

4 When finished, press **[OFF]**.

• You can also listen to your voice mail message(s) by using **[↶]** or **[↷]**.

1. Press **[↶]** or **[↷]**.

2. Press **vm** within 15 seconds.

- After 15 seconds, "vm" will disappear and "(VE)" will be displayed.
- If a voice mail access number is not stored, "vm" will not be displayed. To store the number, see page 42.

```
Talk
00-00-08
↓vm           Mute↓
```

3. Follow steps 3 and 4 of "To listen to your voice mail message(s)" above.

Base Unit

1 Press **[VM]**.

- The base unit is connected to the telephone line and dials the access number (p. 42) in speakerphone mode.
 - If the base unit beeps 3 times, a voice mail access number is not stored. To store the number, see page 42.
-

2 Follow the pre-recorded instructions.

3 When finished, press **[SP-PHONE]**.

- If the handset and the base unit still indicate you have new messages even after you have listened to them, turn the voice mail indicators off by pressing and holding **[OFF]** until the handset beeps. "Voice Mail" will disappear on the handset, the Ringer/Message Alert indicator will go out, and the VM indicator on the base unit will go out.
- If your voice mail service uses a voice mail tone and the recorded message is over 3 minutes long, the handset and base unit may not indicate you have new messages.
- If your voice mail service uses a voice mail tone, the tone will be heard from any parallel connected phone. If you use another phone to retrieve messages, you have to dial your access number manually.

Special Features

Temporary Tone Dialing (For Rotary or Pulse Service Users)

Handset **Base Unit**

Press [*****] (TONE) before entering access numbers which require tone dialing.

- The dialing mode changes to tone. You can enter numbers to access an answering service, electronic banking service, etc. When you hang up, the dialing mode will return to pulse.

Muting Your Conversation

During a call, you can mute your phone so the other party cannot listen to you. When muting your conversation, you can hear the other party.

Handset Press **Mute**.

- “Mute” will flash.
- **To release the mute**, press **Mute** again.
- If you press [**↔**] or [**↔**] to switch between the receiver and speaker, the mute will be released.

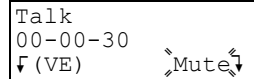

Talk
00-00-30
f (VE) Mute

Base Unit Press [**MUTE**].

- The SP-PHONE indicator flashes.
- **To release the mute**, press [**MUTE**] again.

For Call Waiting Service Users

Handset **Base Unit**

Press [**FLASH/CALL WAIT**] if you hear a call waiting tone during a conversation.

- The first call is put on hold and you can answer the second call.
- To return to the first caller, press [**FLASH/CALL WAIT**] again.
- Call Waiting service cannot be used when the first call is put on hold.
- If this function does not operate properly, consult your telephone company for details.

Call Waiting Caller ID display **Handset**

If you subscribe to both Caller ID and Call Waiting with Caller ID services (CWID), when a second call is received while talking, the second caller's information will be displayed. After you hear a call waiting tone while talking, the display shows the caller's name with the phone number and “----Waiting----”.

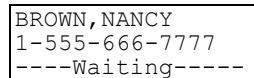

BROWN, NANCY
1-555-666-7777
----Waiting----

- Contact your telephone company for details about availability in your area, and to verify that CWID service is activated on your telephone line.
- The second caller's name will not be announced even if the Talking Caller ID feature is on (p. 25).

Using the PAUSE Key

(For PBX Line/Long Distance Calls) **Handset**

We recommend you press **Pause** or **P** if a pause is required for dial with a PBX or to make a long distance call.

Ex. Line access number **[9]** (PBX)

[9] ➔ **Pause** or **P** ➔ **Phone number**

- Pressing **Pause** or **P** once creates a 3.5 second pause. This prevents misdialing when you dial after confirming the entered number (p. 20) or dial a stored number (p. 34, 35).
- Pressing **Pause** or **P** more than once increases the length of the pause between numbers.

Example

9P15556667777
 fClear Pause↓

OR

9P15551234567
 f◀ ▼=Next P↓

FLASH Button **Handset** **Base Unit**

Pressing **[FLASH/CALL WAIT]** allows you to use special features of your host PBX such as transferring an extension call, or accessing optional telephone services such as call waiting.

- Pressing **[FLASH/CALL WAIT]** cancels Temporary Tone Dialing mode or the mute (p. 46).

Selecting the flash time **Handset**

The flash time required depends on your telephone exchange or host PBX. You can select the following flash times: “700, 600, 400, 300, 250, 110, 100 or 90 ms (milliseconds)”. The factory preset is “700 ms”.

- If PBX functions do not work correctly, consult your PBX supplier for the correct settings.

1 Press **[MENU]**.

2 Scroll to “Initial setting” by pressing **[▼]** or **[▲]**, then press **Select**.

Initial setting
 fBack ▼▲ Select↓

3 Scroll to “Set tel line” by pressing **[▼]** or **[▲]**, then press **Select**.

Set tel line
 fBack ▼▲ Select↓

4 Scroll to “Set flash time” by pressing **[▼]** or **[▲]**, then press **Select**.

Set flash time
 fBack ▼▲ Select↓

5 Select the desired time by pressing **[▼]** or **[▲]**.

Set flash time
 :700ms
 fBack ▼▲ Save↓

6 Press **save**, then press **[OFF]**.

Special Features

Incoming Call Tone **Handset** **Base Unit**

During an intercom call (p. 37), you can be informed of incoming calls by two tones. If this feature is turned on, incoming call tones will be heard for as long as the line is ringing. If this feature is set to “2”, incoming call tones will be heard only 2 times. If this feature is turned off, no tones will be heard. The factory preset is “2”. Using the handset, this feature can be set separately for the handset and base unit.

Handset incoming call tone **Handset**

1 Press **[MENU]**.

2 Scroll to “Ringer setting” by pressing **[▼]** or **[▲]**, then press **Select**.

```
Ringer setting
↓Back ▼▲ Select↓
```

3 Scroll to “Incoming call.” by pressing **[▼]** or **[▲]**, then press **Select**.

```
Incoming call.
↓Back ▼▲ Select↓
```

4 Select “On”, “Off” or “2” by pressing **[▼]** or **[▲]**.

```
Incoming call
tone :2
↓Back ▼▲ Save↓
```

5 Press **save**, then press **[OFF]**.

Base unit incoming call tone **Handset**

1 Press **[MENU]**.

2 Scroll to “Initial setting” by pressing **[▼]** or **[▲]**, then press **Select**.

```
Initial setting
↓Back ▼▲ Select↓
```

3 Scroll to “Set base unit” by pressing **[▼]** or **[▲]**, then press **Select**.

```
Set base unit
↓Back ▼▲ Select↓
```

4 Scroll to “Incoming call.” by pressing **[▼]** or **[▲]**, then press **Select**.

```
Incoming call.
↓Back ▼▲ Select↓
```

5 Select “On”, “Off” or “2” by pressing **[▼]** or **[▲]**.

```
Incoming call
tone :2
↓Back ▼▲ Save↓
```

6 Press **save**, then press **[OFF]**.

Key Tone **Handset**

You can select whether or not the handset keys will sound tones (key tone, confirmation tone, error tone). The factory preset is ON.

1 Press **[MENU]**.

2 Scroll to “Initial setting” by pressing **[▼]** or **[▲]**, then press **Select**.

Initial setting
 ↵Back ▼▲ Select↵

3 Scroll to “Key tone” by pressing **[▼]** or **[▲]**, then press **Select**.

Key tone
 ↵Back ▼▲ Select↵

4 Select “Off” or “On” by pressing **[▼]** or **[▲]**.

Key tone
 :On
 ↵Back ▼▲ Save↵

5 Press **save**, then press **[OFF]**.

Re-registering the Handset **Handset & Base Unit**

If “No link to base. Move closer to base, try again.” is displayed even when using the handset near the base unit, the handset may have lost communication with the base unit. You need to re-register the handset to the base unit.

- Have both the handset and base unit nearby during registration.
- Follow steps 1 and 2 listed below. You have about 1 minute to complete them.

1 *Base unit:* Press and hold **[LOCATOR/INTERCOM]** until a beep sounds.

- The CHARGE indicator flashes.

2 *Handset:* Press and hold **[FLASH/CALL WAIT]** until “Handset Registering” is displayed.

- When registration is complete, a beep sounds from the handset.
- **Wait for 20 seconds after registration is complete while the handset establishes communication with the base unit.**

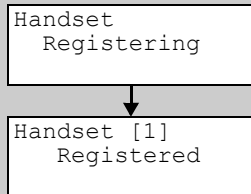

- If the handset beeps 3 times and “Error!!” is displayed, an error occurred. Try again from step 1.
- You can stop registration by pressing **[OFF]** on the handset, and pressing **[LOCATOR/INTERCOM]** on the base unit.

Belt Clip

You can hang the handset on your belt or pocket using the included belt clip.

To attach the belt clip

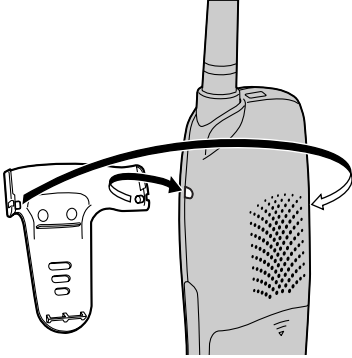

To remove the belt clip

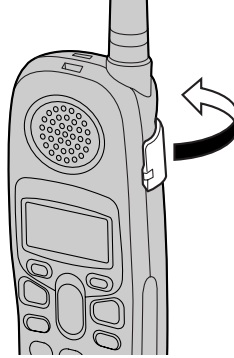

Shoulder Rest Attachment

Use the shoulder rest attachment if you need to keep your hands free during a phone conversation.

To attach the shoulder rest attachment

Attach the included belt clip to the handset (see above), then attach the shoulder rest attachment to the belt clip as shown below. You will hear a click when the shoulder rest attachment is in place.

To remove the shoulder rest attachment

Slide the base of the attachment in the direction of the arrow as shown below.

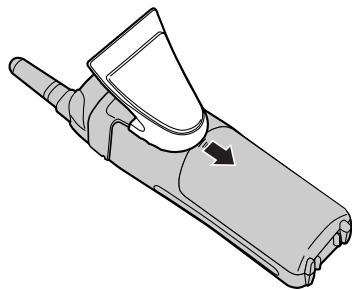
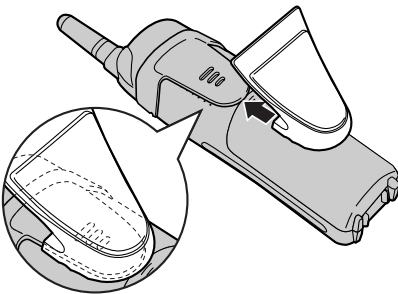

Wall Mounting

This unit can be mounted on a wall phone plate.

- 1 Push the hook and turn it upward. Turn the hook until a click is heard.

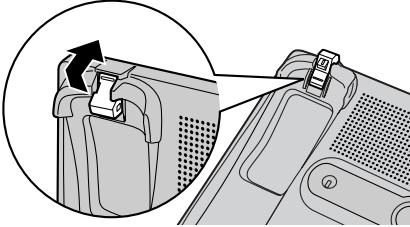

- 2 Press the tabs in the direction of the arrows (1), then remove the wall mounting adaptor (2).

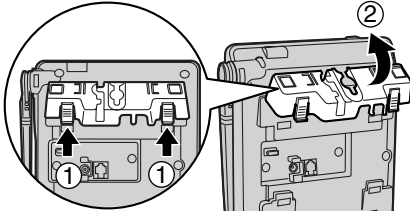

- 3 Connect the AC adaptor. Tuck the telephone line cord inside the wall mounting adaptor, then push the adaptor in the direction of the arrows (1 and 2).

- The word "UP WALL" should face upward.
- Fasten the AC adaptor cord to prevent it from being disconnected.

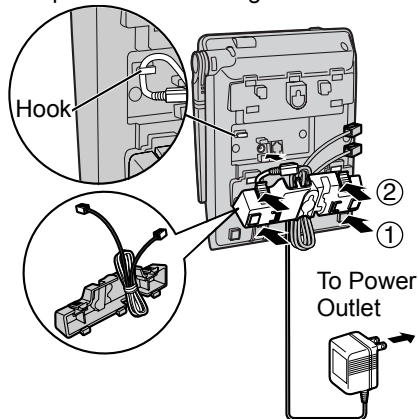

- 4 Connect the telephone line cord. Mount the unit, then slide it down.

- Raise the antenna.

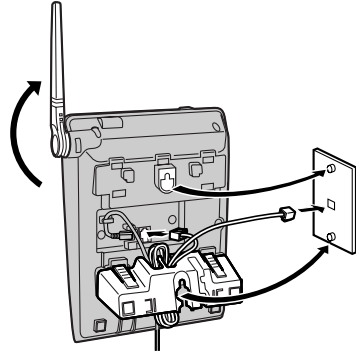

- 5 To charge the handset battery:

Rest the handset on the charge contacts (1), then push the top of the handset so the hook snaps into the slot at the top of the handset (2).

- The unit beeps once and the CHARGE indicator lights.

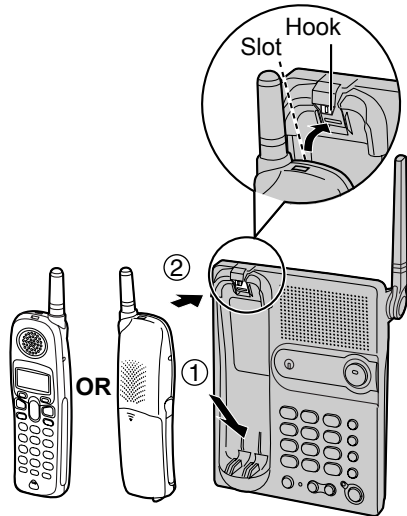

Optional Headset

Connecting an optional headset to the handset allows hands-free phone conversation. Please use only a Panasonic KX-TCA60, KX-TCA86, KX-TCA88, KX-TCA88HA, KX-TCA91, KX-TCA92, or KX-TCA98 headset. To order, call the accessories telephone number on page 2.

Connecting an optional headset

Open the headset jack cover, and insert the headset plug into the headset jack as shown below.

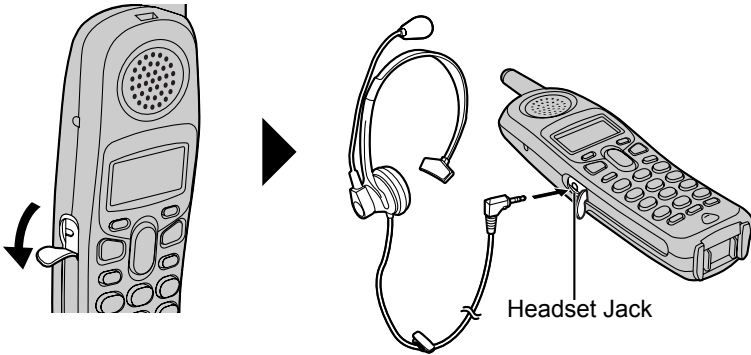

- Headset sold separately. Model shown here is KX-TCA88.

To switch to the speakerphone while using the headset:
Press [📞]. To return to the headset, press [📞].

Direct Commands

Handset

After pressing **[MENU]**, you can also program menu items directly by pressing (**[0]** to **[9]**, **[*]** and **[#]**) instead of using the soft keys.

Menu item	Command	Selection items	Page
Ringer volume	[1] [1]	[0] : Off [1] : Low [2] : Medium [3] : High	p. 15
Ringer tone (for handset)	[1] [2]	[1]–[3] : Tone pattern 1–3 [4]–[7] : Melody pattern 1–4	p. 16
Incoming call tone (for handset)	[1] [3]	[1] : On [2] : Twice [0] : Off	p. 48
VM access	[3]		p. 44
Voice enhancer	[5]	[1] : On [0] : Off	p. 21
Talking Caller ID (for handset)	[9]	[1] : On [0] : Off	p. 25
LCD contrast	[0] [1]	[1]–[6] : Level 1–6	p. 18
Key tone	[0] [2]	[1] : On [0] : Off	p. 49
Auto talk	[0] [3]	[1] : On [0] : Off	p. 14
Caller ID number auto edit	[0] [4]	[1] : On [0] : Off	p. 29
Set dial mode	[0] [5] [1]	[1] : Pulse [2] : Tone	p. 13
Set flash time	[0] [5] [2]	[1] : 700 ms [2] : 600 ms [3] : 400 ms [4] : 300 ms [5] : 250 ms [6] : 110 ms [7] : 100 ms [8] : 90 ms	p. 47
Set line mode	[0] [5] [3]	[1] : A [2] : B	p. 14
Store VM access#	[0] [7] [1]	Go to Step 5 on page 42.	—
VM tone detect	[0] [7] [2]	[1] : On [0] : Off	p. 43
Change language	[0] [8]	[1] : English [2] : Spanish	p. 13
Message alert	[0] [#]	[1] : On [0] : Off	p. 18

Direct Commands

Menu item	Command	Selection items	Page
Ringer tone (for base unit)	[0] [*] [1]	[1]–[3] : Tone pattern 1–3 [4]–[7] : Melody pattern 1–4	p. 17
Incoming call tone (for base unit)	[0] [*] [2]	[1] : On [2] : Twice [0] : Off	p. 48
Talking Caller ID (for base unit)	[0] [*] [4]	[1] : On [0] : Off	p. 26

During programming:

When “Save” is displayed, press the right soft key to **save the new settings**.

To exit programming, press [OFF].

- If you press the direct command incorrectly, press [OFF], then re-enter programming mode by pressing [MENU].
- For function details, see the corresponding pages.

If the Following Appear on Your Display...

The following will be displayed when the unit needs your attention.



Display message	Cause & Remedy
Recharge battery	<ul style="list-style-type: none">• The battery needs to be charged. Recharge the battery (p. 10).
Charge for 6h	<ul style="list-style-type: none">• The battery has been discharged. The handset will not work. Fully charge the battery (p. 9).
No link to base. Move closer to base, try again.	<ul style="list-style-type: none">• The handset has lost communication with the base unit. Walk closer to the base unit and try again or re-register the handset (p. 49).• Confirm the base unit's AC adaptor is plugged in.• Raise the base unit antenna.
Please lift up and try again.	<ul style="list-style-type: none">• A handset button was pressed while the handset was on the base unit. Lift the handset and press the button again.
Busy	<ul style="list-style-type: none">• The base unit is in use. Try again later.
Error!!	<ul style="list-style-type: none">• When you tried to re-register the handset, the handset and base unit could not link for some reason, such as interference from electrical appliances. Move the handset and base unit away from any electrical appliances and try again.
Phone book full	<ul style="list-style-type: none">• When you tried to store an item in the phone book, the phone book memory was full. Press [OFF] to exit the programming mode. To erase other items from the phone book, see page 36.
System is busy. Please try again later.	<ul style="list-style-type: none">• The handset has lost communication with the base unit. Walk closer to the base unit and try again.
Line in use	<ul style="list-style-type: none">• The base unit is conducting an outside call or a parallel connected telephone is in use.
Line on hold	<ul style="list-style-type: none">• The base unit is on hold for an outside call.
Store VM access#	<ul style="list-style-type: none">• You have not stored the voice mail access number. Store the number (p. 42).

Troubleshooting





If the handset display shows error messages, see “If the Following Appear on Your Display...” (p. 55) for the Cause & Remedy.

Problem	Cause & Remedy
“No link to base. Move closer to base, try again.” is displayed and an alarm tone sounds.	<ul style="list-style-type: none">• You are too far from the base unit. Walk closer to the base unit.• Confirm the base unit’s AC adaptor is plugged in.• Raise the base unit antenna.• If the above remedies do not solve the problem, the handset may have lost communication with the base unit. Register the handset again (p. 49).
The handset and/or base unit does not work.	<ul style="list-style-type: none">• Check the settings (p. 8–10).• Check whether the dialing mode setting is correct (p. 13).• Fully charge the battery (p. 9).• Clean the charge contacts and charge again (p. 10).• Check battery Installation (p. 9).• Unplug the base unit’s AC adaptor to reset it. Plug in, and try again.• Re-install the battery (p. 9) and fully charge it.
Static, sound cuts in/out, fades. Interference from other electrical units.	<ul style="list-style-type: none">• Move the handset and base unit away from other electrical appliances (p. 3).• Walk closer to the base unit.• Raise the base unit antenna.
The handset and/or base unit does not ring.	<ul style="list-style-type: none">• The ringer volume is turned off. Set to high, medium, or low (p. 15, 16).
The handset display is blank.	<ul style="list-style-type: none">• If the handset display is blank, fully charge the battery (p. 9).
You cannot program any function items.	<ul style="list-style-type: none">• Programming is not possible while the handset and/or base unit is being used.• Do not pause for over 60 seconds while programming.• Walk closer to the base unit.
While programming or searching, the handset starts to ring and the program/search stops.	<ul style="list-style-type: none">• A call is coming in. To answer the call, press [📞], [📞] or [SP-PHONE]. Start again from the beginning after hanging up.
You cannot make an intercom/outside call.	<ul style="list-style-type: none">• If the handset or base unit is in use, you may not be able to make a call. Try again later.

Troubleshooting

Problem	Cause & Remedy
You cannot redial.	<ul style="list-style-type: none">• If the last number dialed was more than 48 digits long, the number will not be redialed correctly.
You cannot make long distance calls.	<ul style="list-style-type: none">• Please make sure you have long distance service.
The handset does not display the caller's name and/or phone number.	<ul style="list-style-type: none">• You need to subscribe to Caller ID.• Other telephone equipment may be interfering with your phone. Disconnect it and try again.• Other electrical appliances connected to the same outlet may be interfering with Caller ID.• Telephone line noise may be affecting Caller ID.• The caller requested not to send his/her Caller ID information (p. 24).• If a call is being transferred to you, the Caller ID information will not be displayed.• If a (separate) Caller ID box is connected between the base unit and the telephone wall jack, disconnect the Caller ID box or plug the unit directly into the wall jack.
The handset and/or base unit does not announce the displayed caller's name.	<ul style="list-style-type: none">• The handset and/or base unit ringer volumes are turned off. Set to high, medium, or low (p. 15, 16).• The Talking Caller ID feature is turned off. Turn it on (p. 25, 26).
The handset and/or base unit does not announce the displayed caller's name properly.	<ul style="list-style-type: none">• Name pronunciation may vary. Name pronunciation quality is based on names most commonly used in the United States.• The handset and/or base unit will announce each letter of abbreviations, such as "Co." and "Inc."• Caller ID supports names of up to 15 letters. If the caller's name has more than 15 letters, the name will not be announced correctly.
The handset cannot automatically edit the Caller List/incoming phone numbers.	<ul style="list-style-type: none">• The Caller ID number auto edit feature is turned off. Turn it on (p. 29) and try again.• You need to press  or  after editing the number.
The handset display exits the Caller List or phone book.	<ul style="list-style-type: none">• Do not pause for over 60 seconds while searching.

Troubleshooting

Problem	Cause & Remedy
<p>“Recharge battery” is displayed, “” flashes, or the handset beeps intermittently.</p>	<ul style="list-style-type: none"> • Fully charge the battery (p. 9).
<p>“Charge for 6h” and “” are displayed and the handset does not work.</p>	<ul style="list-style-type: none"> • The battery has been discharged. Fully charge the battery (p. 9). • Check battery installation (p. 9).
<p>You charged the battery fully, but “Recharge battery” is still displayed and/or “” continues to flash, or “Charge for 6h” and “” are displayed.</p>	<ul style="list-style-type: none"> • Clean the charge contacts and charge again (p. 10). • The battery may need to be replaced. If you install a new battery, fully charge it (p. 9).
<p>The CHARGE indicator does not go out after the battery has been charged.</p>	<ul style="list-style-type: none"> • This is normal.
<p>The Ringer/Message Alert indicator flashes slowly when the handset is not ringing and in use.</p>	<ul style="list-style-type: none"> • The Message Alert is turned on and new messages in your voice mailbox have been recorded. Turn the Message Alert off (p. 18) or listen to the new messages (p. 44, 45).
<p>You cannot have a conversation using the headset.</p>	<ul style="list-style-type: none"> • Make sure the optional headset is connected properly (p. 52). • If “SP-phone” is displayed on the handset, press [] to switch to the headset.
<p>If you cannot solve your problem</p>	<ul style="list-style-type: none"> • Visit our website: http://www.panasonic.com/support • Contact us via the web at: http://www.panasonic.com/contactinfo • Call our customer call center at: 1-800-211-PANA(7262)

Important Safety Instructions

When using this unit, basic safety precautions should always be followed to reduce the risk of fire, electric shock, or personal injury.

1. Read and understand all instructions.
2. Follow all warnings and instructions marked on this unit.
3. Unplug this unit from AC outlets before cleaning. Do not use liquid or aerosol cleaners. Use a damp cloth for cleaning.
4. Do not use this unit near water, for example, near a bathtub, washbowl, kitchen sink, or the like.
5. Place this unit securely on a stable surface. Serious damage and/or injury may result if the unit falls.
6. Do not cover slots and openings on the unit. They are provided for ventilation and protection against overheating. Never place the unit near radiators, or in a place where proper ventilation is not provided.
7. Use only the power source marked on the unit. If you are not sure of the type of power supplied to your home, consult your dealer or local power company.
8. Do not place objects on the power cord. Install the unit where no one can step or trip on the cord.
9. Do not overload wall outlets and extension cords. This can result in the risk of fire or electric shock.
10. Never push any objects through slots in this unit. This may result in the risk of fire or electric shock. Never spill any liquid on the unit.
11. To reduce the risk of electric shock, do not disassemble this unit. Take the unit to an authorized servicer when service is required. Opening or removing covers may expose you to dangerous voltages or other risks. Incorrect reassembly can cause electric shock when the unit is subsequently used.
12. Unplug this unit from the wall outlet and refer servicing to an authorized servicer when the following conditions occur:
 - A. When the power supply cord or plug is damaged or frayed.
 - B. If liquid has been spilled into the unit.
 - C. If the unit has been exposed to rain or water.
 - D. If the unit does not work normally by following the operating instructions. Adjust only controls covered by the operating instructions. Improper adjustment may require extensive work by an authorized servicer.
 - E. If the unit has been dropped or physically damaged.
 - F. If the unit exhibits a distinct change in performance.
13. During thunderstorms, avoid using telephones except cordless types. There may be a remote risk of an electric shock from lightning.
14. Do not use this unit to report a gas leak, when in the vicinity of the leak.

SAVE THESE INSTRUCTIONS

Important Safety Instructions

CAUTION:

To reduce the risk of fire or injury to persons, read and follow these instructions.

1. Use only the battery(ies) specified.
2. Do not dispose of the battery(ies) in a fire. They may explode. Check with local waste management codes for special disposal instructions.
3. Do not open or mutilate the battery(ies). Released electrolyte is corrosive and may cause burns or injury to the eyes or skin. The electrolyte may be toxic if swallowed.
4. Exercise care in handling batteries in order not to short the battery to conductive materials such as rings, bracelets, and keys. The battery and/or conductor may overheat and cause burns.
5. Charge the battery(ies) provided with or identified for use with this product only in accordance with the instructions and limitations specified in this manual.

WARNING:

TO PREVENT FIRE OR SHOCK HAZARD, DO NOT EXPOSE THIS PRODUCT TO RAIN OR ANY TYPE OF MOISTURE.

- The AC adaptor is used as the main disconnect device, ensure that the AC outlet is located/installed near the unit and is easily accessible.

FCC and Other Information

This equipment complies with Part 68 of the FCC rules and the requirements adopted by the ACTA. On the bottom of this equipment is a label that contains, among other information, a product identifier in the format US:ACJ-----.

If requested, this number must be provided to the telephone company.

Registration No. (found on the bottom of the unit)

Ringer Equivalence No. (REN) 0.1B

A plug and jack used to connect this equipment to the premises wiring and telephone network must comply with the applicable FCC Part 68 rules and requirements adopted by the ACTA. A compliant telephone cord and modular plug is provided with this product. It is designed to be connected to a compatible modular jack that is also compliant.

The REN is used to determine the number of devices that may be connected to a telephone line. Excessive RENs on a telephone line may result in the devices not ringing in response to an incoming call. In most but not all areas, the sum of RENs should not exceed five (5.0). To be certain of the number of devices that may be connected to a line, as determined by the total RENs, contact the local telephone company. For products approved after July 23, 2001, the REN for this product is part of the product identifier that has the format US:AAAEQ##TXXXX. The digits represented by ## are the REN without a decimal point (e.g., 03 is a REN of 0.3).

If this equipment causes harm to the telephone network, the telephone company will notify you in advance that temporary discontinuance of service may be required. But if advance notice isn't practical, the telephone company will notify the customer as soon as possible. Also, you will be advised of your right to file a complaint with the FCC if you believe it is necessary.

FCC and Other Information

The telephone company may make changes in its facilities, equipment, operations or procedures that could affect the operation of the equipment. If this happens the telephone company will provide advance notice in order for you to make necessary modifications to maintain uninterrupted service.

If trouble is experienced with this equipment, for repair or warranty information, please contact a Factory Servicenter or other Authorized Servicer. If the equipment is causing harm to the telephone network, the telephone company may request that you disconnect the equipment until the problem is resolved.

Connection to party line service is subject to state tariffs. Contact the state public utility commission, public service commission or corporation commission for information.

If your home has specially wired alarm equipment connected to the telephone line, ensure the installation of this equipment does not disable your alarm equipment. If you have questions about what will disable alarm equipment, consult your telephone company or a qualified installer.

WHEN PROGRAMMING EMERGENCY NUMBERS AND(OR) MAKING TEST CALLS TO EMERGENCY NUMBERS:

- 1) Remain on the line and briefly explain to the dispatcher the reason for the call.
- 2) Perform such activities in the off-peak hours, such as early morning or late evenings.

This device complies with Part 15 of the FCC Rules. Operation is subject to the following two conditions: (1) This device may not cause harmful interference, and (2) this device must accept any interference received, including interference that may cause undesired operation.

Privacy of communications may not be ensured when using this phone.

CAUTION:

Any changes or modifications not expressly approved by the party responsible for compliance could void the user's authority to operate this device.

Note:

This equipment has been tested and found to comply with the limits for a Class B digital device, pursuant to Part 15 of the FCC Rules. These limits are designed to provide reasonable protection against harmful interference in a residential installation. This equipment generates, uses, and can radiate radio frequency energy and, if not installed and used in accordance with the instructions, may cause harmful interference to radio communications. However, there is no guarantee that interference will not occur in a particular installation. If this equipment does cause harmful interference to radio or television reception, which can be determined by turning the equipment off and on, the user is encouraged to try to correct the interference by one or more of the following measures:

- Reorient or relocate the receiving antenna.
- Increase the separation between the equipment and receiver.
- Connect the equipment into an outlet on a circuit different from that to which the receiver is connected.
- Consult the dealer or an experienced radio/TV technician for help.

Some cordless telephones operate at frequencies that may cause interference to nearby TVs and VCRs. To minimize or prevent such interference, the base of the cordless telephone should not be placed near or on top of a TV or VCR. If interference is experienced, move the cordless telephone further away from the TV or VCR. This will often reduce, or eliminate, interference.

FCC and Other Information

Operating near 2.4GHz electrical appliances may cause interference. Move away from the electrical appliances.

FCC RF Exposure Warning:

This product complies with FCC radiation exposure limits set forth for an uncontrolled environment. To comply with FCC RF exposure requirements the base unit must be installed and operated with its antenna located 20 cm or more between antenna and all person's body (excluding extremities of hands, wrist and feet). The handset unit may be carried and operated with only the specific provided belt-clip. Other non-tested belt-clips or similar body-worn accessories may not comply and must be avoided. The base and handset units must not be co-located or operated in conjunction with any other antenna or transmitter.

This equipment is hearing aid compatible as defined by the FCC in 47 CFR Section 68.316.

When you hold the phone to your ear, noise might be heard in your Hearing Aid. Some Hearing Aids are not adequately shielded from external RF (radio frequency) energy. If noise occurs, use an optional headset accessory or the speakerphone option (if applicable) when using this phone. Consult your audiologist or Hearing Aid manufacturer about the availability of Hearing Aids which provide adequate shielding to RF energy commonly emitted by digital devices.

A TIA/EIA-IS-968 compliant telephone cord and modular plug is provided with this equipment. This equipment is designed to be connected to the telephone network or premises wiring using a compatible modular jack that is also TIA/EIA-IS-968 compliant.

- **Environment** — do not place the unit in a room where the temperature is less than 5°C (41°F) or greater than 40°C (104°F). Allow 10 cm (4") clearance around the unit for proper ventilation. Avoid excessive smoke, dust, mechanical vibration, shock, or direct sunlight.
- **Medical** — consult the manufacturer of any personal medical devices, such as pacemakers or hearing aids, to determine if they are adequately shielded from external RF (radio frequency) energy. (The unit operates in the frequency range of 2400MHz to 2481MHz, and the power output level can range 0.04 to 0.1 watts.) Do not use the unit in health care facilities if any regulations posted in the area instruct you not to do so. Hospitals or health care facilities may be using equipment that could be sensitive to external RF (radio frequency) energy.
- **Routine care** — wipe the unit with a soft cloth. Do not use benzine, thinner, or any abrasive powder. When you leave the unit unused for a long period of time, unplug the AC adaptor from the outlet.
- **If there is any trouble** — disconnect the unit from the telephone line and connect a known working phone. If the known working phone operates properly, have your unit repaired by one of the authorized Panasonic Factory Service Centers. If the known working phone does not operate properly, consult your telephone company.

Index

A

- Accessories 2
- Answering calls, base unit 23
- Answering calls, handset 23
- Auto talk 14, 23

B

- Backlit LCD 21
- Base unit location 3
- Battery charge 3, 9
- Battery information* 10
- Battery replacement 10
- Battery strength 9
- Belt clip 50

C

- Call share 41
- Call Waiting Caller ID display 46
- Call waiting tone 46
- Caller ID number auto edit* 29
- Caller ID service 24
- Caller List, editing 28
- Caller List, erasing 31
- Caller List, storing 30
- Caller List, viewing 27
- Calling back from the Caller List 27
- Chain dial* 35
- Conf (Conference) 41
- Conference calls 41

D

- Dialing mode 13
- Direct commands 53, 54
- Display language 13

E

- Error messages 55

F

- FCC and other information 60
- FLASH button 47
- Flash time 47
- Function menu*,
 Direct commands 53
- Function menu, selection 11
- Function menu, table 12

H

- Headset, optional 52
- Hold 20, 22

I

- Incoming call tone 48
- Installation, AC adaptor 8
- Installation, battery 9
- Installation, telephone line cord 8
- Intercom call 37, 38

K

- Key tone 49

L

- LCD contrast 18
- Lighted handset keypad 21
- Line mode 14
- Location of controls 6, 7

M

- Making calls, base unit 22
- Making calls, handset 19, 20
- Message alert* 18
- Microphone, base unit 22
- Microphone, handset 19
- Mute 46

N

- Navigator key 7
- Noise 3

P

- Pause 47
- Phone book* 32
- Phone book, dialing 34
- Phone Book, editing 36
- Phone book, erasing 36
- Phone book, names 33
- Phone book, storing 32
- Power failure 8
- Pulse service 46

Index

R

- Redial 20, 22
- Redial list 20
- Registration* 49
- Ringer off 15, 16, 23
- Ringer tone 16, 17
- Ringer volume 15, 16
- Rotary service, tone dialing 46

S

- Safety instructions 59
- Shipping product
 - for service. Back Cover
- Shoulder rest attachment 50
- Soft keys 7
- Specifications 67
- SP-phone, base unit 22
- SP-phone, handset 19

T

- Talking Caller ID*. 25, 26
- Transferring a call*. 39
- Troubleshooting 56
- TTY 2, 66, Back Cover

V

- VE (Voice Enhancer) 21
- VM (Voice Mail)* 42
- Voice enhancer technology* 21
- Volume control, base unit 22
- Volume control, handset 20

W

- Wall mounting 51
- Warranty 65

- “—” indicates important information and frequently used features.

PANASONIC CONSUMER
ELECTRONICS COMPANY, DIVISION
OF MATSUSHITA ELECTRIC
CORPORATION OF AMERICA
One Panasonic Way
Secaucus, New Jersey 07094

PANASONIC SALES COMPANY,
DIVISION OF MATSUSHITA
ELECTRIC OF PUERTO RICO, INC.,
Ave. 65 de Infanteria, Km. 9.5
San Gabriel Industrial Park
Carolina, Puerto Rico 00985

Panasonic Telephone Products Limited Warranty

Limited Warranty Coverage

If your product does not work properly because of a defect in materials or workmanship, Panasonic Consumer Electronics Company or Panasonic Sales Company (collectively referred to as "the warrantor") will, for the length of the period indicated on the chart below, which starts with the date of original purchase ("Limited Warranty period"), at its option either (a) repair your product with new or refurbished parts, or (b) replace it with a new or a refurbished product. The decision to repair or replace will be made by the warrantor.

Parts
One (1) Year

Labor
One (1) Year

During the "Labor" Limited Warranty period there will be no charge for labor. During the "Parts" Limited Warranty period, there will be no charge for parts. You must mail-in your product during the Limited Warranty period. This Limited Warranty excludes both parts and labor for batteries, antennas, and cosmetic parts (cabinet). This Limited Warranty only applies to products purchased and serviced in the United States or Puerto Rico. This Limited Warranty is extended only to the original purchaser and only covers products purchased as new.

Mail-In Service

For assistance in the continental U.S.A. in obtaining repairs please ship the product to:

Panasonic Services Company Customer Servicenter
Suite B 4900 George McVay Drive McAllen, TX 78503

For assistance in Puerto Rico call Panasonic Sales Company (787)-750-4300 or fax (787)-768-2910.

For Limited Warranty service for headsets if a headset is included with this product please call Panasonic Call Center at 1-800-211-PANA (7262).

When shipping the unit carefully pack, include all accessories, and send it prepaid, adequately insured and preferably in the original carton. Include a letter detailing the complaint and provide a day time phone number where you can be reached.

IF REPAIR IS NEEDED DURING THE LIMITED WARRANTY PERIOD THE PURCHASER WILL BE REQUIRED TO FURNISH A SALES RECEIPT/PROOF OF PURCHASE INDICATING DATE OF PURCHASE, AMOUNT PAID AND PLACE OF PURCHASE. CUSTOMER WILL BE CHARGED FOR THE REPAIR OF ANY UNIT RECEIVED WITHOUT SUCH PROOF OF PURCHASE.

Limited Warranty Limits And Exclusions

This Limited Warranty ONLY COVERS failures due to defects in materials or workmanship, and DOES NOT COVER normal wear and tear or cosmetic damage. The Limited Warranty ALSO DOES NOT COVER damages which occurred in shipment, or failures which are caused by products not supplied by the warrantor, or failures which result from accidents, misuse, abuse, neglect, mishandling, misapplication, alteration, faulty installation, set-up adjustments, misadjustment of consumer controls, improper maintenance, power line surge, lightning damage, modification, introduction of sand, humidity or liquids, commercial use such as hotel, office, restaurant, or other business or rental use of the product, or service by anyone other than a Factory Servicenter or other Authorized Servicer, or damage that is attributable to acts of God.

THERE ARE NO EXPRESS WARRANTIES EXCEPT AS LISTED UNDER "LIMITED WARRANTY COVERAGE". THE WARRANTOR IS NOT LIABLE FOR INCIDENTAL OR CONSEQUENTIAL DAMAGES RESULTING FROM THE USE OF THIS PRODUCT, OR ARISING OUT OF ANY BREACH OF THIS LIMITED WARRANTY. (As examples, this excludes damages for lost time, lost calls or messages, cost of having someone remove or re-install an installed unit if applicable, travel to and from the servicer. The items listed are not exclusive, but are for illustration only.) **ALL EXPRESS AND IMPLIED WARRANTIES, INCLUDING THE WARRANTY OF MERCHANTABILITY, ARE LIMITED TO THE PERIOD OF THE LIMITED WARRANTY.**

Some states do not allow the exclusion or limitation of incidental or consequential damages, or limitations on how long an implied warranty lasts, so the exclusions may not apply to you. This Limited Warranty gives you specific legal rights and you may also have other rights which vary from state to state. If a problem with this product develops during or after the Limited Warranty period, you may contact your dealer or Servicenter. If the problem is not handled to your satisfaction, then write to the warrantor's Consumer Affairs Department at the addresses listed for the warrantor.

PARTS AND SERVICE, WHICH ARE NOT COVERED BY THIS LIMITED WARRANTY, ARE YOUR RESPONSIBILITY.

Customer Services Directory

Obtain Product Information and Operating Assistance; locate your nearest Dealer or Servicenter; purchase Parts and Accessories; or make Customer Service and Literature requests by visiting our Web Site at:

<http://www.panasonic.com/support>

or, contact us via the web at:

<http://www.panasonic.com/contactinfo>

You may also contact us directly at: 1-800-211-PANA (7262),
Monday-Friday 9 am-9 pm; Saturday-Sunday 10 am-7 pm, EST.

For hearing or speech impaired TTY users, TTY : 1-877-833-8855

Accessory Purchases

Purchase Parts, Accessories and Instruction Books online for all Panasonic Products by visiting our Web Site at:

<http://www.pasc.panasonic.com>

or, send your request by E-mail to:

npcparts@panasonic.com

You may also contact us directly at:
1-800-332-5368 (Phone) 1-800-237-9080 (Fax Only)
(Monday - Friday 9 am to 8 pm, EST.)

Panasonic Services Company
20421 84th Avenue South, Kent, WA 98032
(We Accept Visa, MasterCard, Discover Card, American Express,
and Personal Checks)

For hearing or speech impaired TTY users, TTY : 1-866-605-1277

Service in Puerto Rico

***Matsushita Electric of Puerto Rico, Inc. Panasonic Sales Company
Factory Servicenter:***

***Ave. 65 de Infantería, Km. 9.5, San Gabriel Industrial Park,
Carolina, Puerto Rico 00985
Phone (787)750-4300, Fax (787)768-2910***

Specifications

■ Base Unit

- Power Supply:** AC Adaptor (120 V AC, 60 Hz)
- Power Consumption:** Standby: Approx. 2.0 W
Maximum: Approx. 5.4 W
- Frequency:** 2.4 GHz – 2.48 GHz
- Dimensions (H x W x D):** Approx. 85 mm x 175 mm x 200 mm
(3 ¹¹/₃₂" x 6 ⁷/₈" x 7 ⁷/₈")
- Mass (Weight):** Approx. 460 g (1.01 lb.)

■ Handset

- Power Supply:** Ni-MH battery (3.6 V, 830 mAh)
- Frequency:** 2.4 GHz – 2.48 GHz
- Dimensions (H x W x D):** Approx. 208 mm x 52 mm x 39 mm
(8 ³/₁₆" x 2 ¹/₁₆" x 1 ¹⁷/₃₂")
- Mass (Weight):** Approx. 190 g (0.42 lb.)
- Security Codes:** 1,000,000

- **Dialing Mode:** Tone (DTMF)/Pulse

- **Operating Environment:** 5 °C – 40 °C (41 °F – 104 °F)

Specifications are subject to change without notice.

For your future reference

Serial No. _____ Date of purchase _____

(found on the bottom of the unit)

Name and address of dealer _____

For product service

- Visit our website: <http://www.panasonic.com/support>
- Contact us via the web at: <http://www.panasonic.com/contactinfo>
- Call us at: 1-800-211-PANA(7262)

When you ship the product

- Carefully pack your unit, preferably in the original carton.
- Attach a letter, detailing the symptom, to the outside of the carton.

Symptom

- Send the unit to an authorized servicer, prepaid and adequately insured.
- Do not send your unit to the Panasonic Consumer Electronics Company listed below or to executive or regional sales offices. These locations do not repair consumer products.

- This cordless telephone is designed for use in the United States of America. Sale or use of this product in other countries may violate local laws.
- Ce téléphone sans fil est conçu pour être utilisé aux États-Unis d'Amérique. La vente ou l'emploi de cet appareil dans certains autres pays peut constituer une infraction à la législation locale.
- Este teléfono inalámbrico fue elaborado para uso en los Estados Unidos de América. La venta o el empleo de este producto en ciertos países puede constituir violación de la legislación local.
- このコードレス電話機は、日本国外での使用を目的として設計されており、日本国内での使用は法律違反となります。従って、当社では日本国内においては原則として修理などのサービスは致しかねます。

**If you need assistance with the setup or operation,
please call 1-800-211-PANA(7262)**

For hearing or speech impaired TTY users, TTY : 1-877-833-8855

**Panasonic Consumer Electronics Company,
Division of Matsushita Electric Corporation of America**
One Panasonic Way, Secaucus, New Jersey 07094

**Panasonic Sales Company,
Division of Matsushita Electric of Puerto Rico, Inc.**
Ave. 65 de Infantería, Km. 9.5, San Gabriel Industrial Park
Carolina, Puerto Rico 00985

© 2004 Panasonic Communications Co., Ltd. All Rights Reserved.

PQQX13985YA F1203-1014 ©