

# Panasonic

2.4GHz Expandable Cordless Phone System

## Operating Instructions

Model No. KX-TG2382B

KX-TG2382PW

KX-TG2383B

KX-TG2383S

Pulse-or-tone dialing capability



Model shown is KX-TG2382B.

Caller ID Compatible

**PLEASE READ BEFORE USE AND SAVE.**

**Charge the battery for about 15 hours before initial use.**

**Panasonic World Wide Web address: <http://www.panasonic.com>**  
for customers in the USA or Puerto Rico

Preparation

Cordless Telephone

Answering System

Useful Information







**Thank you for purchasing your new Panasonic cordless telephone.**

Please read IMPORTANT SAFETY INSTRUCTIONS on page 71 before use. Read and understand all instructions.

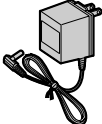
Caller ID and Call Waiting Service, where available, are telephone company services. After subscribing to Caller ID, this phone will display a caller's name and phone number. Call Waiting Caller ID, which displays a second caller's name and phone number while the user is on the phone line with the first caller, requires a subscription to both Caller ID with Name and Call Waiting Service.

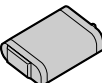
**Attach your purchase receipt here.**

**Accessories (included)** For extra orders, call 1-800-332-5368.

Description		Order No.	Quantity	
<input type="checkbox"/> AC Adaptor for base unit (p. 9)		PQLV10Z (PQLV10)	1	
<input type="checkbox"/> Telephone Line Cord (p. 9)		PQJA10075Z	1	
<input type="checkbox"/> Battery (p. 10, 61)		N4HHGMB00001 or N4HHGMB00005 (HHR-P103)	KX-TG2382B: 2 KX-TG2382PW: 2 KX-TG2383B: 3 KX-TG2383S: 3	
<input type="checkbox"/> Handset Cover (p. 10, 61)		PQKK10131Z3 (Black)  PQKK10131Z6 (Pearl White) PQKK10131Z5 (Silver)	KX-TG2382B: 2 KX-TG2383B: 3 KX-TG2382PW: 2 KX-TG2383S: 3	
<input type="checkbox"/> Belt Clip (p. 12)		PQKE10352Z3 (Black)  PQKE10352Z5 (Pearl White) PQKE10352Z4 (Silver)	KX-TG2382B: 2 KX-TG2383B: 3 KX-TG2382PW: 2 KX-TG2383S: 3	
<input type="checkbox"/> Charger Unit (p. 9)		Charger	PQLV30017ZB (Black)	KX-TG2382B: 1 KX-TG2383B: 2
			PQLV30017ZPW (Pearl White)	KX-TG2382PW: 1
			PQLV30017ZS (Silver)	KX-TG2383S: 2
		AC Adaptor	PQLV2Z (PQLV2)	KX-TG2382B: 1 KX-TG2382PW: 1 KX-TG2383B: 2 KX-TG2383S: 2

## For KX-TG2382B/KX-TG2382PW users

KX-TG2382B/KX-TG2382PW includes two handsets and one base unit. You can expand the system by adding up to one additional handset. A maximum of 3 handsets can be registered to the base unit. **The included handsets are pre-registered at the factory and assigned the extension numbers 1 and 2.**

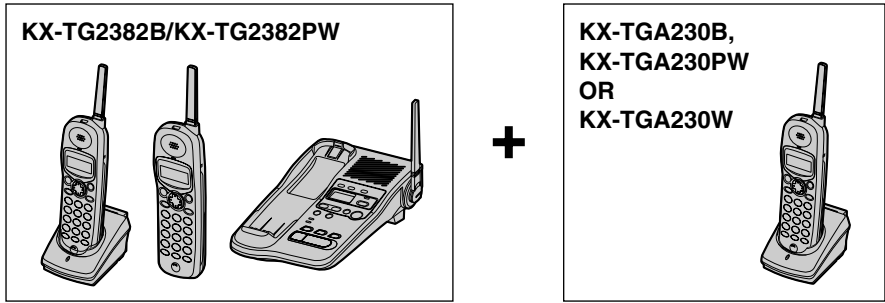

If you purchase accessory handsets, you must register each to the base unit. (Please read the KX-TGA230B, KX-TGA230PW or KX-TGA230W Installation Manual.)

The model number of the accessory handset is KX-TGA230B, KX-TGA230PW or KX-TGA230W. The charger is included. To order, contact your dealer or call 1-800-211-PANA(7262) to locate a dealer.

## For KX-TG2383B/KX-TG2383S users

KX-TG2383B/KX-TG2383S includes three handsets and one base unit. A maximum of 3 handsets can be registered to the base unit. **The included handsets are pre-registered at the factory and assigned the extension numbers 1, 2 and 3.**



- To re-register a handset to a different base unit of the same model, see pages 62 and 63.

# Contents

---

## *Preparation*

<b>For Best Performance</b> .....	6
<b>Location of Controls</b> .....	7
<b>Installation</b> .....	9
Connections .....	9
Installing the Battery in the Handset .....	10
Battery Charge .....	10
<b>Belt Clip</b> .....	12
<b>Optional Headset</b> .....	12
<b>Programmable Settings</b> .....	13
Programming Guidelines.....	13
Function Menu Table .....	14
Date and Time .....	15
Dialing Mode .....	16
Line Mode .....	17
Auto Talk Feature .....	18
Ringer Volume .....	19
LCD Contrast .....	20
<b>Preparing the Answering System</b> .....	21
Greeting Message.....	21
Caller's Recording Time.....	23
Number of Rings .....	24

## *Cordless Telephone*

<b>Making Calls</b> .....	25
System Capabilities (Operating More Than One Handset) .....	25
<b>Answering Calls</b> .....	29
<b>Caller ID Service</b> .....	30
<b>Using the Caller List</b> .....	31
Viewing the Caller List .....	31
Calling Back from the Caller List.....	32
Editing the Caller's Phone Number.....	33
The Caller ID Number Auto Edit Feature.....	34
Storing Caller List Information in the Directory .....	35
Erasing Caller List Information .....	36
<b>Directory</b> .....	37
Storing Names and Numbers .....	37
Dialing from the Directory .....	39
Editing.....	40
Erasing .....	41
<b>Intercom</b> .....	42
Making Intercom Calls.....	42
Answering Intercom Calls .....	43

<b>Transferring a Call</b> .....	44
<b>Conference Calls</b> .....	45
<b>Call Share</b> .....	45
<b>Special Features</b> .....	46
Temporary Tone Dialing (For Rotary or Pulse Service Users) .....	46
Muting Your Conversation.....	46
For Call Waiting Service Users .....	46
How to Use the PAUSE Button (For PBX Line/Long Distance Calls) .....	47
FLASH Button .....	47
Ringer Tone .....	48
Incoming Call Tone .....	48

## *Answering System*

<b>Automatic Answering Operation</b> .....	49
Setting the Unit to Answer Calls .....	49
<b>Listening to Messages</b> .....	50
<b>Erasing Messages</b> .....	51
<b>Remote Operation with the Handset</b> .....	52
<b>Remote Operation from a Touch Tone Phone</b> .....	54
Remote Code .....	55
Voice Menu .....	56
Direct Remote Operation .....	57

## *Useful Information*

<b>Wall Mounting</b> .....	58
<b>Adding Another Phone</b> .....	60
<b>Battery Replacement</b> .....	61
<b>Canceling Registration/Re-registration</b> .....	62
Canceling the Handset Registration .....	62
Re-registering the Handset .....	63
<b>If the Following Appear...</b> .....	64
<b>Troubleshooting</b> .....	66
<b>Important Safety Instructions</b> .....	71
<b>FCC and Other Information</b> .....	72
<b>Index</b> .....	75
<b>Warranty</b> .....	77
<b>Specifications</b> .....	79

# For Best Performance

---

## Battery charge

A rechargeable Ni-MH battery powers the handset. Charge the battery for about **15 hours** before initial use (p. 10).

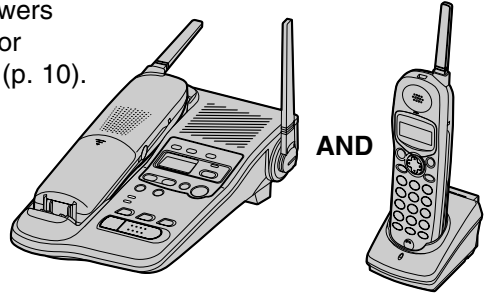

## Base unit location/Noise

Calls are transmitted between the base unit and the handset using wireless radio waves. **For maximum distance and noise-free operation**, the recommended base unit location is:

Away from electrical appliances such as a TV, personal computer or another cordless phone.

In a **HIGH** and **CENTRAL** location with no obstructions such as walls.

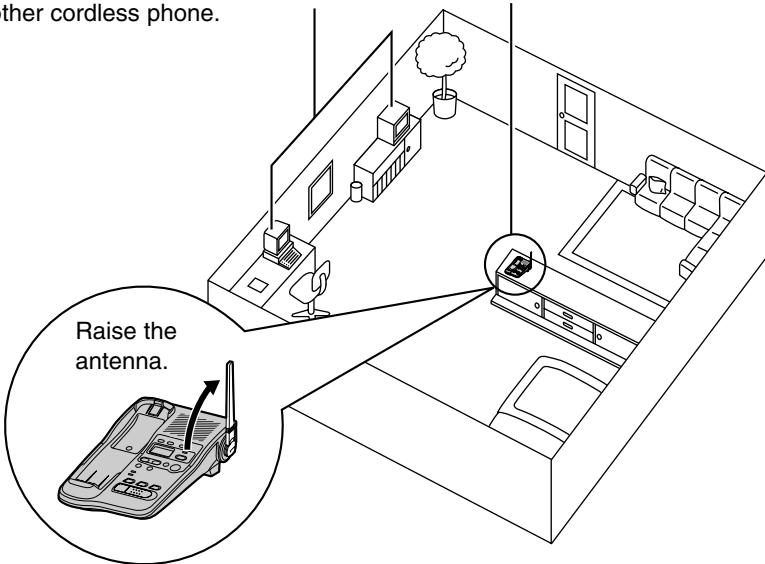

### Note:

While using the handset:

- If you are near a microwave oven which is being used, noise may be heard from the receiver or the speaker. Move away from the microwave oven and closer to the base unit.
- If you use the handset near another cordless phone's base unit, noise may be heard. Move away from the other cordless phone's base unit and closer to your base unit.

# Location of Controls



## Base unit

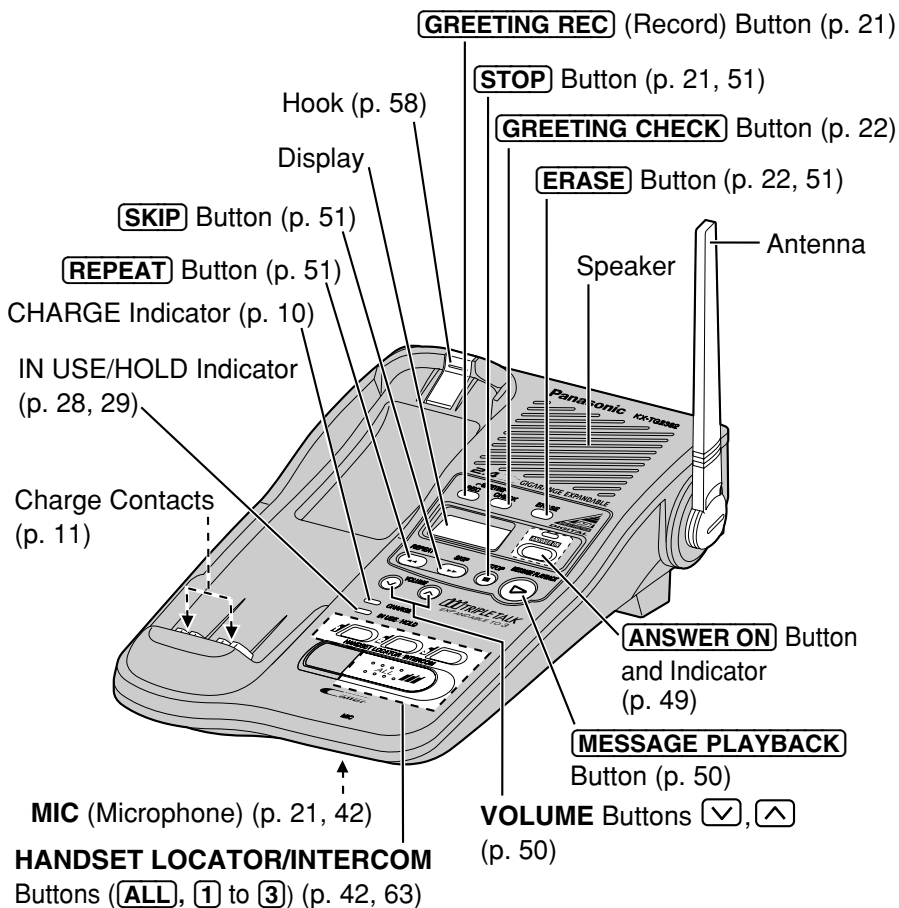

## Charger unit

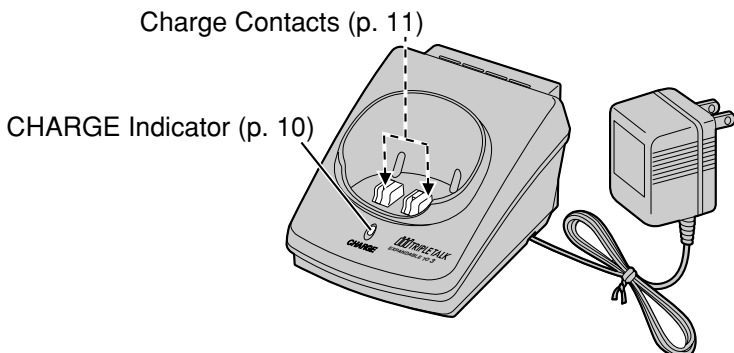

# ➔ Location of Controls

## Handset

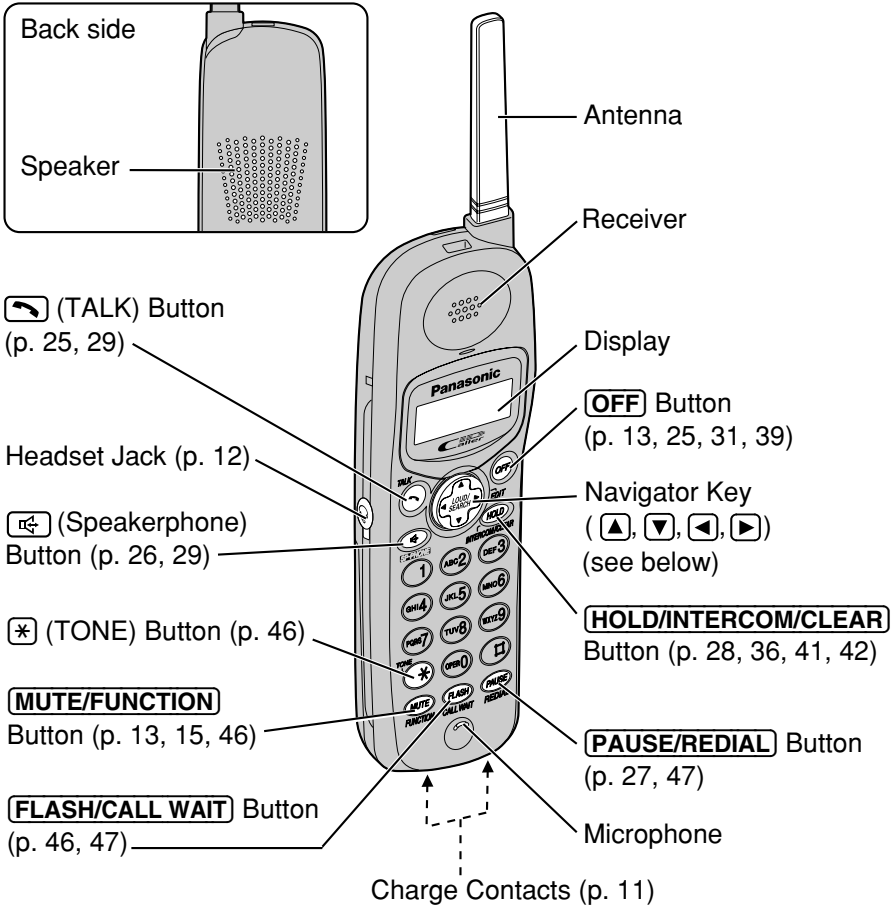

### How to use the Navigator key

This key has four active areas that are indicated by arrows.



- Pressing the up and down arrows allows you to scroll through a list of settings, the Caller List and your personal directory. The up and down arrows are also used to adjust the ringer volume and the receiver/speaker volume.
- Pressing the right and left arrows allows you to enter the directory list and to move the cursor when entering directory items.
- The right arrow is also used to select your menu choices.

Throughout these Operating Instructions, the Navigator key is indicated by the arrows ▼, ▲, ◀ or ▶.



# Installation



## Connections

### Base unit

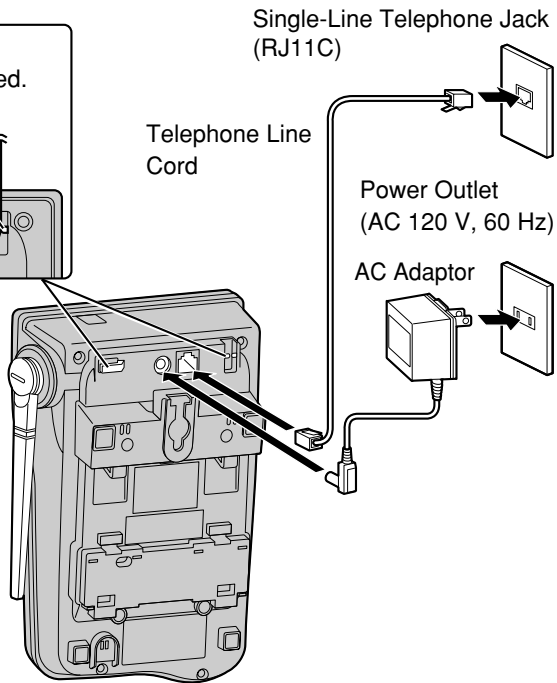
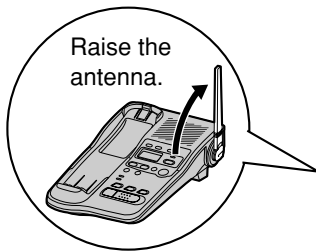
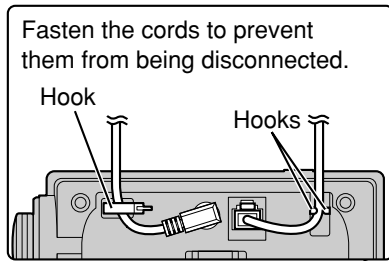

- USE ONLY WITH Panasonic AC ADAPTOR PQLV10 (Order No. PQLV10Z).
- The AC adaptor must remain connected at all times. (It is normal for the adaptor to feel warm during use.)
- To connect a standard telephone on the same line, see page 60.
- If your unit is connected to a PBX which does not support Caller ID services, you cannot access those services.

### Charger unit

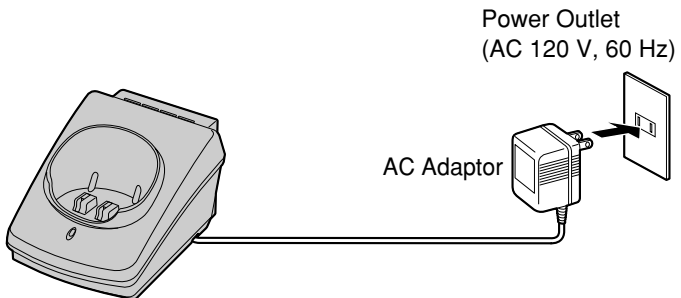

- USE ONLY WITH Panasonic AC ADAPTOR PQLV2 (Order No. PQLV2Z).
- The AC adaptor must remain connected at all times. (It is normal for the adaptor to feel warm during use.)

## ➔ Installation

### Installing the Battery in the Handset

Insert the battery into the handset as shown, matching the correct polarity (①). Press the battery down until it fits securely into the compartment (②). When finished, close the cover.

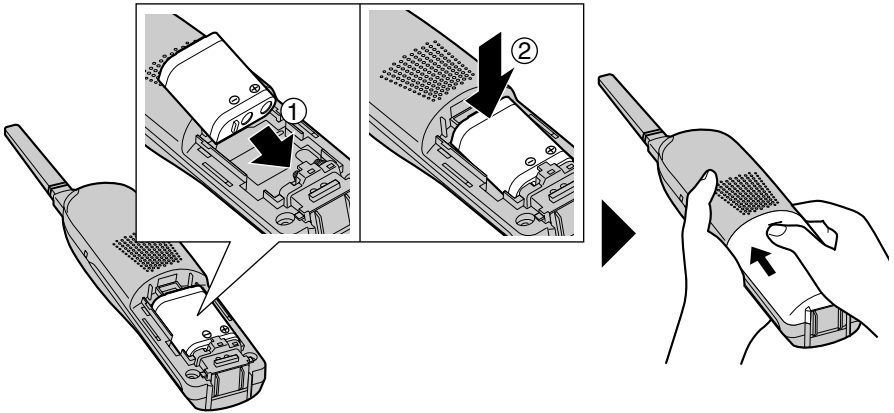

### Battery Charge

Place the handsets on the base unit and the charger, then charge for about **15 hours** before initial use.

- The CHARGE indicator on the base unit or the charger will light, a beep will sound and “Charging” will be displayed on the handset.
- Each handset’s extension number is shown in the top right of its display (“[1]”, “[2]” or “[3]”) (p. 3).
- You can charge either handset on the base unit or the charger.

Ex. Extension number 1

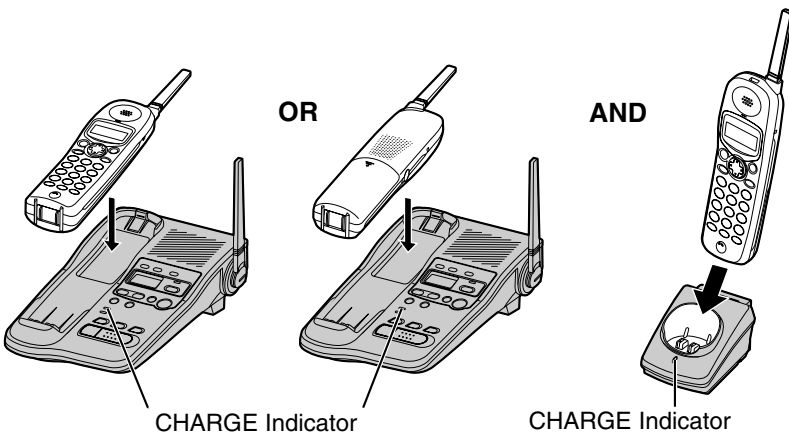
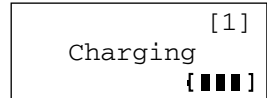

## Battery strength

You can check the battery strength on the handset display. The battery strength is as shown in the chart below.

Display prompt	Battery strength
{ ■■■ }	Fully charged
{ ■■ }	Medium
{ ■ }	Low
⚡ { ■ } ⚡ (flashing)	Needs to be recharged.

## Recharge

Recharge the battery when:

- “Recharge” is displayed on the handset,
- “{ ■ }” flashes on the display, or
- the handset beeps intermittently while it is in use.

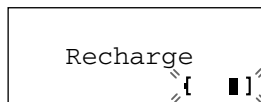

- If you DO NOT recharge the handset battery for more than 15 minutes, the display will continually indicate “Recharge” and/or “{ ■ }” will flash when the handset is lifted off the base unit or the charger.
- If the battery has been discharged, the handset will display “Charge for 15h” when you place the handset on the base unit or the charger. The handset will not work. Keep charging until fully charged.

## Battery information

After your Panasonic battery is fully charged (p. 10):

Operation	Operating time
While in use (TALK)	Up to 4 hours
While not in use (Standby)	Up to 7 days

- The battery operating time may be shortened depending on usage conditions and ambient temperature.
- Clean the charge contacts of the handset, the base unit and the charger with a soft, dry cloth once a month. Clean more often if the unit is subject to grease, dust or high humidity.** Otherwise the battery may not charge properly.
- If the battery is fully charged, you do not have to place the handset on the base unit or the charger until “Recharge” is displayed and/or “{ ■ }” flashes. This will maximize the battery life.
- The battery cannot be overcharged.

# Belt Clip

---

You can hang the handset on your belt or pocket using the belt clip.

## To attach the belt clip

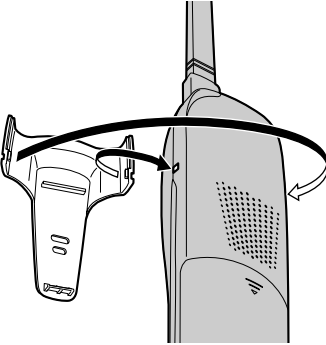

## To remove the belt clip

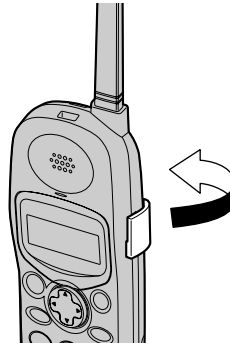

# Optional Headset



---

Plugging a headset into the handset allows a hands-free phone conversation. Please use only the Panasonic KX-TCA88 headset. To order, call the accessories telephone number on page 2.

## Connecting the optional headset to the handset

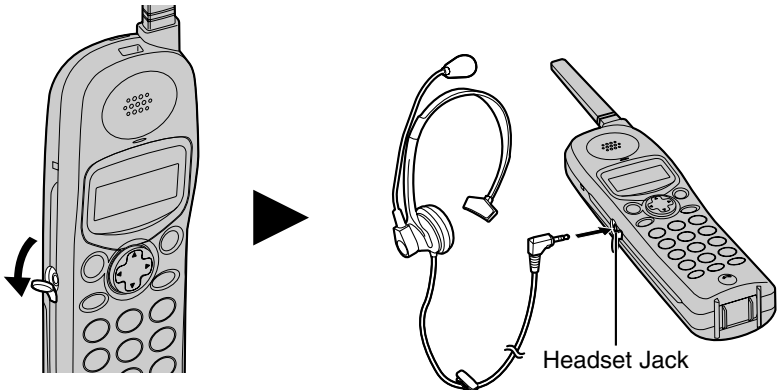
Open the headset jack cover, and connect the optional headset to the headset jack as shown below.



**To switch to the speakerphone while using the headset:**  
Press . To return to the headset, press .



## Programming Guidelines

This unit has programmable functions. Most of them are selected from the function menu on the display (p. 14).

Navigator key has four active areas that are indicated by arrows. The key is indicated by the arrows , , or in the Operating Instructions.

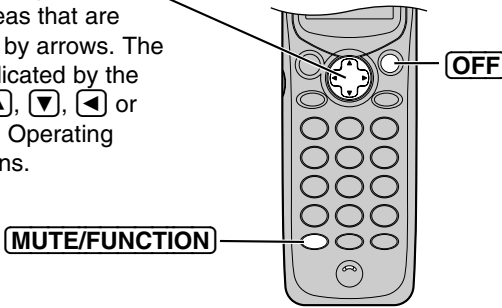

## How to select a function item from the menu

Make sure the unit is not being used and the handset is lifted off the base unit.

1. Press **MUTE/FUNCTION**.
  - The main menu is displayed (p. 14).
2. You can scroll through the menu by pressing or . Scroll to the desired item by pressing or .
3. Press to select the item.
4. If the item has a sub-menu I, it will be displayed. Select the sub-menu item by pressing or , and press . If the sub-menu I item has the sub-menu II, it will be displayed. Select the sub-menu II item in the same way.
5. You can then select the desired setting by pressing or .
6. To save the setting, press (Save key).
  - When programming is complete, a confirmation tone sounds. The display will return to the main menu or the sub-menu I or the sub-menu II (if the function item is in the sub-menu I or in the sub-menu II). You can continue programming other items. To exit the menu, press **OFF**.

```
-----  
▶Save directory  
Message play
```

```
Message play  
▶Ringer setting  
Date and time
```

```
Ringer volume  
▶Ringer tone  
Incoming call
```

```
Ex. Ringer tone setting  
Ringer tone  
:1  
▼▲ ▶=Save
```

# ➔ Programmable Settings

## Useful information:

- “-----” indicates the beginning or end of the function menu.
- You can go back to the previous display by pressing **◀** except when entering characters or numbers. To return to the main menu from the sub-menu I or sub-menu II, press **◀**.
- You can exit the programming mode any time by pressing **OFF**.
- If you do not press any buttons for 60 seconds, the handset will exit the programming mode.
- If the unit detects a problem, an error message will be displayed (p. 64).

## Function Menu Table

You can use the following functions to customize your unit. After pressing **MUTE/FUNCTION**, the main menu is displayed. Most items in the main menu have a sub-menu I. The sub-menu I is shown after selecting the item in the main menu. If the sub-menu I item has the sub-menu II, it will be displayed after selecting that sub-menu I item. See the corresponding pages for function details.

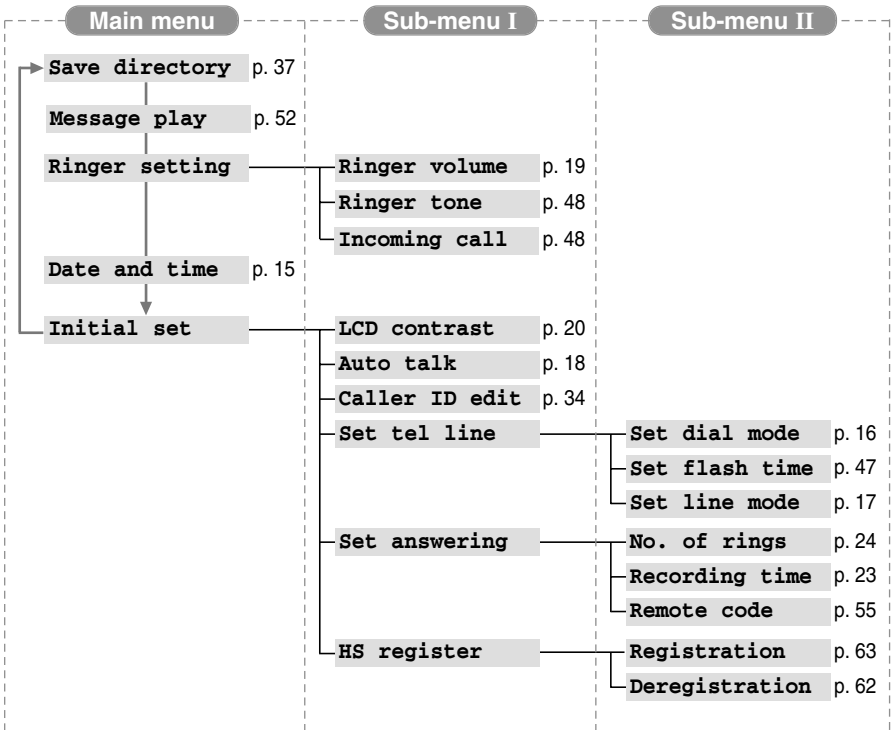

- If you program the date and time, the dialing mode, the flash time, the line mode, the number of rings, the recording time or the remote code using one of the handsets, you will not need to program the same function using the other handsets.



# Date and Time

“⌚” flashes on the base unit display if the clock has not been set. The clock needs adjusting.

Base unit display

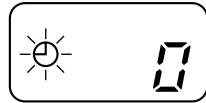

**Voice Day/Time Stamp:** During playback, a synthesized voice will announce the day and time that each message was recorded.

**Make sure the unit is not being used and the handset is lifted off the base unit.**

1 Press **[MUTE/FUNCTION]**.

2 Scroll to “Date and time” by pressing **[▼]** or **[▲]**.

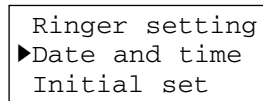

3 Press **[▶]**.

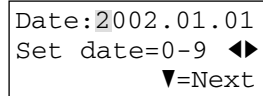

4 Enter the year, and month and day using 4-digit numbers. (Ex. To set Aug. 7, 2003, enter “2003” and “0807”.)

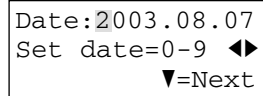

- If you enter a wrong number, press **[◀]** or **[▶]** to move the cursor to the incorrect number. Enter the correct number.

5 Press **[▼]** (Next key).

- If 3 beeps sound, the setting is not correct. Enter the correct number.

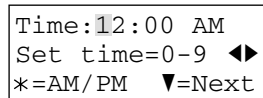

6 ① Enter the time (hour and minute) using a 4-digit number. (Ex. To set 9:30, enter “0930”.)

- ② Select “AM” or “PM” by pressing **[\*]**.

7 Press **[▼]** (Next key).

- If you want to change the setting, press **[▲]** (Edit key) to reach the desired display and change it.

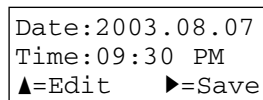

8 Press **[▶]** (Save key).

- A beep sounds and the clock starts working.
- To exit the programming mode, press **[OFF]**.

If a power failure occurs, the time may be shifted. When “⌚” flashes on the base unit display, adjust the date/time.

• You can exit the programming mode any time by pressing **[OFF]**.

## ➡ Programmable Settings

- When entering the time in step 6, you cannot enter numbers greater than 12. **Do not use military time.** (To set 13:00 hours, enter “0100”, and select “PM” by pressing **[\*]**.)

### To check the date/time

**[MUTE/FUNCTION]** → **[▼]** or **[▲]** to select “Date and time” → **[▶]** →  
→ **[▼]** (Next key) TWICE → Date and time will be displayed. → **[OFF]**

### For Caller ID service users (p. 30)

- The Caller ID information will reset the clock after the first ring if the adjusted time is incorrect.
- If the clock has not previously been set, the Caller ID information will not adjust the clock.
- The Caller ID information will automatically adjust the clock for daylight saving time.

## Dialing Mode

If you have touch tone service, set to “Tone”. If rotary or pulse service is used, set to “Pulse”. Your phone comes from the factory set to “Tone”. **Make sure the unit is not being used and the handset is lifted off the base unit.**

1 Press **[MUTE/FUNCTION]**.

```
-----  
▶Save directory  
Message play
```

2 Scroll to “Initial set” by pressing **[▼]** or **[▲]**, and press **[▶]**.

```
Date and time  
▶Initial set  
-----
```

3 Scroll to “Set tel line” by pressing **[▼]** or **[▲]**, and press **[▶]**.

```
Caller ID edit  
▶Set tel line  
Set answering
```

4 Press **[▶]** at “Set dial mode”.  
•The current setting is displayed.

```
-----  
▶Set dial mode  
Set flash time
```

5 Select “Pulse” or “Tone” by pressing **[▼]** or **[▲]**.

```
Set dial mode  
:Tone  
▼▲ ▶=Save
```

6 Press **[▶]** (Save key).  
•A beep sounds.  
•To exit the programming mode, press **[OFF]**.

```
Set dial mode  
:Pulse
```

- You can exit the programming mode any time by pressing **[OFF]**.





# Line Mode

The line mode is preset at the factory to “B”. Generally leave the line mode to “B”. If a change of the line mode setting is required by our customer call center or serviceman, change the line mode to “A”.

**Make sure the unit is not being used and the handset is lifted off the base unit.**

1 Press **MUTE/FUNCTION**.

```
-----
▶Save directory
Message play
```

2 Scroll to “Initial set” by pressing **▼** or **▲**, and press **▶**.

```
Date and time
▶Initial set
-----
```

3 Scroll to “Set tel line” by pressing **▼** or **▲**.

```
Caller ID edit
▶Set tel line
Set answering
```

4 Press **▶**.

```
-----
▶Set dial mode
Set flash time
```

5 Scroll to “Set line mode” by pressing **▼** or **▲**.

```
Set flash time
▶Set line mode
-----
```

6 Press **▶**.  
•The current setting is displayed.

```
Set line mode
: B
▼▲ ▶=Save
```

7 Select “A” or “B” by pressing **▼** or **▲**.

```
Set line mode
: A
▼▲ ▶=Save
```



8 Press **▶** (Save key).  
•A beep sounds.  
•To exit the programming mode, press **OFF**.

```
Set line mode
: A
```

•You can exit the programming mode any time by pressing **OFF**.

## ➔ Programmable Settings



### Auto Talk Feature

The Auto Talk feature allows you to answer a call by lifting the handset off the base unit or the charger without pressing  or . If you want to use this feature, turn the feature ON by programming. Your phone comes from the factory set to OFF.

**Make sure the unit is not being used and the handset is lifted off the base unit.**

1 Press **MUTE/FUNCTION**.



```
-----
▶Save directory
  Message play
```

2 Scroll to "Initial set" by pressing  or .

```
Date and time
▶Initial set
-----
```

3 Press .

```
-----
▶LCD contrast
  Auto talk
```



4 Scroll to "Auto talk" by pressing  or .

```
LCD contrast
▶Auto talk
  Caller ID edit
```

5 Press .

- The current setting is displayed.

```
Auto talk
                                :Off
▼▲                               ▶=Save
```

6 Select "On" or "Off" by pressing  or .

```
Auto talk
                                :On
▼▲                               ▶=Save
```

7 Press  (Save key).

- A beep sounds.
- To exit the programming mode, press **OFF**.

```
Auto talk
                                :On
```

- You can exit the programming mode any time by pressing **OFF**.
- In order to view Caller ID information after you lift up the handset to answer a call, leave the Auto Talk feature OFF.



# Ringer Volume

You can program the handset ringer volume to HIGH, MEDIUM, LOW or OFF. If set to OFF, the handset will not ring for external calls, and for internal calls it will ring at the LOW level. Your phone comes from the factory set to HIGH.

**Make sure the unit is not being used and the handset is lifted off the base unit.**

- 1 Press **MUTE/FUNCTION**.
- 2 Scroll to "Ringer setting" by pressing **▼** or **▲**, and press **▶**.
- 3 Press **▶** at "Ringer volume".
- 4 Select the desired volume by pressing **▼** or **▲**.
  - Each time you press **▼** or **▲**, the volume will change and ring.
  - To turn the ringer OFF:** press **▼** repeatedly until "Off ?" is displayed.
- 5 Press **▶** (Save key).
  - A beep sounds.

```

Message play
▶Ringer setting
Date and time
  
```

```

-----
▶Ringer volume
Ringer tone
  
```

HIGH

```

Ringer volume
Low  . . . . . High
▼▲          ▶=Save
▲ ↑          ↓ ▼
  
```

MEDIUM

```

Ringer volume
Low  . . . . High
▲ ↑          ↓ ▼
  
```

LOW

```

Ringer volume
Low  . .      High
▲ ↑          ↓ ▼
  
```

OFF

```

Ringer volume
Off ?
  
```

### To turn the ringer ON:

Press **▲** in step 4.

- The ringer will sound at the LOW level.

- You can exit the programming mode any time by pressing **OFF**.
- If set to OFF, "Ringer off" will be displayed while the handset is not in use.
- If you have received new calls, "Ringer off" will not be displayed but "Received calls" will be displayed while the handset is not in use. "Ringer off" will be displayed for about 5 seconds after completing operations or lifting the handset from the base unit or the charger.
- You can also select the ringer volume while an external call is being received. Press **▼** or **▲** while the handset is just ringing.
- You can change the ringer tone for external calls. See page 48.

# ➔ Programmable Settings

## LCD Contrast

You can program the handset LCD contrast (6 levels). Your phone comes from the factory set to level 3.

**Make sure the unit is not being used and the handset is lifted off the base unit.**

1 Press **MUTE/FUNCTION**.

2 Scroll to "Initial set" by pressing **▼** or **▲**, and press **▶**.

```
Date and time
▶Initial set
-----
```

3 Press **▶** at "LCD contrast".

```
-----
▶LCD contrast
Auto talk
```

4 Select the desired contrast by pressing **▼** or **▲**.

- Each time you press **▼** or **▲**, the LCD contrast will change.
- The number of steps shows the LCD contrast level.

Level 6

```
LCD contrast
Low  . . . . . High
▼▲          ▶=Save
```

Level 4

```
LCD contrast
Low  . . . . High
```

Level 1

```
LCD contrast
Low  - High
```

5 Press **▶** (Save key).

- A beep sounds.
- To exit the programming mode, press **OFF**.

•You can exit the programming mode any time by pressing **OFF**.

# Preparing the Answering System

## Greeting Message

You can record a personal greeting message of **up to 2 minutes**. If a greeting message is not recorded, one of two pre-recorded greetings will be played when a call is received (p. 22).

The **total recording time** of all messages (greeting, incoming) is **about 15 minutes**. We recommend you record a **brief greeting message** (p. 22) in order to leave more time for recording new messages.

### To record a greeting message

- 1 Press **GREETING REC** to start the recording mode.
  - “Press RECORD again to record greeting” is heard.
- 2 Within 5 seconds, press **GREETING REC** again to record your greeting.
  - A long beep sounds.
- 3 After the long beep, talk clearly, about 20 cm (8 inches) away from the **MIC** (microphone).
  - The base unit display shows the elapsed recording time.
  - If you record for over 2 minutes, the unit will automatically stop recording.
- 4 When finished, press **GREETING REC**.
  - You can also finish recording by pressing **STOP**.
  - To change the greeting, start again from step 1.

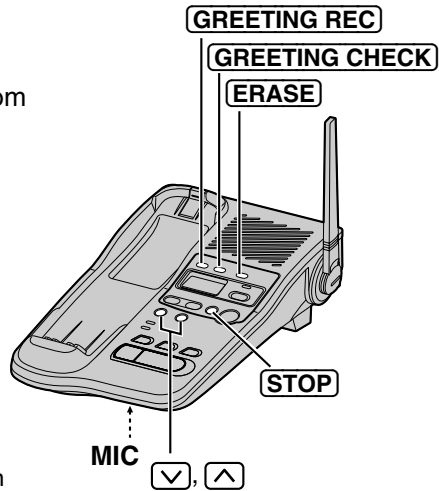

•If “E” is displayed, 6 beeps sound and “Your greeting was not recorded. Record your greeting again.” is announced, start again from step 1.

## ➡ Preparing the Answering System

### Greeting message sample:

“Hello, this is (your name and/or number). Sorry I cannot take your call. Please leave a message after the beep. Thank you.”

### To adjust the speaker volume:

9 levels (0–8) are available while using the Answering System. To increase, press .

To decrease, press .

Ex. Level 8





### To check the recorded greeting message

Press .

- The greeting message will be played.

### To erase the recorded greeting message

Press , and then press  while the message is being played.

- The unit will answer a call with a pre-recorded greeting message.

### Pre-recorded greeting message

If you do not record a greeting message (p. 21), one of two messages will be played when a call is received, depending on the caller's recording time (p. 23).

To check the pre-recorded greeting, press .

- A pre-recorded greeting will be played as follows:
  - When the recording time is set to “1 minute”, “2 minutes” or “3 minutes”:  
“Hello, we are not available now. Please leave your name and phone number after the beep. We will return your call.”
  - When the recording time is set to “Greeting only”:  
“Hello, we are not available now. Please call again. Thank you for your call.”

### Flash Memory Message Backup (Message storage)

Messages are stored on a “flash memory” IC chip and will not be affected by power failures. All messages are saved until you erase them.



## Caller's Recording Time

You can select "1 minute", "2 minutes", "3 minutes" or "Greeting only" for the caller's recording time. Your phone comes from the factory set to "3 minutes".

**Make sure the unit is not being used and the handset is lifted off the base unit.**

- 1 Press **MUTE/FUNCTION**.
- 2 Scroll to "Initial set" by pressing **▼** or **▲**, and press **▶**.
- 3 Scroll to "Set answering" by pressing **▼** or **▲**, and press **▶**.
- 4 Scroll to "Recording time" by pressing **▼** or **▲**.
- 5 Press **▶**.
  - The current setting is displayed.
- 6 Select the recording time by pressing **▼** or **▲**.
  - You can also select the recording time by pressing **1** (1 minute), **2** (2 minutes), **3** (3 minutes) or **0** (Greeting only).
- 7 Press **▶** (Save key).
  - A beep sounds.
  - To exit the programming mode, press **OFF**.

Date and time  
▶Initial set  
-----

Set tel line  
▶Set answering  
HS register

No. of rings  
▶Recording time  
Remote code

Recording time  
:3min  
▼▲ ▶=Save

Recording time  
:Greeting only  
▼▲ ▶=Save

- You can exit the programming mode any time by pressing **OFF**.

If you select "Greeting only", the unit will answer a call with the greeting message, and then hang up. The unit will not record any incoming messages. The display will show "5.0" instead of the number of messages.

Base unit display

5.0

## ➔ Preparing the Answering System

### Number of Rings

You can select the number of times the unit rings before the Answering System answers a call, from “2” to “7” or “Toll saver”\*. The Answering System needs to be on. Your phone comes from the factory set to “4”.

**Make sure the unit is not being used and the handset is lifted off the base unit.**

1 Press **MUTE/FUNCTION**.

2 Scroll to “Initial set” by pressing **▼** or **▲**, and press **▶**.

```
Date and time
▶Initial set
-----
```

3 Scroll to “Set answering” by pressing **▼** or **▲**.

```
Set tel line
▶Set answering
HS register
```

4 Press **▶**.

```
-----
▶No. of rings
Recording time
```

5 Press **▶** at “No. of rings”.  
•The current setting is displayed.

```
Number of rings
:4
▼▲ ▶=Save
```

6 Select the number of rings by pressing **▼** or **▲**.  
•You can also select the number of rings by pressing **0** (Toll saver\*), or **2** to **7**.

```
Number of rings
:Toll saver
▼▲ ▶=Save
```

7 Press **▶** (Save key).  
•A beep sounds.  
•To exit the programming mode, press **OFF**.

•You can exit the programming mode any time by pressing **OFF**.

#### \*Toll saver

When you call the unit from outside:

If the unit answers on the 2nd ring, there is at least one new message.

If the unit answers on the 4th ring, there are no new messages.

**Hang up when you hear the 3rd ring.** This will save you the toll charge for the call.



# Making Calls



## System Capabilities (Operating More Than One Handset)

At most 3 extensions (3 handsets or 2 handsets and base unit) can operate at a time. But during a conference call (p. 45), only 2 handsets can be used. If the 3rd handset tries to join, its LCD displays "Busy" and it will not join the conversation.

## Using the Handset

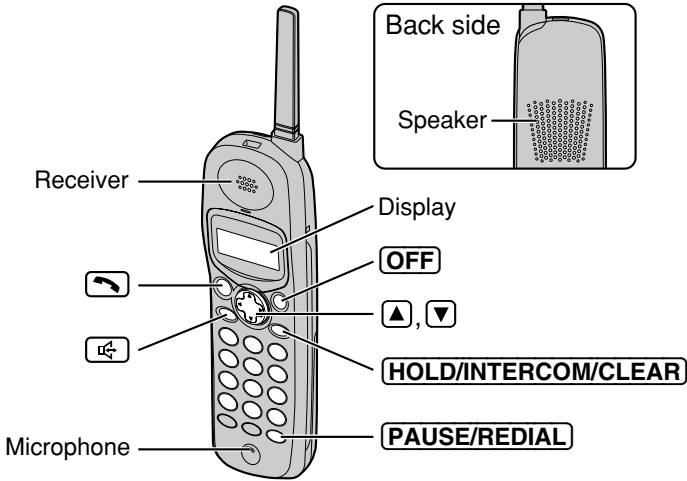

Cordless Telephone

1 Press



2 Dial a phone number.

- The dialed number is displayed.
- After a few seconds, the display will show the length of the call and the battery strength.

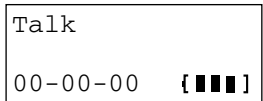
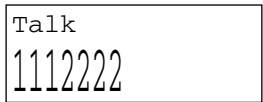

3 To hang up, press **OFF** or place the handset on the base unit or the charger.

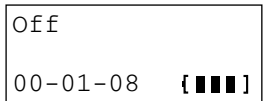

•When a handset is engaged in an outside call, "Line in use" is shown on the display of other handsets.

## ➔ Making Calls

### To have a hands-free phone conversation (Using Digital Duplex Speakerphone)

- 1 Press .
- 2 Dial a phone number.
  - The dialed number is displayed.
  - After a few seconds, the display will show the length of the call and the battery strength.
- 3 When the other party answers, talk into the microphone.
- 4 To hang up, press **OFF** or place the handset on the base unit or the charger.

SP-phone





SP-phone  
1112222

SP-phone  
00-00-00 [■■■■]

Off  
00-01-08 [■■■■]

#### Hands-free Digital Duplex Speakerphone

For best performance, please note the following:

- Talk alternately with the caller in a quiet room.
- If the other party has difficulty hearing you, press  to decrease the speaker volume.
- If the other party's voice from the speaker cuts in/out during a conversation, press  to decrease the speaker volume.
- While talking using , you can switch to the hands-free phone conversation by pressing . To switch back to the receiver, press .



## To dial after confirming the entered number

1 Dial a phone number.

- If you misdial, press **HOLD/INTERCOM/CLEAR**. One digit is erased. Dial the correct phone number.
- To cancel, press **OFF**.

3334444

2 Press .

OR  
To have a hands-free phone conversation, press , and when the other party answers, talk into the microphone.

- After a few seconds, the display will show the length of the call and the battery strength.

Ex. was pressed.

Talk  
3334444

3 To hang up, press **OFF** or place the handset on the base unit or the charger.

## To redial the last number dialed on the handset

Press or and press **PAUSE/REDIAL**.

## To redial using the redial list (Memory Redial)

The last 5 phone numbers dialed with the handset are stored in the redial list.

1. Press **PAUSE/REDIAL**.

- The last number dialed is displayed.

2. Scroll to the desired number by pressing or .

- You can also scroll through the list by pressing **PAUSE/REDIAL**.
- To exit the list, press **OFF**.

3. Press or .

333-4444

▼▲ Redial list1

- To erase an item, repeat steps 1 and 2, and press **HOLD/INTERCOM/CLEAR**.
- If "No items stored" is displayed, the list is empty.

## ➡ Making Calls

### To put a call on hold

Press **[HOLD/INTERCOM/CLEAR]** twice.



- The IN USE/HOLD indicator light flashes, "Hold" is displayed and the call is put on hold.

- To transfer the call to another handset, see page 44.
- If a call is kept holding for 6 minutes, an alarm tone will start to sound. After 4 additional minutes on hold the call will be disconnected.
- When you put the call on hold, "Line on hold" is shown on the display of other handsets.

### To release the hold

Press or .

- Another handset user can also release the hold by pressing or .
- If another phone is connected on the same line (p. 60), you can also release the hold by lifting its handset.

### To adjust the receiver volume (HIGH, MEDIUM or LOW) or speaker volume (6 levels) while talking

To increase, press .

To decrease, press .

Ex. Receiver volume: High  
Speaker volume: Level 6

- Each time you press or , the volume level will change.
- The number of steps indicates the volume level.
- The display will return to the length of the call.



### Lighted handset keypad

The handset dialing buttons will light when you press a button, lift the handset off the base unit or the charger, or when a call is received. The lights will go out a few seconds after pressing a button, lifting the handset, answering a call, hanging up a call, leaving the programming mode or ending the intercom.

### Backlit LCD display

The lighted handset display will stay on for a few seconds after pressing a handset button, lifting the handset off the base unit or the charger, hanging up a call, leaving the programming mode or ending the intercom.

# Answering Calls

When a call is received, the unit rings and “Incoming call” is displayed on the handset and the IN USE/HOLD indicator flashes quickly on the base unit.

If you subscribe to a Caller ID service, the calling party information will be displayed after the first ring (p. 30). In order to view the Caller ID information, please wait until the second ring to answer a call.



- 1 Press .
  - You can also answer a call by pressing any dialing button **0** to **9**, **\*** or **#** (**Any Key Talk**).

OR

Press , and when the other party answers, talk into the microphone.

- 2 To hang up, press **OFF**.

## Auto Talk

If you set the Auto Talk feature to ON (p. 18), you can answer a call by lifting the handset off the base unit or the charger without pressing  or .

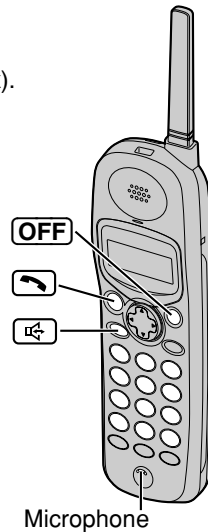

# Caller ID Service

---

This unit is compatible with a Caller ID service offered by your telephone company. If you subscribe to a Caller ID service, the calling party's information will be shown on the handset after the first ring.

The handset can record information of up to 30 different callers, including the time and date received and the number of times called, in the Caller List. The Caller List information is sorted by the most recent to the oldest call. When the 31st call is received, the first call is deleted.

Using the list, you can automatically call back a caller. You can store the callers' names and numbers from the Caller List into the directory. If you subscribe to both Caller ID and Call Waiting services, when a second call is received while talking, the new caller's name and phone number will be displayed (p. 46).

## How caller information is displayed when a call is received

The handset display shows the caller's name and phone number after the first ring.

ROBINSON, TINA  
1-000-222-3333

•After you answer the call, the display will show the length of the call.

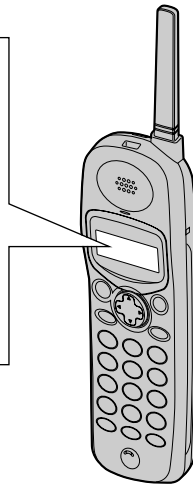

- Caller information cannot be displayed in the following cases:
  - If the caller dialed from an area which does not provide a Caller ID service, the display will show "Out of area".
  - If the caller has requested not to display his/her information, the display will show "Private caller".
- If your unit is connected to a PBX which does not support Caller ID services, you cannot access those services.
- The name display service may not be available in some areas. For further information, please contact your telephone company.
- If the handset has lost communication with the base unit when a call is received, the caller information will not be recorded in the Caller List.

# Using the Caller List



If you have received new calls, "Received calls" will be displayed while the handset is not in use.

Handset on the base unit

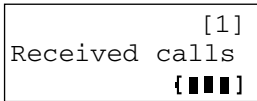

Handset off the base unit

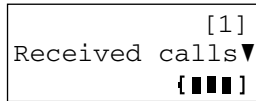

## Viewing the Caller List

To check who has called, follow the steps below.

**Make sure the unit is not being used and the handset is lifted off the base unit.**

- 1 Press or to enter the Caller List.
  - The display will show, for example, the following.

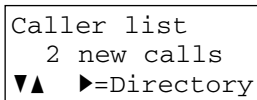

- 2 To search from the most recent call, press .  
To search from the oldest call, press .
  - To scroll between callers, press or .

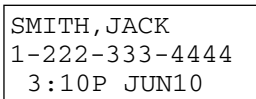

- 3 To exit the list, press **OFF**.

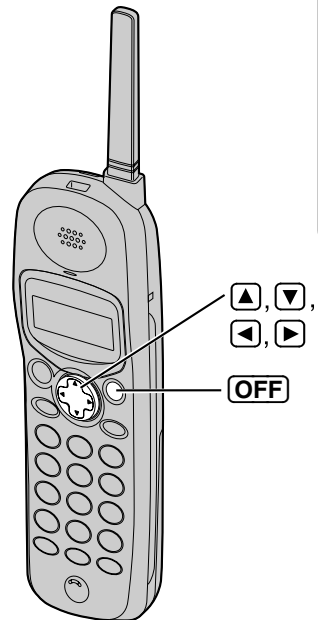

Cordless Telephone

- If "No items stored" is displayed, the Caller List is empty.
- If there is no name information for a caller, the display will only show the phone number.
- After viewing all of the new call entries in the Caller List, "Received calls" will disappear.
- Once new calls have been checked, "√" will be added to caller information.
- Each handset has the Caller List individually. If you checked the Caller List on your handset, Caller List information in the other handsets will remain still NEW and "√" will not be added.
- In step 1, you can go to the directory list by pressing (p. 39).
- If you do not press any buttons for 60 seconds, the handset will exit the Caller List.

## ➡ Using the Caller List

---

### What “√” means

When the display shows “√”, you have already viewed this calling information, answered the call or called back the caller. If the same caller calls again, the call entry with “√” will be replaced with the new call entry.

SMITH, JACK 1-222-333-4444 3:10P JUN10 √
--



### If a caller calls more than once

The number of times the same caller called is displayed (X2 to X9). The date and time of the most recent call will be recorded. After checking, X2 to X9 will be replaced with “√”.



Ex. The caller called 3 times.

TURNER, CINDY 1-234-456-7890 11:20A JAN12 X3
--



## Calling Back from the Caller List

1 Press  or  to enter the Caller List.

Caller list 3 new calls ▼▲ ►=Directory
--

2 Scroll to the desired caller by pressing  or .

TURNER, CINDY 1-234-456-7890 11:20A JAN12 X3
--

3 Press  or .  
•The displayed phone number is dialed automatically.

Ex. Talk mode

Talk 12344567890
---------------------

- In some cases, you may have to edit the number before dialing (p. 33).  
(Ex. You may have to delete “1” and the area code.)
- If a phone number is not displayed in the caller information, you cannot call back that caller.





# Editing the Caller's Phone Number

You can edit a phone number into one of 3 patterns to call back or store it into the directory.

### The Caller ID Number Auto Edit Feature (p. 34)

This feature will allow the unit to edit a Caller ID number into one of 3 patterns you desired for you automatically in the Caller List. For details and activation please see page 34.

**Make sure the unit is not being used and the handset is lifted off the base unit.**

1 Press or to enter the Caller List.

```
Caller list
5 new calls
▼▲ ▶=Directory
```

2 Scroll to the desired caller by pressing or .

```
PARKER, FRED
1-234-321-5555
11:20A JAN12 ✓
```

3 Press .

```
▶Edit
Save directory
▼▲ ▶=Yes
```

4 Press (Yes key) at "Edit".

```
PARKER, FRED
1-234-321-5555
▼=Next ▶=Edit
```

5 Press (Edit key) to select a pattern.

Ⓐ 321-5555  
▼=Next ▶=Edit

•Each time you press , the number is rearranged into one of 3 patterns.

Ⓐ

Ⓑ  -

Ⓒ 1 -  -

•The order in which patterns Ⓐ-Ⓒ are displayed depends on how the telephone number is displayed in step 2.

Ⓑ 234-321-5555  
▼=Next ▶=Edit

Ⓒ 1-234-321-5555  
▼=Next ▶=Edit

6 After editing the number, you can continue with calling back or storing procedures.

To call back, press or (p. 32).

To store the number in the directory, press (Next key) and press (Save key). (If the caller has no name information, see page 35, from step 3.)

## ➡ Using the Caller List

### The Caller ID Number Auto Edit Feature

There are 3 patterns of phone number (ⓐ, ⓑ, and ⓒ on p. 33). This feature allows your phone to automatically edit an in-coming Caller ID number into one pattern you preferred, and display the Caller ID number with that pattern on the handset automatically.

After this feature is activated, Caller ID numbers coming from considered area codes (201, for example), from which the Caller ID numbers have been chosen to follow the desired pattern (7 digit pattern, for example), will be automatically edited from other patterns (11 digit pattern, for example) into the same pattern you have previously selected (which is 7 digit pattern, in the example).

Up to 4 area codes are allowed for this feature for patterns ⓐ, ⓑ and ⓒ (p. 33).

To activate this feature, you must (1) set this feature to on, and (2) make an out-going call from Caller List (p. 32) with a number which has one of 3 patterns that you have edited with considered area code, and that you prefer to be followed by future Caller ID numbers, so that in the future all the Caller ID numbers coming from the same area code will be displayed in the same pattern.

The Caller ID number Auto Edit feature is preset to ON at factory.

•If you fail to reach your destination when making the call, the phone number you dialed might have an incorrect pattern, please edit the phone number with another pattern (p. 33).

For example, if you move to another area, you may need to turn this feature to OFF to erase previously edited area codes. Then, if still need, you may activate this feature again.

**Make sure the unit is not being used and the handset is lifted off the base unit.**

1. Press **MUTE/FUNCTION**.
2. Scroll to "Initial set" by pressing **▼** or **▲**, and press **▶**.
3. Scroll to "Caller ID edit" by pressing **▼** or **▲**, and press **▶**.
4. Select "On" or "Off" by pressing **▼** or **▲**.
5. Press **▶** (Save key).
  - A beep sounds.
  - To exit the programming mode, press **OFF**.

Date and time ▶Initial set -----
--

Auto talk ▶Caller ID edit Set tel line
--

Auto edit	:On
▼▲	▶=Save

•When the feature is set to OFF, the unit will still be able to display Caller ID, like regular Caller ID telephone, but the in-coming Caller ID number will not be edited by pattern and by area codes.



# Storing Caller List Information in the Directory

You can store phone numbers that are in the Caller List into the directory. **Make sure the unit is not being used and the handset is lifted off the base unit.**

1 Press or to enter the Caller List.

```
Caller list
  10 new calls
▼▲ ▶=Directory
```

2 Scroll to the caller you want to store in the directory by pressing or , and press .

```
TURNER, CINDY
1-234-456-7890
11:20A JAN12 X3
```

•If the number requires editing, see page 33.

```
▶Edit
  Save directory
▼▲ ▶=Yes
```

3 Scroll to “Save directory” by pressing or , and press .

```
  Edit
▶Save directory
▼▲ ▶=Yes
```

- A beep sounds.
- To continue storing other items, repeat from step 2.
- To exit the programming mode, press **OFF**.

```
TURNER, CINDY
1-234-456-7890
```

**If there is no name information for the caller, “Enter name” will be displayed.**

- If a name is not required, press (Next key) and press (Save key).
- If a name is required, enter the name (p. 38). When finished, press (Next key) and press (Save key).

- A beep sounds.
- To continue storing other items, repeat from step 2.
- To exit the programming mode, press **OFF**.

```
Enter name
█
◀▶ ▼=Next
```

```
Enter name
CINDY TURNER
◀▶ ▼=Next
```

```
CINDY TURNER
1-234-456-7890
```

- You can exit the programming mode any time by pressing **OFF**.
- If the display shows “Directory full” in step 3, press **OFF** to exit the list. To erase other stored items from the directory, see page 41.
- You cannot store caller information in the directory if a phone number is not displayed.

## ➡ Using the Caller List

---

### Erasing Caller List Information

After checking the Caller List, you can erase some or all of the entries. **Make sure the unit is not being used and the handset is lifted off the base unit.**

#### To erase a specific caller from the Caller List

1 Press **▼** or **▲** to enter the Caller List.

```
Caller list
10 new calls
▼▲ ▶=Directory
```

2 Scroll to the caller you want to erase from the Caller List by pressing **▼** or **▲**.

```
REAGAN, TOM
1-888-777-6666
12:20A JAN12 ✓
```

3 Press **HOLD/INTERCOM/CLEAR**.  
•A beep sounds and the information is erased.  
•To erase other items, repeat from step 2.  
•To exit the Caller List, press **OFF**.

```
Clear
```

#### To erase all entries in the Caller List

Before erasing all entries, make sure that “0 new call” is displayed.

1 Press **▼** or **▲** to enter the Caller List.

```
Caller list
0 new call
▼▲ ▶=Directory
```

2 Press **HOLD/INTERCOM/CLEAR**.  
•To stop erasing, press **◀** (No).

```
All clear?
◀=No CLEAR=Yes
```

3 Press **HOLD/INTERCOM/CLEAR**.  
•A beep sounds and all entries are erased.

```
All clear
```



You can store up to 30 names and phone numbers in the directory using the handset. All of the directory items are sorted by the first word in alphabetical order. You can make a call by selecting a name on the handset display.

Each handset has the directory list individually.

## Storing Names and Numbers

**Make sure the unit is not being used and the handset is lifted off the base unit.**

1 Press **MUTE/FUNCTION**.

-----  
▶Save directory  
Message play

2 Press **▶** at "Save directory".  
•The display shows the number of stored items in the directory.

Directory  
10 items

3 Enter a name, up to 15 characters with the dialing buttons, (**0** to **9**) (p. 38).

- If a name is not required, press **▼** (Next key) and go to step 5.
- To move the cursor, press **◀** or **▶**.

Enter name  
█  
◀ ▶ ▼=Next

Enter name  
Tom Jones █  
◀ ▶ ▼=Next

4 Press **▼** (Next key).

Enter phone no.

5 Enter a phone number, up to 22 digits.

- Each time you press **HOLD/INTERCOM/CLEAR**, a digit is erased. To erase all of the digits, press and hold **HOLD/INTERCOM/CLEAR**.
- To move the cursor, press **◀** or **▶**.

0987654321 █  
◀ ▶ ▼=Next

6 Press **▼** (Next key).

- If you want to change the name or number, press **▲** (Edit key) to reach the desired display and change it.

Tom Jones  
098-765-4321  
▲=Edit ▶=Save

7 Press **▶** (Save key).

- A beep sounds.
- To continue storing other items, repeat from step 2.
- To exit the programming mode, press **OFF**.

Tom Jones  
098-765-4321

## ➔ Directory

- If a pause is required for dialing, **PAUSE/REDIAL** can be stored in a phone number counting as one digit in step 5.
- You can exit the programming mode any time by pressing **OFF**.
- If the display shows "Directory full" in step 2, the display will return to step 1, press **OFF** to exit the programming mode. To erase other stored items from the directory, see page 41.

### Selecting characters to enter names

The handset dialing buttons (0 to 9) can be used to enter letters and symbols. The letters are printed on the dialing buttons. Pressing each button selects a character as shown below.

Keys	Number of times key is pressed										
	1	2	3	4	5	6	7	8	9	10	11
①	#	&	'	( )	*	,	-	.	/	1	
②	a	b	c	A	B	C	2				
③	d	e	f	D	E	F	3				
④	g	h	i	G	H	I	4				
⑤	j	k	l	J	K	L	5				
⑥	m	n	o	M	N	O	6				
⑦	p	q	r	s	P	Q	R	S	7		
⑧	t	u	v	T	U	V	8				
⑨	w	x	y	z	W	X	Y	Z	9		
⑩	0	Blank									
◀	Moves the cursor to the left.										
▶	Moves the cursor to the right. (To enter another character using the same number key, move the cursor to the next space.)										
<b>HOLD/INTERCOM/CLEAR</b> erases characters.											

**For example, to enter "Tom Jones":**

1. Press **8** four times.
2. Press **6** three times, then press **▶**.
3. Press **6** once, then press **▶** twice.
4. Press **5** four times, press **6** three times, then press **▶**.
5. Press **6** twice, press **3** twice, then press **7** four times.

T
To
Tom
Tom Jo
Tom Jones



### If you make a mistake while entering a name:

Press or to move the cursor to the incorrect character, press **[HOLD/INTERCOM/CLEAR]** to delete and enter the correct character. Each time you press **[HOLD/INTERCOM/CLEAR]** a character is erased. To erase all characters, press and hold **[HOLD/INTERCOM/CLEAR]**.

## Dialing from the Directory

Make sure the unit is not being used and the handset is lifted off the base unit.

- Press or to enter the directory list.
  - The display shows the number of stored items in the directory.

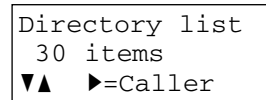

- Scroll to the desired item by pressing or .
  - All directory items are stored in the order shown on the right.

### To search for a name by initial:

- Press the dialing button for the first letter of the desired name until any name with the same initial is displayed (see the Index table below).  
Ex. To find "Frank", press **[3]** repeatedly until the first item under "F" is displayed.

- Press repeatedly until the name is displayed.

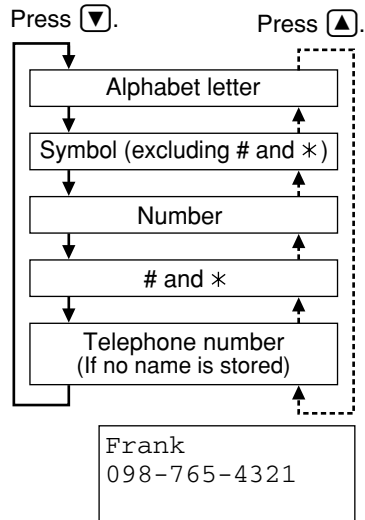

- Press or .
  - The number is dialed automatically.

- If "No items stored" is displayed in step 1, the directory list is empty.
- You can leave the directory list any time by pressing **[OFF]**.
- In step 1, you can go to the Caller List by pressing (p. 31).

### Index table

Keys	Index	Keys	Index
<b>[1]</b>	Other symbols, 1	<b>[6]</b>	M, N, O, 6
<b>[2]</b>	A, B, C, 2	<b>[7]</b>	P, Q, R, S, 7
<b>[3]</b>	D, E, F, 3	<b>[8]</b>	T, U, V, 8
<b>[4]</b>	G, H, I, 4	<b>[9]</b>	W, X, Y, Z, 9
<b>[5]</b>	J, K, L, 5	<b>[0]</b>	0, Blank

## ➔ Directory

### Editing

Make sure the unit is not being used and the handset is lifted off the base unit.

1 Press or to enter the directory list.

2 Scroll to the directory item you want to change by pressing or , and press .

- To search for the item by initial, see page 39.

Jane  
456-7890

Enter name  
Jane  
 ▼=Next

3 Edit the name using the dialing buttons, up to 15 characters.

- To move the cursor, press or .
- If you do not need to change the name, press (Next key) and go to step 5.

Enter name  
Jane Walker  
 ▼=Next

4 Press (Next key).

4567890  
 ▼=Next

5 Add a number to the current number.

- If you do not need to change the number, press (Next key) and go to step 7.
- Each time you press **HOLD/INTERCOM/CLEAR**, a digit is erased. To erase all digits, press and hold **HOLD/INTERCOM/CLEAR**.
- To move the cursor, press or .

12344567890  
 ▼=Next

6 Press (Next key).

- If you want to change the name or number, press (Edit key) to reach the desired display and change it.

Jane Walker  
1-234-456-7890  
▲=Edit =Save

7 When finished, press (Save key).

- A beep sounds.
- To continue editing other items, repeat from step 2.
- To exit the directory list, press **OFF**.

Jane Walker  
1-234-456-7890



- You can exit the edit mode any time by pressing **OFF**.





---

# Erasing

Make sure the unit is not being used and the handset is lifted off the base unit.

1 Press  or  to enter the directory list.

2 Scroll to the directory item that you want to erase by pressing  or .

- To search for the item by initial, see page 39.

Helen 1-234-567-8901
-------------------------

3 Press **HOLD/INTERCOM/CLEAR**.

- To stop erasing, press  (No key).

Clear?
◀=No CLEAR=Yes

4 Press **HOLD/INTERCOM/CLEAR**.

- A beep sounds and the item is erased.
- To erase other items, repeat from step 2.
- To exit the directory list, press **OFF**.

Clear
-------

- You can exit the programming mode any time by pressing **OFF**.

# Intercom

A 2-way intercom is possible between the handset and the base unit or between two handsets. You can call all handsets from the base unit at once.

Page the desired unit(s) by entering the extension number, shown in the top right of each handset's display (p. 10). The base unit's extension number is 0.

## Making Intercom Calls

### Handset

1 Press **HOLD/INTERCOM/CLEAR**.

Press  
handset#[1-3]  
or [0] for base

2 To page the base unit, press **[0]**.  
•The base unit will ring for 1 minute.

Calling [0]



To page another handset,  
press **HOLD/INTERCOM/CLEAR**, and enter  
the extension number using the dialing  
button (**[1]** to **[3]**).

Ex. Calling Handset 2

- The destination handset will ring for 1 minute.
- To stop paging, press **OFF**.

Calling [2]

3 When the paged party answers, talk into the handset.

- You can switch to the speaker by pressing .
- To switch back to the receiver, press .

Intercom

00-00-03 [■■■■]

4 To end the intercom, press **OFF**.

Off

00-00-50 [■■■■]

### Base unit

Using this feature, you can also locate a misplaced handset.

1 To page the handset, enter the extension number, using the **HANDSET LOCATOR/INTERCOM** (**[1]** to **[3]**).

- The IN USE/HOLD indicator flashes.
- The handset will ring for 1 minute.
- To stop paging, press **HANDSET LOCATOR/INTERCOM** (**[ALL]** or **[1]** to **[3]**).

2 When the paged party answers, talk into the **MIC**.

3 To end the intercom, press **HANDSET LOCATOR/INTERCOM** **[ALL]**.

To page all handsets, press **HANDSET LOCATOR/INTERCOM** **[ALL]**.

- All handsets will ring for 1 minute.
- You can only talk with the handset user who answers first.

#### During an intercom call:

- If you have difficulty hearing the other party, decrease the speaker volume by pressing **[▽]** or **[∨]**.
- If an incoming call is being received, you will hear two tones (incoming call tone, p. 48) and the IN USE/HOLD indicator on the base unit will flash quickly. To answer, press **[OFF]** and press **[📞]** or **[📞]**.
- If the handset detects a problem, an error message will be displayed (p. 64).

## Answering Intercom Calls

### Handset

When an intercom call is being received, the handset rings and the display shows the calling extension.

Press **[📞]**, **[📞]** or **[HOLD/INTERCOM/CLEAR]**.

- You can also answer the call by pressing any dialing button **[0]** to **[9]**, **[\*]** or **[#]** (**Any Key Talk**).

To end the intercom, press **[OFF]** or place the handset on the base unit or the charger.

### Auto Talk:

If you set the Auto Talk feature to ON (p. 18), you can answer a call by lifting the handset off the base unit or the charger without pressing **[📞]**, **[📞]** or **[HOLD/INTERCOM/CLEAR]**.

### Base unit

When an intercom call is being received, the base unit rings and the IN USE/HOLD indicator flashes.

Press **HANDSET LOCATOR/INTERCOM** **[ALL]**.

To end the intercom, press **HANDSET LOCATOR/INTERCOM** **[ALL]**.

- When the ringer volume is off (p. 19), the handset will ring at the LOW level for internal calls.
- You cannot change the ringer tone for internal calls.

Ex. Base calling

Call from [0]

Intercom

00-00-03 [■■■■]



# Transferring a Call

You can transfer an external call between two handsets.

## To transfer a call from the handset

- 1 During a call, press **HOLD/INTERCOM/CLEAR**.
  - The IN USE/HOLD indicator flashes and the call is put on hold.

Line on hold.  
Press handset#  
to transfer:1-3
- 2 To page another handset, enter the extension number using the dialing button (1) to (3).

Ex. Calling Handset 2  
Hold  
Calling [2]
- 3 If required, wait for the paged party to answer, and you can announce the transfer. If not required, go to step 4.
  - If the paged party does not answer, press  or  to return to the outside call.



Intercom hold  
◀=Conference  
00-00-05 [■■■■]
- 4 To complete the transfer, press **OFF**.

## To answer from another handset a transferred call:





–If the paging party announces the transfer, the calling extension is displayed. Press ,  or **HOLD/INTERCOM/CLEAR** to answer the page.

Call from [1]

•After the paging party hangs up the call, you can talk to the outside caller.

–If the paging party hangs up before you answer the page, “Incoming call” is displayed. Press  or  to take the transferred call.

Incoming call

- Any users can take a transferred call by pressing  or .
  - If you do not announce the transfer and if the paged party does not answer within 60 seconds after you hang up, the transferred call will be returned to you with ringing. If you still do not answer the caller’s call within 4 minutes, the call will be disconnected. You may answer the caller by pressing  or  before or during the ringing.

# Conference Calls

While you are talking with an outside caller, you can make a conference call with your handset and another handset.

## Ex. A conference call with Handset 1 and 2.

- 1 During a call, press **HOLD/INTERCOM/CLEAR**.
- The IN USE/HOLD indicator flashes and the call is put on hold.

```
Line on hold.  
Press handset#  
to transfer:1-3
```

- 2 To page another handset, enter the extension number using the dialing button (1) to (3).

Ex. Calling Handset 2

```
Hold  
Calling [2]
```

- 3 When the paged party answers, press  (Conference) on your handset to make a conference call.

Ex. Intercom hold with Handset 1

```
Intercom hold  
◀=Conference  
00-00-05 {■■■■}
```

- To leave the conference, press **OFF**. The two other parties can continue the conversation.

```
Conference  
00-00-05 {■■■■}
```

- During a conference, the outside call can be placed on hold by pressing **HOLD/INTERCOM/CLEAR** on the handset. Internal communications between extensions are not suspended. Only the person who placed the call on hold can resume the full conference; press  on the handset.

## Call Share

This feature allows the handset to join the existing external call. A handset user can join another handset user's conversation.

### To join a conversation (Call Share)

Press  or .

```
Conference  
00-00-05 {■■■■}
```

- A maximum of three parties including the outside party can join a conversation if all other extensions are not being used.  
Ex. While the handset is engaged in an external call, another extension can join the conversation. In that event, the 3rd handset cannot join the conversation.

# Special Features

---

## Temporary Tone Dialing (For Rotary or Pulse Service Users)

Press **[\*]** before entering access numbers which require tone dialing.

- The dialing mode changes to tone. You can enter numbers to access an answering service, electronic banking service, etc. When you hang up, the mode will return to pulse.

## Muting Your Conversation

Press **[MUTE/FUNCTION]** while talking.

- The display on the right will be shown.

Ex. **[MUTE/FUNCTION]**  
was pressed.

```
Talk
<Mute> [||||]
```

- The other party cannot hear your voice but you can hear theirs.
- To release the mute, press **[MUTE/FUNCTION]** on the handset.
- When you switch between the receiver and speaker, the mute will be released.

## For Call Waiting Service Users

Press **[FLASH/CALL WAIT]** if you hear a call-waiting tone while talking.

- The first call is put on hold and you can answer the second call.
- To return to the first caller, press **[FLASH/CALL WAIT]** again.
- The call waiting service cannot be used when:
  - the first call is placed on hold,
  - the Answering System is recording someone's message, or
  - a parallel connected telephone is in use.
- If this function does not operate properly, consult your telephone company for details.

## Call Waiting Caller ID Feature

Call Waiting Caller ID Feature allows your handset to display the second caller's information. After you hear a call-waiting tone while talking, the handset will display the caller's name with the phone number and "----Waiting----".

```
BROWN, NANCY
1-555-666-7777
----Waiting----
```

- Please contact your telephone company for details and availability in your area.



## How to Use the PAUSE Button (For PBX Line/Long Distance Calls)

We recommend you press **PAUSE/REDIAL** if a pause is required for dialing with a PBX or to make a long distance call.

Ex. Line access number **9** (PBX)

**9** → **PAUSE/REDIAL** → Phone number

- Pressing **PAUSE/REDIAL** once creates a 3.5 second pause. This prevents misdialing when you redial or dial a stored number.
- Pressing **PAUSE/REDIAL** more than once increases the length of the pause between numbers.

## FLASH Button

Pressing **FLASH/CALL WAIT** allows you to use special features of your host PBX such as transferring an extension call or accessing special telephone services (optional) such as call waiting.

- Pressing **FLASH/CALL WAIT** causes to disable the Temporary Tone Dialing mode or the mute (p. 46).

## Selecting the flash time

The flash time depends on your telephone exchange or host PBX.

You can select the following flash times: “700, 600, 400, 300, 250, 110, 100 or 90 ms (milliseconds)”. Your phone comes from the factory set to “700 ms”.

**Make sure the unit is not being used and the handset is lifted off the base unit.**

**1** Press **MUTE/FUNCTION** and scroll to “Initial set” by pressing **▼** or **▲**, and press **▶**.

**2** Scroll to “Set tel line” by pressing **▼** or **▲**, and press **▶**.

Caller ID edit
▶Set tel line
Set answering

**3** Scroll to “Set flash time” by pressing **▼** or **▲**, and press **▶**.

Set dial mode
▶Set flash time
Set line mode

- The current setting is displayed.

**4** Select the flash time by pressing **▼** or **▲**.

Set flash time
: 700ms
▼▲ ▶=Save

**5** Press **▶** (Save key).

- A beep sounds.
- To exit the programming mode, press **OFF**.

- If the unit is connected via a PBX, PBX functions (transferring a call etc.) might not work correctly. Consult your PBX supplier for the correct setting.

## ➔ Special Features

### Ringer Tone

You can select the handset ringer tone out of 6 patterns for external calls. When an external call is being received, the handset will ring in the selected tone. Your phone comes from the factory set to "1".

**Make sure the unit is not being used and the handset is lifted off the base unit.**

- 1 Press **MUTE/FUNCTION**.
- 2 Scroll to "Ringer setting" by pressing ▼ or ▲, and press ▶.
- 3 Scroll to "Ringer tone" by pressing ▼ or ▲, and press ▶.
  - The current setting will be displayed.
- 4 Select the desired ringer tone by pressing ▼ or ▲.
  - Each time you press ▼ or ▲, the tone will change and ring. If the ringer volume has been set to OFF, the handset will not ring (p. 19).
  - You can also select the ringer tone by pressing dialing buttons 1 to 6.
- 5 Press ▶ (Save key).
  - A beep sounds.
  - To exit the programming mode, press **OFF**.

```
Message play
▶Ringer setting
Date and time
```

```
Ringer volume
▶Ringer tone
Incoming call
```

```
Ringer tone
:1
▼▲ ▶=Save
```

### Incoming Call Tone

During an intercom call (p. 42), or while listening to messages on the handset (p. 52), you can be informed by two tones if a call arrives. If you set to ON, this incoming call tone will be heard for as long as the line rings. To delete the incoming call tone, set to OFF. To set the incoming call tone to sound twice, set to "2". Your phone comes from the factory set to "2".

**Make sure the unit is not being used and the handset is lifted off the base unit.**

- 1 Press **MUTE/FUNCTION** and scroll to "Ringer setting" by pressing ▼ or ▲, and press ▶.
- 2 Scroll to "Incoming call" by pressing ▼ or ▲, and press ▶.
  - The current setting will be displayed.
- 3 Select "On", "Off" or "2" by pressing ▼ or ▲.
- 4 Press ▶ (Save key).
  - A beep sounds.
  - To exit the programming mode, press **OFF**.

```
Message play
▶Ringer setting
Date and time
```

```
Ringer tone
▶Incoming call
-----
```

```
Incoming call
tone :2
▼▲ ▶=Save
```



# Automatic Answering Operation

When the unit answers a call, a greeting message is played and the caller's message is recorded.

- The total recording time (including greeting message) is **about 15 minutes**. If messages are recorded in noisy rooms, the time may be shortened by up to 3 minutes.
- A maximum of 64 messages (including greeting message) can be recorded.

## Setting the Unit to Answer Calls

Press **ANSWER ON** to turn on the Answering System.

- The indicator lights and the unit announces "Answer set" and the current day and time.
- The unit will announce the remaining recording time if it is less than 5 minutes.
- If you hear "Memory full", "**FULL**" is displayed on the base unit and the ANSWER ON indicator flashes rapidly, erase some, or all, of the messages (p. 51).

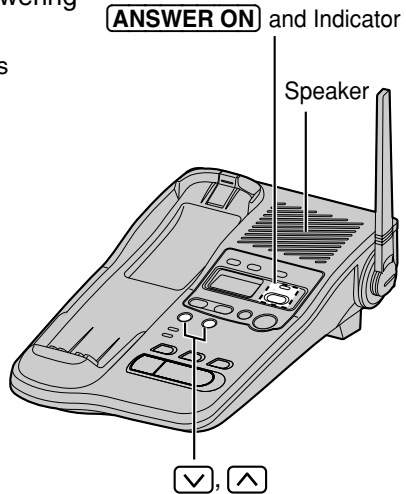

- If you do not want the unit to answer calls, press **ANSWER ON** again to turn off the Answering System. The indicator light goes out and "Answer off" is heard.
- You can also turn on the Answering System remotely using any other phone (p. 57).
- If you turn the Answering System on with "⊖" flashing, "⊖" will disappear but the clock is still incorrect. Adjust the date and time (p. 15). If you subscribe to a Caller ID service (p. 30), the caller ID information will adjust the clock.

## Monitoring incoming calls

While a call is being recorded, you can monitor it through the base unit speaker.

To answer the call with the handset, press or . The unit stops recording.

- To increase the speaker volume, press . To decrease, press .

# Listening to Messages

You can see the total number of recorded messages on the base unit display. If ANSWER ON indicator flashes, new messages have been recorded.

To listen to messages with the handset, see page 52.

## To play back messages

Press **MESSAGE PLAYBACK**.

- The unit announces the number of new messages, and plays back the new messages.
- If old messages exist with new messages, only new messages will be played back.
- When you have no new messages, the unit announces “No new messages. All message playback”, and plays back all messages.

During playback, the display shows the message number.

Ex. 12 messages exist;

12

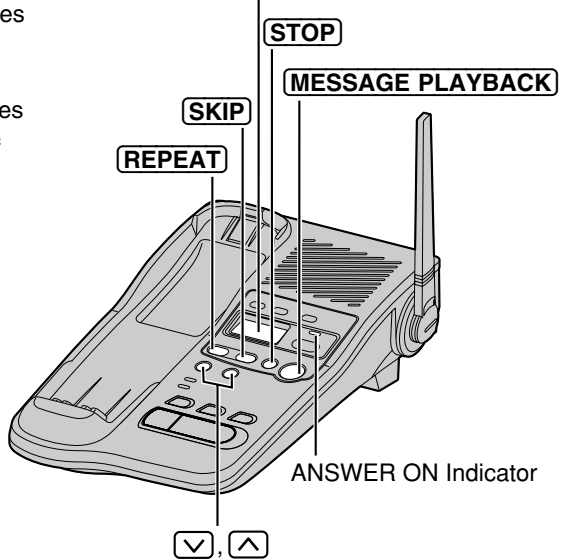

## To adjust the speaker volume:

9 levels (0–8) are available during playback.

To increase the volume, press VOLUME **▲**.

To decrease, press VOLUME **▼**.

- At the end of the last message, “End of final message” is heard. The unit will announce the remaining recording time if it is less than 5 minutes.
- When the Answering System has no messages, the unit announces “No messages”.

## During playback

To <b>repeat</b> message	Press <b>REPEAT</b> . •If you press within 5 seconds of playback, the previous message will be played.
To <b>skip</b> message	Press <b>SKIP</b> .
To <b>stop</b> operation	Press <b>STOP</b> . •To resume playback, press the <b>MESSAGE PLAYBACK</b> . •If you do not press any button for 60 seconds or if you press <b>STOP</b> again, the playback mode will be canceled.

## Erasing Messages

The unit will announce the remaining recording time after playback, if it is less than 5 minutes. New messages cannot be recorded when:

—“Memory full” is heard.

—“**FULL**” is displayed on the base unit.

—the ANSWER ON indicator flashes rapidly (only when the Answering System is on).

Erase some, or all, of the messages. We recommend you erase unnecessary messages after each playback.

### Erasing a specific message

Press **ERASE** while the message you want to erase is being played (p. 50).

- A short beep will sound and the message will be erased.
- The unit will continue to play the next message.

### Erasing all messages

All recorded messages, except the greeting message, can be erased at one time.

**1** Press **ERASE**.  
•“To erase all messages, press ERASE again” is heard.

**2** Within 5 seconds, press **ERASE** again.  
•A beep sounds and “No messages” is heard.  
•The base unit display shows “0”.

- The information in the Caller List will not be erased. To erase Caller List information, see page 36.

# Remote Operation with the Handset

You can access the Answering System from your handset and listen to messages.

If new messages have been recorded, "New message" will be displayed.

Handset off the base unit

```
New message [1]
Received calls▼
{■■■■}
```

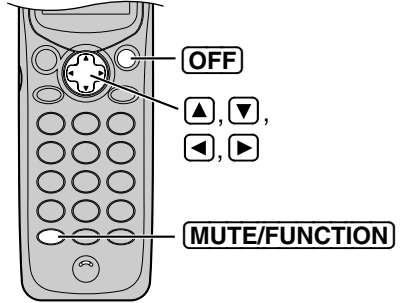

Concerning new message indications on the base unit, see page 50.

## To listen to messages

1 Press **MUTE/FUNCTION**.

2 Scroll to "Message play" by pressing **▼** or **▲**, and press **▶**.

- A beep sounds.
- The number of new messages will be announced from the speaker.

To switch to the receiver, press **☎**.

To switch back to the speaker, press **☎**.

•To play new messages, press **4**.

•You can enter the desired **direct commands** for other functions (p. 53).

•If you do not enter a command, the voice menu will start (see below).

•After the voice menu, all message playback will start.

```
Save directory
▶Message play
Ringer setting
```

```
4:New messages
5:All messages
◀Repeat Skip▶
```

3 To end remote operation, press **OFF**.

•To adjust the speaker or receiver volume, press **▲** to increase and press **▼** to decrease.



•After listening to new messages, "New message" will disappear.

## Voice menu



If no commands are entered after doing steps 1 and 2, or if no commands are entered after you heard new or all messages and "End of final message", the following voice menu will be heard through the handset.

"Press 4 to play back new messages. Press 5 to play back all messages."

•You can enter direct commands even if the voice menu has started.

- The unit will announce the remaining recording time after playback, if it is less than 5 minutes.
- If a call is being received during the remote operation, you will hear incoming call tones (p. 48). To answer the call, press  or .
- If you hear “Memory full” after playback, erase some, or all, of the messages (see below).

## Direct commands

- 4 NEW MESSAGE PLAYBACK**
- Only new messages are played back.
- 5 ALL MESSAGE PLAYBACK**
- All messages are played back.
- 1 REPEAT (During playback)**
- The current message is repeated.
  - If you press within 5 seconds of playback, the previous message will be played.
  - You can also press  to repeat a message.
- 2 SKIP (During playback)**
- The current message is skipped. The next message is played.
  - You can also press  to skip a message.
- 9 STOP**
- Operation is stopped temporarily.
  - To resume operation, enter a direct command within 15 seconds, or the voice menu will start (p. 52).

- \* 4 ERASING A SPECIFIC MESSAGE (During playback)**
- The current message is erased.
  - A short beep will sound and the next message will be played.
- \* 5 ERASING ALL MESSAGES**
- All recorded messages are erased.
  - A long beep sounds, and “No messages” is heard.
- 0 ANSWERING SYSTEM OFF**
- “Answer off” is heard and the Answering System is turned off.
- 8 ANSWERING SYSTEM ON**
- “Answer set” is heard and the Answering System is turned on.

# Remote Operation from a Touch Tone Phone

You can operate the Answering System from any touch tone phone. A synthesized voice menu will guide you on how to operate the unit (p. 56).

- To skip the voice menu and operate the unit directly, see page 57.

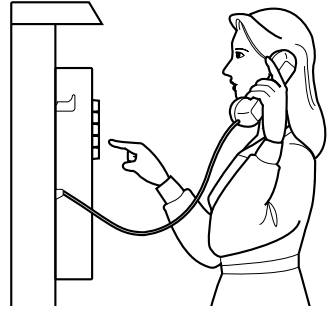

## Summary of remote operation

Call your unit from a touch tone phone.



Enter your remote code (p. 55) during or after the greeting message.

- The number of new messages will be announced and the new messages will be played\*.



After 3 seconds, the voice menu will start (p. 56).  
Follow the menu or enter the direct commands (p. 57).



To end remote operation, hang up.

- The messages are saved.

- The unit will announce the remaining recording time after playback, if it is less than 5 minutes.

\* If “No new messages” is heard, the Answering System has only old messages.  
If “No messages” is heard, the Answering System has no messages.



# Remote Code

The remote code prevents unauthorized people from accessing your unit and listening to your messages. Choose any **2-digit number (00–99)**. The factory preset remote code is “11”. If you do not program your own remote code, you can use “11”.

**Make sure the unit is not being used and the handset is lifted off the base unit.**

1 Press **[MUTE/FUNCTION]**.

2 Scroll to “Initial set” by pressing **[▼]** or **[▲]**, and press **[▶]**.

```
Date and time
▶Initial set
-----
```

3 Scroll to “Set answering” by pressing **[▼]** or **[▲]**, and press **[▶]**.

```
Set tel line
▶Set answering
HS register
```

4 Scroll to “Remote code” by pressing **[▼]** or **[▲]**.

```
Recording time
▶Remote code
-----
```

5 Press **[▶]**.  
•The current setting is displayed.

```
Remote code
:11
▶=Save
```

6 Enter a remote code using a **2-digit number (00–99)**.

```
Remote code
:35
▶=Save
```

7 Press **[▶]** (Save key).  
•A beep sounds.  
•To exit the programming mode, press **[OFF]**.

•You can exit the programming mode any time by pressing **[OFF]**.

## To check the remote code

Repeat steps 1 to 5.

•The remote code is displayed. When finished, press **[OFF]**.

# ➔ Remote Operation from a Touch Tone Phone

## Voice Menu

The shaded parts are voice prompts.

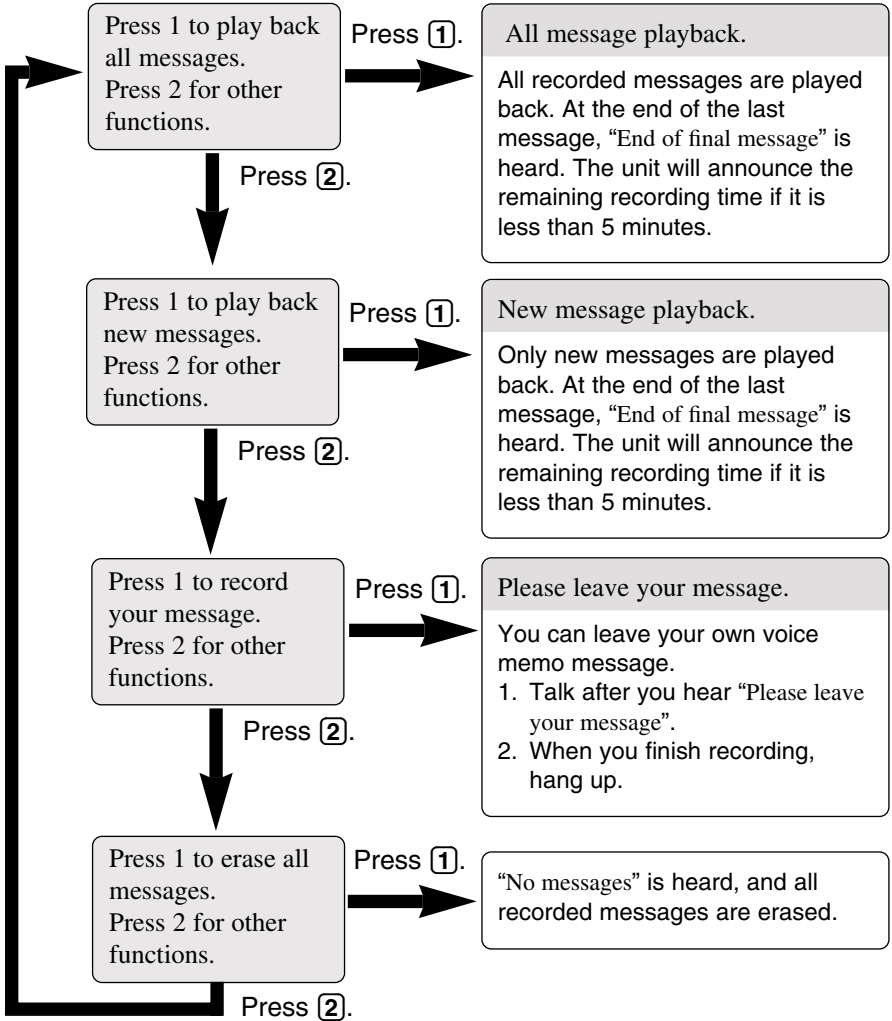

- 3 seconds after playback, the voice menu will start again from the beginning.
- If you hear "Memory full" after playback, erase some, or all, of the messages (p. 57).



---

## Direct Remote Operation

Once you have entered the remote code, you can also control your unit by direct commands instead of using the voice menu. To end the remote operation, hang up anytime.

### Direct commands

**4** NEW MESSAGE PLAYBACK

- Only new messages are played back.

**5** ALL MESSAGE PLAYBACK

- All messages are played back.

**1** REPEAT (During playback)

- The current message is repeated.
- If you press within 5 seconds of playback, the previous message will be played.

**2** SKIP (During playback)

- The current message is skipped. The next message is played.

**9** STOP

- Operation is stopped temporarily.
- To resume operation, enter a direct command within 15 seconds, or the voice menu will start (p. 56).

**\* 4** ERASING A SPECIFIC MESSAGE

(During playback)

- The current message is erased.
- A short beep will sound and the next message will be played.

**\* 5** ERASING ALL MESSAGES

- All recorded messages are erased.
- A long beep sounds, and “No messages” is heard.

**0** ANSWERING SYSTEM OFF

- The unit hangs up and will not answer calls until turned on again (p. 49, 53, see below).

## Turning on the Answering System

Call your unit and wait for 15 rings.

- The unit will answer and the greeting message will be played.
- The Answering System will be turned on. Hang up or enter the remote code for other options.
- When turning on the Answering System using a rotary or pulse service telephone, you cannot enter the remote code for other options.

## Skipping the greeting message

After calling your unit, press **\*** during the greeting message.

- The unit skips the rest of the greeting message and you can start recording your message after the long beep.

# Wall Mounting

## Base unit

This unit can be mounted on a wall phone plate.

- 1 Push the hook and turn it around.  
Turn the hook until a click is heard.

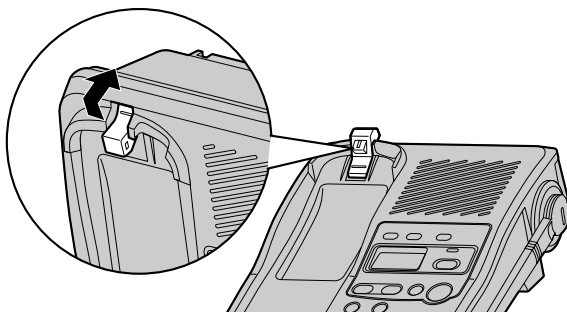

- 2 Press the tabs in the direction of the arrows (①), then remove the wall mounting adaptor (②).

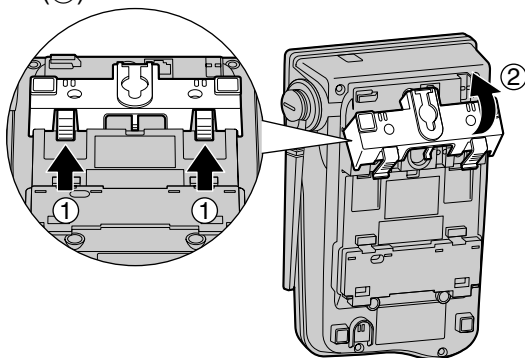

- 3 Connect the AC adaptor. Tuck the telephone line cord inside the wall mounting adaptor, then push it in the direction of the arrow (① and ②).

- The word "UP WALL" should face upward.

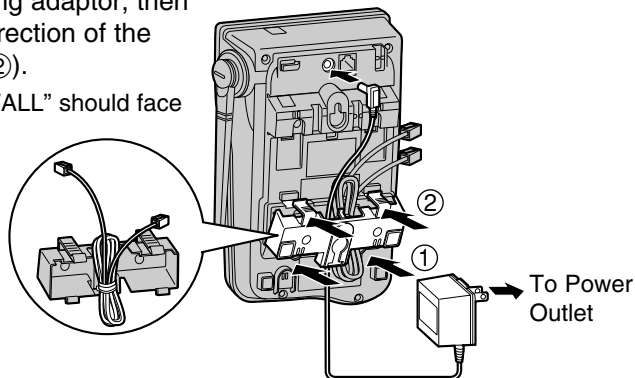



**4** Connect the telephone line cord.  
Mount the unit, then slide down.

- Raise the antenna.

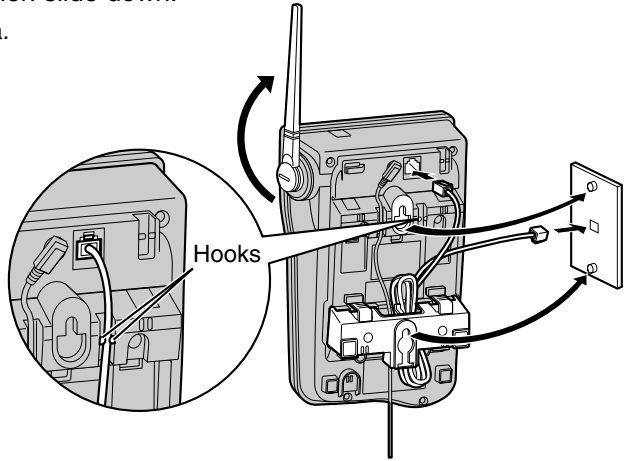

**5** **To charge the handset battery:**  
Fix the charge contacts (1) and insert the hook to the handset hole (2).

- The CHARGE indicator lights.

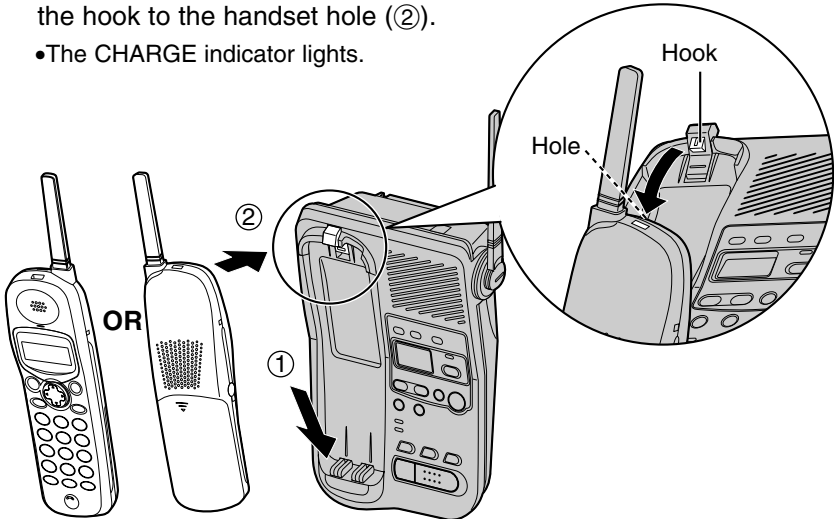

## ➔ Wall Mounting

### Charger unit

The charger can be wall mounted. Connect the AC adaptor. Install screws using the wall template below. Mount the charger (①). Slide it down (②) then slide down to the right (③) until it is secured.

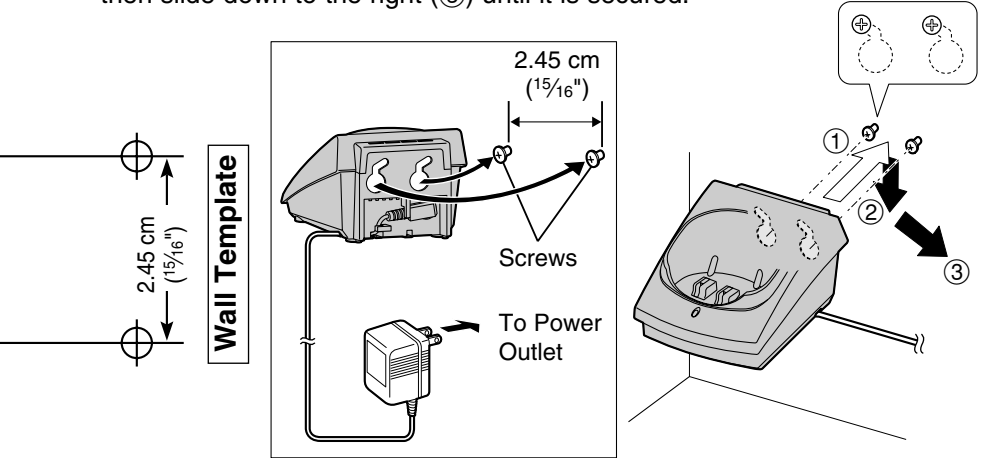

## Adding Another Phone

This unit will not function during a power failure. To connect a standard telephone on the same line, use the Panasonic T-adaptor KX-J66. To order, call the accessories telephone number on page 2.

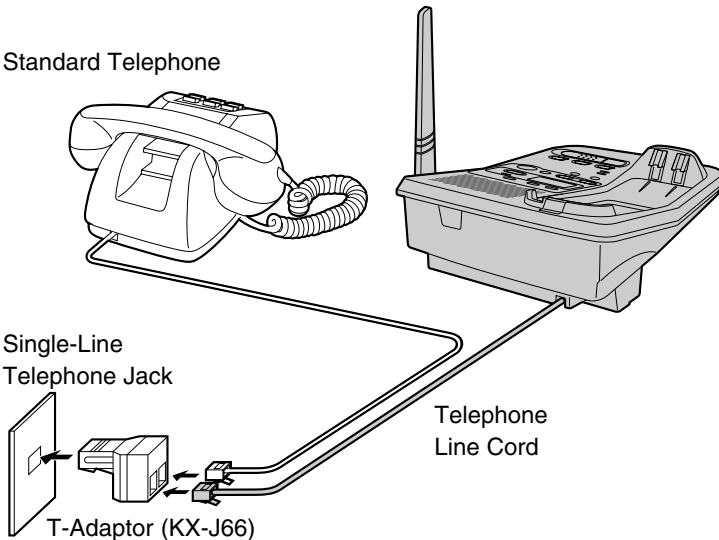

# Battery Replacement

If “Recharge” is displayed and/or “{ ■}” flashes after a few telephone calls even if the battery was fully charged, replace the battery with a new Panasonic N4HHGMB00001 or N4HHGMB00005 (HHR-P103) battery. To order, call the accessories telephone number on page 2.

- 1 Press the notch on the handset cover firmly and slide it as indicated by the arrow.

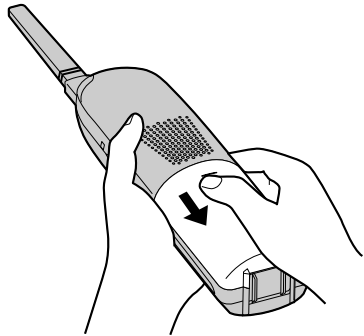

- 2 Remove the old battery and wait for **a few minutes**. And insert the new battery into the handset as shown, matching the correct polarity (①). Press the battery down until it fits securely into the compartment (②).

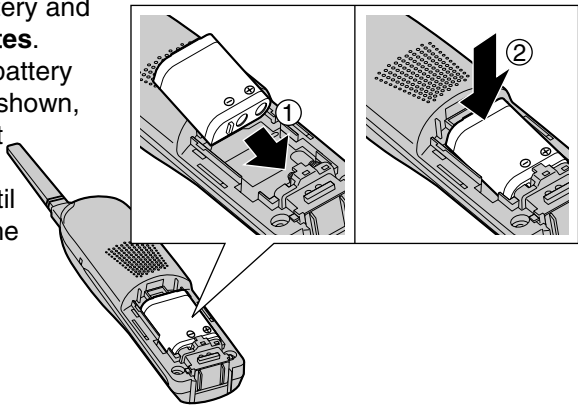

- 3 Close the cover. Make sure the handset display shows “{ ■}”, when you place the handset on the base unit or the charger.
  - If it does not show “{ ■}”, remove the new battery and wait for 10 minutes; and then insert the battery again. Make sure the handset display shows “{ ■}”.
- 4 Charge the new battery for about 15 hours in order to display the battery strength prompt correctly (p. 10, 11).

A nickel metal hydride battery that is recyclable powers the product you have purchased. Please call 1-800-8-BATTERY for information on how to recycle this battery.



# Canceling Registration/Re-registration

## Canceling the Handset Registration

If you no longer need to use the handset or if you need to register the handset to a different base unit of the same model, it may be necessary to cancel the registration.

Only one handset can be canceled at a time near the base unit to which the handset is currently registered.

**Make sure the unit is not being used and the handset is lifted off the base unit.**

1 Press **MUTE/FUNCTION**.

2 Scroll to "Initial set" by pressing **▼** or **▲**, and press **▶**.

```
Date and time
▶Initial set
-----
```

3 Scroll to "HS register" by pressing **▼** or **▲**, and press **▶**.

```
Set answering
▶HS register
-----
```

4 Scroll to "Deregistration" by pressing **▼** or **▲**.

```
Registration
▶Deregistration
-----
```

5 Press **▶**.

```
To deregister
press 3,3,5
:--- ▶=Ok
```

6 Press **335** (DEL.) to delete the registration memory.

```
To deregister
press 3,3,5
:335 ▶=Ok
```

- If you make a mistake, press **HOLD/INTERCOM/CLEAR**, and enter "335".

7 Press **▶** (Ok key).

```
Handset [1]
Deregistered
```

- A beep sounds and the registration memory will be erased on both the handset and the base unit.
- If 3 beeps sound, you entered a wrong code. Enter "335", then press **▶** (Ok key).
- To register the handset to another base unit of the same model, start from step 5 on page 63.

- You can exit the programming mode any time by pressing **OFF**.
- After canceling registration, the handset cannot be used. If you want to use it again, register the handset to the base unit by performing steps 5 and 6 on page 63.

# Re-registering the Handset

If you want to re-register the handset to the base unit or a different base unit of the same model, you need to register it to that base unit. The handset will be given a new extension number of that base unit. Only one handset can be registered at a time. **Make sure the base unit and the other handsets are not being used. Registration must be completed within 1 minute.**

If you have canceled the handset registration at the previous base unit (p. 62), start from step 5.

**1 Handset:** Press **MUTE/FUNCTION**.

**2** Scroll to “Initial set” by pressing **▼** or **▲**, and press **▶**.

Date and time  
▶Initial set  
-----

**3** Scroll to “HS register” by pressing **▼** or **▲**, and press **▶**.

Set answering  
▶HS register  
-----

**4** Press **▶** at “Registration”.

-----  
▶Registration  
Deregistration

**5 Base unit:**  
Press and hold **HANDSET LOCATOR/INTERCOM ALL** until the CHARGE indicator flashes.

Press [ALL] on base for 3 sec, then press [▶].

**6 Handset:**  
① Press **▶**.

Handset  
Registering

② Wait until a long beep sounds and the display shows the registered number. The registration will be then complete.

Ex. Extension number 3

Handset [3]  
Registered

- The registered number “[1]” to “[3]” is shown on the top right of the display.
- You can stop registration by pressing **OFF** on the handset and pressing **HANDSET LOCATOR/INTERCOM ALL** on the base unit.

If you have not canceled the handset registration at the previous base unit (p. 62), the handset number still remains on that base unit memory. Erase the handset number from the previous base unit. For KX-TG2382B/KX-TG2382PW/KX-TG2383B/KX-TG2383S base unit: (1) Press and hold **HANDSET LOCATOR/INTERCOM ALL** until the CHARGE indicator flashes. (2) Press and hold **HANDSET LOCATOR/INTERCOM** (1 to 3) of the handset number that you want to erase until the CHARGE indicator flashes, then rapidly flashes, then goes out.

# If the Following Appear...

---

If the unit detects a problem, one of the following messages will be displayed on the handset. Error beeps or a busy tone will sound.



Display message	Cause & Remedy
Recharge	The battery needs to be charged. Recharge the battery (p. 10, 11).
Charge for 15h	The battery has been discharged. The handset will not work. Charge the battery fully (p. 10, 11).
No link to base Move closer to base, try again	The handset has lost communication with the base unit. Move closer to the base unit, and try again.
Busy	<ul style="list-style-type: none"><li>• The called handset/base unit is in use.</li><li>• The handset you are calling is too far from the base unit.</li><li>• If the radio communication between the handset and the base unit is partially impaired, this display will be shown.</li><li>• If more than one unit is in use, such as conducting an external/internal call or listening to messages, you may not be able to use another unit. Try again later.</li><li>• If the Answering System is responding to a call or another user is listening to messages in the Answering System, you cannot access the Answering System. Try again later.</li><li>• You cannot join the conference call. A maximum of 2 handsets can take part in a conference call.</li><li>• While 2 other handsets are making a conference call, you cannot operate the handset. Try again later.</li></ul>
Error!!	When you tried to register or deregister the handset, the handset and the base unit could not link for some reason, such as interference from other electrical appliances. Take the handset and the base unit away from the electrical appliances and try again.



Display message	Cause & Remedy
Directory full	When trying to store an item in the directory, the directory memory is full. To erase other items from the directory, see page 41.
Please lift up and try again.	A handset button was pressed while the handset was on the base unit or the charger. Lift the handset and press the button again.
Invalid	The called handset has not been registered to the base unit or you selected your extension number.
Invalid. Please register to the base.	The handset you tried to make a call has not been registered to the base unit. Register it (p. 63, steps 5 and 6).
All handsets registered. Maximum is 3.	<ul style="list-style-type: none"> <li>• 3 handsets have already been registered to the base unit. To cancel another handset registration, see page 62.</li> <li>• This base unit has the memory of the handset currently registered to another base unit. Erase the handset memory from the base unit. For KX-TG2382B/KX-TG2382PW/ KX-TG2383B/KX-TG2383S base unit:               <ol style="list-style-type: none"> <li>(1) Press and hold <b>HANDSET LOCATOR/INTERCOM</b> <b>(ALL)</b> until the CHARGE indicator flashes.</li> <li>(2) Press and hold <b>HANDSET LOCATOR/INTERCOM</b> <b>(1)</b> to <b>(3)</b> of the handset number that you want to erase until the CHARGE indicator flashes, then rapidly flashes, then goes out.</li> </ol> </li> </ul>

# Troubleshooting

## Cordless Telephone



Problem	Cause & Remedy
“No link to base Move closer to base, try again” is displayed and an alarm tone sounds.	<ul style="list-style-type: none"><li>•You are too far from the base unit. Move closer to the base unit and try again.</li><li>•Plug in the AC adaptor of the base unit.</li><li>•Raise the base unit antenna.</li></ul>
Static, sound cuts in/out, fades. Interference from other electrical units.	<ul style="list-style-type: none"><li>•Locate the handset and the base unit away from other electrical appliances (p. 6).</li><li>•Move closer to the base unit.</li><li>•Raise the base unit antenna.</li></ul>
The handset does not ring.	<ul style="list-style-type: none"><li>•The ringer volume is OFF. Set to HIGH, MEDIUM or LOW (p. 19).</li><li>•If more than one other user is using the handsets and base unit, the handset may not ring. Those users will hear incoming call tones (p. 48) and the IN USE/HOLD indicator flashes quickly on the base unit.</li></ul>
The handset display is blank.	<ul style="list-style-type: none"><li>•Charge the battery fully (p. 10).</li></ul>
You cannot store a name and phone number in the directory.	<ul style="list-style-type: none"><li>•You cannot store an item in the directory while the handset is in the talk, speakerphone, intercom or remote operation mode.</li><li>•Do not pause for over 60 seconds while storing.</li></ul>
While programming or searching, the handset starts to ring and stops the program/search.	<ul style="list-style-type: none"><li>•To answer the call, press  or . Start again from the beginning after hanging up.</li></ul>
You cannot make an internal/external call with the handset.	<ul style="list-style-type: none"><li>•You cannot make a call when the handset is in the remote operation mode. Exit the mode by pressing <b>OFF</b> (p. 52).</li></ul>



Problem	Cause & Remedy
The unit does not display the caller's name and/or phone number.	<ul style="list-style-type: none"><li>• You need to subscribe to a Caller ID service.</li><li>• Other telephone equipment may be interfering with your phone. Disconnect it and try again.</li><li>• Other electrical appliances connected to the same outlet may be interfering with the Caller ID information.</li><li>• Telephone line noise may be affecting the Caller ID information.</li><li>• The caller requested not to send his/her information. See page 30.</li><li>• If a call is being transferred to you, the caller information will not be displayed.</li></ul>
The handset display exits the Caller List.	<ul style="list-style-type: none"><li>• Do not pause for over 60 seconds while searching.</li></ul>
You cannot page the handset or base unit.	<ul style="list-style-type: none"><li>• The called handset is too far from the base unit.</li><li>• The called unit is in use. Try again later.</li><li>• If more than one other user is using the handsets and base unit, you may not be able to page. Try again later.</li><li>• While 2 other handsets are making a conference call, you cannot page the handset or the base unit. Try again later.</li></ul>
You cannot redial by pressing <b>PAUSE/REDIAL</b> on the handset.	<ul style="list-style-type: none"><li>• If the last number dialed was more than 32 digits long, the number will not be redialed correctly.</li><li>• The button has a double function as either redial or pause. It will redial the last number dialed if pressed at the outset of a call (p. 27). If another number has been dialed first, it will operate as a pause button (p. 47).</li></ul>
You cannot have a conversation or listening to messages using the headset.	<ul style="list-style-type: none"><li>• Make sure that an optional headset is connected properly (p. 12).</li><li>• If "SP-phone" is displayed on the handset, press  to switch to the headset.</li></ul>





## ➔ Troubleshooting

### Answering System

Problem	Cause & Remedy
The Answering System is on, but incoming messages are not recorded.	<ul style="list-style-type: none"><li>•The recording time is set to “Greeting only”. Select “1 minute”, “2 minutes” or “3 minutes” (p. 23).</li><li>•Memory is full. Erase some, or all, of the messages (p. 51).</li></ul>
“ <b>FULL</b> ” is displayed and the ANSWER ON indicator flashes rapidly, and no new messages are recorded.	<ul style="list-style-type: none"><li>•Memory is full. Erase some, or all, of the messages (p. 51).</li></ul>
You cannot access the Answering System from the base unit or the handset.	<ul style="list-style-type: none"><li>•If more than one other user is using the handsets and base unit, you may not be able to access the Answering System. Try again later.</li><li>•If the Answering System is responding to a call or another user is listening to messages in the Answering System, you cannot access the Answering System. Try again later.</li><li>• While 2 other handsets are making a conference call, you cannot access the Answering System. Try again later.</li><li>•Your handset is too far from the base unit. Move closer to the base unit.</li></ul>
You cannot access the Answering System from a touch tone phone.	<ul style="list-style-type: none"><li>•Make sure you enter the correct remote code (p. 55).</li><li>•The Answering System may not respond if the tones are too short to activate the unit. Press each button firmly.</li><li>•The Answering System is off. Turn it on (p. 57).</li></ul>
During playback on the handset, incoming call tones are heard.	<ul style="list-style-type: none"><li>•To answer the call, press  or . For playback, start again from the beginning after hanging up.</li></ul>
When you play back messages or you turn the Answering System on, the unit announces the wrong day.	<ul style="list-style-type: none"><li>•The date may be set wrong. Adjust the date (p. 15).</li></ul>



## General

Problem	Cause & Remedy
The unit does not work.	<ul style="list-style-type: none"><li>•Check the settings (p. 9–11).</li><li>•Check whether the dialing mode setting is correct (p. 16).</li><li>•Charge the battery fully (p. 10).</li><li>•Clean the charge contacts and charge again (p. 11).</li><li>•Install the battery properly (p. 10).</li><li>•Unplug the AC adaptor of the base unit to reset. Plug in, and try again.</li><li>•The handset has not been registered to the base unit. Register the handset (p. 63, steps 5 and 6).</li><li>•Re-install the battery (p. 61) and charge it fully.</li><li>•After you register an additional handset to the base unit, please confirm that the other (first one and second one) pre-registered handsets display “Talk” by pressing . If one of the handsets does not display “Talk”, re-register that handset to the base unit.</li></ul>
You cannot program items, such as the dialing mode.	<ul style="list-style-type: none"><li>•Programming is not possible while the handset is being used.</li><li>•Do not pause for over 60 seconds while programming.</li><li>•Move closer to the base unit.</li><li>•, ,  or  may have been pressed when you picked up the handset. Press <b>OFF</b> and try again.</li><li>•If more than one other user is using the handsets, you may not be able to program. Try again later.</li></ul>

## ➔ Troubleshooting

Problem	Cause & Remedy
<p>You cannot register the handset at the base unit.</p>	<ul style="list-style-type: none"> <li>•Charge the battery fully (p. 10).</li> <li>•The maximum of 3 handsets have already been registered to the base unit.</li> <li>•This base unit has the memory of the handset currently registered to another base unit. Erase the handset memory from the base unit. For KX-TG2382B/KX-TG2382PW/ KX-TG2383B/KX-TG2383S base unit:               <ol style="list-style-type: none"> <li>(1) Press and hold <b>HANDSET LOCATOR/INTERCOM</b> <b>(ALL)</b> until the CHARGE indicator flashes.</li> <li>(2) Press and hold <b>HANDSET LOCATOR/INTERCOM</b> <b>(1)</b> to <b>(3)</b> of the handset number that you want to erase until the CHARGE indicator flashes, then rapidly flashes, then goes out.</li> </ol> </li> </ul>
<p>“Recharge” is displayed, “[ ■ ]” flashes or the handset beeps intermittently.</p>	<ul style="list-style-type: none"> <li>•Charge the battery fully (p. 10, 11).</li> </ul>
<p>“Charge for 15h” is displayed and the handset does not work.</p>	<ul style="list-style-type: none"> <li>•The battery has been discharged. Charge the battery fully (p. 10, 11).</li> </ul>
<p>You charged the battery fully, but “Recharge” is still displayed and/or “[ ■ ]” continues to flash, or “Charge for 15h” is displayed.</p>	<ul style="list-style-type: none"> <li>•Clean the charge contacts and charge again (p. 11).</li> <li>•Install a new battery (p. 61).</li> </ul>
<p>The CHARGE indicator light does not go out after the battery has been charged.</p>	<ul style="list-style-type: none"> <li>•This is normal.</li> </ul>
<p>If you cannot solve your problem</p>	<ul style="list-style-type: none"> <li>•Call our customer call center at 1-800-211-PANA(7262).</li> <li>•Panasonic’s e-mail address for customer inquiries: <a href="mailto:consumerproducts@panasonic.com">consumerproducts@panasonic.com</a> for customers in the USA or Puerto Rico ONLY</li> </ul>

# Important Safety Instructions



When using this unit, basic safety precautions should always be followed to reduce the risk of fire, electric shock, or personal injury.

1. Read and understand all instructions.
2. Follow all warnings and instructions marked on this unit.
3. Unplug this unit from AC outlets before cleaning. Do not use liquid or aerosol cleaners. Use a damp cloth for cleaning.
4. Do not use this unit near water, for example, near a bathtub, washbowl, kitchen sink, or the like.
5. Place this unit securely on a stable surface. Serious damage and/or injury may result if the unit falls.
6. Do not cover slots and openings on the unit. They are provided for ventilation and protection against overheating. Never place the unit near radiators, or in a place where proper ventilation is not provided.
7. Use only the power source marked on the unit. If you are not sure of the type of power supplied to your home, consult your dealer or local power company.
8. Do not place objects on the power cord. Install the unit where no one can step or trip on the cord.
9. Do not overload wall outlets and extension cords. This can result in the risk of fire or electric shock.
10. Never push any objects through slots in this unit. This may result in the risk of fire or electric shock. Never spill any liquid on the unit.
11. To reduce the risk of electric shock, do not disassemble this unit. Take the unit to an authorized servicer when service is required. Opening or removing covers may expose you to dangerous voltages or other risks. Incorrect reassembly can cause electric shock when the unit is subsequently used.
12. Unplug this unit from the wall outlet and refer servicing to an authorized servicer when the following conditions occur:
  - A. When the power supply cord or plug is damaged or frayed.
  - B. If liquid has been spilled into the unit.
  - C. If the unit has been exposed to rain or water.
  - D. If the unit does not work normally by following the operating instructions. Adjust only controls covered by the operating instructions. Improper adjustment may require extensive work by an authorized servicer.
  - E. If the unit has been dropped or physically damaged.
  - F. If the unit exhibits a distinct change in performance.
13. During thunderstorms, avoid using telephones except cordless types. There may be a remote risk of an electric shock from lightning.
14. Do not use this unit to report a gas leak, when in the vicinity of the leak.

## SAVE THESE INSTRUCTIONS

For assistance, please call: 1-800-211-PANA(7262)

## Important Safety Instructions

---

### **CAUTION:**

To reduce the risk of fire or injury to persons, read and follow these instructions.

1. Use only the battery(ies) specified.
2. Do not dispose of the battery(ies) in a fire. They may explode. Check with local waste management codes for special disposal instructions.
3. Do not open or mutilate the battery(ies). Released electrolyte is corrosive and may cause burns or injury to the eyes or skin. The electrolyte may be toxic if swallowed.
4. Exercise care in handling batteries in order not to short the battery to conductive materials such as rings, bracelets, and keys. The battery and/or conductor may overheat and cause burns.
5. Charge the battery(ies) provided with or identified for use with this product only in accordance with the instructions and limitations specified in this manual.

### **WARNING:**

**TO PREVENT FIRE OR SHOCK HAZARD, DO NOT EXPOSE THIS PRODUCT TO RAIN OR ANY TYPE OF MOISTURE.**

- The AC adaptor is used as the main disconnect device, ensure that the AC outlet is located/installed near the unit and is easily accessible.

## **FCC and Other Information**

---

This equipment complies with Part 68 of the FCC rules and the requirements adopted by the ACTA. On the bottom of this equipment is a label that contains, among other information, a product identifier in the format US:ACJ-----.

If requested, this number must be provided to the telephone company.

Registration No. ....(found on the bottom of the unit)

Ringer Equivalence No. (REN).....0.1B

A plug and jack used to connect this equipment to the premises wiring and telephone network must comply with the applicable FCC Part 68 rules and requirements adopted by the ACTA. A compliant telephone cord and modular plug is provided with this product. It is designed to be connected to a compatible modular jack that is also compliant.

The REN is used to determine the number of devices that may be connected to a telephone line. Excessive RENs on a telephone line may result in the devices not ringing in response to an incoming call. In most but not all areas, the sum of RENs should not exceed five (5.0). To be certain of the number of devices that may be connected to a line, as determined by the total RENs, contact the local telephone company. For products approved after July 23, 2001, the REN for this product is part of the product identifier that has the format US:AAAEQ##TXXXX. The digits represented by ## are the REN without a decimal point (e.g., 03 is a REN of 0.3).





If this equipment causes harm to the telephone network, the telephone company will notify you in advance that temporary discontinuance of service may be required. But if advance notice isn't practical, the telephone company will notify the customer as soon as possible. Also, you will be advised of your right to file a complaint with the FCC if you believe it is necessary.

The telephone company may make changes in its facilities, equipment, operations or procedures that could affect the operation of the equipment. If this happens the telephone company will provide advance notice in order for you to make necessary modifications to maintain uninterrupted service.

If trouble is experienced with this equipment, for repair or warranty information, please contact a Factory Servicenter or other Authorized Servicer. If the equipment is causing harm to the telephone network, the telephone company may request that you disconnect the equipment until the problem is resolved.

Connection to party line service is subject to state tariffs. Contact the state public utility commission, public service commission or corporation commission for information.

If your home has specially wired alarm equipment connected to the telephone line, ensure the installation of this equipment does not disable your alarm equipment. If you have questions about what will disable alarm equipment, consult your telephone company or a qualified installer.

#### **WHEN PROGRAMMING EMERGENCY NUMBERS AND(OR) MAKING TEST CALLS TO EMERGENCY NUMBERS:**

- 1) Remain on the line and briefly explain to the dispatcher the reason for the call.
- 2) Perform such activities in the off-peak hours, such as early morning or late evenings.

This device complies with Part 15 of the FCC Rules. Operation is subject to the following two conditions: (1) This device may not cause harmful interference, and (2) this device must accept any interference received, including interference that may cause undesired operation.

Privacy of communications may not be ensured when using this phone.

#### **CAUTION:**

Any changes or modifications not expressly approved by the party responsible for compliance could void the user's authority to operate this device.

#### **Note:**

This equipment has been tested and found to comply with the limits for a Class B digital device, pursuant to Part 15 of the FCC Rules. These limits are designed to provide reasonable protection against harmful interference in a residential installation. This equipment generates, uses, and can radiate radio frequency energy and, if not installed and used in accordance with the instructions, may cause harmful interference to radio communications. However, there is no guarantee that interference will not occur in a particular installation. If this equipment does cause harmful interference to radio or television reception, which can be determined by turning the equipment off and on, the user is encouraged to try to correct the interference by one or more of the following measures:

- Reorient or relocate the receiving antenna.
- Increase the separation between the equipment and receiver.
- Connect the equipment into an outlet on a circuit different from that to which the receiver is connected.
- Consult the dealer or an experienced radio/TV technician for help.

## ➡ FCC and Other Information

---

Some cordless telephones operate at frequencies that may cause interference to nearby TVs and VCRs. To minimize or prevent such interference, the base of the cordless telephone should not be placed near or on top of a TV or VCR. If interference is experienced, move the cordless telephone further away from the TV or VCR. This will often reduce, or eliminate, interference.

Operating near 2.4GHz electrical appliances may cause interference. Move away from the electrical appliances.

### **CAUTION:**

To comply with FCC RF exposure requirements, the base unit should be installed with its antenna located at 20 cm or more from persons and handset should be carried with the specific belt-clip provided for the handset to ensure compliance. Other non-tested belt-clips or similar body-worn accessories may not comply, therefore, should be avoided.

This equipment is hearing aid compatible as defined by the FCC in 47 CFR Section 68.316.

When you hold the phone to your ear, noise might be heard in your Hearing Aid. Some Hearing Aids are not adequately shielded from external RF (radio frequency) energy. If noise occurs, use an optional headset accessory or the speakerphone option (if applicable) when using this phone. Consult with your audiologist or Hearing Aid manufacturer about the availability of Hearing Aids which provide adequate shielding to RF energy commonly emitted by digital devices.

- **Environment** — do not place the unit in a room where the temperature is less than 5°C (41°F) or greater than 40°C (104°F). Allow 10 cm (4") clearance around the unit for proper ventilation. Avoid excessive smoke, dust, mechanical vibration, shock, or direct sunlight.
- **Medical** — consult the manufacturer of any personal medical devices, such as pacemakers or hearing aids, to determine if they are adequately shielded from external RF (radio frequency) energy. (The unit operates in the frequency range of 2400MHz to 2480MHz, and the power output level can range 0.04 watts to 0.40 watts.) Do not use the unit in health care facilities if any regulations posted in the area instruct you not to do so. Hospitals or health care facilities may be using equipment that could be sensitive to external RF (radio frequency) energy.
- **Routine care** — wipe the unit with a soft cloth. Do not use benzine, thinner, or any abrasive powder. When you leave the unit unused for a long period of time, unplug the AC adaptor from the outlet.
- **If there is any trouble** — disconnect the unit from the telephone line and connect a known working phone. If the known working phone operates properly, have your unit repaired by a Factory Servicenter or other Authorized Servicer. If the known working phone does not operate properly, consult your telephone company.



<b>A</b>		<b>H</b>	
Accessories .....	2	Headset, optional .....	12
Answering Calls .....	29	Hold .....	28
Answering System .....	49	<b>I</b>	
Auto Talk Feature .....	18, 29, 43	Incoming Call Tone .....	48
<b>B</b>		Installation, AC Adaptor .....	9
Backlit LCD display .....	28	Installation, Adding Another Phone... 60	
Base Unit Location .....	6	Installation, Battery .....	10
Battery Charge .....	6, 10	Installation, Telephone Line Cord .....	9
Battery information .....	11	Intercom call .....	42, 43
Battery Replacement .....	61	Intercom paging .....	42, 43
Battery strength .....	11	<b>L</b>	
Belt Clip .....	12	LCD Contrast .....	20
<b>C</b>		Lighted handset keypad .....	28
Call monitor .....	49	Line Mode .....	17
Call Waiting Caller ID .....	46	Listening to Messages .....	50, 52, 54
Call Waiting Tone .....	46	Location of Controls .....	7, 8
Caller ID Number Auto Edit Feature ... 33, 34		<b>M</b>	
Caller ID service .....	16, 29, 30	Making Calls .....	25, 26
Caller List, editing .....	33	Message storage .....	22
Caller List, erasing .....	36	Microphone, Base unit .....	21, 42
Caller List, storing .....	35	Microphone, Handset .....	26
Caller List, viewing .....	31	Monitoring incoming calls .....	49
Calling Back from the Caller List .....	32	MUTE .....	46
Conference calls .....	45	<b>N</b>	
<b>D</b>		Navigator key .....	8
Date and time .....	15	Noise .....	6
Deregistration .....	62	<b>P</b>	
Dialing Mode .....	16	PAUSE .....	47
Directory .....	37	Power failure .....	15, 22, 60
Directory, dialing .....	39	Pulse service .....	46
Directory, editing .....	40	<b>R</b>	
Directory, erasing .....	41	Recording Time .....	23
Directory, names .....	38	Redial .....	27
Directory, storing .....	37	Redial list .....	27
Display .....	64	Registration .....	63
<b>E</b>		Registration, Canceling .....	62
Erasing a message .....	51	Remote Code .....	55
Erasing all messages .....	51	Remote Operation, Handset .....	52
Extension number .....	42, 63	Remote Operation, Touch Tone Phone .. 54	
<b>F</b>		Ringer Off .....	19
FCC and Other Information .....	72	Ringer Tone .....	48
FLASH Button .....	47	Ringer Volume .....	19
Flash time .....	47	Rotary service, Tone dialing .....	46
Function Menu Table .....	14		
<b>G</b>			
Greeting Message .....	21		

# Index

---

<b>S</b>		
Safety Instructions .....	71	
Shipping product for service .....		
.....Back cover		
Specifications .....	79	
SP-phone .....	26	
<b>T</b>		
Toll saver .....	24	
Transferring a Call .....	44	
Troubleshooting, Answering System ....	68	
Troubleshooting, Cordless Telephone ..	66	
		Troubleshooting, General .....
		69
		<b>V</b>
		Voice menu .....
		52, 56
		Volume control, Base Unit .....
		22, 50
		Volume control, Handset.....
		28
		<b>W</b>
		Wall Mounting .....
		58
		Warranty.....
		77

**PANASONIC CONSUMER  
ELECTRONICS COMPANY, DIVISION  
OF MATSUSHITA ELECTRIC  
CORPORATION OF AMERICA**  
One Panasonic Way  
Secaucus, New Jersey 07094

**PANASONIC SALES COMPANY,  
DIVISION OF MATSUSHITA  
ELECTRIC OF PUERTO RICO, INC.,**  
Ave. 65 de Infanteria, Km. 9.5  
San Gabriel Industrial Park  
Carolina, Puerto Rico 00985

## **Panasonic Telephone Products Limited Warranty**

### **Limited Warranty Coverage**

If your product does not work properly because of a defect in materials or workmanship, Panasonic Consumer Electronics Company or Panasonic Sales Company (collectively referred to as "the warrantor") will, for the length of the period indicated on the chart below, which starts with the date of original purchase ("warranty period"), at its option either (a) repair your product with new or refurbished parts, or (b) replace it with a new or a refurbished product. The decision to repair or replace will be made by the warrantor.

<b>Parts</b>	<b>Labor</b>
<b>One (1) Year</b>	<b>One (1) Year</b>

During the "Labor" warranty period there will be no charge for labor. During the "Parts" warranty period, there will be no charge for parts. You must mail-in your product during the warranty period. This Limited Warranty excludes both parts and labor for batteries, antennas, and cosmetic parts (cabinet). This warranty only applies to products purchased and serviced in the United States or Puerto Rico. This warranty is extended only to the original purchaser of a new product which was not sold "as is".

### **Mail-In Service**

For assistance in the continental U.S.A. in obtaining repairs please ship the product to:

**Panasonic Services Company  
Customer Servicerter  
Suite B  
4900 George McVay Drive  
McAllen, TX 78503**

For assistance in Puerto Rico call Panasonic Sales Company (787)-750-4300 or fax (787)-768-2910.

When shipping the unit carefully pack and send it prepaid, adequately insured and preferably in the original carton. Include a letter detailing the complaint and provide a day time phone number where you can be reached.

**IF REPAIR IS NEEDED DURING THE WARRANTY PERIOD THE PURCHASER WILL BE REQUIRED TO FURNISH A SALES RECEIPT/PROOF OF PURCHASE INDICATING DATE OF PURCHASE, AMOUNT PAID AND PLACE OF PURCHASE. CUSTOMER WILL BE CHARGED FOR THE REPAIR OF ANY UNIT RECEIVED WITHOUT SUCH PROOF OF PURCHASE.**

### **Limited Warranty Limits And Exclusions**

This warranty ONLY COVERS failures due to defects in materials or workmanship, and DOES NOT COVER normal wear and tear or cosmetic damage. The warranty ALSO DOES NOT COVER damages which occurred in shipment, or failures which are caused by products not supplied by the warrantor, or failures which result from accidents, misuse, abuse, neglect, mishandling, misapplication, alteration, faulty installation, set-up adjustments, misadjustment of consumer controls, improper maintenance, power line surge, lightning damage, modification, introduction of sand, humidity or liquids, commercial use such as hotel, office, restaurant, or other business or rental use of the product, or service by anyone other than a Factory Servicerter or other Authorized Servicer, or damage that is attributable to acts of God.

**THERE ARE NO EXPRESS WARRANTIES EXCEPT AS LISTED UNDER "LIMITED WARRANTY COVERAGE". THE WARRANTOR IS NOT LIABLE FOR INCIDENTAL OR CONSEQUENTIAL DAMAGES RESULTING FROM THE USE OF THIS PRODUCT, OR ARISING OUT OF ANY BREACH OF THIS WARRANTY. (As examples, this excludes damages for lost time, lost calls or messages, cost of having someone remove or re-install an installed unit if applicable, travel to and from the servicer. The items listed are not exclusive, but are for illustration only.) ALL EXPRESS AND IMPLIED WARRANTIES, INCLUDING THE WARRANTY OF MERCHANTABILITY, ARE LIMITED TO THE PERIOD OF THE LIMITED WARRANTY.**

Some states do not allow the exclusion or limitation of incidental or consequential damages, or limitations on how long an implied warranty lasts, so the exclusions may not apply to you.

This warranty gives you specific legal rights and you may also have other rights which vary from state to state. If a problem with this product develops during or after the warranty period, you may contact your dealer or Servicenter. If the problem is not handled to your satisfaction, then write to the warrantor's Consumer Affairs Department at the addresses listed for the warrantor.

**PARTS AND SERVICE, WHICH ARE NOT COVERED BY THIS LIMITED WARRANTY, ARE YOUR RESPONSIBILITY.**

## ***Customer Services Directory***

***For Product Information, Operating Assistance, Literature Request, Dealer Locations, and all Customer Service inquiries please contact: 1-800-211-PANA (7262), Monday-Friday 9 am-9 pm; Saturday-Sunday 10 am-7 pm, EST.***

***or send e-mail :***

***consumerproducts@panasonic.com***

***For hearing or speech impaired TTY users, TTY : 1-877-833-8855***

***Web Site: <http://www.panasonic.com>***

***You can purchase parts, accessories or locate your nearest servicenter by visiting our Web Site.***

### ***Accessory Purchases:***

**1-800-332-5368 (Customer Orders Only)**

**For hearing or speech impaired TTY users, TTY : 1-866-605-1277**

**Panasonic Services Company 20421 84th Avenue South, Kent, WA 98032**

**(6 am to 5 pm Monday - Friday; 6 am to 10:30 am Saturday; PST)**

**(Visa, MasterCard, Discover Card, American Express, Check)**

### ***Service in Puerto Rico***

***Matsushita Electric of Puerto Rico, Inc. Panasonic Sales Company/  
Factory Servicenter:***

***Ave. 65 de Infantería, Km. 9.5, San Gabriel Industrial Park,  
Carolina, Puerto Rico 00985***

***Phone (787)750-4300 Fax (787)768-2910***

# Specifications

---

## ■ Base unit

- Power Supply:** AC Adaptor (120 V AC, 60 Hz)  
**Power Consumption:** Standby: Approx. 3.2 W  
Maximum: Approx. 6 W  
**Frequency:** 2.40 GHz – 2.48 GHz  
**Dimensions (H x W x D):** Approx. 84 mm x 145 mm x 215 mm  
(3 <sup>5</sup>/<sub>16</sub>" x 5 <sup>23</sup>/<sub>32</sub>" x 8 <sup>15</sup>/<sub>32</sub>" )  
**Mass (Weight):** Approx. 440 g ( 0.97 lb.)

## ■ Charger

- Power Supply:** AC Adaptor (120 V AC, 60 Hz)  
**Power Consumption:** Standby: Approx. 0.8 W  
Maximum: Approx. 2.0 W  
**Dimensions (H x W x D):** Approx. 60 mm x 74 mm x 98 mm  
(2 <sup>11</sup>/<sub>32</sub>" x 2 <sup>29</sup>/<sub>32</sub>" x 3 <sup>7</sup>/<sub>8</sub>" )  
**Mass (Weight):** Approx. 100 g ( 0.22 lb.)

## ■ Handset

- Power Supply:** Ni-MH battery (3.6 V, 650 mAh)  
**Frequency:** 2.40 GHz – 2.48 GHz  
**Dimensions (H x W x D):** Approx. 237 mm x 52 mm x 38 mm  
(9 <sup>11</sup>/<sub>32</sub>" x 2 <sup>1</sup>/<sub>16</sub>" x 1 <sup>1</sup>/<sub>2</sub>" )  
**Mass (Weight):** Approx. 180 g (0.4 lb.)  
**Security Codes:** 1,000,000

■ **Dialing Mode:** Tone (DTMF)/Pulse

■ **Operating Environment:** 5 °C – 40 °C (41 °F – 104 °F)

Specifications are subject to change without notice.

## Energy Star:

As an ENERGY STAR® Partner, Panasonic has determined that this product meets the ENERGY STAR guidelines for energy efficiency. ENERGY STAR is a U.S. registered mark.



## For product service

- Call 1-800-211-PANA(7262) for the location of an authorized servicer.
- Panasonic's e-mail address for customer inquiries:  
consumerproducts@panasonic.com  
for customers in the USA or Puerto Rico ONLY

## When you ship the product

- Carefully pack your unit, preferably in the original carton.
- Attach a letter, detailing the symptom, to the outside of the carton.

Symptom

---

- Send the unit to an authorized servicer, prepaid and adequately insured.
- Do not send your unit to the Panasonic Consumer Electronics Company listed below or to executive or regional sales offices. These locations do not repair consumer products.

## For your future reference

Serial No.

(found on the bottom of the unit)

Date of purchase

---

Name and address of dealer

---

- This cordless telephone is designed for use in the United States of America. Sale or use of this product in other countries may violate local laws.
- Ce téléphone sans fil est conçu pour être utilisé aux États-Unis d'Amérique. La vente ou l'emploi de cet appareil dans certains autres pays peut constituer une infraction à la législation locale.
- Este teléfono sin cordón fue elaborado para uso en los Estados Unidos de América. La venta o el empleo de este producto en ciertos países puede constituir violación de la legislación local.
- このコードレス電話機は、日本国外での使用を目的として設計されており、日本国内での使用は法律違反となります。従って、当社では日本国内においては原則として修理などのサービスは致しかねます。

**If you need assistance with the set-up or operation,  
please call 1-800-211-PANA(7262)**

**Panasonic Consumer Electronics Company,  
Division of Matsushita Electric Corporation of America**  
One Panasonic Way, Secaucus, New Jersey 07094

**Panasonic Sales Company,  
Division of Matsushita Electric of Puerto Rico, Inc.**  
Ave. 65 de Infantería, Km. 9.5, San Gabriel Industrial Park  
Carolina, Puerto Rico 00985