

# Panasonic

2.4GHz Cordless Answering System

Model No. **KX-TG2680N**

Pulse-or-tone dialing capability

## Operating Instructions



Caller ID Compatible

**PLEASE READ BEFORE USE AND SAVE.**

**Charge the battery for about 8 hours before initial use.**

Panasonic World Wide Web address: <http://www.panasonic.com>  
for customers in the USA or Puerto Rico

Preparation

Cordless Telephone

Answering System

Useful Information

# Before Initial Use

Please read **IMPORTANT SAFETY INSTRUCTIONS** on page 92 before use.  
Read and understand all instructions.

**Thank you for purchasing your new Panasonic cordless telephone.**

Caller ID and Call Waiting Service, where available, are telephone company services. After subscribing to Caller ID, this phone will display a caller's name and phone number, then announce the displayed caller's name. Name and telephone number Caller ID service is required for the Talking Caller ID feature. Call Waiting Caller ID, which displays a second caller's name and phone number while the user is on another call, requires a subscription to both Caller ID and Call Waiting.

Attach your purchase receipt here.

## For your future reference

Serial No. \_\_\_\_\_  
(found on the bottom of the unit)

Date of purchase \_\_\_\_\_

Name and address of dealer \_\_\_\_\_

## Accessories (included) For extra orders, call 1-800-332-5368.

- AC Adaptor (p. 10)  
Order No. PQWATG2650N

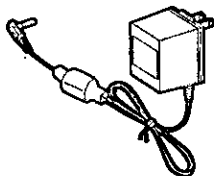

one

- Telephone Line Cord (p. 10)

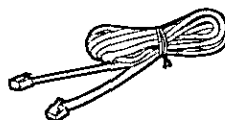

one

- Wall Mounting Adaptor (p. 76)  
Order No. PQKL10038Z1

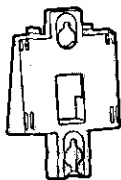

one

- Belt Clip (p. 77)  
Order No. PQKE10109Z1



one

# For Best Performance

## Battery Charge

A rechargeable Nickel-Metal Hydride (Ni-MH) battery powers the handset. Charge the battery for about **8 hours** before initial use (p. 11).

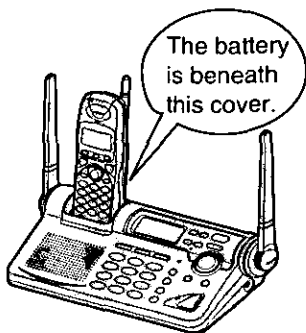

## Base Unit Location/Noise

Calls are transmitted between the base unit and the handset using wireless radio waves. **For maximum distance and noise-free operation**, the recommended base unit location is:

Away from electrical appliances such as a TV, personal computer or another cordless phone.

In a **HIGH** and **CENTRAL** location with no obstructions such as walls.

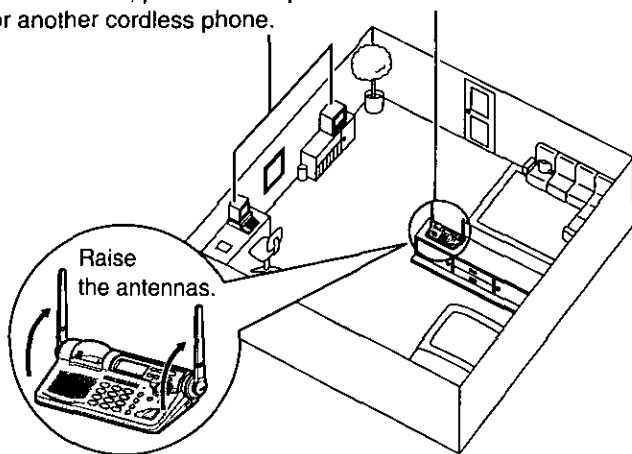

For best performance, extend the handset antenna fully.

- If the antenna is only extended half-way, better operating range is not available.

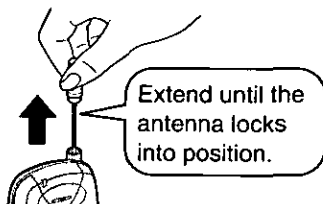

### Note:

While using the handset:

- If you are near a microwave oven which is being used, noise may be heard from the receiver or the speaker. Move away from the microwave oven and closer to the base unit.
- If more than one cordless phone is being used and your handset is near another cordless phone's base unit, noise may be heard. Move away from the other cordless phone's base unit and closer to your base unit.

# Contents

## **Preparation**

<b>Location of Controls</b> .....	6
<b>Displays</b> .....	9
<b>Settings</b> .....	10
Connections .....	10
Battery Charge .....	11
Selecting the Dialing Mode .....	13
Selecting the Line Mode .....	14
<b>Programmable Functions</b> .....	15
Setting the Auto Talk Feature .....	16
Setting the Talking Caller ID Feature .....	17
Selecting the Ringer Volume .....	18
<b>Preparing the Answering System</b> .....	20
Greeting Message .....	20
Programming Summary for the Answering System .....	22
Selecting the Caller's Recording Time .....	23
Day and Time Adjustment .....	24
Selecting the Number of Rings .....	26

## **Cordless Telephone**

<b>Making Calls</b> .....	27
With the Handset .....	27
With the Base Unit .....	30
Simultaneous Keypad Dialing .....	32
<b>Answering Calls</b> .....	33
With the Handset .....	33
With the Base Unit .....	33
<b>Caller ID Service</b> .....	34
<b>Using the Caller List</b> .....	37
Viewing the Caller List .....	37
Calling Back from the Caller List .....	38
Editing the Caller's Phone Number .....	39
Storing Caller List Information in the Directory .....	41
Erasing Caller List Information .....	42
<b>One-Touch Dialer</b> .....	44
Storing a Phone Number in the DIRECT Button .....	44
Dialing the Stored Number in the DIRECT Button .....	45
<b>Using the Directory</b> .....	45
Storing Names and Numbers in the Directory .....	46
Selecting Characters to Enter Names .....	48
Finding Items in the Directory .....	50

Dialing from the Directory . . . . .	51
Editing an Item in the Directory . . . . .	52
Erasing an Item from the Directory . . . . .	53
<b>Intercom</b> . . . . .	54
Transferring a Call Using the Intercom . . . . .	55
<b>Special Features</b> . . . . .	56
Automatic Security Code Setting . . . . .	56
For Call Waiting Service Users . . . . .	56
How to Use the PAUSE Button (For Analog PBX Line/Long Distance Service Users) . . . . .	56
Temporary Tone Dialing (For Rotary or Pulse Service Users) . . . . .	57
FLASH Button . . . . .	57

### **Answering System**

<b>Automatic Answering Operation</b> . . . . .	58
Setting the Unit to Answer Calls . . . . .	58
<b>Listening to Messages</b> . . . . .	59
From the Handset . . . . .	60
<b>Erasing Messages</b> . . . . .	61
<b>Pager Call</b> . . . . .	62
Storing a Pager Number . . . . .	62
Storing Your Home Telephone Number . . . . .	64
Pager Mode Setting . . . . .	66
Setting the Unit to Call a Pager . . . . .	67
<b>Remote Operation from a Touch Tone Phone</b> . . . . .	68
Setting the Remote Code . . . . .	69
Voice Menu . . . . .	70
Direct Remote Operation . . . . .	72
<b>Remote Operation with the Handset</b> . . . . .	74

### **Useful Information**

<b>Wall Mounting</b> . . . . .	76
<b>Using the Belt Clip</b> . . . . .	77
<b>Using an Optional Headset</b> . . . . .	78
<b>Battery Replacement</b> . . . . .	80
<b>Adding Another Phone</b> . . . . .	81
<b>Fashion Plate™ Snap-On Color Covers (Optional)</b> . . . . .	82
<b>If the Following Appear...</b> . . . . .	84
<b>Before Requesting Help</b> . . . . .	86
<b>Important Safety Instructions</b> . . . . .	92
<b>FCC and Other Information</b> . . . . .	94

# Location of Controls

## Base unit

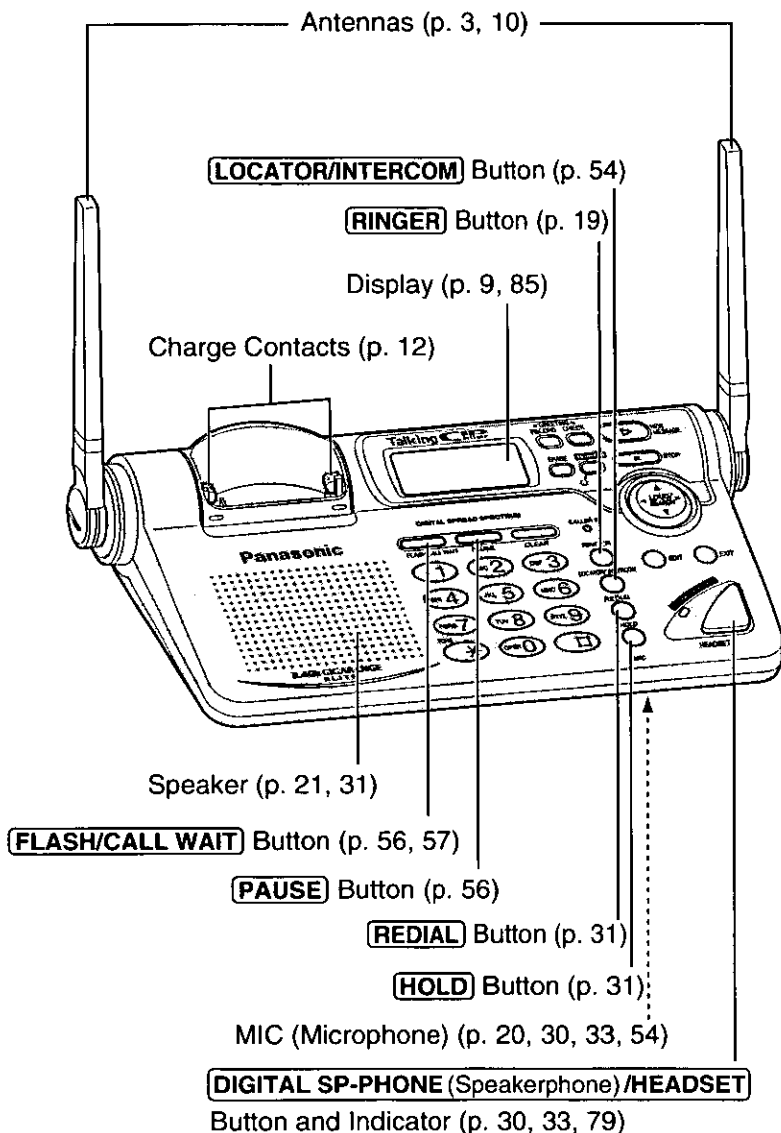

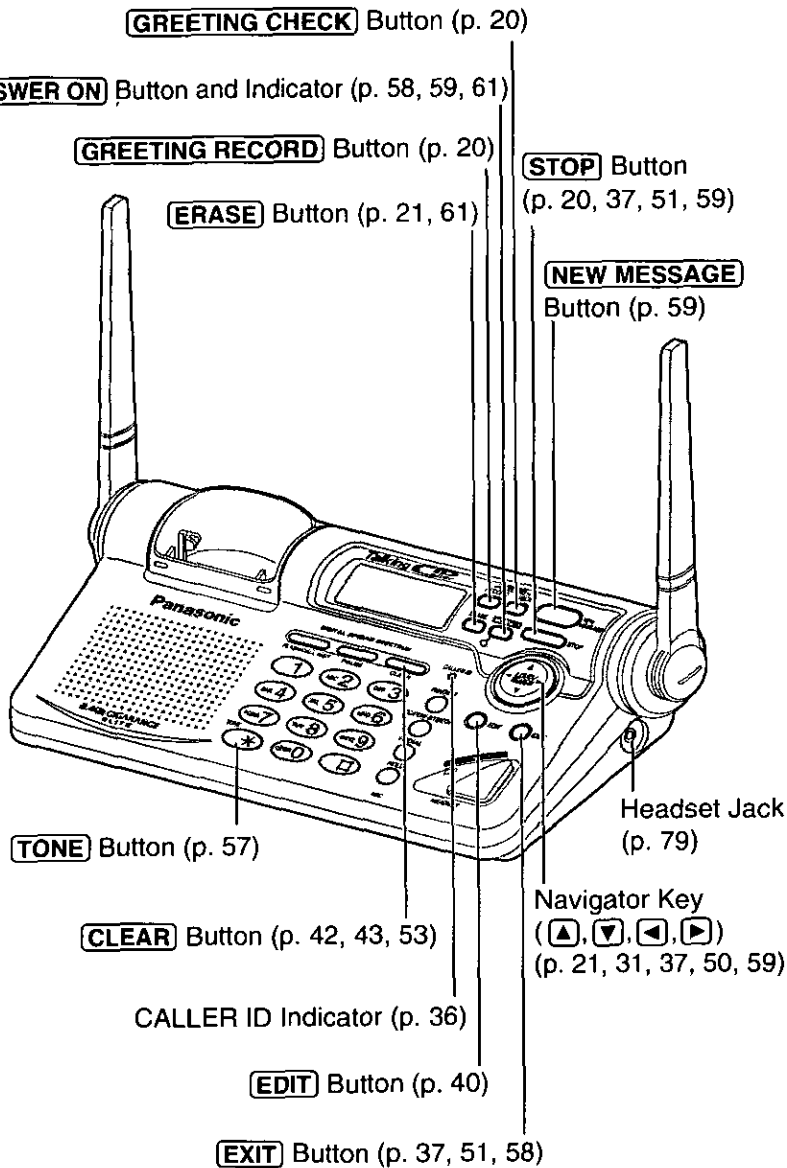

# ➔ Location of Controls

## Handset

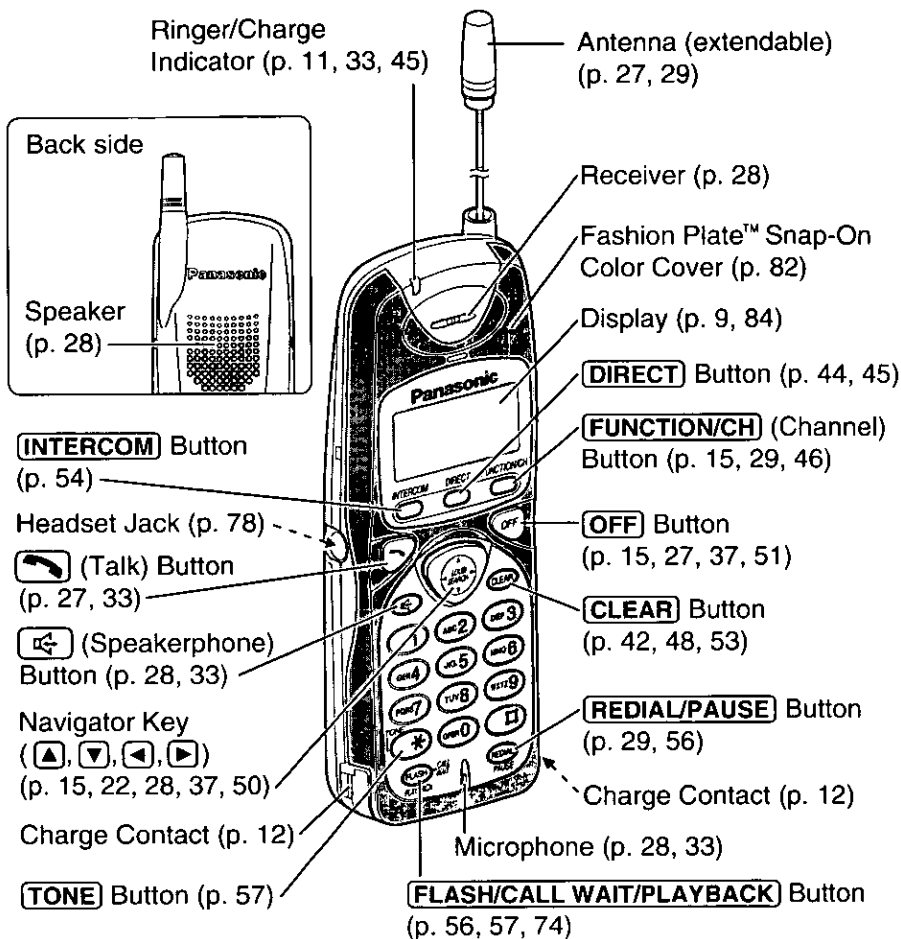

### How to handle the handset antenna:

You can even use the handset without extending the antenna. But for best performance, extend the antenna fully until it locks into position.

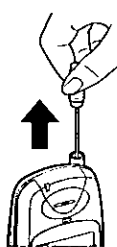

To put away the antenna, slide down vertically holding the lower part until it stops.

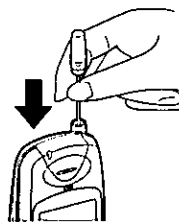



# Displays

## Handset

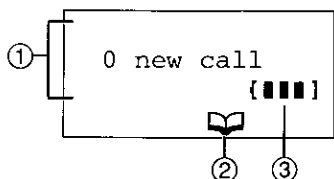

①The display shows the dialed number, call status, programming options and directory items etc. If you subscribe to a Caller ID service, caller information will be displayed (p. 34). The number of new calls will also be displayed.

②The directory icon displays when storing or viewing the directory items (p. 46, 50).

③The battery icon indicates the battery strength (p. 11).

### Standby mode:

While the handset is off the base unit, the display becomes blank after you finish using the handset (making/answering a call, viewing the Caller List or directory list etc.). The handset can receive calls. The battery life is conserved in this state. While the handset is on the base unit, the battery icon and the number of new Caller ID calls are displayed in the standby mode (p. 36).

## Base unit

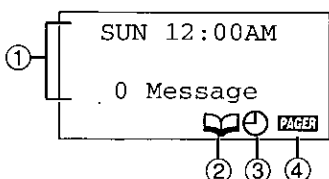

①The day and time and the number of incoming messages are displayed while the unit is not in use (**Standby mode**). The display shows the dialed number, call status, programming options and directory items etc.

If you subscribe to a Caller ID service, caller information will be displayed (p. 34). The number of new calls will also be displayed.

②The directory icon displays when viewing the directory items (p. 50).

③The clock icon flashes with the day and time if the clock needs adjusting (p. 24).

④The pager icon indicates the pager mode is on (p. 67).

## Backlight LCD Displays

The handset and the base unit have the backlight LCD displays. Each display will light when you start using the handset or the base unit, and when a call is received. The handset display light will stay on for a few seconds after pressing a button or lifting the handset off the base unit. The base unit display light will go out after use.

You can change the backlight color to orange for certain callers by storing them in the directory (p. 45).

# Settings

## Connections

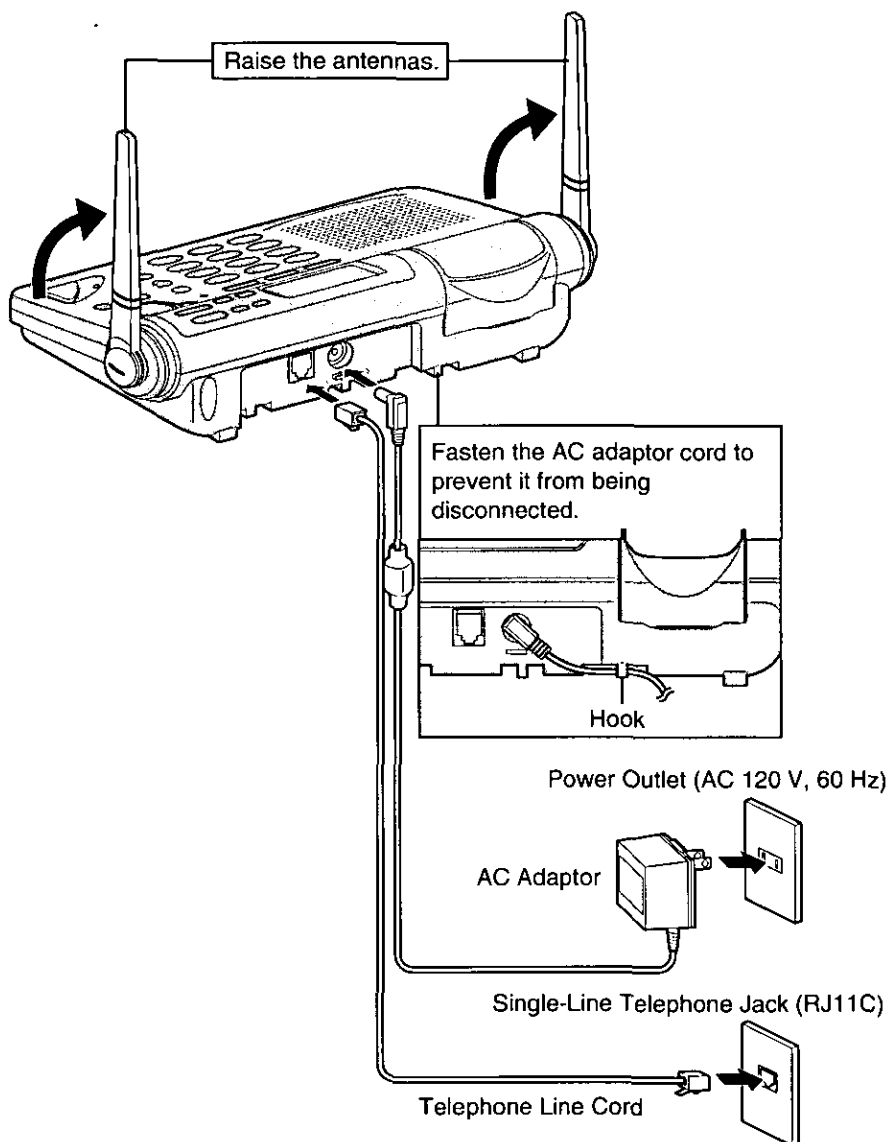

- USE ONLY WITH Panasonic AC ADAPTOR PQLV10 (Order No. PQWATG2650N).
- The AC adaptor must remain connected at all times. (It is normal for the adaptor to feel warm during use.)
- To connect a standard telephone on the same line, see page 81.
- If your unit is connected to a PBX which does not support Caller ID services, you cannot access those services.



## Battery Charge

Insert the handset in the cradle. The ringer/charge indicator will light and a beep will sound. Charge for about **8 hours** before initial use.

- If the battery has been fully charged, the ringer/charge indicator light will turn from red to green.
- If you use the handset for a few minutes, the ringer/charge indicator light will stay red for a while even if the battery is fully charged. This is normal.

Ringer/Charge Indicator

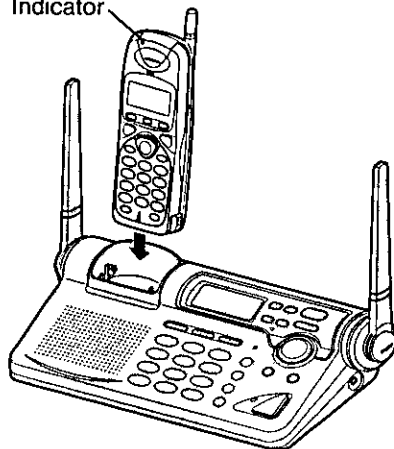

## Battery strength

You can check the battery strength on the handset display while the handset is on the base unit, while it is in use (making/answering a call etc.), or after viewing the Caller List or directory items, programming etc. The battery strength will remain for 5 seconds after using the handset, then the display will return to the standby mode (p. 9).

The battery strength is as shown in the chart below.

Display prompt	Battery strength
{■■■■}	High
{■■■}	Medium
{■■}	Low
⌘{■■}⌘ (flashing)	Needs to be recharged.

- If the battery has been fully charged, the ringer/charge indicator will light in green.

### Recharge

Recharge the battery when:

- “Recharge battery” is displayed on the handset,
- “{ ■}” flashes on the display, or
- the handset beeps intermittently while it is in use.

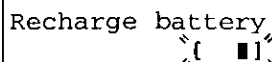

Recharge battery  
{ ■}

- If you DO NOT recharge the handset battery for more than 15 minutes, the display will keep indicating “Recharge battery” and/or “{ ■}” will continue to flash.

### Battery information

After your Panasonic battery is fully charged (p. 11):

Operation		Approx. battery life
While in use (TALK)	near the base unit*	Up to 4.5 hours
	away from the base unit	Up to 3.5 hours
While not in use (Standby)		Up to 11 days

\*Within about 10 feet (3 m)

- Battery life may be shortened depending on usage conditions, such as viewing the Caller ID Caller List or directory list, and ambient temperature.
- Clean the handset and the base unit charge contacts with a soft, dry cloth once a month. Clean more often if the unit is subject to grease, dust or high humidity.** Otherwise the battery may not charge properly.
- If the battery is fully charged, you do not have to place the handset on the base unit until “Recharge battery” is displayed and/or “{ ■}” flashes. This will maximize the battery life.
- The battery cannot be overcharged.



# Selecting the Dialing Mode

You can program the dialing mode using the handset near the base unit.

If you have touch tone service, set to "Tone". If rotary or pulse service is used, set to "Pulse". Your phone comes from the factory set to "Tone".

**Make sure the unit is in the standby mode initially.**

- 1 Press **FUNCTION/CH**.
 

▶Save directory
Ringer volume
▼▲ ▶=Yes
  
- 2 Press **▼** or **▲** repeatedly until the arrow points to "Program".
 

▶Program
Calling pager
▼▲ ▶=Yes
  
- 3 Press **▶** (Yes key).
 

▶Save DIRECT#
Set flash time
▼▲ ▶=Yes
  
- 4 Press **▼** or **▲** repeatedly until the arrow points to "Set dial mode".
 

▶Set dial mode
TAD program
▼▲ ▶=Yes
  
- 5 Press **▶** (Yes key).
 

Dial mode
:Tone
▼▲ ▶=Save
  
- 6 Press **▼** or **▲** to select "Pulse" or "Tone".
 

Dial mode
:Pulse
▼▲ ▶=Save
  
- 7 Press **▶** (Save key).
  - A beep sounds.
  - To return to the standby mode, press **OFF**.

Dial mode
:Pulse

- You can exit the programming mode any time by pressing **OFF**.
- If the handset has lost communication with the base unit, 3 beeps sound and "No link to base. Place on cradle and try again." is displayed.

### Selecting the Line Mode

If the line is connected to a low voltage system such as a PBX, set to "B". Otherwise the Call Waiting Caller ID Feature may not be used (p. 56), and the unit may not alert your pager (p. 62). Your phone comes from the factory set to "A". **Use the handset near the base unit.**

**Make sure the unit is in the standby mode initially.**

- 1 Press **FUNCTION/CH**.  

▶Save directory	
Ringer volume	
▼▲	▶=Yes
- 2 Press **▼** or **▲** repeatedly until the arrow points to "Program".  

▶Program	
Calling pager	
▼▲	▶=Yes
- 3 Press **▶** (Yes key).  

▶Save DIRECT#	
Set flash time	
▼▲	▶=Yes
- 4 Press **▼** or **▲** repeatedly until the arrow points to "Set line mode".  

▶Set line mode	
Talk switching	
▼▲	▶=Yes
- 5 Press **▶** (Yes key).  

Line mode	
	:A
▼▲	▶=Save
- 6 Press **▼** or **▲** to select "B" or "A".  

Line mode	
	:B
▼▲	▶=Save
- 7 Press **▶** (Save key).  

Line mode	
	:B

  - A beep sounds.
  - To return to the standby mode, press **OFF**.

- You can exit the programming mode any time by pressing **OFF**.
- If the handset has lost communication with the base unit, 3 beeps sound and "No link to base. Place on cradle and try again." is displayed.

# Programmable Functions



You can program the following function items **using the handset near the base unit**. The display shows the programming instructions. See the corresponding pages for function details.

**Make sure the unit is in the standby mode initially.**

Press **[FUNCTION/CH]**.



<Function menu>\*

▶ Save directory.....	To store an item in the directory (p. 46).
Ringer volume .....	To select the handset ringer volume (p. 18).
Program	
Calling pager .....	To dial the stored pager number (p. 65).

Press **[▶]**.



<Function menu>\*

▶ Save DIRECT# .....	To store a phone number in the DIRECT button (p. 44).
Set flash time .....	To select the flash time (p. 57).
Set line mode .....	To select the line mode (p. 14).
Talk switching.....	To set the auto talk feature (p. 16).
Set dial mode .....	To select the dial mode (p. 13).
TAD program .....	To program answering system functions (p. 22).
Talk Caller ID.....	To set the Talking Caller ID feature (p. 17).



## During programming:

\*To select a desired function item, press **[▼]** or **[▲]** repeatedly until the arrow points to the item. Then press **[▶]** to go to the next step.

- You can exit the programming mode any time by pressing **[OFF]**.
- If you do not press any buttons for 60 seconds, the unit will return to the standby mode.
- If the handset has lost communication with the base unit, 3 beeps sound and "No link to base. Place on cradle and try again." is displayed.



## ➔ Programmable Functions

### Setting the Auto Talk Feature

The Auto Talk feature allows you to answer a call by lifting the handset off the base unit without pressing  or . If you want to use this feature, turn the feature ON by programming. Your phone comes from the factory set to OFF.



**Make sure the unit is in the standby mode initially.**

1 Press **FUNCTION/CH**.

2 Press  or  repeatedly until the arrow points to "Program".

```
▶Program
  Calling pager
▼▲                ▶=Yes
```



3 Press  (Yes key).

4 Press  or  repeatedly until the arrow points to "Talk switching".

```
Set line mode
▶Talk switching
▼▲                ▶=Yes
```

5 Press  (Yes key).

```
Auto talk
                                :Off
▼▲                ▶=Save
```

6 Press  or  to select "On" or "Off".

```
Auto talk
                                :On
▼▲                ▶=Save
```

7 Press  (Save key).

•A beep sounds.

•To return to the standby mode, press **OFF**.

```
Auto talk
                                :On
```

•You can exit the programming mode any time by pressing **OFF**.

•In order to view Caller ID information before answering a call, leave the Auto Talk feature OFF.





## Setting the Talking Caller ID Feature

After subscribing to a Caller ID service, the handset and the base unit will display a caller's name and phone number (p. 34). Name and telephone number Caller ID service is required. This Talking Caller ID feature allows the unit to announce a displayed caller's name through the handset and base unit speakers while a call is being received (p. 34). You can listen to the caller's name instead of looking at the display.

For example, if you receive a call from "JOHN SMITH", the unit will display "SMITH, JOHN" and announce "Call from SMITH, JOHN" repeatedly until you or the answering system answer the call.

Your unit comes with this feature turned ON, but you may turn it OFF.

**Make sure the unit is in the standby mode initially.**

1 Press **FUNCTION/CH**.

2 Press **▼** or **▲** repeatedly until the arrow points to "Program".

▶Program Calling pager ▼▲ ▶=Yes
---------------------------------------

3 Press **▶** (Yes key).

4 Press **▼** or **▲** repeatedly until the arrow points to "Talk Caller ID".

▶Talk Caller ID ▼▲ ▶=Yes
-----------------------------

5 Press **▶** (Yes key).

Talk Caller ID :On ▼▲ ▶=Save
------------------------------------

6 Press **▼** or **▲** to select "Off" or "On".

Talk Caller ID :Off ▼▲ ▶=Save
-------------------------------------

7 Press **▶** (Save key).

•A beep sounds.

•To return to the standby mode, press **OFF**.

Talk Caller ID :Off
------------------------

•You can exit the programming mode any time by pressing **OFF**.

### Selecting the Ringer Volume

#### With the handset

You can set the handset ringer volume to HIGH, LOW or OFF. If set to OFF, the handset will not ring, and a caller's name will not be announced with the handset even if the Talking Caller ID feature is ON (p. 17).

Your phone comes from the factory set to HIGH.

**Make sure the unit is in the standby mode initially.**

- 1 Press **[FUNCTION/CH]**.
- 2 Press **[▼]** or **[▲]** repeatedly until the arrow points to "Ringer volume".
- 3 Press **[▶]** (Yes key).
- 4 Press **[▼]** or **[▲]** to select the desired volume.
  - The selected volume is displayed and rings.
  - To turn the ringer OFF**, press and hold **[▼]** until 2 beeps sound.

```
Save directory
▶Ringer volume
▼▲ ▶=Yes
```

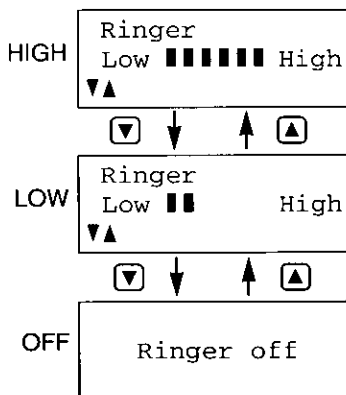

**To turn the ringer ON**, press **[▲]** or **[▼]** in step 4.

- The ringer will sound at the LOW level.
- You can also select the ringer volume while a call is being received. Press **[▼]** or **[▲]** while the unit is just ringing. If you adjust the ringer volume while the unit is announcing a caller's name (Talking Caller ID feature, p. 17, 34), the ringer volume will not be changed but the speaker volume will be changed.
- When set to OFF, "Ringer off" will flash for about 45 seconds before the handset returns to the standby mode.
- When you replace the battery, the selected ringer volume setting will return to the factory set (HIGH). Reprogram if necessary.

## With the base unit

You can set the base unit ringer volume to HIGH, LOW or OFF. If set to OFF, the base unit will not ring, and a caller's name will not be announced with the base unit even if the Talking Caller ID feature is ON (p. 17).

Your phone comes from the factory set to HIGH.

Make sure the unit is in the standby mode initially. (You can also select the ringer volume while a call is being received.)

**To select HIGH or LOW, press **RINGER**.**

- Each time you press the button, the selected ringer volume will be displayed and ring.

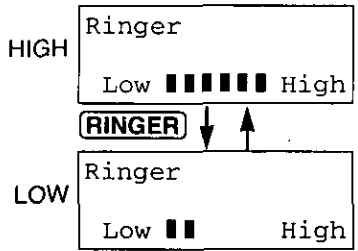

**To turn the ringer OFF, press and hold **RINGER** until 2 beeps sound.**

- "Ringer off" will be displayed.

**To turn the ringer ON, press **RINGER**.**

- The ringer will sound at the HIGH level.

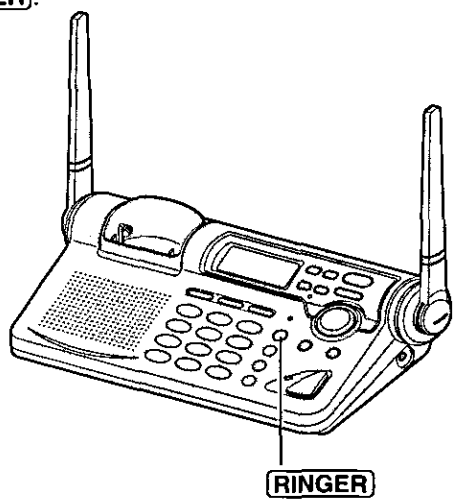
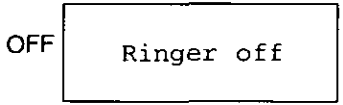

# Preparing the Answering System

## Greeting Message

You can record a personal greeting message of **up to 2 minutes**. If a greeting message is not recorded, one of two pre-recorded greetings will be played when a call is received (p. 21).

All messages (greeting, incoming, etc.) are stored in digital memory (p. 21). The **total recording time is about 15 minutes**.

We recommend you record a **brief greeting message** (see sample on next page) in order to leave more time for recording new messages.

### To record a greeting message

- 1 Press **GREETING RECORD** to start the recording mode.
  - “Press RECORD again to record greeting” is heard.

- 2 Within 5 seconds, press **GREETING RECORD** again to record your greeting.
  - A long beep sounds.

Greeting record
00-00

- 3 After the long beep, talk clearly, about 8 inches (20 cm) away from the **MIC** (microphone).

Greeting record
00-12

- The base unit display shows the elapsed recording time.
- If you record for over 2 minutes, the unit will automatically stop recording.

- 4 When finished, press **STOP**.
  - To check the recorded greeting, press **GREETING CHECK**.

Greeting check
00-12

- To change the message, start again from step 1.

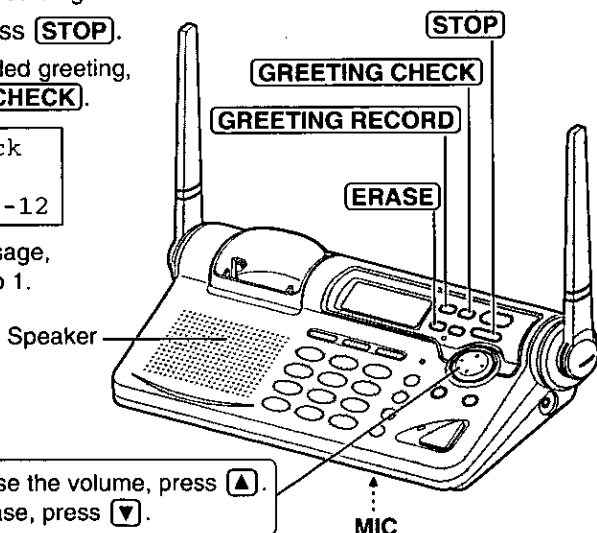



### To adjust the speaker volume:

9 levels (0–8) are available while using the answering system. To increase, press **▲**.

To decrease, press **▼**.

Ex. Level 8



### Greeting message sample

“Hello, this is (your name and/or number). Sorry I cannot take your call. Please leave a message after the beep. Thank you.”

### To erase the recorded greeting message

Press **GREETING CHECK** → press **ERASE** while the message is being played.

- The unit will answer a call with a pre-recorded greeting.

### Pre-recorded greeting message

If you do not record a greeting message (p. 20), one of two messages will be played when a call is received, depending on the caller’s recording time (p. 23).

To check the pre-recorded greeting, press **GREETING CHECK**.

- A pre-recorded greeting will be played as follows:

- When the recording time is set to “1 minute” or “3 minutes”:

“Hello, we are not available now. Please leave your name and phone number after the beep. We will return your call.”

- When the recording time is set to “Greeting only”:

“Hello, we are not available now. Please call again. Thank you for your call.”

### Flash Memory Message Backup

Messages are stored on a “flash memory” IC chip and will not be affected by power failures. All messages are saved until you erase them.

## ➡ Preparing the Answering System

### Programming Summary for the Answering System

You can program the following functions using the handset near the base unit. Make sure the unit is in the standby mode initially.

Press **FUNCTION/CH**. Press **▼** or **▲** to select "Program", and press **▶** (Yes key).

Press **▼** or **▲** to select "TAD program", and press **▶** (Yes key).  
•"Answering system setting. See base unit." is displayed on the handset.

The base unit display shows programming options. Enter a required command on the display using the handset dialing buttons. See the page numbers for details.

0=Day and time	Adjusts the day and time (p. 24).
1=Remote code	Sets the remote code (p. 69).
2=Number of ring	Selects the number of rings (p. 26).
↓*	
5=Recording time	Selects the caller's recording time (p. 23).
6=Pager mode	Selects the pager mode setting (p. 66).
7=Home number	Stores your home telephone no. (p. 64).
↓*	
#=Pager number	Stores a pager number (p. 62).

\*The display will change every 3 seconds.

Press **▶** (Save key).

- You can exit the programming mode any time by pressing **OFF**.
- If you do not press any buttons for 60 seconds, the unit will return to the standby mode.
- If 6 beeps sound on the base unit during programming, a wrong key was pressed. Enter the correct number.
- If the handset has lost communication with the base unit, 3 beeps sound and "No link to base. Place on cradle and try again." is displayed on the handset.



## Selecting the Caller's Recording Time

You can select "1 minute", "3 minutes" or "Greeting only" for the caller's recording time. Your phone comes from the factory set to "3 minutes".

- 1 Press **FUNCTION/CH**.
 

▶Save directory
Ringer volume
▼▲ ▶=Yes
- 2 Press **▼** or **▲** repeatedly until the arrow points to "Program".
 

▶Program
Calling pager
▼▲ ▶=Yes
- 3 Press **▶** (Yes key).
 

▶Save DIRECT#
Set flash time
▼▲ ▶=Yes
- 4 Press **▼** or **▲** repeatedly until the arrow points to "TAD program".
 

Set dial mode
▶TAD program
▼▲ ▶=Yes
- 5 Press **▶** (Yes key).
  - The base unit display shows programming options.

Answering system setting.
See base unit.
- 6 Press **5**.
  - The current setting is displayed on the base unit.

Base unit display
Recording time
:3min
- 7 Press **1**, **2** or **3** to select the recording time.
  - 1: 1 minute
  - 2: 3 minutes
  - 3: Greeting only

Base unit display
Recording time
:Greeting only
- 8 Press **▶** (Save key).
  - A beep sounds.
  - To return to the standby mode, press **OFF**.

If you select "Greeting only", the unit will answer a call with the greeting message, and then hang up. The unit will not record any incoming messages. The base unit display will show "Greeting only" in the standby mode.

## ➔ Preparing the Answering System

### Day and Time Adjustment

**Voice Time/Day Stamp:** During playback, a synthesized voice will announce the day and time that each message was recorded.

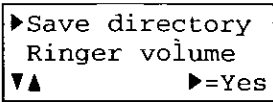
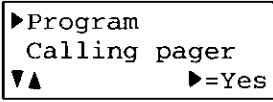
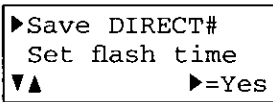
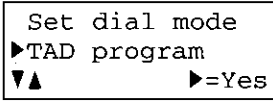
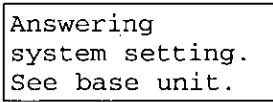
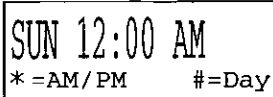
- 1 Press **FUNCTION/CH**.  

- 2 Press **▼** or **▲** repeatedly until the arrow points to "Program".  

- 3 Press **▶** (Yes key).  

- 4 Press **▼** or **▲** repeatedly until the arrow points to "TAD program".  

- 5 Press **▶** (Yes key).  
•The base unit display shows programming options.  

- 6 Press **0**.  
•"Set time" is announced.  
If previously adjusted, the day/time will be heard.  
Base unit display  

- 7 Enter the time (hour and minute) using a 4-digit number.  
(Ex. To set 9:30, enter "0930".)
- 8 Press **\*** to select "AM" or "PM".  
Press **#** repeatedly to set the day.





9 Press  (Save key).

- The unit announces the day/time. The clock starts working.
- If 6 beeps sound, the setting is not correct. Start again from step 5.
- To return to the standby mode, press **OFF**.

•In step 7, you cannot enter numbers greater than 12. **Do not use military time.** (To set 13:00 hours, enter "0100", and select "PM" by pressing )

If a power failure occurs, the adjusted day/time will be erased. Readjust the day/time.

#### **For Caller ID service users (p. 34)**

- The Caller ID information will re-set the clock after the first ring if the adjusted time is incorrect. However, the day will not be re-set. Set the day following the procedures on pages 24 and 25.
- If the time has not previously been set, the Caller ID information will not adjust the clock.
- The Caller ID information will automatically adjust the clock for daylight saving time.

## ➔ Preparing the Answering System

### Selecting the Number of Rings

You can select the number of times the unit rings before the answering system answers a call, from "2" to "7" or "Toll saver".

Your phone comes from the factory set to "3".

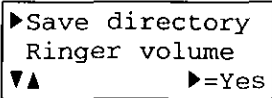
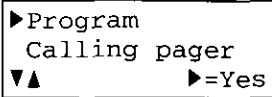
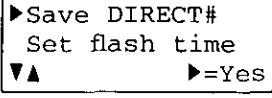
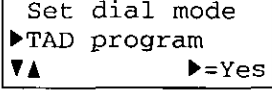
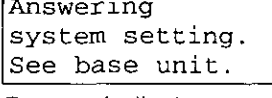
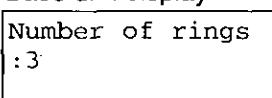
- 1 Press **[FUNCTION/CH]**.  

- 2 Press **[▼]** or **[▲]** repeatedly until the arrow points to "Program".  

- 3 Press **[▶]** (Yes key).  

- 4 Press **[▼]** or **[▲]** repeatedly until the arrow points to "TAD program".  

- 5 Press **[▶]** (Yes key).  
•The base unit display shows programming options.  

- 6 Press **[2]**.  
•The current setting is displayed on the base unit.  

- 7 Press **[0]**, or **[2]** to **[7]** to set the number of rings.  
0: Selects "Toll saver".  
2-7: The unit will answer after the selected number of rings.  
•The unit will announce a caller's name after the 2nd ring (Talking Caller ID feature, p. 34). To listen to the name announcements, do not select "2".
- 8 Press **[▶]** (Save key).  
•A beep sounds.  
•To return to the standby mode, press **[OFF]**.

#### \*Toll saver

When you call the unit from a touch tone telephone:

If the unit answers on the 3rd ring, there is at least one new message.

If the unit answers on the 5th ring, there are no new messages.

**Hang up when you hear the 4th ring.** This will save you the toll charge for the call.

# Making Calls



## With the Handset

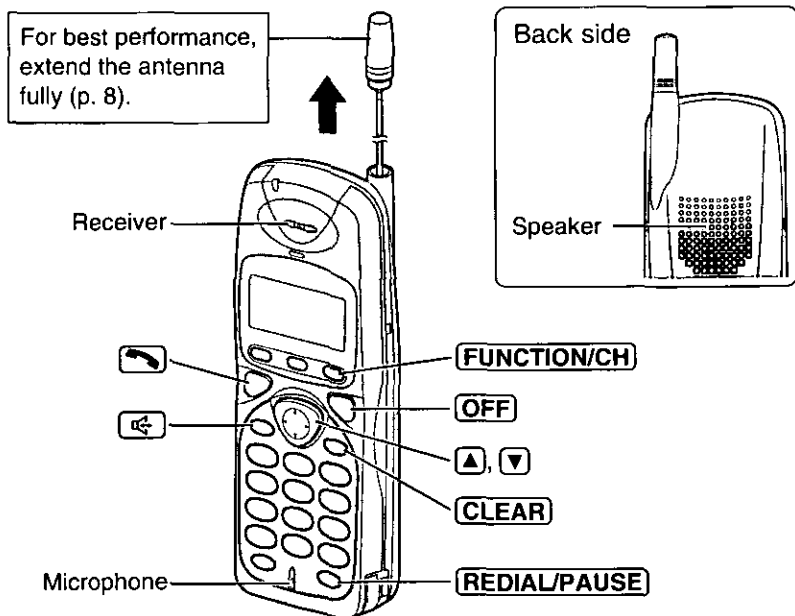

1 Press

Talk

2 Dial a phone number.

- The dialed number is displayed.
- After a few seconds, the display will show the length of the call and the battery strength.

Talk  
1112222

3 To hang up, press **OFF** or place the handset on the base unit.



Talk  
00-00-00 [■■■■]

Off  
00-01-08 [■■■■]

•If the handset has lost communication with the base unit, 3 beeps sound and "No link to base. Place on cradle and try again." is displayed.

## ➔ Making Calls

### To have a hands-free phone conversation (Using Digital Duplex Speakerphone)

- 1 Press .
  - The button lights.
- 2 Dial a phone number.
  - The dialed number is displayed.
  - After a few seconds, the display will show the length of the call and the battery strength.
- 3 When the other party answers, talk into the microphone.
- 4 To hang up, press **OFF** or place the handset on the base unit.
  - The  button light goes out.

Talk

Talk  
1112222





Talk  
00-00-00 [■■■■]

Off  
00-01-08 [■■■■]

- If the handset has lost communication with the base unit, 3 beeps sound and "No link to base. Place on cradle and try again." is displayed.

#### Hands-free Digital Duplex Speakerphone

For best performance, please note the following:



- Talk alternately with the caller in a quiet room.
- If the other party has difficulty hearing you, press  to decrease the speaker volume.
- If the other party's voice from the speaker cuts in/out during a conversation, press  to decrease the speaker volume.
- While talking using , you can switch to the hands-free phone conversation by pressing . To switch back to the receiver, press



### To adjust the receiver volume (High, Medium or Low) or speaker volume (6 levels) while talking

To increase, press .

To decrease press .

- Each time you press  or , the volume level will change.
- The display will return to the length of the call.

Ex. Receiver volume: High  
Speaker volume: level 6

Loud  
Low ■■■■■■ High



## If noise interferes with the conversation

Extend the antenna fully, press **FUNCTION/CH** to select a clearer channel or move closer to the base unit.

## To redial the last number dialed on the handset

Press or and press **REDIAL/PAUSE**.

## To dial after confirming the entered number

1 Dial a phone number.  
•If you misdial, press **CLEAR** and dial again.

33344444

2 Press .  
OR  
To have a hands-free phone conversation, press , and when the other party answers talk into the microphone.

Talk  
33344444

•After a few seconds, the display will show the length of the call and the battery strength.

Talk  
00-00-00 [||||]

3 To hang up, press **OFF** or place the handset on the base unit.

## To redial after confirming the last number dialed

Press **REDIAL/PAUSE** and press or .

## Lighted handset keypad

The handset dialing buttons will light when you press a button or lift the handset off the base unit, and flash when a call is received. The lights will go out a few seconds after pressing a button, lifting the handset or answering a call.

## ➔ Making Calls

### With the Base Unit (Digital Duplex Speakerphone)

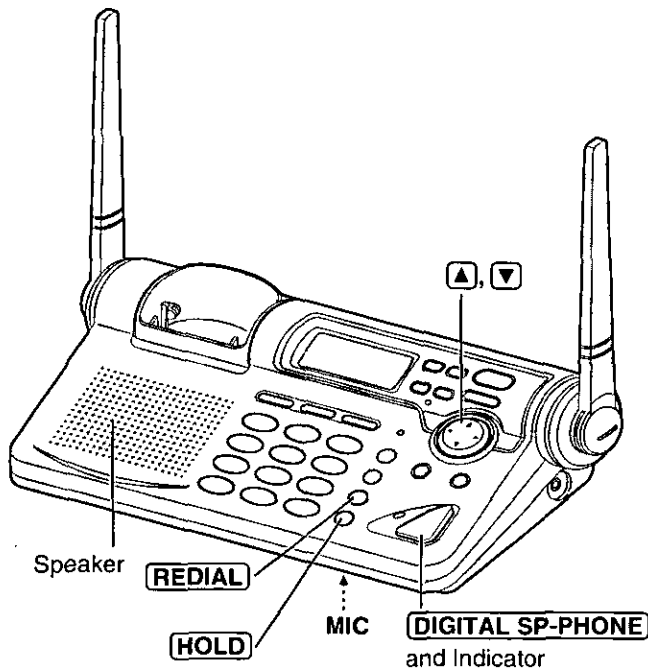

- 1 Press **DIGITAL SP-PHONE**.  
•The DIGITAL SP-PHONE indicator lights.

Talk

- 2 Dial a telephone number.

Talk  
1112222



- 3 When the other party answers, talk into the **MIC** (microphone).

Talk  
00-00-00

- 4 To hang up, press **DIGITAL SP-PHONE**.  
•The indicator light goes out.

Off  
00-00-00

•To switch to the handset while using the base unit speakerphone:

—If the handset is off the base unit, press  or .

—If on the base unit, just lift up.

•During a call using the handset, the call can be switched to the base unit speakerphone by pressing **DIGITAL SP-PHONE** on the base unit.



### Hands-free Digital Duplex Speakerphone

For best performance, please note the following:

- Talk alternately with the caller in a quiet room.
- If the other party has difficulty hearing you, press to decrease the speaker volume.
- If the other party's voice from the speaker cuts in/out during a conversation, press to decrease the speaker volume.

### To adjust the speaker volume (8 levels) while talking

To increase, press .

To decrease, press .

Ex. Level 8



### To redial the last number dialed on the base unit

Press and press .

### To put a call on hold

Press .

- The DIGITAL SP-PHONE indicator flashes.



### To release the hold

From the base unit, press .

From the handset, press or , or lift the handset off the base unit.

- If another phone is connected on the same line (p. 81), you can also release the hold by lifting its handset.

## ➔ Making Calls

### Simultaneous Keypad Dialing

You can use the base unit like a standard telephone. After pressing  to make a call with the handset near the base unit, you can also dial using the base unit keypad.

- 1 Handset:  
Press .
- 2 Base unit:  
Dial a telephone number while hearing a dial tone on the handset.
  - When the other party answers, talk using the handset.
- 3 Handset:  
To hang up, press **OFF** or place the handset on the base unit.

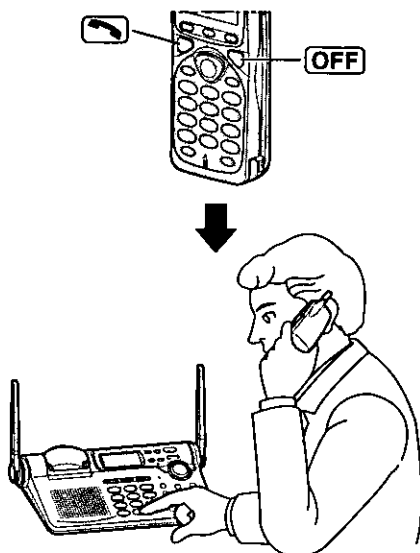

Simultaneous Keypad Dialing is possible after pressing .

### Useful information

You can enter numbers using the base unit keypad during a call with the handset. For example, to access an answering service, electronic banking service, etc.

1. Handset:  
Press .
2. Handset:  
Dial a telephone number.
  - You can also dial with the base unit keypad.
3. Base unit:  
Enter the required numbers while listening to the pre-recorded instructions.
4. Handset:  
To hang up, press **OFF** or place the handset on the base unit.



# Answering Calls

When a call is received, the unit rings, "Incoming call" is displayed and the ringer/charge indicator flashes.





If you subscribe to a Caller ID service, the calling party information will be displayed after the first ring (p. 34). The caller's name will be announced after the second ring (Talking Caller ID feature, p. 17, 34).

If you have a maximum of 50 Caller ID names and numbers stored in the Caller List, and more than 30 names and numbers stored in the directory, the caller's name announcement may be heard after the third ring.

## With the Handset

If the handset is off the base unit;

Press .

•You can also answer a call by pressing any dialing button  to ,  or  (—Any Key Talk).

OR

Press , and when the other party answers talk into the microphone.

Ringer/Charge Indicator



Microphone

## Auto Talk

If you set the Auto Talk feature to ON (p. 16), you can answer a call by lifting the handset off the base unit without pressing  or

.

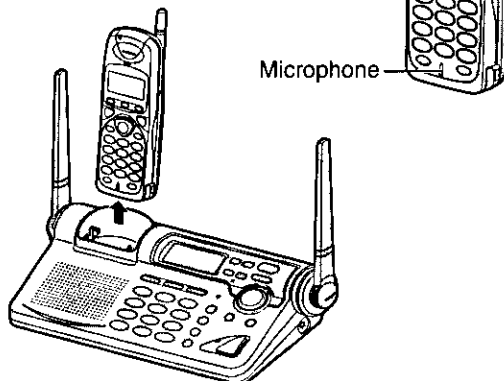

## With the Base Unit

1 Press **DIGITAL SP-PHONE**.

2 Talk into the **MIC**.

3 To hang up, press **DIGITAL SP-PHONE**.

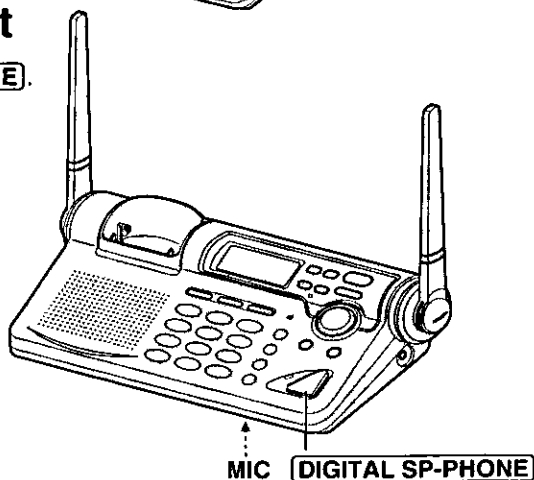

# Caller ID Service

This unit is compatible with a Caller ID service offered by your telephone company. If you subscribe to a Caller ID service, the calling party's information will be shown on the handset and base unit displays after the first ring. After the second ring the handset and the base unit will announce the displayed name following every ring (**Talking Caller ID feature**). You will audibly be informed of whom is calling you. Name and telephone number Caller ID service is required for this feature.

- Only the name will be announced.
- If you have a maximum of 50 Caller ID names or numbers stored in the Caller List, and more than 30 names and numbers stored in the directory, the caller's name announcement may be heard after the third ring.

The unit can record information of up to 50 different callers in the Caller List. The Caller List information is sorted by the most recent to the oldest call. When the 51st call is received, the first call is deleted.

Using the list, you can automatically call back a caller. You can store the callers' names and numbers from the Caller List into the directory.

If you subscribe to both Caller ID and Call Waiting services, when a second call is received while talking, the new caller's name and phone number will be displayed (p. 56).

## How caller information is displayed and a caller's name is announced when a call is received

The handset and base unit displays show the caller's name and number after the first ring. After the second ring, for example, "Call from ROBINSON, TINA" will be heard through the handset and base unit speakers following every ring.

ROBINSON, TINA  
1-000-222-3333

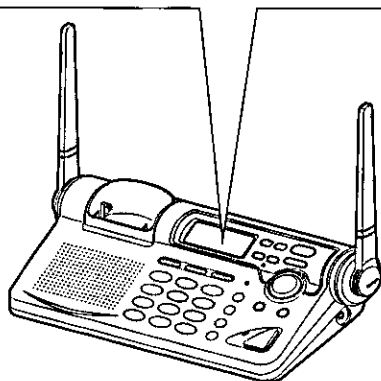
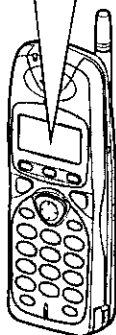

- After you answer the call, the display will show the length of the call.





- Caller information cannot be displayed in the following cases:
  - If the caller dialed from an area which does not provide a Caller ID service, "Out of area" will be displayed and announced.
  - If the caller has requested not to display his/her information, "Private caller" will be displayed and announced.
- If your unit is connected to a PBX which does not support Caller ID services, you cannot access those services.
- The name display service may not be available in some areas. For further information, please contact your telephone company.

### **Using the Talking Caller ID feature:**

- Name and telephone number Caller ID service is required. For further information, please contact your telephone company.
- If a caller dialed from an area which does not provide a name display service, the unit will announce "Call from out of area", "Call from private caller", "Call from out of area, number available" or "Number available".
- You can adjust the handset and base unit speaker volumes during name announcements. Press  or  on the handset or the base unit. 6 levels are available for the handset (p. 28). 8 levels are available for the base unit (p. 31). (If you adjust the handset speaker volume while the unit is just ringing, the speaker volume will not be changed but the ringer volume will be changed.)
- If the handset ringer volume is OFF, the handset will not announce callers' names. If the base unit ringer volume is OFF, the base unit will not announce callers' names.
- If the feature is OFF, the unit does not announce callers' names (p. 17).
- A second caller name will not be announced while talking with the first caller (For Call Waiting Service Users, p. 56).
- Name pronunciation may vary. Name pronunciation quality is based on most commonly names used in the United States.
- If you subscribe to a Distinctive Ring Service (IDENTA-RING for example) from your telephone company with 2 or 3 consecutive rings, your unit may mute one or more of the rings in order to announce the name of the caller.

### **Call group feature (Dual-Color Visual Ringer):**

If you receive a caller ID call from one of the phone numbers stored in the directory and the item has set the feature;

- the handset and base unit will ring with a different ringer pattern,
- the handset and base unit displays will light in orange, and
- the ringer/charge indicator will flash in orange.

You can then distinguish the caller from others easily. To use this feature, store items in the directory and turn the feature on for required items (p. 41, 45, 46).

## ➔ Caller ID Service

### To check the number of new calls

When new calls have been received, the CALLER ID indicator flashes on the base unit. The handset and base unit displays show the number of new calls.

**Ex. You have received 10 new calls.**

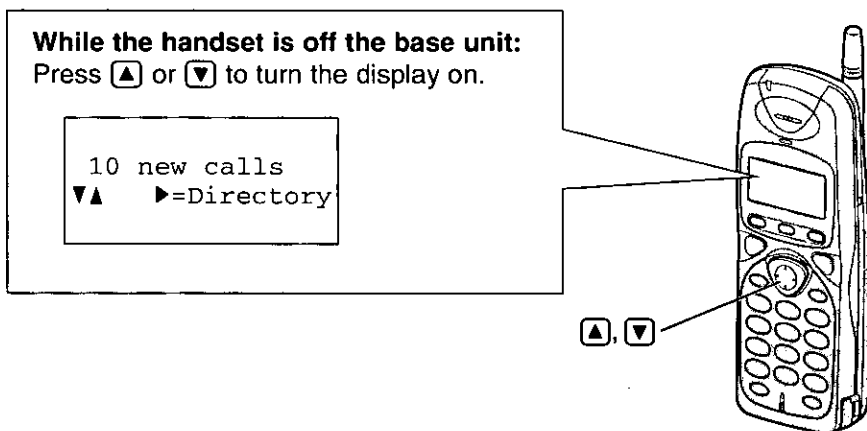
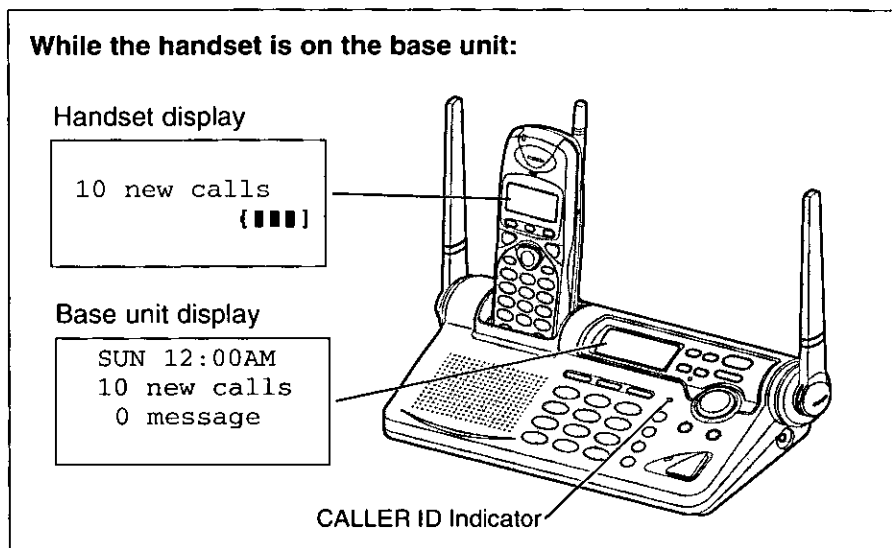

•If "No items stored" is displayed, the Caller List is empty.

# Using the Caller List



## Viewing the Caller List

You can view the caller list with the handset or the base unit. Caller List information includes the caller's name and phone number, the time and date the call was received, and the number of times that caller called.

**Make sure the unit is in the standby mode initially.**

### With the handset

- 1 Press **▼** or **▲** to enter the Caller List.

- The display will show, for example, the following.

```
2 new calls
▼▲ ▶=Directory
```

- You can go to the directory list by pressing **▶** (p. 50).

- 2 To search from the most recent call, press **▼**.  
To search from the oldest call, press **▲**.

- To scroll between callers, press **▼** or **▲**.

```
SMITH, JACK
1-222-333-4444
3:10P JUN.10
```

- 3 To exit the list, press **OFF**.

- The handset will return to the standby mode.

### With the base unit

- 1 Press **▼** or **▲** to enter the Caller List.

- The display will show, for example, the following.

```
2 new calls
▼▲ ▶=Directory
```

- You can go to the directory list by pressing **▶** (p. 50).

- 2 To search from the most recent call, press **▼**.  
To search from the oldest call, press **▲**.

- To scroll between callers, press **▼** or **▲**.

```
SMITH, JACK
1-222-333-4444
3:10P JUN.10
```

- 3 To exit the list, press **EXIT** or **STOP**.

- The base unit will return to the standby mode.

- If "No items stored" is displayed, the Caller List is empty.
- If there is no name information for a caller, the display will only show the phone number.
- While you are viewing the Caller List with the handset, another person cannot access the list using the base unit, and vice versa.

## ➔ Using the Caller List

### What "✓" means

When the display shows "✓", you have already viewed this calling information, answered the call, called back the caller or played back the message (p. 59). If the same caller calls again, the call entry with "✓" will be replaced with the new call entry.

SMITH, JACK 1-222-333-4444 3:10P JUN.10 ✓
-------------------------------------------------



### If a caller calls more than once

The number of times the same caller called is displayed (X2 to X9). The date and time of the most recent call will be recorded. After checking, X2 to X9 will be replaced with "✓".



SMITH, JACK 1-222-333-4444 3:10P JUN.10 X3
--------------------------------------------------

## Calling Back from the Caller List



### With the handset

- 1 Press  or  to enter the Caller List.

3 new calls ▼▲ ▶=Directory
-------------------------------



- 2 Press  or  repeatedly to find the desired caller.

TURNER, CINDY 1-234-456-7890 11:20A JAN.12 X3
-----------------------------------------------------

- 3 Press  or .  
•The displayed phone number is dialed automatically.

Talk 12344567890
---------------------

### With the base unit

- 1 Press  or  to enter the Caller List.

3 new calls ▼▲ ▶=Directory
-------------------------------

- 2 Press  or  repeatedly to find the desired caller.

TURNER, CINDY 1-234-456-7890 11:20A JAN.12 X3
-----------------------------------------------------

- 3 Press **DIGITAL SP-PHONE**.  
•The displayed phone number is dialed automatically.

Talk 12344567890
---------------------

- In some cases, you may have to edit the number before dialing (p. 39, 40).  
(Ex. You may have to delete "1" and the area code.)
- If a phone number is not displayed in the caller information, you cannot call back that caller.



## Editing the Caller's Phone Number

You can edit a phone number into one of 4 patterns using the handset or the base unit.

**Make sure the unit is in the standby mode initially.**

### With the handset

1 Press or to enter the Caller List.

2 Press or repeatedly to find the desired caller, and press .

3 While the arrow points to "Edit", press (Yes key).

4 Press (Edit key) to select a pattern.

- Each time you press , the number is rearranged into one of 4 different patterns.

(a)

(b)  -

(c) 1 -

(d) 1 -  -

- The order in which patterns (a)–(d) are displayed depends on how the telephone number is displayed in step 3.

5 After editing the number, you can continue with calling back or storing procedures. To call back, press or (p. 38). To store the number in the directory, press (Next key), and follow the instructions on the display (see page 41).

5 new calls  
 =Directory

PARKER, FRED  
 1-234-321-5555  
 11:20A JAN.12 ✓

Edit  
 Save directory  
 =Yes

PARKER, FRED  
 1-234-321-5555  
=Next =Edit

(a) 321-5555  
=Next =Edit

(b) 234-321-5555  
=Next =Edit

(c) 1-321-5555  
=Next =Edit

(d) 1-234-321-5555  
=Next =Edit

•The number edited in step 4 will not be maintained in the Caller List.

## ➔ Using the Caller List

### With the base unit

1 Press **▼** or **▲** to enter the Caller List.

5 new calls  
▼▲ ▶=Directory

2 Press **▼** or **▲** repeatedly to find the desired caller.

PARKER, FRED  
1-234-321-5555  
11:20A JAN.12 ✓

3 Press **EDIT** to select a pattern.

- Each time you press **EDIT**, the number is rearranged into one of 4 different patterns.

- (a) **Phone no.**
- (b) **Area code** - **Phone no.**
- (c) 1 - **Phone no.**
- (d) 1 - **Area code** - **Phone no.**

- The order in which patterns (a)–(d) are displayed depends on how the telephone number is displayed in step 2.

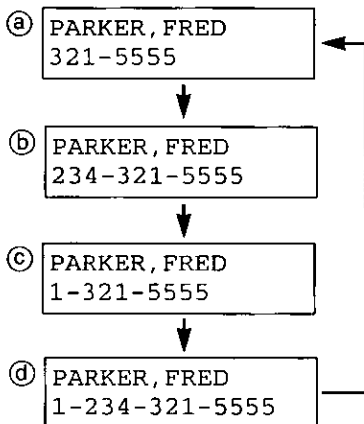

4 After editing the number, you can continue with calling back. Press **DIGITAL SP-PHONE** (p. 38).

- The number edited in step 3 will not be maintained in the Caller List.





## Storing Caller List Information in the Directory

You can store names and phone numbers that are in the Caller List into the directory. You can also turn the call group feature on for certain callers (p. 45).

**Storing must be carried out with the handset.**

**Make sure the unit is in the standby mode initially.**

1 Press or to enter the Caller List.

10 new calls  
 =Directory

2 Press or repeatedly to find the caller you want to store in the directory, and press (Yes key).

TURNER, CINDY  
1-234-456-7890  
11:20A JAN.12 X3

•If the number requires editing, see page 39.

Edit  
Save directory  
 =Yes

3 Press or to select "Save directory", and press (Yes key).

Edit  
Save directory  
 =Yes

**If there is no name information for the caller, "Enter name" will be displayed.**

a) If a name is not required, press (Next key) twice.

Enter name  
  
 =Next

b) If a name is required, enter the name (p. 48). When finished, press (Next key) twice.

Enter name  
CINDY TURNER  
 =Next

4 To turn the call group feature on, select "On" by pressing or . If not required, select "Off". (See page 47, from step 7.)

Set group  
:Off  
 =Next

- You can exit the programming mode any time by pressing **OFF**.
- If the display shows "Directory full" in step 3, press **OFF** to exit the list. To erase other stored items from the directory, see page 53.
- You cannot store caller information in the directory if a phone number is not displayed.
- If 3 beeps sound and the display shows "Save error", move closer to the base unit and start again from step 1.

## ➔ Using the Caller List

### Erasing Caller List Information

After checking the Caller List, you can erase some or all of the entries with the handset or the base unit.

**Make sure the unit is in the standby mode initially.**

#### To erase a specific caller from the Caller List

**With the handset:**

- 1 Press **▼** or **▲** to enter the Caller List.

```
10 new calls
▼▲ ▶=Directory
```

- 2 Press **▼** or **▲** repeatedly to find the caller you want to erase from the Caller List.

```
REAGAN, TOM
1-888-777-6666
12:20A JAN.12 ✓
```

- 3 Press **CLEAR**.

```
Clear
```

- A beep sounds and the information is erased.
- To erase other items, repeat from step 2.
- To return to the standby mode, press **OFF**.

**With the base unit:**

- 1 Press **▼** or **▲** to enter the Caller List.

```
10 new calls
▼▲ ▶=Directory
```

- 2 Press **▼** or **▲** repeatedly to find the caller you want to erase from the Caller List.

```
REAGAN, TOM
1-888-777-6666
12:20A JAN.12 ✓
```

- 3 Press **CLEAR**.



```
Clear
```

- A beep sounds and the information is erased.
- To erase other items, repeat from step 2.
- To return to the standby mode, press **EXIT** or **STOP**.

## To erase all entries in the Caller List

Before erasing all entries, make sure that "0 new call" is displayed.

### With the handset:

- 1 Press  or  to enter the Caller List.



```

0 new call
▼▲ ▶=Directory
  
```

- 2 Press **CLEAR**.

```

▶Exit
All clear
▼▲ ▶=Yes
  
```

- 3 Press  or  to select "All clear".

```

Exit
▶All clear
▼▲ ▶=Yes
  
```



- 4 Press  (Yes key) or **CLEAR**.

```

All clear
  
```

- A beep sounds and all entries are erased.

### With the base unit:

- 1 Press  or  to enter the Caller List.



```

0 new call
▼▲ ▶=Directory
  
```

- 2 Press **CLEAR**.

```

▶Exit
All clear
▼▲ ▶=Yes
  
```

- 3 Press  or  to select "All clear".

```

Exit
▶All clear
▼▲ ▶=Yes
  
```

- 4 Press  (Yes key) or **CLEAR**.

```

All clear
  
```

- A beep sounds and all entries are erased.

# One-Touch Dialer

You can store a phone number in the **DIRECT** button of the handset. The stored number is dialed with a one-touch operation.

## Storing a Phone Number in the DIRECT Button

Make sure the unit is in the standby mode initially.

- 1 Press **FUNCTION/CH**.
- 2 Press **▼** or **▲** repeatedly until the arrow points to "Program".
- 3 Press **▶** (Yes key).
- 4 While the arrow points to "Save DIRECT#", press **▶** (Yes key).
- 5 Enter a phone number, up to 22 digits.
  - Each time you press **CLEAR** the digit to the left of the cursor is erased. To erase all digits, press and hold **CLEAR**.
  - To move the cursor, press **◀** or **▶**.
- 6 Press **▼** (Next key).
  - If you want to edit the entered number, press **▲** (Edit key) and return to step 5.
- 7 Press **▶** (Save key).
  - A beep sounds.
  - To return to the standby mode, press **OFF**.

▶Program
Calling pager
▼▲ ▶=Yes

▶Save DIRECT#
Set flash time
▼▲ ▶=Yes

□
◀▶ ▼=Next

1234567890123456
789012
◀▶ ▼=Next

1234567890123456
789012
▲=Edit ▶=Save

1234567890123456
789012
Save DIRECT#



- You can exit the programming mode any time by pressing **OFF**.
- If a pause is required for dialing, **REDIAL/PAUSE** can be stored in a phone number in step 5. This counts as one digit (p. 56).

## Dialing the Stored Number in the DIRECT Button

- 1 Press **DIRECT**.  
•The stored number is displayed.

1234567890123456 789012
----------------------------

- 2 Press  or .  
•The number is dialed.

- You can also dial the stored number by pressing  or  then pressing **DIRECT**.
- If your line has rotary or pulse service, any access numbers stored after pressing **PHONE** will not be dialed.

## Using the Directory

You can store up to 90 names and phone numbers in the directory using the handset. All directory items are sorted by the first word in alphabetical order. Using the directory, you can make a call by selecting a name on the handset or base unit display.

### Call group feature (Dual-Color Visual Ringer):

You can distinguish certain callers from others by the ringer pattern, the color of the display backlight and the ringer/charge indicator light when a call is received. Turn the call group feature on for required items (for example, for family). When a Caller ID call is received from those callers, the handset and the base unit will ring with a different ringer pattern from the second ring, the handset and base unit displays will light in orange and the ringer/charge indicator will flash in orange from the second ring. If you have a maximum of 50 Caller ID names and numbers stored in the Caller List, and more than 30 names and numbers stored in the directory, the ringer pattern may change, the color of the display backlight may change and the ringer/charge indicator may flash in orange from the third ring.

Call group feature	Backlight color Ringer/Charge indicator light color	Ringer pattern
Off	Green	Ordinary
On	Orange	Higher pitch

- The call group feature cannot be used without subscribing to a Caller ID service (p. 34).



## ➔ Using the Directory

### Storing Names and Numbers in the Directory

Store a name and number, then if required, turn the call group feature on for the item.

**Storing must be carried out with the handset.**

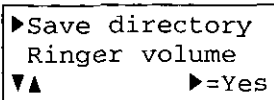
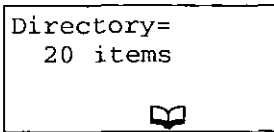
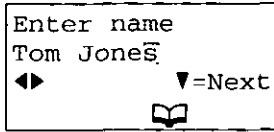
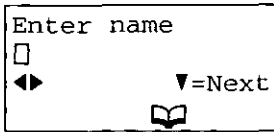
**Make sure the unit is in the standby mode initially.**

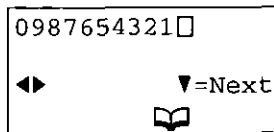
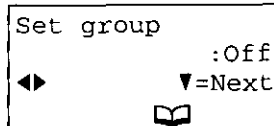
- 1 Press **FUNCTION/CH**.  

- 2 While the arrow points to "Save directory", press **▶** (Yes key).
  - The display shows the number of stored items in the directory.
- 3 Enter a name, up to 15 characters using the dialing buttons (p. 48).
  - To move the cursor, press **◀** or **▶**.
  - If a name is not required, press **▼** (Next key) and go to step 5.
- 4 Press **▼** (Next key).  

- 5 Enter a phone number, up to 22 digits.
  - If you misdial, press **CLEAR**. Digits are erased from the right. To erase all digits, press and hold **CLEAR**.
- 6 Press **▼** (Next key).  

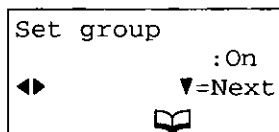

- 7 To turn the call group feature on, select "On" by pressing ◀ or ▶.  
If not required, select "Off".

- When "On" is selected, the display will light in orange and a different ringer pattern will be heard. When "Off" is selected, an ordinary ringer pattern will be heard.



- 8 Press ▼ (Next key).

- If you want to change the storing name, number or group setting, press ▲ (Edit key) repeatedly to reach the desired display and change it.

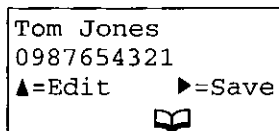

- 9 Press ▶ (Save key).

- A beep sounds.
- To continue storing other items, repeat from step 2.
- To return to the standby mode, press **OFF**.

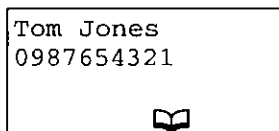

- If a pause is required for dialing, **REDIAL/PAUSE** can be stored in a phone number in step 5. This counts as one digit (p. 56).
- You can exit the programming mode any time by pressing **OFF**.
- If the display shows "Directory full" in step 2, press **OFF**. To erase other stored items from the directory, see page 53.
- After the maximum of 90 items has been stored, "Directory full" is also displayed.
- If 3 beeps sound and the display shows "Save error", move closer to the base unit and start again from step 1.

## ➔ Using the Directory

### Selecting Characters to Enter Names

The handset dialing buttons (0 to 9) can be used to enter letters and symbols. The letters are printed on the dialing buttons.

Pressing each button selects a character as shown below.

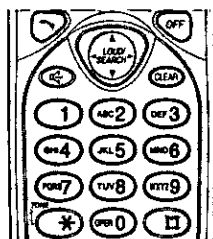

Keys	Number of times key is pressed										
	1	2	3	4	5	6	7	8	9	10	11
①	#	&	'	( )	*	,	-	.	/	1	
②	A	B	C	a	b	c	2				
③	D	E	F	d	e	f	3				
④	G	H	I	g	h	i	4				
⑤	J	K	L	j	k	l	5				
⑥	M	N	O	m	n	o	6				
⑦	P	Q	R	S	p	q	r	s	7		
⑧	T	U	V	t	u	v	8				
⑨	W	X	Y	Z	w	x	y	z	9		
⑩	0	Blank									
◀	To move the cursor to the left										
▶	To move the cursor to the right										

- To enter another character using the same dialing button, press ▶ to move the cursor to the next space.

### If you make a mistake while entering a name

Use ◀ or ▶ to move the cursor to the incorrect character, press **CLEAR** to delete and enter the correct character. Each time you press **CLEAR**, a character is erased from the right.

To erase all characters, press and hold **CLEAR**.





## For example, to enter "Tom Jones":

- 1 Press **[FUNCTION/CH]**.
- 2 While the arrow points to "Save directory", press **[▶]** (Yes key).
- 3 Press **[8]**.
- 4 Press **[6]** six times, then press **[▶]** to move the cursor to the right.
- 5 Press **[6]** four times.
- 6 Press **[▶]** twice to enter a blank.
- 7 Press **[5]**.
- 8 Press **[6]** six times, then press **[▶]** to move the cursor to the right.
- 9 Press **[6]** five times.
- 10 Press **[3]** five times.
- 11 Press **[7]** eight times.
- 12 When finished, press **[▼]** (Next key).
  - To enter a phone number and continue storing, see page 46, from step 5.

▶ Save directory  
Ringer volume  
▼▲ ▶=Yes

Directory=  
20 items

Enter name  
□  
◀▶ ▼=Next

T

To□

Tom

Tom □

Tom J

Tom Jo□

Tom Jon

Tom Jonē

Enter name  
Tom Jones  
◀▶ ▼=Next

Enter phone no.

## ➔ Using the Directory

### Finding Items in the Directory

You can search the directory using the handset or the base unit.

**Make sure the unit is in the standby mode initially.**

#### With the handset/base unit

1 Press or to enter the directory list.

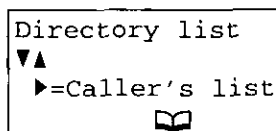

2 Press or .

- The first item is displayed.

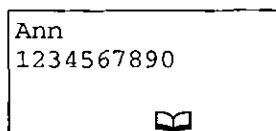

3 Press or repeatedly until the desired item is displayed.

- All directory items are stored in the order shown on the right.

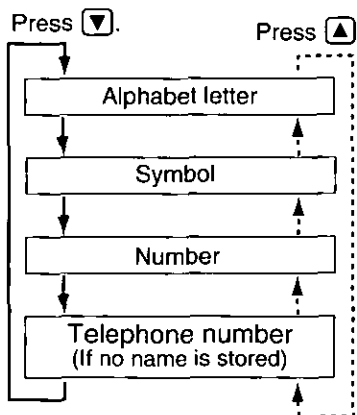

#### To search for a name by initial

With the handset/base unit:

1 Press or to enter the directory list.

2 Press or .

- The first item is displayed.

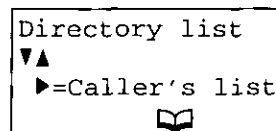

3 Press the dialing button for the first letter of the desired name until any name with the same initial is displayed (see the Index table on page 51).

Ex. To find "Frank", press repeatedly until the first item under "F" is displayed.

4 Press repeatedly until the name is displayed.



## Index table

Keys	Index	Keys	Index
①	Other symbols, 1	⑥	M, N, O, 6
②	A, B, C, 2	⑦	P, Q, R, S, 7
③	D, E, F, 3	⑧	T, U, V, 8
④	G, H, I, 4	⑨	W, X, Y, Z, 9
⑤	J, K, L, 5	⑩	0

- You can leave the directory list any time. If using the handset, press **OFF**. If using the base unit, press **EXIT** or **STOP**.
- If "No items stored" is displayed in step 2, the directory is empty.
- In step 1, you can go to the Caller List by pressing (p. 37).
- If you are viewing the directory with the handset, another person cannot access the directory using the base unit, and vice versa.

## Dialing from the Directory

Make sure the unit is in the standby mode initially.

### With the handset

- 1 Press or to enter the directory list.

```
Directory list
▼▲
▶=Caller's list
```

- 2 Press or .
- The first item is displayed.
- 3 Press or repeatedly to find the directory item that you want to dial.
  - To search for the item by initial, see page 50.
  - To exit the directory, press **OFF**.
- 4 Press or .
- The number is dialed automatically.

### With the base unit

- 1 Press or to enter the directory list.

```
Directory list
▼▲
▶=Caller's list
```

- 2 Press or .
- The first item is displayed.
- 3 Press or repeatedly to find the directory item that you want to dial.
  - To search for the item by initial, see page 50.
  - To exit the directory, press **EXIT** or **STOP**.
- 4 Press **DIGITAL SP-PHONE**.
- The number is dialed automatically.



## ➔ Using the Directory

### Editing an Item in the Directory

You can edit a name and phone number of a stored item and change the group setting (p. 45).

**Programming must be carried out with the handset.**



**Make sure the unit is in the standby mode initially.**

1 Press  or  to enter the directory list.

```
Directory list
▼▲
▶=Caller's list
```

2 Press  or .

•The first item is displayed.



3 Press  or  repeatedly to find the directory item you want to change, and press .

```
Jane
1234567
```

•To search for the item by initial, see page 50.

•If you do not need to change the name, go to step 5.

```
Enter name
Jane
◀▶          ▼=Next
```

4 Edit the name using the dialing buttons,  or  (p. 48), up to 15 characters.

```
Enter name
Jane Walker
◀▶          ▼=Next
```

5 Press  (Next key).

•If you do not need to change the number, go to step 7.

```
1|1234567
◀▶          ▼=Next
```

6 Add a number to the current number.

•Pressing **CLEAR** erases the digit to the left of the cursor. To erase all digits, press and hold **CLEAR**.

```
0981|234567
◀▶          ▼=Next
```

7 Press  (Next key).

```
Set group
:Off
◀▶          ▼=Next
```

8 To turn the call group feature on, select "On" by pressing  or .

If not required, select "Off".

•When "On" is selected, the display will light in orange and a different ringer pattern will be heard. When "OFF" is selected, an ordinary ringer pattern will be heard.

```
Set group
:On
◀▶          ▼=Next
```

- 9 Press **▼** (Next key).
- If you want to change the storing name, number or group setting, press **▲** (Edit key) repeatedly to reach the desired display and change it.

```
Jane Walker
0981234567
▲=Edit      ▶=Save
```

- 10 Press **▶** (Save key).
- A beep sounds.
  - To continue editing other items, repeat from step 3.
  - To return to the standby mode, press **OFF**.

```
Jane Walker
0981234567
```

- You can exit the programming mode any time by pressing **OFF**.

## Erasing an Item from the Directory

### With the handset/base unit

You can erase an item using the handset or the base unit.

**Make sure the unit is in the standby mode initially.**

- 1 Press **◀** or **▶** to enter the directory list.

```
Directory list
▼▲
▶=Caller's list
```

- 2 Press **▼** or **▲**.
- The first item is displayed.

- 3 Press **▼** or **▲** repeatedly to find the directory item you want to erase.
- To search for the item by initial, see page 50.

```
Helen
1234567890
```

- 4 Press **CLEAR**.
- To stop erasing, press **◀** (No key).

```
Clear?
◀=No      ▶=Yes
```

- 5 Press **▶** (Yes key) or **CLEAR**.
- A beep sounds and the item is erased.
  - To erase other items, repeat from step 3.
  - To return to the standby mode, if using the handset, press **OFF**. If using the base unit, press **EXIT** or **STOP**.

```
Clear
```

# Intercom

A 2-way intercom is possible between the handset and the base unit.

## Paging the base unit from the handset

- 1** Handset:  
Press **INTERCOM**. Talk to the paged party after the beeps.  
•“Intercom” is displayed.
- 2** Base unit:  
When the other party's voice is heard, answer using the **MIC**.
- 3** Handset:  
To end the intercom, press **OFF**.

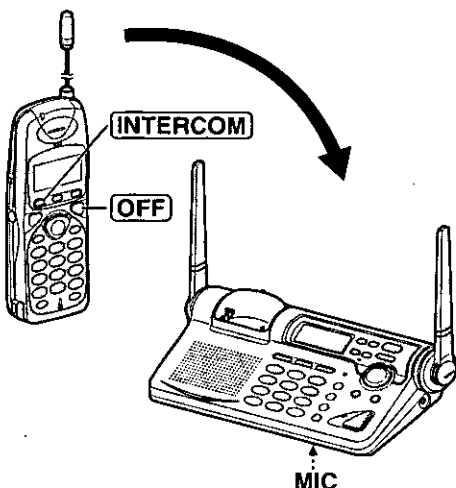



## Paging the handset from the base unit (Handset locator)

Using this feature, you can locate a misplaced handset.

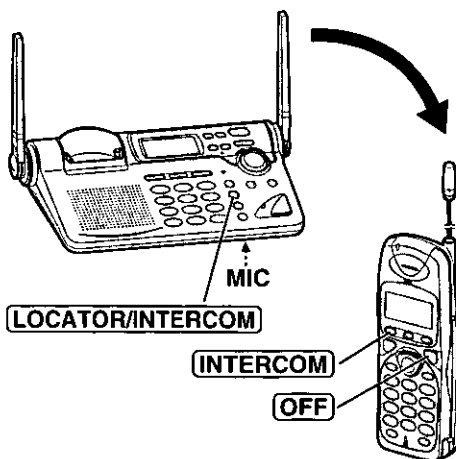
- 1** Base unit:  
Press **LOCATOR/INTERCOM**.  
•“Paging” is displayed on the base unit.  
•The handset beeps for 1 minute and “Paging Press INTERCOM” is displayed.  
•To stop paging, press **LOCATOR/INTERCOM** again.
- 2** Handset:  
Press **INTERCOM** to answer.  
•“Intercom” is displayed.
- 3** Base unit:  
Talk into the **MIC**.
- 4** Handset:  
To end the intercom, press **OFF**.





**During an intercom call:**

- Intercom calls can only be ended with the handset.
- If the handset user has difficulty hearing the base unit user, decrease the base unit speaker volume by pressing .
- If an incoming call is received, the intercom call stops and the unit starts to ring. To answer, if you are using the handset, press  or . If you are using the base unit, press **DIGITAL SP-PHONE**.



## Transferring a Call Using the Intercom

The intercom can be used during a call. This feature enables you to transfer a call between the handset and the base unit.

### From the handset to the base unit

- 1 Handset:**  
During a call, press **INTERCOM**. Talk to the paged party after the beeps.
  - The call is put on hold and "Intercom hold" is displayed.
  - If the base unit user does not answer, press  or .
- 2 Base unit:**  
When the paging party's voice is heard, answer using the **MIC**.
- 3 Base unit:**  
To answer the call, press **DIGITAL SP-PHONE**.
  - The transfer is complete.

### From the base unit to the handset

- 1 Base unit:**  
During a call, press **LOCATOR/INTERCOM**.
  - The call is put on hold and "Paging" is displayed.
  - If the handset user does not answer, press **DIGITAL SP-PHONE**.
- 2 Handset:**  
Press **INTERCOM** to answer the page.
  - "Intercom hold" is displayed.
- 3 Handset:**  
To answer the call, press  or .
  - The transfer is complete.

# Special Features

---

## Automatic Security Code Setting

Each time you place the handset on the base unit, the unit automatically selects one of more than a million security codes. These codes help prevent the unauthorized use of your telephone line by another cordless telephone user.

## For Call Waiting Service Users

Press **FLASH/CALL WAIT/PLAYBACK** or **FLASH/CALL WAIT** if you hear a call-waiting tone while talking.

- The first call is put on hold and you can answer the second call.
- To return to the first caller, press **FLASH/CALL WAIT/PLAYBACK** or **FLASH/CALL WAIT** again.
- The call waiting service cannot be used when:
  - the answering system is recording someone's message, or
  - a parallel connected telephone is in use.
- If this function does not operate properly, consult your telephone company for details.

## Call Waiting Caller ID Feature

Call Waiting Caller ID Feature allows your unit to display the second caller's information. After you hear a call-waiting tone while talking, the unit will display the caller's name with the phone number and "----Waiting----".

BROWN, NANCY 1-000-222-3333 ----Waiting----
---------------------------------------------------

- Please contact your telephone company for details and availability in your area.
- A second caller name will not be announced even if the Talking Caller ID feature is ON (p. 17).

## How to Use the PAUSE Button (For Analog PBX Line/Long Distance Service Users)

We recommend you press **REDIAL/PAUSE** or **PAUSE** if a pause is required for dialing with a PBX or to access a long distance service.

Ex. Line access number **9** (PBX)

**9** → **REDIAL/PAUSE** or **PAUSE** → Phone number

- Pressing **REDIAL/PAUSE** or **PAUSE** once creates a 3.5 second pause. This prevents misdialing when you redial or dial a stored number.
- Pressing **REDIAL/PAUSE** or **PAUSE** more than once increases the length of the pause between numbers.



## Temporary Tone Dialing (For Rotary or Pulse Service Users)

Press **[TONE]** before entering access numbers which require tone dialing.

- The dialing mode changes to tone. You can enter numbers to access an answering service, electronic banking service, etc. When you hang up, the mode will return to pulse.
- Access numbers entered after pressing **[TONE]** will not be included when redialing.

## FLASH Button

Pressing **[FLASH/CALL WAIT/PLAYBACK]** or **[FLASH/CALL WAIT]** allows you to use special features of your host PBX such as transferring an extension call or accessing special telephone services (optional) such as call waiting.

### Selecting the flash time

The flash time depends on your telephone exchange or host PBX. You can select the following flash times: "700, 600, 400, 300, 250, 110, 100 or 90 ms (milliseconds)". Your phone comes from the factory set to "700 ms". **Make sure the unit is in the standby mode initially.**

- 1 Press **[FUNCTION/CH]**.
- 2 Press **[▼]** or **[▲]** repeatedly until the arrow points to "Program", and press **[▶]** (Yes key).
- 3 Press **[▼]** or **[▲]** repeatedly until the arrow points to "Set flash time", and press **[▶]** (Yes key).
 

Save DIRECT#
▶Set flash time
▼▲ ▶=Yes
- 4 Press **[▼]** or **[▲]** repeatedly until the desired time is displayed, and press **[▶]** (Save key).
 

Flash time
: 700ms
▼▲ ▶=Save

  - A beep sounds.
  - To return to the standby mode, press **[OFF]**.

- You can exit the programming mode any time by pressing **[OFF]**.
- If you are connected via a PBX, a longer flash time may be necessary to use PBX functions (transferring a call etc.). Consult your PBX supplier for the correct setting.

# Automatic Answering Operation

When the unit answers a call, a greeting message is played and the caller's message is recorded. While recording, "– Answering –" will flash on the base unit display.

- The total recording time (including greeting message) is **about 15 minutes**. If messages are recorded in noisy rooms, the time may be shortened by up to 3 minutes.
- A maximum of 64 messages (including greeting message) can be recorded.

## Setting the Unit to Answer Calls

Press **ANSWER ON** to turn on the answering system.

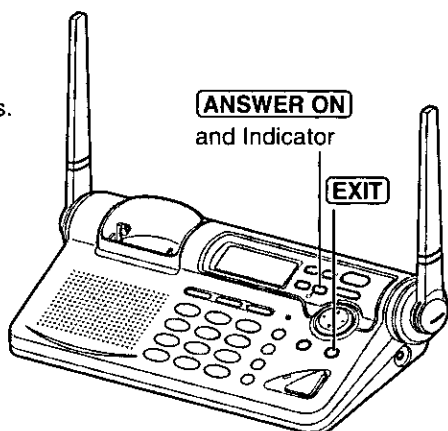

- The indicator lights and "Answer set" is heard.
- The unit will announce the remaining recording time if it is less than 5 minutes.
- If you hear "Memory full", "Message full" is displayed on the base unit and the ANSWER ON indicator flashes rapidly, erase some, or all, of the messages (p. 61).





- If you do not want the unit to answer calls, press **ANSWER ON** again to turn off the answering system. The indicator light goes out and "Answer off" is heard.
- You can also turn on the answering system remotely using any other phone (p. 73).

## Monitoring incoming calls

While a call is being recorded, you can monitor it through the base unit speaker.

To answer the call with the base unit speakerphone, press **DIGITAL SP-PHONE**. For the handset, press  or . The unit stops recording.

If the call monitoring feature is not required, turn it off by pressing and holding **EXIT** in the standby mode. Each time you press and hold **EXIT** in the standby mode, the feature will turn on or off.

While monitoring a call, you can turn the feature ON by pressing  or .

# Listening to Messages



You can see the total number of recorded messages on the base unit display. If the ANSWER ON indicator flashes, new messages have been recorded.

## Listening to only new messages

Press **NEW MESSAGE** briefly.

- The unit announces the number of new messages and plays them back.

## Listening to all recorded messages

Press and hold **NEW MESSAGE** until playback starts.

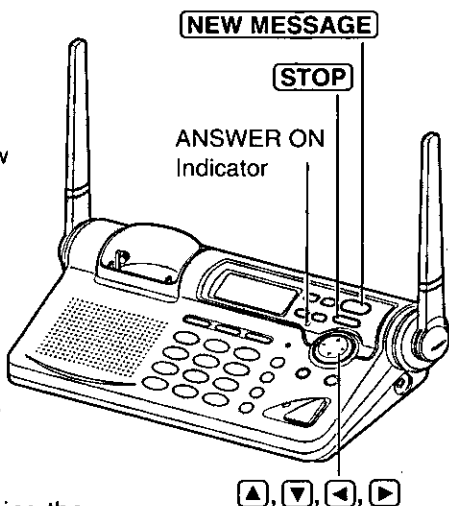

## To adjust the speaker volume:

9 levels (0–8) are available while using the answering system. To increase, press **▲**.

To decrease, press **▼**.

- During each message playback, the message number is displayed. (Ex. While the first message is being played back, “- Message 1 -” is displayed.)
- At the end of the last message, “End of final message” is heard. The unit will announce the remaining recording time if it is less than 5 minutes.

## During playback

To repeat message

To repeat from the beginning of the message

Press **◀**.

- If you press within 5 seconds of playback, the previous message will be played.

To skip message

To skip to the next message

Press **▶**.

To stop operation

Press **STOP**.

- To resume playback, press **NEW MESSAGE**.
- If you do not press any button for 60 seconds or if you press **STOP** again, the unit will return to the standby mode.

## ➔ Listening to Messages

### For Caller ID service users (p. 34)

During playback, the base unit display will show the name and/or number of the caller whose message is being played.

SMITH, JACK 1-222-333-4444 - Message 3 -
------------------------------------------------

#### To call back the displayed number:

During playback, press **(DIGITAL SP-PHONE)**.

- The unit stops playback and automatically dials the displayed phone number.
- After listening to new incoming messages, "✓" will be added to the call entries in the Caller ID Caller List (p. 38).

## From the Handset

If someone else is in the room and you want to listen to the recorded messages privately, you can use the handset.

### 1 Handset:

Press **(FLASH/CALL WAIT/PLAYBACK)**.

- The number of new messages is heard on the handset.

### 2 Base unit:

To listen to new messages, press **(NEW MESSAGE)** briefly. To listen to all messages, press and hold **(NEW MESSAGE)** until playback starts.

- The messages will be heard on the handset.
- (◀)**, **(▶)** and **(STOP)** can also be used during playback (p. 59).



### 3 When finished, press

**(FLASH/CALL WAIT/PLAYBACK)**

or place the handset on the base unit.

- You can also listen to messages without using the base unit. See page 74.

# Erasing Messages

The unit will announce the remaining recording time after playback, if it is less than 5 minutes. New messages cannot be recorded when:

- “Memory full” is heard.
- “Message full” flashes on the base unit display.
- the ANSWER ON indicator flashes rapidly.

Erase some, or all, of the messages. We recommend you erase unnecessary messages after each playback.

## Erasing a specific message

Press **ERASE** while the message you want to erase is being played.

- The unit erases the message.
- A short beep will sound and the unit will continue to play the next message.

## Erasing all messages

All recorded messages, except the greeting message, can be erased at one time.

- 1 Press **ERASE**.
  - “Press ERASE again to erase all messages” is heard.
- 2 Within 5 seconds, press **ERASE** again.
  - A beep sounds and “No messages” is heard.
  - The base unit display shows “0 message”.

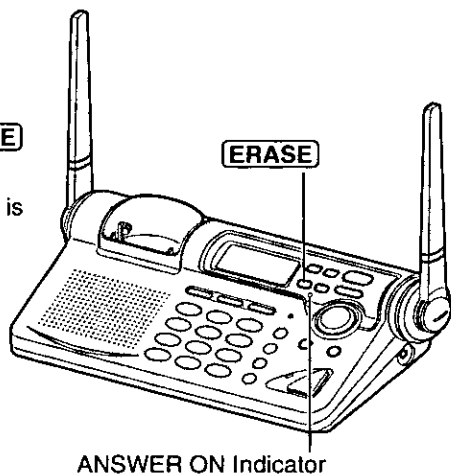

- The information in the Caller List will not be erased. To erase Caller List information, see page 42.

# Pager Call

This feature allows you to alert your pager when the unit records an incoming message or receives a Caller ID call (p. 66). You can retrieve the message from a touch tone telephone (p. 68). If you subscribe to a Caller ID service, the caller's telephone number will be displayed on your pager. First program the following settings (p. 62–66), then set the unit to call the pager. **Use the handset near the base unit.**

**Make sure that the unit is in the standby mode initially.**

## Storing a Pager Number

If you use a 1-800 pager number, see the next page for the storing procedure.

1 Press **FUNCTION/CH**.

2 Press **▼** or **▲** repeatedly until the arrow points to "Program".

▶Program
Calling pager
▼▲ ▶=Yes

3 Press **▶** (Yes key).

▶Save DIRECT#
Set flash time
▼▲ ▶=Yes

4 Press **▼** or **▲** repeatedly until the arrow points to "TAD program".

Set dial mode
▶TAD program
▼▲ ▶=Yes

5 Press **▶** (Yes key).  
•The base unit display shows programming options.

Answering system setting. See base unit.
------------------------------------------------

6 Press **#**.

Base unit display
Enter pager no.

7 Enter your pager number, and press **REDIAL/PAUSE** twice.\* Enter the access code, if required by your pager company, and press **REDIAL/PAUSE** twice again.\*

- The entered number is displayed on the base unit.
- If you misdial, press **CLEAR** and enter the correct number.
- You can enter a total of 44 digits.



- 8** Press  (Save key).
- A beep sounds.
  - To return to the standby mode, press **OFF**.

\* Pager companies require a delay after the pager number and/or the access code is dialed. Contact your pager company regarding the required pause time. Pressing **REDIAL/PAUSE** once creates a 3.5 second delay and counts as one digit.

- If the line has rotary or pulse service, press **STONE** between the pager number and **REDIAL/PAUSE** in step 7.

## Storing a 1-800 pager number

If you use a 1-800 pager number with a PIN code, store the pager number as follows.

- 1** Follow steps 1 through 6 on page 62.
- 2**
- ① Enter the 1-800 pager number, and press **REDIAL/PAUSE** 3 times.\*
  - ② Enter the PIN code, and press **REDIAL/PAUSE** twice.\*
- The entered number is displayed on the base unit.
  - If you misdial, press **CLEAR** and enter the correct number.
  - You can enter a total of 44 digits.
- 3** Press  (Save key).
- A beep sounds.
  - To return to the standby mode, press **OFF**.

\* Pager companies require a delay after the pager number and the PIN code are dialed. Contact your pager company regarding the required pause time. Pressing **REDIAL/PAUSE** once creates a 3.5 second delay and counts as one digit.

- If the line has rotary or pulse service, press **STONE** between the pager number and **REDIAL/PAUSE** in step 2.
- Alphanumeric voice dispatch pager services will not work with this function.

## ➔ Pager Call

### Storing Your Home Telephone Number

After storing your home telephone number, it will then be displayed on your pager when your family wants you to call home. (See useful information on page 65.)

1 Press **FUNCTION/CH**.

2 Press **▼** or **▲** repeatedly until the arrow points to "Program".

▶Program
Calling pager
▼▲ ▶=Yes

3 Press **▶** (Yes key).

▶Save DIRECT#
Set flash time
▼▲ ▶=Yes

4 Press **▼** or **▲** repeatedly until the arrow points to "TAD program".

Set dial mode
▶TAD program
▼▲ ▶=Yes

5 Press **▶** (Yes key).

- The base unit display shows programming options.

Answering system setting.
See base unit.

6 Press **7**.

Base unit display

Enter home no.:
-----------------

7 Enter your home telephone number up to 11 digits.

- The entered number is displayed on the base unit.
- If you misdial, press **CLEAR** and enter the correct number.

8 Press **▶** (Save key).



- A beep sounds.
- To return to the standby mode, press **OFF**.

•Your pager will also display your home number if the unit receives a call from an area which does not provide the Caller ID service or the caller requests not to show their information. Please call home to check who alerted your pager.







## To confirm the stored pager and home numbers

1. Press **FUNCTION/CH**.
2. Press **▼** or **▲** to select "Calling pager".
3. Press **▶** (Yes key).
4. Press  or .
  - The unit dials the stored pager number.
  - The pager beeps, and displays your home number and "11".
  - If the pager does not beep or does not display your home number and "11", store the pager and home numbers again (p. 62–64).
5. When finished, press **OFF**.

### Useful Information

Your family can let you know when they want you to call home as follows:

Press **FUNCTION/CH** → **▼** or **▲** to select "Calling pager" → **▶** (Yes key) →  or .

### \* What "11" means

When your unit alerts your pager, "11" will be displayed after the caller's telephone number. "11" will not be displayed when another phone alerts your pager.

**Ex. When the unit records a caller's message whose number is "2345678":**

"234567811" will be displayed on your pager. If you select pager mode "Received call" (p. 66) and a caller does not leave a message, "00" will be displayed instead of "11".

**Ex. When the caller whose number is "2345678" alerts your pager directly:**

"2345678" will be displayed on your pager.

## To erase the stored pager number

Follow steps 1 through 6 on page 62. → **CLEAR** → **▶** (Save key) → **OFF**.

•The pager call mode will automatically return to OFF (p. 67).

## To erase the stored home telephone number

Follow steps 1 through 6 on page 64. → **CLEAR** → **▶** (Save key) → **OFF**.

## Pager Mode Setting

After subscribing to a Caller ID service (p. 34), you can select one of the following pager mode settings. The unit will alert your pager:

**Recorded MSG:** After the unit records an incoming message (factory preset),

OR

**Received call:** Each time the unit receives a Caller ID call, even if the caller does not leave a message.

If you want to change the mode, proceed as follows.

- 1 Press **FUNCTION/CH**.
- 2 Press **▼** or **▲** repeatedly until the arrow points to "Program".
- 3 Press **▶** (Yes key).
- 4 Press **▼** or **▲** repeatedly until the arrow points to "TAD program".
- 5 Press **▶** (Yes key).
  - The base unit display shows programming options.
- 6 Press **6**.
  - The current setting is displayed on the base unit.
- 7 To select "**Received call**", press **2**.  
OR  
To select "**Recorded MSG**", press **1**.
- 8 Press **▶** (Save key).
  - A beep sounds.
  - To return to the standby mode, press **OFF**.

```
▶Program
  Calling pager
▼▲                               ▶=Yes
```

```
▶Save DIRECT#
  Set flash time
▼▲                               ▶=Yes
```

```
Set dial mode
▶TAD program
▼▲                               ▶=Yes
```

```
Answering
system setting.
See base unit.
```

Base unit display

```
Pager mode
:Recorded MSG
```

Base unit display

```
Pager mode
:Received call
```

- If you select "**Received call**" and set the unit to call your pager (p. 65), the unit will alert your pager even if the answering system is not turned on.
- If you select "**Received call**", and a Call ID call is received with no telephone number, the unit will only alert your pager if the caller leaves a message.

## Setting the Unit to Call a Pager

1 Press **FLASH/CALL WAIT/PLAYBACK**.

- The number of new messages is heard on the handset.

2 Press **3**.

- “**PAGER**” is displayed on the base unit.
- If “**PAGER**” is not displayed, the pager number has not been stored. Store the number (p. 62, 63), and try again.

3 Press **FLASH/CALL WAIT/PLAYBACK**.

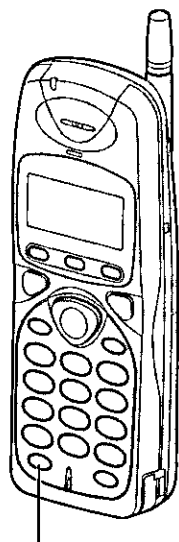

**FLASH/CALL WAIT/PLAYBACK**

**To turn off the pager call mode, repeat steps 1 through 3.**

- “**PAGER**” will disappear.
- Each time you press **3** in step 2, the mode will turn on or off.

If you have not subscribed to a Caller ID service, the caller's telephone number will not be displayed on your pager.

- If another message (or Caller ID call) is received before the unit alerts your pager for a previous message (or Caller ID call), the previous caller information will not be sent to your pager. Only the last call received will be sent to your pager.
- If someone else makes or answers another call with the unit or a parallel connected phone before the unit alerts your pager for a previous message (or Caller ID call), the unit will stop alerting your pager for that message (or Caller ID call).
- If you receive a telephone number on your pager but cannot recognize the caller, you may have received a direct inward dial (DID) call, such as from a PBX. Please call your unit to check the caller's message.

# Remote Operation from a Touch Tone Phone

You can operate the answering system from any touch tone phone. A synthesized voice menu will guide you on how to operate the unit (p. 70).

- To skip the voice menu and operate the unit directly, see page 72.

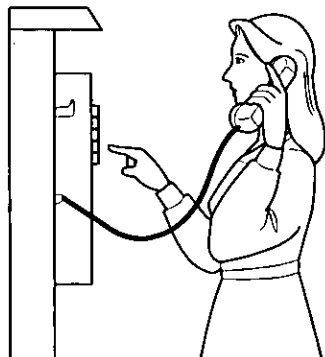

## Summary of remote operation

Call your unit from a touch tone phone.



Enter your remote code (p. 69) during or after the greeting message.  
•The number of new messages is heard.



After 3 seconds, the voice menu will start (p. 70).  
Follow the menu or enter the direct commands (p. 72).



To end remote operation, hang up.  
•The messages are saved.

- The unit will announce the remaining recording time after playback, if it is less than 5 minutes.



## Setting the Remote Code

The remote code prevents unauthorized people from accessing your unit and listening to your messages. Choose any **2-digit number (00–99)**. The factory preset remote code is “11”. If you do not program your own remote code, you can use “11”.

**Use the handset near the base unit. Make sure the unit is in the standby mode initially.**

1 Press **FUNCTION/CH**.

2 Press **▼** or **▲** repeatedly until the arrow points to “Program”.

▶Program	
Calling pager	
▼▲	▶=Yes

3 Press **▶** (Yes key).

▶Save DIRECT#	
Set flash time	
▼▲	▶=Yes

4 Press **▼** or **▲** repeatedly until the arrow points to “TAD program”.

Set dial mode	
▶TAD program	
▼▲	▶=Yes

5 Press **▶** (Yes key).

- The base unit display shows programming options.

Answering system setting.
See base unit.

6 Press **1**.

- The current remote code is displayed on the base unit.

Base unit display

Remote code	:11
-------------	-----

7 Enter a remote code using a **2-digit number (00–99)**.

8 Press **▶** (Save key).

- A beep sounds.
- To return to the standby mode, press **OFF**.

•If 6 beeps sound during programming, a wrong key was pressed. Enter the correct number.

### To check the remote code

Repeat steps 1 to 6.

•The current remote code is displayed on the base unit. When finished, press **OFF**.

# ➔ Remote Operation from a Touch Tone Phone

---

## Voice Menu

The shaded boxes are voice prompts.

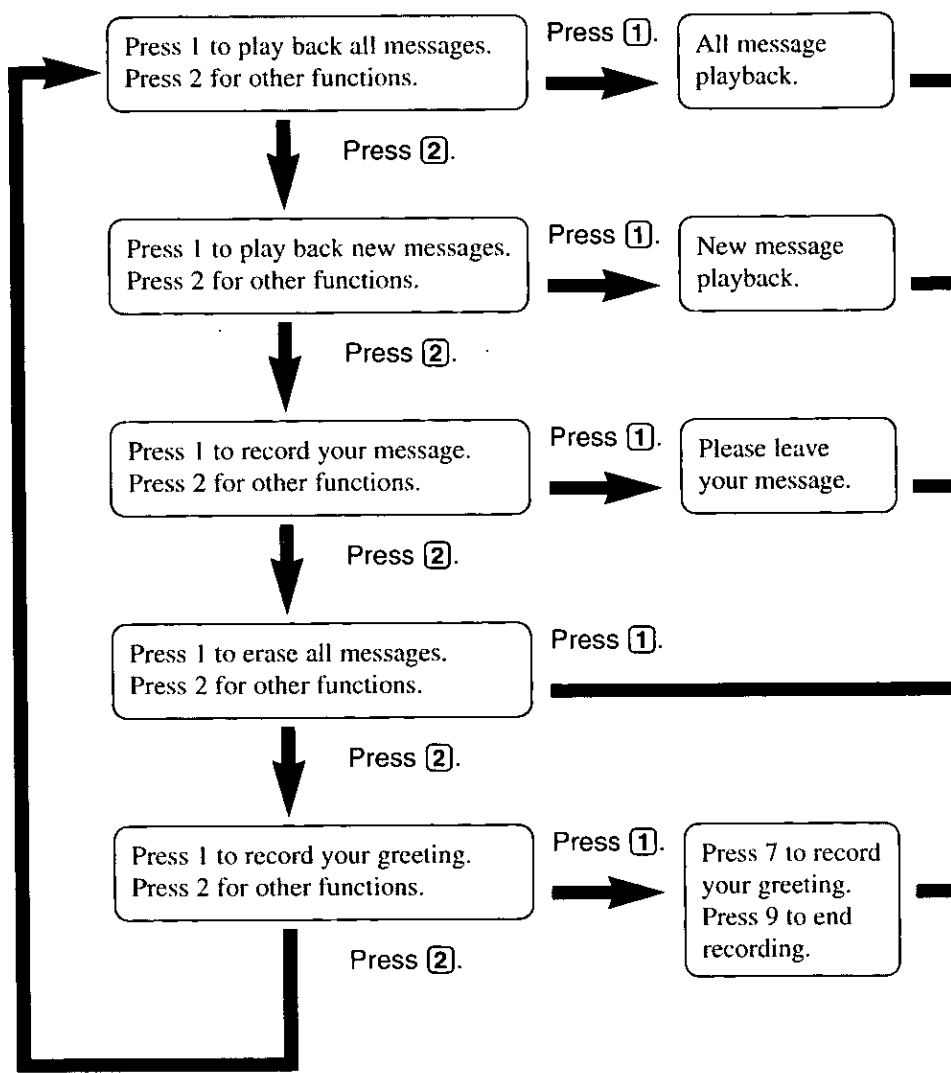



### **All Message Playback**

All recorded messages are played back. At the end of the last message, "End of final message" is heard. The unit will announce the remaining recording time if it is less than 5 minutes.

### **New Message Playback**

Only new messages are played back. At the end of the last message, "End of final message" is heard. The unit will announce the remaining recording time if it is less than 5 minutes.

### **Recording a Memo Message**

You can leave a personal message.

1. Talk after you hear "Please leave your message".
2. When you finish recording, hang up.

### **Erasing All Messages**

All recorded messages (except greeting message) are erased.

### **Recording a Greeting Message**

You can re-record your greeting message.

1. Press **7**.  
You will hear a voice prompt followed by a long beep.
2. After the beep, talk for up to 2 minutes.
3. When you finish recording, press **9**.
4. Your greeting will be played back for confirmation.

- 3 seconds after playback, the voice menu will start again from the beginning.
- if you hear "Memory full" after playback, erase some, or all, of the messages (p. 72).

## ➔ Remote Operation from a Touch Tone Phone

---

### Direct Remote Operation

Once you have entered the remote code, you can also control your unit by direct commands instead of using the voice menu. To end the remote operation, hang up anytime.

#### Direct commands

---

NEW MESSAGE PLAYBACK      **4**      •Only new messages are played back.

---

ALL MESSAGE PLAYBACK      **5**      •All messages are played back.

---

REPEAT  
(During playback)      **1**      •The current message is repeated.

---

SKIP  
(During playback)      **2**      •The current message is skipped.  
The next message is played.

---

STOP      **9**      •Operation is stopped temporarily.  
•To resume operation, enter a direct command within 15 seconds, or the voice menu will start.

---

GREETING MESSAGE RECORDING      **7**      •A long beep sounds.  
↓  
RECORD      •After the beep, talk immediately for up to 2 minutes.  
↓  
**9**      •The recording is stopped.  
•The recorded message is played.

---

ERASING A SPECIFIC MESSAGE  
(During playback)      **\*** **4**      •The current message is erased.  
•A short beep will sound and the next message will be played.

---

ERASING ALL MESSAGES      **\*** **5**      •All recorded messages are erased.  
•A long beep sounds and "No messages" is heard.

---



---

PAGER CALL  
ON/OFF

**3**

- Each time you press **3**, "On/Off" is heard and the mode will turn on or off.
- If you have not stored a pager number, 6 beeps will sound and the mode will not turn on.

---

ANSWERING  
SYSTEM OFF

**0**

- The unit hangs up and will not answer calls until turned on again.
- 

## Turning on the answering system

Call your unit and wait for 15 rings.

- The unit will answer and the greeting message will be played.
- The answering system will turn on. Hang up or enter the remote code for other options.
- When turning on the answering system using a rotary or pulse service telephone, you cannot enter the remote code for other options.

## Skipping the greeting message

After calling your unit, press **\*** during the greeting message.

- The unit skips the rest of the greeting message and you can start recording your message after the long beep.

# Remote Operation with the Handset

You can operate your answering system with the handset.

The announcements and recorded messages can only be heard with the handset.

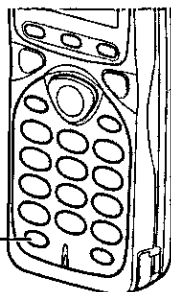

**FLASH/CALL WAIT/PLAYBACK**

## Summary of remote operation

Press **FLASH/CALL WAIT/PLAYBACK**.

- The number of new messages is heard.
- "Remote operation" is displayed on the handset.





Enter the desired direct commands (p. 75).

- If you do not enter a command, the voice menu will start (see below).
- After the voice menu, all message playback will start.



To end remote operation, press **FLASH/CALL WAIT/PLAYBACK**.

- The messages are saved.

- The unit will announce the remaining recording time after playback, if it is less than 5 minutes.
- If the unit starts to ring during the remote operation, press  or  to answer the call. The remote operation is ended.
- If you hear "Memory full" after playback, erase some, or all, of the messages (p. 75).

## Voice menu

If no commands are entered after you press **FLASH/CALL WAIT/PLAYBACK**, the unit will start the following voice menu.

"Press 4 to play back new messages. Press 5 to play back all messages."

- You can enter direct commands even if the voice menu has started.

---

## Direct commands

---

NEW MESSAGE PLAYBACK	<b>4</b>	<ul style="list-style-type: none"><li>• Only new messages are played back.</li></ul>
ALL MESSAGE PLAYBACK	<b>5</b>	<ul style="list-style-type: none"><li>• All messages are played back.</li></ul>
REPEAT (During playback)	<b>1</b>	<ul style="list-style-type: none"><li>• The current message is repeated.</li><li>• You can also press <b>◀</b> to repeat a message.</li></ul>
SKIP (During playback)	<b>2</b>	<ul style="list-style-type: none"><li>• The current message is skipped. The next message is played.</li><li>• You can also press <b>▶</b> to skip a message.</li></ul>
STOP	<b>9</b>	<ul style="list-style-type: none"><li>• Operation is stopped temporarily.</li><li>• To resume operation, enter a direct command within 15 seconds, or the voice menu will start (p. 74).</li></ul>
ERASING A SPECIFIC MESSAGE (During playback)	<b>* 4</b>	<ul style="list-style-type: none"><li>• The current message is erased.</li><li>• A short beep will sound and the next message will be played.</li></ul>
ERASING ALL MESSAGES	<b>* 5</b>	<ul style="list-style-type: none"><li>• All recorded messages are erased.</li><li>• A long beep sounds and "No messages" is heard.</li></ul>
PAGER CALL ON/OFF	<b>3</b>	<ul style="list-style-type: none"><li>• Each time you press <b>3</b>, the mode will turn on or off.</li><li>• If you have not stored a pager number, "<b>PAGER</b>" will not be displayed on the base unit, and the mode will not turn on.</li></ul>
ANSWERING SYSTEM OFF	<b>0</b>	<ul style="list-style-type: none"><li>• "Answer off" is heard and the answering system is turned off.</li></ul>
ANSWERING SYSTEM ON	<b>8</b>	<ul style="list-style-type: none"><li>• "Answer set" is heard and the answering system is turned on.</li></ul>

---

# Wall Mounting

This unit can be mounted on a wall phone plate.

- 1 Connect the AC adaptor.

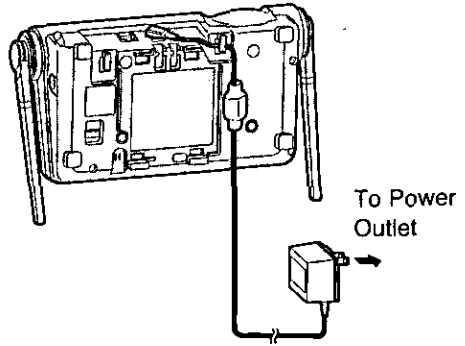

- 2 Tuck the telephone line cord inside the wall mounting adaptor, then push it in the direction of the arrow.
  - The word "UP" should face upward.

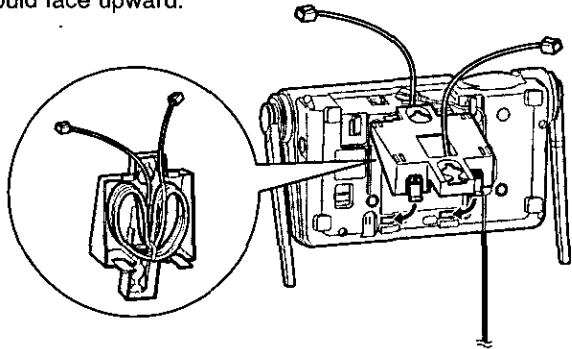

- 3 Connect the telephone line cord. Mount the unit, then slide down.
  - Raise the antennas.

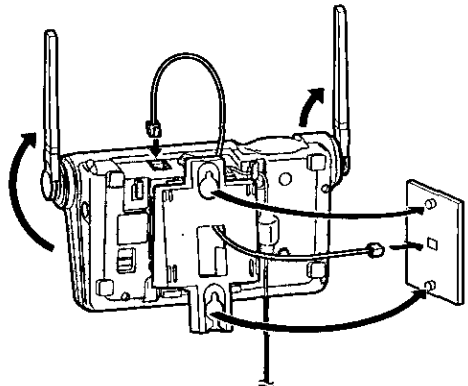

- 
- 4 To charge the handset battery:**  
Insert the handset in the cradle and adjust the angle of the cradle in the direction of the arrow as shown.

- The ringer/charge indicator lights.

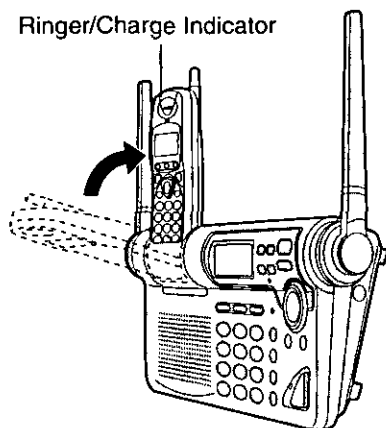

---

## Using the Belt Clip

---

You can hang the handset on your belt or pocket using the belt clip.

**To attach the belt clip**

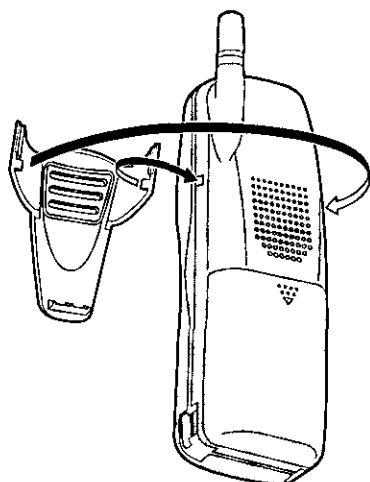

**To remove the belt clip**



# Using an Optional Headset

Plugging an optional headset into the handset or the base unit allows a hands-free phone conversation. Please use only the Panasonic KX-TCA88 headset. To order call the accessories telephone number on page 2.



## With the Handset

### Connecting the headset to the handset

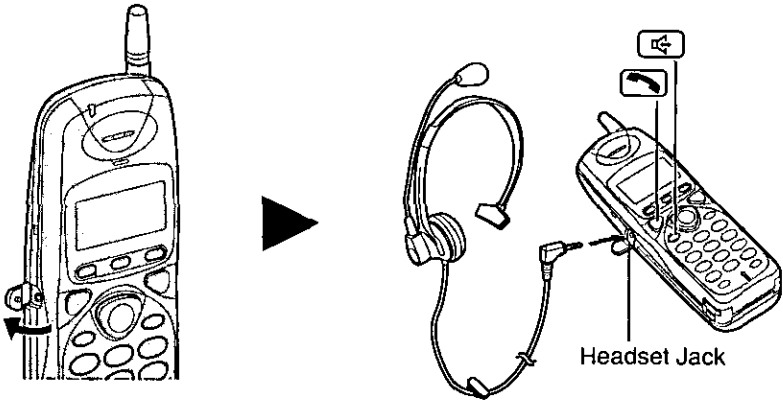
Open the headset jack cover, and connect the headset to the headset jack as shown below.



**To switch to the speakerphone while using the headset:**

Press . To return to the headset, press .

## With the Base Unit

### Connecting the headset to the base unit

Connect the headset to the headset jack as shown.

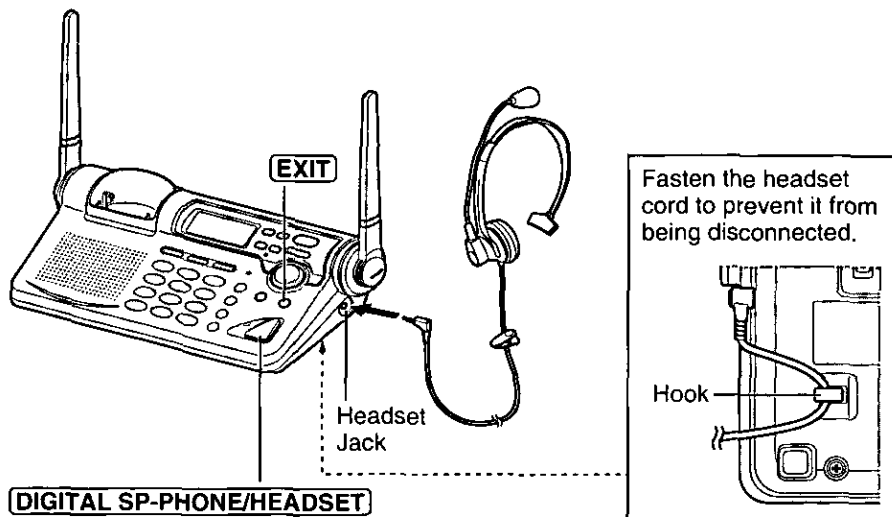

### Making/Answering calls

- 1 Press **DIGITAL SP-PHONE/HEADSET** to make or answer a call.
  - If you misdial when making a call, press **DIGITAL SP-PHONE/HEADSET** twice and dial again.
- 2 To hang up, press **DIGITAL SP-PHONE/HEADSET**.

### To adjust the headset receiver volume (High, Medium or Low):

While using the headset, press **▲** or **▼**.

#### To switch to the speakerphone while using the headset:

"EXIT=SP-phone" is displayed. Press **EXIT**.

To return to the headset, press **EXIT** again.

- Each time you press **EXIT**, the call will switch to the headset or speakerphone. While in the speakerphone mode, "EXIT=Headset" is displayed.

- During a conversation using the headset, you can switch the call to the handset by lifting it off the cradle.
- If you disconnect the headset during a conversation, you can continue the conversation with the speakerphone.

# Battery Replacement

If "Recharge battery" is displayed and/or "[ ■ ]" flashes after being fully charged, replace the battery with a new Panasonic HHR-P509 (PQHHR150AA23) battery. To order, call the accessories telephone number on page 2.

- 1 Remove the cover by sliding it up while pressing the arrow.

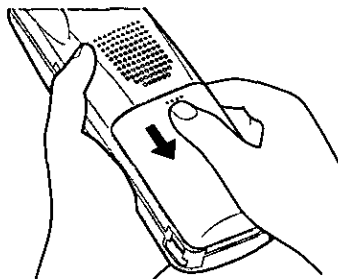

- 2 Remove the old battery. Then install the new one:

- ① Pinch the battery leads at the distance of about 10 mm from the battery plug with the red lead on the right and the black lead on the left.
- ② Insert the battery plug into the connector in the handset vertically.

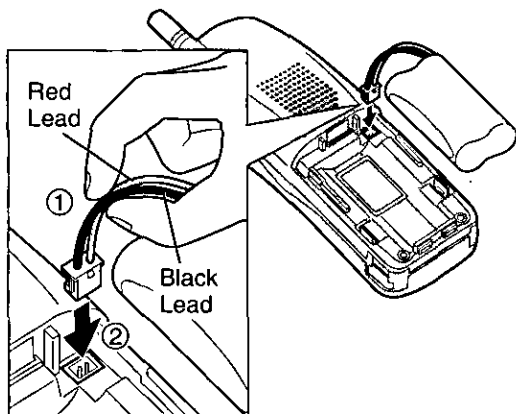

- ③ Press the plug with your finger tip to ensure it is firmly inserted.

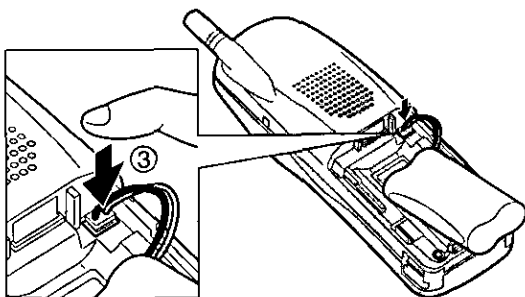

- 3 Close the cover. Make sure you charge the new battery for about 8 hours in order to display the battery strength prompt correctly (p. 11).



# Adding Another Phone

This unit will not function during a power failure. To connect a standard telephone on the same line, use the Panasonic T-adaptor KX-J66. To order, call the accessories telephone number on page 2.

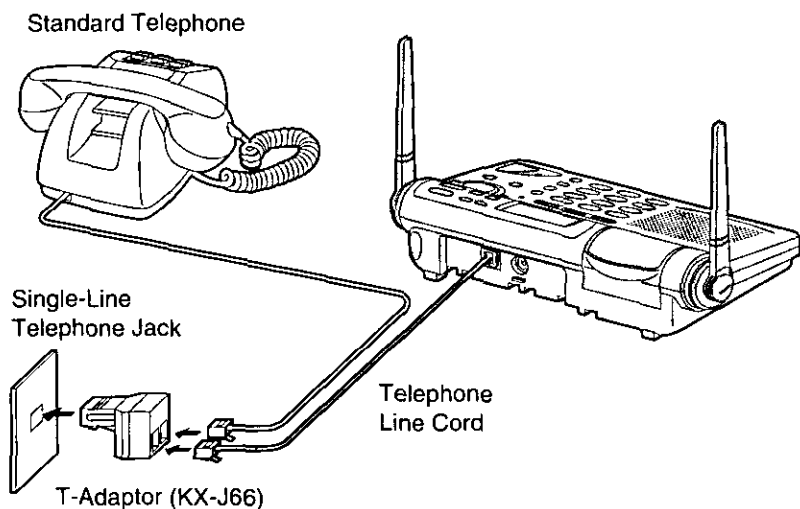

# Fashion Plate™ Snap-On Color Covers (Optional)

You can change the look of your phone's handset with optional Fashion Plate™ snap-on color covers, KX-TGA10. Three different color covers are included; brownstone, charcoal and wineberry. To order, contact your dealer or call 1-800-211-PANA(7262) to locate a dealer.

- 1 Remove the battery cover by sliding it up while pressing the arrow. Remove the battery.

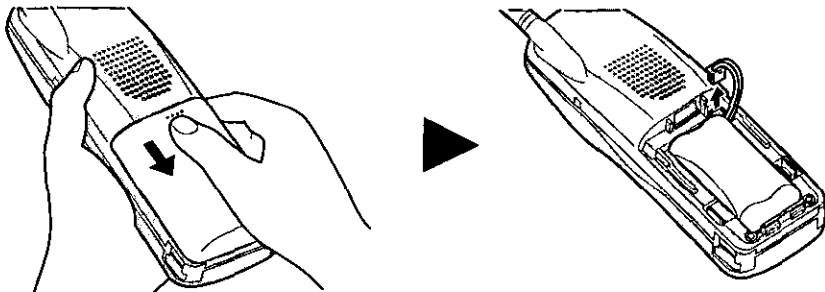

- 2 The color cover is held in place by the right and left tabs. Unlock one of the tabs by pressing horizontally (①) and vertically (②), and partially pull down the color cover (③, ④) as shown.

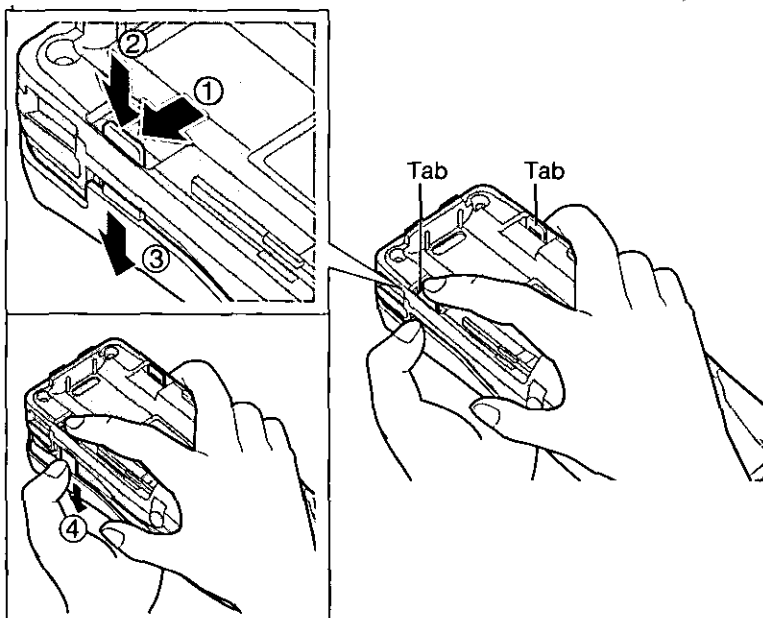

- 3** Unlock the other tab by pressing horizontally (①) and vertically (②), and partially pull down the color cover (③) in the same way. Completely remove the cover from the handset.

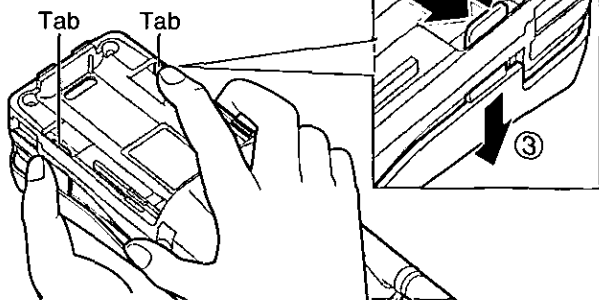

- 4** Place the new color cover, fitting the tabs on the cover into the slots on the handset.

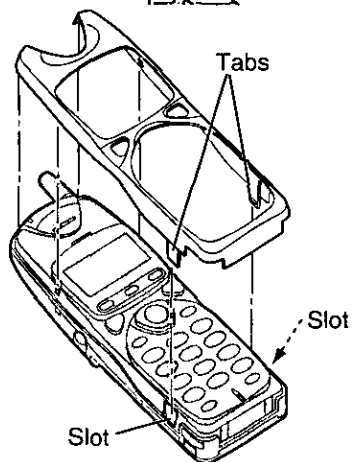

- 5** Snap the color cover shut on the lower (①), middle (②) and upper (③) parts of the handset.

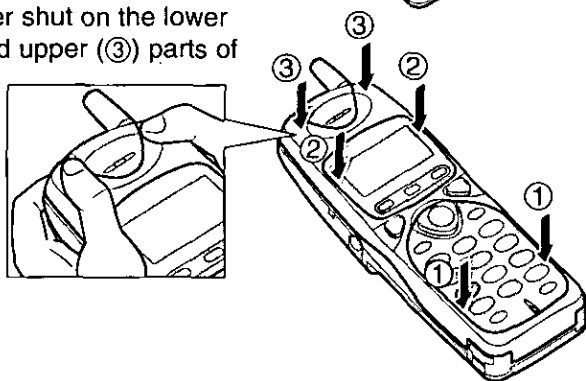

- 6** Connect the battery and close the battery cover (p. 80). Then insert the handset in the cradle until the ringer/charge indicator lights and a beep sounds.

# If the Following Appear...

---

If the unit detects a problem, one of the following messages will be displayed on the handset or the base unit.

## Handset display

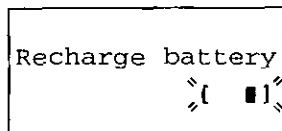



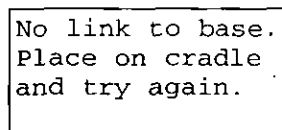

The battery needs to be charged. Insert the handset in the cradle to charge the battery (p. 11).

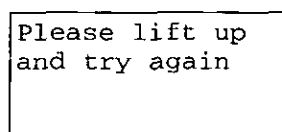

The handset has lost communication with the base unit. Insert the handset in the cradle and try again.



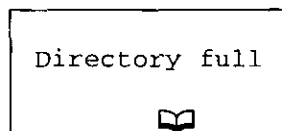

, ,  or  was pressed while the handset was on the base unit. Lift the handset and press the button again.

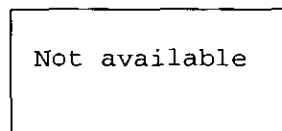

When trying to store an item or Caller List information in the directory, the directory memory is full (p. 41, 46). To erase other stored items from the directory, see page 53.



While the base unit was not in the standby mode,  or  was pressed to search the Caller List/directory list,  was pressed to select an option, or **INTERCOM** or **FLASH/CALL WAIT/PLAYBACK** was pressed.

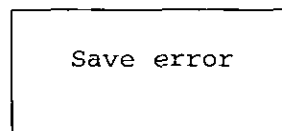

While storing items in the directory, the handset has lost communication with the base unit. Move closer to the base unit and try again.

## Base unit display

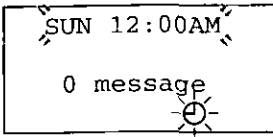

When the clock needs adjusting, the day and time flashes with “⌚”. Adjust the clock (p. 24).

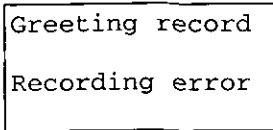

Your greeting message was not recorded correctly. Record it again (p. 20).

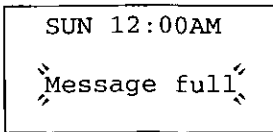



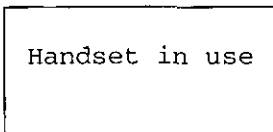







If message memory is full, “Message full” will flash. Erase some, or all, of the messages (p. 61).



The display will be shown when the handset is in use (making/answering a call, viewing the Caller List or directory list, listening to messages, etc.).

# Before Requesting Help

## Cordless Telephone



Problem	Remedy
"No link to base. Place on cradle and try again." is displayed and an alarm tone sounds.	<ul style="list-style-type: none"><li>•You are too far from the base unit. Move closer and try again.</li><li>•Insert the handset in the cradle and try again.</li><li>•Plug in the AC adaptor.</li><li>•Extend the handset antenna fully.</li><li>•Raise the base unit antennas.</li></ul>
Static, sound cuts in/out, fades. Interference from other electrical units.	<ul style="list-style-type: none"><li>•Locate the handset and the base unit away from other electrical appliances (p. 3).</li><li>•Move closer to the base unit.</li><li>•Extend the handset antenna fully.</li><li>•Raise the base unit antennas.</li><li>•Press <b>FUNCTION/CH</b> to select a clearer channel.</li></ul>
The handset and/or the base unit do not ring.	<ul style="list-style-type: none"><li>•The ringer volume is set to OFF. Set to HIGH or LOW (p. 18, 19).</li></ul>
The handset display is blank.	<ul style="list-style-type: none"><li>•The handset is in the standby mode (p. 9). Press , ,  or  to turn the display on.</li></ul>
The handset display is still blank after pressing  ,  ,  or  .	<ul style="list-style-type: none"><li>•Charge the battery fully (p. 11).</li></ul>
You cannot store a name and phone number in the directory.	<ul style="list-style-type: none"><li>•You cannot store an item in the directory while the unit is in the talk, speakerphone or intercom mode, or while the answering system is in use.</li><li>•Do not pause for over 60 seconds while storing.</li></ul>
While programming or searching, the unit starts to ring and stops the program/search.	<ul style="list-style-type: none"><li>•To answer the call, press ,  or <b>DIGITAL SP-PHONE</b>. Start again from the beginning after hanging up.</li></ul>



Problem	Remedy
The unit does not display the caller's name and/or phone number.	<ul style="list-style-type: none"><li>•You need to subscribe to a Caller ID service from a telephone company.</li><li>•Other telephone equipment may be interfering with your phone. Disconnect it and try again.</li><li>•Other electrical appliances connected to the same outlet may be interfering with the Caller ID information.</li><li>•Telephone line noise may be affecting the Caller ID information.</li></ul>
The unit does not announce the displayed caller's name.	<ul style="list-style-type: none"><li>•The handset and base unit ringer volumes are OFF (p. 18, 19).</li><li>•The Talking Caller ID feature is OFF (p. 17).</li></ul>
The handset or base unit display goes to the standby mode while viewing the Caller List.	<ul style="list-style-type: none"><li>•Do not pause for over 60 seconds while searching.</li></ul>
When a second call is received during a conversation, the unit does not display the new caller's name and/or phone number.	<ul style="list-style-type: none"><li>•The line mode selection is incorrect. See page 14.</li></ul>
You cannot page the handset or the base unit.	<ul style="list-style-type: none"><li>•The handset is too far from the base unit.</li><li>•The handset or the base unit is engaged in an outside call, viewing the Caller List/directory list or listening to messages. Try again later. If you are using the base unit, wait until "Handset in use" disappears.</li></ul>

## ➔ Before Requesting Help

---







Problem	Remedy
You cannot redial by pressing <b>REDIAL/PAUSE</b> or <b>REDIAL</b> .	<ul style="list-style-type: none"><li>• If the last number dialed was more than 32 digits long, the number will not be redialed correctly.</li><li>• Access numbers entered after pressing <b>STONE</b> will not be included when redialing.</li><li>• The <b>REDIAL/PAUSE</b> button on the handset has a double function as either redial or pause. It will redial the last number dialed if pressed at the outset of a call (p. 29). If another number has been dialed first, it will operate as a pause button (p. 56).</li></ul>
You cannot have a conversation using the headset.	<ul style="list-style-type: none"><li>• Make sure that the headset is connected properly (p. 78, 79).</li><li>•  may have been pressed. If the button lights, press  to continue the conversation with the headset.</li><li>• If "EXIT=Headset" is displayed on the base unit, press <b>EXIT</b> to switch from the speakerphone to the headset.</li></ul>

## Answering System

Problem	Remedy
The answering system is on, but incoming messages are not recorded.	<ul style="list-style-type: none"><li>• The recording time is set to "Greeting only". Select "1 minute" or "3 minutes" (p. 23).</li><li>• Memory is full. Erase some, or all, of the messages (p. 61).</li></ul>
You cannot listen to the recorded messages.	<ul style="list-style-type: none"><li>• Make sure that the unit is in the standby mode.</li></ul>
"Message full" flashes on the base unit display and the ANSWER ON indicator flashes rapidly, and no new messages are recorded.	<ul style="list-style-type: none"><li>• Memory is full. Erase some, or all, of the messages (p. 61).</li></ul>









Problem	Remedy
You cannot operate the answering system at the base unit.	<ul style="list-style-type: none"><li>•The handset user is operating the answering system, or is engaged in an outside call. Wait until "Handset in use" disappears.</li></ul>
You cannot operate the answering system from a touch tone phone.	<ul style="list-style-type: none"><li>•Make sure you enter the correct remote code.</li><li>•The answering system may not respond if the tones are too short to activate the unit. Press each button firmly.</li><li>•The answering system is off. Turn it on (p. 73).</li></ul>
You cannot operate the answering system with the handset.	<ul style="list-style-type: none"><li>•Someone is operating the answering system.</li><li>•You are too far from the base unit. Move closer to the base unit.</li><li>•The unit is recording a message. To answer the call, press  or .</li></ul>
While recording a greeting message, the unit starts to ring and stops recording.	<ul style="list-style-type: none"><li>•To answer the call, press <b>DIGITAL SP-PHONE</b> or press  or . Start again from the beginning after hanging up.</li></ul>
During playback, the unit starts to ring and stops playback.	<ul style="list-style-type: none"><li>•To answer the call, press <b>DIGITAL SP-PHONE</b> or press  or . To resume playback, press <b>NEW MESSAGE</b> after hanging up.</li></ul>
The base unit does not display the name and/or number of the caller whose message is being played.	<ul style="list-style-type: none"><li>•If the caller is not stored in the Caller List, the base unit will not display the caller's information.</li></ul>
The unit does not alert your pager.	<ul style="list-style-type: none"><li>•The line mode selection is incorrect. See page 14.</li></ul>

## Before Requesting Help

---

### General

Problem	Remedy
The unit does not work.	<ul style="list-style-type: none"><li>•Check the settings (p. 10–14).</li><li>•Charge the battery fully (p. 11).</li><li>•Clean the charge contacts and charge again (p. 12).</li><li>•Install the battery properly (p. 80).</li><li>•Insert the handset in the cradle and unplug the AC adaptor to reset. Plug in, and try again.</li><li>•Re-install the battery and insert the handset in the cradle (p. 80). Try again.</li></ul>
You cannot program items, such as the dialing mode.	<ul style="list-style-type: none"><li>•Programming is not possible while the unit is in the talk or speakerphone mode, when viewing the Caller List/directory list, or while the answering system is in use.</li><li>•Do not pause for over 60 seconds while programming.</li><li>•Move closer to the base unit.</li><li>•, ,  or  may have been pressed when you picked up the handset. Press <b>OFF</b> and try again.</li></ul>
Previously programmed information is erased.	<ul style="list-style-type: none"><li>•If a power failure occurs, programmed information may be erased. Reprogram if necessary.</li></ul>
“Recharge battery” is displayed on the handset, “[ ]” flashes or the unit beeps intermittently.	<ul style="list-style-type: none"><li>•Charge the battery fully (p. 11).</li></ul>
You charged the battery fully, but “Recharge battery” is still displayed and/or “[ ]” continues to flash.	<ul style="list-style-type: none"><li>•Clean the charge contacts and charge again (p. 12).</li><li>•Install a new battery (p. 80).</li></ul>

---

<b>Problem</b>	<b>Remedy</b>
The ringer/charge indicator light does not go out while charging.	•This is normal.
If you cannot solve your problem.	•Call our customer call center at 1-800-211-PANA(7262). •Panasonic's e-mail address for customer inquiries: consumerproducts@panasonic.com for customers in the USA or Puerto Rico ONLY

# Important Safety Instructions

---

When using this unit, basic safety precautions should always be followed to reduce the risk of fire, electric shock, or personal injury.

1. Read and understand all instructions.
2. Follow all warnings and instructions marked on this unit.
3. Unplug this unit from AC outlets before cleaning. Do not use liquid or aerosol cleaners. Use a damp cloth for cleaning.
4. Do not use this unit near water, for example, near a bathtub, washbowl, kitchen sink, or the like.
5. Place this unit securely on a stable surface. Serious damage and/or injury may result if the unit falls.
6. Do not cover slots and openings on the unit. They are provided for ventilation and protection against overheating. Never place the unit near radiators, or in a place where proper ventilation is not provided.
7. Use only the power source marked on the unit. If you are not sure of the type of power supplied to your home, consult your dealer or local power company.
8. Do not place objects on the power cord. Install the unit where no one can step or trip on the cord.
9. Do not overload wall outlets and extension cords. This can result in the risk of fire or electric shock.
10. Never push any objects through slots in this unit. This may result in the risk of fire or electric shock. Never spill any liquid on the unit.
11. To reduce the risk of electric shock, do not disassemble this unit. Take the unit to an authorized servicer when service is required. Opening or removing covers may expose you to dangerous voltages or other risks. Incorrect reassembly can cause electric shock when the unit is subsequently used.
12. Unplug this unit from the wall outlet and refer servicing to an authorized servicer when the following conditions occur:
  - A. When the power supply cord or plug is damaged or frayed.
  - B. If liquid has been spilled into the unit.
  - C. If the unit has been exposed to rain or water.
  - D. If the unit does not work normally by following the operating instructions. Adjust only controls covered by the operating instructions. Improper adjustment may require extensive work by an authorized servicer.
  - E. If the unit has been dropped or physically damaged.
  - F. If the unit exhibits a distinct change in performance.
13. During thunderstorms, avoid using telephones except cordless types. There may be a remote risk of an electric shock from lightning.
14. Do not use this unit to report a gas leak, when in the vicinity of the leak.

**SAVE THESE INSTRUCTIONS**

---

**CAUTION:**

To reduce the risk of fire or injury to persons, read and follow these instructions.

1. Use only the battery(ies) specified.
2. Do not dispose of the battery(ies) in a fire. They may explode. Check with local waste management codes for special disposal instructions.
3. Do not open or mutilate the battery(ies). Released electrolyte is corrosive and may cause burns or injury to the eyes or skin. The electrolyte may be toxic if swallowed.
4. Exercise care in handling batteries in order not to short the battery to conductive materials such as rings, bracelets, and keys. The battery and/or conductor may overheat and cause burns.
5. Charge the battery(ies) provided with or identified for use with this product only in accordance with the instructions and limitations specified in this manual.

**WARNING:**

TO PREVENT FIRE OR SHOCK HAZARD, DO NOT EXPOSE THIS PRODUCT TO RAIN OR ANY TYPE OF MOISTURE.

- When left unused for a long period of time, the base unit should be unplugged from the household AC outlet.

# FCC and Other Information

---

If requested by the telephone company, inform them as follows:

FCC Registration No. .... (found on the bottom of the unit)  
Ringer Equivalence ..... 0.1B  
The particular telephone line to which the equipment is connected.

This unit must not be connected to a coin operated line.

If you are on a party line, check with your local telephone company.

## **Ringer Equivalence No. (REN):**

The REN is useful in determining the quantity of devices you may connect to your telephone line and still have all of those devices ring when your telephone number is called. In most, but not all areas, the sum of the REN's of all devices connected to one line should not exceed five (5.0). To be certain of the number of devices you may connect to your line, as determined by the REN, you should contact your local telephone company to determine the maximum REN for your calling area.

In the event terminal equipment causes harm to the telephone network, the telephone company should notify the customer, if possible, that service may be stopped.

However, where prior notice is impractical, the company may temporarily cease service providing that they:

- (a) Promptly notify the customer.
- (b) Give the customer an opportunity to correct the problem with their equipment.
- (c) Inform the customer of the right to bring a complaint to the Federal Communication Commission pursuant to procedures set out in FCC Rules and Regulations Subpart E of Part 68.

The Telephone Company may make changes in its communications facilities, equipment, operations or procedures, where such action is reasonably required in the operation of its business and is not inconsistent with the rules and regulations in FCC Part 68.

If such changes can be reasonably expected to render any customer terminal equipment incompatible with telephone company communications facilities, or require modification or alteration of such terminal equipment, or otherwise materially affect its use or performance, the customer shall be given adequate notice in writing, to allow the customer an opportunity to maintain uninterrupted service.

When programming emergency numbers and/or making test calls to emergency numbers:

1. Remain on the line and briefly explain to the dispatcher the reason for the call before hanging up.
2. Perform such activities in the off-peak hours, such as early morning hours or late evenings.

This device complies with Part 15 of the FCC Rules. Operation is subject to the following two conditions: (1) This device may not cause harmful interference, and (2) this device must accept any interference received, including interference that may cause undesired operation.

Privacy of communications may not be ensured when using this phone.

---

**CAUTION:**

Any changes or modifications not expressly approved by the party responsible for compliance could void the user's authority to operate this device.

**Note:**

This equipment has been tested and found to comply with the limits for a Class B digital device, pursuant to Part 15 of the FCC Rules. These limits are designed to provide reasonable protection against harmful interference in a residential installation. This equipment generates, uses, and can radiate radio frequency energy and, if not installed and used in accordance with the instructions, may cause harmful interference to radio communications. However, there is no guarantee that interference will not occur in a particular installation. If this equipment does cause harmful interference to radio or television reception, which can be determined by turning the equipment off and on, the user is encouraged to try to correct the interference by one or more of the following measures:

- Reorient or relocate the receiving antenna.
- Increase the separation between the equipment and receiver.
- Connect the equipment into an outlet on a circuit different from that to which the receiver is connected.
- Consult the dealer or an experienced radio/TV technician for help.

Some cordless telephones operate at frequencies that may cause interference to nearby TVs and VCRs. To minimize or prevent such interference, the base of the cordless telephone should not be placed near or on top of a TV or VCR. If interference is experienced, move the cordless telephone further away from the TV or VCR. This will often reduce, or eliminate, interference.

Operating near 2.4GHz electrical appliances may cause interference. Move away from the electrical appliances and/or press the CH (Channel) button.

- **Environment** — do not place the unit in a room where the temperature is less than 5°C (41°F) or greater than 40°C (104°F). Allow 10 cm (4") clearance around the unit for proper ventilation. Avoid excessive smoke, dust, mechanical vibration, shock, or direct sunlight.
- **Medical** — consult the manufacturer of any personal medical devices, such as pacemakers, to determine if they are adequately shielded from external RF (radio frequency) energy. (The unit operates in the frequency range of 2401MHz to 2472MHz, and the power output level can range from 0.001 watts to 0.20 watts.) Do not use the unit in health care facilities if any regulations posted in the area instruct you not to do so. Hospitals or health care facilities may be using equipment that could be sensitive to external RF (radio frequency) energy.
- **Routine care** — wipe the unit with a soft cloth. Do not use benzine, thinner, or any abrasive powder. When you leave the unit unused for a long period of time, unplug the AC adaptor from the outlet.
- **If there is any trouble** — disconnect the unit from the telephone line and connect a known working phone. If the known working phone operates properly, have your unit repaired by one of the authorized Panasonic Factory Service Centers. If the known working phone does not operate properly, consult your telephone company.

## For product service

- Panasonic Servicenters are listed in the servicenter directory.
- Call 1-800-211-PANA(7262) for the location of an authorized servicenter.
- Panasonic's e-mail address for customer inquiries:  
consumerproducts@panasonic.com  
for customers in the USA or Puerto Rico ONLY

## When you ship the product

- Carefully pack your unit, preferably in the original carton.
- Attach a letter, detailing the symptom, to the outside of the carton.

### Symptom

---

- Send the unit to an authorized servicenter, prepaid and adequately insured.
- Do not send your unit to the Panasonic Consumer Electronics Company listed below or to executive or regional sales offices. These locations do not repair consumer products.

- This cordless telephone is designed for use in the United States of America. Sale or use of this product in other countries may violate local laws.
- Ce téléphone sans fil est conçu pour être utilisé aux États-Unis d'Amérique. La vente ou l'emploi de cet appareil dans certains autres pays peut constituer une infraction à la législation locale.
- Este teléfono sin cordón fue elaborado para uso en los Estados Unidos de América. La venta o el empleo de este producto en ciertos países puede constituir violación de la legislación local.
- このコードレス電話機は、日本国外での使用を目的として設計されており、日本国内での使用は法律違反となります。従って、当社では日本国内においては原則として修理などのサービスは致しかねます。

**Panasonic Consumer Electronics Company,  
Division of Matsushita Electric Corporation of America**  
One Panasonic Way, Secaucus, New Jersey 07094

**Panasonic Sales Company,  
Division of Matsushita Electric of Puerto Rico, Inc.**  
Ave. 65 de Infantería, Km. 9.5, San Gabriel Industrial Park  
Carolina, Puerto Rico 00985