



Panasonic

2.4GHz Expandable Cordless Phone System

Operating Instructions

Model No. **KX-TG2750S**

Pulse-or-tone dialing capability

Preparation

Basic Operation

Advanced Operation

Useful Information



Caller ID Compatible

PLEASE READ BEFORE USE AND SAVE.

Charge the battery for about 15 hours before initial use.

Panasonic World Wide Web address: <http://www.panasonic.com>
for customers in the USA or Puerto Rico





Thank you for purchasing your new Panasonic cordless telephone.

Please read **IMPORTANT SAFETY INSTRUCTIONS** on page 62 before use. Read and understand all instructions.

Caller ID, Call Waiting Service, and Voice Mail Service, where available, are telephone company services. After subscribing to Caller ID, this phone will display a caller's name and phone number. Call Waiting Caller ID, which displays a second caller's name and phone number while the user is on the phone line with the first caller, requires a subscription to both Caller ID with Name and Call Waiting Service. After subscribing to Voice Mail Service, this phone's VM indicator will flash when there are new messages left in the voice mail box at phone company.

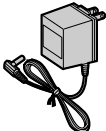
Attach your purchase receipt here.

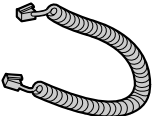
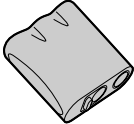
Accessories (included) For extra orders, call 1-800-332-5368.

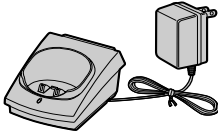
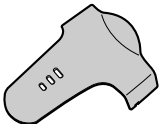
<input type="checkbox"/> AC Adaptor (p. 10) Order No. PQLV10Z (PQLV10)  one	<input type="checkbox"/> Telephone Line Cord (p. 10) Order No. PQJA10075Z  one	<input type="checkbox"/> Handset (p. 10) Order No. PQJXM0121Z  one
<input type="checkbox"/> Handset Cord (p. 10) Order No. PFJA04C001Z  one	<input type="checkbox"/> Battery (p. 11) Order No. N4HKGMA00001 (P-P511)  one	<input type="checkbox"/> Handset Cover (p. 11) Order No. PQKK10126Z1  one
<input type="checkbox"/> Charger Unit (p. 10) Charger Order No. PQLV30013ZS AC Adaptor Order No. KX-TCA1-G (KX-TCA1)  one	<input type="checkbox"/> Belt Clip (p. 51) Order No. PQKE10340Z1  one	

To use more than one cordless handset, please purchase the accessory cordless handset KX-TGA270S, KX-TGA271B, KX-TGA271V, KX-TGA271W, KX-TGA272S and KX-TGA273S. The charger is included. To order, contact your dealer or call 1-800-211-PANA(7262) to locate a dealer.

For Best Performance

Battery Charge

A rechargeable Ni-Cd battery powers the cordless handset. Charge the battery for about **15 hours** before initial use (p. 11).



Base Unit Location/Noise

Calls are transmitted between the base unit and the cordless handset using wireless radio waves. **For maximum distance and noise-free operation**, the recommended base unit location is:

Away from electrical appliances such as a TV, personal computer or another cordless phone.

In a **HIGH** and **CENTRAL** location with no obstructions such as walls.

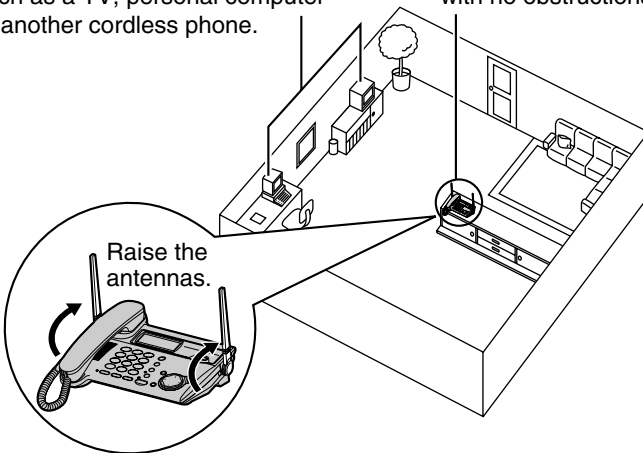

Note:

- If you use the cordless handset near a microwave oven which is being used, noise may be heard from the receiver or the speaker. Move away from the microwave oven and closer to the base unit.
- If you use the cordless handset near another cordless phone's base unit, noise may be heard. Move away from the other cordless phone's base unit and closer to your base unit.

Contents

Preparation

Location of Controls	6
Displays	9
Installation	10
Connections	10
Installing the Battery in the Cordless Handset	11
Battery Charge	11
Programmable Settings	13
Programming Guidelines	13
Function Menu Table	14
Date and Time	16
Dialing Mode	17
Line Mode	17
Ringer Volume	18
Ringer Tone	18
Auto Talk Feature	19
LCD Contrast	19
Registration for Additional Handsets	20

Basic Operation

Making Calls	21
Using the Base Unit	21
Using the Cordless Handset ..	23
Answering Calls	25
Caller ID Service	25
Using the Caller List	26
Viewing the Caller List	26
Calling Back from the Caller List	27
Editing the Caller's Phone Number	27
Caller ID Number Auto Edit Feature	28
Storing Caller List Items in the Directory	29
Erasing Caller List Items	29

Advanced Operation

Directory	30
Storing Names and Numbers ..	30
Dialing from the Directory	32
Editing an Item in the Directory	33
Erasing an Item in the Directory	33
Copying the Directory	34
Intercom	36
Making Intercom Calls	36
Answering Intercom Calls	37
Transferring a Call	38
Conference Calls	40
Call Share	40
Call Privacy Feature	41
Room Monitor Feature	41
2-Way Radio Communication (When the System Has Additional Handsets)	43
Voice Mail Service	45
Storing Your Voice Mail Access Number	45
Setting Voice Mail (VM) Tone Detection	46
Listening to Voice Mail Messages	47
Special Features	48
Muting Your Conversation	48
Temporary Tone Dialing (For Rotary or Pulse Service Users)	48
For Call Waiting Service Users	48
Using the PAUSE Button (For PBX Line/Long Distance Calls) ..	49
Incoming Call Tone	49
FLASH Button	50

Useful Information

Belt Clip	51
Optional Headset	51
Wall Mounting	52
Canceling Registration/ Re-registration	54
Canceling the Handset Registration	54
Re-registering the Handset . . .	55
If the Following Appear on Your Display...	56
Troubleshooting	59
Important Safety Instructions	62
FCC and Other Information . .	64
Index	67
Warranty	69
Specifications	71

Important

Throughout these Operating Instructions, **Base Unit** and **Handset** are used to indicate with which unit an operation can be performed.

Base Unit : Perform with the base unit.

Handset : Perform with the cordless handset.

Base Unit Handset : Perform with the base unit and cordless handset separately.

Use either Base Unit or Handset : Perform with either the base unit or cordless handset. You do not need to perform the operation with both.

Base Unit & Handset : Perform with the base unit and cordless handset together.

Location of Controls

Base unit

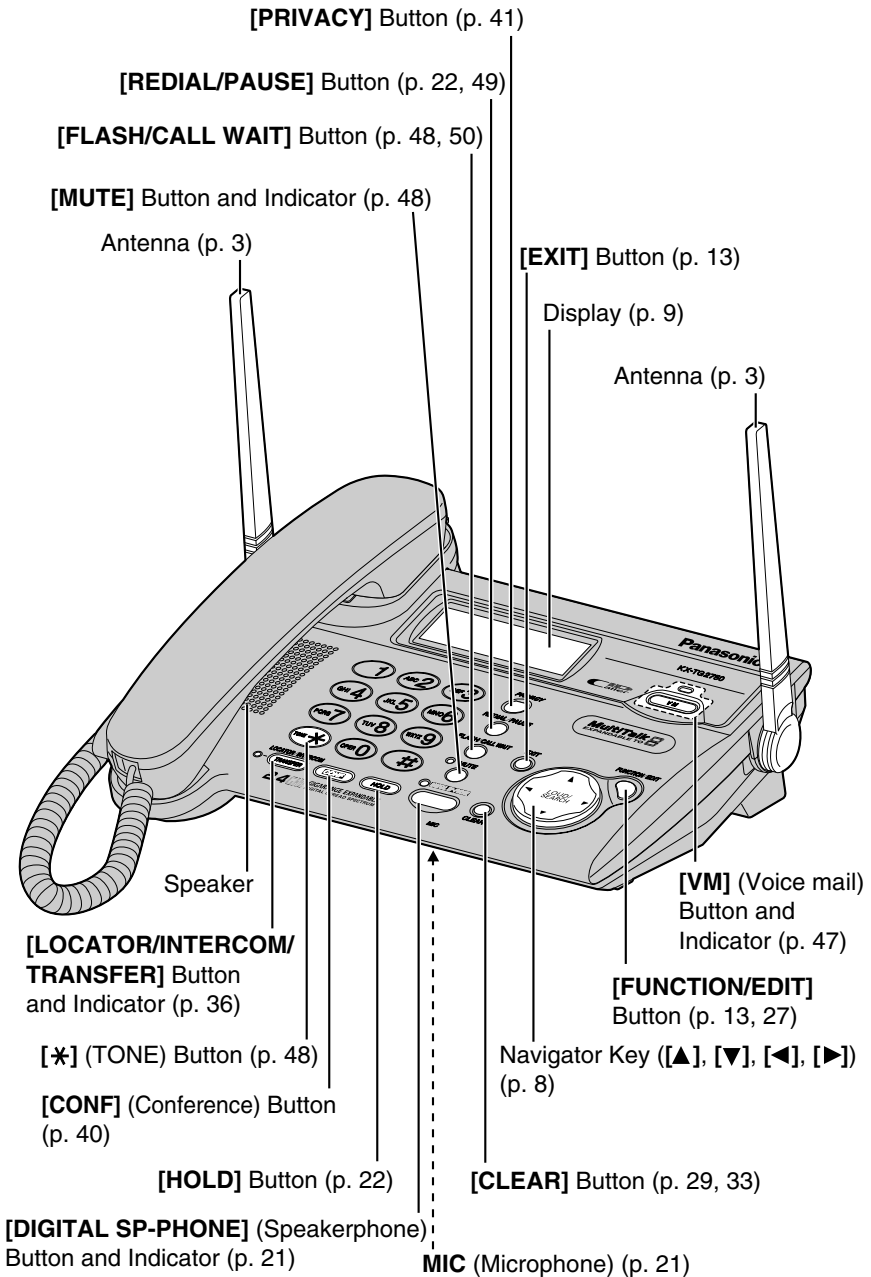

Cordless handset

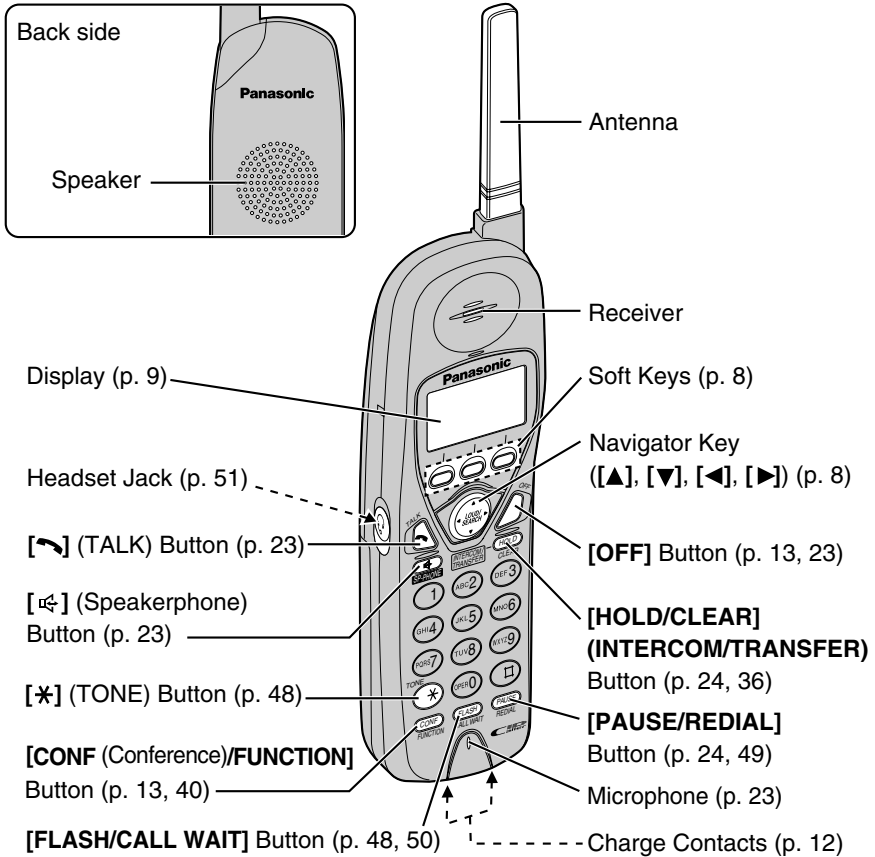

Charger unit

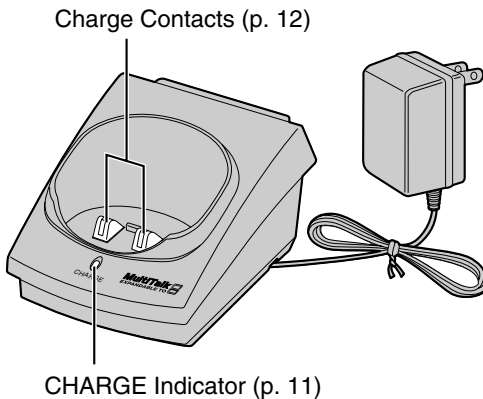







Location of Controls

How to use the navigator keys/soft keys

Navigator keys

These keys have four active areas that are indicated by the arrows.

Base unit 	 <ul style="list-style-type: none">• Scrolls up the function menu, Caller List and the directory list.• Increases the volume.
Cordless handset 	 <ul style="list-style-type: none">• Scrolls down the function menu, Caller List and the directory list.• Decreases the volume.
	 <ul style="list-style-type: none">• Selects your menu choices, enters the directory list or moves the cursor forward.
	 <ul style="list-style-type: none">• Enters the directory list, returns to the previous display or moves the cursor backward.

Throughout these Operating Instructions, the navigator keys are indicated by the arrows [▼], [▲], [◀] or [▶].

Cordless handset soft keys

Example

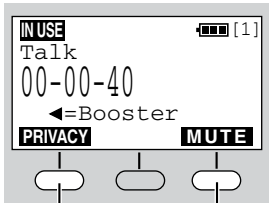

Three soft keys are used to select functions displayed directly above the keys. Functions displayed above the keys will change depending on the state of use.

For example, on the left display, “**PRIVACY**” and “**MUTE**” are displayed above the soft keys.

To operate “**MUTE**”, press the right soft key.
To operate “**PRIVACY**”, press the left soft key.

- When a function does not appear above a soft key, the soft key will not work.

Throughout these Operating Instructions, the soft keys are indicated by the function icons, such as **MUTE** and **PRIVACY**.

Lighted handset keypad

The dialing buttons will light when you press a button or lift the cordless handset off the charger. The light will go out after a few seconds.

Displays

Base unit

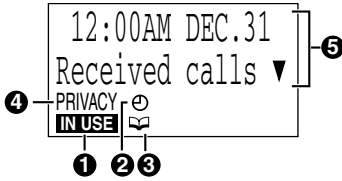

Cordless handset

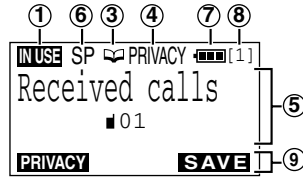

① ① “**IN USE**” (IN USE icon) functions as follows.

Off (invisible)	The line is free.
On	The line is being used.
Flashing	A call is on hold within this system (cordless handset or base unit).
Flashing quickly	A call is being received.

② When “⌚” (clock icon) flashes, the clock needs adjusting (p. 16).

③ ③ “📖” (directory icon) is displayed when storing, viewing, copying or receiving the directory items (p. 30–35).

④ ④ “PRIVACY” indicates Call Privacy mode is on (p. 41). Other extension users cannot join your conversation.

⑤ ⑤ The display shows the dialed number, call status, programming options, directory items, Caller ID information etc. The time and date are displayed on the base unit.

“■” (extension icon) is displayed with the extension numbers

- during an intercom call (p. 36) or a conference call (p. 40);
- while monitoring a room (p. 42);
- while in 2-Way Radio mode (p. 44).

⑥ “SP” is shown when you are using the handset speaker

- during an intercom call (p. 36) or a conference call (p. 40);
- while monitoring a room (p. 42);
- while in 2-Way Radio mode (p. 44).

⑦ The battery icon indicates the battery strength (p. 11).

⑧ The extension number of your cordless handset is displayed if it has been registered to the base unit (p. 20, 55).

⑨ The prompts on the bottom line will show corresponding functions of the soft keys which are located directly below the display (p. 8).

Ex. The soft key below “**SAVE**” will function as **SAVE** key.

Backlit LCD displays

The lighted display of the cordless handset will stay on for a few seconds after pressing a button or lifting the cordless handset off the charger.

The base unit display will light during use.

Installation

Connections

Base unit

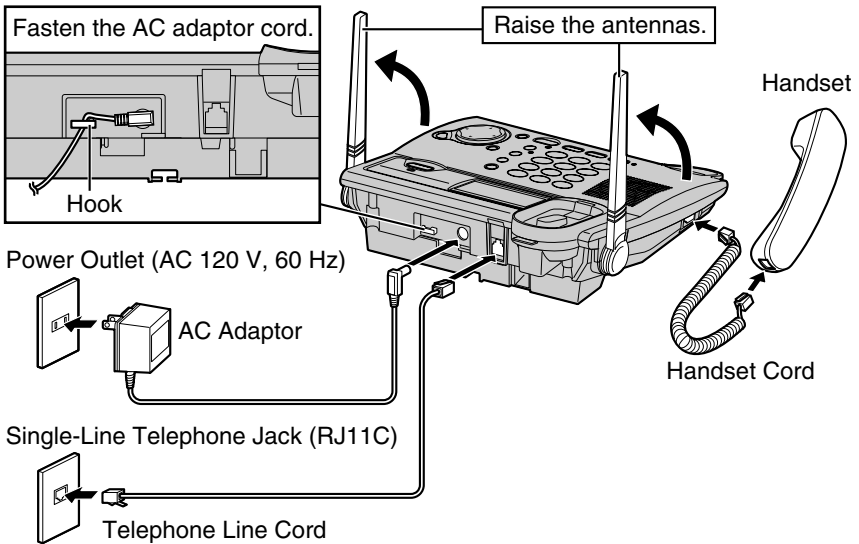

- Base unit: USE ONLY WITH Panasonic AC ADAPTOR PQLV10 (Order No. PQLV10Z).
- Use Only a Panasonic Handset for the KX-TG2750S.
- The AC adaptor must remain connected at all times. (It is normal for the adaptor to feel warm during use.)
- If your unit is connected to a PBX which does not support Caller ID and voice mail services, you cannot access those services.

During a power failure the base unit will work as a standard telephone, so that you can make or answer external calls with the base unit handset.

You cannot use the base unit speakerphone and the cordless handset.

- If power returns to the base unit while having a conversation using the base unit handset, you will not be able to use the speakerphone nor the cordless handset and the display will be blank until you hang up the call. After hanging up the call, you can resume all functions.

Charger unit

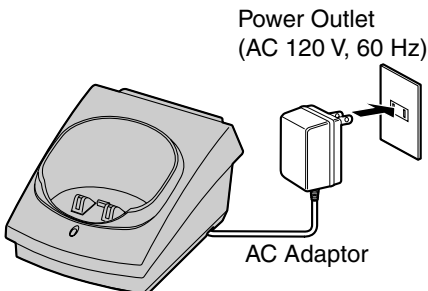

- Charger unit: USE ONLY WITH Panasonic AC ADAPTOR KX-TCA1 (Order No. KX-TCA1-G).
- The AC adaptor must remain connected at all times. (It is normal for the adaptor to feel warm during use.)

Installing the Battery in the Cordless Handset

Insert the battery (①), and press it down until it snaps into the compartment (②). Close the cover.

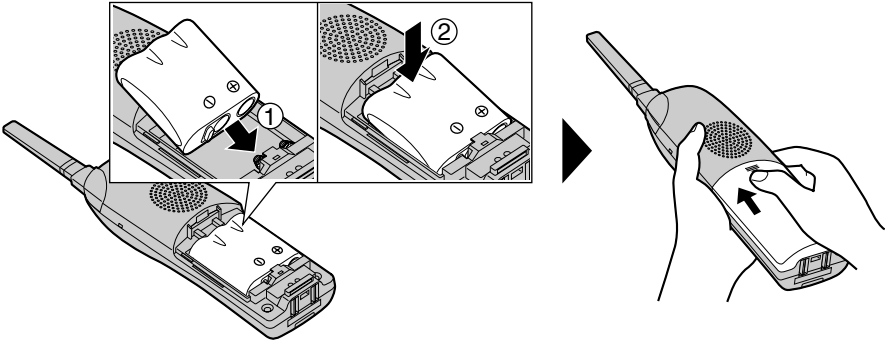

To replace the battery:

Press the notch on the cover firmly and slide it as indicated by the arrow. Replace the old battery with a new one (p. 12). Close the cover and charge the cordless handset for about 15 hours.

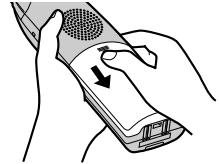

Battery Charge

Place the cordless handset on the charger and charge for about **15 hours** before initial use.

- The unit beeps once, the CHARGE indicator lights and "Charging" is displayed.

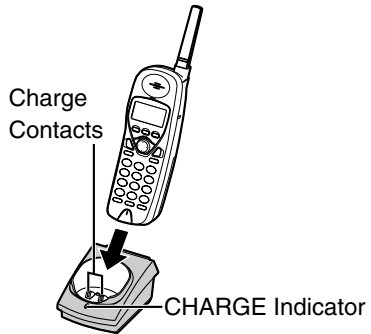

Battery strength

You can check the battery strength on the cordless handset display. The battery strength is as shown in the chart below.

Display prompt	Battery strength
	Fully charged
	Medium
	Low
(flashing)	Needs to be recharged.
	Discharged



Installation

Recharge

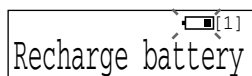

Recharge the battery when:

- “Recharge battery” is displayed on the cordless handset,
- “” flashes, or
- the cordless handset beeps intermittently while it is in use.



- If you DO NOT recharge the battery for more than 15 minutes, the display will continually indicate “Recharge battery” and/or “” will flash when the cordless handset is lifted off the charger.
- If the battery has been discharged, the cordless handset will display “Charge for 15HRS” and “” when you place the cordless handset on the charger. The handset will not work unless the battery is charged. Keep charging.

Battery replacement:

If you cleaned the charge contacts and fully charged the battery, but after a few telephone calls, “Recharge battery” is displayed and/or “” continues to flash, or “Charge for 15HRS” and “” are displayed, the battery needs to be replaced. Please order a new Panasonic N4HKGMA00001 (P-P511) battery at the telephone number shown on page 2. To replace the battery, see page 11.

A nickel cadmium battery that is recyclable powers the product you have purchased. At the end of its useful life, under various state and local laws, it is illegal to dispose of this battery into your municipal waste stream. Please call 1-800-8-BATTERY for information on how to recycle this battery.



Battery information

After your Panasonic battery is fully charged:

Operation	Operating time
While in use (TALK)	Up to 4.5 hours
While not in use (Standby)	Up to 11 days*
While using the Reception Booster feature (p. 24)	Up to 3.5 hours

*When using the 2-Way Radio mode (p. 43): Up to 12 hours (standby)

- The battery operating time may be shortened depending on usage conditions and ambient temperature.
- **Clean the charge contacts of the cordless handset and the charger with a soft, dry cloth once a month. Clean more often if the unit is subject to grease, dust or high humidity.** Otherwise the battery may not charge properly.
- If the battery is fully charged, you do not have to place the cordless handset on the charger until “Recharge battery” is displayed and/or “” flashes. This will maximize the battery life.
- The battery cannot be overcharged.

Programmable Settings

Programming Guidelines **Base Unit** **Handset**

The base unit and the cordless handset have programmable functions. They are selected from the function menu on the display (p. 14, 15).

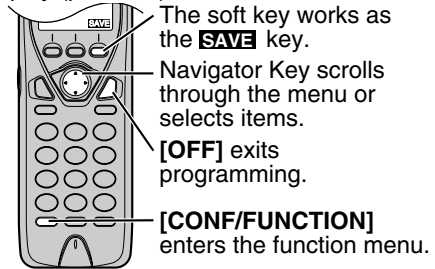
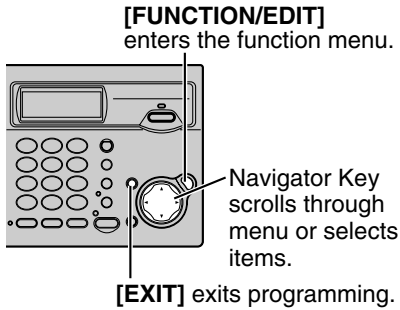

How to select a function item from the menu

Make sure the base unit and the cordless handset are not being used. The cordless handset must be operated near the base unit and off the charger.

- 1** *Base unit:* Press **[FUNCTION/EDIT]**.
Cordless handset: Press **[CONF/FUNCTION]**.
 - The main menu is displayed (p. 14, 15).

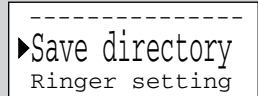

- 2** Scroll to the desired item by pressing **[▼]** or **[▲]**. Press **[▶]** to select the item.

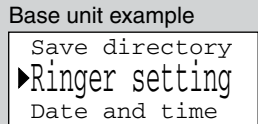

- 3** If the item has a sub-menu, select the menu item (p. 14, 15). Repeat step 2 until your desired item is displayed.

- 4** *Base unit:* Select the desired setting by pressing **[▼]** or **[▲]**, then press **[▶]** (Save). (For "Date and time (p. 16)" and "Save VM access# (p. 45)", press **[▼]** (Save) instead of **[▶]**.)
Cordless handset: Select the desired setting by pressing **[▼]** or **[▲]**, then press the soft key (**SAVE**).
 - A confirmation tone will be heard and the setting will be saved.

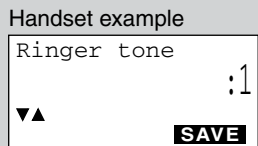
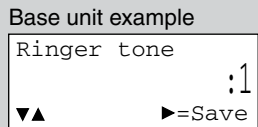

- 5** *Base unit:* Press **[EXIT]** to exit programming mode.
Cordless handset: Press **[OFF]** to exit programming mode.

Programmable Settings

Useful information

- “-----” indicates the beginning or end of the function menu.
- You can go back to the previous display by pressing [◀] except when entering characters or numbers. To return to the main menu from the sub-menu, press [◀].
- After programming is complete, the display will return to the main menu or the sub-menu depending on which menu the selected item is located. (See the menu tables on pages 14 and 15.)
- To exit the programming mode:
For the base unit, press [EXIT]. For the cordless handset, press [OFF].
- If you do not press any buttons for 60 seconds, the unit will exit programming mode.
- If the unit detects a problem, an error message will be displayed (p. 56–58).

Function Menu Table

You can use the following functions to customize your unit. See the corresponding pages for function details.

Base unit

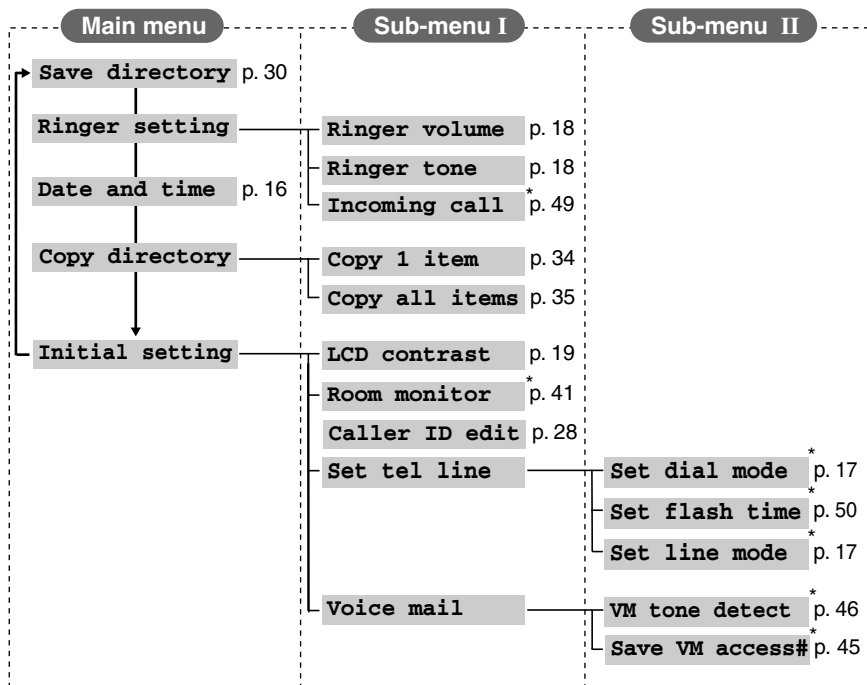

The items with “” in the menu table can be programmed with either the base unit or the cordless handset. You do not need to program these items on both the base unit and the cordless handset.

Cordless handset

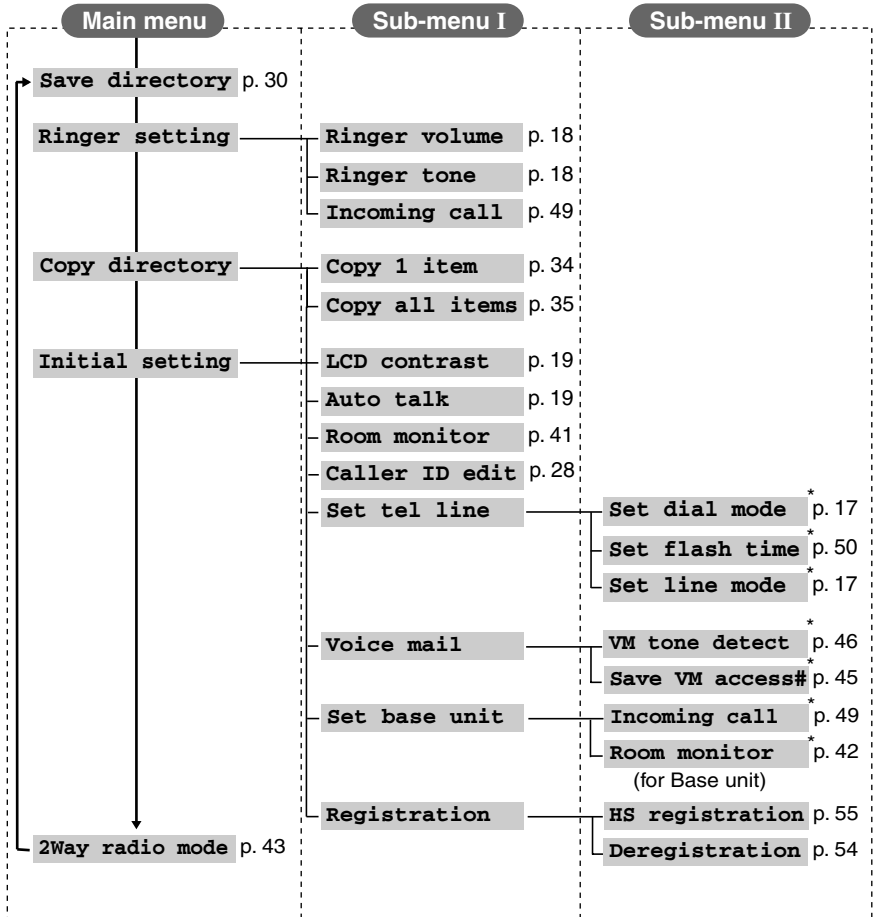

The items with “” in the menu table can be programmed with either the base unit or the cordless handset. You do not need to program these items on both the base unit and the cordless handset.

Programmable Settings

Date and Time **Base Unit**

1 Press [FUNCTION/EDIT].

2 Scroll to “Date and time” by pressing [▼] or [▲], then press [▶].

▶Date and time

3 (1) Enter the year, and month and day using 4-digit numbers. (Ex. To set Apr. 7, 2003, enter “2003” and “0407”.)

Date:2003.12.31
Time:12:00 AM
◀▶ 0-9=Date&Time
*=AM/PM ▼=Save

(2) Enter the time (hour and minute) using a 4-digit number. (Ex. To set 9:30, enter “0930”.)

Date:2003.04.07
Time:09:30 AM
◀▶ 0-9=Date&Time
*=AM/PM ▼=Save

- If you enter a wrong number, press [◀] or [▶] to move the cursor to the incorrect number. Enter the correct number.

4 Select “AM” or “PM” by pressing [✳].

5 Press [▼] (Save).

- If 3 beeps sound, the setting is not correct. Start again from step 3.
- The clock starts working.

6 Press [EXIT].

- When entering the time, you cannot enter numbers greater than 12. **Do not use military time.** (To set 13:00 hours, enter “0100”, and select “PM”.)

If a power failure occurs, the time setting may be incorrect. When “⊖” flashes on the base unit display, adjust the date/time.

For Caller ID service users (p. 25)

- Caller ID information will reset the clock after the first ring if the adjusted time is incorrect.
- If the time has not previously been set, the Caller ID information will not adjust the clock.
- Caller ID information will automatically adjust the clock for daylight saving time.

Dialing Mode (use either **Base Unit** or **Handset**)

If you have touch tone service, set to "Tone". If rotary or pulse service is used, set dialing mode to "Pulse". The factory preset is "Tone".

Base Unit

1 Press [FUNCTION/EDIT].	
2 Scroll to "Initial setting" by pressing [▼] or [▲], then press [▶].	▶Initial setting
3 Scroll to "Set tel line" by pressing [▼] or [▲], then press [▶].	▶Set tel line
4 Press [▶] at "Set dial mode".	▶Set dial mode
5 Select "Pulse" or "Tone" by pressing [▼] or [▲].	Set dial mode :Tone ▼▲ ▶=Save
6 Press [▶] (Save), then press [EXIT].	

Handset: Press [CONF/FUNCTION], and follow steps 2 to 5 above, using the cordless handset. Press the soft key (SAVE), then press [OFF].

Line Mode (use either **Base Unit** or **Handset**)

The line mode is preset at the factory to "B". Generally leave the line mode to "B". If a change of the line mode setting is required by our customer call center or serviceman, change the line mode to "A".

Base Unit

1 Press [FUNCTION/EDIT].	
2 Scroll to "Initial setting" by pressing [▼] or [▲], then press [▶].	▶Initial setting
3 Scroll to "Set tel line" by pressing [▼] or [▲], then press [▶].	▶Set tel line
4 Scroll to "Set line mode" by pressing [▼] or [▲], then press [▶].	▶Set line mode
5 Select "A" or "B" by pressing [▼] or [▲].	Set line mode :B ▼▲ ▶=Save
6 Press [▶] (Save), then press [EXIT].	

Handset: Press [CONF/FUNCTION], and follow steps 2 to 5 above, using the cordless handset. Press the soft key (SAVE), then press [OFF].

Programmable Settings

Ringer Volume **Base Unit** **Handset**

You can select the ringer volume to HIGH, MEDIUM, LOW or OFF on the base unit and the cordless handset separately. The factory preset is HIGH. If set to OFF, the unit will not ring for external calls and will ring at the LOW level for intercom calls.

1 *Base unit:* Press **[FUNCTION/EDIT]**.

Cordless handset: Press **[CONF/FUNCTION]**.

2 Scroll to “Ringer setting” by pressing **[▼]** or **[▲]**, then press **[▶]**.

▶Ringer setting

3 Press **[▶]** at “Ringer volume”.

▶Ringer volume

4 Select the desired volume by pressing **[▼]** or **[▲]**.

- The volume will change and ring.
- The number of steps indicates the volume level.
- **To turn the ringer OFF**, press **[▼]** repeatedly until “Off ?” is displayed.

Ex. HIGH

Ringer volume
Low  High

Ex. OFF

Ringer volume
Off ?

5 *Base unit:* Press **[▶]** (Save).

Cordless handset: Press the soft key **(SAVE)**.

- If set to OFF, the base unit displays “Ringer off” while not in use and no new calls are in the Caller List. The cordless handset displays “Ringer off” while not in use.
- You can also select the ringer volume while an external call is being received. Press **[▼]** or **[▲]** while the unit is just ringing.

Ringer Tone **Base Unit** **Handset**

You can select one of 6 ringer tones for external calls on the base unit and the cordless handset separately. The factory preset is “1”.

1 Follow steps 1 and 2 of “Ringer Volume” above.

2 Scroll to “Ringer tone” by pressing **[▼]** or **[▲]**, then press **[▶]**.

▶Ringer tone

3 Select the desired tone by pressing **[▼]** or **[▲]**.

- The tone will change and ring. If the ringer volume has been set to OFF, the unit will not ring.
- You can also select the ringer tone by pressing **[1]** to **[6]**.

Ringer tone
:1

4 *Base unit:* Press **[▶]** (Save), then press **[EXIT]**.

Cordless handset: Press the soft key **(SAVE)**, then press **[OFF]**.

Auto Talk Feature **Handset**

The Auto Talk feature allows you to answer a call by lifting the cordless handset off the charger without pressing [↶] or [↷]. To use this feature, turn the feature ON. The factory preset is OFF.

1 Press [CONF/FUNCTION].	
2 Scroll to “Initial setting” by pressing [▼] or [▲], then press [▶].	▶Initial setting
3 Scroll to “Auto talk” by pressing [▼] or [▲], then press [▶].	▶Auto talk
4 Select “On” or “Off” by pressing [▼] or [▲].	Auto talk :Off
5 Press the soft key (SAVE), then press [OFF].	

- In order to view Caller ID information after you lift up the cordless handset to answer a call, leave the Auto Talk feature OFF.

LCD Contrast **Base Unit** **Handset**

You can select the LCD contrast (6 levels) on the base unit and the cordless handset separately. The factory preset is level 3.

1 <i>Base unit:</i> Press [FUNCTION/EDIT]. <i>Cordless handset:</i> Press [CONF/FUNCTION].	
2 Scroll to “Initial setting” by pressing [▼] or [▲], then press [▶].	▶Initial setting
3 Press [▶] at “LCD contrast”.	▶LCD contrast
4 Select the desired contrast by pressing [▼] or [▲]. <ul style="list-style-type: none"> • The contrast will change. • The number of steps indicates the contrast level. 	Ex. Level 6 LCD contrast Low  High
5 <i>Base unit:</i> Press [▶] (Save), then press [EXIT]. <i>Cordless handset:</i> Press the soft key (SAVE), then press [OFF].	

Registration for Additional Handsets Base Unit & Handset

KX-TG2750S includes a base unit and one cordless handset. You can expand the system by adding up to 7 additional cordless handsets, sold separately. A maximum of 8 cordless handsets can be registered to the base unit.

Generally a maximum of 4 extensions excluding or including the base unit can operate at a time. If 4 other extensions are in use, such as conducting a call, you may not be able to use your unit. "System is busy. Please try again later." will be displayed when you try to operate your unit. The maximum operating number may decrease, depending on the state of usage, such as using the Reception Booster mode (p. 24).



The included cordless handset is pre-registered at the factory and assigned the extension number 1. You do not need to register this handset which has "[1]" on the display. If you purchase accessory cordless handsets, you must register each of them at the base unit. Only one cordless handset can be registered at a time. A cordless handset will be assigned the extension number at registration. The model numbers of the optional cordless handsets are KX-TGA270S, KX-TGA271B, KX-TGA271V, KX-TGA271W, KX-TGA272S and KX-TGA273S. To order, contact your dealer or call 1-800-211-PANA(7262) to locate a dealer.

Charge the battery fully. Make sure the base unit and the other cordless handsets are not being used. Registration must be completed within 1 minute.

The handset display shows the instructions as shown on the right.

Press MUTE on
base unit, then
OK on handset to
register handset

1 Base unit: Press [MUTE].

- The MUTE indicator flashes.

2 Cordless handset:

- (1) Press the soft key **[OK]**.
- (2) Wait until a long beep sounds and the display shows the registered number.

- Registration is complete.

Ex. Extension number 2

Handset [2] [2]
Registered

- You can stop registration by pressing **[OFF]** on the cordless handset and pressing **[MUTE]** on the base unit.
- To re-register a cordless handset to a different base unit of the same model, see pages 54 and 55.

Making Calls

Using the Base Unit **Base Unit**

You can make a call by simply lifting the handset off the cradle and dialing a phone number. To hang up, place the handset on the cradle.

- “Talk” is displayed while using the handset.

To have a hands-free phone conversation

1 Press **[DIGITAL SP-PHONE]**.

- The indicator lights and “SP-phone” is displayed.

2 Dial a phone number.

- The dialed number is displayed.
- After a few seconds, the display will show the length of the call.
- If you misdial, press **[DIGITAL SP-PHONE]** and start again from step 1.

3 When the other party answers, talk into the **MIC** (microphone).

4 To hang up, press **[DIGITAL SP-PHONE]**.

- The indicator goes out.

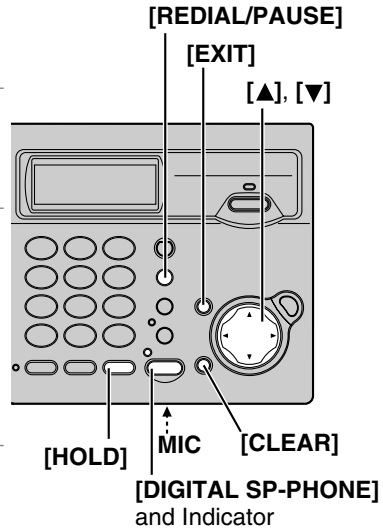

Hands-free Digital Duplex Speakerphone

For best performance, please note the following:

- Talk alternately with the caller in a quiet room.
- If you or the other party has hearing difficulty, press [▼] to decrease the speaker volume.
- You can switch to the handset by lifting it up. To switch back to the speakerphone, press **[DIGITAL SP-PHONE]**.

To adjust the handset/speaker volume while talking

3 levels (High, Medium and Low) are available for the handset and 8 levels for the speaker.

To increase, press [▲]. To decrease, press [▼].

- The number of steps indicates the volume level.

Ex. Handset volume: High

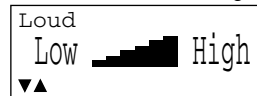

Making Calls

To dial after confirming the entered number

1. Enter a phone number.



- If you misdial, press **[CLEAR]**. Dial the correct number.
 - To cancel, press **[EXIT]**.
2. Lift the handset or press **[DIGITAL SP-PHONE]**.
 3. When the other party answers, talk into the handset or **MIC**.
 4. To hang up, place the handset or press **[DIGITAL SP-PHONE]**.

To redial the last number dialed

Lift the handset or press **[DIGITAL SP-PHONE]**, then press **[REDIAL/PAUSE]**.

To redial using the redial list (Memory Redial)

The last 5 phone numbers dialed with the base unit are stored in the redial list.

1. Press **[REDIAL/PAUSE]**.
 - The last number dialed is displayed with number 1.
2. Scroll to the desired number by pressing **[▼]** or **[▲]**.
 - You can also scroll down through the list by pressing **[REDIAL/PAUSE]**.
 - To exit the list, press **[EXIT]**.
3. Lift the handset or press **[DIGITAL SP-PHONE]**.
 - **To erase an item**, scroll to the item then press **[CLEAR]**.
 - If “No items stored” is displayed, the list is empty.

To put a call on hold

Press **[HOLD]**.

- “Hold” is displayed and the DIGITAL SP-PHONE indicator flashes.
- If using the handset, you can place it on the cradle.

To release the hold;

- when using the handset, press **[HOLD]**.
 - when using the speakerphone, press **[DIGITAL SP-PHONE]** or lift the handset.
- Cordless handset users can release the hold by pressing **[↶]** or **[↷]**.
 - If a call is kept holding for 6 minutes, an alarm tone will start to sound. After 4 additional minutes on hold the call will be disconnected.

Using the Cordless Handset **Handset**

- 1 Press [**☎**].
 - “Talk” is displayed.
- 2 Dial a phone number.
 - The dialed number is displayed.
 - After a few seconds, the display will show the length of the call.
- 3 To hang up, press [**OFF**] or place the cordless handset on the charger.

To have a hands-free phone conversation

- 1 Press [**☎**].
 - “SP-phone” is displayed.
- 2 Dial a phone number.
 - The dialed number is displayed.
 - After a few seconds, the display will show the length of the call.
- 3 When the other party answers, talk into the microphone.
- 4 To hang up, press [**OFF**] or place the cordless handset on the charger.

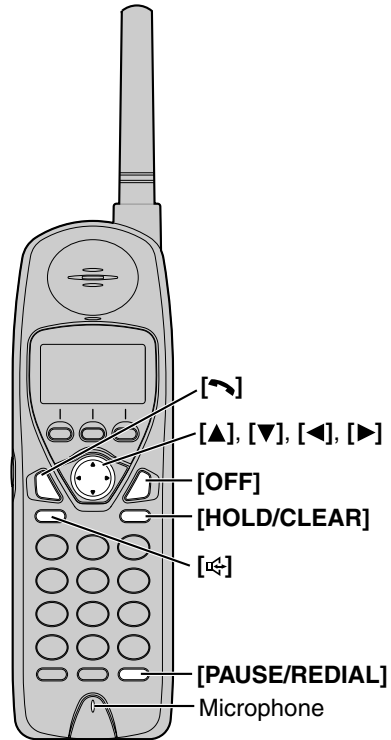

Hands-free Digital Duplex Speakerphone

For best performance, please note the following:

- Talk alternately with the caller in a quiet room.
- If you or the other party has hearing difficulty, press [**▼**] to decrease the speaker volume.
- While talking using [**☎**], you can switch to the hands-free phone conversation by pressing [**☎**]. To switch back to the receiver, press [**☎**].

To adjust the receiver/speaker volume while talking

3 levels (High, Medium and Low) are available for the receiver and 6 levels for the speaker.

To increase, press [**▲**]. To decrease, press [**▼**].

- The number of steps indicates the volume level.

Ex. Receiver volume: High
Speaker volume: Level 6

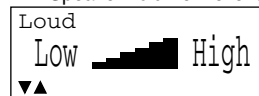

Making Calls

To dial after confirming the entered number

1. Enter a phone number.



- If you misdial, press [**HOLD/CLEAR**]. Dial the correct number.
 - To cancel, press [**OFF**].
2. Press [**↶**] or [**↷**].
 3. To hang up, press [**OFF**] or place the cordless handset on the charger.

To redial the last number dialed

Press [**↶**] or [**↷**], then press [**PAUSE/REDIAL**].

To redial using the redial list (Memory Redial)

The last 5 phone numbers dialed with the cordless handset are stored in the redial list.

1. Press [**PAUSE/REDIAL**].
 - The last number dialed is displayed with number 1.
2. Scroll to the desired number by pressing [**▼**] or [**▲**].
 - You can also scroll down through the list by pressing [**PAUSE/REDIAL**].
 - To exit the list, press [**OFF**].
3. Press [**↶**] or [**↷**].
 - **To erase an item**, scroll to the item then press [**HOLD/CLEAR**].
 - If “No items stored” is displayed, the list is empty.

Reception Booster feature

This feature improves the sound quality when using the cordless handset in an area with interference.

Press [**◀**] (Booster) while talking.

- “Booster on” will flash when the mode is on.
- To turn the feature off, press [**◀**] or [**▶**].
- The feature will be off after hanging up, when putting a call on hold or making a conference.
- The battery operating time will be shortened using this feature (p. 12).

To put a call on hold

Press [**HOLD/CLEAR**] twice.

- “Hold” is displayed.
- To transfer the call to another extension, see page 38.

To release the hold, press [**↶**] or [**↷**].

- The base unit user can also release the hold by lifting its handset or pressing [**DIGITAL SP-PHONE**].
- Another cordless handset user can also release the hold by pressing [**↶**] or [**↷**].
- If a call is kept holding for 6 minutes, an alarm tone will start to sound. After 4 additional minutes on hold the call will be disconnected.

Answering Calls

When a call is received, the unit rings and “Incoming call” is displayed.

Base Unit

- 1 Lift the handset or press **[DIGITAL SP-PHONE]**.
- 2 Talk into the handset or **MIC** (microphone).
- 3 To hang up, place the handset on the cradle or press **[DIGITAL SP-PHONE]**.

Handset

- 1 Press [**↶**] or [**↷**].
 - You can also answer a call by pressing any dialing button (**[0]** to **[9]**, **[#]** or **[*]**)(**Any Key Talk**).
- 2 To hang up, press **[OFF]** or place the cordless handset on the charger.

Auto Talk: If you set the Auto Talk feature to ON (p. 19), you can answer a call by lifting the cordless handset off the charger without pressing [**↶**] or [**↷**].

- To transfer the call to another person, see page 38.
- When the ringer volume is set to OFF, the unit will not ring (p. 18).

Caller ID Service

This unit is compatible with Caller ID services offered by your telephone company. If you subscribe to Caller ID, the calling party's information will be displayed and the Caller ID information will be recorded in the Caller List.

How Caller ID information is displayed when a call is received

The base unit and the cordless handset display the caller's name and number after the first ring. In order to view the Caller ID information, please wait until the second ring to answer.

Example

ROBINSON, TINA 1-555-222-3333

- After you answer the call, the display will show the length of the call.
- If the unit does not receive Caller ID information, the following will be displayed:

Display	Meaning
Out of area	The caller dialed from an area which does not provide Caller ID service.
Private caller	The caller requested not to send his/her information.
Long distance	The caller made a long distance call.

- Depending on radio communications with the base unit, the cordless handset may not display Caller ID information immediately after the first ring.
- If your unit is connected to a PBX which does not support Caller ID, you cannot access Caller ID services.
- The name display service may not be available in some areas. For further information, please contact your telephone company.
- If you subscribe to both Caller ID and Call Waiting services, when a second call is received while talking, the second caller's information will be displayed (p. 48).

Using the Caller List

The base unit and the cordless handset can record Caller ID information from up to 50 different callers and store this information in each unit's Caller List. Caller List information is sorted by the most recent call to the oldest. When the 51st call is received, the information from the first call is deleted.

Viewing the Caller List **Base Unit** **Handset**

If you have received new calls, "Received calls" will be displayed.

1 Press [▼] or [▲] to enter the Caller List.

Ex. Received 10 new calls

Caller list
10 new calls
▼▲
▶=Directory list

2 To search from the most recent call, press [▼].
To search from the oldest call, press [▲].

- The caller's name, number and the time and date received are displayed.

Example

SMITH, JACK
1-555-333-4444
3:10P JUN.10

3 *Base unit:* Press [EXIT] to exit the list.

Cordless handset: Press [OFF] to exit the list.

- If "No items stored" is displayed, the Caller List is empty.
- If there is no name information for a caller, the display will only show the phone number.
- After viewing all of the new call entries in the Caller List, "Received calls" will disappear.
- The base unit and each cordless handset have their own Caller Lists. If you viewed the Caller List on one unit, information in the other units will remain NEW and "√" will not be added.
- In step 1, you can go to the directory list by pressing [▶] (p. 32).
- If you do not press any buttons for 60 seconds, the unit will exit the Caller List.

What "√" means

"√" indicates you have already viewed this calling information, or answered the call.

SMITH, JACK
1-555-333-4444
3:10P JUN.10 √

If a caller calls more than once

The number of times the same caller called is displayed (X2 to X9). The date and time of the most recent call will be recorded. After viewing a caller's information, X2 to X9 will be replaced with "√".

Ex. Called 3 times.

TURNER, CINDY
1-555-456-7890
11:20A JAN.12 x3

Calling Back from the Caller List **Base Unit** **Handset**

1 Scroll to the desired caller by pressing [▼] or [▲].

2 *Base unit:* Lift the handset or press **[DIGITAL SP-PHONE]**.

Cordless handset:

Press [↶], [↷] or the soft key (**DIAL**).

- The phone number is dialed.

TURNER, CINDY
1-555-456-7890
11:20A JAN.12 x3

- In some cases, you may have to edit the number before dialing (see below). (Ex. You may have to delete “1” and the area code.)
- If a phone number is not displayed by Caller ID, you cannot call back that caller from the Caller List.

Editing the Caller’s Phone Number **Base Unit** **Handset**

You can edit a phone number in the Caller List to call it back or store it in the directory.

Caller ID Number Auto Edit Feature (p. 28)

This feature allows the unit to edit a Caller ID number into one of 3 patterns automatically in the Caller List. For details and activation, see page 28.

1 Scroll to the desired caller by pressing [▼] or [▲].

PARKER, FRED
1-555-321-5555

2 *Base unit:* Press **[FUNCTION/EDIT]**.

Cordless handset: Press the soft key (**EDIT**).

- Each time you press **[FUNCTION/EDIT]** or the soft key (**EDIT**), the number is rearranged into one of 3 patterns.

(a)

(b) –

(c) 1 – –

- The order in which patterns (a)–(c) are displayed depends on how the telephone number is displayed in step 1.

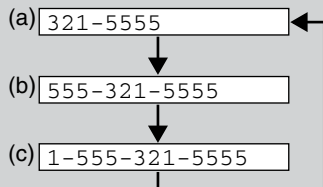

3 To continue with making a call from the Caller List, see this page above.

To continue with storing the number in the directory, press **[▶]** twice.

- If there is no name information, see “Storing Caller List Items in the Directory” on page 29.

Using the Caller List

Caller ID Number Auto Edit Feature **Base Unit** **Handset**

There are 3 patterns of phone number [(a), (b), and (c), p. 27]. This feature allows your phone to automatically edit an in-coming Caller ID number into a pattern of your choice, and display the Caller ID number with that pattern automatically.

After this feature is activated, Caller ID numbers coming from specific area codes (201, for example), from which the Caller ID numbers have been chosen to follow the desired pattern (7-digit pattern, for example), will be automatically edited from other patterns (11-digit pattern, for example) into the same pattern you have previously selected (which is 7-digit pattern, in this example).

Up to 4 area codes can be designated for this feature for pattern (a), (b), and (c) (p. 27). The Caller ID numbers can be edited automatically on the base unit and the cordless handset separately. Changes made on the cordless handset cannot be used to make a call with the base unit and vice versa.

To activate this feature, you must (1) set this feature to ON, and (2) make an out-going call from Caller List (p. 27) with a number which has one of the 3 patterns that you have edited with specific area codes, and that you prefer to be followed by future Caller ID numbers, so that in the future all the Caller ID numbers coming from the same area code will be displayed in the same pattern.

The Caller ID number Auto Edit feature is preset at the factory to ON.

- If a call does not go through, the phone number you dialed may have an incorrect pattern. Please edit the phone number with another pattern (p. 27).

For example, if you move to another area, you may need to turn this feature to OFF to erase previously edited area codes. Then, if still necessary, you may activate this feature again.

You can turn on/off the feature on the base unit and the cordless handset separately.

1 *Base unit:* Press **[FUNCTION/EDIT]**.

Cordless handset: Press **[CONF/FUNCTION]**.

2 Scroll to "Initial setting" by pressing **[▼]** or **[▲]**, then press **[▶]**.

▶Initial setting

3 Scroll to "Caller ID edit" by pressing **[▼]** or **[▲]**, then press **[▶]**.

▶Caller ID edit

4 Select "On" or "Off" by pressing **[▼]** or **[▲]**.

Auto edit

:On

5 *Base unit:* Press **[▶]** (Save), then press **[EXIT]**.

Cordless handset: Press the soft key (**SAVE**), then press **[OFF]**.

- When the feature is set to OFF, the unit will still be able to display Caller ID, but the in-coming Caller ID number will not be edited by pattern or by area codes.

Storing Caller List Items in the Directory **Base Unit** **Handset**

Callers' names and phone numbers that are in the base unit or cordless handset Caller List can be stored in each unit's directory.

- 1 Scroll to the desired caller by pressing [▼] or [▲].

- If the number requires editing, see page 27.

TURNER, CINDY 1-555-456-7890 11:20A JAN. 12 x3
--

- 2 Press [▶].

- To stop storing, press [◀].

Save directory? ◀=No ▶=Yes

- 3 Press [▶] again.

- If there is no name information for the caller, "Enter name" will be displayed.
 - You can enter a name by performing the following steps:
 - (1) enter the name (p. 31), (2) press [▼], and (3) press [▶] (Save) on the base unit or press the soft key **(SAVE)** on the cordless handset.
 - If a name is not required, press [▼], then press [▶] (Save) on the base unit or press the soft key **(SAVE)** on the cordless handset.
 - To continue storing other items, repeat from step 1.
 - To exit the programming mode, press **[EXIT]** on the base unit. For the cordless handset, press **[OFF]**.

- You cannot store Caller List items in the directory if a phone number is not displayed.

Erasing Caller List Items **Base Unit** **Handset**

To erase a specific item

- 1 Scroll to the desired caller by pressing [▼] or [▲].

- 2 *Base unit:* Press **[CLEAR]**.

Cordless handset:

Press **[HOLD/CLEAR]**.

- "Clear" is displayed.
- To erase other items, repeat from step 1.
- To exit the Caller List, press **[EXIT]** on the base unit. For the cordless handset, press **[OFF]**.

To erase all items

- 1 Press [▼] or [▲] to enter the Caller List.

- Before erasing all items, make sure that "0 new call" is displayed.

- 2 *Base unit:* Press **[CLEAR]**.

Cordless handset:

Press **[HOLD/CLEAR]**.

- To stop erasing, press [◀].

- 3 *Base unit:* Press **[CLEAR]** again.

Cordless handset:

Press **[HOLD/CLEAR]** again.

- "All clear" is displayed and all items in your Caller List are erased.

Directory

You can store up to 50 names and phone numbers in the base unit or the cordless handset directory. All directory items are sorted by the first word in alphabetical order. You can make a call by selecting a name on the display. You can also copy your directory items to another extension (p. 34, 35).

Storing Names and Numbers **Base Unit** **Handset**

You can store names and phone numbers in the base unit and the cordless handset directories separately.

1 *Base unit:* Press **[FUNCTION/EDIT]**.

Cordless handset: Press **[CONF/FUNCTION]**.

2 Press **[▶]** at “Save directory”.

- The display will show the number of stored items.

3 Enter a name, up to 16 characters with the dialing buttons (0 to 9) (p. 31), then press **[▼]**.

- If a name is not required, press **[▼]** then go to step 4.

4 Enter a phone number, up to 22 digits.

- To move the cursor, press **[◀]** or **[▶]**.
- To delete a digit, press **[CLEAR]** on the base unit or press **[HOLD/CLEAR]** on the cordless handset. To erase all of the digits, press and hold **[CLEAR]** or **[HOLD/CLEAR]**.

5 Press **[▼]**.

- If you want to change the name or number, press **[▲]** to reach the desired display and change it.

6 *Base unit:* Press **[▶]** (Save).

Cordless handset: Press the soft key (**SAVE**).

- To continue storing other items, repeat from step 2.

7 *Base unit:* Press **[EXIT]**.

Cordless handset: Press **[OFF]**.

- If a pause is required for dialing, press **[REDIAL/PAUSE]** on the base unit or **[PAUSE/REDIAL]** on the cordless handset, in step 4. A pause stored in a phone number counts as one digit (p. 49).

Selecting characters to enter names

Enter names using the dialing buttons. Press each button until the desired character is displayed.

- Pressing each button selects a character in the order shown below.

Keys	Characters	Keys	Characters
[1]	# & ' () * , - . / 1	[6]	m n o M N O 6
[2]	a b c A B C 2	[7]	p q r s P Q R S 7
[3]	d e f D E F 3	[8]	t u v T U V 8
[4]	g h i G H I 4	[9]	w x y z W X Y Z 9
[5]	j k l J K L 5	[0]	0 Space
[◀]	Moves the cursor to the left.		
[▶]	Moves the cursor to the right. (To enter another character using the same number key, move the cursor to the next space.)		

For example, to enter “Tom”:

1. Press [8] four times.
2. Press [6] three times, then press [▶] to move the cursor.
3. Press [6] once.

T

To

Tom

If you make a mistake while entering a name or number

1. Press [◀] or [▶] to move the cursor to the incorrect character.
2. *Base unit:* Press [CLEAR] to delete the character.
Cordless handset: Press [HOLD/CLEAR] to delete the character.
 - Each time you press [CLEAR] or [HOLD/CLEAR], a character is erased.
 - To erase all characters, press and hold [CLEAR] or [HOLD/CLEAR].
3. Enter the correct character.

Directory

Dialing from the Directory **Base Unit** **Handset**

- 1 Press [**◀**] or [**▶**] to enter the directory list.
 - The display shows the number of stored items.

Directory list
30 items
▼▲
▶=Caller list

- 2 Scroll to the desired item. To scroll down, press [**▼**]. To scroll up, press [**▲**].

Directory items are sorted in the following order:	
1	Alphabet letters (Alphabetical)
2	& ' () , - . /
3	Numbers 0 to 9
4	# *
5	Telephone numbers (If no name is stored)

Frank
555-456-7890

- 3 *Base unit:* Lift the handset or press [**DIGITAL SP-PHONE**].

Cordless handset: Press [**↶**] or [**↷**].

- The phone number is dialed.

- If “No items stored” is displayed in step 1, the directory list is empty.
- To exit the directory list, press [**EXIT**] on the base unit or press [**OFF**] on the cordless handset.
- In step 1, you can go to the Caller List by pressing [**▶**] (p. 26).

To search for a name by initial

1. Press [**◀**] or [**▶**] to enter the directory list.
2. Press the dialing button for the first letter of the desired name until any name with the same initial is displayed (see the Index table below).

Ex. To find “Frank”, press [**3**] repeatedly until the first item under “F” is displayed.
3. Press [**▼**] repeatedly until the desired name is displayed.



Index table

Keys	Index	Keys	Index
[1]	Other symbols, 1	[6]	M, N, O, 6
[2]	A, B, C, 2	[7]	P, Q, R, S, 7
[3]	D, E, F, 3	[8]	T, U, V, 8
[4]	G, H, I, 4	[9]	W, X, Y, Z, 9
[5]	J, K, L, 5	[0]	0, Space

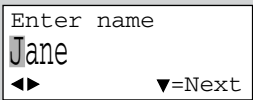
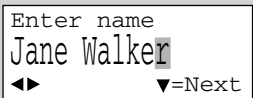
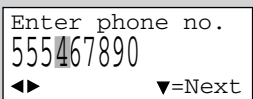
Editing an Item in the Directory **Base Unit** **Handset**

<p>1 Press [◀] or [▶], then scroll to the desired directory item by pressing [▼] or [▲].</p> <ul style="list-style-type: none"> To search for the item by initial, see page 32. 	
<p>2 <i>Base unit:</i> Press [FUNCTION/EDIT]. <i>Cordless handset:</i> Press the soft key (EDIT).</p>	
<p>3 Edit the name (p. 31), then press [▼].</p> <ul style="list-style-type: none"> If you do not need to change the name, press [▼] then go to step 4. 	
<p>4 Edit the phone number, then press [▼].</p> <ul style="list-style-type: none"> If you do not need to change the number, press [▼] then go to step 5. To delete a digit, press [CLEAR] on the base unit or press [HOLD/CLEAR] on the cordless handset. To erase all of the digits, press and hold [CLEAR] or [HOLD/CLEAR]. To move the cursor, press [◀] or [▶]. 	
<p>5 <i>Base unit:</i> Press [▶] (Save). <i>Cordless handset:</i> Press the soft key (SAVE).</p>	
<p>6 <i>Base unit:</i> Press [EXIT]. <i>Cordless handset:</i> Press [OFF].</p>	

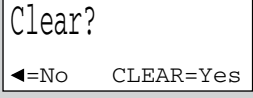
Erasing an Item in the Directory **Base Unit** **Handset**

<p>1 Press [◀] or [▶], then scroll to the desired directory item by pressing [▼] or [▲].</p> <ul style="list-style-type: none"> To search for the item by initial, see page 32. 	
<p>2 <i>Base unit:</i> Press [CLEAR]. <i>Cordless handset:</i> Press [HOLD/CLEAR].</p> <ul style="list-style-type: none"> To stop erasing, press [◀]. 	
<p>3 <i>Base unit:</i> Press [CLEAR] again. <i>Cordless handset:</i> Press [HOLD/CLEAR] again.</p> <ul style="list-style-type: none"> "Clear" is displayed. 	
<p>4 <i>Base unit:</i> Press [EXIT]. <i>Cordless handset:</i> Press [OFF].</p>	

Directory

Copying the Directory **Base Unit** **Handset**

You can copy a directory item or all the items between the base unit and the cordless handset, and between two cordless handsets (when the system has one or more additional cordless handsets, p. 20). Entries copied to the destination unit are added to its directory.

- If an external call is received during the directory transfer, the transfer will be stopped. You will need to re-send the item(s) later.
- After the transfer has started, do not place your cordless handset on the charger until the transfer completes, otherwise the transfer will be stopped.

To copy one directory item to another unit

- 1 Make sure the destination unit is not in use.

Base unit: Press **[FUNCTION/EDIT]**.

Cordless handset: Press **[CONF/FUNCTION]**.

- 2 Scroll to “Copy directory” by pressing **[▼]** or **[▲]**, then press **[▶]**.

▶Copy directory

- 3 Press **[▶]** at “Copy 1 item”.

▶Copy 1 item

- 4 Select the destination extension number by pressing **[▼]** or **[▲]**. (“0” for the base unit, “1– 8” for the cordless handset)

- You can also select the extension number by pressing **[0]**, **[1]** to **[8]**.

Enter extension#
:1
▼▲ ▶=Next

- 5 Press **[▶]**.

Select item

- 6 Scroll to the desired directory item by pressing **[▼]** or **[▲]**.

- To search for the item by initial, see page 32.

- 7 *Base unit:* Press **[▶]** (Send).

Cordless handset: Press the soft key **(SEND)**.

- You can continue copying another item.

Complete

- 8 *Base unit:* Press **[EXIT]**.

Cordless handset: Press **[OFF]**.

To copy all of the items in your directory to another unit

1 Make sure the destination unit is not in use.

Base unit: Press **[FUNCTION/EDIT]**.

Cordless handset: Press **[CONF/FUNCTION]**.

2 Scroll to “Copy directory” by pressing **[▼]** or **[▲]**, then press **[▶]**.

▶Copy directory

3 Scroll to “Copy all items” by pressing **[▼]** or **[▲]**, then press **[▶]**.

▶Copy all items

4 Select the destination extension number by pressing **[▼]** or **[▲]**. (“0” for the base unit, “1– 8” for the cordless handset)

Enter extension#
:1

- You can also select the extension number by pressing **[0]**, **[1]** to **[8]**.

5 *Base unit:* Press **[▶]** (Send).

Cordless handset: Press the soft key **(SEND)**.

- When all items have been transferred, “Complete” is displayed.
- The destination unit displays “Directory Receiving” then “Directory Received”.
- You can continue copying items to another extension.

Ex. Copying 1st item out of 10 items

Tom Jones
555-765-4321
01/10

6 *Base unit:* Press **[EXIT]**.

Cordless handset: Press **[OFF]**.

- You can exit the directory copying mode by pressing **[EXIT]** on the base unit or **[OFF]** on the cordless handset.

Intercom

A 2-way intercom can be set up between the base unit and a cordless handset, and between two cordless handsets (when the system has one or more additional cordless handsets, p. 20). You can call all cordless handsets from the base unit at once.

- Using this feature, you can also locate a misplaced cordless handset.

Making Intercom Calls

Base Unit

1 Press **[LOCATOR/INTERCOM/TRANSFER]**.

- The LOCATOR/INTERCOM/TRANSFER indicator and the DIGITAL SP-PHONE indicator light.

To switch from the speakerphone to the handset, lift it off the cradle.

Press extension#
to call
MUTE=Monitor

2 To page all cordless handsets, press **[0]**.

To page a cordless handset, press its extension number (**[1]** to **[8]**).

- The cordless handset(s) will ring for 1 minute.
- To stop paging, place the handset on the cradle, or if using the speakerphone, press **[DIGITAL SP-PHONE]** or **[LOCATOR/INTERCOM/TRANSFER]**.

Ex. Calling all Handsets

Paging [ALL]

Ex. Calling Handset 1

Calling [1]

3 When the paged party answers, talk into the **MIC** or handset.

Intercom
00-00-05
■01

4 To disconnect the intercom, place the handset on the cradle, or if using the speakerphone, press **[DIGITAL SP-PHONE]** or **[LOCATOR/INTERCOM/TRANSFER]**.

Handset

1 Press **[HOLD] (INTERCOM)**.

Press extension#
to call

2 To page the base unit, press **[0]**.

To page another cordless handset, press the extension number (**[1]** to **[8]**).

- The paged unit will ring for 1 minute.
- To stop paging, press **[OFF]**.

Ex. Calling Base unit

Calling [0]

Ex. Calling Handset 2

Calling [2]

3 When the paged party answers, start talking.

- You can switch to the speaker by pressing **[☎]**. To switch back to the receiver, press **[↶]**.

Intercom
00-00-05
■01

4 To disconnect the intercom, press **[OFF]** or place the cordless handset on the charger.

During an intercom call:

- If you have difficulty hearing, decrease the speaker volume by pressing [▼].
- If an incoming call is being received, you will hear two tones (incoming call tone, p. 49).

To answer the call;

- if using the base unit handset, place it on the cradle then lift it up.
- if using the base unit speakerphone, press **[DIGITAL SP-PHONE]** twice.
- if using the cordless handset, press **[OFF]** and press [↶] or [↷].

Answering Intercom Calls

Base Unit

When an intercom call is being received, the base unit rings and the LOCATOR/INTERCOM/TRANSFER indicator flashes. The display shows the calling extension number.

- 1 Lift the handset off the cradle, or press **[LOCATOR/INTERCOM/TRANSFER]** or **[DIGITAL SP-PHONE]**.
- 2 To disconnect the intercom, place the handset on the cradle, or if using the speakerphone press **[DIGITAL SP-PHONE]** or **[LOCATOR/INTERCOM/TRANSFER]**.

Handset

When an intercom call is being received, the cordless handset rings and the display shows the calling extension number.

- 1 Press [↶], [↷] or **[HOLD]** (**INTERCOM**).
 - You can also answer the call by pressing any dialing button ([0] to [9], [#] or [*])(**Any Key Talk**).
- 2 To disconnect the intercom, press **[OFF]** or place the cordless handset on the charger.

Auto Talk

If you set the Auto Talk feature to ON (p. 19), you can answer a call by lifting the cordless handset off the charger without pressing [↶], [↷] or **[HOLD]** (**INTERCOM**).

- When the ringer volume is off (p. 18), the base unit and the cordless handset will ring at the LOW level for intercom calls.
- You cannot change the ringer tone for intercom calls.
- When the base unit user pages all cordless handsets, only the cordless handset user who answers first can talk with the base unit user.

Transferring a Call **Base Unit** **Handset**

You can transfer an external call between the base unit and the cordless handset, or between two cordless handsets (when the system has one or more additional cordless handsets, p. 20.)

From the base unit to the cordless handset

1 *Base unit:*

- (1) During a call, press **[LOCATOR/INTERCOM/TRANSFER]**.
 - If the line is on hold, release the hold (p. 22) before pressing **[LOCATOR/INTERCOM/TRANSFER]**.
- (2) To page a cordless handset, press its extension number (**[1]** to **[8]**).
To page all cordless handsets, press **[0]**.
- (3) Wait for the cordless handset user to answer, and you can announce the transfer.
 - If the paged party does not answer, press **[LOCATOR/INTERCOM/TRANSFER]** to return to the outside call.

Press extension#
to transfer
0-8=Extension

- ### 2 *Cordless handset:* Press **[↶]**, **[↷]** or **[HOLD] (INTERCOM)** to answer the page.

Call from [0]

- ### 3 *Base unit:* To complete the transfer, place the handset on the cradle or if using the speakerphone, press **[DIGITAL SP-PHONE]**.

- When the base unit user calls all cordless handsets, only the cordless handset user who answers first can take the transferred call.

From the cordless handset to the base unit

1 *Cordless handset:*

- (1) During a call, press **[HOLD] (TRANSFER)**.
 - The call is put on hold.
- (2) To page the base unit, press **[0]**.
- (3) Wait for the paged party to answer, and you can announce the transfer.
 - If the paged party does not answer, press **[↶]** or **[↷]** to return to the outside call.

Press extension#
to transfer
0-8=Extension

- ### 2 *Base unit:* Lift the handset or press **[DIGITAL SP-PHONE]** or **[LOCATOR/INTERCOM/TRANSFER]** to answer the page.

Ex. Handset 1 calling

Call from [1]

- ### 3 *Cordless handset:* To complete the transfer, press **[OFF]**.

From a cordless handset to another cordless handset (when the system has one or more additional cordless handsets)

1. During a call, press **[HOLD] (TRANSFER)**, then page another cordless handset by pressing its extension number (**[1]** to **[8]**).
2. Wait for the paged party to answer, and you can announce the transfer.
 - The paged handset user can answer by pressing **[↶]**, **[↷]** or **[HOLD] (INTERCOM)**.
3. To complete the transfer, press **[OFF]**.

If you do not announce the transfer (Quick call transfer)

You can hang up a call before the paged party answers your page.

Base unit:

During a call, press **[LOCATOR/INTERCOM/TRANSFER]**, and press the extension number (**[1]** to **[8]**) or press **[0]** to page all extensions, then place the handset on the cradle or press **[DIGITAL SP-PHONE]** to hang up.

Cordless handset:

During a call, press **[HOLD] (TRANSFER)** and press the extension number (**[0]** for the base unit, **[1]** to **[8]** for the cordless handset), then press **[OFF]** to hang up.

- The call will be transferred directly.
- The paged party can take the transferred call by pressing **[↶]**, **[↷]** or **[DIGITAL SP-PHONE]**, or by lifting the base unit handset.
- After the paged party answers, the transfer is complete.
- If the paged party does not answer:
 - for the base unit, lift the handset or press **[DIGITAL SP-PHONE]** to return to the outside call.
 - for the cordless handset, press **[↶]** or **[↷]** to return to the outside call.

- Any user can take a transferred call by pressing **[↶]**, **[↷]** or **[DIGITAL SP-PHONE]**, or by lifting the base unit handset.
- If you do not announce the transfer and the paged party does not answer within 60 seconds after you hang up, your phone will ring and the call will be returned to your phone. You may speak to the caller again by lifting the base unit handset or pressing **[DIGITAL SP-PHONE]**, **[↶]** or **[↷]**.
If you do not answer the call within 4 minutes, the call will be disconnected.

Conference Calls

While you are talking with an outside caller, you can call the base unit or the cordless handset to make a conference call. When the system has one or more additional cordless handsets (p. 20), you can make a conference call with your cordless handset and another cordless handset.

Base Unit

- 1 During a call, press **[LOCATOR/INTERCOM/TRANSFER]**.
 - The call is put on hold.
 - 2 To page the cordless handset, press the extension number (**[1]** to **[8]**).
 - 3 When the paged party answers, press **[CONF]** on your unit to make a conference call.
-

Handset

- 1 During a call, press **[HOLD] (INTERCOM)**.
 - The call is put on hold.
 - 2 To page the base unit, press **[0]**. To page another cordless handset, press the extension number (**[1]** to **[8]**).
 - 3 When the paged party answers, press **[CONF/FUNCTION]** on your unit to make a conference call.
-

- To leave the conference, place the base unit handset, or press **[DIGITAL SP-PHONE]** on the base unit or press **[OFF]** on the cordless handset. The two other parties can continue the conversation.
- During a conference, the outside call can be placed on hold by pressing **[HOLD]** on the base unit or **[HOLD] (INTERCOM)** on the cordless handset. Internal communications between extensions are not suspended. Only the person who placed the call on hold can resume the full conference; press **[CONF]** on the base unit or **[CONF/FUNCTION]** on the cordless handset.
- Two more extensions can join the conference call if all other extensions are not being used. To join the conference call, press **[↶]**, **[↷]** or **[DIGITAL SP-PHONE]** or lift the base unit handset. A maximum of five parties including the outside party can take part in a conference call.

Call Share

This feature allows the base unit or the cordless handset to join the existing external call.

To join a conversation (Call Share) **Base Unit** **Handset**

Base unit: Lift the handset off the cradle or press **[DIGITAL SP-PHONE]**.

Cordless handset: Press **[↶]** or **[↷]**.

- “Conference” is displayed.
- A maximum of five parties including the outside party can join a conversation if all other extensions are not being used.

Call Privacy Feature

To prevent other users from joining your conversation, turn this feature on during a call. To allow other users to join your conversation, leave the feature off.

To turn the Call Privacy Feature on **Base Unit** **Handset**

Base unit: Press [**PRIVACY**] while talking.

Cordless handset: Press the soft key (**PRIVACY**) while talking.

- “PRIVACY” will be displayed.
- To turn the feature off, press [**PRIVACY**] on the base unit or press the soft key (**PRIVACY**) on the cordless handset again while talking.
- When the Call Privacy feature is turned on, other users cannot join the conversation. The feature will return to off after you hang up the call.

Room Monitor Feature

This feature allows you to monitor a room through the unit by using the intercom feature. For example, you can monitor a baby from different areas of the house. You can call the destination unit to monitor the room. The called unit will not ring. When the system has one or more additional cordless handsets (p. 20), you can monitor through one cordless handset to another.

If you allow other users to monitor through your unit, turn the feature on. If you want to prevent your unit from being monitored by other extensions, leave this feature off (factory preset).

To turn the Room Monitor feature on **Base Unit** **Handset** (to allow other users to monitor through your base unit or cordless handset)

You can turn the feature on on the base unit and the cordless handset separately.

1 *Base unit:* Press [**FUNCTION/EDIT**].

Cordless handset: Press [**CONF/FUNCTION**].

2 Scroll to “Initial setting” by pressing [**▼**] or [**▲**], then press [**▶**].

▶Initial setting

3 Scroll to “Room monitor” by pressing [**▼**] or [**▲**], then press [**▶**].

▶Room monitor

4 Select “On” by pressing [**▼**] or [**▲**].

Room monitor
:On

5 *Base unit:* Press [**▶**] (Save), then press [**EXIT**].

Cordless handset: Press the soft key (**SAVE**), then press [**OFF**].

- To prevent your base unit or cordless handset from being monitored, select “off” in step 4.

Room Monitor Feature

- You can also turn on/off the base unit Room Monitor feature, by using the cordless handset. Perform the following steps:
 - (1) Press **[CONF/FUNCTION]**.
 - (2) Scroll to “Initial setting” by pressing **[▼]** or **[▲]**, then press **[▶]**.
 - (3) Scroll to “Set base unit” by pressing **[▼]** or **[▲]**, then press **[▶]**.
 - (4) Scroll to “Room monitor” by pressing **[▼]** or **[▲]**, then press **[▶]**.
 - (5) Select “On” or “Off” by pressing **[▼]** or **[▲]**, press the soft key (**SAVE**), and press **[OFF]**.

To monitor with **Base Unit**

The destination cordless handset must not be in use.

- 1 Press **[LOCATOR/INTERCOM/TRANSFER]**, then press **[MUTE]**.

```
Press extension#  
to call  
MUTE=Monitor
```

- 2 To call the cordless handset, press the extension number (**[1]** to **[8]**).

- To monitor from the base unit handset, lift it off the cradle. To switch back to the speaker, press **[DIGITAL SP-PHONE]**.

```
Press extension#  
for room monitor
```

```
Room monitor  
00-00-05  
■01
```

- 3 To end monitoring, place the handset on the cradle, or if using the speakerphone, press **[LOCATOR/INTERCOM/TRANSFER]** or **[DIGITAL SP-PHONE]**.

To monitor with **Handset**

The destination unit must not be in use.

- 1 Press **[HOLD]** (**INTERCOM**), then press the soft key (**MONITOR**).

- 2 To call the base unit, press **[0]**.
To call another cordless handset, press its extension number (**[1]** to **[8]**).

- To monitor from the speaker, press **[📞]**. You can place the cordless handset on the charger. To switch back to the receiver, press **[📞]**.

```
Press extension#  
for room monitor
```

```
Room monitor  
00-00-05  
■01
```

- 3 To end monitoring, press **[OFF]**.

- The monitored user can stop being monitored by:
 - on the base unit, press **[LOCATOR/INTERCOM/TRANSFER]** or **[DIGITAL SP-PHONE]**.
 - on the cordless handset, press **[OFF]**.
- “Room monitor” is also displayed on the monitored unit.
- While the base unit is monitoring or being monitored, the LOCATOR/INTERCOM/TRANSFER indicator flashes and the DIGITAL SP-PHONE indicator lights.

2-Way Radio Communication

(When the System Has Additional Handsets)

Handset

If you purchase one or more additional cordless handsets (KX-TGA270S, KX-TGA271B, KX-TGA271V, KX-TGA271W and KX-TGA273S) (p. 20), you can use this feature. A cordless handset user can talk with another cordless handset user regardless of the base unit location. 2-Way Radio communication, which is the direct communication between a pair of cordless handsets, does not need the base unit interface.

You need to turn on 2-Way Radio mode on the cordless handsets to use this feature.

Once this mode is turned on, your cordless handset can be used only to talk with another cordless handset user, and the following features cannot be used on your cordless handset:

- Making/answering external and intercom calls
- Searching the Caller List or directory
- Programming
- Receiving Caller ID information

After using 2-Way Radio mode, remember to turn the mode off to resume above functions and save battery operating time (p. 12).

To turn 2-Way Radio mode on

1 Press [CONF/FUNCTION] .	
2 Scroll to "2Way radio mode" by pressing [▼] or [▲] , then press [▶] .	▶2Way radio mode
3 Select "On" by pressing [▼] or [▲] .	2Way radio mode :On
4 Press the soft key (SAVE).	2Way radio mode

To turn 2-Way Radio mode off:

Place the cordless handset on the charger.

- "2Way radio mode" will disappear.
- You can also turn off 2-Way Radio mode by performing the following three steps:
 - (1) Press **[CONF/FUNCTION]**.
 - (2) Select "Off" by pressing **[▼]** or **[▲]**.
 - (3) Press the soft key (**SAVE**).

2-Way Radio Communication

To call another cordless handset

Make sure 2-Way Radio mode is on on your cordless handset and the destination cordless handset, and the displays show “2Way radio mode”.

1 Press [**↶**], [**↷**] or [**HOLD**] (INTERCOM).

```
Press extension#  
to call  
2Way radio mode
```

2 Press the extension number ([**1**] to [**8**]).

- The called cordless handset will ring for 1 minute.
- To stop calling, press [**OFF**].

Ex. Calling Handset 3

```
Calling [3]  
2Way radio mode
```

3 When the called party answers, start talking.

- After a few seconds, the display will show the length of the call.
- You can switch to the receiver or the speaker by pressing [**↶**] or [**↷**].

```
Talk  
00-00-05  
    ■ 1 3  
2Way radio mode
```

4 To end the conversation, press [**OFF**].

- To adjust the receiver volume (High, Medium or Low) or speaker volume (6 levels) while talking, press [**▼**] or [**▲**].

To adjust the ringer volume for 2-Way Radio mode (High, Medium, Low or OFF):

To increase ringer volume, press [**▲**] while the cordless handset is not in use. To decrease ringer volume, press [**▼**].

- To turn the ringer off, press [**▼**] until “Off” is displayed. “Ringer off” will be displayed and the unit will not ring in 2-Way Radio mode.
- You cannot change the ringer tone for 2-Way Radio mode.

To answer a call

After the ring, press [**↶**], [**↷**] or [**HOLD**] (INTERCOM).

- You can also answer a call by pressing any dialing button ([**0**] to [**9**], [**#**] or [*****])(Any Key Talk).
- To end the conversation, press [**OFF**].

Voice Mail Service

Voice mail is an electronic on-line answering service offered by your telephone company. If you subscribe to this service, the voice mail system can answer calls for you when you are unavailable to answer the phone or when your line is busy. Callers can leave messages that are saved in virtual voice mail boxes, which are maintained for you at the phone company, allowing you to listen to your messages whenever you like.

The unit will let you know that someone has left voice mail for you (p. 47).

For quick access to your voice mail box by using [VM] on the base unit or the soft key (**MAIL**) on the cordless handset, first store your access number.

Storing Your Voice Mail Access Number

(use either **Base Unit** or **Handset**)

Base Unit

1 Press [FUNCTION/EDIT].	
2 Scroll to "Initial setting" by pressing [▼] or [▲], then press [▶].	▶Initial setting
3 Scroll to "Voice mail" by pressing [▼] or [▲], then press [▶].	▶Voice mail
4 Scroll to "Save VM access#" by pressing [▼] or [▲], then press [▶].	▶Save VM access#
5 Enter your access number, up to 32 digits. <ul style="list-style-type: none">You may enter pauses* (see page 46).To delete a digit, press [CLEAR].To erase all of the digits, press and hold [CLEAR].	Save VM access# █
6 Press [▼] (Save), then press [EXIT]. <ul style="list-style-type: none">"MAIL" is displayed on the cordless handset display.	Save VM access# 12344567PPP8901█

To erase the stored number

Repeat steps 1 through 4 and press and hold [CLEAR] until all of the digits are erased. Press [▼] (Save), then press [EXIT].

Handset

Press [CONF/FUNCTION], and follow steps 2 to 5 above, using the cordless handset. Press the soft key (**SAVE**), then press [OFF].

- "MAIL" is displayed.
- To erase the stored number, press and hold [HOLD/CLEAR] in step 5, press the soft key (**SAVE**), and press [OFF].

Voice Mail Service

*To prevent misdialing, you may add pauses between your voice mail box access number and your mail box password on page 45, in step 5.

Ex. 1-222-333-4444 P P P P 8888

Your voice mail box access number Pauses Your mail box password

Pressing **[REDIAL/PAUSE]** on the base unit or **[PAUSE/REDIAL]** on the cordless handset once creates a 3.5 seconds delay and counts as one digit. The delay time necessary between entering your access number and entering your mail box password will depend on your telephone company.

Setting Voice Mail (VM) Tone Detection (use either **Base Unit** or **Handset**)

Your telephone company sends special signals (Voice mail tones) to activate the VM indicator. Lift the base unit handset, or press **[DIGITAL SP-PHONE]**, **[↶]** or **[↷]** to listen to the dial tone. If you hear a series of dial tones followed by a continuous dial tone, this indicates that a new message was recorded. Voice Mail detection is preset at the factory to ON. Minutes after you hang up or after the phone stops ringing, your unit will seize the phone line and check if a message has been recorded. If a new message was recorded at your telephone company, the base unit VM indicator will flash and “Voice mail” will be displayed on the cordless handset.

Set this programming to OFF when:

- you do not subscribe to a voice mail service,
- your telephone company does not send a series of tones, followed by a continuous tone to indicate you have new voice mail, or
- your phone is connected to a business or office telephone system (PBX).

See below to turn this setting OFF.

If you are not sure which setting is required, consult your local telephone company or contact the Panasonic Customer Call Center.

Base Unit

1 Press **[FUNCTION/EDIT]**.

2 Scroll to “Initial setting” by pressing **[▼]** or **[▲]**, then press **[▶]**.

▶Initial setting

3 Scroll to “Voice mail” by pressing **[▼]** or **[▲]**, then press **[▶]**.

▶Voice mail

4 Press **[▶]** at “VM tone detect”.

▶VM tone detect

5 Select “Off” or “On” by pressing **[▼]** or **[▲]**.

VM tone detect
:On

6 Press **[▶]** (Save), then press **[EXIT]**.

Handset

Press **[CONF/FUNCTION]**, and follow steps 2 to 5 above, using the cordless handset. Press the soft key **(SAVE)**, then press **[OFF]**.

Listening to Voice Mail Messages **Base Unit** **Handset**

The unit will let you know that someone has left voice mail for you in three ways;

- (a) VM indicator will flash on the base unit,
- (b) "Voice mail" will be displayed on the cordless handset, and
- (c) "**MAIL**" will flash on the cordless handset.

To listen to your voice mail message(s), follow the steps below.

Base Unit

1 Press **[VM]**.

- The base unit connects to the telephone line and dials the access number (p. 45).
- To switch from the speakerphone to the handset, lift it off the cradle.

2 Follow the pre-recorded instructions.

3 When finished, place the handset on the cradle or if using the speakerphone press **[DIGITAL SP-PHONE]**.

Handset

1 Press the soft key (**MAIL**), then press [**↶**] or [**↷**].

- The cordless handset connects to the telephone line and dials the access number (p. 45).

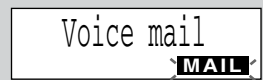

2 Follow the pre-recorded instructions.

3 When finished, press **[OFF]**.

- If "Store VM access#" is displayed and 3 beeps sound, store the number (p. 45).
- After listening to your message(s), "**MAIL**" stops flashing but remains on the cordless handset display.
- If the base unit and cordless handset still indicate you have new messages even after you have listen to them, turn them off as follows.
 - for the base unit: Press **[FUNCTION/EDIT]**, then press and hold **[CLEAR]** until the unit beeps.
 - for the cordless handset: Press **[CONF/FUNCTION]**, then press and hold **[HOLD/CLEAR]** until the unit beeps."Voice mail" will disappear, "**MAIL**" on the cordless handset stops flashing but remains and the VM indicator will turn off.
- If your voice mail service uses a voice mail tone and the recorded message is over 3 minutes long, the base unit and cordless handset may not indicate you have new messages.
- If your voice mail service uses a voice mail tone, the tone will be heard from any parallel connected phone. If you use another phone to retrieve messages, you have to dial your access number manually.

Special Features

Muting Your Conversation **Base Unit** **Handset**

During a call, you can mute your phone so the other party cannot listen to you. When muting your conversation, you can hear the other party.

Base unit: Press **[MUTE]**.

- The MUTE indicator lights.
- “Mute” will be displayed for a few seconds.
- **To release the mute**, press **[MUTE]** again.
- If you press **[DIGITAL SP-PHONE]** or lift the handset to switch between the speaker and handset, the mute will be released.

Cordless handset: Press the soft key (**MUTE**).

- “Mute” will be displayed for a few seconds and “**MUTE**” will flash.
- **To release the mute**, press the soft key (**MUTE**) again.
- If you press [**↶**] or [**↷**] to switch between the receiver and speaker, the mute will be released.

Temporary Tone Dialing

(For Rotary or Pulse Service Users) **Base Unit** **Handset**

Press [**✖**] (TONE) before entering access numbers which require tone dialing.

- The dialing mode changes to tone. You can enter numbers to access an answering service, electronic banking service, etc. When you hang up, the dialing mode will return to pulse.

For Call Waiting Service Users **Base Unit** **Handset**

Press **[FLASH/CALL WAIT]** if you hear a call-waiting tone while talking.

- The first call is put on hold and you can answer the second call.
- To return to the first caller, press **[FLASH/CALL WAIT]** again.
- Call Waiting service cannot be used when the first call is put on hold.
- If this function does not operate properly, consult your telephone company for details.

Call Waiting Caller ID Feature

Call Waiting Caller ID Feature allows your unit to display the second caller's information. After you hear a call-waiting tone while talking, the display shows the caller's name with the phone number and “Waiting”.

BROWN, NANCY 1-555-666-7777 ----Waiting----

- Please contact your telephone company for details and availability in your area.

Using the PAUSE Button (For PBX Line/Long Distance Calls) **Base Unit** **Handset**

We recommend you press **[REDIAL/PAUSE]** on the base unit or **[PAUSE/REDIAL]** on the cordless handset if a pause is required for dialing with a PBX or to make a long distance call.

Ex. Line access number **[9]** (PBX)

[9] → **[REDIAL/PAUSE]** or **[PAUSE/REDIAL]** →

- Pressing **[REDIAL/PAUSE]** or **[PAUSE/REDIAL]** once creates a 3.5 second pause. This prevents misdialing when you redial or dial a stored number.
- Pressing **[REDIAL/PAUSE]** or **[PAUSE/REDIAL]** more than once increases the length of the pause between numbers.

Incoming Call Tone **Base Unit** **Handset**

During an intercom call or while using the Room Monitor feature, you can be informed by two tones if a call arrives.

If you set incoming call tone to ON, this incoming call tone will be heard for as long as the line rings. To bypass the incoming call tone, set it to OFF. To set the incoming call tone to sound twice, set to "2". The factory preset is "2".

You can set the incoming call tone on the base unit or the cordless handset separately.

1 *Base unit:* Press **[FUNCTION/EDIT]**.

Cordless handset: Press **[CONF/FUNCTION]**.

2 Scroll to "Ringer setting" by pressing **[▼]** or **[▲]**, then press **[▶]**.

▶Ringer setting

3 Scroll to "Incoming call" by pressing **[▼]** or **[▲]**, then press **[▶]**.

▶Incoming call

4 Select "On", "Off" or "2" by pressing **[▼]** or **[▲]**.

Incoming call
tone :2

5 *Base unit:* Press **[▶]** (Save), then press **[EXIT]**.

Cordless handset: Press the soft key **(SAVE)**, then press **[OFF]**.

- You can also set the incoming call tone for the base unit, by using the cordless handset. Perform the following steps:
 - (1) Press **[CONF/FUNCTION]**.
 - (2) Scroll to "Initial setting" by pressing **[▼]** or **[▲]**, then press **[▶]**.
 - (3) Scroll to "Set base unit" by pressing **[▼]** or **[▲]**, then press **[▶]**.
 - (4) Press **[▶]** at "Incoming call".
 - (5) Select "On", "Off" or "2" by pressing **[▼]** or **[▲]**, press the soft key **(SAVE)**, and press **[OFF]**.

Special Features

FLASH Button **Base Unit** **Handset**

Pressing **[FLASH/CALL WAIT]** also allows you to use special features of your host PBX such as transferring an extension call or accessing optional telephone services such as call waiting.

- Pressing **[FLASH/CALL WAIT]** cancels the Temporary Tone Dialing mode or the mute (p. 48).

Selecting the flash time (use either **Base Unit** or **Handset**)

The flash time depends on your telephone exchange or host PBX.

You can select the following flash times: “700, 600, 400, 300, 250, 110, 100 or 90 ms (milliseconds)”. The factory preset is “700 ms”.

- If the unit is connected via a PBX, PBX functions (transferring a call etc.) might not work correctly. Consult your PBX supplier for the correct settings.

Base Unit

1 Press **[FUNCTION/EDIT]**.

2 Scroll to “Initial setting” by pressing **[▼]** or **[▲]**, then press **[▶]**.

▶Initial setting

3 Scroll to “Set tel line” by pressing **[▼]** or **[▲]**, then press **[▶]**.

▶Set tel line

4 Scroll to “Set flash time” by pressing **[▼]** or **[▲]**, then press **[▶]**.

▶Set flash time

5 Select the flash time by pressing **[▼]** or **[▲]**.

Set flash time
:700ms

6 Press **[▶]** (Save), then press **[EXIT]**.

Handset

Press **[CONF/FUNCTION]**, and follow steps 2 to 5 above, using the cordless handset. Press the soft key **(SAVE)**, then press **[OFF]**.

Belt Clip **Handset**

You can hang the cordless handset on your belt or pocket using the belt clip.

To attach the belt clip

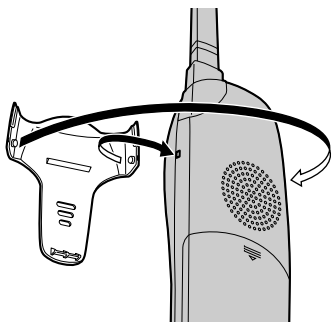

To remove the belt clip

While pressing the top of the clip (A), pull the right edge in the direction of the arrow (B).

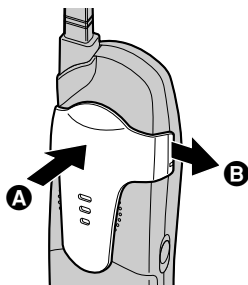

Optional Headset **Handset**

Plugging the optional headset into the cordless handset allows for hands-free phone conversation. Please use only a Panasonic KX-TCA60, KX-TCA86, KX-TCA88, KX-TCA91, KX-TCA92 or KX-TCA98 headset. To order, call the accessories telephone number on page 2.

Connecting an optional headset

Open the headset jack cover, and connect the optional headset to the headset jack as shown below.

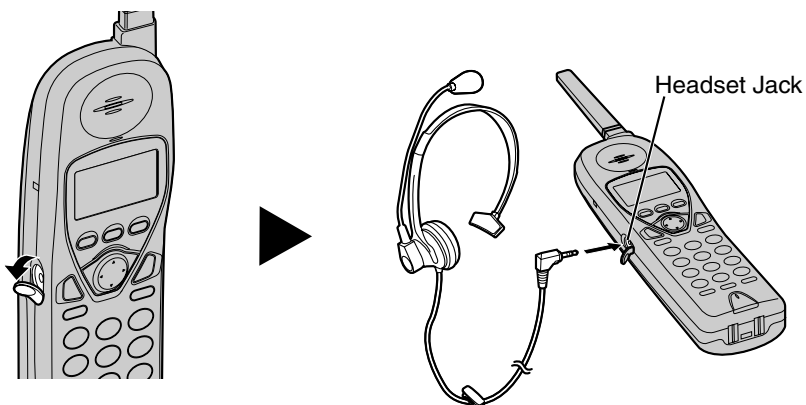

- Headset sold separately. Model shown here is KX-TCA88.

To switch to the speakerphone while using the headset:

Press [📞]. To return to the headset, press [📞].

Wall Mounting

This unit can be mounted on a wall phone plate.

- 1 Pull down the handset hook until it locks, **so the tab holds the handset.**

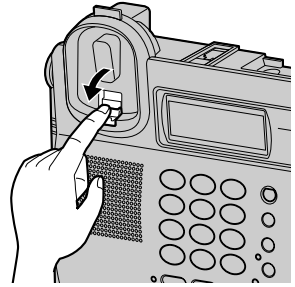

- 2 Press the tabs in the direction of the arrows (①), then remove the wall mounting adaptor (②).

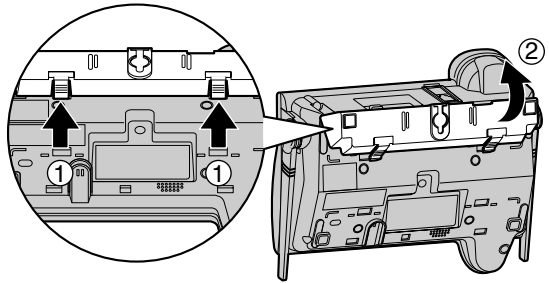

- 3 Connect the AC adaptor. Tuck the telephone line cord inside the wall mounting adaptor, then push it in the direction of the arrows (①) and (②).

- The word "UP WALL" should face upward.

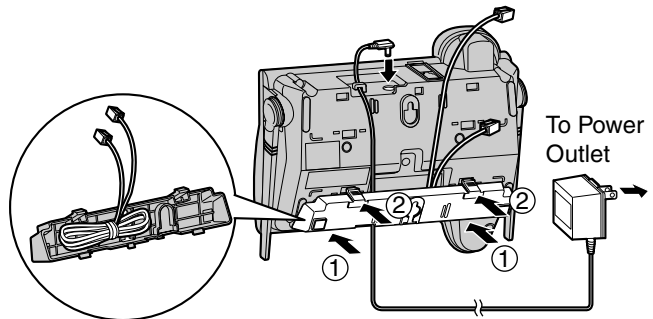

Wall Template for the Charger unit

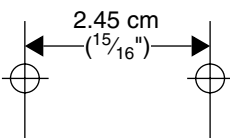

- 4 Connect the telephone line cord. Mount the base unit, then slide down.

- Raise the antennas.

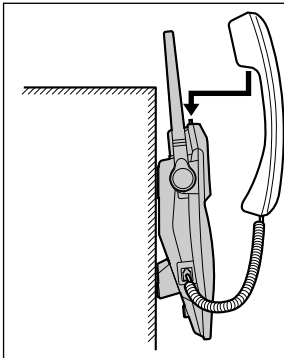
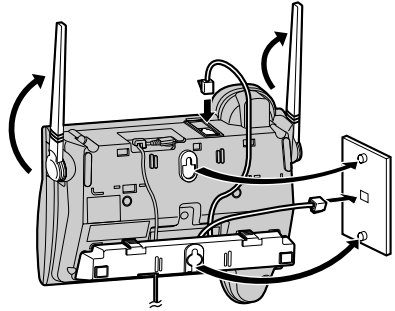

To temporarily set the handset down during a conversation, place it as shown here.

Charger unit

The charger can be wall mounted. Connect the AC adaptor. Install screws using the wall template (p. 52). Mount the charger (1). Slide it down (2), then slide down to the right (3) until it is secured.

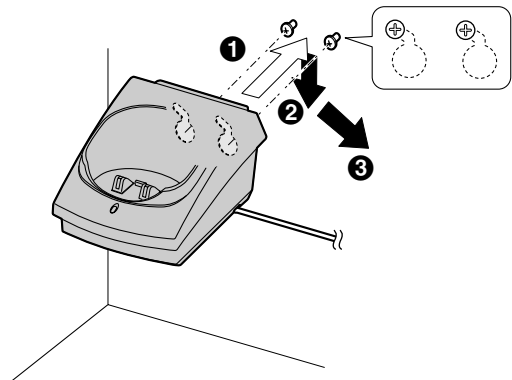
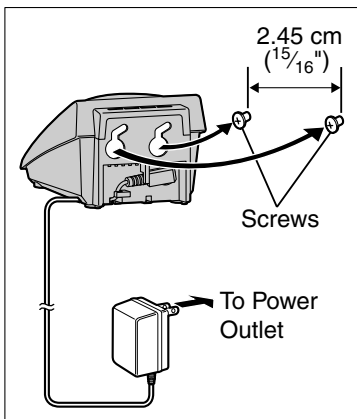

Canceling Registration/Re-registration

Canceling the Handset Registration **Handset**

If you no longer need to use the cordless handset or if you want to use the cordless handset with a different base unit of the same model, it is necessary to cancel the registration from the current base unit.

Only one cordless handset can be canceled at a time **near the base unit**.

Make sure the cordless handset and the base unit are not being used.

1 Press [CONF/FUNCTION] .	
2 Scroll to "Initial setting" by pressing [▼] or [▲] , then press [▶] .	▶Initial setting
3 Scroll to "Registration" by pressing [▼] or [▲] , then press [▶] .	▶Registration
4 Scroll to "Deregistration", by pressing [▼] or [▲] , then press [▶] .	▶Deregistration
5 Press [3][3][5] to delete the registration memory. <ul style="list-style-type: none">• If you make a mistake, press [HOLD/CLEAR], and enter "335".	Deregistration Enter code:335 :335
6 Press the soft key (OK) . <ul style="list-style-type: none">• The registration memory will be erased on both the cordless handset and the base unit.• If 3 beeps sound, you entered a wrong code. Enter "335", then press the soft key (OK).• To register the cordless handset to another base unit of the same model, start from step 5 on page 55 or see page 20.	Ex. Extension number 2 Handset [2]  [-] Deregistered

- "[-]" is shown on the top right of the display.
- After canceling registration, the cordless handset will not work. To use it again, registration will be required (p. 20, 55).

Canceling Registration/Re-registration

Re-registering the Handset **Base Unit & Handset**

If you want to re-register the cordless handset to the base unit or a different base unit of the same model, you need to register it to that base unit. The cordless handset will be given a new extension number of that base unit. Only one cordless handset can be registered at a time near the base unit.

Make sure the base unit and the other cordless handsets are not being used. Registration must be completed within 1 minute.

If you have canceled handset registration at a previous base unit (p. 54), start from step 5.

1 Cordless handset:
Press **[CONF/FUNCTION]**.

2 Cordless handset:
Scroll to “Initial setting” by pressing **[▼]** or **[▲]**, then press **[▶]**.

▶Initial setting

3 Cordless handset:
Scroll to “Registration” by pressing **[▼]** or **[▲]**, then press **[▶]**.

▶Registration

4 Cordless handset:
Press **[▶]** at “HS registration”.

▶HS registration

5 Base unit: Press **[MUTE]**.
• The MUTE indicator flashes.

6 Cordless handset:
(1) Press the soft key **(OK)**.
(2) Wait until a long beep sounds and the display shows the number.
• Registration is complete.

Press MUTE on base unit, then OK on handset to register handset

Ex. Extension number 2

Handset [2]  [2]
Registered

• You can stop registration by pressing **[OFF]** on the cordless handset and pressing **[MUTE]** on the base unit.

If you have not canceled the cordless handset registration at the previous base unit (p. 54), the handset number still remains on that base unit memory. To erase the handset number from the previous base unit, see the base unit Operating Instructions. For KX-TG2750S base unit: (1) Press **[FUNCTION/EDIT]**, (2) Press **[MUTE]**, (3) Enter “335#”, and (4) Enter that handset number (1 to 8).

If the Following Appear on Your Display...

If the unit detects a problem, one of the following messages will be displayed on the base unit or the cordless handset. Error beeps or a busy tone will sound.

Display message	Cause & Remedy
Recharge battery (cordless handset only)	<ul style="list-style-type: none"> The battery needs to be charged. Recharge the battery (p. 12).
Charge for 15HRS (cordless handset only)	<ul style="list-style-type: none"> The battery has been discharged. The cordless handset will not work. Charge the battery fully (p. 12).
No link to base. Walk closer to base and try again. (cordless handset only)	<ul style="list-style-type: none"> The cordless handset has lost communication with the base unit. Walk closer to the base unit, and try again. Plug in the base unit's AC adaptor. Raise the base unit antennas.
Busy	<ul style="list-style-type: none"> The called unit is in use. The Privacy mode is on for the call you tried to join (p. 41). The unit you tried to send directory items to is in use. The cordless handset you are calling is too far from the base unit.
Invalid	<ul style="list-style-type: none"> The called cordless handset has not been registered to the base unit. You selected your own extension number. You pressed [9] instead of entering an extension number. Enter the extension number (0 to 8) to call.
Error!!	<ul style="list-style-type: none"> When you tried to register or deregister the cordless handset, the cordless handset and the base unit could not link for some reason, such as interference from other electrical appliances. Move the cordless handset and the base unit away from electrical appliances and try again. If more than one cordless handset is in use, you may not be able to register/deregister. Try again later. Another unit tried to send directory items to you but the transfer has been stopped (p. 34, 35).
Directory Full	<ul style="list-style-type: none"> When you tried to store an item in the directory, the directory memory is full. Press [EXIT] on the base unit or [OFF] on the cordless handset to exit the programming mode. To erase other items from the directory, see page 33.

If the Following Appear on Your Display...

Display message	Cause & Remedy
System is busy. Please try again later.	<ul style="list-style-type: none"> • If radio communication between the cordless handset and the base unit is partially impaired, this display will be shown.
---Incomplete--- Tom Jones 098-765-4321 Directory full (The name/number is an example.)	<ul style="list-style-type: none"> • When the displayed item is being sent to the destination unit, the directory memory is full and the transfer is stopped. If you tried to send all of the items, the item displayed with "Incomplete" and items after it have not been transferred to the destination unit. You can press [OFF] on the cordless handset or [EXIT] on the base unit to exit (p. 34, 35). To erase other stored items from the destination unit directory, see page 33. You can send all of the items again or send the items which have not been transferred one by one (p. 34, 35). • If the transfer is stopped and "Directory full" is not displayed, it may indicate: <ul style="list-style-type: none"> – the destination cordless handset is out of area, or – the destination unit user may have pressed [↵] or [⏏] on the cordless handset, or lifted the base unit handset or press [DIGITAL SP-PHONE].
Directory No items stored	<ul style="list-style-type: none"> • Although you tried to send your directory items to another extension, your directory is empty.
Denied	<ul style="list-style-type: none"> • When you call another unit to monitor, the Room Monitor mode of the destination unit is set to OFF (p. 41).
Not found 2Way radio mode (cordless handset only)	<ul style="list-style-type: none"> • When you tried to call another cordless handset in 2-Way Radio mode; <ul style="list-style-type: none"> – the cordless handset is too far from your cordless handset. Walk closer to the cordless handset. – 2-Way Radio mode on the cordless handset is off (p. 43). – The cordless handset you called is talking with another cordless handset in 2-Way Radio mode.
Invalid. Please register to the base unit (cordless handset only)	<ul style="list-style-type: none"> • The cordless handset you tried to make a call has not been registered to the base unit. Register the cordless handset (p. 20, 55).
Store VM access#	<ul style="list-style-type: none"> • You have not stored the voice mail access number. Store the number (p. 45).

If the Following Appear on Your Display...

Display message	Cause & Remedy
<p>Error!! 8 handsets have already been registered. (cordless handset only)</p>	<ul style="list-style-type: none">• 8 cordless handsets have already been registered to the base unit. To cancel another handset registration, see page 54.• This base unit has the memory of the cordless handset currently registered to another base unit. Erase the handset memory from the base unit. For KX-TG2750S base unit: (1) Press [FUNCTION/EDIT], (2) Press [MUTE], (3) Enter "335#" and (4) Enter that handset number (1 to 8).

Troubleshooting

If the display shows error messages, see “If the Following Appear on Your Display...” (p. 56–58) for the Cause & Remedy.

Problem	Cause & Remedy
The unit does not work.	<ul style="list-style-type: none">• Check the settings (p. 10–12).• Check whether the dialing mode setting is correct (p. 17).• Charge the battery fully (p. 11).• Clean the charge contacts and charge again (p. 12).• Install the battery properly (p. 11).• Unplug the base unit's AC adaptor to reset it. Plug in, and try again.• The cordless handset has not been registered to the base unit. Register the cordless handset (p. 20, 55).• Re-install the battery (p. 11) and charge it fully.
Static, sound cuts in/out, fades. Interference from other electrical units.	<ul style="list-style-type: none">• Move the cordless handset and the base unit away from other electrical appliances (p. 3).• Walk closer to the base unit.• Raise the base unit antennas.• Press [◀] on the cordless handset to turn on the Reception Booster feature (p. 24).
The base unit and/or cordless handset does not ring.	<ul style="list-style-type: none">• The ringer volume is OFF. Set to HIGH, MEDIUM or LOW (p. 18).• If more than one other unit is in use, the cordless handset/base unit may not ring. Users will hear incoming call tones (p. 49).
The display of the base unit or cordless handset is blank.	<ul style="list-style-type: none">• If only the cordless handset display is blank, charge the battery fully (p. 11).• If you are having a conversation using the base unit handset during a power failure and power returns to the base unit, the display will be blank until you hang up the call. After hanging up, the display will function.
While programming or searching, the unit starts to ring and stops the program/search.	<ul style="list-style-type: none">• A call is coming in. To answer the call, lift the base unit handset, or press [DIGITAL SP-PHONE], [📞] or [📞]. Start again from the beginning after hanging up.

Troubleshooting

Problem	Cause & Remedy
You cannot program function items.	<ul style="list-style-type: none">• Programming is not possible while the unit is being used.• Do not pause for over 60 seconds while programming.• Walk closer to the base unit if you are using the cordless handset.• If more than three other units are in use, you may not be able to program with the base unit or cordless handset. Try again later.• If 2-Way Radio mode is on on your cordless handset, turn it off (p. 43).
You cannot make an intercom/external call.	<ul style="list-style-type: none">• If more than one other unit is in use, you may not be able to make a call. Try again later.• The cordless handset you called is too far from the base unit.• If 2-Way Radio mode is on on your cordless handset, turn it off (p. 43).• If you are having a conversation using the base unit handset during a power failure and power returns to the base unit, you cannot use the speakerphone nor the cordless handset until you hang up the call. After hanging up, you can resume all functions.
The unit does not display the caller's name and/or phone number.	<ul style="list-style-type: none">• You need to subscribe to a Caller ID service.• Other telephone equipment may be interfering with your phone. Disconnect it and try again.• Other electrical appliances connected to the same outlet may be interfering with the Caller ID information.• Telephone line noise may be affecting the Caller ID information.• The caller requested not to send his/her information. See page 25.• If a call is being transferred to you, the Caller ID information will not be displayed.• If a (separate) Caller ID box is connected between the unit and the telephone wall jack, disconnect the Caller ID box or plug the unit directly into the wall jack.
The display exits the Caller List or directory.	<ul style="list-style-type: none">• Do not pause for over 60 seconds while searching.

Troubleshooting

Problem	Cause & Remedy
You cannot redial.	<ul style="list-style-type: none">• If the last number dialed was more than 32 digits long, the number will not be redialed correctly.• The button functions as either redial or pause. It will redial the last number dialed if pressed at the outset of a call (p. 22, 24). If another number has been dialed first, it will operate as a pause button (p. 49).
"IN USE" is not displayed properly. The VM indicator does not flash properly.	<ul style="list-style-type: none">• The line mode selection is incorrect. Set line mode to "A" (p. 17).
"Recharge battery" is displayed, "■" flashes or the cordless handset beeps intermittently.	<ul style="list-style-type: none">• Charge the battery fully (p. 11).
"Charge for 15HRS" and "■" are displayed and the cordless handset does not work.	<ul style="list-style-type: none">• The battery has been discharged. Charge the battery fully (p. 12).
You charged the battery fully, but "Recharge battery" is still displayed and/or "■" continues to flash, or "Charge for 15HRS" and "■" are displayed.	<ul style="list-style-type: none">• Clean the charge contacts and charge again (p. 12).• Install a new battery (p. 11, 12).
The CHARGE indicator does not go out after the battery has been charged.	<ul style="list-style-type: none">• This is normal.
If you cannot solve your problem	<ul style="list-style-type: none">• Call our customer call center at 1-800-211-PANA(7262).• Panasonic's e-mail address for customer inquiries: consumerproducts@panasonic.com for customers in the USA or Puerto Rico ONLY

Important Safety Instructions

When using this unit, basic safety precautions should always be followed to reduce the risk of fire, electric shock, or personal injury.

1. Read and understand all instructions.
2. Follow all warnings and instructions marked on this unit.
3. Unplug this unit from AC outlets before cleaning. Do not use liquid or aerosol cleaners. Use a damp cloth for cleaning.
4. Do not use this unit near water, for example, near a bathtub, washbowl, kitchen sink, or the like.
5. Place this unit securely on a stable surface. Serious damage and/or injury may result if the unit falls.
6. Do not cover slots and openings on the unit. They are provided for ventilation and protection against overheating. Never place the unit near radiators, or in a place where proper ventilation is not provided.
7. Use only the power source marked on the unit. If you are not sure of the type of power supplied to your home, consult your dealer or local power company.
8. Do not place objects on the power cord. Install the unit where no one can step or trip on the cord.
9. Do not overload wall outlets and extension cords. This can result in the risk of fire or electric shock.
10. Never push any objects through slots in this unit. This may result in the risk of fire or electric shock. Never spill any liquid on the unit.
11. To reduce the risk of electric shock, do not disassemble this unit. Take the unit to an authorized servicenter when service is required. Opening or removing covers may expose you to dangerous voltages or other risks. Incorrect reassembly can cause electric shock when the unit is subsequently used.
12. Unplug this unit from the wall outlet and refer servicing to an authorized servicenter when the following conditions occur:
 - A. When the power supply cord or plug is damaged or frayed.
 - B. If liquid has been spilled into the unit.
 - C. If the unit has been exposed to rain or water.
 - D. If the unit does not work normally by following the operating instructions. Adjust only controls covered by the operating instructions. Improper adjustment may require extensive work by an authorized servicenter.
 - E. If the unit has been dropped or physically damaged.
 - F. If the unit exhibits a distinct change in performance.
13. During thunderstorms, avoid using telephones except cordless types. There may be a remote risk of an electric shock from lightning.
14. Do not use this unit to report a gas leak, when in the vicinity of the leak.

SAVE THESE INSTRUCTIONS

Important Safety Instructions

CAUTION:

To reduce the risk of fire or injury to persons, read and follow these instructions.

1. Use only the battery(ies) specified.
2. Do not dispose of the battery(ies) in a fire. They may explode. Check with local waste management codes for special disposal instructions.
3. Do not open or mutilate the battery(ies). Released electrolyte is corrosive and may cause burns or injury to the eyes or skin. The electrolyte may be toxic if swallowed.
4. Exercise care in handling batteries in order not to short the battery to conductive materials such as rings, bracelets, and keys. The battery and/or conductor may overheat and cause burns.
5. Charge the battery(ies) provided with or identified for use with this product only in accordance with the instructions and limitations specified in this manual.

WARNING:

TO PREVENT FIRE OR SHOCK HAZARD, DO NOT EXPOSE THIS PRODUCT TO RAIN OR ANY TYPE OF MOISTURE.

- The AC adaptor is used as the main disconnect device, ensure that the AC outlet is located/installed near the unit and is easily accessible.

FCC and Other Information

This equipment complies with Part 68 of the FCC rules and the requirements adopted by the ACTA. On the bottom of this equipment is a label that contains, among other information, a product identifier in the format US:ACJ-----. If requested, this number must be provided to the telephone company.

Registration No. (found on the bottom of the unit)
Ringer Equivalence No. (REN) 1.0B

A plug and jack used to connect this equipment to the premises wiring and telephone network must comply with the applicable FCC Part 68 rules and requirements adopted by the ACTA. A compliant telephone cord and modular plug is provided with this product. It is designed to be connected to a compatible modular jack that is also compliant.

The REN is used to determine the number of devices that may be connected to a telephone line. Excessive RENs on a telephone line may result in the devices not ringing in response to an incoming call. In most but not all areas, the sum of RENs should not exceed five (5.0). To be certain of the number of devices that may be connected to a line, as determined by the total RENs, contact the local telephone company. For products approved after July 23, 2001, the REN for this product is part of the product identifier that has the format US:AAAEQ##TXXXX. The digits represented by ## are the REN without a decimal point (e.g., 03 is a REN of 0.3).

If this equipment causes harm to the telephone network, the telephone company will notify you in advance that temporary discontinuance of service may be required. But if advance notice isn't practical, the telephone company will notify the customer as soon as possible. Also, you will be advised of your right to file a complaint with the FCC if you believe it is necessary.

The telephone company may make changes in its facilities, equipment, operations or procedures that could affect the operation of the equipment. If this happens the telephone company will provide advance notice in order for you to make necessary modifications to maintain uninterrupted service.

If trouble is experienced with this equipment, for repair or warranty information, please contact a Factory Servicenter or other Authorized Servicer. If the equipment is causing harm to the telephone network, the telephone company may request that you disconnect the equipment until the problem is resolved.

Connection to party line service is subject to state tariffs. Contact the state public utility commission, public service commission or corporation commission for information.

If your home has specially wired alarm equipment connected to the telephone line, ensure the installation of this equipment does not disable your alarm equipment. If you have questions about what will disable alarm equipment, consult your telephone company or a qualified installer.

WHEN PROGRAMMING EMERGENCY NUMBERS AND/OR MAKING TEST CALLS TO EMERGENCY NUMBERS:

- 1) Remain on the line and briefly explain to the dispatcher the reason for the call.
- 2) Perform such activities in the off-peak hours, such as early morning or late evenings.

This device complies with Part 15 of the FCC Rules. Operation is subject to the following two conditions: (1) This device may not cause harmful interference, and (2) this device must accept any interference received, including interference that may cause undesired operation.

FCC and Other Information

Privacy of communications may not be ensured when using this phone.

CAUTION:

Any changes or modifications not expressly approved by the party responsible for compliance could void the user's authority to operate this device.

Note:

This equipment has been tested and found to comply with the limits for a Class B digital device, pursuant to Part 15 of the FCC Rules. These limits are designed to provide reasonable protection against harmful interference in a residential installation. This equipment generates, uses, and can radiate radio frequency energy and, if not installed and used in accordance with the instructions, may cause harmful interference to radio communications. However, there is no guarantee that interference will not occur in a particular installation. If this equipment does cause harmful interference to radio or television reception, which can be determined by turning the equipment off and on, the user is encouraged to try to correct the interference by one or more of the following measures:

- Reorient or relocate the receiving antenna.
- Increase the separation between the equipment and receiver.
- Connect the equipment into an outlet on a circuit different from that to which the receiver is connected.
- Consult the dealer or an experienced radio/TV technician for help.

Some cordless telephones operate at frequencies that may cause interference to nearby TVs and VCRs. To minimize or prevent such interference, the base of the cordless telephone should not be placed near or on top of a TV or VCR. If interference is experienced, move the cordless telephone further away from the TV or VCR. This will often reduce, or eliminate, interference.

Operating near 2.4GHz electrical appliances may cause interference. Move away from the electrical appliances.

CAUTION:

To comply with FCC RF exposure requirements, the base unit should be installed with its antenna located at 20 cm or more from persons and handset should be carried with the specific belt-clip provided for the handset to ensure compliance. Other non-tested belt-clips or similar body-worn accessories may not comply, therefore, should be avoided.

This equipment is hearing aid compatible as defined by the FCC in 47 CFR Section 68.316.

When you hold the phone to your ear, noise might be heard in your Hearing Aid. Some Hearing Aids are not adequately shielded from external RF (radio frequency) energy. If noise occurs, use an optional headset accessory or the speakerphone option (if applicable) when using this phone. Consult your audiologist or Hearing Aid manufacturer about the availability of Hearing Aids which provide adequate shielding to RF energy commonly emitted by digital devices.

FCC and Other Information

- **Environment** — do not place the unit in a room where the temperature is less than 5°C (41°F) or greater than 40°C (104°F). Allow 10 cm (4") clearance around the unit for proper ventilation. Avoid excessive smoke, dust, mechanical vibration, shock, or direct sunlight.
- **Medical** — consult the manufacturer of any personal medical devices, such as pacemakers, to determine if they are adequately shielded from external RF (radio frequency) energy. (The unit operates in the frequency range of 2400MHz to 2480MHz, and the power output level can range 0.04 to 0.4 watts.) Do not use the unit in health care facilities if any regulations posted in the area instruct you not to do so. Hospitals or health care facilities may be using equipment that could be sensitive to external RF (radio frequency) energy.
- **Routine care** — wipe the unit with a soft cloth. Do not use benzine, thinner, or any abrasive powder. When you leave the unit unused for a long period of time, unplug the AC adaptor from the outlet.
- **If there is any trouble** — disconnect the unit from the telephone line and connect a known working phone. If the known working phone operates properly, have your unit repaired by one of the authorized Panasonic Factory Service Centers. If the known working phone does not operate properly, consult your telephone company.

Index

- A**
Accessories 2
Answering Calls, Base unit 25
Answering Calls, Handset 25
Auto Talk Feature 19, 25, 37
- B**
Backlit LCD 9
Base Unit Location 3
Battery Charge 3, 11
Battery information 12
Battery Replacement 11, 12
Battery strength 11
Belt Clip 51
- C**
Call Share 40
Call Waiting Caller ID 48
Call Waiting Tone 48
Caller ID Number Auto Edit
feature 27, 28
Caller ID service 25
Caller List, editing 27
Caller List, erasing 29
Caller List, storing 29
Caller List, viewing 26
Calling Back from the Caller List 27
Conference calls 40
Copy directory 34
- D**
Date and time 16
Deregistration 54
Dialing Mode 17
Directory 30
Directory, copying 34, 35
Directory, dialing 32
Directory, editing 33
Directory, erasing 33
Directory, names 31
Directory, storing 30
Displays 9
- E**
Error messages 56
Extension number 20, 36, 55
- F**
FCC and Other Information 64
FLASH Button 50
Flash time 50
Function Menu, Selection 13
Function Menu, Table 14, 15
- H**
Headset, optional 51
Hold 22, 24
- I**
Incoming Call Tone 49
Installation, AC Adaptor 10
Installation, Battery 11
Installation, Charger unit 10
Installation, Corded handset 10
Installation, Telephone Line Cord 10
Intercom call 36
Intercom paging 36
- L**
LCD Contrast 19
Lighted handset keypad 8
Line Mode 17
Location of Controls 6, 7
- M**
Making Calls, Base unit 21
Making Calls, Handset 23
Microphone, Base unit 21, 36
Microphone, Handset 23
MUTE 48
- N**
Navigator key 8
Noise 3
- P**
PAUSE 49
Power failure 10, 16
Privacy feature 41
Pulse service 48

Index

R

Reception Booster	24
Redial	22, 24
Redial list	22, 24
Registration.	20, 55
Registration, Canceling.	54
Ringer Off	18, 44
Ringer Tone	18
Ringer Volume	18, 44
Room Monitor	41
Rotary service, Tone dialing	48

S

Safety Instructions	62
Shipping product for service Back cover	
Soft keys.	8
Specifications	71
SP-Phone, Base unit	21
SP-Phone, Handset	23

T

Transferring a Call	38
Troubleshooting	59
Two-Way Radio Communication.	43, 44

V

VM (Voice Mail Service)	45
Volume control, Base unit.	21
Volume control, Handset	23, 44

W

Wall Mounting	52
Warranty	69

**PANASONIC CONSUMER
ELECTRONICS COMPANY, DIVISION
OF MATSUSHITA ELECTRIC
CORPORATION OF AMERICA**
One Panasonic Way
Secaucus, New Jersey 07094

**PANASONIC SALES COMPANY,
DIVISION OF MATSUSHITA
ELECTRIC OF PUERTO RICO, INC.,**
Ave. 65 de Infanteria, Km. 9.5
San Gabriel Industrial Park
Carolina, Puerto Rico 00985

Panasonic Telephone Products Limited Warranty

Limited Warranty Coverage

If your product does not work properly because of a defect in materials or workmanship, Panasonic Consumer Electronics Company or Panasonic Sales Company (collectively referred to as "the warrantor") will, for the length of the period indicated on the chart below, which starts with the date of original purchase ("warranty period"), at its option either (a) repair your product with new or refurbished parts, or (b) replace it with a new or a refurbished product. The decision to repair or replace will be made by the warrantor.

Parts	Labor
One (1) Year	One (1) Year

During the "Labor" warranty period there will be no charge for labor. During the "Parts" warranty period, there will be no charge for parts. You must mail-in your product during the warranty period. This Limited Warranty excludes both parts and labor for batteries, antennas, and cosmetic parts (cabinet). This warranty only applies to products purchased and serviced in the United States or Puerto Rico. This warranty is extended only to the original purchaser of a new product which was not sold "as is".

Mail-In Service

For assistance in the continental U.S.A. in obtaining repairs please ship the product to:

**Panasonic Services Company
Customer Servicer
Suite B
4900 George McVay Drive
McAllen, TX 78503**

For assistance in Puerto Rico call Panasonic Sales Company (787)-750-4300 or fax (787)-768-2910.

When shipping the unit carefully pack and send it prepaid, adequately insured and preferably in the original carton. Include a letter detailing the complaint and provide a day time phone number where you can be reached.

IF REPAIR IS NEEDED DURING THE WARRANTY PERIOD THE PURCHASER WILL BE REQUIRED TO FURNISH A SALES RECEIPT/PROOF OF PURCHASE INDICATING DATE OF PURCHASE, AMOUNT PAID AND PLACE OF PURCHASE. CUSTOMER WILL BE CHARGED FOR THE REPAIR OF ANY UNIT RECEIVED WITHOUT SUCH PROOF OF PURCHASE.

Limited Warranty Limits And Exclusions

This warranty ONLY COVERS failures due to defects in materials or workmanship, and DOES NOT COVER normal wear and tear or cosmetic damage. The warranty ALSO DOES NOT COVER damages which occurred in shipment, or failures which are caused by products not supplied by the warrantor, or failures which result from accidents, misuse, abuse, neglect, mishandling, misapplication, alteration, faulty installation, set-up adjustments, misadjustment of consumer controls, improper maintenance, power line surge, lightning damage, modification, introduction of sand, humidity or liquids, commercial use such as hotel, office, restaurant, or other business or rental use of the product, or service by anyone other than a Factory Servicenter or other Authorized Servicer, or damage that is attributable to acts of God.

THERE ARE NO EXPRESS WARRANTIES EXCEPT AS LISTED UNDER "LIMITED WARRANTY COVERAGE". THE WARRANTOR IS NOT LIABLE FOR INCIDENTAL OR CONSEQUENTIAL DAMAGES RESULTING FROM THE USE OF THIS PRODUCT, OR ARISING OUT OF ANY BREACH OF THIS WARRANTY. (As examples, this excludes damages for lost time, lost calls or messages, cost of having someone remove or re-install an installed unit if applicable, travel to and from the servicer. The items listed are not exclusive, but are for illustration only.) **ALL EXPRESS AND IMPLIED WARRANTIES, INCLUDING THE WARRANTY OF MERCHANTABILITY, ARE LIMITED TO THE PERIOD OF THE LIMITED WARRANTY.**

Some states do not allow the exclusion or limitation of incidental or consequential damages, or limitations on how long an implied warranty lasts, so the exclusions may not apply to you.

This warranty gives you specific legal rights and you may also have other rights which vary from state to state. If a problem with this product develops during or after the warranty period, you may contact your dealer or Servicer. If the problem is not handled to your satisfaction, then write to the warrantor's Consumer Affairs Department at the addresses listed for the warrantor.

PARTS AND SERVICE, WHICH ARE NOT COVERED BY THIS LIMITED WARRANTY, ARE YOUR RESPONSIBILITY.

Customer Services Directory

For Product Information, Operating Assistance, Literature Request, Dealer Locations, and all Customer Service inquiries please contact: 1-800-211-PANA (7262), Monday-Friday 9 am-9 pm; Saturday-Sunday 9 am-7 pm, EST. or send e-mail : consumerproducts@panasonic.com For hearing or speech impaired TTY users, TTY : 1-877-833-8855

***Web Site: <http://www.panasonic.com>
You can purchase parts, accessories or locate your nearest servicer by visiting our Web Site.***

Accessory Purchases:

**1-800-332-5368 (Customer Orders Only)
For hearing or speech impaired TTY users, TTY : 1-866-605-1277
Panasonic Services Company 20421 84th Avenue South, Kent, WA 98032
(6 am to 5 pm Monday - Friday; 6 am to 10:30 am Saturday; PST)
(Visa, MasterCard, Discover Card, American Express, Check)**

***Service in Puerto Rico
Matsushita Electric of Puerto Rico, Inc. Panasonic Sales Company/
Factory Servicer:
Ave. 65 de Infantería, Km. 9.5, San Gabriel Industrial Park,
Carolina, Puerto Rico 00985
Phone (787)750-4300 Fax (787)768-2910***

Specifications

■ Base unit

Power Supply:	AC adaptor (120 V AC, 60 Hz)
Power Consumption:	Standby: Approx. 3.5 W Maximum: Approx. 7.2 W
Frequency:	2.40 GHz – 2.48 GHz
Dimensions (H x W x D):	Approx. 93 mm x 250 mm x 194 mm (3 ²¹ / ₃₂ " x 9 ²⁷ / ₃₂ " x 7 ⁶ / ₈ "
Mass (Weight):	Approx. 745 g (1.64 lb.)

■ Charger

Power Supply:	AC adaptor (120 V AC, 60 Hz)
Power Consumption:	Standby: Approx. 0.8 W Maximum: Approx. 4.0 W
Dimensions (H x W x D):	Approx. 60 mm x 74 mm x 96 mm (2 ¹¹ / ₃₂ " x 2 ²⁹ / ₃₂ " x 3 ²⁵ / ₃₂ "
Mass (Weight):	Approx. 95 g (0.21 lb.)

■ Cordless handset

Power Supply:	Ni-Cd battery (3.6 V, 850 mAh)
Frequency:	2.40 GHz – 2.48 GHz
Dimensions (H x W x D):	Approx. 242 mm x 53 mm x 40 mm (9 ¹⁷ / ₃₂ " x 2 ³ / ₃₂ " x 1 ⁹ / ₁₆ "
Mass (Weight):	Approx. 220 g (0.48 lb.)
Security Codes:	1,000,000

■ **Dialing Mode:** Tone (DTMF)/Pulse

■ **Operating Environment:** 5 °C – 40 °C (41 °F – 104 °F)

Specifications are subject to change without notice.

Energy Star:

As an ENERGY STAR® Partner, Panasonic has determined that this product meets the ENERGY STAR guidelines for energy efficiency. ENERGY STAR is a U.S. registered mark.



For product service

- Call 1-800-211-PANA(7262) for the location of an authorized servicer.
- Panasonic's e-mail address for customer inquiries:
consumerproducts@panasonic.com
for customers in the USA or Puerto Rico ONLY

When you ship the product

- Carefully pack your unit, preferably in the original carton.
- Attach a letter, detailing the symptom, to the outside of the carton.

Symptom

- Send the unit to an authorized servicer, prepaid and adequately insured.
- Do not send your unit to the Panasonic Consumer Electronics Company listed below or to executive or regional sales offices. These locations do not repair consumer products.

For your future reference

Serial No. _____

Date of purchase _____

(found on the bottom of the unit)

Name and address of dealer _____

- This cordless telephone is designed for use in the United States of America. Sale or use of this product in other countries may violate local laws.
- Ce téléphone sans fil est conçu pour être utilisé aux États-Unis d'Amérique. La vente ou l'emploi de cet appareil dans certains autres pays peut constituer une infraction à la législation locale.
- Este teléfono sin cordón fue elaborado para uso en los Estados Unidos de América. La venta o el empleo de este producto en ciertos países puede constituir violación de la legislación local.
- このコードレス電話機は、日本国外での使用を目的として設計されており、日本国内での使用は法律違反となります。従って、当社では日本国内においては原則として修理などのサービスは致しかねます。

**If you need assistance with the set-up or operation,
please call 1-800-211-PANA(7262)**

**Panasonic Consumer Electronics Company,
Division of Matsushita Electric Corporation of America**
One Panasonic Way, Secaucus, New Jersey 07094

**Panasonic Sales Company,
Division of Matsushita Electric of Puerto Rico, Inc.**
Ave. 65 de Infantería, Km. 9.5, San Gabriel Industrial Park
Carolina, Puerto Rico 00985

PQQX13562YA S0203-1023