

Installation Manual

PLEASE READ BEFORE USE AND SAVE.

KX-TGA230B/KX-TGA230W is the optional cordless handset for the KX-TG2352W/KX-TG2382B.

This installation manual only describes the steps necessary to start up the handset. Please read the KX-TG2352W/KX-TG2382B operating instructions for further details.

Accessories (included) For extra orders, call 1-800-332-5368.

- | | |
|---|---|
| <input type="checkbox"/> Charger Unitone | <input type="checkbox"/> Batteryone |
| Charger Order No. PQLV30017ZB (Black) | Order No. N4HHGMB00001 |
| Order No. PQLV30017ZW (White) | (HHR-P103) |
| AC Adaptor Order No. PQLV2Z (PQLV2) | <input type="checkbox"/> Belt Clipone |
| <input type="checkbox"/> Handset Coverone | Order No. PQKE10352Z3 (Black) |
| Order No. PQKK10131Z3 (Black) | Order No. PQKE10352Z2 (White) |
| Order No. PQKK10131Z2 (White) | |

Installation

Connecting the AC adaptor

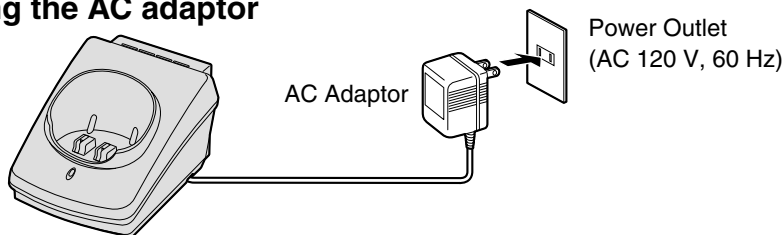

- USE ONLY WITH Panasonic AC ADAPTOR PQLV2 (Order No. PQLV2Z).
- The AC adaptor must remain connected at all times. (It is normal for the adaptor to feel warm during use.)

Installing the battery

Insert the battery into the handset as shown, matching the correct polarity (①). Press the battery down until it fits securely into the compartment (②). Close the cover.

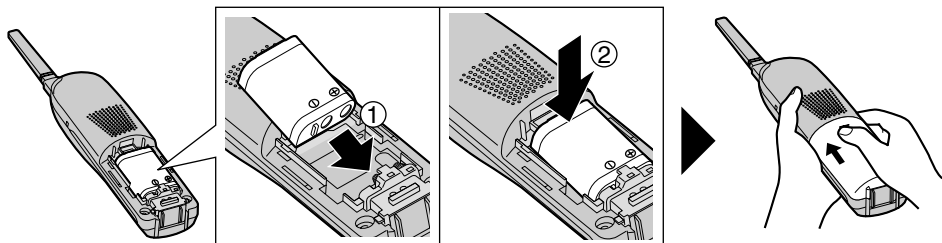

For assistance, please call: 1-800-211-PANA(7262)

Charging the battery

Place the handset on the charger and charge for **about 15 hours** before initial use.

- The CHARGE indicator will light, a beep will sound and “Charging” will be displayed.
- Recharge the battery when:
 - “Recharge” is displayed,
 - “{ ■ }” flashes on the display, or
 - the handset beeps intermittently while it is in use.
- If the battery has been discharged, the handset will display “Charge for 15h” when you place the handset on the charger. The handset will not work. Keep charging until fully charged.

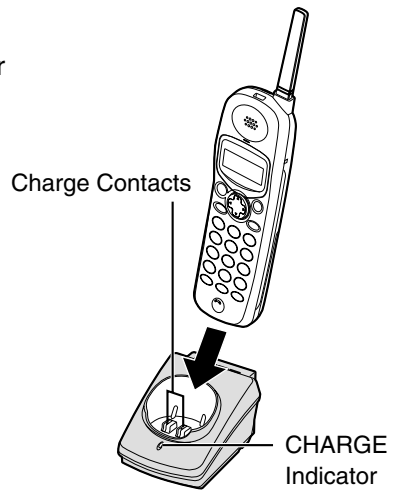

Handset battery information

After your Panasonic battery is fully charged:

Operation	Operating time
While in use (TALK)	Up to 4 hours
While not in use (Standby)	Up to 7 days

- **Clean the charge contacts of the handset and the charger with a soft, dry cloth once a month. Clean more often if the unit is subject to grease, dust or high humidity.** Otherwise the battery may not charge properly.

Belt Clip

You can hang the handset on your belt or pocket using the belt clip.

To attach the belt clip

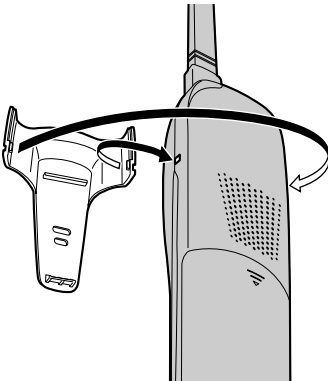

To remove the belt clip

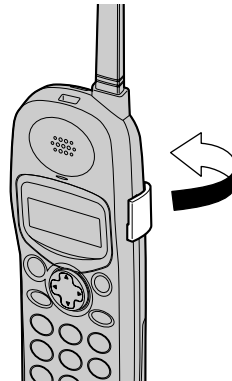

Registration

This cordless handset must be registered at the KX-TG2352W/KX-TG2382B base unit. The handset will be assigned the extension number at registration. Only one handset can be registered at a time.

Make sure the base unit and the other handsets are not being used. Registration must be completed within 1 minute.

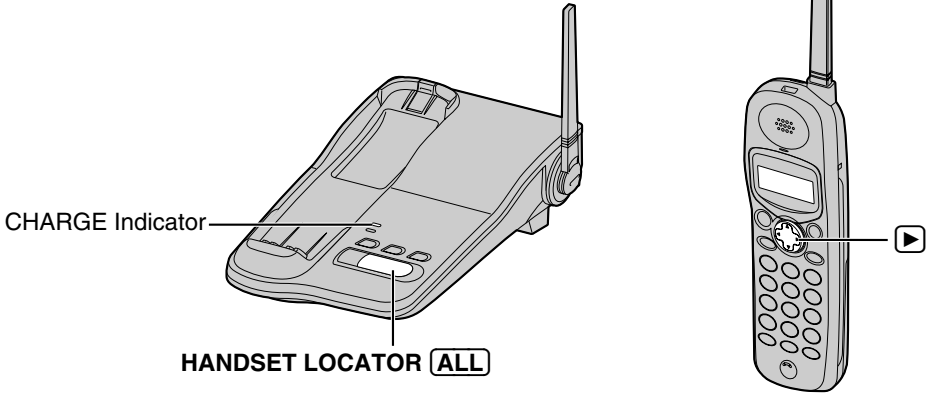

•The illustration of the base unit is the KX-TG2352W.

The handset display shows the instructions as shown on the right.

1 Base unit:
Press **HANDSET LOCATOR [ALL]** until the CHARGE indicator flashes.

Press [ALL] on base for 3 sec, then press [▶].

2 Handset:
① Press [▶].
② Wait until a long beep sounds and the display shows the registered number. The registration will be then complete.

Handset
Registering

Ex. Extension number 3

Handset [3]
Registered

•The registered number “[1]” to “[3]” is shown on the top right of the display.

[3]
[■■■■]

•You can stop registration by pressing **[OFF]** on the handset and pressing **HANDSET LOCATOR [ALL]** on the base unit.

•After you register the handset to the base unit, please confirm that the other (first one and second one) pre-registered handsets display “Talk” by pressing **[☎]**. If one of the handsets does not display “Talk”, re-register that handset to the base unit.

To cancel the handset registration, please see the KX-TG2352W/KX-TG2382B Operating Instructions.

For assistance, please call: 1-800-211-PANA(7262)

Optional Headset

Plugging a headset into the handset allows a hands-free phone conversation. Please use only the Panasonic KX-TCA88 headset.

To order, call the accessories telephone number on page 1.

Connecting the headset

Open the headset jack cover, and connect the headset to the headset jack as shown.

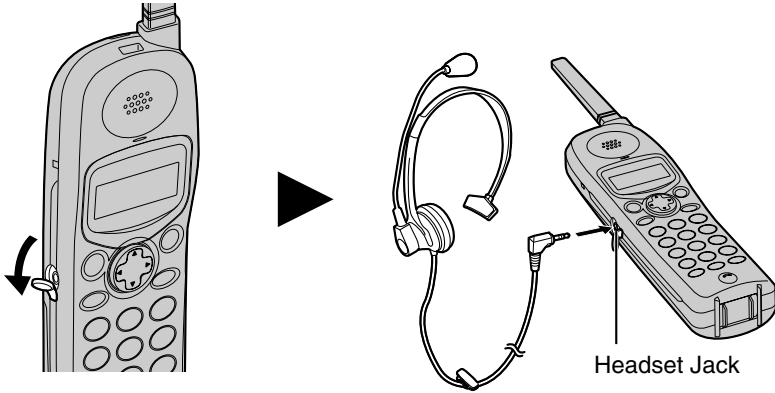

Wall Mounting

The charger can be wall mounted. Connect the AC adaptor. Install screws using the wall template below. Mount the charger (①). Slide it down (②) then slide down to the right (③) until it is secured.

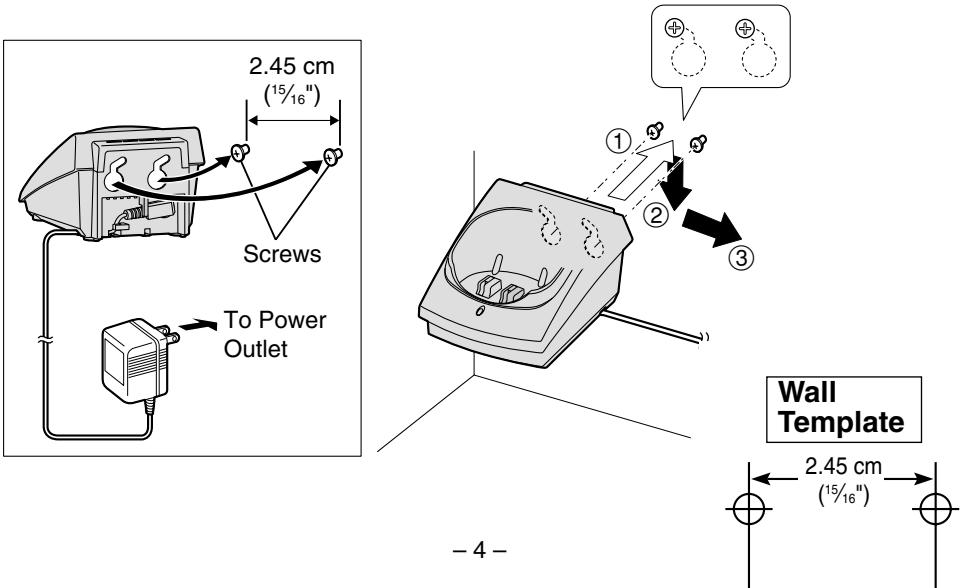

FCC and Other Information

WHEN PROGRAMMING EMERGENCY NUMBERS AND(OR) MAKING TEST CALLS TO EMERGENCY NUMBERS:

- 1) Remain on the line and briefly explain to the dispatcher the reason for the call.
- 2) Perform such activities in the off-peak hours, such as early morning or late evenings.

This device complies with Part 15 of the FCC Rules. Operation is subject to the following two conditions: (1) This device may not cause harmful interference, and (2) this device must accept any interference received, including interference that may cause undesired operation.

Privacy of communications may not be ensured when using this phone.

CAUTION:

Any changes or modifications not expressly approved by the party responsible for compliance could void the user's authority to operate this device.

Note:

This equipment has been tested and found to comply with the limits for a Class B digital device, pursuant to Part 15 of the FCC Rules. These limits are designed to provide reasonable protection against harmful interference in a residential installation. This equipment generates, uses, and can radiate radio frequency energy and, if not installed and used in accordance with the instructions, may cause harmful interference to radio communications. However, there is no guarantee that interference will not occur in a particular installation. If this equipment does cause harmful interference to radio or television reception, which can be determined by turning the equipment off and on, the user is encouraged to try to correct the interference by one or more of the following measures:

- Reorient or relocate the receiving antenna.
- Increase the separation between the equipment and receiver.
- Connect the equipment into an outlet on a circuit different from that to which the receiver is connected.
- Consult the dealer or an experienced radio/TV technician for help.

Operating near 2.4GHz electrical appliances may cause interference. Move away from the electrical appliances.

CAUTION:

To comply with FCC RF exposure requirements, the handset should be carried with the specific belt-clip provided for the handset to ensure compliance. Other non-tested belt-clips or similar body-worn accessories may not comply, therefore, should be avoided.

This equipment is hearing aid compatible as defined by the FCC in 47 CFR Section 68.316.

When you hold the phone to your ear, noise might be heard in your Hearing Aid. Some Hearing Aids are not adequately shielded from external RF (radio frequency) energy. If noise occurs, use an optional headset accessory or the speakerphone option (if applicable) when using this phone. Consult with your audiologist or Hearing Aid manufacturer about the availability of Hearing Aids which provide adequate shielding to RF energy commonly emitted by digital devices.

For assistance, please call: 1-800-211-PANA(7262)

CAUTION:

To reduce the risk of fire or injury to persons, read and follow these instructions.

1. Use only the battery(ies) specified.
2. Do not dispose of the battery(ies) in a fire. They may explode. Check with local waste management codes for special disposal instructions.
3. Do not open or mutilate the battery(ies). Released electrolyte is corrosive and may cause burns or injury to the eyes or skin. The electrolyte may be toxic if swallowed.
4. Exercise care in handling batteries in order not to short the battery to conductive materials such as rings, bracelets, and keys. The battery and/or conductor may overheat and cause burns.
5. Charge the battery(ies) provided with or identified for use with this product only in accordance with the instructions and limitations specified in this manual.

A nickel metal hydride battery powers that is recyclable the product you have purchased.

Please call 1-800-8-BATTERY for information on how to recycle this battery.



WARNING:

TO PREVENT FIRE OR SHOCK HAZARD, DO NOT EXPOSE THIS PRODUCT TO RAIN OR ANY TYPE OF MOISTURE.

- The AC adaptor is used as the main disconnect device, ensure that the AC outlet is located/installed near the unit and is easily accessible.

**If you need assistance with the set-up or operation,
please call 1-800-211-PANA(7262)**

Panasonic World Wide Web address: <http://www.panasonic.com>
for customers in the USA or Puerto Rico

Panasonic's e-mail address for customer inquiries:
consumerproducts@panasonic.com

**Panasonic Consumer Electronics Company,
Division of Matsushita Electric Corporation of America**
One Panasonic Way, Secaucus, New Jersey 07094

**Panasonic Sales Company,
Division of Matsushita Electric of Puerto Rico, Inc.**
Ave. 65 de Infantería, Km. 9.5, San Gabriel Industrial Park
Carolina, Puerto Rico 00985

Manual de instalación

LEA ESTAS INSTRUCCIONES ANTES DE LA UTILIZACIÓN Y GUÁRDELAS.

La KX-TGA230B/KX-TGA230W es una unidad portátil opcional para el KX-TG2352W/KX-TG2382B.

Este manual de instalación describe únicamente los pasos necesarios para iniciar el funcionamiento de la unidad portátil. Lea las instrucciones de funcionamiento del KX-TG2352W/KX-TG2382B para obtener más detalles.

Accesorios (incluidos)

Para solicitar accesorios extra, llame al 1-800-332-5368.

- | | |
|--|--|
| <input type="checkbox"/> Unidad de carga 1 | <input type="checkbox"/> Batería 1 |
| Cargador N.º de pedido PQLV30017ZB (Negro) | N.º de pedido N4HHGMB00001 (HHR-P103) |
| Adaptador de CA N.º de pedido PQLV2Z (PQLV2) | <input type="checkbox"/> Presilla para el cinturón 1 |
| <input type="checkbox"/> Cubierta de la unidad portátil..... 1 | N.º de pedido PQKE10352Z3 (Negro) |
| N.º de pedido PQKK10131Z3 (Negro) | N.º de pedido PQKE10352Z2 (Blanco) |
| N.º de pedido PQKK10131Z2 (Blanco) | |

Instalación

Conexión del adaptador de CA

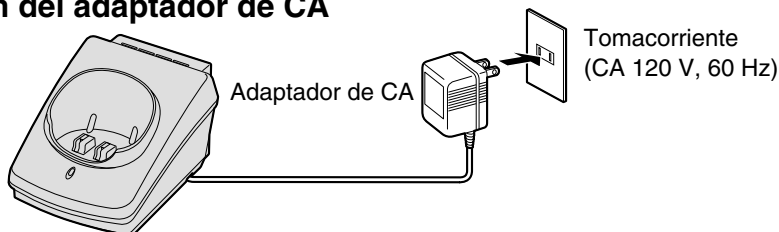

- USE ÚNICAMENTE EL ADAPTADOR DE CA PQLV2 de Panasonic (N.º de pedido PQLV2Z).
- El adaptador de CA deberá permanecer conectado en todo momento. (Durante la utilización es normal que se caliente el adaptador.)

Instalación de la batería

Inserte la batería en la unidad portátil como se muestra ajustando en la polaridad correcta (1). Presione la batería hacia abajo hasta que esté bien instalada en el compartimiento (2). Una vez instalada, cierre la cubierta.

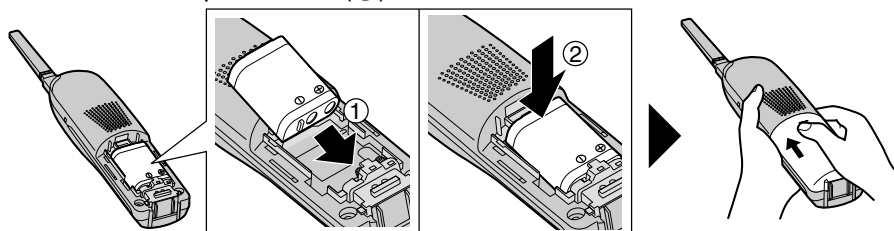

Carga de la batería

Ponga la unidad portátil en la unidad de carga y cárguela durante **15 horas aproximadamente** antes de utilizarla por primera vez.

- El indicador CHARGE se encenderá, sonará un pitido y se visualizará “Charging”.
- Cargue la batería cuando:
 - se visualice “Recharge” en la unidad portátil,
 - “ [■] ” parpadee en el visor, o
 - la unidad portátil emita pitidos intermitentemente mientras esté siendo utilizada.
- Si la batería se ha descargado, la unidad portátil visualizará “Charge for 15h” cuando la ponga en la unidad de carga. La unidad portátil no funcionará. Deje que se cargue.



Información acerca de la batería de la unidad portátil

Después de que su batería Panasonic esté completamente cargada:

Operación	Tiempo de operación
Mientras se utiliza (HABLAR)	Hasta 4 horas
Mientras no se utiliza (Espera)	Hasta 7 días

- **Limpie los contactos de carga de la unidad portátil y de la unidad de carga con un paño suave y seco una vez al mes. Limpie con más frecuencia si la unidad está expuesta a la grasa, el polvo o humedad alta.** Si no, la batería tal vez no se cargue correctamente.

Utilización de la presilla para cinturón

Podrá colgar la unidad portátil en su cinturón o bolsillo utilizando la presilla para cinturón.

Para colocar la presilla para cinturón

Para quitar la presilla para cinturón

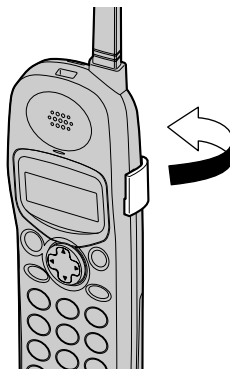
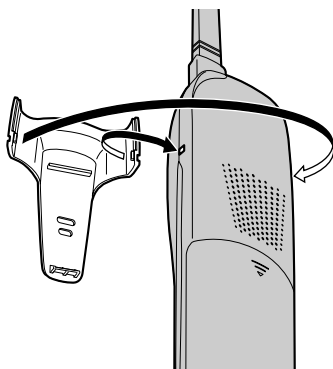

Registro

Esta unidad portátil inalámbrica deberá ser registrada en la unidad base KX-TG2352W/KX-TG2382B. El número de extensión de la unidad portátil será asignado al hacer el registro.

Solamente podrá registrarse una unidad portátil cada vez.

Asegúrese de que la unidad base y las otras unidades portátiles no estén siendo utilizadas. El registro deberá completarse antes de 1 minuto.

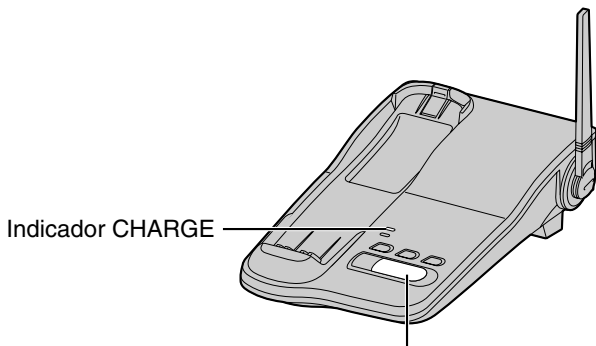

HANDSET LOCATOR [ALL]

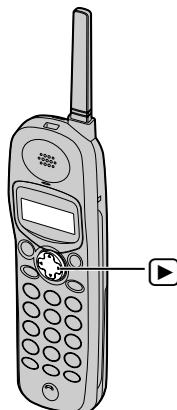

•La ilustración de la unidad base es del KX-TG2352W.

El visor de la unidad portátil muestra las instrucciones como se muestra a la derecha.

Press [ALL] on base for 3 sec, then press [▶].

1 Unidad base:

Presione **HANDSET LOCATOR [ALL]** hasta que el indicador CHARGE parpadee.

2 Unidad portátil:

① Presione [▶].

② Espere hasta que suene un pitido largo y el visor muestre el número registrado. Entonces se habrá completado el registro.

Handset
Registering

Ej., Número de extensión 3

Handset [3]
Registered

•El número de registro “[1]” a “[3]” se mostrará en la parte superior derecha del visor.

[3]

•Podrá detener el registro presionando **[OFF]** en la unidad portátil y presionando **HANDSET LOCATOR [ALL]** en la unidad base.

[■■■■]

•Después de registrar la unidad portátil en la unidad base, confirme que las otras unidades portátiles (la primera y segunda) registradas previamente visualizan “Talk” presionando [📞]. Si una de las unidades portátiles no visualiza “Talk”, vuelva a registrar esa unidad portátil en la unidad base.

Para cancelar el registro de la unidad portátil, consulte las instrucciones de funcionamiento del KX-TG2352W/KX-TG2382B.

Auricular opcional

Enchufando un auricular opcional a la unidad portátil podrá conversar por teléfono con las manos libres. Utilice solamente el auricular Panasonic KX-TCA88.

Para hacer el pedido, llame al número de teléfono para accesorios de la página 1.

Conexión del auricular

Abra la tapa de la toma para auricular y conecte el auricular a la toma para auricular como se muestra.

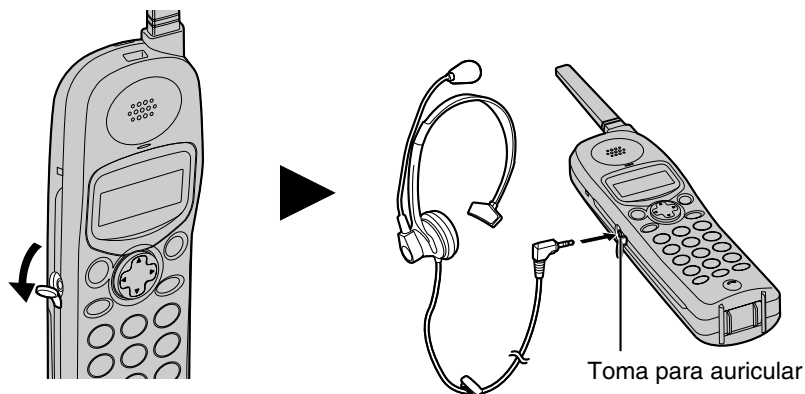

Montaje en pared

El cargador puede montarse en una pared. Conecte el adaptador de CA. Instale los tornillos utilizando la plantilla para pared de abajo. Monte el cargador (①).

Deslícelo hacia abajo (②) y después hacia abajo y hacia la derecha (③) hasta fijarlo en su sitio.

