

Panasonic

2.4GHz Expandable Cordless Handset

Operating Instructions

Model No. **KX-TGA273S**

Pulse-or-tone dialing capability



The KX-TGA273S will only work with the Panasonic cordless phone systems: KX-TG2700/KX-TG2720/ KX-TG2730/KX-TG2740/ KX-TG2750/KX-TG2770/ KX-FPG381

PLEASE READ BEFORE USE AND SAVE.

Charge the battery for about 15 hours before initial use.

Panasonic World Wide Web address: <http://www.panasonic.com>
for customers in the USA or Puerto Rico

Contents by Section

- 1 Getting Started
- 2 Listening to the Radio
- 3 Using the Sleep Timer
- 4 Using the Alarms
- 5 Things You Should Know
- 6 Referencia rápida

Attach your purchase receipt here.

For product service

- Call 1-800-211-PANA(7262) for the location of an authorized servicer.
- Panasonic's e-mail address for customer inquiries: consumerproducts@panasonic.com
for customers in the USA or Puerto Rico ONLY

When you ship the product

- Carefully pack your unit, preferably in the original carton.
- Attach a letter, detailing the symptom, to the outside of the carton.

Symptom

- Send the unit to an authorized servicer, prepaid and adequately insured.
- Do not send your unit to the Panasonic Consumer Electronics Company listed below or to executive or regional sales offices. These locations do not repair consumer products.

If you need assistance with the set-up or operation, please call 1-800-211-PANA(7262)

**Panasonic Consumer Electronics Company,
Division of Matsushita Electric Corporation of America**
One Panasonic Way, Secaucus, New Jersey 07094

**Panasonic Sales Company,
Division of Matsushita Electric of Puerto Rico, Inc.**
Ave. 65 de Infantería, Km. 9.5, San Gabriel Industrial Park
Carolina, Puerto Rico 00985

PQQX13599WA S0203-4043

1-A Accessories (included)

Batteryone
Order No. N4HKGMA00001 (P-P511)

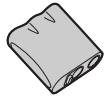

Handset Coverone
Order No. PQKK10126Z1



Belt Clipone
Order No. PQKE10340Z1

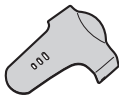

Charger Unitone
Charger Order No. KX-TGA273S
AC Adaptor Order No. PQWATGA273S
Loop Antenna Order No. N1DAEYY00002

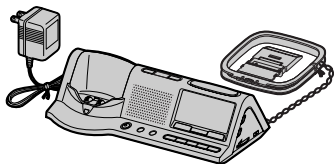

•For extra orders, call
1-800-332-5368.

1-B Location of Controls

Handset

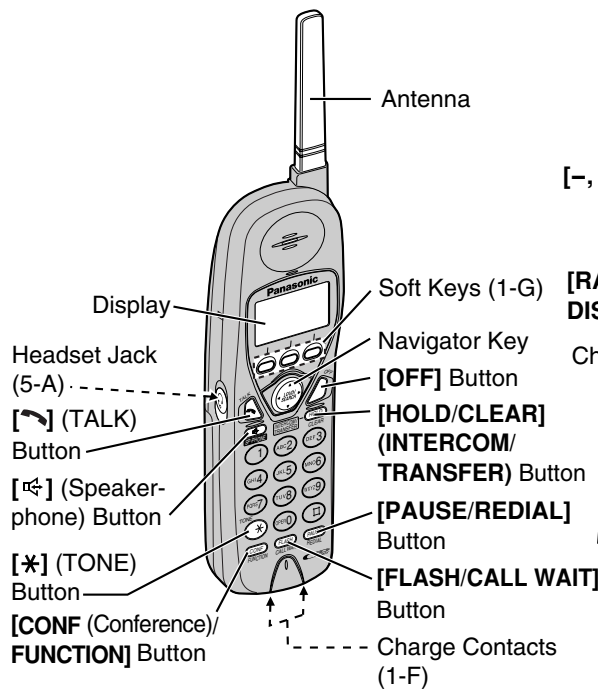

Note: The steps necessary to start up the handset are described in these Operating Instructions. Please read the KX-TG2700/KX-TG2720/KX-TG2730/KX-TG2740/KX-TG2750/KX-TG2770/KX-FPG381 operating instructions for further details about the handset operations.

Charger (with Clock Radio)

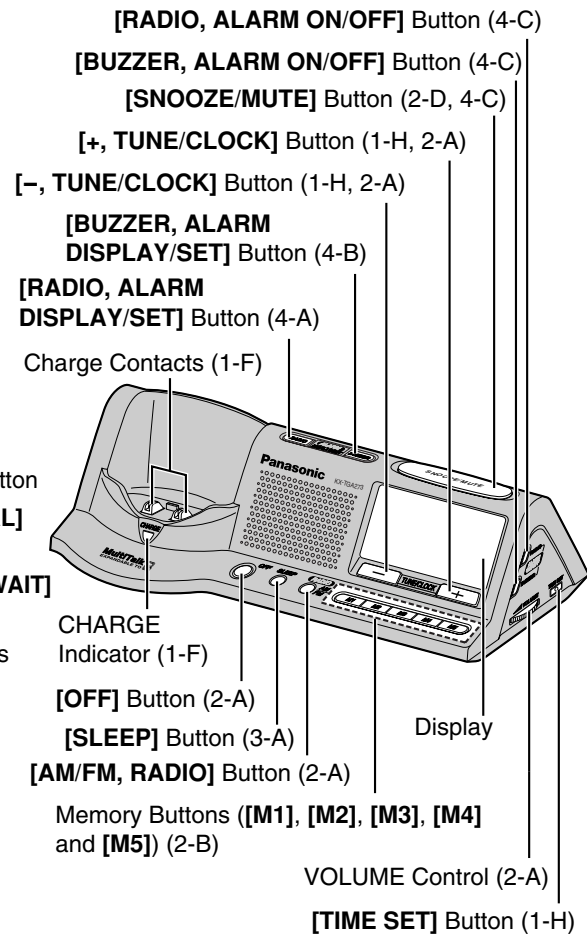

1-C Connecting the AC Adaptor/Setting Up the Loop Antenna

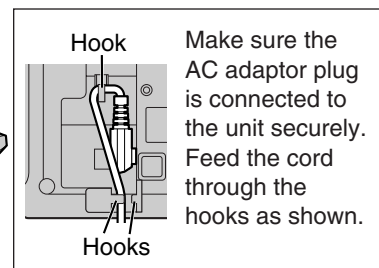
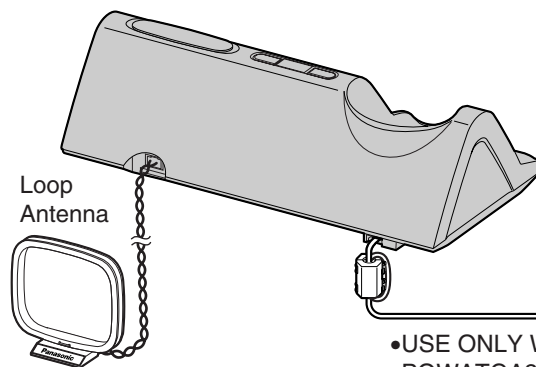
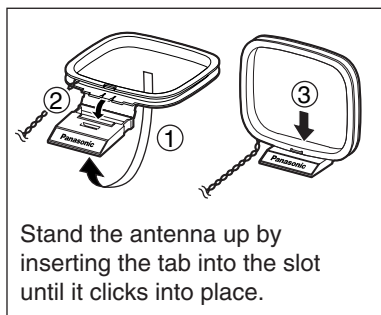

Power Outlet (AC 120 V, 60 Hz)

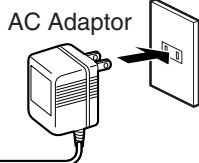

•To disconnect the antenna, firmly pull the antenna cord, holding the cord near the plug.

- USE ONLY WITH Panasonic AC ADAPTOR PQLV1 (Order No. PQWATGA273S).
- The AC adaptor must remain connected at all times. (It is normal for the adaptor to feel warm during use.)

1-D Installing the Handset Battery

Insert the battery (①), and press it down until it snaps into the compartment (②). Close the cover.

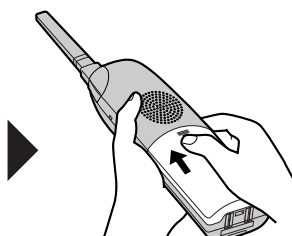
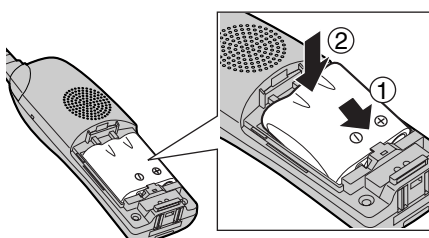

1-E Belt Clip

You can hang the handset on your belt or pocket using the belt clip.

To attach the belt clip

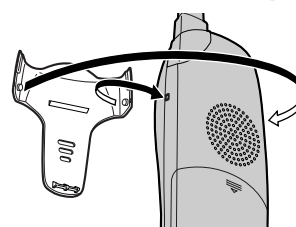

To remove the belt clip

While pressing the top of the clip (A), pull the right edge in the direction of the arrow (B).

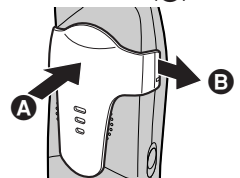

1-F Battery Charge



Place the handset on the charger and charge for **about 15 hours** before initial use.

- The unit beeps once, the CHARGE indicator lights, and "Charging" is displayed.

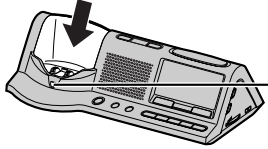

CHARGE Indicator

- Recharge the battery when:
 - "Recharge battery" is displayed,
 - " [] " flashes on the display, or
 - the handset beeps intermittently while it is in use.
- If the battery has been discharged, the handset will display "Charge for 15HRS" and " [] " when you place the handset on the charger. The handset will not work unless the battery is charged. Keep charging.

Battery information

After your Panasonic battery is fully charged:

Operation	Operating time
While in use (TALK)	Up to 4.5 hours
While not in use (Standby)	Up to 11 days*
While using Reception Booster mode	Up to 3.5 hours

*When using 2-Way Radio mode: Up to 12 hours (Standby)

- Clean the charge contacts of the handset and the charger with a soft, dry cloth once a month. Clean more often if the unit is subject to grease, dust or high humidity. Otherwise the battery may not charge properly.

A nickel cadmium battery that is recyclable powers the product you have purchased. At the end of its useful life, under various state and local laws, it is illegal to dispose of this battery into your municipal waste stream. Please call 1-800-8-BATTERY for information on how to recycle this battery.



1-G Handset Registration

This handset must be registered to a KX-TG2700/KX-TG2720/ KX-TG2730/KX-TG2740/KX-TG2750/KX-TG2770/KX-FPG381 base unit.

The handset will be assigned an extension number at registration. The KX-TGA273S will not work without the Panasonic cordless phone systems: KX-TG2700/KX-TG2720/KX-TG2730/KX-TG2740/ KX-TG2750/KX-TG2770/KX-FPG381

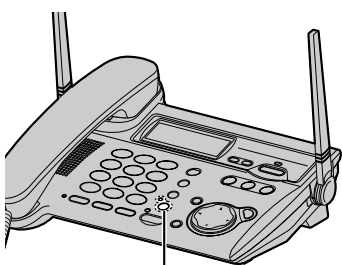

[MUTE] Button and Indicator

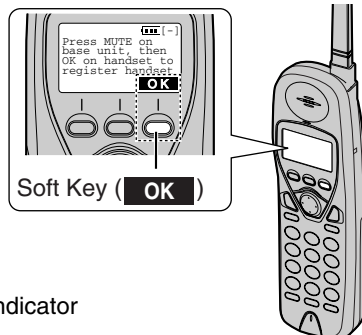

- Base unit model shown here is KX-TG2770. The MUTE button location varies according to the base unit model.

Only one handset can be registered at a time.

Make sure the base unit and the other handsets are not being used. Registration must be completed within 1 minute.

The handset display shows the instructions as shown on the right.

1 Base unit: Press [MUTE].

- The MUTE indicator flashes.

Press MUTE on base unit, then OK on handset to register handset

OK

2 Handset:

- ① Press the soft key ([OK]).
 - ② Wait until a long beep sounds and the display shows the registered number.
- Registration is complete.

Ex. Extension number 2

Handset [2]
Registered

- The registered number "[1]" to "[8]" is shown on the top right of the display.
- You can stop registration by pressing [OFF] on the handset and pressing [MUTE] on the base unit.
- To cancel the handset's registration, please see the base unit Operating Instructions.

1-H Setting Time

The charger unit has a 12-hour clock (monthly accuracy ± 30 seconds). After the AC adaptor is connected, the display shows "--:--". It is normal. Follow the steps on the right to set the time.

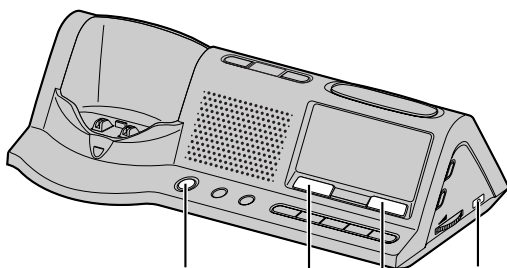

[OFF]

[-, TUNE/CLOCK]

[+, TUNE/CLOCK]

[TIME SET]

1 Press and hold [TIME SET] until the time flashes.

2 Adjust the time by pressing [-, TUNE/CLOCK] or [+ , TUNE/CLOCK].

- Pressing [-] or [+] decreases or increases the time in one-minute units.
- Pressing and holding [-] or [+] decreases or increases the time faster.

3 Press [TIME SET] to set the time.

- The time stops flashing.

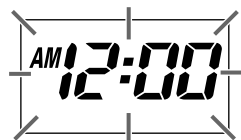

Ex. 3:30PM is set.

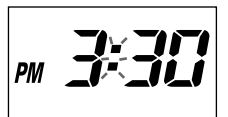

- You can exit time setting mode any time by pressing [OFF].
- If a power failure occurs, the display will show "E." for about 10 minutes, then it will become blank. After power returns, "--:--" will be displayed. The clock memory will be lost. Set the time. The radio alarm and buzzer alarm memory will be retained for about 10 minutes during a power failure (4-A, 4-B).

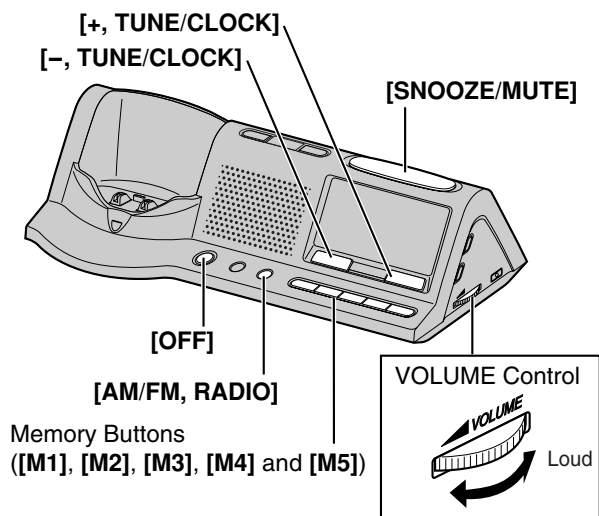

2-A Manual Tuning

- 1 Press **[AM/FM, RADIO]** to turn the radio on.
- 2 Press **[AM/FM, RADIO]** to switch between AM and FM.
- 3 Tune in to the desired station by pressing **[-, TUNE/CLOCK]** or **[+, TUNE/CLOCK]**.
 - Press and hold [-] or [+] to search faster.
- 4 Adjust the volume by using the VOLUME control.



To turn the radio off

Press **[OFF]**.

2-B Preset Tuning

You can assign one FM station and one AM station to each of the 5 memory buttons ([M1], [M2], [M3], [M4] and [M5]) for a total of 10 stations.

To preset stations

- 1 Press **[AM/FM, RADIO]** to turn the radio on.
 - 2 Press **[AM/FM, RADIO]** to switch between AM and FM.
 - 3 Tune in to the desired station by pressing **[-, TUNE/CLOCK]** or **[+, TUNE/CLOCK]**.
 - Press and hold [-] or [+] to search faster.
 - 4 Press and hold a memory button ([M1] to [M5]) until the memory number is displayed.
 - To turn the radio off, press **[OFF]**.
- Ex. Memory Number 1
- If you assign another station of the same band to the memory button, the previously assigned station will be erased.
 • If a power failure occurs, station presets will be retained for about 10 minutes.



To listen to preset stations

- 1 Press **[AM/FM, RADIO]** to turn the radio on.
- 2 Press **[AM/FM, RADIO]** to switch between AM and FM.
- 3 Press the desired memory button ([M1] to [M5]).
 - To turn the radio off, press **[OFF]**.

2-C Improving Reception

For FM

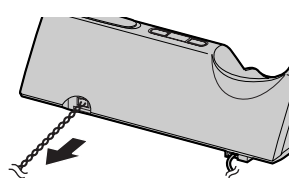

Extend the cord and place the antenna in a location where reception improves.

For AM

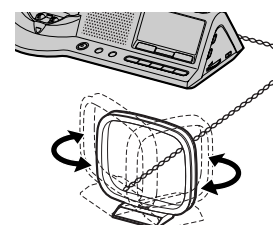

Reorient the antenna horizontally until reception improves.

2-D Muting the Radio

Press **[SNOOZE/MUTE]** while listening to the radio.

- "**MUTE**" flashes on the display.
- To release the mute, press **[SNOOZE/MUTE]** again.

2-E Changing the Tuning Step for FM

You can change the mode for searching for FM stations from 0.2 MHz (factory preset) to 0.1 MHz.

- Please note that changing the step will erase all preset FM stations (2-B) and the station you set for the radio alarm (4-A), and change the radio alarm setting to sound with the buzzer.
1. Press **[AM/FM, RADIO]** to turn the radio on.
 2. Press **[AM/FM, RADIO]** to switch to the FM band.
 3. Press and hold **[AM/FM, RADIO]** for about 5 seconds.
 - The display changes to show the lowest available FM frequency.
- To change the FM frequency in 0.2 MHz steps again, repeat the procedure above.
 - If the AM band is selected and you press and hold **[AM/FM, RADIO]**, for about 5 seconds, the band will change to FM and the tuning step for FM will not change.

3

Using the Sleep Timer Section 3

3-A Setting the Sleep Timer

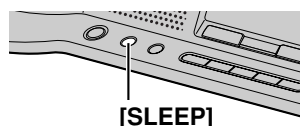

The sleep timer turns the radio off after a set time.

While the radio is on, press **[SLEEP]** repeatedly to select the time (minutes).

- Each time you press **[SLEEP]** the time will change as follows:

30 → 60 → 90 → 120 → OFF

Ex. Sleep Time: 30 min.

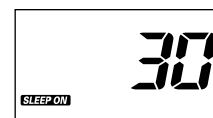

- The radio will automatically turn off after the selected sleep time.
- You cannot set the sleep timer while an alarm is sounding (4-A, 4-B).

To view the time remaining: Press **[SLEEP]**.

To change the setting

1. Press **[SLEEP]**. (The time remaining is displayed.)
2. Immediately after the time remaining is displayed, press **[SLEEP]** repeatedly to select the sleep time.

The charger unit features an alarm clock. You can set the alarm to play the radio or to sound a buzzer at a set time.

The radio alarm and the buzzer alarm can be set separately.

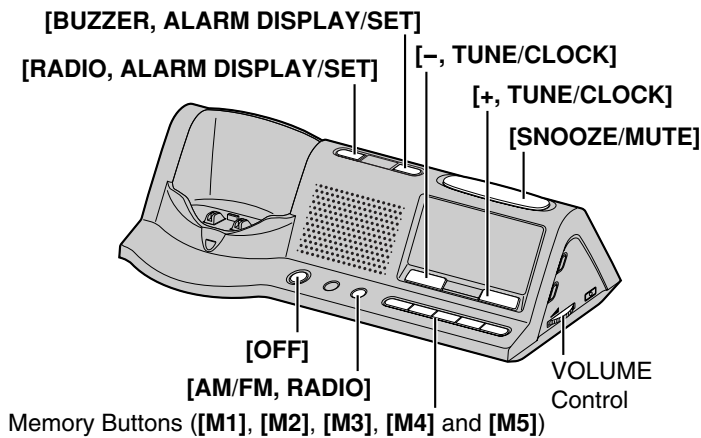

4-A Setting the Radio Alarm

- 1 Press **[AM/FM, RADIO]** to turn the radio on.
- 2 Press **[AM/FM, RADIO]** to switch between AM and FM.
- 3 Tune in to the desired station by pressing **[-, TUNE/CLOCK]** or **[+, TUNE/CLOCK]**.
OR
Press the desired memory button (**[M1]** to **[M5]**).
- 4 Adjust the volume by using the VOLUME control.
- 5 Press and hold **[RADIO, ALARM DISPLAY/SET]** (the button on the top of the unit) until the time flashes.
 
- 6 Set the alarm time by pressing **[-, TUNE/CLOCK]** or **[+, TUNE/CLOCK]**.
 - Pressing and holding **[-]** or **[+]** changes the time faster.
- 7 Press and release **[RADIO, ALARM DISPLAY/SET]** to save the radio alarm time and the station.
 - The time stops flashing and returns to the current time.
 - "**RADIO**" is displayed while the radio alarm is turned on.
- 8 Press **[OFF]** to turn the radio off.
 - The radio will automatically turn on at the set time and will turn off after 1 hour.
 - You can exit alarm setting mode any time by pressing **[OFF]**.
 - The buzzer will sound at the set radio alarm time if you did not turn the radio on in step 1.
 - **To change only the radio alarm time**, repeat steps 5 to 7.
 - If a power failure occurs, the radio alarm time and station preset will be retained for about 10 minutes.

To confirm the radio alarm time and station:

Press and release **[RADIO, ALARM DISPLAY/SET]**.

- The alarm time and the station will be displayed for about 3 seconds.

4-B Setting the Buzzer Alarm

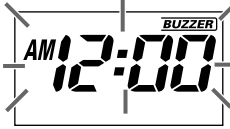
- 1 Press and hold **[BUZZER, ALARM DISPLAY/SET]** (the button on the top of the unit) until the time flashes.
 
 - 2 Set the alarm time by pressing **[-, TUNE/CLOCK]** or **[+, TUNE/CLOCK]**.
 - Pressing and holding **[-]** or **[+]** changes the time faster.
 - 3 Press and release **[BUZZER, ALARM DISPLAY/SET]** to save the buzzer alarm time.
 - The time stops flashing and returns to the current time.
 - "**BUZZER**" is displayed while the buzzer alarm is turned on.
 - The buzzer will start at the set time and will automatically stop after 10 minutes.
 - You can exit alarm setting mode any time by pressing **[OFF]**.
 - If a power failure occurs, the buzzer alarm time will be retained for about 10 minutes.
- To confirm the buzzer alarm time:**
Press and release **[BUZZER, ALARM DISPLAY/SET]**.
- The alarm time will be displayed for about 3 seconds.

4-C Stopping the Alarm

When the alarm sounds at the set time, "**ALARM ON**" is displayed and "**RADIO**" and/or "**BUZZER**" flashes.

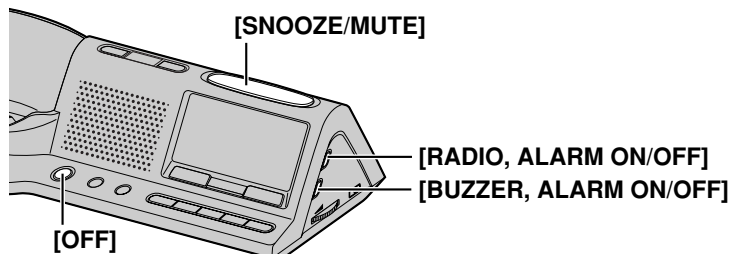

To stop the alarm temporarily (SNOOZE)

Press **[SNOOZE/MUTE]**.

- The alarm will then start again in 6 minutes. You can press **[SNOOZE/MUTE]** again to stop the alarm.

To stop the alarm for the day

Press **[OFF]**.

- The setting remains and the alarm will sound daily until you stop the alarm completely. "**RADIO**" and/or "**BUZZER**" will remain on the display.

To stop the alarm completely

1. While the alarm is sounding or the SNOOZE mode is on, press **[OFF]**, then follow step 2.
OR
If the alarm is not sounding or the SNOOZE mode is not used, go to step 2.
2. Press **[RADIO, ALARM ON/OFF]** or **[BUZZER, ALARM ON/OFF]** to turn the alarm off.
 - "**RADIO**" or "**BUZZER**" disappears from the display.
 - **To turn the alarm on again**, press **[RADIO, ALARM ON/OFF]** or **[BUZZER, ALARM ON/OFF]**.



5-A Optional Headset

Plugging an optional headset into the handset allows for a hands-free phone conversation. Please use only a Panasonic KX-TCA60, KX-TCA86, KX-TCA88, KX-TCA91, KX-TCA92 or KX-TCA98 headset. To order, call the accessories telephone number in section 1-A.

To connect a headset

Open the headset jack cover, and connect the headset to the headset jack as shown.

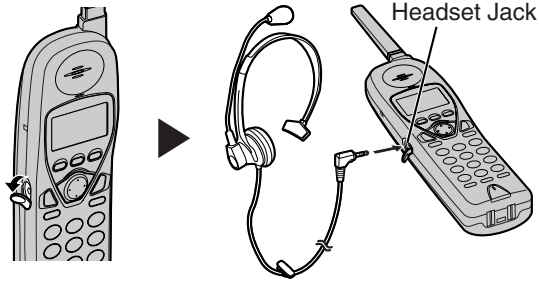

Headset sold separately.
Model shown here is KX-TCA88.

- To switch to the speakerphone while using the headset: Press []. To return to the headset, press [].

5-B Troubleshooting (for Charger Unit)

Problem	Cause & Remedy
The clock shows “-:-:-”.	•The clock needs to be set (1-H).
There is excessive noise from the radio.	•Move the charger away from other electrical appliances.
No sound from the radio.	•Make sure the AC adaptor is connected and the antenna is standing (1-C).
“E.” is displayed below the time.	•A power failure may have occurred or the AC adaptor may be disconnected. Reconnect power. If the unit loses power for about 10 minutes, clock memory will be lost (1-H). Radio and buzzer alarm settings (4-A, 4-B), and radio station presets will also be lost (2-B).
All preset FM stations have been erased and the radio alarm does not sound at the set time.	•If you have changed the tuning step for FM (2-E), all preset FM stations and the radio alarm setting will be erased. The buzzer alarm will sound at the set time instead of the radio.
The radio/buzzer alarm does not sound at the set time.	•A power failure may have occurred and the alarm time may be erased.
If you cannot solve your problem	<ul style="list-style-type: none"> •For handset troubleshooting, please see the base unit Operating Instructions. •Call our customer call center at 1-800-211-PANA(7262). •Panasonic’s e-mail address for customer inquiries: consumerproducts@panasonic.com for customers in the USA or Puerto Rico ONLY

5-C FCC and Other Information

WHEN PROGRAMMING EMERGENCY NUMBERS AND/OR MAKING TEST CALLS TO EMERGENCY NUMBERS:

- 1) Remain on the line and briefly explain to the dispatcher the reason for the call.
- 2) Perform such activities in the off-peak hours, such as early morning or late evenings.

This device complies with Part 15 of the FCC Rules. Operation is subject to the following two conditions: (1) This device may not cause harmful interference, and (2) this device must accept any interference received, including interference that may cause undesired operation.

Privacy of communications may not be ensured when using this phone.

CAUTION:

Any changes or modifications not expressly approved by the party responsible for compliance could void the user’s authority to operate this device.

Note:

This equipment has been tested and found to comply with the limits for a Class B digital device, pursuant to Part 15 of the FCC Rules. These limits are designed to provide reasonable protection against harmful interference in a residential installation. This equipment generates, uses, and can radiate radio frequency energy and, if not installed and used in accordance with the instructions, may cause harmful interference to radio communications. However, there is no guarantee that interference will not occur in a particular installation. If this equipment does cause harmful interference to radio or television reception, which can be determined by turning the equipment off and on, the user is encouraged to try to correct the interference by one or more of the following measures:

- Reorient or relocate the receiving antenna.
- Increase the separation between the equipment and receiver.
- Connect the equipment into an outlet on a circuit different from that to which the receiver is connected.
- Consult the dealer or an experienced radio/TV technician for help.

Operating near 2.4GHz electrical appliances may cause interference. Move away from the electrical appliances.

CAUTION:

To comply with FCC RF exposure requirements, the handset should be carried with the specific belt-clip provided for the handset to ensure compliance. Other non-tested belt-clips or similar body-worn accessories may not comply, therefore, should be avoided.

This equipment is hearing aid compatible as defined by the FCC in 47 CFR Section 68.316.

When you hold the phone to your ear, noise might be heard in your Hearing Aid. Some Hearing Aids are not adequately shielded from external RF (radio frequency) energy. If noise occurs, use an optional headset accessory or the speakerphone option (if applicable) when using this phone. Consult with your audiologist or Hearing Aid manufacturer about the availability of Hearing Aids which provide adequate shielding to RF energy commonly emitted by digital devices.

CAUTION:

To reduce the risk of fire or injury to persons, read and follow these instructions.

1. Use only the battery(ies) specified.
2. Do not dispose of the battery(ies) in a fire. They may explode. Check with local waste management codes for special disposal instructions.
3. Do not open or mutilate the battery(ies). Released electrolyte is corrosive and may cause burns or injury to the eyes or skin. The electrolyte may be toxic if swallowed.

- Exercise care in handling batteries in order not to short the battery to conductive materials such as rings, bracelets, and keys. The battery and/or conductor may overheat and cause burns.
- Charge the battery(ies) provided with or identified for use with this product only in accordance with the instructions and limitations specified in this manual.

WARNING:

TO PREVENT FIRE OR SHOCK HAZARD, DO NOT EXPOSE THIS PRODUCT TO RAIN OR ANY TYPE OF MOISTURE.

- The AC adaptor is used as the main disconnect device, ensure that the AC outlet is located/installed near the unit and is easily accessible.

For your future reference

Serial No. _____ Date of purchase _____
(found on the bottom of the unit)

Name and address of dealer _____

- This cordless telephone is designed for use in the United States of America. Sale or use of this product in other countries may violate local laws.
- Ce téléphone sans fil est conçu pour être utilisé aux États-Unis d'Amérique. La vente ou l'emploi de cet appareil dans certains autres pays peut constituer une infraction à la législation locale.
- Este teléfono sin cordón fue elaborado para uso en los Estados Unidos de América. La venta o el empleo de este producto en ciertos países puede constituir violación de la legislación local.
- このコードレス電話機は、日本国外での使用を目的として設計されており、日本国内での使用は法律違反となります。従って、当社では日本国内においては原則として修理などのサービスは致しかねます。

5-D Specifications

- Handset**
 - Power Supply:** Ni-Cd battery (3.6 V, 850 mAh)
 - Frequency:** 2.40 GHz – 2.48 GHz
 - Dimensions (H x W x D):** Approx. 242 mm x 53 mm x 40 mm
(9 17/32" x 2 3/32" x 1 9/16")
 - Mass (Weight):** Approx. 220 g (0.48 lb.)
 - Security Codes:** 1,000,000
- Dialing Mode:** Tone (DTMF)/Pulse
- Charger**
 - Power Supply:** AC Adaptor (120 V AC, 60 Hz)
 - Power Output:** 300 mW (RMS....max.)
 - Frequency Range:** **FM:** 87.9 – 107.9 MHz (200 kHz steps)
87.5 – 108.0 MHz (100 kHz steps)
AM: 520 – 1710 kHz (10 kHz steps)
 - Frequency Response:** 40 Hz – 4 kHz for FM band
 - Monthly Accuracy:** ±30 seconds
 - Speaker:** 3.6 cm (1 13/32") 6 Ω x 1
 - Dimensions (H x W x D):** Approx. 64 mm x 187 mm x 87 mm
(2 17/32" x 7 3/8" x 3 7/16")
 - Mass (Weight):** Approx. 230 g (0.51 lb.)
- Operating Environment:** 5 °C – 40 °C (41 °F – 104 °F)

Specifications are subject to change without notice.

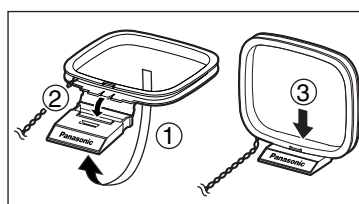
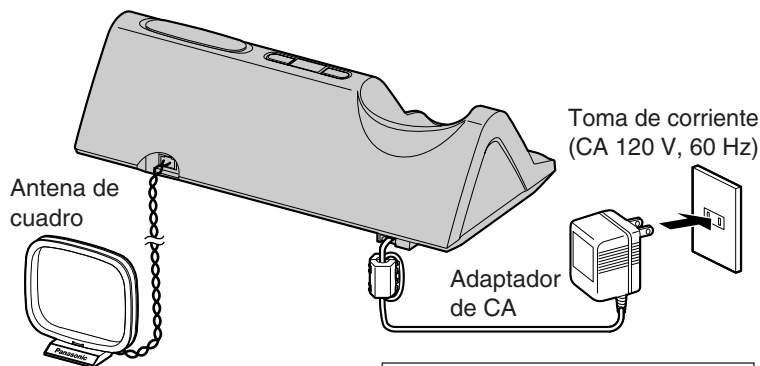
6-A Preparación**Para conectar el adaptador de CA o instalar la antena de cuadro**

Gancho Asegúrese de que la clavilla del adaptador de CA esté firmemente conectada a la unidad. Enchufe el cable a través de los ganchos como se muestra en la ilustración.

Ganchos

- Use solamente con el adaptador de CA PQLV1 de Panasonic (N.º de pedido PQWATGA273S).
- El adaptador de CA deberá permanecer conectado en todo momento. (Durante la utilización es normal que se caliente el adaptador.)

Instalación de la batería

Inserte la batería (①), y empujela hacia abajo hasta que encaje con un chasquido en su compartimento (②). Cierre la cubierta.

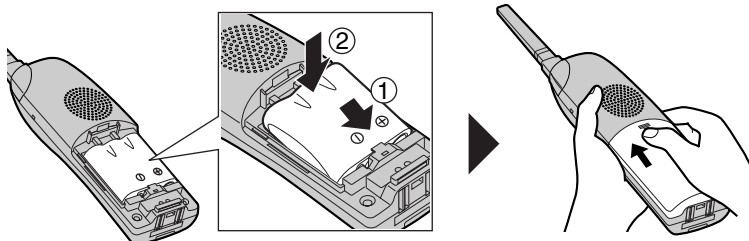
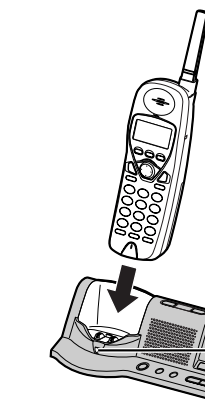
**Carga de la batería**

Ponga la unidad portátil en el cargador y cárguela durante **15 horas aproximadamente** antes de utilizarla por primera vez.

- Sonara un pitido, el indicador CHARGE se encenderá y se visualizará "Charging".

Indicador CHARGE

Para usar la presilla para el cinturón, consulte la sección 1-E. Para usar auriculares opcionales (modelo n.º KX-TCA60, KX-TCA86, KX-TCA88, KX-TCA91, KX-TCA92 o KX-TCA98), consulte la sección 5-A.



6-B Para escuchar la radio

Para registrar la unidad portátil

Esta unidad portátil deberá ser registrada en la unidad base KX-TG2700/KX-TG2720/KX-TG2730/KX-TG2740/KX-TG2750/KX-TG2770/KX-FPG381. El número de extensión de la unidad portátil será asignado al hacer el registro.

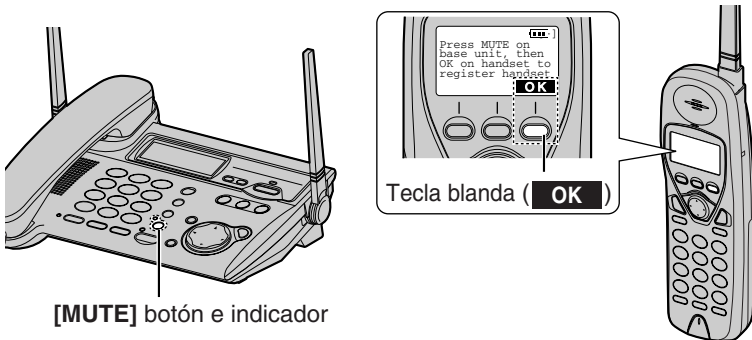

- El modelo de unidad base que aparece aquí es KX-TG2770. La ubicación del botón MUTE varía según el modelo de unidad base.

Solamente podrá registrarse una unidad portátil cada vez.

Asegúrese de que la unidad base y las otras unidades portátiles no estén siendo utilizadas. El registro deberá completarse antes de 1 minuto.

El visualizador de la unidad portátil muestra las instrucciones como se muestra a la derecha.

1 Unidad base: Presione [MUTE].

- La luz del indicador MUTE parpadeará.

2 Unidad portátil:

- 1 Presione la tecla blanda derecha (OK).

- 2 Espere hasta que suene un pitido largo y el visualizador muestre el número registrado.

- Entonces se habrá completado el registro.

- El número de registro "[1]" a "[8]" se mostrará en la parte superior derecha del visualizador.

- Podrá parar el registro presionando [OFF] en la unidad portátil y presionando [MUTE] en la unidad base.

- Para cancelar el registro de la unidad portátil, consulte las instrucciones de funcionamiento de la unidad base.

Para poner la hora

La unidad de carga tiene un reloj de 12 horas (con una desviación mensual máxima de ± 30 segundos). Después de conectar el adaptador de CA, aparece en pantalla "-:-:--". Esto es normal. Siga los pasos a continuación para poner la hora.

- 1 Mantenga presionado [TIME SET] hasta que la hora parpadee.

- 2 Ajuste la hora presionando [-, TUNE/CLOCK] o [+ , TUNE/CLOCK].

- Presionando [-] o [+] se aumenta o se reduce la hora en unidades de un minuto.
- Manteniendo presionado [-] o [+] se reduce o se aumenta la hora más rápidamente.

- 3 Presione [TIME SET] para poner la hora.

- La hora deja de parpadear.

Press MUTE on base unit, then OK on handset to register handset.

Ej.: Número de extensión 2

Handset [2]
Registered

AM 12:00

Ej.: Se ha puesto la hora 3:30 PM.

PM 3:30

Encendido manual

- 1 Presione [AM/FM, RADIO] para encender la radio.

- 2 Presione [AM/FM, RADIO] para cambiar de AM a FM y viceversa.

- 3 Sintonice la estación deseada presionando [-, TUNE/CLOCK] o [+ , TUNE/CLOCK].

- Mantenga presionado [-] o [+] para buscar más rápido.

- 4 Ajuste el volumen por medio del mando VOLUME.

PM 3:40
FM 87.9MHz

Para apagar la radio

Presione [OFF].

Presintonización

Se puede asignar una estación FM y una estación AM a cada uno de los 5 botones de memoria ([M1], [M2], [M3], [M4] y [M5]) para presintonizar un total de 10 estaciones.

Para presintonizar estaciones:

- 1 Presione [AM/FM, RADIO] para encender la radio.

- 2 Presione [AM/FM, RADIO] para cambiar de AM a FM y viceversa.

- 3 Sintonice la estación deseada presionando [-, TUNE/CLOCK] o [+ , TUNE/CLOCK].

- Mantenga presionado [-] o [+] para buscar más rápido.

- 4 Mantenga presionado un botón de memoria ([M1] a [M5]) hasta que aparezca en pantalla el número de la memoria.

- Para apagar la radio, presione [OFF].

PM 10:30
AM 520kHz

Ej.: Número de memoria 1

Para escuchar las estaciones presintonizadas:

- 1 Presione [AM/FM, RADIO] para encender la radio.

- 2 Presione [AM/FM, RADIO] para cambiar de AM a FM y viceversa.

- 3 Presione el botón de memoria deseado ([M1] a [M5]).

- Para apagar la radio, presione [OFF].

Para mejorar la recepción

Para FM: Extienda el cable y coloque la antena en un lugar en el que se observe una mejora en la recepción.

Para AM: Vuelva a orientar la antena horizontalmente hasta observar una mejora en la recepción.

Para silenciar la radio

Presione [SNOOZE/MUTE] mientras escucha la radio.

- Para anular el silenciamiento, presione [SNOOZE/MUTE] de nuevo.

Para cambiar el intervalo de sintonización de FM

Se puede cambiar el modo de búsqueda de estaciones FM de 0.2 MHz (preconfiguración de fábrica) a 0.1 MHz.

- Tenga en cuenta que al cambiar el intervalo de sintonización se borrarán todas las estaciones FM presintonizadas, así como la estación que usted ha asignado a la alarma de radio (6-D), y que la configuración de alarma de radio se cambiará a alarma de timbre.

1. Presione [AM/FM, RADIO] para encender la radio.

2. Presione [AM/FM, RADIO] para cambiar a la banda de FM.

3. Mantenga presionado [AM/FM, RADIO] durante unos 5 segundos.

- Para cambiar de nuevo la frecuencia de FM a intervalos de 0.2 MHz, repita el procedimiento anterior.

6-C Configuración del temporizador para dormir

Con la radio encendida, presione **[SLEEP]** repetidamente para seleccionar la hora (en minutos). Ej.: Tiempo de temporizador para dormir: 30 min.

- Con cada presión de **[SLEEP]** la hora cambia como sigue:

30 → 60 → 90 → 120 → OFF

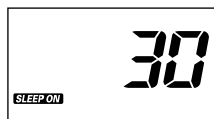

- La radio se apagará automáticamente después de que transcurra el tiempo de temporizador para dormir seleccionado.

6-D Uso de las alarmas

Para configurar la alarma de radio

- 1 Presione **[AM/FM, RADIO]** para encender la radio.
- 2 Presione **[AM/FM, RADIO]** para cambiar de AM a FM y viceversa.
- 3 Sintonice la estación deseada presionando **[-, TUNE/CLOCK]** o **[+, TUNE/CLOCK]**.
○
Presione el botón de memoria deseado (**[M1]** a **[M5]**).
- 4 Ajuste el volumen por medio del mando **VOLUME**.
- 5 Mantenga presionado **[RADIO, ALARM DISPLAY/SET]** (el botón situado en la parte superior de la unidad) hasta que la hora parpadee.
- 6 Configure la hora a la que debe sonar la alarma presionando **[-, TUNE/CLOCK]** o **[+, TUNE/CLOCK]**.
• Manteniendo presionado **[-]** o **[+]** se cambia la hora más rápidamente.
- 7 Presione y luego suelte **[RADIO, ALARM DISPLAY/SET]** para guardar la hora de la alarma de radio y la estación.
- 8 Presione **[OFF]** para apagar la radio.



Para configurar la alarma de timbre

- 1 Mantenga presionado **[BUZZER, ALARM DISPLAY/SET]** (el botón situado en la parte superior de la unidad) hasta que la hora parpadee.
- 2 Configure la hora de la alarma presionando **[-, TUNE/CLOCK]** o **[+, TUNE/CLOCK]**.
• Manteniendo presionado **[-]** o **[+]** se cambia la hora más rápidamente.
- 3 Presione y luego suelte **[BUZZER, ALARM DISPLAY/SET]** para guardar la hora de la alarma de timbre.



Para detener la alarma

Para detener la alarma temporalmente (SNOOZE):

Presione **[SNOOZE/MUTE]**.

Para detener la alarma para todo el día: Presione **[OFF]**.

- La configuración no cambia y la alarma sonará diariamente a la misma hora, a no ser que usted la detenga completamente.

Para detener la alarma completamente:

1. Mientras suena la alarma o mientras está activado el modo **SNOOZE**, presione **[OFF]** y luego siga el paso 2.
○
Si la alarma no está sonando o no está activado el modo **SNOOZE**, vaya al paso 2.
2. Presione **[RADIO, ALARM ON/OFF]** o **[BUZZER, ALARM ON/OFF]** para apagar la alarma.
• Para volver a encender la alarma, presione **[RADIO, ALARM ON/OFF]** o **[BUZZER, ALARM ON/OFF]**.