

Panasonic

2.4GHz Cordless Station Unit

Model No. **KX-TGA420B**

Pulse-or-tone dialing capability

Operating Instructions



KX-TGA420B can only work with
Panasonic KX-TG2000B/KX-TG4000B
cordless phone system.

Caller ID Compatible

PLEASE READ BEFORE USE AND SAVE.

Charge the battery for about 8 hours before initial use.

Panasonic World Wide Web address: <http://www.panasonic.com>
for customers in the USA or Puerto Rico

Before Initial Use

Please read **IMPORTANT SAFETY INSTRUCTIONS** on page 72 before use.
Read and understand all instructions.

Thank you for purchasing your new Panasonic cordless telephone.

Caller ID and Call Waiting Service, where available, are telephone company services. After subscribing to Caller ID, this phone will display a caller's name and phone number. Call Waiting Caller ID, which displays a second caller's name and phone number while the user is on another call on the same line, requires a subscription to both Caller ID and Call Waiting. Please make sure from the telephone company that Call Waiting Caller ID service is activated.

Attach your purchase receipt here.

For your future reference

Serial No _____

Date of purchase _____

(found on the bottom of the unit)

Name and address of dealer _____

Accessories (included) For extra orders, call 1-800-332-5368

- AC Adaptor (p 9)
Order No. PQLV1Z

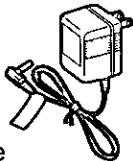

one

- Handset (p 8)
Order No. PQJXF0113Z

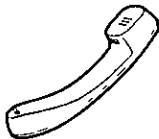

one

- Handset Cord (p 8)
Order No. PQJA212N

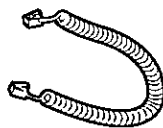

one

- Battery (p 8)
Order No. HHR-15F2G1

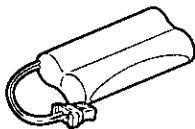

one

- Battery Cover (p 8)
Order No. PQKK10123Z1

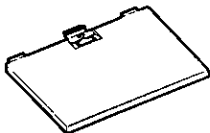

one

- Wall Mounting Adaptor (p 62)
Order No. PQKL24Z0

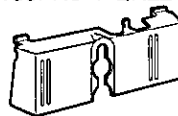

one

This model KX-TGA420B is one of the stations (extensions) and must be used with a KX-TG4000B/KX-TG2000B base unit (operator). It is necessary to register this station unit to the base unit before use (p 12, 13). The station unit does not work without the base unit.

An Introduction to the Station Unit

How the station unit takes part in the system

The station unit KX-TGA420B is one of the stations (extensions) of the KX-TG4000B/KX-TG2000B base unit, the same as the cordless handsets*. A maximum of 8 stations in any combination of the station units and the cordless handsets can be installed to the base unit (the first station will be the handset included with the base unit).

*The handset is included with the base unit and is also the optional cordless handset KX-TGA400B/KX-TGA200B.

Example: 8 stations (extensions) consist of 6 station units and 2 cordless handsets.

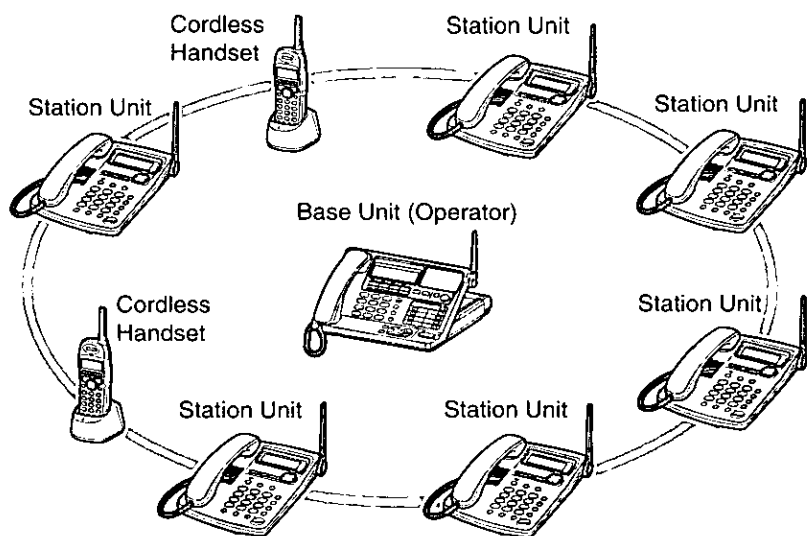

• The illustration of the base unit is KX-TG4000B, and the illustrations of the cordless handsets are those included in KX-TG4000B, and KX-TGA400B.

Portability (using the battery power mode)

Calls are transmitted between the station unit and the base unit using radio waves, the same as the cordless handset.

The station unit can be used with the AC adaptor connected to the power outlet (AC power mode, p. 9). However, if you want to use the station unit in a remote location away from the power outlet, a rechargeable Nickel-Metal Hydride (Ni-MH) battery will supply power (Battery power mode). You need to install the battery and charge it for about **8 hours** before initial use (p. 8, 9, 10).

Contents

Chapter 1 *Preparation*

Location of Controls	6
Display	7
Installation	8
Installing the Battery	8
Connecting the Handset	8
Connecting the AC Adaptor	9
Battery Charge (To Use the Battery Power Mode)	10
Registration	12
Registering the Station Unit Using the PIN	13
Programmable Settings	14
Programming Guidelines	14
Function Menu Table	15
Selecting the Ringer Volume	16

Chapter 2 *Basic Operation*

Making Calls	17
Answering Calls	20
Using Other Lines During a Conversation	21
Intercom	22
Making Intercom Calls	22
Answering Intercom Calls	22
Transferring a Call	23
Conference	24
Using the Directory	25
Storing Names and Numbers in the Directory	25
Dialing from the Directory	27
Editing an Item in the Directory	28
Erasing an Item in the Directory	28
Caller ID Service	29
Using the Caller List	30
Viewing the Caller List	30
Calling Back from the Caller List	31
Editing the Caller's Phone Number	31
Storing Caller List Information in the Directory	32
Erasing Caller List Information	33

Chapter 3 *Advanced Operation*

Special Features	34
How to Use the PAUSE Button	
(For Analog PBX Line/Long Distance Service Users)	34
For Call Waiting Service Users	34
FLASH Button	34

Temporary Tone Dialing (For Rotary or Pulse Service Users)	35
Other Programmable Settings	35
Selecting the Ringer Pattern	35
Calling Line Selection	36
Incoming Call Tone	37
Erasing the Directory, Caller List and Redial List	38
Clearing Settings	38
Canceling Registration	39

Chapter 1

Chapter 4	System Features
------------------	------------------------

Voice Mail System	40
Setting the Mailbox Password	41
Automated Attendant System	42
How Automated Attendant System Works	42
Setting the Answer Mode	43
Recording a Personal Greeting Message	44
Call Transfer Status	45
Call Operator Status	46
Listening to Messages	48
Transferring a Message	50
Erasing a Message	50
Listening to Messages in the General Delivery Mailbox	50
Delivering Your Own Memo Message	51
Other Voice Mail System Features	52
Transferring a Call to Other Person's Mailbox	52
Message Menu Mode	52
Remote Operation from a Touch Tone Phone	53
How to Access the Voice Mail System	53
Pager Call	56
Storing a Pager Number	56
Storing the Pager Display Number	57
Setting the Unit to Call a Pager	58

Chapter 2

Chapter 3

Chapter 4

Chapter 5	Useful Information
------------------	---------------------------

Battery Replacement	59
Using an Optional Headset	60
Wall Mounting	62
Error Messages	64
Before Requesting Help	67
Important Safety Instructions	72
FCC and Other Information	74
Index	75

Chapter 5

Location of Controls

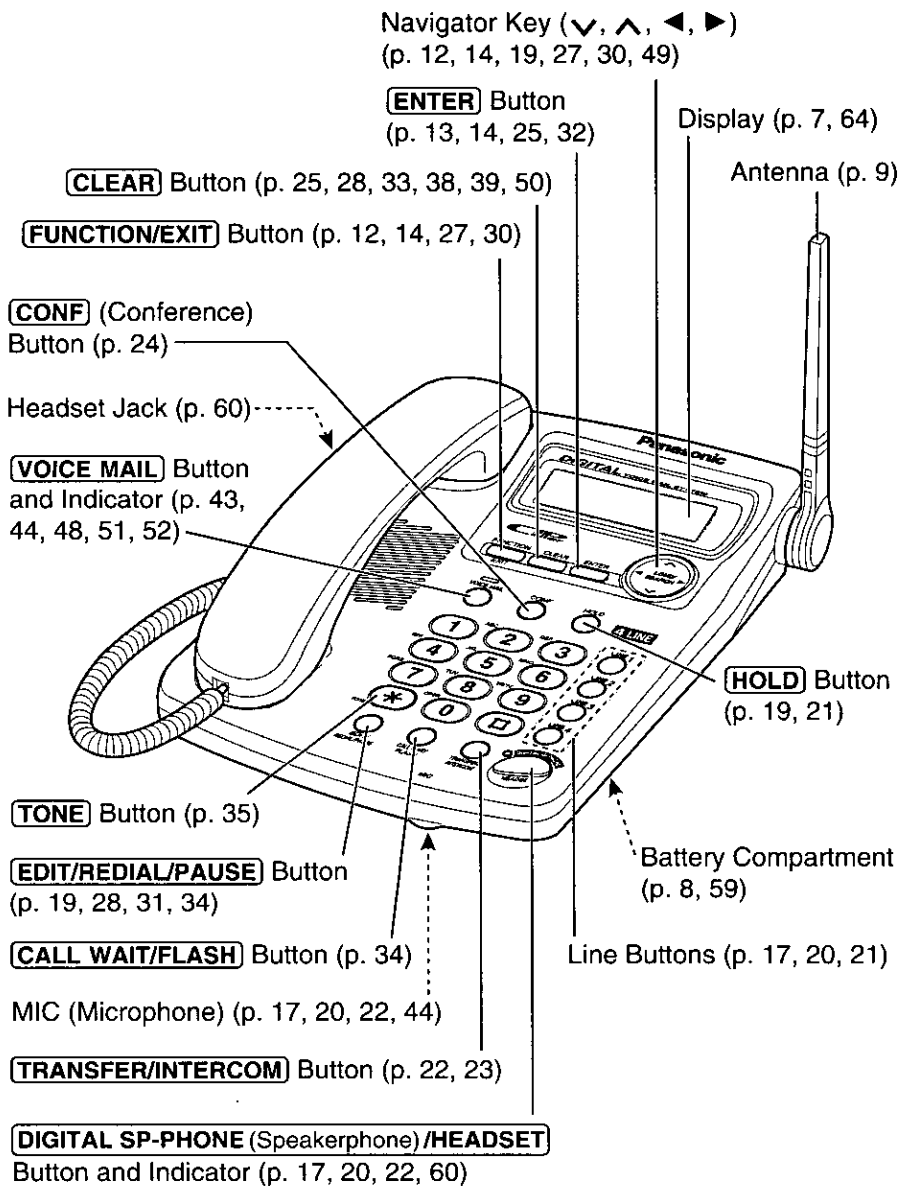

If your unit is registered to KX-TG2000B:

The **LINE 3** and **LINE 4** buttons are inoperative. If **LINE 3** or **LINE 4** is pressed, "Line not available" will be shown on the display.

Display

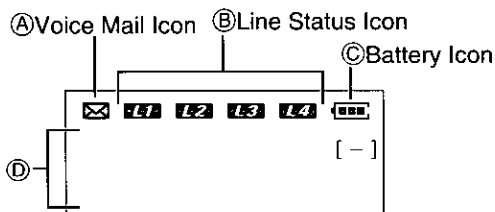

Ⓐ The voice mail icon flashes if there is at least one new message in your mailbox (p. 48). During playback, it will be displayed.

Ⓑ The line status icons function as follows. (If your unit is registered to KX-TG2000B, “**L3**” and “**L4**” will not be displayed.)

Off (invisible)	The line is free.
On	The line is being used.
Flashing	A call is on hold. The Automated Attendant System or Answering System is responding to a call (p. 40, 42).
Flashing quickly	A call is being received.

Ⓒ The battery icon indicates the battery strength (p. 10).

Ⓓ “[-]” is displayed in the standby mode if the station unit is not registered to the base unit. At registration the unit will be assigned the extension number, and the number will display in square brackets in the standby mode (p. 12, 13).

The display shows the dialed number, call status, programming options and directory items etc. If you subscribe to a Caller ID service, caller information will be displayed (p. 29).

Backlit LCD display

While the AC adaptor is connected (AC power mode, p. 9) and you are operating the unit, the display will remain lit. However, while the unit is powered by the battery (battery power mode, p. 10), the display will not light.

Installation

Installing the Battery

If you want to use the station unit in a remote location from the power outlet, a rechargeable Nickel-Metal Hydride (Ni-MH) battery will power the unit (Battery power mode). The battery will also work as emergency power during a power failure.

The battery is charged in the battery compartment while the AC adaptor is connected (p. 9). It takes about **8 hours** to charge fully. For details about battery charge and battery information, see pages 10 and 11.

- 1** Install the battery in the battery compartment. Be sure wires are free from being pressed by the battery body or battery cover.

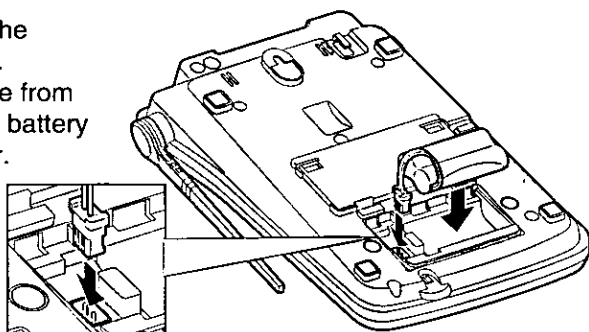

- 2** Close the battery cover: Slide the battery cover, and push it forward as shown until it locks into place.

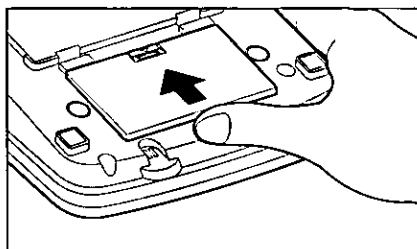
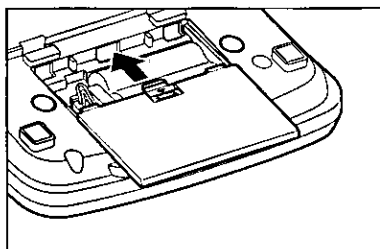

Connecting the Handset

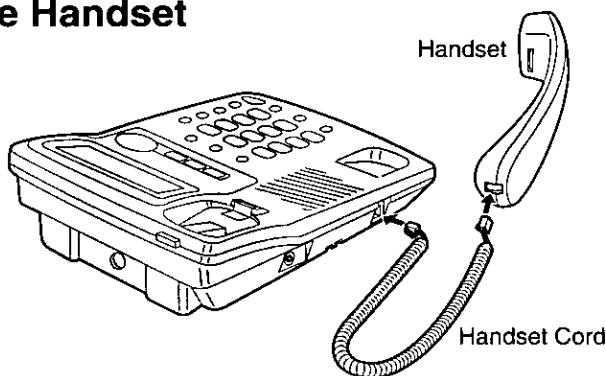

- Use only a Panasonic Handset for the KX-TGA420B.



Connecting the AC Adaptor

The station unit is powered by the AC power while the AC adaptor is connected (AC power mode). At the same time the battery is being charged in the battery compartment (p. 8).

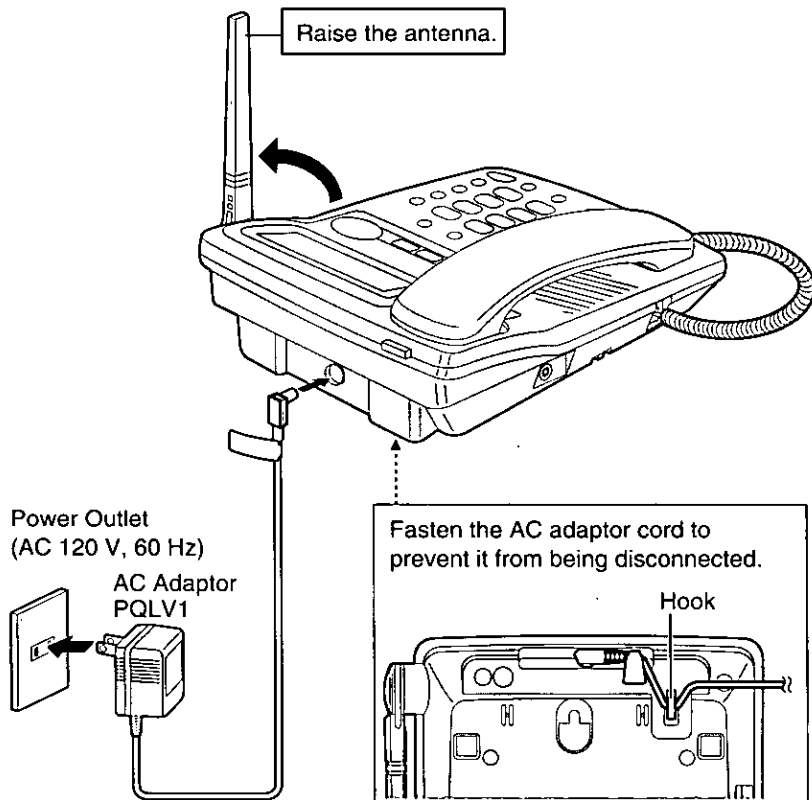

- USE ONLY WITH Panasonic AC ADAPTOR PQLV1 (Order No. PQLV1Z).
- The AC adaptor must remain connected in the AC power mode (while charging the battery). (It is normal for the adaptor to feel warm during use.)

For noise-free operation:

Calls are transmitted between the station unit and the base unit using radio waves, the same as the cordless handset.





- If you use the station unit near a microwave oven which is being used, noise may be heard from the receiver. Move away from the microwave oven and locate the station unit near the base unit.
- If you use the station unit near another phone's base unit, noise may be heard. Move away from the cordless phone's base unit and locate the station unit near the base unit.

Battery Charge (To Use the Battery Power Mode)

The station unit can be used with the AC adaptor connected (AC power mode). However, if you want to move the station unit with the AC adaptor disconnected for your convenience, charge for about **8 hours** before initial use. Make sure the battery is installed properly and the AC adaptor is connected (p. 8, 9).

Battery strength

You can check the battery strength on the display.
The battery strength is shown as in the chart below.

Display prompt	Battery strength
	Fully charged
	Medium
	Low
 (flashing)	Needs to be recharged.

- If you do not install the battery with the AC adaptor connected, “” will flash and “Install battery” will be displayed. However the unit will work with the AC power.

Recharge

Connect the AC adaptor to recharge the battery when:

- “Recharge” is displayed,
- “” flashes on the display, or
- the station unit beeps intermittently while it is in use.

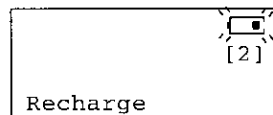

- If you DO NOT recharge the battery for more than 15 minutes, the display will keep indicating “Recharge” and/or “” will continue to flash.
- After the battery is fully charged, you can disconnect the AC adaptor and move the unit to your convenient place.
- If you charge the discharged battery, it will be charged quickly. In that case the area of the battery may feel warm. This is normal.

Battery information

After your Panasonic battery is fully charged (p 10)

Operation		Operating time
While in use (TALK)	with the handset	8 hours
	with the speakerphone	4 hours
While not in use (Standby)		4 days

- The battery operating time may be shortened depending on usage conditions and ambient temperature
- If the battery is fully charged and you use the unit in the battery power mode, you do not have to charge the battery until "Recharge" is displayed and/or "  " flashes This will maximize the battery life
- The battery cannot be overcharged

Registration

This station unit must be registered at the KX-TG4000B/KX-TG2000B base unit. The station unit will be assigned the extension number at registration. Only one unit can be registered at a time using the base unit. If the PIN has been stored, see page 13.

Make sure that the base unit and station unit are in the standby mode. Registration must be completed within 1 minute.

1 Base unit:

Press **FUNCTION**.

2 Press ∇ or \blacktriangle until the arrow points to "Registration", and press \blacktriangleright .

```
Pager setting
▶Registration
Initialization
```

3 Press ∇ or \blacktriangle until the arrow points to "HS registration".

```
Set PIN
▶HS registration
Deregistration
```

4 Press \blacktriangleright .

```
Handset
registering
```

5 Station unit:

Press **FUNCTION**.

6 Press ∇ or \blacktriangle until the arrow points to "Registration", and press \blacktriangleright .

```
Voice mail
Pager setting
▶Registration
```

7 While "HS registration" is at the arrow, press \blacktriangleright .

```
▶HS registration
Deregistration
v^ ▶=Set
```

```
Handset
registering
```

8 Base unit/station unit:

Wait until a beep sounds on the base unit and station unit and until both of the displays show the assigned extension number.

Ex. Extension number is 2.

- To return to the standby mode, press **EXIT**.
- The extension number will be displayed on the station unit.

```
Station unit

Handset2
registered
```

Base Unit

```
Handset2
registered
```

If the station unit displays "Enter PIN" in step 8, follow steps 3 to 5 on next page.

Registering the Station Unit Using the PIN

If the PIN (Personal Identification Number) has been stored with the base unit to prevent unauthorized persons from registering and using an extension unit (station unit/cordless handset) (see page 52 in the KX-TG4000B/KX-TG2000B Operating Instructions), you are required to enter it at registration.

Only one unit can be registered at a time by using the base unit.

Make sure that the base unit and station unit are in the standby mode. Registration must be completed within 1 minute.

1 Base unit:

Follow steps 1 to 4 on page 12.

```
Handset
registering
```

2 Station unit:

Repeat the steps 5 to 7 on page 12.

```
Handset
registering
```

3 Enter the PIN.

- If you enter the wrong PIN, press **CLEAR**, and enter the PIN again.

```
HS registration
Enter PIN: 0--
ENTER=Set
```

4 Press **ENTER**.

```
HS registration
Enter PIN:1230
ENTER=Set
```

5 Base unit/station unit:

Wait until a beep sounds on the base unit and station unit and until both of the displays show the assigned extension number.

Ex. Extension number is 2.

- To return to the standby mode, press **EXIT**.
- The extension number will be displayed on the station unit.

```
Station unit
Handset2
registered
```

Base Unit

```
Handset2
registered
```

- If registered to KX-TG2000B, the **LINE 3** and **LINE 4** buttons on the station unit will be inoperative.

Programmable Settings

Programming Guidelines

This station unit has programmable functions. Most of them are selected from the function menu on the display (p. 15).

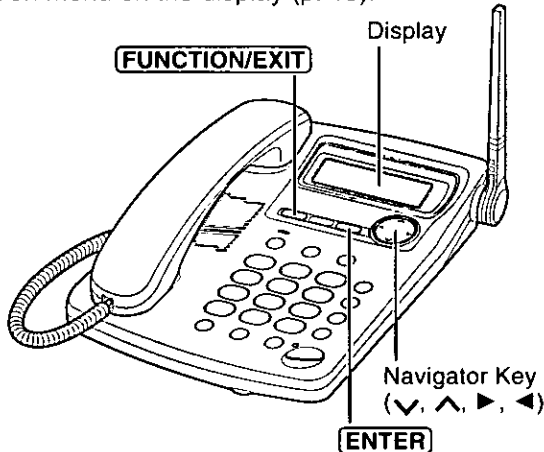

How to select a function item from the menu

1. Press **FUNCTION** while in the standby mode. The main menu is displayed (see next page).
2. You can scroll through the menu by pressing ▼ or ▲. Find the desired item and point the arrow to the item by pressing ▼ or ▲.
Ex. "Ringer setting" is at the arrow.

Save directory
▶ Ringer setting
Line selection
3. Press ► to select the item.
4. If the selected item has a sub-menu, it will be displayed. Select the sub-menu item by pressing ▼ or ▲, and press ►.
5. You can then select the desired setting.
 - **ENTER** is used to select or save a programming setting.
6. When programming is complete, a confirmation tone sounds. The display will return to the main menu or the sub-menu (if the function item is in the sub-menu). You can continue programming other items. To return to the standby mode, press **EXIT**.

Useful information:

- You can go back to the previous display by pressing ◀ except when entering characters or numbers. To return to the main menu from the sub-menu, press ◀.
- You can exit the programming mode any time by pressing **EXIT**.
- If you do not press any buttons for 60 seconds, the unit will return to the standby mode.
- If the unit detects a problem, an error message will be displayed (p. 64).



Function Menu Table

You can use the following functions to customize your unit according to your needs. After pressing **FUNCTION**, the main menu is displayed. Most items in the main menu have a sub-menu. The sub-menu is shown after selecting the item in the main menu.

See the corresponding pages for function details.

Main menu items are written in bold and sub-menu items are under each main menu item in the shaded box.

Save directory	Stores an item in the directory (p. 25).
Ringer setting	
Ringer volume	Selects the ringer volume (p. 16).
Ringer pattern	Selects the ringer pattern (p. 35).
Incoming call	Turns on/off the incoming call tone (p. 37).
Line selection	Selects the calling line selection (p. 36).
Voice mail	
Set password	Sets the mailbox password (p. 41).
Message menu	Turns on/off the message menu mode (p. 52).
Pager setting	
Pager number	Stores the pager number (p. 56).
Pager on/off	Turns on/off the pager mode (p. 58).
Pager display #	Stores the pager display no. (p. 57).
Calling pager	Sets the unit to call a pager (p. 57).
Registration	
HS registration	Registers the unit (p. 12, 13).
Deregistration	Cancels the registration (p. 39).
Initialization	
Function	Clears settings (p. 38).
Dial data	Erases all entries in the directory, Caller List and redial list (p. 38).

Selecting the Ringer Volume

You can set the ringer volume to HIGH, LOW or OFF

Your phone comes from the factory set to HIGH

Make sure that the station unit is in the standby mode

- 1 Press **FUNCTION**
- 2 Press **▼** or **▲** until the arrow points to "Ringer setting"

```
Save directory
▶Ringer setting
Line selection
```

- 3 Press **▶**

```
▶Ringer volume
Ringer pattern
Incoming call
```

- 4 While "Ringer volume" is at the arrow, press **▶**

HIGH

```
Ringer volume
Low ██████████ High
▼▲
```

- The current volume is displayed

- 5 Press **▲** to increase or press **▼** to decrease the volume

▲ ↑ ↓ ▼

```
Ringer volume
Low ██ High
▼▲
```

- Each time you press **▼** or **▲**, the volume will change and ring
- It is normal that 7 bars change to 2 bars when the ringer volume is set from HIGH to LOW
- **To turn the ringer OFF**, press and hold **▼** until a beep sounds "Ringer off" will be displayed and the station unit will not ring for all the lines

LOW

▲ ↑ ↓ ▼

```
Ringer off
▼▲
```

–To turn off the ringer for one of the lines, you can do so by setting Ring group feature at Ringer setting on the base unit (See page 23 in the KX-TG4000B/KX-TG2000B Operating Instructions) When "Ringer off" is set for an individual line by the ring group feature on the base unit, "Ringer off" will not be displayed on the station unit. The line status icon (p 7) will flash on the station unit when a call is coming

- To return to the standby mode, press **EXIT**

To turn the ringer ON, press **▲** in step 5

- The ringer will sound at the LOW level

- You can also select the ringer volume while a call is being received. Press **▼** or **▲** while the unit is ringing
- To change the ringer pattern, see page 35

Making Calls



For users registered to KX-TG4000B: Four calls can be handled simultaneously on separate telephone lines by 4 units.

For users registered to KX-TG2000B: Two calls can be handled simultaneously on separate telephone lines by 2 units.

Using the handset

When you lift the handset off the cradle to make a call, the station unit will automatically select a free line. (To change the line selection, see page 36.) Dial a phone number. To hang up, replace the handset on the cradle.

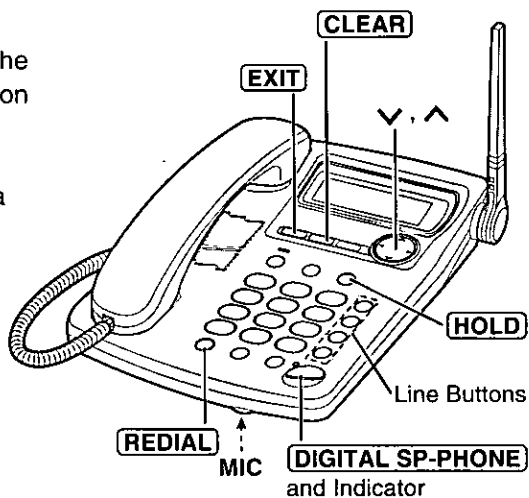

Using the digital duplex speakerphone

- 1 Press **DIGITAL SP-PHONE**.
 - The indicator lights.
 - A free line is automatically selected and the line status icon is displayed.
- 2 Dial a phone number.
 - The dialed number is displayed.
 - If you misdial, press **DIGITAL SP-PHONE**, and start again from step 1.
 - After a few seconds, the display will show the length of the call.
- 3 When the other party answers, talk into the **MIC** (microphone).
- 4 To hang up, press **DIGITAL SP-PHONE**.
 - The indicator light goes out and the line status icon disappears.

Ex. Line 1 is selected.

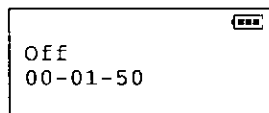
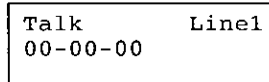
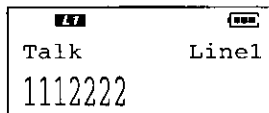
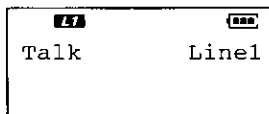

- In step 1, you can select a line by pressing a line button whose line status icon is not displayed, instead of pressing **DIGITAL SP-PHONE**. If registered to KX-TG2000B, do not press **LINE 3** or **LINE 4**.

➔ Making Calls

- If the unit detects a problem, an error message will be displayed (p. 64).
- For users registered to KX-TG4000B:
 - If 4 other units are in use, you may not be able to make a call. When you try to make a call, "System is busy. Please try again later." will be displayed.
- For users registered to KX-TG2000B:
 - If more than one unit is in use, you may not be able to make a call. When you try to make a call, "System is busy. Please try again later." will be displayed.
 - If **(LINE 3)** or **(LINE 4)** is pressed, "Line not available" will be displayed.

To dial after confirming the entered number

1 Enter a phone number.

- If you misdial, press **(CLEAR)**. Digits are erased from the right.
- To cancel, press **(EXIT)**.

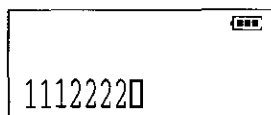

2 Lift the handset off the cradle or press

(DIGITAL SP-PHONE).

- You can press a line button instead of pressing **(DIGITAL SP-PHONE)**.
- After a few seconds, the display will show the length of the call.

Ex. Line 1 is selected.

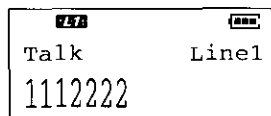

3 When the other party answers, talk into the handset or **MIC**.

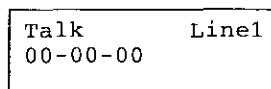

4 To hang up, replace the handset on the cradle or press **(DIGITAL SP-PHONE)**.

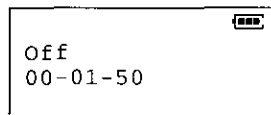

Hands-free Digital Duplex Speakerphone

For best performance, please note the following:

- Talk alternately with the caller in a quiet room.
- If the other party has difficulty hearing you, press **▼** to decrease the speaker volume.
- If the other party's voice from the speaker cuts in/out during a conversation, press **▼** to decrease the speaker volume.
- You can switch to the handset by lifting it up off the cradle. To switch back to the speakerphone, press **(DIGITAL SP-PHONE)**.

To adjust the handset volume (High, Medium or Low) or the speaker volume (8 levels)

Press **▲** or **▼** while talking.

- Each time you press **▲** or **▼**, the volume level will change.

Ex. Handset volume: High

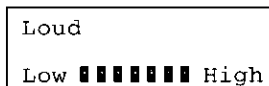

Ex. Speakerphone volume: 8

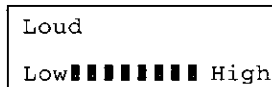

To redial the last number dialed

Lift the handset off the cradle or press **[DIGITAL SP-PHONE]**, and press **[REDIAL]**.

To redial using the redial list

The last 10 phone numbers dialed with the station unit are stored in the redial list.

1. Press **[REDIAL]**. (The last number dialed is displayed.)
2. Press **[REDIAL]** until the desired number is displayed.
 - You can scroll between numbers by pressing **▼** or **▲**.
 - To exit the list, press **[EXIT]**.
3. Lift the handset off the cradle or press **[DIGITAL SP-PHONE]**.
 - **To erase an item**, repeat steps 1 and 2, and press **[CLEAR]**.
 - If "No items stored" is displayed, the list is empty.

To put a call on hold

Press **[HOLD]**.

- The line status icon flashes.
- If using the handset, you can replace it on the cradle.
- If a call is kept holding for 3 minutes, a warning tone will sound. After 2 additional minutes on hold the automated attendant will respond to the caller and he/she can call the operator (base unit) or another extension (cordless handset/station unit), or leave a message following the Incomplete Call Handling Menu (p. 46).

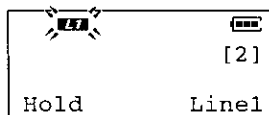

To release the hold

Press the line button whose status icon is flashing.

- The hold can be released from the base unit, a cordless handset or another station unit by pressing the line button. If another phone is connected on the same line, the hold will also be released by lifting its handset.

Answering Calls

When a call is being received, the station unit rings and "Incoming call" is displayed. The called line status icon flashes quickly on the display. The line is automatically selected when you answer the call.

If you subscribe to a Caller ID service, the calling party information will be displayed after the first ring (p. 29). In order to view the Caller ID information, please wait until the second ring to answer a call.

For users registered to KX-TG4000B: Four calls can be handled simultaneously by 4 units.

For users registered to KX-TG2000B: Two calls can be handled simultaneously by 2 units.

Using the handset

You can answer a call by simply lifting the handset off the cradle. To hang up, replace the handset on the cradle.

Using the digital duplex speakerphone

- 1 Press **DIGITAL SP-PHONE**.
 - The indicator lights.
 - The called line status icon stops flashing.
- 2 Talk into the **MIC** (microphone).
- 3 To hang up, press **DIGITAL SP-PHONE**.
 - The indicator light goes out.

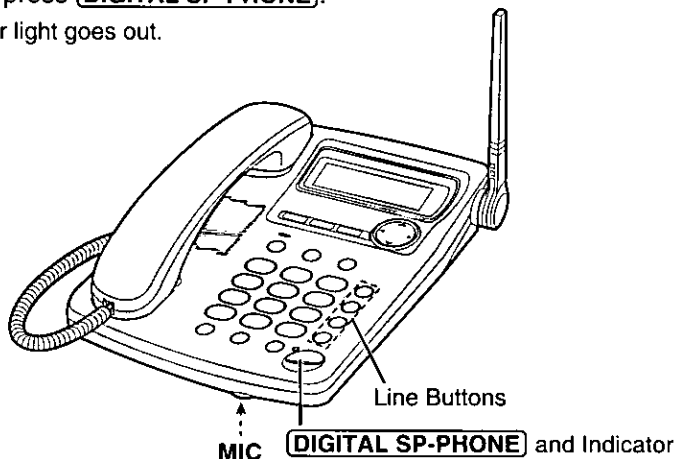

- You can answer a call by pressing the called line button instead of pressing **DIGITAL SP-PHONE**.
- To transfer the call that you took, to another person, see page 23. To transfer the call to another person's mailbox to allow the caller to leave a message there, see page 52.
- When the ringer volumes is set to OFF, the station unit will not ring (p. 16).

Using Other Lines During a Conversation

During a conversation, if an incoming call is being received on another line, you will hear **two tones** and the line status icon on the display will flash quickly. You can answer the second call while holding the first call. You can also make a call without terminating the first call.

If you subscribe to a Caller ID service, the second caller's information will be displayed when a call is being received on another line (p. 29).

You can delete the **two tones** (incoming call tone). See page 37.

1 Ex. If you are using LINE 1

Press **HOLD** to put the first call (LINE 1) on hold.

- The line status icon flashes on the display.

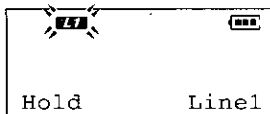

- ## 2
- For users registered to KX-TG4000B:
Press another line button (LINE 2, 3 or 4) to make or answer a second call.

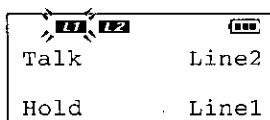

For users registered to KX-TG2000B:
Press the other line button (LINE 2) to make or answer a second call. (Do not press **LINE 3** or **LINE 4**.)

- ## 3
- To return to the first call (LINE 1), press the line button for the first call (LINE 1).

- The second call is terminated.

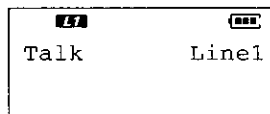

- To hold the second call in step 3, press **HOLD** before pressing the line button for the first call.
- For users registered to KX-TG4000B:
Pressing **HOLD** puts the current call on hold while keeping the previously held calls. You can make or answer another call by pressing a line button whose line is not in use. You can handle up to 4 calls at a time.

Intercom

You can talk to the operator (base unit user) or another extension user (cordless handset user or another station unit user) using the intercom line. The extension number is assigned at registration to the station unit (p. 12, 13). The base unit has the number "0".

Making Intercom Calls

1 Press **INTERCOM**.

Press extension
No. to call

2 To page the operator (base unit), enter **0**.
To page another extension (cordless handset/another station unit), enter the number (**1** to **8**).

Ex. Ext.2 paging Base Unit

Calling [2] → [0]

- The paged unit rings.
- To stop paging, press **INTERCOM**.
- After the paged party answers, the display will show the length of the call.

Intercom
00-00-00

3 When the other party's voice is heard, lift the handset off the cradle or talk into the **MIC** (microphone).

4 To end the intercom, replace the handset on the cradle or press **DIGITAL SP-PHONE**.

Off
00-07-15

Answering Intercom Calls

After the rings, lift the handset off the cradle or press **DIGITAL SP-PHONE**.

Ex. Base Unit paging
Extension 2

To end the intercom, replace the handset on the cradle or press **DIGITAL SP-PHONE**.

Call [2] ← [0]

During an intercom call:

- If an incoming call is being received, you will hear two tones (incoming call tone, p. 37). To answer, press the relevant line button.
- If the unit detects a problem, an error message will be displayed (p. 64).

- When the ringer volumes is set to OFF, the station unit will not ring (p. 16).

Transferring a Call

You can transfer an external call to the operator (base unit) or another extension (cordless handset/another station unit).

1 During a call, press **TRANSFER**.

- The call is put on hold.

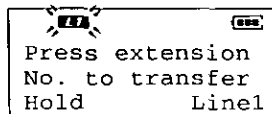

2 To page the operator (base unit), enter **0**.

To page another extension (cordless handset/another station unit), enter the number (**1** to **8**).

3 If required, wait for the paged party to answer, and you can announce the transfer. If not required, go to step 4.

- If the paged party does not answer, press the relevant line button.

4 To complete the transfer, press **DIGITAL SP-PHONE** or replace the handset on the cradle.

To answer a transferred call:

Lift the handset off the cradle or press **DIGITAL SP-PHONE** after the rings.

- After the paging party hangs up, you can talk to the outside caller.
- You can press the relevant line button instead of pressing **DIGITAL SP-PHONE** to talk to the outside caller.
- If the paged party does not answer within 30 seconds after you hang up, the transferred call will be returned to you with a sounding tone from the unit. If you still do not answer the caller's call within 2 minutes, the automated attendant will respond to the caller (p. 42). You may answer the caller by pressing the relevant line button before the sounding tone or before the start of the automated attendant. You may also transfer the caller into the caller's intended extension mailbox by performing the three procedures:
 - 1) telling the caller the intended extension number with the # sign,
 - 2) your pressing the **VOICE MAIL** button, and
 - 3) your hanging up the line, so the intended extension mailbox will be presented to the caller (p. 52). If the incoming call is answered by the operator or a cordless handset, the call can also be transferred to other mailbox by the same procedures.
- The operator (base unit) or another extension user (cordless handset/another station unit user) can take a transferred call by pressing the relevant line button on their unit.

Conference

This feature allows you to join two other calls to make a conference call. At least one of the other two parties should be on an external line.

Conference with two external calls

- 1 Press **(HOLD)** to put the first call on hold.
- 2 For users registered to KX-TG4000B:
Press another line button (LINE 2, 3 or 4) to make or answer a second call.
For users registered to KX-TG2000B:
Press the other line button (LINE 2) to make or answer a second call. (Do not press **(LINE 3)** or **(LINE 4)**.)
- 3 When the second call is connected, press **(CONF)** to make a conference call.

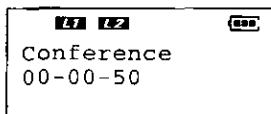

(Ex. Conference with LINE1 & 2)

- To hang up both lines, replace the handset on the cradle or press **(DIGITAL SP-PHONE)**.
- To hang up only one line, press the line button for the party with which you want to continue talking.
- To put both lines on hold, press **(HOLD)**.
To talk with only one caller, press the corresponding line button.
To resume both lines, press **(CONF)**.
- A maximum of 3 parties can take part in a conference call.

Conference with an external call and intercom call

- 1 Press **(TRANSFER)** to put the call on hold.
- 2 To page the operator (base unit), enter **(0)**.
To page another extension (cordless handset/another station unit), enter the number **(1 to 8)**.
- 3 When the paged party answers, press **(CONF)** to make a conference call.

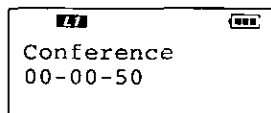

- To hang up only the intercom call, press the line button.
- To leave the conference, replace the handset on the cradle or press **(DIGITAL SP-PHONE)**. The two other parties can continue the conversation.

Using the Directory



You can store names and phone numbers in the directory. The station unit can store up to 50 items. All directory items are sorted by the first word in alphabetical order. Using the directory, you can make a call by selecting a name on the display.

Storing Names and Numbers in the Directory

Make sure that the station unit is in the standby mode.

1 Press **FUNCTION**.

```
▶Save directory
  Ringer setting
  Line selection
```

2 While "Save directory" is at the arrow, press ▶.

```
Directory=
  0 item
```

- The display shows the number of items, and "Enter name".

```
Enter name:
□
◀ ENTER=Next
```

3 Enter a name, up to 16 characters, using the dialing buttons (p. 26).

```
Enter name:
Tom Jones□
◀ ENTER=Next
```

- To move the cursor, press ◀ or ▶.
- If a name is not required, go to step 4.

4 Press **ENTER**.

```
Enter phone No.:
```

5 Enter a phone number, up to 22 digits.

- If you misdial, press **CLEAR**. Digits are erased from the right. To erase all digits, press and hold **CLEAR**.

```
0987654321□
ENTER=Save
```

6 Press **ENTER**.

- A beep sounds.
- To store other items, repeat from step 2.
- To return to the standby mode, press **EXIT**.

```
Tom Jones
0987654321
```

- If a pause is required for dialing, **PAUSE** can be stored in a phone number in step 5. This counts as one digit (p. 34).
- If the display shows "Memory is full" in step 2, press **EXIT** and erase other stored items from the directory (p. 28).

➔ Using the Directory

Selecting characters to enter names

The dialing buttons (0 to 9) can be used to enter letters and symbols. The letters are printed on the dialing buttons. Pressing each button selects a character as shown below.

Keys	Number of times key is pressed										
	1	2	3	4	5	6	7	8	9	10	11
1	#	&	'	()	*	,	-	.	/	1	
2	A	B	C	a	b	c	2				
3	D	E	F	d	e	f	3				
4	G	H	I	g	h	i	4				
5	J	K	L	j	k	l	5				
6	M	N	O	m	n	o	6				
7	P	Q	R	S	p	q	r	s	7		
8	T	U	V	t	u	v	8				
9	W	X	Y	Z	w	x	y	z	9		
0	0	Blank									
◀	Moves the cursor to the left.										
▶	Moves the cursor to the right. (To enter another character using the same number key, move the cursor to the next space.)										
CLEAR	Erases characters.										

If you make a mistake while entering a name:

Press ◀ or ▶ to move the cursor to the incorrect character, press CLEAR to delete, and enter the correct character. Each time you press CLEAR a character is erased from the right. To erase all characters, press and hold CLEAR.

For example, to enter "Tom Jones":

1. Press 8.
2. Press 6 six times, then press ▶.
3. Press 6 four times, then press ▶ twice.
4. Press 5, press 6 six times, then press ▶.
5. Press 6 five times, press 3 five times, then press 7 eight times.

◻
To◻
Tom ◻
Tom Jo◻
Tom Jones◻



Dialing from the Directory

1 Press ◀ or ▶ to enter the directory.

2 Press ∨ or ∧ to find the desired item.

- All directory items are sorted in the order shown on the right.

3 Lift the handset off the cradle or press **DIGITAL SP-PHONE**.

- The number is dialed automatically.
- You can press a line button instead of pressing **DIGITAL SP-PHONE**. If registered to KX-TG2000B, do not press **LINE 3** or **LINE 4**.

Directory list
∨∧
▶=Caller's list

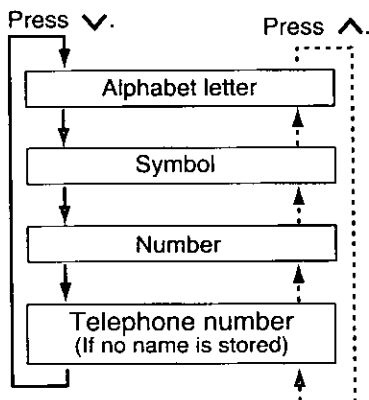

To search for a name by initial

1 Press ◀ or ▶ to enter the directory.

2 Press the dialing button for the first letter of the desired name until any name with the same initial is displayed (see table on page 26).

Ex. To find "Frank", press **3** until the first item under "F" is displayed.

3 Press ∨ until the name is displayed.

4 Lift the handset off the cradle or press **DIGITAL SP-PHONE**.

- The number is dialed automatically.
- You can press a line button instead of pressing **DIGITAL SP-PHONE**. If registered to KX-TG2000B, do not press **LINE 3** or **LINE 4**.

Directory list
∨∧
▶=Caller's list

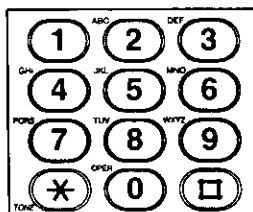

- You can leave the directory any time by pressing **EXIT**.
- If "No items stored" is displayed in step 1, the directory is empty.
- In step 1, you can go to the Caller List by pressing ▶ (p. 30).

➔ Using the Directory

Editing an Item in the Directory

Make sure that the station unit is in the standby mode.

- 1 Press ◀ or ▶ to enter the directory.
- 2 Press ▼ or ▲ to find the directory item you want to edit.
 - To search for the item by initial, see page 27.

3 Press **EDIT**.

- If you do not need to change the name, go to step 5.

```
Enter name:
Jane
◀ ENTER=Next
```

4 Edit the name using the dialing buttons, up to 16 characters (p. 26).

- To move the cursor, press ◀ or ▶.

```
Enter name:
Jane Walke
◀ ENTER=Next
```

5 Press **ENTER**.

- If you do not need to change the number, go to step 7.

```
234567
ENTER=Save
```

6 Add a number to the current number.

- Pressing **CLEAR** erases the digit to the left of the cursor. To erase all digits, press and hold **CLEAR**.

```
098234567
ENTER=Save
```

7 Press **ENTER**.

- A beep sounds.
- To edit other items, start again from step 2.
- To return to the standby mode, press **EXIT**.

Erasing an Item in the Directory

Make sure that the station unit is in the standby mode.

- 1 Press ◀ or ▶ to enter the directory.
- 2 Press ▼ or ▲ to find the directory item you want to erase.
 - To search for the item by initial, see page 27.

3 Press **CLEAR**.

- To stop erasing, press ◀.

```
Clear?
◀=No ENTER=Yes
```

4 Press **ENTER**.

- A beep sounds and "Clear" is displayed.
 - To erase other items, start again from step 2.
 - To return to the standby mode, press **EXIT**.
- To erase all items in the directory, see page 38.

Caller ID Service

This unit is compatible with a Caller ID service offered by your telephone company. After subscribing to a Caller ID service, the calling party's information will be shown on the display after the first ring.

The station unit can record information of up to 30 different callers, including the time and date the call was received and the number of times called, in the caller list.

The Caller List information is sorted from the most recent to the oldest call. When the unit receives the 31st call, the oldest call is deleted.

Using this list, you can automatically call back a caller. You can store the callers' names and numbers from the Caller List in the directory.

If you subscribe to both Caller ID and Call Waiting services, when a second call is received on the same line, the new caller's name and phone number will be displayed (p. 34).

How caller information is displayed when a call is received

The display shows the caller's name, number and the called line after the first ring.

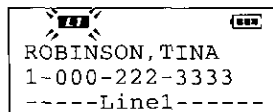

- After you answer the call, the display will show the length of the call.

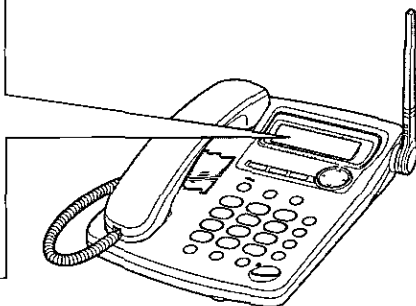

- When more than one line is receiving a call, each caller's information will be displayed alternately.
- Caller information cannot be displayed in the following cases:
 - If the caller dialed from an area which does not provide a Caller ID service, the display will show "Out of area".
 - If the caller has requested not to display his/her information, the display will show "Private caller".
- If the base unit is connected to a PBX which does not support Caller ID services, you cannot access those services.
- The name display service may not be available in some areas. For more information, please contact your telephone company.
- If the station unit has lost communication with the base unit when a call is received, the caller information will not be recorded in its Caller List.

Using the Caller List

If you have received new calls, "Received calls" will be displayed in the standby mode.

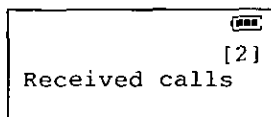

Viewing the Caller List

To check who has called, follow the steps below.

Make sure that the station unit is in the standby mode.

- 1** Press \checkmark or \wedge to enter the list.
- The number of new calls is displayed.

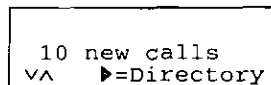

- 2** To search from the most recent call, press \checkmark .
To search from the oldest call, press \wedge .

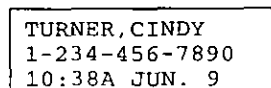

- The display shows:
 - the caller's name,
 - the caller's number, and
 - the time and date of the call (ex. 10:38 AM, Jun. 9).
- To scroll between callers, press \checkmark or \wedge .

- 3** To exit the list, press **EXIT**.

- If "No items stored" is displayed in step 1, the Caller List is empty.
- If there is no name information for a caller, the display will only show the phone number.
- After viewing all of the new call entries, "Received calls" will disappear.
- Once new calls have been checked " \checkmark " will be added.
- In step 1, you can go to the directory by pressing \blacktriangleright (p. 27).

What " \checkmark " means

When the display shows " \checkmark ", you have already viewed this calling information, answered the call or called back the caller. If the same caller calls again, the call entry with " \checkmark " will be replaced with the new call entry.

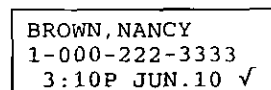

If a caller calls more than once

The number of times the same caller called is displayed (X2 to X9). The date and time of the most recent call will be recorded. After checking, X2 to X9 will be replaced with " \checkmark ".

Ex. The caller called 5 times.

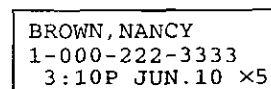



Calling Back from the Caller List

- 1 Press \checkmark or \wedge to enter the list.
- 2 Press \checkmark or \wedge to find the desired caller.

30 new calls \checkmark/\wedge \blacktriangleright Directory

SMITH, JACK 1-234-567-8901 3:10P JUN. 9

- 3 Lift the handset off the cradle or press **DIGITAL SP-PHONE**.

12 MEM
Talk Line2 12345678901

- The displayed phone number is dialed automatically.
- You can press a line button instead of pressing **DIGITAL SP-PHONE**. If registered to KX-TG2000B, do not press **LINE 3** or **LINE 4**.
- In some cases, you may have to edit the number before dialing (see below). (Ex. You may have to delete "1" and the area code.)
- If a phone number is not displayed in the caller information, you cannot call back that caller.

Editing the Caller's Phone Number

You can edit a phone number into one of 4 patterns.

Make sure that the station unit is in the standby mode.

- 1 Press \checkmark or \wedge to enter the list.
 - The number of new calls is displayed.
- 2 Press \checkmark or \wedge to find the desired caller.
- 3 Press **EDIT** to select a pattern. Each time you press **EDIT**, the number is rearranged into one of 4 different patterns.

- (a) Phone no.
- (b) Area code - Phone no.
- (c) 1 - Phone no.
- (d) 1 - Area code - Phone no.

- The order in which patterns (a) - (d) are displayed depends on how the telephone number is displayed in step 2.
- 4 After editing the number, you can continue with calling back or storing procedures. To call back, lift the handset off the cradle or press **DIGITAL SP-PHONE**. To store the number in the directory, press **ENTER** (see page 32, from step 3).

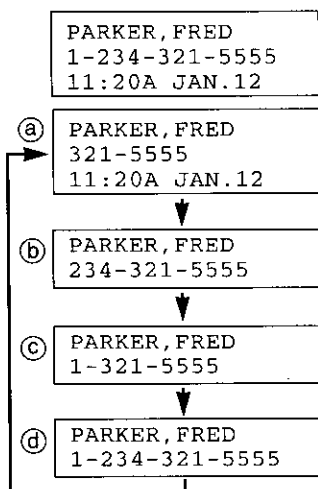

- The number edited in step 4 will not be maintained in the Caller List.

For assistance, please call: 1-800-211-PANA(7262)

➔ Using the Caller List

Storing Caller List Information in the Directory

You can store names and phone numbers that are in the Caller List into the directory.

Make sure that the station unit is in the standby mode.

1 Press **▼** or **▲** to enter the list.

```
30 new calls
v^ ▶=Directory
```

2 Press **▼** or **▲** to find the desired caller.

- If the number requires editing, see page 31.

```
TURNER, CINDY
1-234-456-7890
11:20A JUN.12
```

3 Press **ENTER**.

```
Save directory?
ENTER=Yes
```

4 Press **ENTER** again.

```
TURNER, CINDY
12344567890
```

If there is no name information for the caller, "Enter name" will be displayed.

```
Enter name:
□
◀ ENTER=Save
```

a) If a name is not required, press **ENTER**.

b) If a name is required, enter the name (p. 26), and press **ENTER**.

```
Enter name:
CINDY TURNER
◀ ENTER=Save
```

- A beep sounds.
- To store other items, repeat from step 2.
- To return to the standby mode, press **EXIT**.

```
CINDY TURNER
12344567890
```

- If the display shows "Memory is full" in step 3, press **EXIT**. To erase stored items from the directory, see page 28.
- You cannot store caller information in the directory if a phone number is not displayed.

Erasing Caller List Information

After checking the Caller List, you can erase some or all of the entries of the station unit

Make sure that the station unit is in the standby mode

To erase a specific caller from the Caller List

1 Press \downarrow or \uparrow to enter the list

```
30 new calls
v^  ▶=Directory
```

2 Press \downarrow or \uparrow to find the caller you want to erase from the caller list

```
REAGAN, TOM
1-666-444-5555
11 20P JUN 12 ✓
```

3 Press **CLEAR**

- A beep sounds and the information is erased
- To erase other items, repeat from step 2
- To return to the standby mode, press **EXIT**

```
Clear
```

To erase all entries in the Caller List

Before erasing all entries, make sure that "0 new call" is displayed

1 Press \downarrow or \uparrow to enter the list

```
0 new call
v^  ▶=Directory
```

2 Press **CLEAR**

- To stop erasing, press \leftarrow

```
All clear?
◀=No  CLEAR=Yes
```

3 Press **CLEAR**

- A beep sounds and all entries are erased

```
All clear
```

Special Features

How to Use the PAUSE Button (For Analog PBX Line/Long Distance Service Users)

We recommend you press **PAUSE** if a pause is required for dialing with a PBX or to access a long distance service.

Ex. Line access number **9** (PBX)

9 ⇒ **PAUSE** ⇒ Phone number

- Pressing **PAUSE** once creates a 3.5 second pause.
This prevents misdialing when you redial or dial a stored number.
- Pressing **PAUSE** more than once increases the length of the pause between numbers.

For Call Waiting Service Users

If another call is received on the same line while talking, you will hear a call-waiting tone. Press **CALL WAIT** to answer the second call.

- The first call is put on hold.
- To return to the first caller, press **CALL WAIT** again.
- The call waiting service cannot be used when:
 - the first call on the same line is placed on hold,
 - you are having a conference call (p. 24), or
 - the Automated Attendant System or Answering System is responding to the first call on the same line (p. 40, 42).
- If this function does not operate properly, consult your telephone company for details.

Call Waiting Caller ID Feature

Call Waiting Caller ID feature allows the unit to display a second caller's information.

After you hear a call-waiting tone while talking, the display will show the caller's name with the phone number and "----Waiting----".

BROWN, NANCY 1-000-222-3333 ----Waiting----

- Please contact your telephone company for details and availability in your area.

FLASH Button

Pressing **FLASH** allows you to use special features of your host PBX such as transferring an extension call or accessing special telephone services (optional) such as call waiting.

- The flash time is set by the base unit.

Temporary Tone Dialing (For Rotary or Pulse Service Users)

Press **[TONE]** before entering access numbers which require tone dialing.

- The dialing mode changes to tone. You can enter numbers to access an answering service, electronic banking service, etc. When you hang up, the mode will return to pulse.
- Access numbers entered after pressing **[TONE]** will not be included when redialing.

Other Programmable Settings

Selecting the Ringer Pattern

You can select the desired ringer patterns. 4 patterns are available for each line. Your phone comes from the factory set to pattern 1.

Make sure that the station unit is in the standby mode.

- 1 Press **[FUNCTION]**.
- 2 Press **∨** or **∧** until the arrow points to "Ringer setting", and press **▶**.
- 3 Press **∨** or **∧** until the arrow points to "Ringer pattern", and press **▶**.
 - The current settings are displayed.
If registered to KX-TG2000B, "L3" and "L4" are inoperative.
- 4 Enter the desired pattern using the dialing buttons (**[1]** to **[4]**) for each line. To move to another line, press **▶** or **◀**.
 - If registered to KX-TG2000B, do not select "L3" and "L4".
 - Each time you select a pattern, it rings.
- 5 Press **[ENTER]**.
 - A beep sounds.
 - To return to the standby mode, press **[EXIT]**.

Save directory
▶ Ringer setting
Line selection

Ringer volume
▶ Ringer pattern
Incoming call

Ringer pattern
L1 L2 L3 L4
1 1 1 1

For users registered to KX-TG2000B:
LINE 3 and LINE 4 ringer pattern settings are inoperative.

➔ Other Programmable Settings

Calling Line Selection

The station unit will automatically select a free line when you make a call. You can change the calling line selection.

Make sure that the station unit is in the standby mode.

1 Press **[FUNCTION]**.

2 Press **∨** or **∧** until the arrow points to "Line selection", and press **▶**.

```
Save directory
Ringer setting
▶Line selection
```

- The current setting is displayed.

Auto:

A free line will be selected (LINE 1 has priority) when making a call (factory preset).

```
Line selection
:Auto
∨∧ ENTER=Save
```

Line1: Line 1 will be selected when making a call.

Line2: Line 2 will be selected when making a call.

Line3: Line 3 will be selected when making a call (for users registered to KX-TG4000B only).

Line4: Line 4 will be selected when making a call (for users registered to KX-TG4000B only).

3 For users registered to KX-TG4000B:

Select "Line1", "Line2", "Line3", "Line4" or "Auto" by pressing **∨** or **∧**.

```
Line selection
:Line1
∨∧ ENTER=Save
```

For users registered to KX-TG2000B:

Select "Line1", "Line2" or "Auto" by pressing **∨** or **∧**. (Do not select "Line3" or "Line4".)

4 Press **[ENTER]**.

- A beep sounds.

- To return to the standby mode, press **[EXIT]**.

- Any line can be selected manually, regardless of the programmed line selection, by pressing that line button. If registered to KX-TG2000B, the **[LINE 3]** and **[LINE 4]** buttons are inoperative.

For users registered to KX-TG2000B:

Do not select "Line3" or "Line4" for the calling line selection. Otherwise "Line not available" will be displayed when you lift the handset off the cradle or press **[DIGITAL SP-PHONE]** to make or answer a call.



Incoming Call Tone

While using one line, you can be informed if another call arrives on another line by two tones. During an intercom call or while listening to messages (p. 48), you can also be informed by two tones if a call arrives.

If you set to ON, this incoming call tone will be heard for as long as another line rings. To delete this incoming call tone, set to OFF. To set the incoming call tone to sound twice, set to "2".

Your phone comes from the factory set to "2".

Make sure that the station unit is in the standby mode.

- 1 Press **FUNCTION**.
- 2 Press \downarrow or \uparrow until the arrow points to "Ringer setting", and press \blacktriangleright .
- 3 Press \downarrow or \uparrow until the arrow points to "Incoming call", and press \blacktriangleright .
 - The current setting is displayed.
- 4 Select the desired setting, "On", "Off" or "2" by pressing \downarrow or \uparrow .
- 5 Press **ENTER**.
 - A beep sounds.
 - To return to the standby mode, press **EXIT**.

```

Save directory
▶Ringer setting
Line selection
  
```

```

Ringer volume
Ringer pattern
▶Incoming call
  
```

```

Incoming call
tone:2
v^ ENTER=Save
  
```

```

Incoming call
tone:On
v^ ENTER=Save
  
```

➡ Other Programmable Settings

Erasing the Directory, Caller List and Redial List

You can erase all entries in the directory, caller list and redial list.

Make sure that the station unit is in the standby mode.

- 1 Press **FUNCTION**.
- 2 Press ∇ or \blacktriangle until the arrow points to "Initialization", and press \blacktriangleright .
- 3 Press ∇ or \blacktriangle until the arrow points to "Dial data", and press \blacktriangleright .
 - The current settings are displayed.
RDL=Redial List
CID=Caller List
DIR=Directory
- 4 Select "Yes" to erase the list by pressing ∇ or \blacktriangle . Select "No" to leave the list.
To move to another list, press \blacktriangleright or \blacktriangleleft .
- 5 Press **ENTER**.
 - A beep sounds.
 - To return to the standby mode, press **EXIT**.

```
▶Initialization
v^          ▶=Set
```

```
Function
▶Dial data
v^          ▶=Set
```

```
Delete dial data
RDL CID DIR
No No No
```

```
Delete dial data
RDL CID DIR
No Yes No
```

Clearing Settings

The settings of your station unit shown on the right will return to the factory preset.

Make sure that the station unit is in the standby mode.

- 1 Press **FUNCTION**.
- 2 Press ∇ or \blacktriangle until the arrow points to "Initialization", and press \blacktriangleright .
- 3 While "Function" is at the arrow, press \blacktriangleright .
- 4 Press **CLEAR**.
 - A beep sounds and "Clear" is displayed.
 - To return to the standby mode, press **EXIT**.

Function	Factory preset	Reference page
Ringer volume	HIGH	16
Ringer pattern	Pattern 1	35
Incoming call tone	2 times	37
Line selection	AUTO	36

```
▶Initialization
v^          ▶=Set
```

```
▶Function
Dial data
v^          ▶=Set
```

```
Initialize
function?
CLEAR=Delete
```

Canceling Registration

If you no longer need to use the station unit or if you need to register the unit to a different KX-TG4000B/KX-TG2000B base unit, it may be necessary to cancel the registration with the base unit

Only one unit can be canceled at a time by using the base unit to which the station unit is currently registered

Make sure that the base unit and station unit are in the standby mode

Base unit

- 1 Press **FUNCTION**
- 2 Press ∇ or \blacktriangle until the arrow points to "Registration", and press \blacktriangleright
- 3 Press ∇ or \blacktriangle until the arrow points to "Deregistration", and press \blacktriangleright
 - The registered unit numbers are displayed

```
Deregistering
HS No.  02345678
◀▶      ENTER=Set
```

- 4 Press \blacktriangleright or \blacktriangleleft to move the cursor to the extension number to be canceled
- 5 Press **ENTER**

```
Deregister?
Handset2
◀=No    CLEAR=Yes
```

- To stop, press \blacktriangleleft
- 6 Press **CLEAR**
 - A beep sounds and "Clear" is displayed
 - To return to the standby mode, press **EXIT**

Station unit

- 1 Press **FUNCTION**
- 2 Press ∇ or \blacktriangle until the arrow points to "Registration", and press \blacktriangleright
- 3 Press ∇ or \blacktriangle until the arrow points to "Deregistration", and press \blacktriangleright

```
Deregister?
Handset2
◀=No    CLEAR=Yes
```

- To stop, press \blacktriangleleft
- 4 Press **CLEAR**
 - A beep sounds and "Clear" is displayed
 - To return to the standby mode, press **EXIT**
 - [-] will be displayed

The canceling procedure must be carried out with both the base unit and the station unit

- The station unit will not work. To use it again, registration will be required (p 12, 13)

Voice Mail System

The Voice Mail System allows you to receive and deliver voice messages using your personal mailbox. The system accommodates one general delivery mailbox and a maximum of 8 personal mailboxes which are assigned to the extensions (station units and cordless handsets). The mailbox numbers are the same as the extension numbers.

The Voice Mail System works fully with the Automated Attendant System, which routes incoming calls to a specified mailbox and allows a caller to leave a message (p. 42). If a caller does not specify a mailbox or calls from rotary telephones, the call is routed to the general delivery mailbox. With the Answering System (see below)*, all calls are routed to the general delivery mailbox. Either the Automated Attendant System or the Answering System can be set to any line by the base unit.

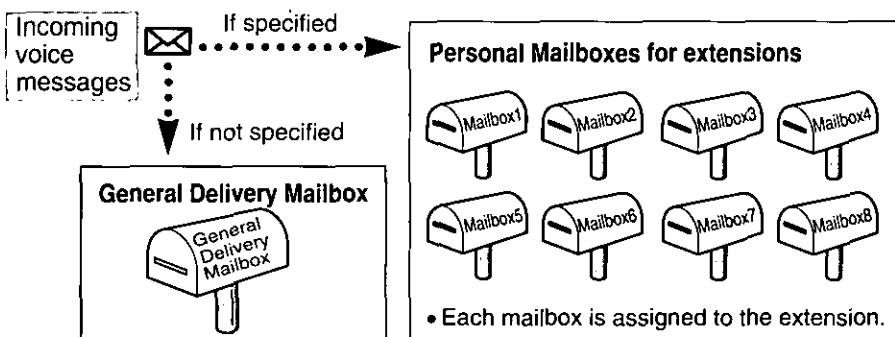

You can use the Voice Mail System by accessing your personal mailbox. Each extension user can only access his/her own personal mailbox. The general delivery mailbox is managed by the operator (base unit). All users can access this mailbox through each personal mailbox.

The following functions are possible:

- listening to messages left in your mailbox or the general delivery mailbox (p. 48, 50)
 - transferring a message left in your mailbox to other mailboxes (p. 50)
 - delivering your own voice memo message to other mailboxes (p. 51)
- You can also access the Voice Mail System features remotely from a touch tone phone (p. 53).

- All messages (greeting, incoming, etc.) are stored in digital memory of the base unit. The maximum recording time for each caller is 3 minutes.
- If "Automatic Message Delete Feature" is on by the base unit, incoming messages left in all mailboxes will automatically be erased after a month.

*The Answering System responds to incoming calls with a greeting message and callers can leave their messages in the general delivery mailbox. For details see page 65 in the KX-TG4000B/KX-TG2000B Operating Instructions.

Setting the Mailbox Password

Assign a **4-digit password (0000-9999)** to your personal mailbox to prevent unauthorized persons from accessing your mailbox and listening to the messages remotely from a touch tone phone. The preset password for each personal mailbox is a 4-digit number using the mailbox number (Ex "1111" for Mailbox 1, "2222" for Mailbox 2). Each password must be unique. You can also stop unauthorized accesses to your personal mailbox from the station unit using this password. If required, turn the **direct access mode OFF**. Once you turn it OFF, no one can use the **(VOICE MAIL)** button features on your unit and access your mailbox without entering the password. Your phone comes from the factory set to ON. **Make sure that the station unit is in the standby mode.**

- 1 Press **(FUNCTION)**
- 2 Press ∇ or \blacktriangle until the arrow points to "Voice mail", and press \blacktriangleright
- 3 While "Set password" is at the arrow, press \blacktriangleright
 - The password is displayed
- 4 Enter a password using a **4-digit number**
 - If you enter a wrong number, press **(CLEAR)**, and enter the password again
- 5 Press **(ENTER)**
 - The current setting of the direct access mode is displayed
- 6 To select the direct access mode
Select "Off" or "On" by pressing ∇ or \blacktriangle
- 7 Press **(ENTER)**
 - A beep sounds
 - To return to the standby mode, press **(EXIT)**

```
▶Voice mail
  Pager setting
  Registration
```

```
▶Set password
  Message menu
  v^          ▶=Set
```

```
Enter mailbox
password      1234
              ENTER=Save
```

```
Direct HS access
              On
  v^          ENTER=Save
```

```
Direct HS access
              Off
  v^          ENTER=Save
```

To check the password, repeat steps 1 through 3

- The password will be displayed. When finished, press **(EXIT)**

To erase the password

After erasing the password, the remote operation feature will not be used.

Press **(CLEAR)** in step 4, and press **(ENTER)**

- The direct access mode will be on and you can access the mailbox from your unit without the password

Automated Attendant System

How Automated Attendant System Works

The Automated Attendant System is a flexible communication tool that can enhance your productivity by improving your call management. The automated attendant answers incoming calls and then routes the callers to the operator (base unit) or the desired extension (station unit/cordless handset).

The extension numbers are assigned at registration (p. 12, 13). Callers can reach desired mailboxes using this system to leave messages.

The Automated Attendant System can be set to any line by the base unit.

Calling the automated attendant

When a caller calls a line to which the Automated Attendant System is assigned, the caller will first hear the line's greeting message which is set by the base unit.

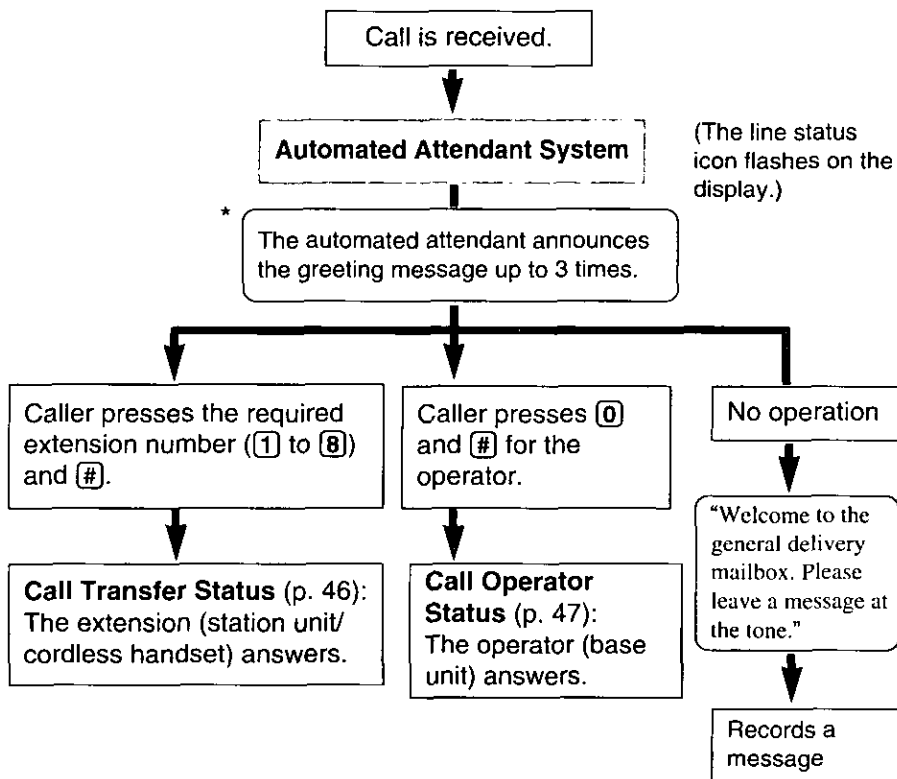

*If callers select neither extension nor operator, or call from rotary telephones, the greeting message will be repeated 3 times, and then they will be transferred to the general delivery mailbox where they can leave messages.



Setting the Answer Mode

If you are out of the office or unavailable to answer calls, turn ON the answer mode. Callers who call your extension will be greeted with a greeting message of your mailbox (see "Recording a Personal Greeting Message" on page 44) and callers can leave messages in your mailbox. Your phone comes from the factory set to OFF. To take calls, leave this mode OFF.

1 While the station unit is in the standby mode, press **VOICE MAIL**.

- If the direct access mode is OFF (p. 41), enter the mailbox password and press **#**.
- If you have new messages, listen to all of them.
- The display will show the command menu as shown on the right and the menu will be announced from the speaker (p. 48). You can switch to the handset by lifting it off the cradle.

1=Play all msg.
2=Deliver msg.
3=Personal greet



4=To general box
5=Answer on/off
*=End

2 Press **5**.

- The current setting is displayed.

Auto attendant	
Answer	:Off
1=On	2=Off

3 To select ON, press **1**.

- Your personal greeting, if recorded, can be heard by the caller at the end of 2nd ring after the caller selects your extension. If you do not record your greeting, the pre-recorded greeting will be heard (p. 44).

Auto attendant	
Answer	:On

OR

To select OFF, press **2**.

- The caller can only hear a pre-recorded message for Incomplete Call Handing Status (p. 46), at the end of 5th ring after caller selects your extension, and may leave a message at your personal mailbox by pressing 1.

4 Press **VOICE MAIL**.

- If the handset is off the cradle, you can replace it on the cradle to end the operation without pressing **VOICE MAIL**.
- You can adjust the speaker/handset volume by pressing **^** or **v**.

Recording a Personal Greeting Message

If the answer mode is ON (p. 43), callers will hear a pre-recorded personal greeting message after reaching your personal mailbox, as follows:

“Sorry, no one is available to answer the call. Please leave a message at the tone.”

You can also record your own greeting message of **up to 2 minutes**.

We recommend you record a **brief greeting message** (see sample below) in order to leave more time for recording new messages.

1 While the station unit is in the standby mode, press **VOICE MAIL**.

- If the direct access mode is OFF (p. 41), enter the mailbox password and press **#**.
- If you have new messages, listen to all of them.
- The display will show the command menu as shown on the right and the menu will be announced from the speaker (p. 48).

1=Play all msg.
2=Deliver msg.
3=Personal greet



4=To general box
5=Answer on/off
*=End

Greeting check

1=Change 2=OK

Greeting record
:00
1=End

Greeting check
:00
1=Change 2=OK

2 Press **3**.

- After the current message is played, “To change, press 1. To accept, press 2” is heard.

3 Press **1**.

- “Record greeting at the tone. To end recording, press 1” is heard.

4 After the tone, talk clearly, about 8 inches (20 cm) away from the **MIC** (microphone). To end, press **1**.

- If the elapsed recording time exceeds 2 minutes, the unit will stop recording.
- The message will be played.

5 Press **2**.

6 Press **VOICE MAIL**.

Greeting message sample:

“Hello, this is (your name). Sorry I cannot take your call. Please leave a message at the tone. Thank you.”

- You can adjust the speak volume by pressing **^** or **v**.



To record a personal greeting message using the handset

1. Press **VOICE MAIL** while the station unit is in the standby mode, and lift the handset off the cradle.
 - If the direct access mode is OFF (p. 41), enter the mailbox password and press **#**.
 - If you have new messages, listen to all of them.
 2. Press **3**, then press **1**.
 3. After the tone, talk clearly using the handset. To end, press **1**.
 4. Press **2**.
 5. Replace the handset on the cradle.
- Announcements and the message will be heard through the handset instead of the speakerphone.
 - You can adjust the handset volume by pressing **^** or **v**.

To erase the recorded greeting message

1. While the station unit is in the standby mode, press **VOICE MAIL**.
 - If the direct access mode is OFF (p. 41), enter the mailbox password and press **#**.
 - If you have new messages, listen to all of them.
 2. Press **3**.
 3. Press **3** again while the message is being played.
 4. Press **VOICE MAIL**.
- The unit will answer with the pre-recorded greeting message (p. 44).
 - In step 1, you can lift the handset off the cradle after pressing **VOICE MAIL**.

Call Transfer Status

When a caller specifies an extension by pressing the extension number (1 to 8) followed by (#), the call is connected to that extension, and the extension can take the call. If the extension user is on another call or does not answer, a list of options (Incomplete Call Handling Menu) is announced to guide the caller. If the answer mode is ON (p. 43), the caller can leave a message in the mailbox.

- If a caller presses an invalid extension number, "Sorry this number is not assigned" is announced. The caller can call the operator or another extension or leave a message in the general delivery mailbox following the Incomplete Call Handling Menu.

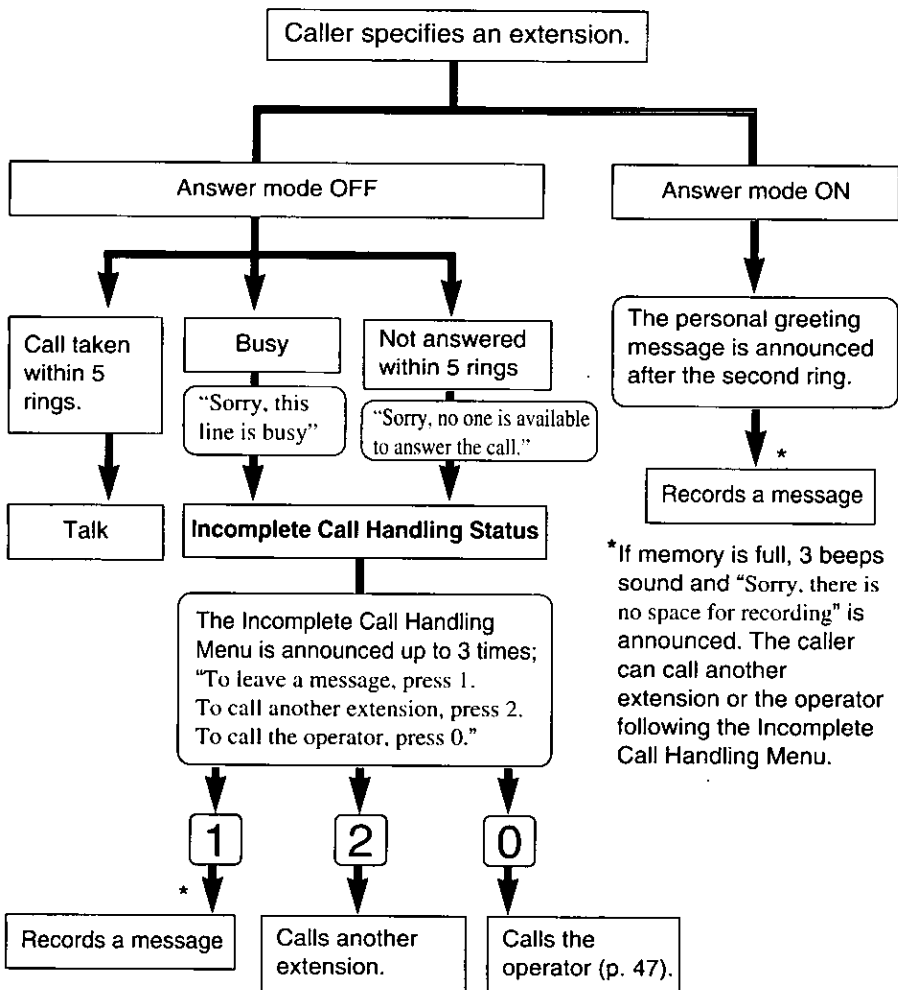

Call Operator Status

When a caller specifies the operator by pressing **0** and **#**, the call is connected to the operator. If the operator is on another call or does not answer, a list of options (Incomplete Call Handling Menu) is announced to guide the caller. The caller can leave a message in the general delivery mailbox or call an extension.

The operator will also be responsible for answering and handling calls that have been transferred.

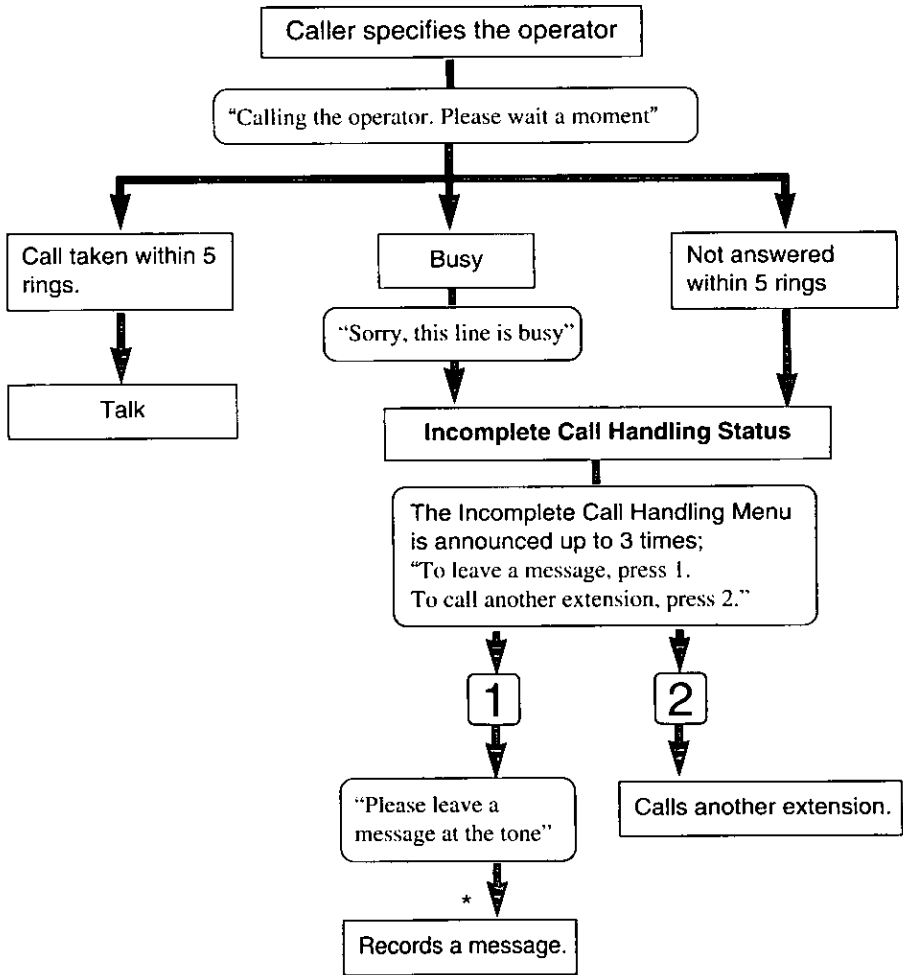

*If memory is full, 3 beeps sound and "Sorry, there is no space for recording" is announced. The caller can call an extension following the Incomplete Call Handling Menu.

Listening to Messages

You can access your personal mailbox and listen to the messages, transfer the messages to other mailboxes or erase unnecessary messages. You can also access the general delivery mailbox from your unit.

If the VOICE MAIL indicator flashes, "☒" flashes and "Voice mail" is shown on the display, new messages have been received in your mailbox. During playback "☒" is displayed.

Listening to new messages

1 While the station unit is in the standby mode, press **VOICE MAIL**.

- If the direct handset access mode is OFF (p. 41), enter the mailbox password and press **#**.
- The unit announces the mailbox number and the number of new messages from the speaker.

New messages playback *=Command menu
--

2 New messages are played.

- During each message playback, the message number is displayed.
- After each message playback, the Message Menu will be displayed as shown on the right and announced:

1=Repeat 2=Next 3=Erase 7=Transfer

"To repeat this message, press 1.
To play the next message, press 2.
To erase this message, press 3.
To transfer this message, press 7."

- At the end of the last message, "This is the last message" will be heard.

3 After listening to all new messages, the Command Menu is displayed as shown on the right and announced:

1=Play all msg. 2=Deliver msg. 3=Personal greet

"To play all messages, press 1.
To deliver a message, press 2. (p. 51)
To change the personal greeting, press 3. (p. 44)
To change to the general delivery mailbox, press 4.
(p. 50)
For Automated Attendant Status, press 5.
(To turn on/off the answer mode, p. 43)"

4=To general box 5=Answer on/off *=End
--



To listen to all messages, press 1.

- After each message playback, the Message Menu will be announced and displayed.

To end the operation, press VOICE MAIL.

- To delete the Message Menu, see page 52.



To listen to messages from the handset

While the station unit is in the standby mode, press **VOICE MAIL**, and lift the handset off the cradle.

- The display shows "Playback from handset" for a few seconds.

Playback from handset ENTER=Speaker
--

- You can switch from the handset to the speaker by pressing **ENTER**. "Playback from speaker" will be displayed for a few seconds. Each time you press **ENTER** while the handset is off the cradle, the mode will switch to the handset or the speaker.

Playback from speaker ENTER=Handset
--

- To end the operation in the handset mode, you can replace the handset on the cradle without pressing **VOICE MAIL**.
- If the direct access mode is OFF (p. 41), enter the mailbox password and press **#**.

During playback

To repeat a message	Press 1 or ◀ . (If you press within 5 seconds of playback, the previous message will be played.)
To skip a message	Press 2 or ▶ . (The next message is played.)

To adjust the speaker volume (8 levels) or handset volume (High, Medium or Low):

Press **▲** or **▼** during playback.

- Each time you press **▲** or **▼**, the volume level will change.

For Caller ID service users (p. 29)

During playback, the display shows the name and/or number of the caller whose message is being played.

SMITH, JACK 1-234-567-8901 ---Message 1---
--

To call back the displayed number:

During playback, press **DIGITAL SP-PHONE**.

- You can press a line button instead of pressing **DIGITAL SP-PHONE**. If registered to KX-TG2000B, do not press **LINE 3** or **LINE 4**.
- The unit stops playback and automatically dials the displayed phone number.

Listening to your personal mailbox messages from the base unit:

If the battery has no power or the station unit cannot be used any more, you (or the operator) can access your personal mailbox from the base unit.

1. Press **✉** on the base unit. (If there are new messages, listen to all of them.)
2. Press the corresponding INTERCOM button (**1** to **8**).
3. Enter your mailbox password (p. 41), and press **ENTER**.

➔ Listening to Messages

Transferring a Message

After listening to a message left in your personal mailbox, you can transfer it to other mailboxes.

1 During playback or before the start of the next message, press **[7]**.

- "Enter the destination mailbox number" is announced.

```
Transfer message
Enter mailbox #
```

2 Enter the destination mailbox numbers using the corresponding dialing buttons (**[0]**, **[1]** to **[8]**). For the general delivery mailbox, enter **[0]**.

- The mailbox numbers and "To accept, press #. To cancel, press *" are announced.
- If you make a mistake, press **[*]** and start again from step 1.

```
Transfer message
BoxNo.: 1-3-5--80
*=Cancel    #=OK
```

3 Press **[#]**.

- The mailbox numbers entered in step 2 will be announced, and the next message will be played.

```
Transfer message
BoxNo.: 1-3-5--80
```

Erasing a Message

We recommend you erase unnecessary messages after each playback. While the message you want to erase is being played or before the start of the next message, press **[3]** or **[CLEAR]**.

- A beep sounds and "Message erased" is heard.
- The unit will play the next message.

Listening to Messages in the General Delivery Mailbox

You can access the general delivery mailbox from the station unit.

1 While the station unit is in the standby mode, press **[VOICE MAIL]**.

- If the direct access mode is OFF (p. 41), enter the mailbox password and press **[#]**.
- If you have new messages, listen to all of them.
- To listen to messages from the handset instead of the speaker, lift the handset off the cradle.

2 Press **[4]**.

- "This is the general delivery mailbox" is heard.
- After the number of new messages is announced, new messages will be played.

3 After listening to all new messages;

To listen to all messages, press **[1]**.

To return to your mailbox, press **[4]**.

To end the operation, press **[VOICE MAIL]**.

- If the handset is off the cradle, you can replace it on the cradle to end the operation without pressing **[VOICE MAIL]**.

Delivering Your Own Memo Message

You can record and send your own voice memo message of **up to 3 minutes**, to other extensions and the operator in a single operation

1 While the station unit is in the standby mode, press **VOICE MAIL**

- If the direct access mode is OFF (p 41), enter the mailbox password and press **#**
- If you have new messages, listen to all of them
- The display will show the command menu as shown on the right and the menu will be announced from the speaker

```
1=Play all msg
2=Deliver msg
3=Personal greet
```



```
4=To general box
5=Answer on/off
*=End
```

2 Press **2**

```
Deliver message
Enter mailbox #
```

3 Enter the destination mailbox numbers using the corresponding dialing buttons (**0**, **1** to **8**) For the general delivery mailbox, enter **0**

```
Deliver message
BoxNo 12--5--80
*=Cancel #=OK
```

- If you make a mistake, press ***** and start again from step 2

4 Press **#**

- "Please leave a message at the tone To end recording press 1" is heard

```
Message record
00
1=End
```

5 After the tone, talk clearly, about 8 inches (20 cm) away from the **MIC** (microphone)

```
Message record
50
1=End
```

6 To end recording, press **1**

- The recorded message is played
- To change the message, press **1** and record the message again

```
Message play
00
1=Change 2=OK
```

7 Press **2**

8 Press **VOICE MAIL**

- To record the message with the handset, lift the handset off the cradle after pressing **VOICE MAIL** in step 1 In step 5, talk to the handset instead of the **MIC**
- "Message recorded by (extension number)" is announced before a delivered message is played at the destination extension
- You can adjust the speaker/handset volume by pressing **^** or **v**

Other Voice Mail System Features

Transferring a Call to Other Person's Mailbox

After you answer an incoming call, the call can be transferred to a mailbox of the person the caller wishes to speak to, where the caller can leave a message. To transfer to other person's personal mailbox, calls must be sent through the General Delivery Mailbox. The caller can then enter the extension number and the # sign to reach the mailbox. If the operator (base unit) or a cordless handset user answers an incoming call, he/she can also transfer the call to a personal mailbox.

The following is how calls must be transferred to the voice mail.

After you answered a call, you may announce that person the caller wishes to speak to is not available, and remind the caller of the extension number followed by the # sign. You then press the **VOICE MAIL** button, and hang up the line.

- The caller will then hear the line's greeting message. While the greeting is playing, the caller can press the extension number (1 to 8) followed by #. After that,
 - If the answer mode of the extension is on (p. 43), the caller will hear the personal greeting message at the end of the 2nd ring, then he/she can leave a message at the tone.
 - If the answer mode is off (p. 43), the caller will hear "Sorry, no one is available to answer the call. To leave a message press 1. To call another extension press 2. To call the operator press 0" at the end of the 5th ring. Or if the person the caller wishes to speak to, is on another call, the caller will hear "Sorry, this line is busy. To leave a message press 1. To call another extension press 2. To call the operator press 0".

If the caller who called and talked to the station unit user needs to speak to the operator or to leave a message for the operator, the station unit user should let the caller know: 1) the operator extension is 0, 2) to reach the operator or operator's mailbox (General Delivery Mailbox), the caller should press 0 and # during the line's greeting which the caller will hear after the station unit user presses **VOICE MAIL** button and hangs up the line.

Message Menu Mode

After each message is played, the Message Menu (p. 48) is announced and displayed as a guide. With a touch tone phone from a remote location, this menu can be heard (p. 53). To turn off the announcement and the display, which follow each message played, set the Message Menu to OFF. Your phone comes from the factory set to ON.

Make sure that the station unit is in the standby mode.

- 1 Press **FUNCTION**
- 2 Press ∇ or \blacktriangle until the arrow points to "Voice mail", and press \blacktriangleright
- 3 Press ∇ or \blacktriangle until the arrow points to "Message menu", and press \blacktriangleright
 - The current setting is displayed
- 4 Select "Off" or "On" by pressing ∇ or \blacktriangle
- 5 Press **ENTER**
 - A beep sounds
 - To return to the standby mode, press **EXIT**

Message menu
On
∇ \blacktriangle ENTER=Save

Remote Operation from a Touch Tone Phone ➔

You can access the Voice Mail System from any touch tone phone if the Automated Attendant System or the Answering System is on for any of lines by the base unit. You can listen to recorded messages in your personal mailbox and the general delivery mailbox, and you can transfer the messages and deliver your own messages to other mailboxes.

When you access your mailbox, you are required to enter your mailbox password (p. 41).

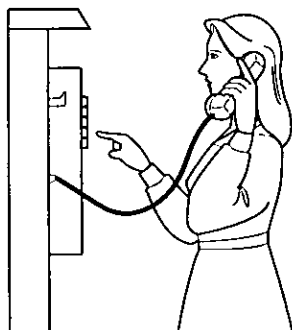

How to Access the Voice Mail System

Call the line's phone number to which the Automated Attendant System or the Answering System is assigned.

Press ***** and enter your mailbox password during or after the greeting message.

- "Mailbox (No.)" or "This is the general delivery mailbox" is heard.

After the number of new messages is announced, new messages will be played. After each message playback, the Message Menu is announced (if the Message Menu mode is on, p. 52):

"To repeat this message, press 1. To play the next message, press 2.

To erase this message, press 3. To transfer this message, press 7. (p. 54)"

If required, enter a command.

After playing back all new messages, the Command Menu is announced:

"To play all messages, press 1. (p. 54) To deliver a message, press 2. (p. 54)

To change the personal greeting, press 3. (p. 54)

To change to the general delivery mailbox, press 4. (p. 55)

To end this call, press *."

If required, enter a command.

To end remote operation, press ***** and hang up.

Remote Operation from a Touch Tone Phone

During message playback

During playback or before the start of the next message,

To repeat the message, press **1**

To play the next message, press **2**

To erase the message, press **3**

To transfer a message

After listening to a message, you can transfer it to other mailboxes

1 During playback or before the start of the next message, press **7**

2 Enter the destination mailbox numbers using the corresponding dialing buttons (**0**, **1** to **8**) For the general delivery mailbox, enter **0**

3 Press **#**

To listen to all messages

While the Command Menu is announced (p 53), press **1**

To deliver your own message

You can send your own voice memo message of up to 3 minutes, to several mailboxes

1 While the Command Menu is announced (p 53), press **2**

2 Enter the destination mailbox numbers using the corresponding dialing buttons (**0**, **1** to **8**) For the general delivery mailbox, enter **0**

3 Press **#**

4 Talk clearly after the tone To end, press **1**

5 Press **2**

6 Press ***** and hang up

To change the personal greeting message

You can change the mailbox personal greeting message

1 While the Command Menu is announced (p 53), press **3**

2 Press **1**

3 Talk clearly after the tone To end, press **1**

4 Press **2**

5 Press ***** and hang up

To switch to the general delivery mailbox from your personal mailbox

After entering your mailbox, you can switch to the general delivery mailbox to listen to messages

- 1 While the Command Menu is announced (p 53), press **[4]**
 - "This is the general delivery mailbox" is heard
 - After the number of new messages is announced, new messages will be played
- 2 After listening to all new messages,
To listen to all messages, press **[1]**
To return to your mailbox, press **[4]**
To end the operation, press **[*]** and hang up

Interrupting remote operation

If a user is accessing a mailbox from a remote location, and you mistakenly answer the call,

- 1 Press **[VOICE MAIL]**
- 2 Place the handset on the cradle or press **[DIGITAL SP-PHONE]**
The user can then access the mailbox

Calling the Answering System to leave a message in the general delivery mailbox without entering the password

Press **[*]** twice during the line's greeting message. The unit skips the rest of the message and you can leave your message after the tone

Pager Call

This feature allows the station unit to alert your pager when your mailbox has received an incoming message from an outside caller (When a message has been transferred or delivered from another user, the unit will not alert your pager) You can retrieve the message from a touch tone telephone (p 53) If you subscribe to a Caller ID service, the caller's telephone number will be displayed on your pager

First store a pager number and the pager display number (p 56, 57), then set the unit to call the pager

Make sure that the station unit is in the standby mode.

Storing a Pager Number

1 Press **FUNCTION**

2 Press **∨** or **∧** until the arrow points to "Pager setting", and press **▶**

3 While "Pager number" is at the arrow, press **▶**

Enter pager No

- If the number has already been stored, it will be displayed

4 Enter your pager number, and press **PAUSE** twice * Enter the access code, if required by your pager company
OR

If you use a 1-800 pager number with a pager PIN code

Enter the 1-800 number, and press **PAUSE** 3 times *

Enter the pager PIN code

- If you misdial, press **CLEAR**
Digits are erased from the right To erase all the digits, press and hold **CLEAR**
- You can enter a total of 44 digits

5 Press **ENTER**

- A beep sounds
- To return to the standby mode, press **EXIT**

*Pager companies require a delay after the pager number and/or the access code is dialed
For a 1-800 pager number, a delay will be required after the pager number and the pager PIN code are dialed
Contact your pager company regarding the required pause time
Pressing **PAUSE** once creates a 3 5 second delay and counts as one digit

- If the line(s) has(have) rotary or pulse service, press ***** between the pager number and **PAUSE** in step 4
- If you stored a 1-800 pager number, alphanumeric voice dispatch pager services will not work with this function



Storing the Pager Display Number

After storing one of the unit's phone numbers, you can check that pager number is stored correctly. This phone number will be displayed on your pager if the message is received from an area which does not provide a caller ID service or a caller requests not to show his/her information.

- 1 Press **FUNCTION**
- 2 Press \vee or \wedge until the arrow points to "Pager setting", and press \blacktriangleright
- 3 Press \vee or \wedge until the arrow points to "Pager display #", and press \blacktriangleright
 - "Enter display #" is displayed
 - If the number has already been stored, it will be displayed
- 4 Enter the phone number, up to 11 digits

Enter display #
2223334444□
ENTER=Save

- If you misdial, press **CLEAR**. Digits are erased from the right. To erase all the digits, press and hold **CLEAR**.
- 5 Press **ENTER**
 - A beep sounds
 - To return to the standby mode, press **EXIT**

To check the stored pager number and pager display number

- 1 Press **FUNCTION**
 - 2 Select "Pager setting" by pressing \vee or \wedge , and press \blacktriangleright
 - 3 Select "Calling pager" by pressing \vee or \wedge , and press \blacktriangleright
 - 4 Press **DIGITAL SP-PHONE**
 - The pager number is dialed
 - The pager beeps, and displays the pager display number followed by "11". If not, store the pager number and pager display number again
- Other users can let you know when they want you to call back, by following the procedure above

*What "11" means

When your unit alerts you pager after receiving a message in the mailbox, "11" will be displayed after the caller's telephone number

➔ Pager Call

To erase the pager number

- 1 Press **(FUNCTION)**, and press ∇ or \blacktriangle until the arrow points to "Pager setting", and press \blacktriangleright
- 2 While "Pager number" is at the arrow, press \blacktriangleright
- 3 Press **(CLEAR)**
- 4 Press **(ENTER)**

•The pager call mode will automatically return to OFF (see below)

To erase the pager display number

- 1 Press **(FUNCTION)**, and press ∇ or \blacktriangle until the arrow points to "Pager setting", and press \blacktriangleright
- 2 Press ∇ or \blacktriangle until the arrow points to "Pager display #", and press \blacktriangleright
- 3 Press **(CLEAR)**
- 4 Press **(ENTER)**

Setting the Unit to Call a Pager

- 1 Press **(FUNCTION)**
- 2 Press ∇ or \blacktriangle until the arrow points to "Pager setting", and press \blacktriangleright
- 3 Press ∇ or \blacktriangle until the arrow points to "Pager on/off", and press \blacktriangleright
 - "Off" (factory preset) is displayed
- 4 Select "On" by pressing ∇ or \blacktriangle

Pager on/off
On
∇ \blacktriangle ENTER=Save

- 5 Press **(ENTER)**
 - A beep sounds
 - To return to the standby mode, press **(EXIT)**

To turn off the pager call mode, select "Off" in step 4

If you have not subscribed to a Caller ID service, the caller's telephone number will not be displayed on your pager
--

- If another message is received before the unit alerts your pager for a previous message, the previous caller information will not be sent to your pager. Only the last call received will be sent to your pager
- If someone else makes or answers another call with your unit before the unit alerts your pager for a previous message, the unit will stop alerting your pager for that message
- If you receive a telephone number on your pager but cannot recognize the caller, you may have received a direct inward dial (DID) call, such as from a PBX. Please call your unit to check the caller's message

Battery Replacement

If "Recharge" is displayed with the battery icon "  flashing, please recharge the battery for another 8 hours. If "Recharge" still shows after being fully charged (p 10), or if "Install battery" is displayed when the battery has been installed or in use for certain amount of time (p 64), replace the battery with a new Panasonic HHR-15F2G1 battery. To order, call the accessories telephone number on page 2.

- 1** Remove the battery cover. Press down the arrow (①), then slide the cover in the direction shown (②).

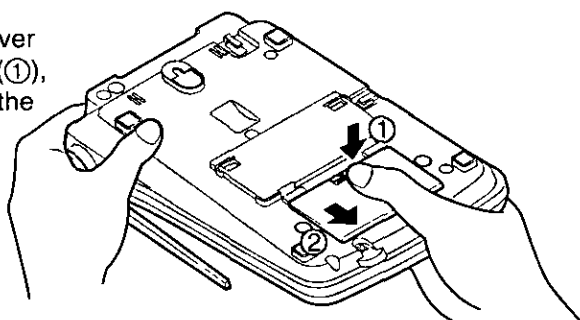

- 2** Replace the battery. Be sure wires are free from being pressed by the battery body or battery cover.

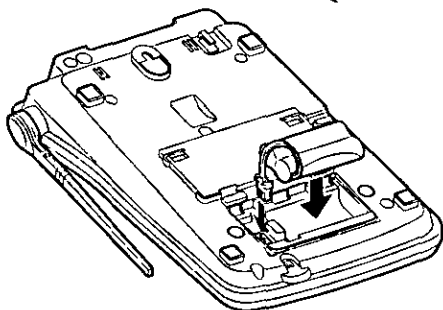

- 3** Close the battery cover. Slide the battery cover, and push it forward as shown until it locks into place.

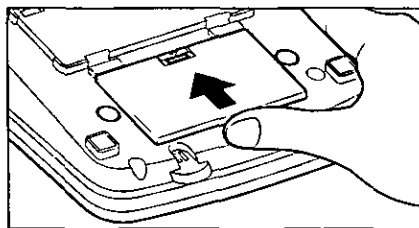
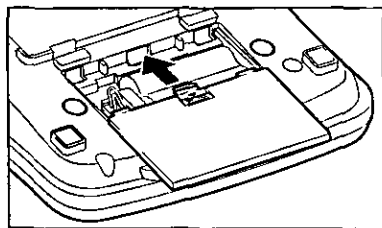

- 4** Connect the AC adaptor to charge (p 9). To use in a remote location (battery power mode), make sure you charge the new battery for about 8 hours in order to display the battery strength prompt correctly (p 10).

A nickel metal hydride battery that is recyclable powers the product you have purchased. Please call 1-800-8-BATTERY for information on how to recycle this battery.



Using an Optional Headset

Plugging an optional headset into the station unit allows a hands-free phone conversation. Please use only the Panasonic KX-TCA88 headset. To order, call the accessories telephone number on page 2.

Connecting the headset

Connect the headset to the headset jack as shown.

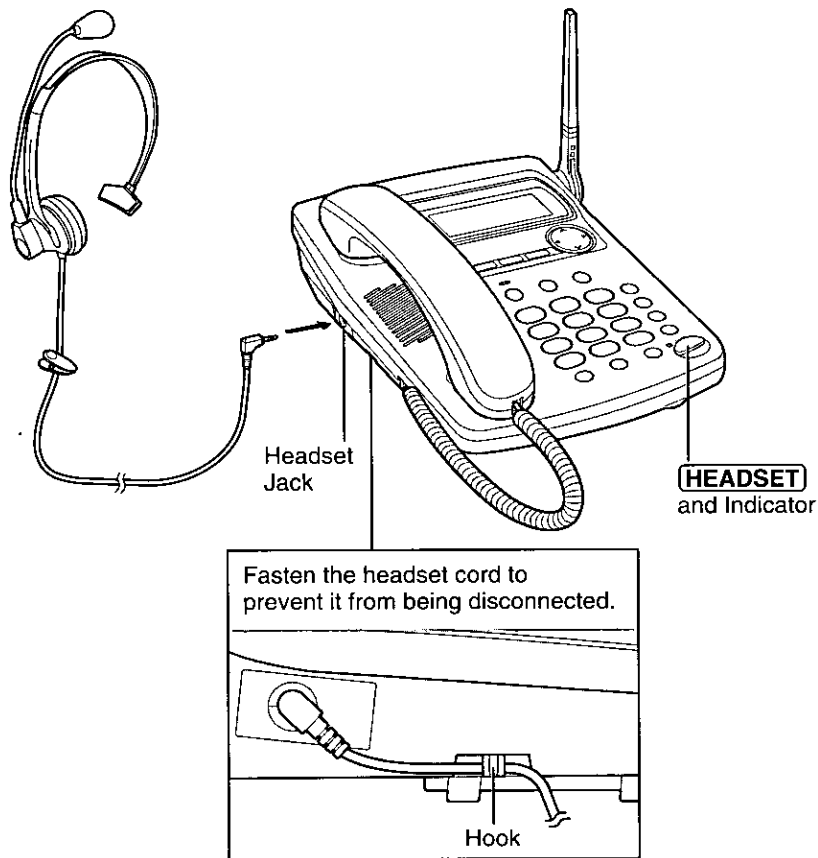

Making/Answering calls

- 1 Press **HEADSET** to make or answer a call.
 - You can press the line button instead of pressing **HEADSET**. If registered to KX-TG2000B, do not press **LINE 3** or **LINE 4**.
 - If you misdial when making a call, press **HEADSET** twice and dial again.
- 2 To hang up, press **HEADSET**.

Intercom

1 To make an intercom call:

Press **INTERCOM**, and enter the desired extension number (**0**, **1** to **8**).

- To stop paging, press **INTERCOM**.

To answer an intercom call:

Press **HEADSET**.

2 To end the intercom, press **HEADSET**.

To adjust the headset receiver volume (High, Medium or Low):

While using the headset, press **^** or **v**.

To switch to the speakerphone while using the headset:

"ENTER=SP-phone" is displayed. Press **ENTER**.

To return to the headset, press **ENTER** again.

- Each time you press **ENTER**, the call will switch to the headset or speakerphone. While in the speakerphone mode, "ENTER=Headset" is displayed.

- If you disconnect the headset during a conversation with the handset on the cradle, you can continue the conversation with the speakerphone. If the handset is off the cradle, you can continue the conversation with the handset.

While the headset is connected:

- When playing back messages (p. 48), you can listen to them from the headset.
 - To switch from the headset to the speaker, press **ENTER**. "Playback from speaker ENTER=Headset" will be displayed for a few second. To return to the headset, press **ENTER** again. "Playback from headset ENTER=Speaker" will be displayed. Each time you press **ENTER**, the mode will switch to the headset or speaker.
 - If you disconnect the headset during playback with the handset on the cradle, you can continue playback with the speaker. If the handset is off the cradle, you can continue playback with the handset.
- When recording a personal greeting message (p. 44) or your own voice memo message (p. 51), you can record the message with the headset microphone.

Wall Mounting

This unit can be mounted on a wall phone plate.

- 1** Pull down the handset hook until it locks, so the tab holds the handset.

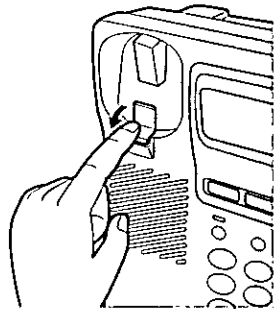

- 2** Connect the AC adaptor.

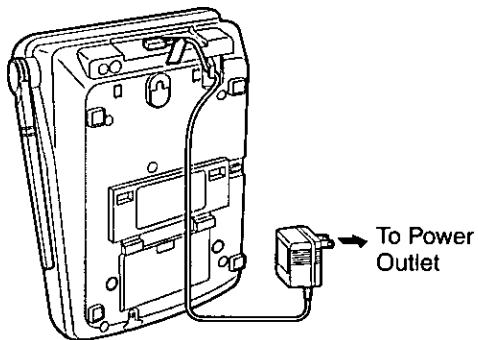

- 3**
 - ① Insert the tabs of the wall mounting adaptor into the wall openings.
 - ② Push the adaptor in the direction of the arrow. "UP" should face upward.

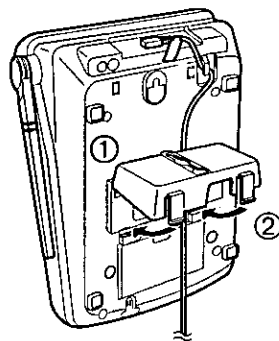

4 Mount the unit on the wall phone plate, then slide down.

- Raise the antenna.
- The telephone jack on the plate will be covered by the unit.

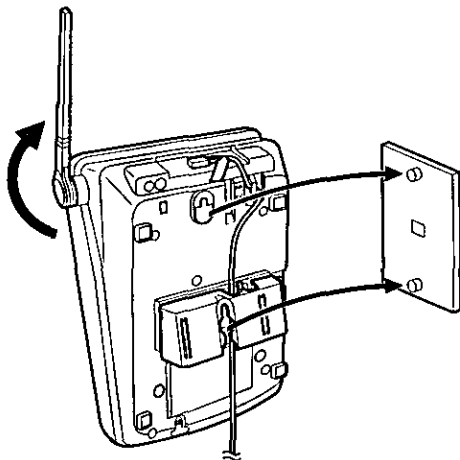

To temporarily set the handset down during a conversation, place it as shown here.

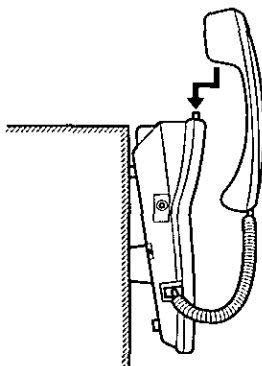

Error Messages

Display messages

If the station unit detects a problem, one of the following messages will be displayed. Error beeps or a busy tone will sound.

Display message	Cause & Remedy
No link to base. Walk closer to base & try again	The station unit has lost communication with the base unit. Locate the unit near the base unit, and try again.
Recharge	The battery needs to be charged. Connect the AC adaptor to recharge (p. 9).
System is busy. Please try again later.	If 4 other units are in use (for users registered to KX-TG4000B), or if more than one unit is in use (for users registered to KX-TG2000B): <ul style="list-style-type: none">– you may not be able to program certain function items, such as “Set password” or “Pager on/off”,– you may not be able to make an external or internal call, or– you may not be able to listen to messages in your mailbox. Try again later.
Busy	<ul style="list-style-type: none">• The paged party is engaged in a call.• While another user is listening to messages in the general delivery mailbox, you cannot access that mailbox (p. 50).• All lines are in use or a line of the button you pressed is in use. You cannot make a call. Try again later.• A paged unit is too far from the base unit.
Invalid	<ul style="list-style-type: none">• A paged unit has not been registered to the base unit.• The unit you are canceling has not been registered to the base unit (p. 39).
Memory is full	When trying to store an item in the directory, the directory memory is full. Erase other items and try again (p. 28).
Install battery	You have not installed the battery in the battery compartment (p. 8). However the unit will work with the AC power. If “Install battery” displays with the battery installed properly, the battery may be impaired. In that case replace it with a new one (p. 59).



Display message	Cause & Remedy
Line not available	The station unit has been registered to KX-TG2000B; – The LINE 3 and LINE 4 buttons are inoperative. – Line 3 or Line 4 is selected for the calling line selection. Change the selection to “Auto”, “Line 1” or “Line 2” (p. 36).
Call restriction	The dialed number is restricted by the base unit.
Please set pager number	You tried to check the number or set the unit to call the pager without first storing the pager number (p. 56).
Incorrect PIN. Try again.	You entered a wrong PIN (p. 13). Enter the correct PIN.
Not available. Please deregister HS	The station unit you are registering has already been registered.
Error!!	<ul style="list-style-type: none">•When you tried to register the station unit, the unit could not link to the base unit for some reason, such as interference from other electrical appliances. Take both units away from the electrical appliances and try again.•8 extension units (station units and cordless handsets) have already been registered to the base unit. You may ask the operator to cancel another unit registration.
Please enter another password	You selected a password which is the same as another mailbox (p. 41). Select another one.
Invalid. Please register to the base unit	The station unit you tried to make a call or access the mailbox has not been registered to the base unit. Register it to the base unit (p. 12, 13).

Error Messages

Voice messages

If the station unit detects a problem, one of the following messages will be announced.

Voice message	Cause & Remedy
"Sorry, there is no space for recording"	The remaining recording time or the number of messages which can still be recorded is 0. Erase unnecessary messages (p. 50) or you may ask the operator to erase unnecessary messages.
"Incorrect entry"	An invalid extension number was entered when transferring or delivering a message. Make sure that the unit is registered to the base unit (p. 50, 51).
"This is your mailbox"	You entered your own mailbox number when transferring or delivering a message (p. 50, 51).
"Sorry, this mailbox is in use"	You tried to access the general delivery mailbox from your unit while another user was listening to the messages there (p. 50).

Before Requesting Help



Telephone

Problem	Remedy
The unit does not work.	<ul style="list-style-type: none">• Be sure that the AC adaptor is connected properly (p. 9).• Charge the battery fully (p. 10).• Install the battery properly (p. 8, 59).• The unit has not been registered to the base unit. Register it to the base unit (p. 12, 13).• The base unit backup battery has been discharged during a power failure.
"No link to base. Walk closer to base & try again" is displayed and an alarm tone sounds.	<ul style="list-style-type: none">• You are too far from the base unit. Locate the station unit near the base unit and try again.• Raise the antenna.
Static, sound cuts in/out, fades. Interference from other electrical units.	<ul style="list-style-type: none">• Locate the station unit and the base unit away from other electrical appliances.• Locate the station unit near the base unit.• Raise the antenna.
The unit does not ring.	<ul style="list-style-type: none">• The ringer volume is set to OFF. Select HIGH or LOW (p. 16).• If registered to KX-TG4000B: If 4 other units are in use, the station unit may not ring. Those users will hear incoming call tones.• If registered to KX-TG2000B: If more than one unit is in use, the station unit may not ring. Those users will hear incoming call tones.• The unit is removed from the ring group of the line by the base unit.
You cannot dial.	<ul style="list-style-type: none">• The dialed number is restricted by the base unit.
The display is blank.	<ul style="list-style-type: none">• The battery has been discharged. Connect the AC adaptor to charge the battery fully (p. 9).

➔ Before Requesting Help

Problem	Remedy
You cannot program function items, such as the line selection.	<ul style="list-style-type: none">• Do not pause for over 60 seconds while programming.• Programming is not possible while the handset is off the cradle or the DIGITAL SP-PHONE indicator lights.• Make sure that the station unit is in the standby mode.
You cannot make a call even if there is at least one free line.	<ul style="list-style-type: none">• You may not be able to make a call, if 4 other units are in use (for users registered to KX-TG4000B), or if more than one unit is in use (for users registered to KX-TG2000B). Try again later.
You cannot page another unit.	<ul style="list-style-type: none">• You may not be able to page, if 4 other units are in use (for users registered to KX-TG4000B), or if more than one unit is in use (for users registered to KX-TG2000B). Try again later.• The unit is too far from the base unit.• The paged unit is in use.
You cannot store a name and phone number in the directory.	<ul style="list-style-type: none">• You cannot store an item in the directory while the handset is off the cradle or the DIGITAL SP-PHONE indicator lights.• Do not pause for over 60 seconds while programming.
While programming or searching, the unit starts to ring and stops the program/search.	<ul style="list-style-type: none">• To answer the call, lift the handset off the cradle, press DIGITAL SP-PHONE or press the called line button. Start again from the beginning after hanging up.
The caller's information is not displayed.	<ul style="list-style-type: none">• The unit is removed from the ring group of the line by the base unit.• Other telephone equipment may be interfering with your phone. Disconnect it and try again.• Other electrical appliances connected to the same outlet may be interfering with the Caller ID information.• Telephone line noise may be affecting the Caller ID information.



Problem	Remedy
The unit exits the Caller list/directory while you are viewing it.	<ul style="list-style-type: none">• Do not pause for over 60 seconds while searching.
You cannot register the unit at the base unit.	<ul style="list-style-type: none">• The battery needs to be charged. Connect the AC adaptor to charge the battery fully (p. 9).
When a second call is received on the same line, the unit does not display the new caller's information.	<ul style="list-style-type: none">• If another call is received on the same line while;<ul style="list-style-type: none">– the Automated Attendant System or Answering System is responding to a call, or– a call is placed on hold,the caller information will not be displayed.
You cannot redial the last number dialed.	<ul style="list-style-type: none">• If the last number dialed was more than 32 digits long, the number will not be redialed.• Access numbers entered after pressing (TONE) will not be included when redialing.• The (REDIAL) button also functions as the (PAUSE) button. It will redial the last number dialed if pressed at the outset of a call (p. 19). If another number has been dialed first, it will operate as a pause button (p. 34).
You cannot have a conversation using the headset.	<ul style="list-style-type: none">• Make sure that the headset is plugged into the headset jack properly (p. 60).• If "ENTER=Headset" is displayed, press (ENTER) to switch from the speakerphone to the headset.
"Recharge" is displayed, "■" flashes or the unit beeps intermittently.	<ul style="list-style-type: none">• Connect the AC adaptor to charge the battery fully (p. 9).
You charged the battery fully, but "Recharge" is still displayed and/or "■" still continues to flash.	<ul style="list-style-type: none">• Install a new battery (p. 59).

➔ Before Requesting Help

System Features (Voice Mail System/Automated Attendant System/Answering System)

Problem	Remedy
The Automated Attendant System is on, but incoming messages are not recorded in your mailbox.	<ul style="list-style-type: none">• The remaining recording time or the number of messages which can still be recorded is 0. Erase unnecessary messages (p. 50) or you may ask the operator to erase unnecessary messages.
You cannot access your mailbox by pressing VOICE MAIL .	<ul style="list-style-type: none">• Make sure that the station unit is in the standby mode.• You may not be able to access the mailbox, if 4 other units are in use (for users registered to KX-TG4000B) or if more than one unit is in use (for users registered to KX-TG2000B). Try again later.• If the Automated Attendant System or Answering System is responding to 4 calls (for users registered to KX-TG4000B) or 2 calls (for users registered to KX-TG2000B) on separate lines, you cannot access the mailbox. Try again later.• The station unit is too far from the base unit. Locate the unit near the base unit.• If "Enter mailbox password" is displayed, the direct access mode is OFF (p. 41). Enter the mailbox password and press #.
You cannot access your mailbox from a touch tone phone.	<ul style="list-style-type: none">• Make sure you press * and enter the correct password.• The Automated Attendant System or Answering System may not respond if the tones are too short to activate the unit. Press each button firmly.
While recording a greeting message, incoming call tones are heard.	<ul style="list-style-type: none">• To answer the call, press the called line button. The recording will stop. Start from the beginning after hanging up.

Problem	Remedy
During playback, incoming call tones are heard	<ul style="list-style-type: none"> To answer the call, press the called line button. To resume playback, press VOICE MAIL after hanging up
The display does not show the name and/or number of the caller whose message is being played	<ul style="list-style-type: none"> If the caller is not stored in the caller list, the caller's information will not be displayed
You cannot listen to messages from the speaker or headset	<ul style="list-style-type: none"> When the optional headset is connected, messages are heard from the headset. You can switch to the speaker by pressing ENTER

- If you cannot solve your problem, call our customer call center at 1-800-211-PANA(7262)
- Panasonic's e-mail address for customer inquiries: consumerproducts@panasonic.com for customers in the USA or Puerto Rico ONLY

Important Safety Instructions

When using this unit, basic safety precautions should always be followed to reduce the risk of fire, electric shock, or personal injury.

1. Read and understand all instructions.
2. Follow all warnings and instructions marked on this unit.
3. Unplug this unit from AC outlets before cleaning. Do not use liquid or aerosol cleaners. Use a damp cloth for cleaning.
4. Do not use this unit near water, for example, near a bathtub, washbowl, kitchen sink, or the like.
5. Place this unit securely on a stable surface. Serious damage and/or injury may result if the unit falls.
6. Do not cover slots and openings on the unit. They are provided for ventilation and protection against overheating. Never place the unit near radiators, or in a place where proper ventilation is not provided.
7. Use only the power source marked on the unit. If you are not sure of the type of power supplied to your home, consult your dealer or local power company.
8. Do not place objects on the power cord. Install the unit where no one can step or trip on the cord.
9. Do not overload wall outlets and extension cords. This can result in the risk of fire or electric shock.
10. Never push any objects through slots in this unit. This may result in the risk of fire or electric shock. Never spill any liquid on the unit.
11. To reduce the risk of electric shock, do not disassemble this unit. Take the unit to an authorized servicer when service is required. Opening or removing covers may expose you to dangerous voltages or other risks. Incorrect reassembly can cause electric shock when the unit is subsequently used.
12. Unplug this unit from the wall outlet and refer servicing to an authorized servicer when the following conditions occur:
 - A. When the power supply cord or plug is damaged or frayed.
 - B. If liquid has been spilled into the unit.
 - C. If the unit has been exposed to rain or water.
 - D. If the unit does not work normally by following the operating instructions. Adjust only controls covered by the operating instructions. Improper adjustment may require extensive work by an authorized servicer.
 - E. If the unit has been dropped or physically damaged.
 - F. If the unit exhibits a distinct change in performance.
13. During thunderstorms, avoid using telephones except cordless types. There may be a remote risk of an electric shock from lightning.
14. Do not use this unit to report a gas leak, when in the vicinity of the leak.

SAVE THESE INSTRUCTIONS

CAUTION:

To reduce the risk of fire or injury to persons, read and follow these instructions

- 1 Use only the battery(ies) specified
- 2 Do not dispose of the battery(ies) in a fire. They may explode. Check with local waste management codes for special disposal instructions.
- 3 Do not open or mutilate the battery(ies). Released electrolyte is corrosive and may cause burns or injury to the eyes or skin. The electrolyte may be toxic if swallowed.
- 4 Exercise care in handling batteries in order not to short the battery to conductive materials such as rings, bracelets, and keys. The battery and/or conductor may overheat and cause burns.
- 5 Charge the battery(ies) provided with or identified for use with this product only in accordance with the instructions and limitations specified in this manual.

WARNING:

TO PREVENT FIRE OR SHOCK HAZARD, DO NOT EXPOSE THIS PRODUCT TO RAIN OR ANY TYPE OF MOISTURE

- The AC adaptor is used as the main disconnect device, ensure that the AC outlet is located/installed near the unit and is easily accessible

FCC and Other Information

When programming emergency numbers and/or making test calls to emergency numbers:

1. Remain on the line and briefly explain to the dispatcher the reason for the call before hanging up.
2. Perform such activities in the off-peak hours, such as early morning hours or late evenings.

This device complies with Part 15 of the FCC Rules. Operation is subject to the following two conditions: (1) This device may not cause harmful interference, and (2) this device must accept any interference received, including interference that may cause undesired operation.

Privacy of communications may not be ensured when using this phone.

CAUTION:

Any changes or modifications not expressly approved by the party responsible for compliance could void the user's authority to operate this device.

Note:

This equipment has been tested and found to comply with the limits for a Class B digital device, pursuant to Part 15 of the FCC Rules. These limits are designed to provide reasonable protection against harmful interference in a residential installation. This equipment generates, uses, and can radiate radio frequency energy and, if not installed and used in accordance with the instructions, may cause harmful interference to radio communications. However, there is no guarantee that interference will not occur in a particular installation. If this equipment does cause harmful interference to radio or television reception, which can be determined by turning the equipment off and on, the user is encouraged to try to correct the interference by one or more of the following measures:

- Reorient or relocate the receiving antenna.
- Increase the separation between the equipment and receiver.
- Connect the equipment into an outlet on a circuit different from that to which the receiver is connected.
- Consult the dealer or an experienced radio/TV technician for help.

Operating near 2.4GHz electrical appliances may cause interference. Move away from the electrical appliances.

CAUTION:

To comply with FCC RF exposure requirements, this unit should be installed with its antenna located at 20 cm or more from persons.

- **Environment** — do not place the unit in a room where the temperature is less than 5°C (41°F) or greater than 40°C (104°F). Allow 10 cm (4") clearance around the unit for proper ventilation. Avoid excessive smoke, dust, mechanical vibration, shock, or direct sunlight.
- **Medical** — consult the manufacturer of any personal medical devices, such as pacemakers, to determine if they are adequately shielded from external RF (radio frequency) energy. (The unit operates in the frequency range of 2401MHz to 2480MHz, and the power output level can range from 0.04 watts to 0.40 watts.) Do not use the unit in health care facilities if any regulations posted in the area instruct you not to do so. Hospitals or health care facilities may be using equipment that could be sensitive to external RF (radio frequency) energy.
- **Routine care** — wipe the unit with a soft cloth. Do not use benzine, thinner, or any abrasive powder. When you leave the unit unused for a long period of time, unplug the AC adaptor from the outlet.

Index

- A** Access to General Delivery Mailbox ..50, 55
Access to personal mailbox48, 53
Accessories.....2
AC power mode9
Answering calls20
Answering System mode40
Automated Attendant System42
- B** Backlit LCD7
Battery installation.....8
Battery operating time11
Battery power mode.....8, 10
Battery replacement.....59
Battery strength.....10
- C** Call on hold19, 21
Call transfer.....46, 47
Call waiting caller ID2, 34
Call waiting tone.....34
Caller ID display.....29, 49
Caller ID service.....20, 29
Caller ID, edit31
Caller List, erasing33
Caller List, storing32
Caller List, viewing.....30
Calling back from Caller ID List ..31, 49
Calling extensions.....42, 46
Calling operator.....42, 47
Command menu43, 48
Conference call24
- D** Delivering a voice memo message...51
Deregistration.....39
Direct access41
Directory.....25
Directory, dialing27
Directory, editing.....28
Directory, erasing.....28
Directory, name and symbols26
Directory, searching.....27
Displays on LCD7
- E** Erasing a voice mail message ..50, 53
Error messages.....64
Error messages, display64
Error messages, voice66
Extension number12, 22
- F** Factory preset function setting.....38
FCC and other information.....72
FLASH button34
Function Menu, Selection14
Function Menu, Table15
- G** Greeting, answer mode setting...43, 44
- H** Headset, optional60
Hold alarm.....19
Hold time19
- I** Incoming call tone37
Initialization38
Installation8
Installation, AC adaptor.....9
Installation, battery.....8
Installation, corded handset.....8
Intercom call.....22
Intercom paging22
- L** Line selection36
Listening to voice mail messages...48, 50
Location of buttons6
- M** Mailbox password41
Making Calls17
Message Menu48, 52
- N** Noise9
- P** Pager call56
Pager call mode, setting58
Pager display number57
Pager number56
PAUSE34
Personal greeting.....43, 44
PIN number13
Pulse service.....35
- R** Redial.....19
Redial list, erasing.....19
Registration.....12, 13
Remote access52, 53
Remote access operation ...53, 54, 55
Ringer Off.....16
Ringer pattern35
Rotary service35, 42
Rotary service, tone dialing.....35
- S** Safety Instructions72
Setting, Ringer volume.....16
Shipping product for service...Back cover
- T** Transferring a voice mail message ...50
Troubleshooting, Help line71
Troubleshooting, System70
Troubleshooting, Telephone67
- V** Voice Mail40
Voice Mail transfer23, 52
Voice Mail, General Mailbox40
Voice Mail, Personal mailbox.....40
Volume control, Headset61
Volume control, SP-phone19, 49
Volume control, Corded handset...19, 49

For product service

- Call 1-800-211-PANA(7262) for the location of an authorized servicenter.
- Panasonic's e-mail address for customer inquiries:
consumerproducts@panasonic.com
for customers in the USA or Puerto Rico ONLY

When you ship the product

- Carefully pack your unit, preferably in the original carton.
- Attach a letter, detailing the symptom, to the outside of the carton.

Symptom

- Send the unit to an authorized servicenter, prepaid and adequately insured.
- Do not send your unit to the Panasonic Consumer Electronics Company listed below or to executive or regional sales offices. These locations do not repair consumer products.

- This cordless telephone is designed for use in the United States of America. Sale or use of this product in other countries may violate local laws.
- Ce téléphone sans fil est conçu pour être utilisé aux États-Unis d'Amérique. La vente ou l'emploi de cet appareil dans certains autres pays peut constituer une infraction à la législation locale.
- Este teléfono sin cordón fue elaborado para uso en los Estados Unidos de América. La venta o el empleo de este producto en ciertos países puede constituir violación de la legislación local.
- このコードレス電話機は、日本国外での使用を目的として設計されており、日本国内での使用は法律違反となります。従って、当社では日本国内においては原則として修理などのサービスは致しかねます。

Panasonic Consumer Electronics Company,
Division of Matsushita Electric Corporation of America
One Panasonic Way, Secaucus, New Jersey 07094

Panasonic Sales Company,
Division of Matsushita Electric of Puerto Rico, Inc.
Ave. 65 de Infantería, Km. 9.5, San Gabriel Industrial Park
Carolina, Puerto Rico 00985