

Roland

MIDI GR-MIDI CONVERTER

GM-70

Owner's Manual

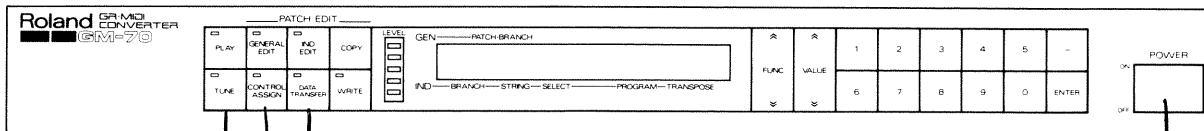

Initialize

The Roland GM-70 is a MIDI Converter for guitar that can convert complicated vibrations of the guitar's strings into MIDI signals.

To make the best use of the GM-70, please read the owner's manual carefully.

FEATURES

- The GM-70's 16 bit CPU and the newly developed LSI allow to convert the guitar signals to MIDI signals in a high speed.
- The GM-70 features the MIDI Mono Mode that assigns a different MIDI channel to each string, sending message separately.
- Various functions can be assigned to the control knobs on the guitar controller and foot controller, etc.
- Various parameters (e.g. Program Change, Transpose) can be assigned to each string.
- By using the four Branches, four different MIDI signals can be transmitted at a time.
- Up to 128 different MIDI settings can be stored in the GM-70's memory.
- Using the optional Foot Controller FC-100, you can select any of the MIDI settings instantaneously.

IMPORTANT NOTES

- The appropriate power supply for this unit is shown on its name plate. Please make sure that the line voltage in your country meets the requirement.
- Please do not use the same socket used for any noise generating device (such as motor, variable lighting system).
- This unit might not work properly if turned on immediately after turned off. If this happens, simply turn it off and turn it on again a few seconds later.
- Before setting up this unit with other devices, turn this unit and all the other units off.
- This unit might be heated while operating, but there is no need to worry about it.
- Use a soft cloth and clean only with a mild detergent.
- Do not use solvents such as paint thinner.
- Avoid using this unit in excessive heat or humidity or where it may be affected by direct sunlight or dust.
- Operating this unit near a neon, fluorescent lamp, TV or CRT Display may cause noise interference. If so, change the angle or the position of the unit.
- The GM-70 features memory back-up system that retains the data even when switched off. The battery that supports the back-up circuit should be replaced every five years. Call for the Roland service station for the battery replacement. (The first replacement may be required before five years, depending on how long it had passed before you purchased the unit.)

ADVICE ON HOW TO USE THE GP-8

How to store the 128 effect programs

The GP-8 can store up to 128 different effect programs, and any of them can be instantaneously called by using a foot controller (optional) even during live performance. It may be a good idea to arrange these effect programs as follows.

e.g.) Collect all the effects used for live performance in Group A, and the effects for sound library in Group B.

☞ In a Bank of Group A (e.g. 1-1 to 1-8), you may collect eight different effects which are to be used in a song. A normal sound (without effect) stored in the last Number (Number 8) may be quite useful.

☞ In Group B, you may store the original effects you have made, and copy the one you want to use to Group A. In Group B, you may also collect the same type of sounds (lead type, backing type, etc) in one Bank.

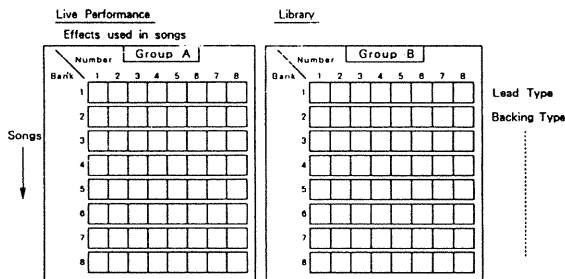

* 64 different effect programs are preprogrammed in Group A (in random order), and exactly the same effects are stored in Group B in a different order according to sound type.

Knack about sound synthesis

☞ Set SENS of Dynamic Filter to 0, DOWN / UP to UP, and the Cutoff Frequency to a certain value. This creates such effect as when the wah pedal is fixed at a certain position. And now, a unique guitar sound can be obtained by adjusting Q Control.

A high quality digital chorus is built in the GP-8. This digital chorus takes an important part in sound synthesis. Specially, the setting of the Pre-delay should be greatly vary depending on the sound you aim to create.

☞ When using the digital chorus as a chorus, set Feedback to 0, and Pre-delay to higher than 10. By setting Pre-delay rather long, spacious chorus effect can be obtained.

☞ When using the digital chorus as a flanger, set Rate around 0 to 10, Depth from 0 to 15. Then setting Pre-delay to 1 creates the BOSS High-band Flanger (HF-2) like sound, and setting it 2 or 3 creates the BF-2 like sound.

FOR MINIMIZING NOISE AND HUM

- The GP-8 contains high gain units such as an overdrive and a distortion, therefore, be aware that even a slight noise or hum will be amplified.
- When connecting two GP-8's, be sure that they do not touch each other, or electrical looping will be caused between the units, generating hum.

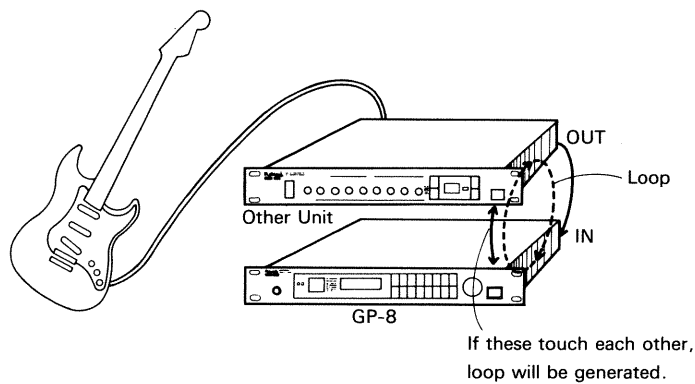

- When using the GP-8 with the GR-MIDI Converter "GM-70", connect the output of the guitar's normal sound directly to the Input Jack of the GP-8 without putting it through the GM-70. In this way, hum and noise will be minimized.

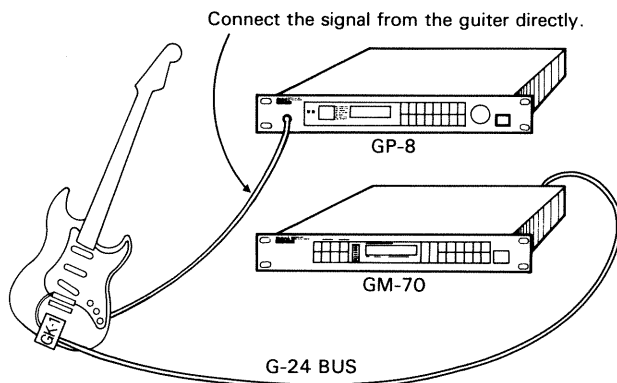

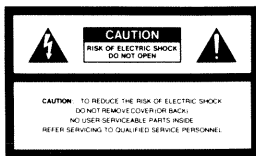

The lighting flash with arrowhead symbol, within an equilateral triangle, is intended to alert the user to the presence of un-insulated "dangerous voltage" within the product's enclosure that may be of sufficient magnitude to constitute a risk of electric shock to persons.

The exclamation point within an equilateral triangle is intended to alert the user to the presence of important operating and maintenance (servicing) instructions in the literature accompanying the product.

INSTRUCTIONS PERTAINING TO A RISK OF FIRE, ELECTRIC SHOCK OR INJURY TO PERSONS.

IMPORTANT SAFETY INSTRUCTIONS

WARNING When using electric products, basic precautions should always be followed, including the following:

1. Read all the instructions before using the product.
2. To reduce the risk of injury, close supervision is necessary when a product is used near children.
3. Do not use this product near water- for example, near a bathtub, washbowl, kitchen sink, in a wet basement, or near a swimming pool, or the like.
4. This product should be used only with a cart or stand that is recommended by the manufacturer.
5. This product, either alone or in combination with an amplifier and headphones or speakers, may be capable of producing sound levels that could cause permanent hearing loss.
Do not operate for a long period of time at a high volume level or at level that is uncomfortable. If you experience any hearing loss or ringing in the ears, you should consult an audiologist.
6. The product should be located so that its location or position does not interfere with its proper ventilation.
7. The product should be located away from heat sources such as radiators, heat registers or other products that produce heat.
8. The product should avoid using in where it may be effected by dust.
9. The product should be connected to a power supply only of the type described in the operating instructions or as marked on the product.
10. The power-supply cord of the product should be unplugged from the outlet when left unused for a long time.
11. Do not tread on the power-supply cord.
12. Do not pull the cord but hold the plug when unplugging.
13. When setting up with any other instruments, the procedure should be followed in accordance with instruction manual.
14. Care should be taken so that objects do not fall and liquids are not spilled into the enclosure through openings.
15. The product should be serviced by qualified service personnel when:
 - A: The power-supply cord or the plug has been damaged; or
 - B: Objects have fallen, or liquid has been spilled into the product; or
 - C: The product has been exposed to rain; or
 - D: The product does not appear to operate normally or exhibits a marked change in performance; or
 - E: The product has been dropped, or the enclosure damaged.
16. Do not attempt to service the product beyond that described in the user-maintenance instructions. All other servicing should be referred to qualified service personnel.

SAVE THESE INSTRUCTIONS

WARNING : THIS APPARATUS MUST BE EARTHED

IMPORTANT :The wires in this mains lead are coloured in accordance with the following code:
 Green-and-yellow : Earth
 Blue : Neutral
 Brown : Live

As the colours of the wires in the mains lead of this apparatus may not correspond with the coloured markings identifying the terminals in your plug, proceed as follows:

The wire which is coloured green-and-yellow must be connected to the terminal in the plug which is marked by the letter E or by the safety earth symbol \oplus or coloured green or green-and-yellow.

The wire which is coloured blue must be connected to the terminal which is marked with the letter N or coloured black.

The wire which is coloured brown must be connected to the terminal which is marked with the letter L or coloured red.

Bescheinigung des Herstellers /Importeurs

Hiermit wird bescheinigt, daß der/die/das

ROLAND GR-MIDI CONVERTER GM-70

(Gerät, Typ, Bezeichnung)

in Übereinstimmung mit den Bestimmungen der

Amtsbl. Vfg 1046 / 1984

(Amtsblattverfügung)

funk-entstört ist.

Der Deutschen Bundespost wurde das Inverkehrbringen dieses Gerätes angezeigt und die Berechtigung zur Überprüfung der Serie auf Einhaltung der Bestimmungen eingeräumt.

Roland Corporation Osaka / Japan

Name des Herstellers/Importeurs

RADIO AND TELEVISION INTERFERENCE

***Warning** : This equipment has been verified to comply with the limits for a Class B computing device pursuant to Subpart J, of Part 15, of FCC rules. Operation with non-certified or non-verified equipment is likely to result in interference to radio and TV reception.

The equipment described in this manual generates and uses radio frequency energy. If it is not installed and used properly, that is, in strict accordance with our instructions, it may cause interference with radio and television reception.

This equipment has been tested and found to comply with the limits for a Class B computing device in accordance with the specifications in Subpart J, of Part 15, of FCC Rules. These rules are designed to provide reasonable protection against such interference in a residential installation. However, there is no guarantee that the interference will not occur in a particular installation. If this equipment does cause interference to radio or television reception, which can be determined by turning the equipment on and off, the user is encouraged to try to correct the interference by the following measure:

- Disconnect other devices and their input/output cables one at a time. If the interference stops, it is caused by either the other device or its I/O cable.
- These devices usually require Roland designated shielded I/O cables. For Roland devices, you can obtain the proper shielded cable from your dealer. For non-Roland devices, contact the manufacturer or dealer for assistance.

If your equipment does cause interference to radio or television reception, you can try to correct the interference by using one or more of the following measures:

- Turn the TV or radio antenna until the interference stops.
- Move the equipment to one side or the other of the TV or radio.
- Move the equipment farther away from the TV or radio.
- Plug the equipment into an outlet that is on a different circuit than the TV or radio. (That is, make certain the equipment and the radio or television set are on circuits controlled by different circuit breakers or fuses.)
- Consider installing a rooftop television antenna with coaxial cable lead-in between the antenna and TV.

If necessary, you should consult your dealer or an experienced radio/television technician for additional suggestions. You may find helpful the following booklet prepared by the Federal Communications Commission:

How to Identify and Resolve Radio-TV Interference Problems
 This booklet is available from the U.S. Government Printing Office, Washington, D.C. 20402, Stock No. 004 000 00345 4.

Please read the separate volume "MIDI", before reading this owner's manual.

Copyright © 1986 by ROLAND CORPORATION

All rights reserved. No part of this publication may be reproduced in any form without the written permission of ROLAND CORPORATION.

CONNECTIONS

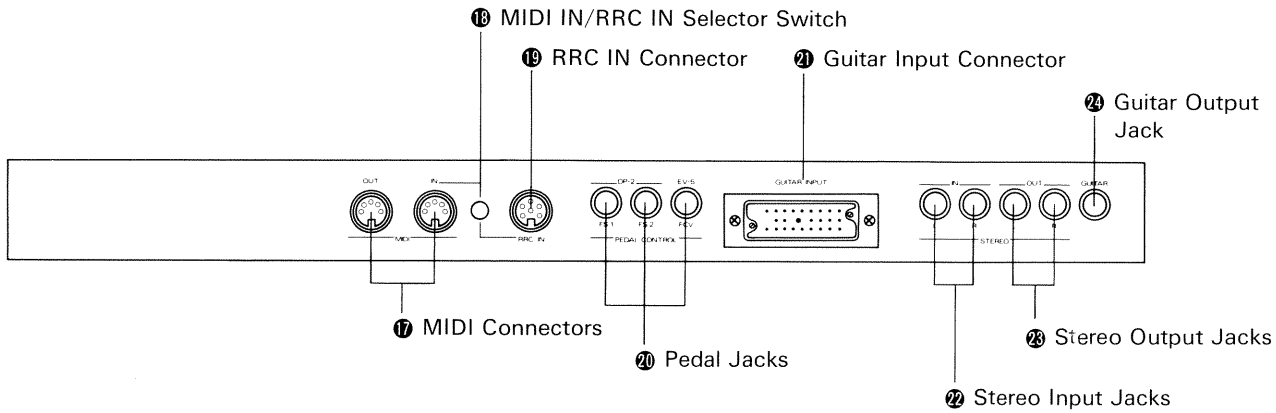
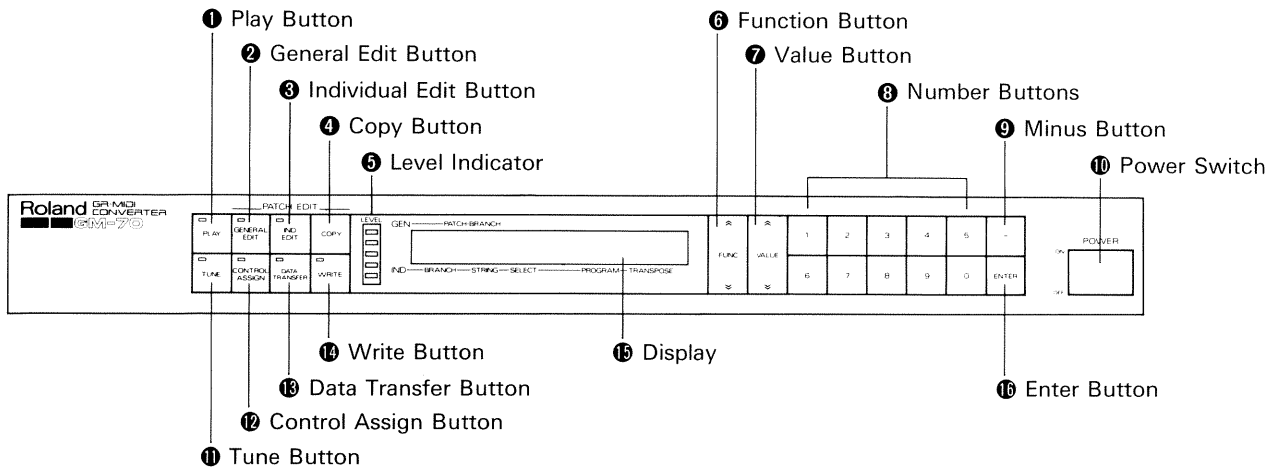

CONTENTS

Panel Description	3
Connection	6
[1] Basic Operation	8
1. MIDI Poly Mode	9
a. Initialization	9
b. Power-up	10
c. MIDI Channel Setting	10
2. MIDI Mono Mode	12
a. Initialization	12
b. Power-up	12
c. MIDI Channel Setting	13
3. About the Guitar	15
a. Adjusting the Divided Pickup ...	15
b. Adjusting the Output Volume ...	15
4. Tuning	17
5. Function Settings	18
a. Setting Each Parameter	18
b. Writing into Memory	20
6. Patch Selection	21

[2] Advanced Operation	23
1. Patch Editing	23
a. General Editing	24
1) Calling a Function	24
2) Editing the Functio	25
b. Individual Editing	28
1) Calling a Function	29
2) Editing the Function	30
3) String Copy	31
c. Patch Renaming	31
2. Patch Writing	32
3. Control Assign	32
a. Assignable Controllers	32
b. Assignable Functions	34
1) Control Change	34
2) Other Functions	35
c. Assigning Operation	36
d. Contoller Operation Modes	37
4. MIDI Program Change Receive ...	38
5. Data Transfer	39
a. Setting MIDI Receive Channel ...	39
b. Bulk Dump	39
c. Bulk Load	40

[3] Supplement	42
1. Default Values by System	
Initialization	42
2. MIDI of the GM-70	43
3. Before Calling for Service	48
Specifications	55

PANEL DESCRIPTION

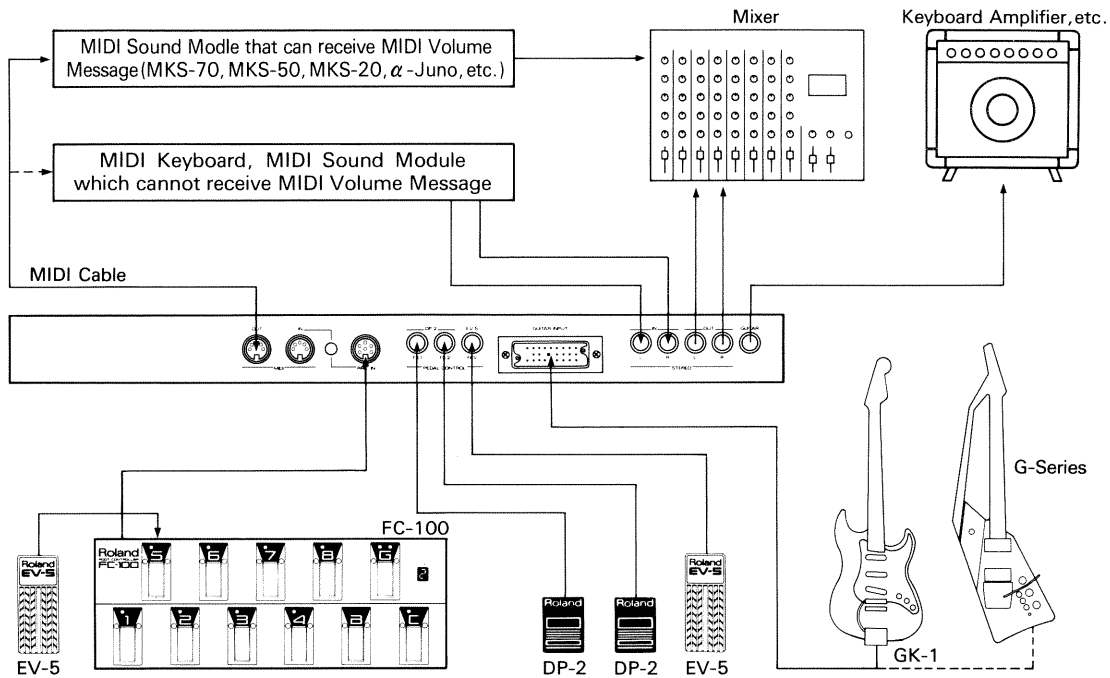

● MIDI Connectors

MIDI OUT : Connect a MIDI sound module or keyboard.

MIDI IN : Use this for receiving the Program Change (see page 38) or for Bulk Load (see page 40).

assigned to the above jacks using the Control Assign function (see page 32).

● Guitar Input Connector

Connect the guitar controller to this connector using the cable supplied with the controller (C-24D BUS).

Input Jack, then connect the Stereo Output Jack to the amplifier. This connection is also effective to mute the slight sound which may remain even when the volume knob on the Guitar Controller is set to the minimum. Here, please remember to set the MIDI Volume to OFF.

● RRC IN Connector

Connect the Foot Controller FC-100 to this connector (see page 22).

● MIDI / RRC Selector Switch

When using the Foot Controller FC-100, set this switch to the "RRC IN" position, and set it to "MIDI IN" when receiving the Program Change or Bulk-loading.

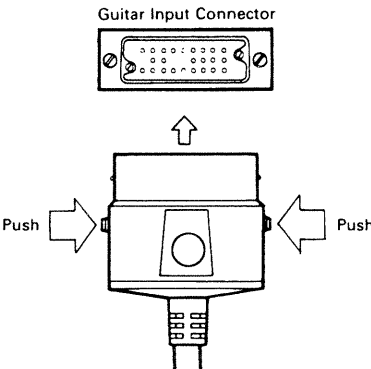

● Stereo Output Jack

Through this jack, the signal fed into the Stereo Input Jack is sent out. The signal fed into R is sent out through R, and that of L through L. When the Guitar Output Jack is not used, this jack sends the mixed sound of the sound module and the guitar's normal sound.

The ideal speakers to be used are PA or keyboard speakers.

● Pedal Jack

FS1 : Connect a pedal switch such as DP-2.

FS2 : Connect a pedal switch such as DP-2.

FCV : Connect the Expression Pedal EV-5.

Some of the functions can be

● Stereo Input Jack

Usually, the sound module is directly connected to an amplifier. However, if the volume of the sound module cannot be changed with the Volume knob on the guitar controller, connect the output jack of the sound module to the Stereo

● Guitar Output Jack

Through this jack, the guitar's normal sound is sent out. Connect a guitar amplifier to this jack. Please note that when this jack is being used, the Stereo Output sends out only the sound of the sound module.

Volume Knob and Balance Knob of the Guitar Control

○ **Volume Knob**

This controls the total volume of the guitar's normal sound and the sound module altogether. At its clockwise position, the highest volume is obtained.

○ **Balance Knob**

This controls the volume balance of the guitar's normal sound and the sound module. At its counterclockwise position, only the guitar's normal sound is heard.

These control knobs change the both volumes at a time: the MIDI volume sent to the sound module and the volume sent through the Stereo Output Jack. When the connected sound module can receive the MIDI Volume messages, connect the output jack of the sound module directly to the amplifier.

***Other knobs and switches can be assigned to various functions, therefore serve to play different roles. Refer to "Control Assign" on page 32.**

G-707's Controllers

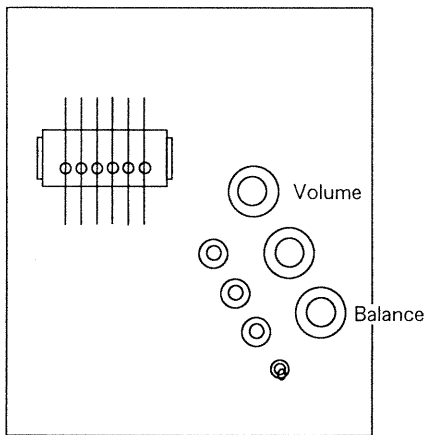

G-202, G-303, G-505 and G-808's Controllers

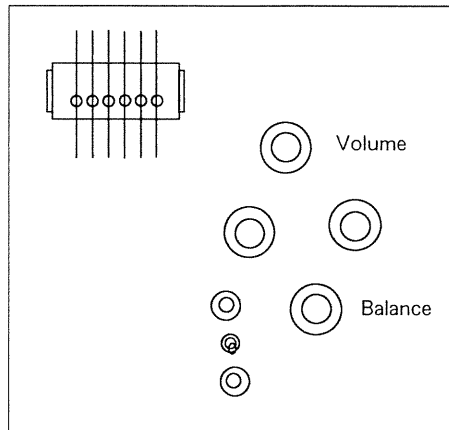

GK-1

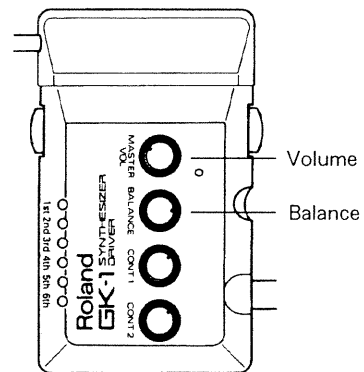

[1] BASIC OPERATION

The GM-70 is a guitar-MIDI converter that can convert the signals sent from the guitar controller into the MIDI signals. The signals sent from the guitar controller are converted into the MIDI signals in various forms through the GM-70, and the MIDI signal plays the connected MIDI sound module.

In other words, the main job you should do on the GM-70 is to determine how the guitar signal is to be converted into MIDI signal.

MIDI allows to control more than one sound module simultaneously by using different MIDI channels from 1 to 16. The GM-70 can select the MIDI Poly or MIDI Mono mode. The Poly mode allows to control more than one Key messages on one channel at a time, and the Mono mode allows one MIDI message on one channel. In the Poly mode, all the strings of the guitar are transmitted on a single channel, and in the Mono mode, six consecutive channels are assigned to the strings.

The Poly or Mono Mode should be correctly selected on the GM-70 depending on the external MIDI device.

***When using the GM-70 with a conventional MIDI keyboard (such as a synthesizer or electronic piano) or with a MIDI sound module (such as MKS-series), refer to the following section "Poly Mode".**

***When using the GM-70 with the sound module that allows to set more than six channels at a time (such as MKS-70, MKS-50), refer to "Mono Mode" on page 12.**

1. MIDI POLY MODE

a. Initialization

To initialize the GM-70 in the Poly mode, turn the unit on while holding the three buttons located at the upper left of the front panel.

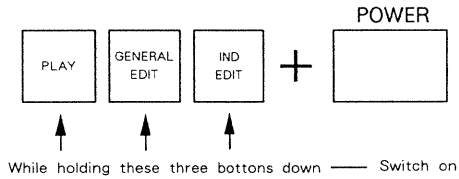

Now, the GM-70 defaults to its basic settings.

***Initialization is not needed from the second time you use the GM-70 in MIDI Poly mode.**

***Please note that initialization erases all the current data, replacing it with the preprogrammed data.**

Initialization in the Mono mode is explained on page 12.

***Default settings of the GM-70 are shown on page 42.**

b. Power-up

- ① **Make sure that the GM-70 is correctly set up with the external device.**
- ② **Turn on the sound module, the GM-70, then the other device such as an amplifier.**

When the GM-70 is turned on, the Display responds with:

ROLAND GM-70

In a few seconds, the Display changes to:

11 *SAMPLE- 1*

The GM-70 has a memory capacity that can retain up to 128 different Patches. The number shown at the left of the Display represents the number of the Patch currently selected, and the name of the Patch follows it.

When the above indication is shown in the Display, the GM-70 is in the Playing mode.

***The details on Patch and Patch Selections are explained on page 21.**

c. MIDI Channel Setting

To play the connected sound module with the GM-70, it is necessary to set the GM-70's MIDI transmit channel to the receive channel of the sound module.

The default MIDI channel of the GM-70 is 1. When the MIDI channel of the sound module is set to other than 1, change it to 1. As an alternative, change the MIDI channel of the GM-70 to the same number as the sound module as follows.

***When the MIDI channels are not set to the same numbers, no sound can be obtained.**

① Push the General Edit Button ②.

② Push the Function Switch ③ until the marked section of the Display flashes

1 A CH = 1 POLY

Flashing (Channel No.)

③ Using the Number Button ④, select the same MIDI channel number as the sound module's.

When the Number Button is pressed, dots appear at the right of the Display showing that it is now in the MIDI channel entering mode.

④ Push the Enter Button ⑤.

***Instead of the Number Button, the Value Button ⑦ can be used for selecting a MIDI channel. In this case, you do not have to push the Enter Button in the end. (This applies to the following procedures.)**

When step ④ is taken, three dots appear at the left of the Display, requiring to write the channel you have set.

⑤ Push the Write Button ⑥.

WRITE PATCH 11

Patch Number

The number shown at the marked section of the Display is the Patch Number (see page 21). The MIDI channel you set is written to the Patch Number shown in the Display. So, if necessary, change it to a different number (see page 32).

⑥ Push the Enter Button ⑥.

The Display responds with as shown below. This shows that the Protect function is working to protect the data previously written.

WRITE PROTECTED

Turn the Protect function off as follows.

⑦ Push the Write Button ⑥.

⑧ Push the Function Button ③.

⑨ Push the Value Button ⑦, and "Protect Off" is shown in the Display.

PROTECT=ON



PROTECT=OFF

Now, repeat the writing procedure :

⑩ Push the Function Button ⑥.

⑪ Push the Enter Button ⑬.

Writing is completed and the Display responds with as shown below.

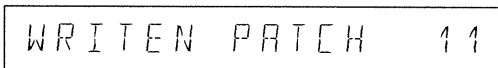

WRITEN PATCH 11

⑫ Taking the similar procedure as step ⑦ to ⑨, turn the Protect ON, then push the Play Button ①, returning to the Playing mode.

Now, the MIDI channel of the Patch shown in the Display is set, therefore, the sound module can be played by the guitar controller.

*If a chord cannot be played, it is likely that the sound module is set to the MIDI Mono mode. (If you are using the MKS -70, the Mono Mode Indicator is lit in the Mono mode). Change to Poly mode.

*After setting the MIDI Channel, go to "Level Adjustment of the Guitar Controller" on page 15.

2. MIDI Mono Mode

a. Initialization

To initialize the GM-70 to the Mono mode, turn the unit on while holding the three buttons located at the lower left of the front panel.

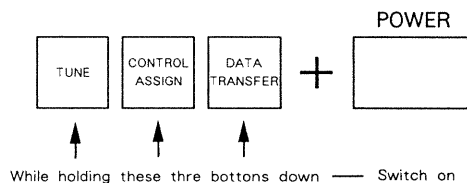

Now, the GM-70 defaults to its basic settings.

***Initialization is not needed from the second time you use the GM-70 in MIDI Mono mode.**

***Please note that initialization will erase all the current data, replacing it with the preprogrammed data.**

Initialization in the Poly mode is shown on page 9.

***Default settings of the GM-70 are shown on page 42.**

b. Power-up

① **Make sure that the GM-70 is correctly set up with the external device.**

② **Turn on the sound module, the GM-70, then the other device such as an amplifier.**

When the GM-70 is turned on, the Display responds with :

ROLAND GM-70

In a few seconds, the Display changes to :

11 *SAMPLE- 1*

The GM-70 has a memory capacity that can retain up to 128 different Patches. The number shown at the left of the Display represents the number of the Patch currently selected, and the name of the Patch follows it.

When the above indication is shown in the Display, the GM-70 is in the Playing mode.

***The details on Patch and Patch Selection are explained on page 21.**

c. MIDI Channel Setting

To play the connected sound module with the GM-70, it is necessary to set the GM-70's MIDI transmit channel to the receive channel of the sound module.

In the Mono mode, each string uses a different channel, therefore uses altogether six channels. The MIDI channel you set is assigned to the 1st string, that plus one is automatically assigned to the 2nd string, that plus two to the 3rd string, and so on. For instance, if you set the MIDI channel 5, channel 5 is assigned to the first string, the channel 6 to the 2nd string, and so on up to the channel 10 to the 6th string.

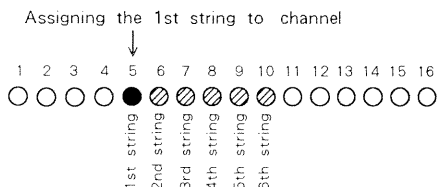

*The channels available are from 1 to 16. This fact restricts the channel number assignable to the 1st string to smaller than 12.

The default MIDI channel assigned to the 1st string is 1.

When using the sound module that features MIDI Mono mode, such as MKS-70 or MKS-50, set the MIDI channel of the sound module to 1, and the MIDI mode to Mono. This will automatically assign the six strings to 1 to 6 channels.

When using the device that allows to set more than six channels at a time, set all the channels to appropriate numbers.

To change the MIDI channels on the GM-70, take the following steps.

- ① Push the General Edit Button ②.
- ② Push the Function Button ③ until the marked section of the Display flashes.

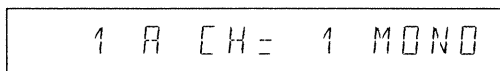

Flashing (Channel No.)

- ③ Select the MIDI channel number you want by using the Number Button ④.

When the Number Button is pushed, a flashing dot appears at the right of the channel number, showing that it is now in the MIDI channel entering mode.

- ④ Push the Enter Button ⑤.

*In stead of the Number Button, the Value Button can be used for selecting a MIDI channel. In this case, you do not have to push the Enter Button in the end. (This applied to the following procedures.)

When step ④ is taken, three dots appear at the far-left of the Display, requiring to write the channel you have set.

- ⑤ Push the Write Button ⑥.

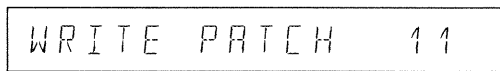

Patch Number

The number shown at the marked section of the Display is the Patch Number (see page 21). The MIDI channel you set will be written to the Patch Number shown in the Display. So, if necessary, change to a different number (see page 32).

⑥ Push the Enter Button ⑬.

The Display responds with as shown below. This shows that the Protect function is working to protect the data previously written.

```
WRITE PROTECTED
```

Turn the Protect function off as follows.

⑦ Push the Write Button ⑭.

⑧ Push the Function Button ⑮.

⑨ Push the Value Button ⑰, and "Protect Off" is shown in the Display.

```
PROTECT=ON  
↓  
PROTECT=OFF
```

Now, repeat the writing procedure :

⑩ Push the Function Button ⑮.

⑪ Push the Enter Button ⑬.

Writing is completed and the Display responds with as shown below.

```
WRITEN PATCH 11
```

⑫ Taking the similar procedure as step ⑦ to ⑨, turn the Protect ON, then push the Play Button ① returning to the Playing mode.

Now, the MIDI channel of the Patch shown in the Display is set, therefore, the sound module can be played by the guitar controller.

*If a chord cannot be played, it is likely that the sound module is set to the MIDI Mono mode. (If you are using the MKS-70, the Mono Mode Indicator is lit in the Mono mode). Change to Mono mode.

3. ABOUT THE GUITAR

In this section, you can adjust the height of the divided pickup and the output level of the guitar controller. These will change the nuance of the sound, and also affect the tracking level.

a. Adjusting the Divided Pickup

When using the Roland G-series guitar, adjust the height of the divided pickup with a driver as shown in the picture.

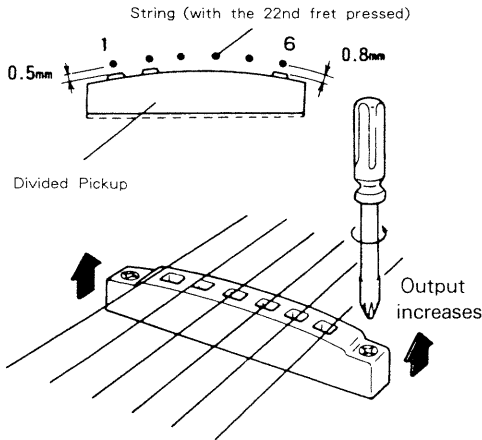

When using the Roland GK-1, check if the divided pickup is 0.5mm high from the strings with the highest fret pressed.

How to install the GK-1 to the guitar is explained in the operation manual of the GK-1.

b. Adjusting the Output Volume

When using the Roland G-series Guitar, remove the cover from the bottom of the guitar, and adjust the volume of each string by rotating the output adjusting knob with a driver.

● G-202

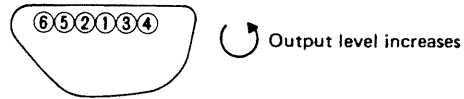

● G-303, 808

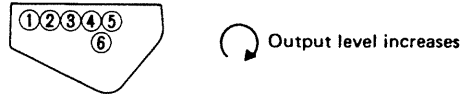

● G-505



● G-707

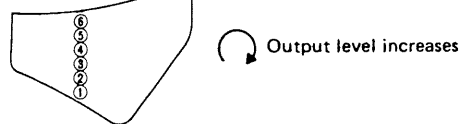

When using the Roland GK-1, adjust the volume using the supplied driver.

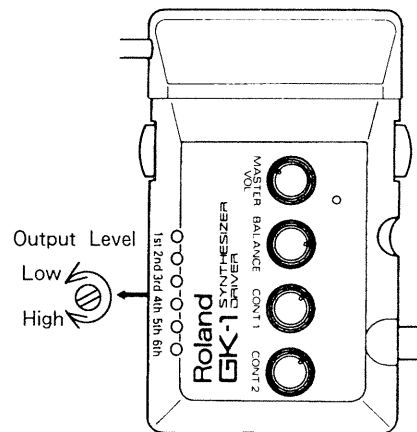

Adjust the level of each string. The optimum level is where the red part of the Level Indicator ⑤ lights up by playing the guitar most strongly.



LEVEL

The appropriate output level varies depending on the playing manner, the type of guitar or the gauge of the strings. After adjusting it as instructed above, you may change it again while actually listening to the sound module.

4. TUNING

In this section, you set the pitch of A (standard pitch), then tune the guitar to it.

① Push the Tune Button ⑩.

The Display responds with:

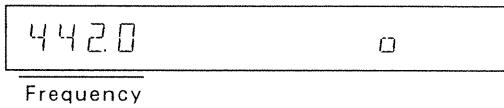

Tuning to the standard pitch

② Using either the Value Button ⑦ or the Number Button ⑧, set the standard pitch.

The pitch is variable from A=430.0 to 450.0Hz in 0.1Hz steps.

When using the Number Button to set the pitch, enter from the center figure. For instance, to set 442.0, enter 4, 2, then 0, and push the Enter Button.

Now, playing the guitar will show the corresponding key number in the Display. # represents "+".

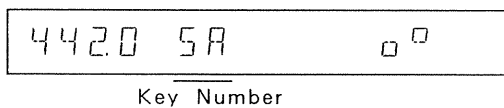

③ Adjust the pitch of the guitar so that the point at the upper line of the Display should meet the lower point (making 8 shape).

If it is not desirable to change the pitch of the guitar, such as when the guitar is finely tuned to the piano.

② While playing the guitar, change the pitch with the Value Button ⑦ until 8 shape is made in the Display.

When tuning is completed, push the Play Button ① to return to the Playing mode.

The set pitch is automatically written into memory, therefore retained even after the GM-70 is turned off.

* When you have completed tuning on the GM-70, tune the connected sound module to the guitar.

5. FUNCTION SETTINGS

The following parameter settings are necessary for usual performance.

The parameter settings should always be done with the General Button **2** turned on (LED ON).



***After all the necessary parameter settings are completed, please be sure to write them into memory as explained in the end of this chapter.**

a. Setting Each Parameter

● Bend Range

This parameter can select whether the guitar's choking or tremolo arm effect should change the pitch of the sound module like the guitar's choking effect, or in semi-tone steps.

To change the pitch of the sound module in the same curve as the guitar's, set the Bend Range at the highest value of the sound module, then set the GM-70's Bend Range to the same value. The value can be changed in semi-tone steps.

***The pitch that exceeds the set Bend Range will be substituted by the highest pitch.**

To change the pitch in semi-tone steps, set the value of the Bend Range to zero. This is called Chromatic mode which can be effectively used for not changing the pitch of the sound module continuously by the guitar's choking, therefore ideal when using piano sound.

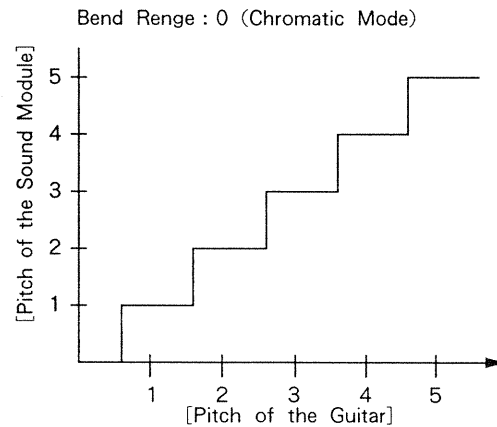
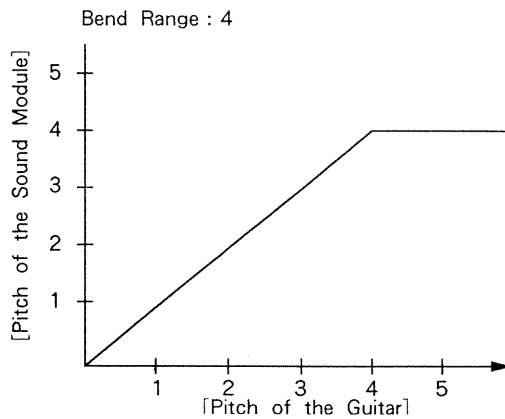

***When the GM-70 is in the Poly mode, the choking effect is applied to the sound module if the guitar is played in single tone, but playing more than one strings at a time will automatically turn to the Chromatic mode.**

① Push the Function Button **6** until the Display responds with as below.

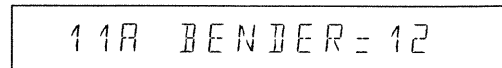

The number shown at the left of the Display represents the Patch number and the alphabet next to it is the Branch (see page 23). The number at the right of the Display is the value of the Bend Range. Here, leave the Patch number and the Branch as they are, and change the value of the Bend Range only.

- ② Using the Number Button ⑧ or Value Button ⑦, select the value of the Bend Range you like, then push the Enter Button ⑩.

7

11A BENDER = .7

ENTER

11A BENDER = 7

● Volume

This sets the volume of the sound module with the guitar's volume set to its maximum. 0 to 99 are valid, higher value increasing the higher volume. At 0, the sound module does not play at all.

*If the MIDI Volume of the sound module is set to OFF, or it does not receive the MIDI Volume message, the Volume set here does not affect the volume of the sound module.

- ① Push the Function Button ⑥ until the Display responds with as below.

11A LEVEL = 99

- ② Using the Number Button ⑧ or the Value Button ⑦, select the value you want, then hit the Enter Button ⑩.

● Program Change Number

This selects which voice on the sound is to be played.

When a Patch on the GM-70 is selected, the Program Change number (1 to 128) is sent to the sound module selecting the corresponding voice on the sound module.

*Please be sure to set the Program Change of the sound module to ON.

The Program Change numbers do not necessarily correspond to the Patch numbers on the sound module.

- ① Press the Function Button ⑥ until the Display responds with as below.

11A PROGRAM = 1

- ② Using the Number Button ⑧ or the Value Button ⑦, select the number you like, then push the Enter Button ⑩.

*To transmit a different Program Change number to each string (in the MIDI Mono mode), refer to "Individual Editing" on page 28.

b. Writing into Memory

The edited data can be written into a memory location (Patch number). Unless an appropriate writing procedure is taken, the edited data will be automatically erased by selecting a different Patch or by turning the unit off.

① Push the Write Button ⑭.

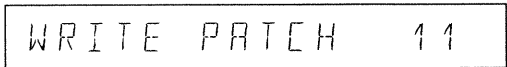

Patch Number

The marked section in the Display represents the Patch number (see page 21). The data will be written into the Patch number shown in the Display, so change it by using the Number Button ⑧ if necessary (see page 32).

② Push the Enter Button ⑯.

Here, the Display responds with as below. This shows that the Protect function is ON to prevent accidental erasure of the data.

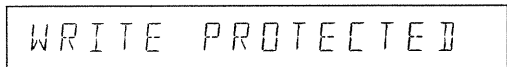

* The GM-70's Protect function is automatically turned to ON when powered up.

Turn the Protect OFF as follows.

③ Push the Write Button ⑭.

④ Push the Function Button ⑥.

⑤ Select Protect OFF with the Value Button ⑦.

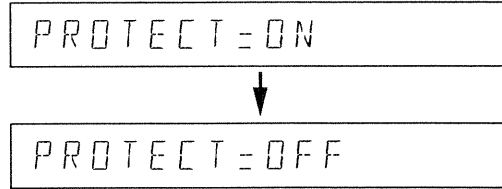

Now, repeat the writing procedure :

⑥ Push the Function Button ⑥.

⑦ Push the Enter Button ⑯.

When the writing is completed, the Display responds with :

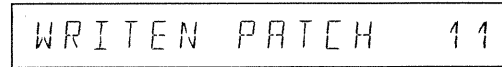

⑧ By taking the similar procedures as steps ③ to ⑤, turn the Protect to ON, then return to the playing mode by pushing the Play Button ①.

6. PATCH SELECTION

The GM-70 can retain up to 128 different Patches. When a Patch on the GM-70 is selected, the Program Change number (1 to 128) is sent to the sound module selecting the corresponding voice on the sound module.

Also, the Mode message is sent to the sound module changing the mode of the sound module.

Patch selection can be done in the playing mode. If the Play Button  is not lit, push it to turn to the playing mode, and the Display responds with :

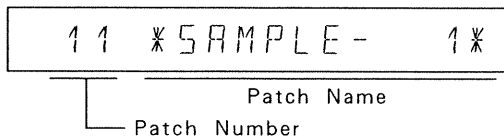

A Patch is shown in the Display as two figure number : the Bank (1 to 8) and Number (1 to 8). 128 Patches are divided into two groups A and B, each having 64 Patches. B Group Patches are shown with the "-" mark at the head, and no sign for the Group A Patches.

Patch Number Display

[Group A]
Number

Bank	A	1	2	3	4	5	6	7	8
1	11	12	13	14	15	16	17	18	
2	21	22	23	24	25	26	27	28	
3	31	32	33	34	35	36	37	38	
4	41	42	43	44	45	46	47	48	
5	51	52	53	54	55	56	57	58	
6	61	62	63	64	65	66	67	68	
7	71	72	73	74	75	76	77	78	
8	81	82	83	84	85	86	87	88	

[Group B] (-indication)
Number

Bank	B	1	2	3	4	5	6	7	8
1	-11	-12	-13	-14	-15	-16	-17	-18	
2	-21	-22	-23	-24	-25	-26	-27	-28	
3	-31	-32	-33	-34	-35	-36	-37	-38	
4	-41	-42	-43	-44	-45	-46	-47	-48	
5	-51	-52	-53	-54	-55	-56	-57	-58	
6	-61	-62	-63	-64	-65	-66	-67	-68	
7	-71	-72	-73	-74	-75	-76	-77	-78	
8	-81	-82	-83	-84	-85	-86	-87	-88	

Patch selection on the GM-70

- ① Using the Number Buttons, assign the Bank and the Number of the Patch you wish to select, then push the Enter Button ⑩
- ② Push the Minus Button ⑨ to select the Group you like.

Patch selection with the Foot Controller FC-100

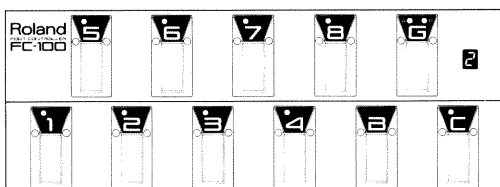

By using the Foot Controller FC-100, you can select any Patch on the GM-70.

- ① Connect the RRC OUT Connector on the FC-100 to the RRC IN Connector ⑩ on the GM-70 using the cable supplied with the FC-100.
- ② Set the MIDI IN/RRC IN Selector Switch ⑩ to the RRC IN position.
- ③ Set the Mode Selector Switch on the FC-100 to the II position.

*If the Mode Selector Switch is set to the I position, the FC-100 does not work properly.

- ④ Using the Number Pedal, the Bank Pedal and the Group Pedal of the FC-100, select the Patch you like.

*Please read the owner's manual of the FC-100 to study how the pedals function.

*When the FC-100 is set up with the GM-70, the FC-100's Display shows Group A, and the indicator of the Bank 1 and Number 1 are lit. This Patch number (A-11) is not sent to the GM-70. Select a Patch to be sent by pressing the corresponding Pedals on the FC-100.

*If you change the Patches without using the FC-100, the FC-100 does not indicate it.

*The Roland Expression Pedal EV-5 can be connected to the FC-100. You can assign desired functions to the Expression Pedal or to the Control Pedal on the FC-100. See page 32 "Control Assign"

Patch selection with the Pedal Switch (DP-2)

Initialize the GM-70 (as shown on page 9 and 12), and the Pedal Switch (es) connected to the FS1 Jack and/or the FS2 Jack serve to select a Patch on the GM-70.

The pedal switch connected to the FS1 Jack advances a Patch number and the one connected to the FS2 backs up one.

It is also possible to assign the Patch Selecting function to the Mode Switch of the G-series Guitar Controller. (See "Control Assign" on page 32.)

Program Change can also be used to select a Patch. (See "MIDI Program Change" on page 38.)

[2] ADVANCED OPERATION

1. PATCH EDITING

The GM-70 allows a guitar controller to play four sound modules simultaneously in different MIDI settings. For this, the GM-70 has four Branches where you can program MIDI settings.

The sound module that is set to the same channel as the Branch A is controlled by the Branch A, and the sound module that is set to the same channel as the Branch B is controlled by the Branch B and so on.

The messages are transmitted to the Branch A first, then B, then C and finally D. Therefore, the sound module of the Branch D receives the messages slightly later than A. So, it may be a good idea to use the Branch A for piano or percussive sound which requires strictly low tracking response.

To avoid unnecessary communication of the messages, please turn the unused Branches OFF. (See page 26.)

*Initializing the GM-70 (see page 9 and 12) will automatically turn the Branches B, C and D OFF.

Up to four Branches can be set in a Patch, and each Branch consists of various functions (parameters). Some functions can be set for all the strings and some can be set for each string individually (refer to the picture shown at the bottom of this page).

To edit the function which is set for all the strings, push the General Edit Button ②. This is called General Editing. To edit the function which is set individually for each string, push the Individual Edit Button ③. This is called Individual Editing.

By pushing both the General Edit and the Individual Edit Buttons simultaneously, the name of the Patch can be changed.

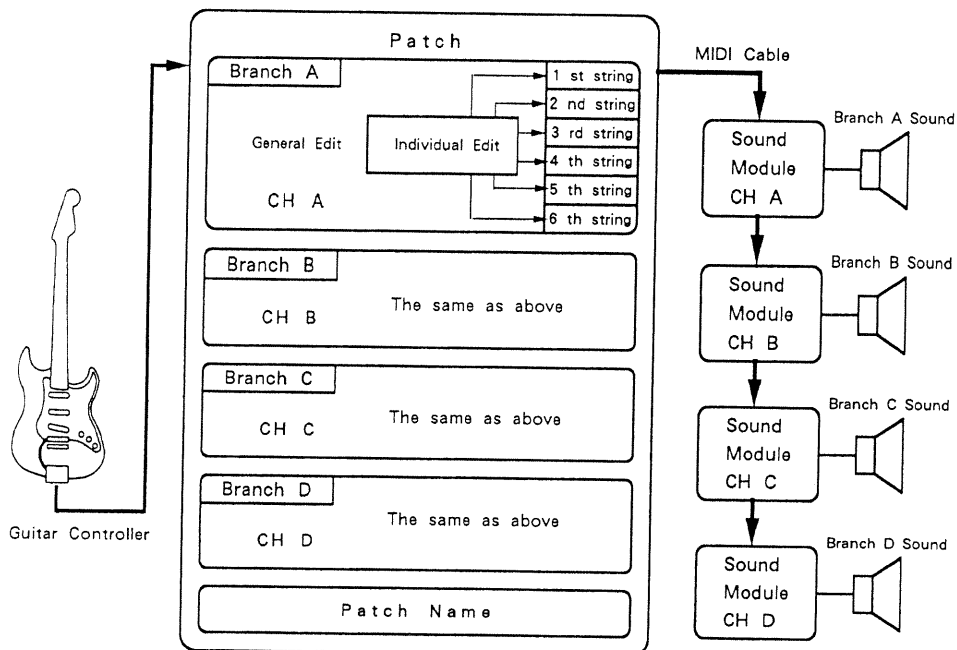

To edit a function, you can use the Number Button ⑧ or the Value Button ⑦.

*The default Patches obtained by initialization are shown on page 42.

During Patch editing, three dots appear at the left of the Display. The edited data will be erased by calling a different Patch, unless an appropriate writing procedure is taken. If you wish to retain the data, be sure to write it into memory as shown in "Writing into Memory" on page 32.

a. General Editing

The General editing allows you to edit the following functions in each Branch.

- Mode and Channel
- Bend Range
- Velocity Curve
- Level
- Program Change Number

Push the General Edit Button ② and make sure that the indicator lights up.

1) Calling Each Function

①Push the Function Button ⑥ until the Display responds with :

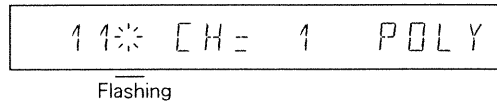

②Using the Value Button ⑦, select the Branch to be edited.

③Pushing the Function Button, call the function you wish to change.

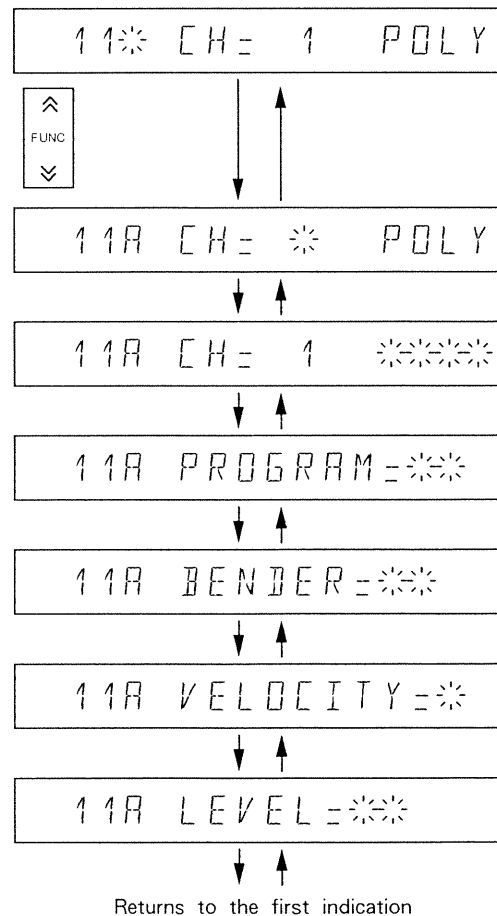

If you wish to change the Branches without changing the functions, do as follows.

① By pushing the Function Button ⑥, select the function you wish retain.

② While holding the General Edit Button ② down, push the Play Button ①.

[If "Bend Range" is selected in step ①]

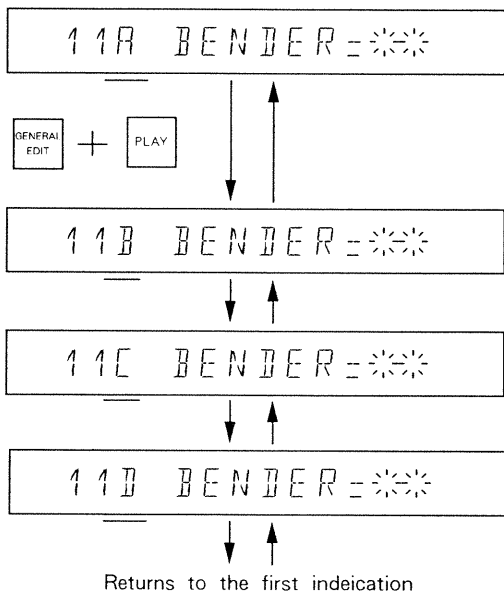

2) Editing the Function

● Mode and Channel

MIDI Poly mode or Mono mode can be set separately for each Branch.

When the Mono mode is selected, the channel number assigned to the 1st string should be set. The following numbers will be automatically assigned to the 2nd to the 6th strings. In other words, one Branch uses 6 channels in the Mono mode. For instance, setting the channel number of the first string to 5 will automatically determine the following strings as shown below.

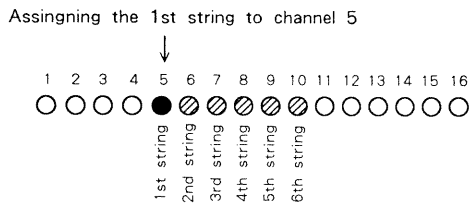

[NOTE]

Depending on the sound module used, the modes available vary. If the wrong MIDI mode is selected, the units do not operate properly.

*OMNI Mode is fixed to OFF.

One MIDI channel can be used only once in a Patch. In other words, it is not possible to use all the four Branches in the Mono mode, because the total number of the MIDI channels available is only 16. One Branch uses 6 consecutive channel numbers, so it is not possible to use all the four Branches in the Mono mode. You can set some of the Branches to the Poly mode that uses one MIDI channel.

You can monitor how the 16 MIDI channels are used in a Patch :

- ① Push the Function Button until the following indication is shown in the Display.

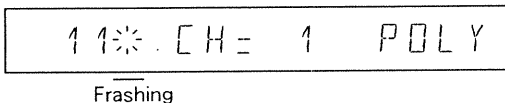

- ② Push the Value Button until the Display responds with as shown below.

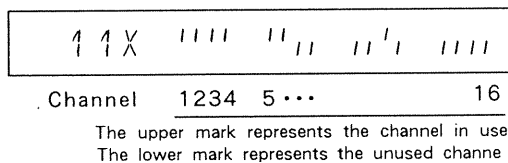

The segments shown in the Display represent the MIDI channel numbers 1 to 16 from left to right. The upper segments represent the channels currently in use, and the lower ones are unused channels.

Channel Setting

- ① By using the Value Button, select the Branch whose MIDI channel setting you wish to change.

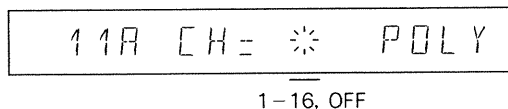

- ② Using the Number Button or the Value Button, select the channel number you like and push the Enter Button.
- ③ Turn the channel of the unused Branch to OFF by pushing the Number Button "0", then the Enter Button.

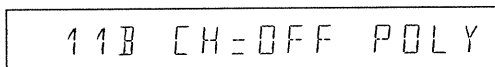

When the channel is OFF, there is no message sent from that Branch.

Mode Setting

- ④ Push the ^ side of the Function Button until the right of the Display flashes as follows.

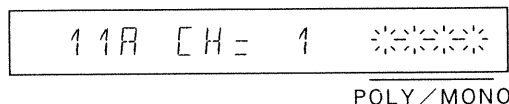

- ⑤ Using the Value Button, select the Mono or Poly mode.

When you change the channels or change the Poly mode to Mono, it may happen that the channel (s) has already been used for other Branch. If this happens, the Display shows the error indication as shown below.

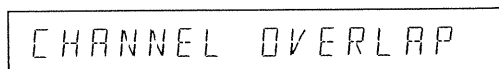

Pushing the Value Button while the above error indication is being shown will automatically select an unused channel. However, unless 6 consecutive numbers are empty for the Mono mode Branch, the channel is set to OFF. This case, re-arrange the channel settings, and try again.

In the Mono mode, more than 12 channels cannot be assigned to one string.

If you assign more than 12 channels to a Mono mode Branch or change from the Poly to the Mono mode when a Branch is using more than 12 channels, the following error indication is shown in the Display.

SETTING ERROR

● **Bend Range**

The details on Bend Range is explained on page 18.

[NOTE]

When the Bend Range is set to other than 0, enormous amount of the messages will be transmitted each time you play the guitar. This means that the memory will be full very easily when recording in a sequencer, etc.

1 1A BENDER = **

1-64

Select the value you like by using the Number Button or the Value Button, then push the Enter Button.

● **Velocity Curve**

Select one of the five Velocity Curves preprogrammed in the GM-70.

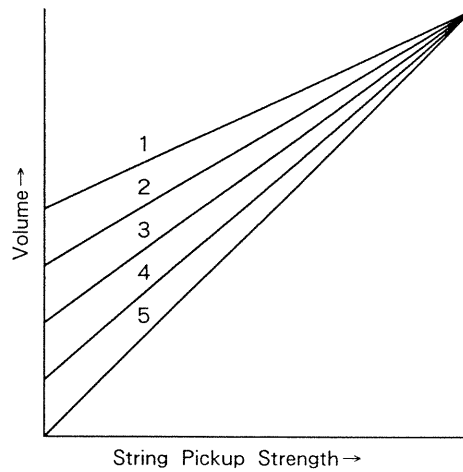

1 1A VELOCITY = *

1-5

Using the Value Button ⑦ or the Number Buttons ⑧, select the number which you find most comfortable.

● **Level**

This sets the MIDI volume transmitted when the volume of the guitar is highest. Select the level depending on the volume of the other Branch or Patch.

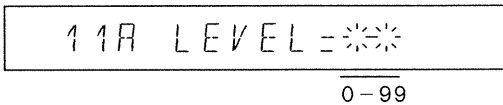

Using the Number Buttons or the Value Button, select the value you like, then push the Enter Button.

● **Program Change Number**

The Program Change Number (1 to 128) set here controls all the 6 strings. So, there is no problem in Poly mode, but if you wish to send different Program Change numbers from the six strings in Mono mode, go to the following section "Individual Editing".

Select the number you like with the Number Buttons or the Value Button, then push the Enter Button.

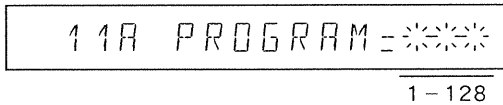

b. Individual Editing

The Individual Editing function allows to set the following functions individually in each Branch.

On/Off (String Selection)

Transpose

Program Change Number

Push the Individual Edit Button **Ⓢ**, and make sure that the indicator lights up.

The Display shows the functions set in each string.

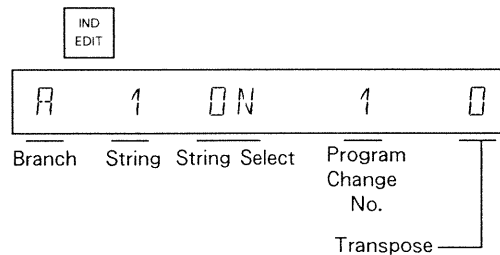

1) Calling a Function

① Push the Function Button ⑥ until the marked section in the Display flashes.

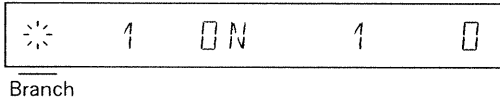

② Select the Branch to be edited by using the Value Button ⑦.

③ Push the ^ side of the Function Button until the marked section in the Display flashes.

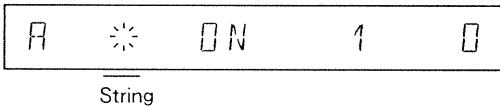

④ Using the Value Button, select the string whose function you wish to change.

⑤ Push the Function Button until the desired function flashes.

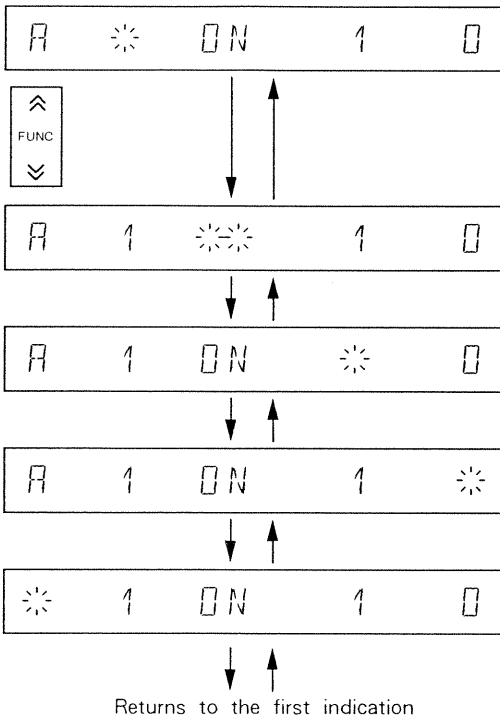

You can change Branches without changing the functions.

① Push the Function Button ⑥ until the desired function flashes.

② While holding the Individual Edit Button ③ down, push the Play Button ①.

The same function of the next Branch will flash.

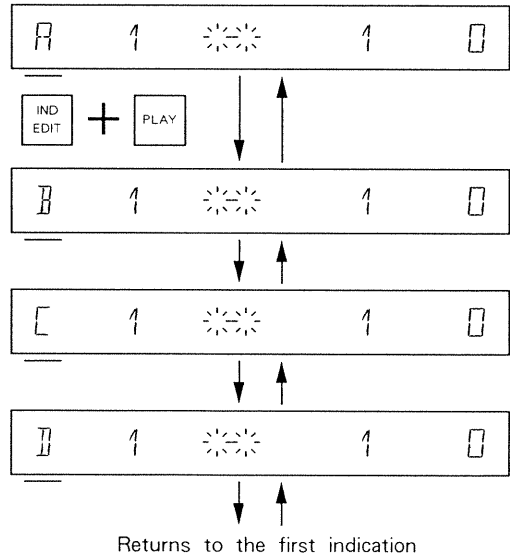

You can change strings without changing the functions.

① Push the Function Button ⑥ until the desired function flashes.

② While holding the Individual Edit Button ③ down, push the Copy Button ④.

The same function of the next string is now flashing.

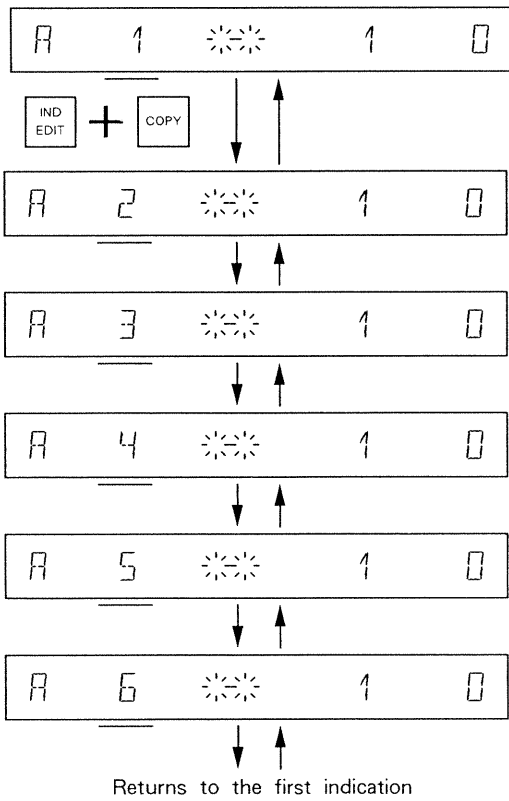

2) Editing the Function

● String Select

This selects whether to transmit the Note message of the string. Usually, this should be set to ON. OFF setting mutes the string, therefore is useful for when using more than one Branches.

*Even when the String Select is set to OFF, the Program Change number is transmitted.

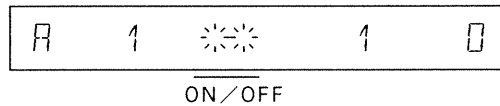

Select ON or OFF with the Value Button.

● Transpose

This can shift the pitch of the sound module upper or lower than the guitar's sound in semi-tone steps from -36 to +36.

The GM-70 can transmit the key numbers from -1C to 9G. If the transposed pitch exceeds this range, the highest or the lowest octave substitutes it:

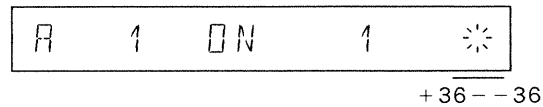

Select the number you like with the Number Button or the Value Button, then push the Enter Button. + or - can be selected with the Minus Button.

● **Program Change Number**

To control more than one sound module in the Mono mode, Program Change number should be assigned to each string.

*In Poly mode, the Program Change number assigned to the first string is automatically transmitted.

*The number shown in the Display is the Program Change number assigned to the first string.

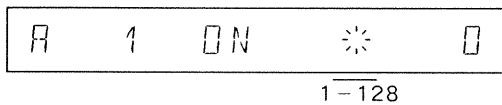

Select the number you like with the Number Button or the Value Button, then push the Enter Button.

3) String Copy

The data set on a string can be copied to other strings. This function is useful for making several strings of the same settings.

The copy function copies the string setting shown in the Display to the lower strings. For instance, if the Display shows the first string, pushing the Copy Button ④ will change the Display to as below, making all the strings 1 to 6 to the same settings.

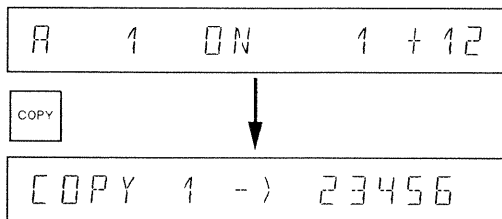

The 1st to 6th strings are ON. Program Change number : 1 and Transpose : 12

To make the 4th, to 6th strings to the same settings, call the 4th string in the Display, and push the Copy Button.

The Display responds with :

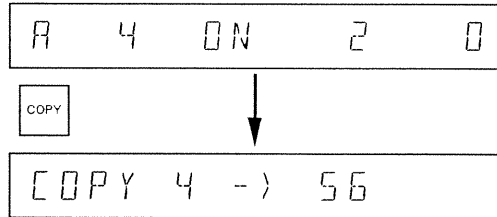

The 1st to 3rd strings remain unchanged .
The 4th to 6th strings are set to Program Change number : 2 and Transpose : 0 .

c. Patch Renaming

You can name a Patch with up to 12 letters.

①Push the General Edit Button ② and the Individual Edit Button ③ at a time.

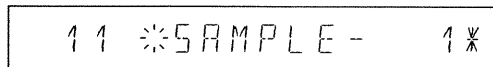

The first letter flashes.

②Move the flashing section to where you wish to change the letter by using the Function Button ③.

③By using the Value Button ⑦, change the letter.

You can use the Number Buttons to enter a number, the Minus Button for "-", and the Enter Button for a space.

2. Patch Writing

The edited Patch can be written into memory.

① Push the Write Button **Ⓚ**.

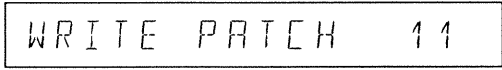

Patch Number

② Select the Patch to be written by pushing the appropriate Number Buttons **Ⓝ** and select Group A or B with the Minus Button **Ⓣ**.

③ Push the Enter Button **Ⓛ**.

If the Display shows as follows, turn the Protect OFF (see page 20), then repeat the writing procedure.

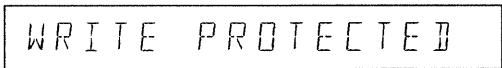

3. Control Assign

The Control Assign function allows to assign different functions (parameters) to the knobs and switches on the Guitar Controller or to the connected pedals.

a. Assignable Controllers

1) Controls and switches of the Guitar Controller

	G- Series	GK-1
CV1	Cut off Frequency Knob	Controller Knob 1
CV2	Resonance Knob (Edit Knob)	Controller Knob 2
CV3	—	—
CV4	Vibrato Depth Knob	—
SW1	Mode Switch I	—
SW2	Mode Switch III	—

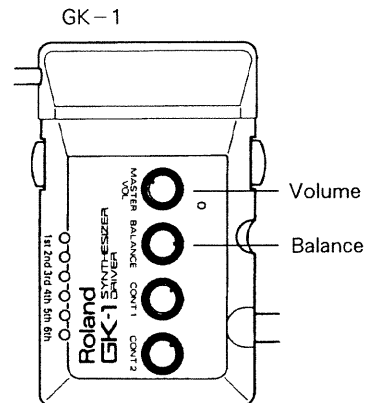
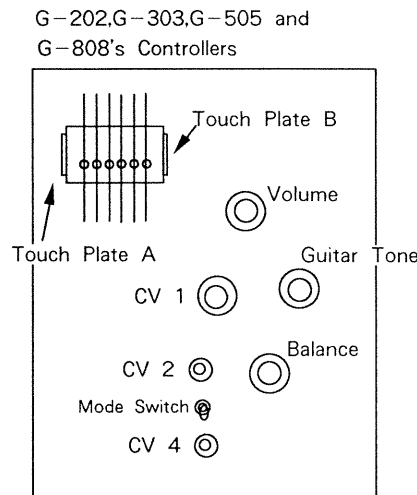
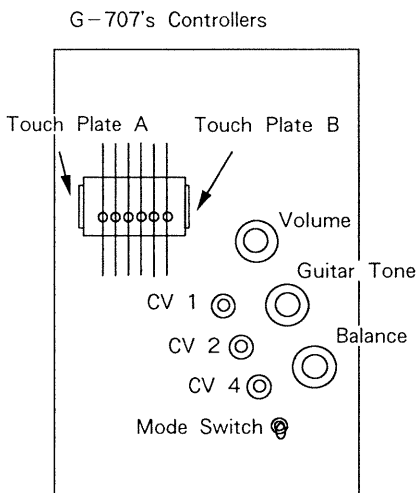

When the control on the guitar is set to the fully counterclockwise position, the value of the CV1, CV2 or CV4 is zero, and at the clockwise position, the value is its maximum. The CV4, however, is not turned on unless you touch the touchplate. The touchplate B is on while it is being touched, and off when released. The touchplate A is turned on when touched and turned off when the touchplate B is touched and released.

The Mode Switch can be set to I, II or III position. At I (lower) position, SW2 is on, and at III (upper), the SW2 is on.

2) The Expression Pedal (EV-5) and the Pedal Switch connected to the GM-70

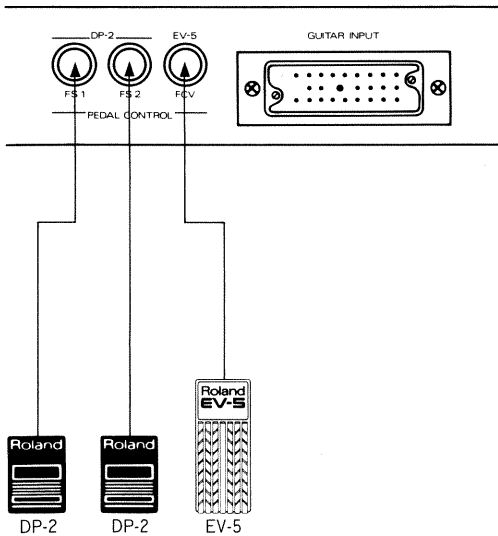

Disp	Controller
FCV	Expression Pedal (EV-5) Connected to the FCV Jack on the GM-70
FS1	Pedal Switch (DP-2) Connected to the FS1 Jack on the GM-70
FS2	Pedal Switch (DP-2) Connected to the FS2 Jack on the GM-70

3) Control Pedal of the Foot Controller FC-100 and the Expression Pedal (EV-5) connected to the Foot Controller FC-100

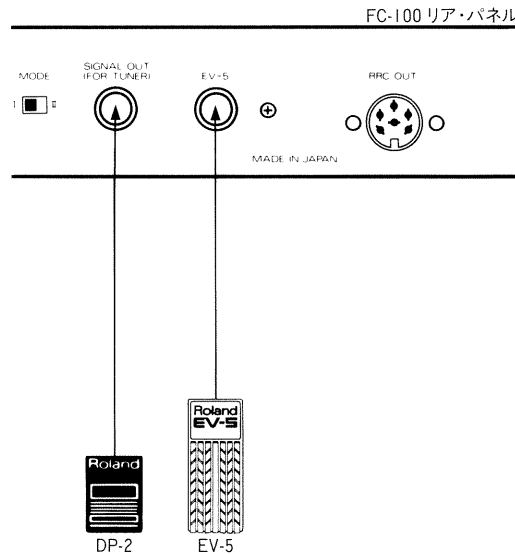

Disp	Controller
RCV	Expression Pedal (EV-5) Connected to the FC-100
RSW	Control Pedal of the FC-100

b. Assignable Functions

1) Control Change

Different MIDI Control Change numbers can be assigned to the Controllers which therefore transmit different Control Change messages to the GM-70.

A rotary-knob type controller transmits the corresponding value, and a switch type controller transmits the highest value at ON, and the lowest value at OFF.

The following table shows the Control numbers and the function description.

***When the Control Change 7 (Main Volume) is assigned, the value (volume) is transmitted when the unit is turned on or when a new Patch is selected. When any other function (including the ones of the following section) is assigned, the value will not be sent unless the relevant Controller is moved.**

C 1	MOD	Modulation Depth	C42	PAN	Panpot
C 2	BRETH	Breath Controller	C43	EXPRS	Expression
C 4	FOOT	Foot Controller	C48	GEN-1	General Controller 1
C 5	PTIME	Portamento Time	C49	GEN-2	General Controller 2
C 6	DATA	Data Entry	C50	GEN-3	General Controller 3
C 7	VOL	Main Volume	C51	GEN-4	General Controller 4
C 8	BALAN	Balance Control	C64	HOLD1	Hold 1
C10	PAN	Panpot	C65	PORTA	Portamento
C11	EXP	Expression	C66	SOSUT	Sostenuto
C16	GEN-1	General Controller 1	C67	SOFT	Soft Pedal
C17	GEN-2	General Controller 2	C69	HOLD2	Hold 2
C18	GEN-3	General Controller 3	C80	GEN-5	General Controller 5
C19	GEN-4	General Controller 4	C81	GEN-6	General Controller 6
C33	MOD	Modulation Depth	C82	GEN-7	General Controller 7
C34	BRETH	Breath Controller	C83	GEN-8	General Controller 8
C36	FOOT	Foot Controller	C92	TREMO	Tremolo Depth
C37	PTIME	Portamento Time	C93	CHORS	Chorus Depth
C38	DATA	Data Entry	C94	CELES	Celeste Depth
C39	VOL	Main Volume	C95	PHASE	Phaser Depth
C40	BALAN	Balance Control			

2) Other Functions

To a rotary-knob type controller (CV1 to CV4, FCV, RCV), the following functions can be assigned as well as a Control Change.

● Pressure (Aftertouch)

This function sends the channel pressure value that changes depending on the position of the controller.

● Bender

This sends the pitch bend value that changes depending on the position of the controller. To assign this function to the controller other than CV3, mode selection is needed: UP mode raises the pitch and DOWN mode lowers the pitch.

*The range of the pitch bend varies depending on the Bend Range set in the sound module.

PRESS	Pressure
BEND	Bender

To a switch type controller (SW1,SW2,FS1, FS2, RSW), the following functions as well as a Control Change can be assigned.

● Sostenuato

The strings which are being played will be sustained by turning the Sostenuato on. Even while the sostenuto is on, you can play other strings (which are not sustained) without sostenuto effect.

● Octave Up

This transpose the sound currently played one octave upper.

● Patch Shift

Increment (INC)

Increment ON increases Patch numbers.

Decrement (DEC)

Decrement ON decreases Patch numbers.

SOS-S	Sostenute
8VAUP	Octave Up
PATCH	Patch Shift

c. Assigning Operation

① Push the Control Assign Button ⑫ and make sure that the indicator lights up.

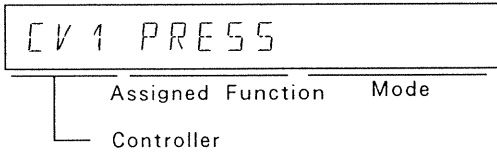

② Call the Controller (function) to be used by pushing the Function Button ⑥. (The assigned function flashes in the Display.)

The following procedure varies depending whether to assign a Control Change or other function.

1) To assign a Control Change

③ Assign the Control Change number by using the Number Buttons ③ and the Enter Button ⑬.

*The Control Change number not shown in the table on page 34 (e.g. 12 to 15, 41, etc.) can also be selected.

*Instead of the Number Buttons, you can use the Value Button if selecting a Control Change number shown in the table.

Pushing the Enter Button here will cause the Display to show the corresponding Control number.

2) Other Functions (after 96)

③ Call the desired function by pushing the \surd side of the Value Button ⑦.

"OFF" follows Control Changes then the other functions follow.

Before taking the step ③, you can select "OFF" by pushing the Minus Button ⑨.

④ To select UP/DOWN of "BENDER", or INC/DEC of "PATCH SHIFT", cause the Mode section in the Display to flash with the Function Button, then use the Value Button.

*To avoid any confusion in operation, turn all the unused controllers "OFF" with the Minus Button.

d. Controller Operation Mode

You can select the optimum Controller operation mode when using a switch type controller or CV3 (Bender Arm).

1) Switches

A switch can be set to Latch or Unlatch mode.

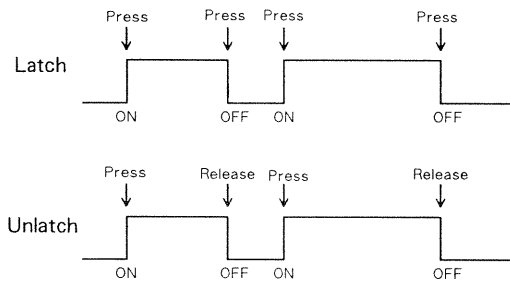

In the Latch mode, the function is turned on when the pedal is pushed, and remains on until the pedal is pressed again. When using a switch of a guitar, the function is on from the moment the switch is pushed down and returned upright to the moment it is pushed down again.

In the Unlatch mode, the function is on while the pedal is being pressed and turned off when the pedal is released. When using a switch of a guitar, the function is on from the moment the switch is pushed down till it is returned upright.

You can select UNLATCH or LATCH when the function other than Patch Shift is assigned to a switch (SW1,SW2,FS1,FS2,RSW).

After you have assigned the desired function, push the \wedge side of the Function Button ⑥ once, then push the Value Button ⑦ until UNLATCH or LATCH whichever you like flashes.



2) Bender Arm (CV3)

When assigning the function other than Bender to the Bender arm on the guitar controller that can transmit Bender message, select either the ABSOLUTE or CENTER.

In the Absolute mode, value 0 is sent at the center position, and raising or lowering the bender arm sends the amount of message increased or decreased from the center position (zero).

In the Center mode, medium value is sent at the center position, and raising the bender arm increases the value and lowering it decreases.

After assigning the desired function to CV3, push the \wedge side of the Function Button ⑥ once, then push the Value Button ⑦ until ABSOLUTE or CENTER whichever you want flashes.

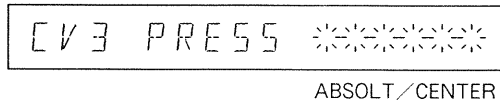

4. MIDI PROGRAM CHANGE RECEIVE

The Program Change sent to the MIDI IN can change the Patches on the GM-70.

The GM-70 features MIDI Receive channels for receiving Program Change. The GM-70's MIDI Receive channel should be set to the same number as the MIDI channel of the transmitter.

*The MIDI receive channels has nothing to do with the transmit channel of each Patch set in General editing.

*The MIDI Receive channel is always set to the OMNI OFF, Poly mode.

How to set the MIDI Receive Channel

- ① Push the Data Transfer Button **15** and make sure that the indicator lights up.
- ② Push the Function Button **6** until the Display responds with :

MIDI RX CH= 16

- ③ Select the desired channel number with the Number Button **3** or the Value Button **7**, then push the Enter Button **16**.

*The set MIDI receive channel is retained even after the unit is turned off, therefore writing procedure is not necessary.

Connecting to the transmitter

- ① Connect the MIDI OUT connector on the transmitter to the MIDI IN Connector **17** on the GM-70 by using the MIDI cable.
- ② Set the MIDI IN/REC IN Selector Switch **18** on the GM-70 to the "MIDI IN" position.

Now, the Program Change sent to the MIDI IN can change the Patches on the GM-70.

Received Program Chage No.	Selected Patch Number
1	1
.	.
.	.
64	88
65	-11
.	.
.	.
128	-88

*Program Change numbers sent to the GM-70 are not necessarily the same numbers as the Program Changes of the GM-70's Patches. So, the Program Change numbers sent from the GM-70 to the sound module may be different from the ones received.

5. DATA TRANSFER

Using the Roland MIDI System Exclusive Message, the data stored in a GM-70's memory can be transferred to other GM-70. Sending the data is called Bulk Dump, and reading the data is called Bulk Load.

You can transfer the entire or the part of data as shown below :

Data Group 11/88 :

Data of Group A

Data Group -11/88 :

Data of Group B

Data Group SYSTEM :

Data of Control Assignment

Data of MIDI Receive Channel

Data of Master Tune

Data Group ALL :

All of the above three data

a. Setting MIDI Receive Channel

The Exclusive message does not need channel setting, but the Roland System Exclusive message selects the receiver device by using the numbers called Device ID that substitutes channel numbers. The GM-70 uses the MIDI Receive Channel number for Device ID, therefore, the MIDI Receive Channel of the GM-70 and the receiver (sound module) should be set to the same number.

*How to set the MIDI receive channel is explained on the previous page.

b. Bulk Dump

Bulk Dump is transferring the data in a GM-70's memory to another GM-70.

First, make sure that the MIDI Receive channels of the transmitter and the receiver are the same number, then go to the following procedure.

① **Connect the MIDI OUT connector on the transmitter GM-70 to the MIDI IN of the receiver GM-70.**

② **Push the Data Transfer Button  and make sure the indicator lights up.**

③ **Push the Function Button  until the Display shows BULK DUMP.**

④ **Using the Value Button , select the data group to be transferred.**

All :

BULK DUMP=ALL

Patch Group A :

BULK DUMP= 11/88

Patch Group B :

BULK DUMP=- 11/88

System :

BULK DUMP=SYSTEM

⑤ Push the Enter Button **Ⓜ**, and the selected data group is transferred.

When bulk dump is completed, the GM-70 is returned to the playing mode.

* Bulk Dump All takes about 30 seconds, but System takes less than a second.

c. Bulk Load

Bulk load is reading the data from other GM-70 to the internal memory. The GM-70 can bulk-load only while the Display shows BULK LOAD.

First, make sure that the MIDI Receive channels of the transmitter and the receiver are set to the same number, then go to the following procedure.

① Connect the MIDI IN connector on a receiver GM-70 to the MIDI OUT of the transmitter GM-70 using the MIDI cable.

② Set the MIDI IN/RRC IN Selector Switch **Ⓜ** to the "MIDI IN" position.

③ Turn the Protect OFF.

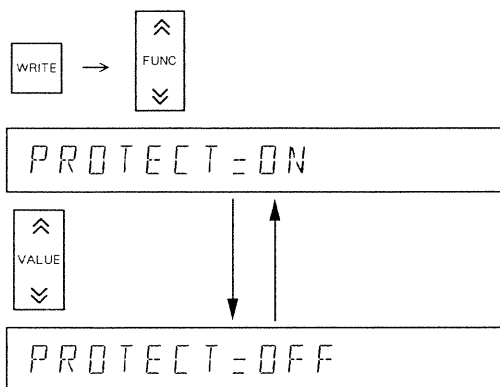

④ Push the Data Transfer Button **Ⓜ**, and make sure the indicator lights up.

⑤ Push the Function Button **Ⓜ** until the Display shows BULK DUMP.

When bulk-loading the Patch Group A or Patch Group B data, you can choose to which Patch Group (location) on the receiver it should be read. Select A or B using the Value Button **Ⓜ**.

Patch Group A :

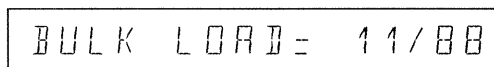

Patch Group B :

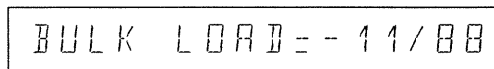

⑥ Push the Enter Button **Ⓜ** and the GM-70 is ready to read the data transferred.

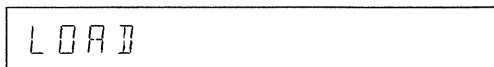

If the MIDI IN/RRC IN Selector Switch is set to the "RRC IN" position, the following error message is shown in the Display.

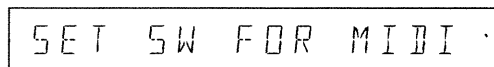

Set the switch to the MIDI IN position, and the GM-70 is ready to read the data transferred.

To stop data transfer, push any button on the panel. The Display shows as below and the unit is returned to the playing mode.

ABORT LOADING

When the data is transferred, it will be written into the internal memory. The Display shows where the transferred data is written.

LOAD

When ALL is received ↓

LOAD ALL

When data between two GM-70's are transferred, bulk-loading the Data Group All takes about 30 seconds, and System needs less than a second. If the Display does not change after waiting a minute, it is likely that something has gone wrong. Push any button on the panel to return to the playing mode.

If trouble occurs during data receiving, the following error message is shown in the Display.

DATA ERROR

Push any button on the panel to return to the playing mode.

When the bulk loading is completed, the unit is automatically returned to the playing mode.

⑦ Return the Protect to ON.

[3] SUPPLEMENT

1. DEFAULT VALUES BY SYSTEM INITIALIZATON

● Patch Setting

Function	Branch A	Branch B · C · D
Channel	1	OFF
Mode	POLY (Poly Mode Initialization) MONO (Mono Mode Initialization)	POLY
Bend Range	12	0 (Chromatic)
Velocity Curve	2	1
Level	99	99
Program Change No.	※	※
String Select	All Strings ON	All Strings ON
Transposes	All Strings 0	All Strings 0
Patch Name	SAMPLE- ※	

*See Patch and Number Table

● Program Change Number or Patch Name that Corresponds to the Patch Number

● Control Assign

	Assigned Function		Mode
CV1	Pressure (Aftertouch)		
CV2	Portamento Time	[C 5]	
CV3	Pitch Bender		
CV4	Modulation Depth	[C 1]	
SW1	Portamento	[C 6]	Unlatch
SW2	Octave Up		Unlatch
FCV	Pressure (Aftertouch)		
FS1	Patch Shift		Increment
FS2	Patch Shift		Decrement
RCV	Volume	[C 7]	
RSW	Hold 1	[C 6]	Unlatch

Patch Number	Program Change Number	Patch Name
11	1	SAMPLE 1
.	.	.
.	.	.
88	64	SAMPLE 64
-11	65	SAMPLE 65
.	.	.
.	.	.
-88	128	SAMPLE 128

● Other Function

Master Tuning	442.0 Hz
MIDI Receive Channel	16

2. MIDI OF THE GM-70

MIDI is an international standard which allows communication of musical performance by means of digital signals.

The GM-70 converts the signal sent from a guitar controller to MIDI signal in various ways. To make the best use of the GM-70, good comprehension of MIDI is required. The following explanation will greatly help you if thoroughly read.

a. Connection

The MIDI equipped instruments employ 5 pin DIN connectors which are indicated as "IN", "OUT" and "THRU" respectively. The MIDI OUT on the transmitter device should be connected to the MIDI IN of the receiver using the MIDI cable.

The GM-70 is a transmitter device. Connect the MIDI OUT to the MIDI cable, then connect the other end of the cable to the MIDI IN of the MIDI sound module or keyboard which is to be played with the MIDI messages.

MIDI THRU output is provided to send a direct copy of signal coming in MIDI IN. If you wish to play two sound modules with the GM-70, connect the MIDI THRU of the first sound module to the MIDI IN of the second one.

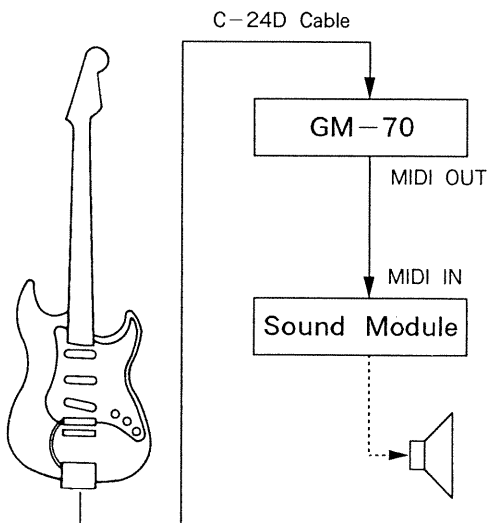
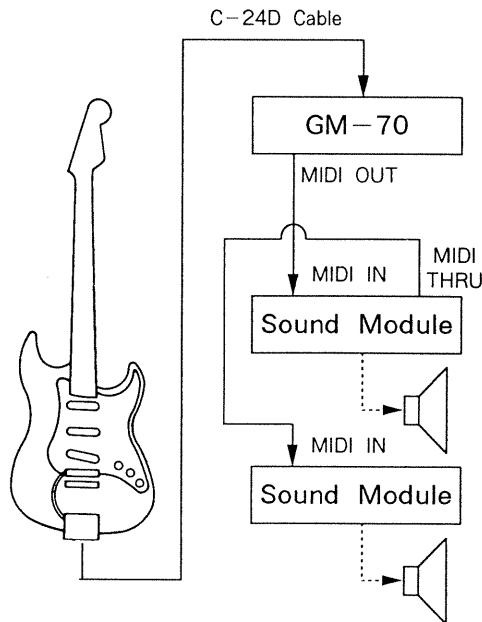

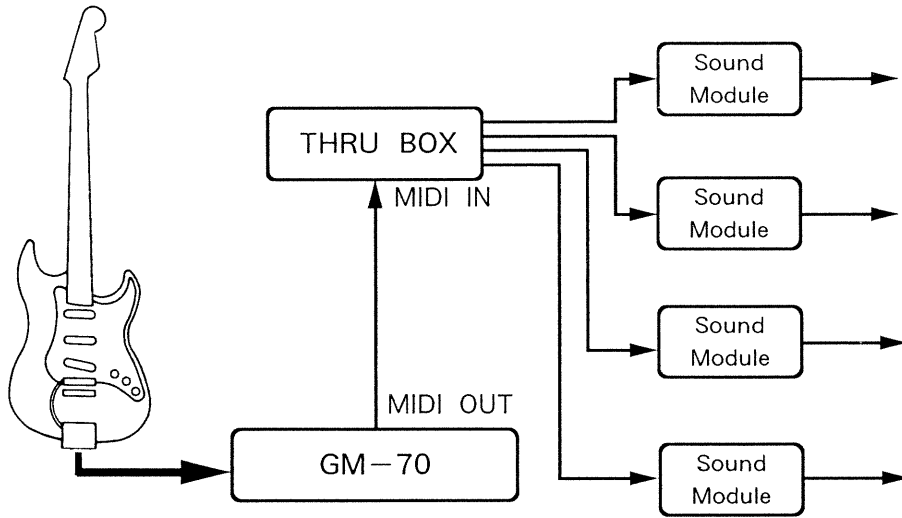

Theoretically speaking, as many MIDI devices can be connected through MIDI THRU's, but to avoid delay of the messages, use the MIDI THRU Box for connecting more than three or four devices.

b. Channels

A single MIDI cable can transmit different messages to several instruments.

This capability comes from the concept of channels: 16 channels from 1 to 16 available in MIDI. Depending on which channel of 1 to 16 is selected on the receiver device, the messages received differ. In other words, the receiver can choose to receive only the necessary messages from the transmitter (s).

The GM-70 has four Branches where four different MIDI channels can be set, therefore can control several sound modules at a time.

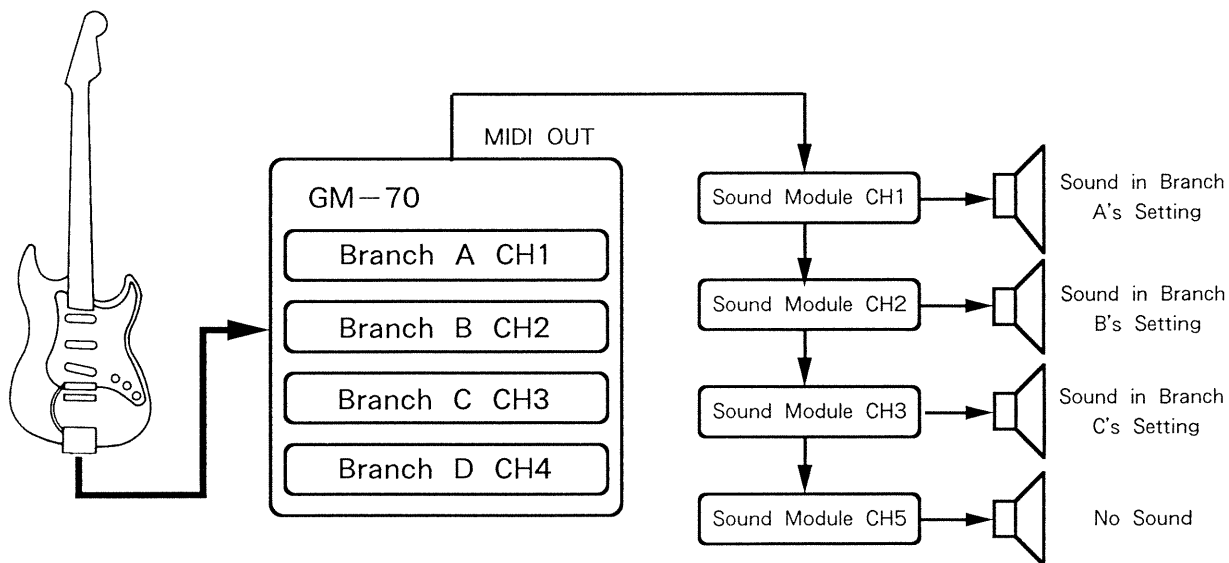

c. Modes

OMNI ON or OFF, and Poly or Mono are another important elements of MIDI.

There are four different combinations available :

OMNI ON, POLY
OMNI ON, MONO
OMNI OFF, POLY
OMNI OFF, MONO

In OMNI ON, the receiver recognizes the messages of all channels without discrimination. This mode is not used when using the GM-70. In the OMNI OFF mode, the receiver accepts the messages exclusively sent on a specific channel.

Poly mode uses only one channel, playing a chord with the messages sent on that channel. Usually a MIDI keyboard selects Poly mode.

Mono mode can play only one sound on one channel, but can use up to 6 channels at a time. The GM-70 uses the MIDI Mono mode, assigning different channels to the six strings. In this way, the subtle nuance of strings can be expressed.

The GM-70 can also select the Poly mode.

The MIDI modes of the transmitter and the receiver should be set to the same ones. The GM-70 transmits the Mode message to the sound module when power is turned on or a different Patch or Mode is selected. The Mode message (Mono or Poly) sent from the transmitter determines the MIDI mode of the receiver, if the receiver can receive the MIDI messages. The GM-70's Mono mode messages cover 6 channels.

d. MIDI Messages

There are various kinds of MIDI messages as follows.

1) Channel Message

Channel messages have channel numbers. The sound module receives the message which is sent on the same channel number as the receiver's. Channel messages include Voice messages and the Mode messages.

● Channel Voice Messages

The Channel Voice messages include the following five.

Note ON/OFF

Note ON consists of the pitch (key number) and the volume (velocity). Note OFF is the message stops the vibration of the strings.

Pitch Bender

This message elevates the pitches of generated sounds. It servers to create the guitar's choking like effect. The maximum effect obtained is determined by the Bend Range value set on the sound module. Some sound modules cannot receive the Pitch bender message, and some can select whether to receive the Pitch bender message or not.

Pressure (Aftertouch)

Aftertouch is the change caused by pressing the key harder after playing it in a normal playing manner. By moving the Controller to which the Aftertouch is assigned, the Aftertouch value of each channel is sent separately to the sound module. The actual effect obtained varies depending on the type of the sound module. Some sound modules cannot receive the Aftertouch message, and some can select whether to receive the Aftertouch message or not.

Program Change

Selecting a Patch on the GM-70 will send the corresponding Program Change number to the connected sound module. Some sound modules cannot receive the Program Change messages, and some can select whether to receive the Program Change messages or not.

Control Change

By moving the Controller, amount of the change made on the Controller Change assigned to the Controller can be transmitted to the connected sound module.

How each Control Change message actually works on the sound module differs depending on the type of the sound module.

● Channel Mode Messages

The GM-70's Channel Mode message is ALL NOTE OFF which is sent when all the strings are turned off.

The Mode messages previously explained include the All Note Off messages, therefore, all notes are muted when the Mode message is received.

2) System Messages

The System messages can be sent without setting MIDI channel. There are three System messages : Exclusive, Common and Real Time, but the GM-70 has only the Exclusive message.

● System Exclusive Message

MIDI is an international standard, but each manufacturer has its own messages to remain originality of each product.

This is called Exclusive messages.

The GM-70 uses this System Exclusive messages to transfer the data stored in memory to other GM-70's. (Bulk-dump and Bulk-load). This is called Data Transfer.

The Exclusive message does not need channel setting, but the Roland System Exclusive message selects the receiver device by using the numbers called Device ID that substitutes channel numbers. The GM-70 uses the MIDI Receive Channel number for Device ID, therefore, the MIDI Receive channel of the GM-70 and the receiver (sound module) should be set to the same number.

3. BEFORE CALLING FOR SERVICE

There is no sound from the sound module and the guitar.

- ☞ Make sure that the GM-70 and the amplifier are turned on.
- ☞ Make sure that the Master Volume of the Guitar Controller is not set too low.
- ☞ Make sure that the volume of the amplifier is not set too low.
- ☞ Make sure that the connections are made correctly as shown in the picture.
- ☞ Check if the connectors are securely plugged in.
- ☞ Check if there is nothing wrong with the connection cables.

There is no sound heard from the guitar.

- ☞ Check if the guitar amplifier is turned on.
- ☞ Check if the Balance Knob of the Guitar Controller is not set to the fully clockwise position.
- ☞ Make sure that an unused plug is not connected to the Guitar Output Jack
- ☞ Check if the level is set high enough.

There is not sound heard from the sound module.

- ☞ Check if the amplifier is turned on.
- ☞ Check if the sound module is turned on.
- ☞ Check if the volume of sound module is set high enough.
- ☞ Check if the Balance Knob on the Guitar Controller is not set to the fully counterclockwise position.
- ☞ Check if the channel number of the Patch currently in use is the same as the sound module's receive channel.
- ☞ Check if you are not using wrong jacks for the Input and Output. When using only one of the Stereo Jacks, you should use the same side for the input and the output. If using the R input, use the R output, and vice versa.
- ☞ Check if the MIDI Volumes of the strings in the Branch that corresponds to the sound module are not set too low.
- ☞ Check if the String Select of the Branch that corresponds to the sound module are not set to OFF.
- ☞ Check if the Controller which the Volume function is assigned to is not turned down.

The volume of the sound module is not affected by the Volume Knob of the Guitar Controller.

- ☐ Check if the MIDI Volume of the sound module is not set to OFF.
- ☐ Check if the sound module used can receive the MIDI Volume message. If not, connect the Output Jack of the sound module to the Stereo Input Jack on the GM-70, then connect the Stereo Output Jack to the amplifier.

When more than one strings are played, not all the sounds on the sound module are heard.

- ☐ This happens when the sound module and the GM-70 is set to the different MIDI mode. Change either of the units to the same MIDI mode as the other one.
- ☐ Check if the sound module is monophonic.
- ☐ Check if the String Select is turned on.
- ☐ If the GM-70 is in the Mono mode, make sure that the channels assigned to the strings match the channels used on the sound module.
- ☐ If the GM-70 is in the Mono mode, and more than one sound modules are controlled individually by the strings of the GM-70, make sure that the channels assigned to the strings match the channels used on the sound modules.

The guitar's pitch is not tuned to the sound module's.

- ☐ Check if the GM-70 is tuned to the guitar.
- ☐ Check if the GM-70 is tuned to the sound module.
- ☐ Check if the bend range of the sound module matches the bend range of the Branch that corresponds to the sound module.
- ☐ Check if the transpose value of the Branch that corresponds to the sound module is set to zero.
- ☐ Check if the sound module is not key-shifted.

Choking effect is not obtained on the sound module.

- ☐ Check if the pitch bender of the sound module is set to OFF.
- ☐ Check if the bend range of the Branch that corresponds to the sound module is not set to zero (=chromatic mode). Set it to the same value as the sound module's.
- ☐ Check if the Controller to which the pitch bender function is assigned is not set to its maximum position.

The dynamics of the sound module does not work properly.

- ☞ Check if the sound module can receive the Velocity messages.
- ☞ Check if the velocity curve selected on the GM-70 is not appropriate.

The patches on the sound module cannot be changed by changing the GM-70's Patches.

- ☞ Check if the Program Change of the sound module is set to ON.
- ☞ Check if the channel of the previous patch and newly selected patch are the same number.
- ☞ Please note that the Program Change numbers sent from the GM-70 often correspond to different Patch numbers on the sound modules.

The Foot Controller FC-100 does not work.

- ☞ Check if the MIDI IN/RRC IN Selector Switch is set to the "RRC IN" position.
- ☞ Check if the cable supplied with the FC-100 is used for connection.

The Patches on the GM-70 cannot be changed by the Program Change messages sent from the external MIDI device.

- ☞ Check if the MIDI IN/RRC IN Selector Switch is set to the MIDI IN position.

- ☞ Check if the MIDI cable is securely connected to the MIDI IN Connector.

- ☞ Check if the receive MIDI channel of the GM-70 is set to the same number as the connected MIDI device's.

The Display does not change at all.

- ☞ Check if you have pushed the Enter Button in the end of the data entry.
- ☞ Check if the GM-70 is in the Playing mode.

A Control Change (function) is assigned to a Controller, but the corresponding function is not obtained.

- ☞ Check if the sound module can receive the Control Change messages.
- ☞ Check if the corresponding function on the sound module is turned on.

The sound module keeps crying.

- ☞ Select a different sound.
- ☞ If the sound does not stop even by selecting a different sound, check if the MIDI cable is securely connected.
- ☞ If the sound stops by selecting a different sound, check if the GM-70 is properly connected to the Guitar Controller.

*The GM-70 does not feature the Active Sensing function.

SPECIFICATIONS

GM-70 : MIDI Converter for Guitar

● Memory Capacity

128 Patches
Control Assign
Tuning Frequency
MIDI Receive Channel

● Edit

Patch Editing
a) General Editing
b) Individual Editing
c) Patch Renaming
Control Assign
Tuning
MIDI Receive Channel

● Front Panel

Play Button
General Edit Button
Individual Edit Button
Copy Button
Tune Button
Control Assign Button
Data Transfer Button
Write Button
Function Switch
Value Switch
Number Buttons (0 to 9)
Minus Button
Enter Button
Level Indicator
Power Switch
16 figure Panel Display
Play Indicator
General Edit Indicator
Individual Edit Indicator
Tune Indicator
Control Assign Indicator
Data Transfer Indicator
Write Indicator

● Rear Panel

Guitar Output Jack
Stereo Input Jacks (R,L)
Stereo Output Jacks (R,L)
Pedal Jacks (FS1, FS2, FSV)
Guitar Input Connector (C-24D STD)
MIDI Connector (IN, OUT)
RRC IN Connector
MIDI IN/RRC IN Selector Switch

● Dimensions

482 (W) × 276 (D) × 44 (H) mm
19" (W) × 10-7/8" (D) × 1-3/4" (H)

● Weight

4kg/8lb 13oz

● Consumption

22w

● Accessories

Connection Cord × 1
MIDI Cable × 1
Owner's Manual × 1

● Options

Foot Controller FC-100
Expression Pedal EV-5
Pedal Switch DP-2
Carrying Case

MIDI Implementation Chart

		Transmitted	Recognized	Remarks
Basic Channel	Default Changed	1-16 1-16	1-16 1-16	Memorized
Mode	Default Messages Altered	3,4 OMNI,MONO,POLY *****	3 × ×	Memorized
Note Number	True Voice	0-127 *****	× ×	
Velocity	Note ON Note ON	○ 9n, v=1-127 × 9n, v=0	× ×	
After Touch	Key's Ch's	× ○	× ×	
Pitch Bender		○	×	Range : 1-64
Control Change	7 0-95	○ Volume ○	× ×	*
Prog Change	True #	○ 0-127 *****	○ 0-127 0-127	
System Exclusive		○	○	**
System common	Song Pos Song sel True	× × ×	× × ×	
System Real Time	Clock Commands	× ×	× ×	
Aux Message	Local ON/OFF All Notes OFF Active Sense Reset	× ○ × ×	× × × ×	
Note	* Any Control Number can be selected. (The value is shown in 7 bits.) ** Dump/Load in the internal memory. (Roland 'one way' format)			

Mode 1 : OMNI ON, POLY
 Mode 3 : OMNI OFF, POLY

Mode 2 : OMNI ON, MONO
 Mode 4 : OMNI OFF, MONO

○ : Yes
 × : No

1. TRANSMITTED DATA

Status	Second	Third	Description	
1001 nnnn	0kkk kkkk	0000 0000	Note OFF kkkkkkk = 0 - 127	*1
1001 nnnn	0kkk kkkk	0vvv vvvv	Note ON kkkkkkk = 0 - 127 vvvvvvv = 1 - 127	*1
1011 nnnn	0000 0111	0vvv vvvv	Volume vvvvvvv = 0 - 127	*1
1011 nnnn	0ccc cccc	0vvv vvvv	Control change ccccccc = 0 - 95 vvvvvvv = 0 - 127	*1, *2
1100 nnnn	0ppp pppp		Program change ppppppp = 0 - 127	*1
1101 nnnn	0vvv vvvv		Channel pressure vvvvvvv = 0 - 127	*1
1110 nnnn	0bbb bbbb	0bbb bbbb	Pitch bender change	*1
1011 nnnn	0111 1011	0000 0000	All NOTES OFF	*1
1011 nnnn	0111 1100	0000 0000	OMNI OFF	*1
1011 nnnn	0111 1110	0000 0110	MONO ON (m = 6)	*1
1011 nnnn	0111 1111	0000 0000	POLY ON	*1
1111 0000	1111 0111	System exclusive	*3

- Notes :
- *1 nnnn represents the MIDI channel number assigned to each Branch of A,B,C and D.
 - *2 Any Control Number can be selected.
 - *3 Bulk Dump(or Load) the internal memory. See 3.EXCLUSIVE.
 - *4 At power-up,
The following message is transmitted to all the Branches.

The mode selected in Patch A 11

The following messages are sent to all the channels.

The current volume value
Program Number set in Patch A 11
 - *5 When a new Patch is selected, the following messages are transmitted.
A) Through the previous channel
Turning OFF all the ON notes
All Notes OFF
Pitch Bender to center
Modulation(Control 1) to 0
Volume (Control 7) to maximum (127)
Damper I(Control 64) to 0
Channel Pressure to 0
OMNI OFF, POLY ON
B) Through the new channel
OMNI OFF
POLY or MONO

Even if the strings previously played are still vibrating, the Channel Voice messages are not transmitted unless a new string is played after a new Patch is selected.

3. EXCLUSIVE

3.1

3.1.1 Exclusive Description

System Exclusive is used for Dump or Load in the internal memory. The format to be used is Roland's 'One Way Transfer' with 21 bit logical address.

Standard Format (treat this as a block)

Byte	Description
a 1111 0000	Exclusive status
b 0100 0001	Roland ID #
c 0000 nnnn	Device-ID # = control channel where nnnn + 1 = channel #
d 0001 0001	Model-ID # (GM-70)
e 0001 0010	Command-ID # (one way transfer data set)
f 0aaa aaaa	21 bits logical address MSB
g 0aaa aaaa	LSB
h 0aaa aaaa	LSB
i 0000 dddd	Data bytes
j 0eee eeee	Checksum
k 1111 0111	End of System Exclusive

Summed value of the all bytes between Command-ID and EOX must be 00H (7 bits). It is not include Command-ID and EOX.

In the GM-70's specifications, Dump (or Load) message is not sent until it is selected through panel operation. This means that in usual performance condition, the Exclusive is not sent or received.

3.1.2 Data Format

The following are the contents of data transmitted and received.

One Patch Memory(80 bytes)

Address Descriptions

0 - 11	12 letter name. ASCII characters
12 - 15	Undefined(reserved, standard is 0)
16	Branch A, 1st string bit 7:Select(1=ON) bit 6 to 0: Program Change Numbers
17	Branch A, 1st string Transpose
18 - 19	Branch A, 2nd string (the contents of data are the same as the 1st string; 16 and 17)
20 - 21	Branch A, 3th string (the contents of data are the same as the 1st string; 16 and 17)
22 - 23	Branch A, 4th string (the contents of data are the same as the 1st string; 16 and 17)
24 - 25	Branch A, 5th string (the contents of data are the same as the 1st string; 16 and 17)
26 - 27	Branch A, 6th string (the contents of data are the same as the 1st string; 16 and 17)
28	branch A bit 5: 1 = OFF bit 4: 1 = POLY, 0 = MONO bit 3 - 0 : Basic Channel
29	Branch A Bend Range
30	Branch A Velocity Curve
31	Branch A Level
32 - 47	Branch B (the contents of data are the same as the Branch A; 16 to 31)
48 - 63	Branch C (the contents of data are the same as the Branch A; 16 to 31)
64 - 79	Branch D (the contents of data are the same as the Branch A; 16 to 31)

System Memory (32 bytes)

Address Descriptions

0	CV 1 Assign
1	CV 1 Mode
2 - 3	CV 2 (the contents of data are the same as CV 1's)
4 - 5	CV 3 (the contents of data are the same as CV 1's)
6 - 7	CV 4 (the contents of data are the same as CV 1's)
8 - 9	SW 1 (the contents of data are the same as CV 1's)
10 - 11	SW 2 (the contents of data are the same as CV 1's)
12 - 13	PCV (the contents of data are the same as CV 1's)
14 - 15	FS 1 (the contents of data are the same as CV 1's)
16 - 17	FS 2 (the contents of data are the same as CV 1's)
18 - 19	RCV (the contents of data are the same as CV 1's)
20 - 21	RSW (the contents of data are the same as CV 1's)
22	Control Channel
23	Undefined(reserved, standard is 00)
24	Master Tune
25 - 31	Undefined(reserved, standard is 00)

all data : 21834 bytes
64 patch : 10880 bytes
system : 74 bytes

2. RECOGNIZED RECEIVE DATA

Status	Second	Third	Description	
1100 nnnn	0ppp pppp		Program change ppppppp = 0 - 127	*1
1111 0000	1111 0111	System exclusive	*2

- Notes :
- *1 nnnn is the value of Control Channel stored in the System memory. The value can be changed freely, but the mode is fixed to OMNI OFF.
 - *2 Bulk Dump(or Load) the internal memory. (See 3. EXCLUSIVE.)

2 TRANSMIT

One of the following data groups can be transmitted through panel operation.

- 1) Entire memory data
- 2) First half(64 Patches) of the 128 Patch Memories (11 to 88)
- 3) Latter half(64 Patches) of the 128 Patch Memories (-11 to -88)
- 4) System Memory

Different address is transmitted depending which of the above four data groups is selected.

The data in one Block is transmitted as follows:

- 1) 1 byte(=8 bits) is divide into two(4 bits each), transmitting two data.
- 2) A Patch consists of 80 bytes and Block includes 160 data.
- 3) The System Memory consists of 32 bytes and a Block consists of 64 data.

Between two Block, Inter Block Gap(more than 20ms) is placed for low ability receive device. The number of the bytes of the MIDI message sent in each of the above methods is as follows.

```
block-001 (patch 11)
  F0 41 0n 11 12 00 00 00 [.data 160bytes.] sum F7
block-002 (patch 12)
  F0 41 0n 11 12 00 01 20 [.data 160bytes.] sum F7
block-003 (patch 13)
  F0 41 0n 11 12 00 02 40 [.data 160bytes.] sum F7
  :
  :
block-128 (patch -88)
  F0 41 0n 11 12 01 1E 60 [.data 160bytes.] sum F7
block-129 (system)
  F0 41 0n 11 12 01 20 00 [.data 64bytes..] sum F7
```

2.1 Entire Data in Memory

First, the Patch Memory data 1 to 128 is sent, then the System Memory. The form and logical address of each Block are as follows.

2.2 First 64 Patches

The form and logical address of each Block are as follows.

```
block-001 (patch 11)
  F0 41 0n 11 12 02 00 00 [.data 160bytes.] sum F7
block-002 (patch 12)
  F0 41 0n 11 12 02 01 20 [.data 160bytes.] sum F7
block-003 (patch 13)
  F0 41 0n 11 12 02 02 40 [.data 160bytes.] sum F7
  :
  :
block-064 (patch 88)
  F0 41 0n 11 12 02 4E 60 [.data 160bytes.] sum F7
```

2.3 Latter 64 Patches

The form and logical address of each Block are as follows.

```
block-001 (patch -11)
  F0 41 0n 11 12 02 50 00 [.data 160bytes.] sum F7
block-002 (patch -12)
  F0 41 0n 11 12 02 51 20 [.data 160bytes.] sum F7
block-003 (patch -13)
  F0 41 0n 11 12 02 52 40 [.data 160bytes.] sum F7
  :
  :
block-064 (patch -88)
  F0 41 0n 11 12 03 1E 60 [.data 160bytes.] sum F7
```

2.4 System Memory Data

Contains only one Block. The form and address are as follows.

```
block-001 (system)
  F0 41 0n 11 12 03 20 00 [.data 64bytes.] sum F7
```

Receive

Enter to the Receive stand-by mode by operating the panel.

*Select whether to receive the first or latter 64 Patches. (See 3.2 Transmit, 3.2.2 and 3.2.3.) This procedure is not necessary when receiving the entire data of memory.

3.3.1 The following conditions should be fulfilled to start receiving data.

* Roland format starts correctly. (If not, the GM-70 will wait until the correct Block is transmitted.)

* The received Device ID is equal to the Control Channel. (If not, the GM-70 will wait until the correct Block is transmitted.)

* The address of the first Block is one of the following. (If not, the GM-70 shows DATA ERROR in the Display and returns to the playing mode.)

Address(3 bytes) MSB LSB

Entire Data

First Half Patches(64 Patches)

Latter Half Patches(64 Patches)

System Memory

3.3.2 Depending on the first address received, the GM-70 stores the data in a proper location in memory. After this, the following conditions should be fulfilled.

* Roland format being received is correct. (If not, the GM-70 will wait until the correct Block is transmitted.)

* The received Device ID is equal to the Control Channel. (If not, the GM-70 will wait until the correct Block is transmitted.)

* The next logical address is correct. (If not, the GM-70 shows DATA ERROR in the Display and returns to the playing mode.)

* Check Sun is correct. (If not, the GM-70 shows DATA ERROR in the Display and returns to the playing mode.)

* EOX follows in the end. (If not, the GM-70 shows DATA ERROR in the Display and returns to the playing mode.)

* The correct number of the Blocks received. (When less Blocks are received: the GM-70 waits until all are received.)

When more Blocks are transmitted: the GM-70 ignores the exceeding Blocks.

3.3.3 Even if the loading goes wrong in the middle, the data received so far is stored into memory.

3.3.4 Loading can be aborted at any time by pushing any button on the panel.

3.3.5 The Control Channel resides in the System Memory. Therefore, the Control Channel (Device ID) is not changed until the System Memory Block's is fully received.

