

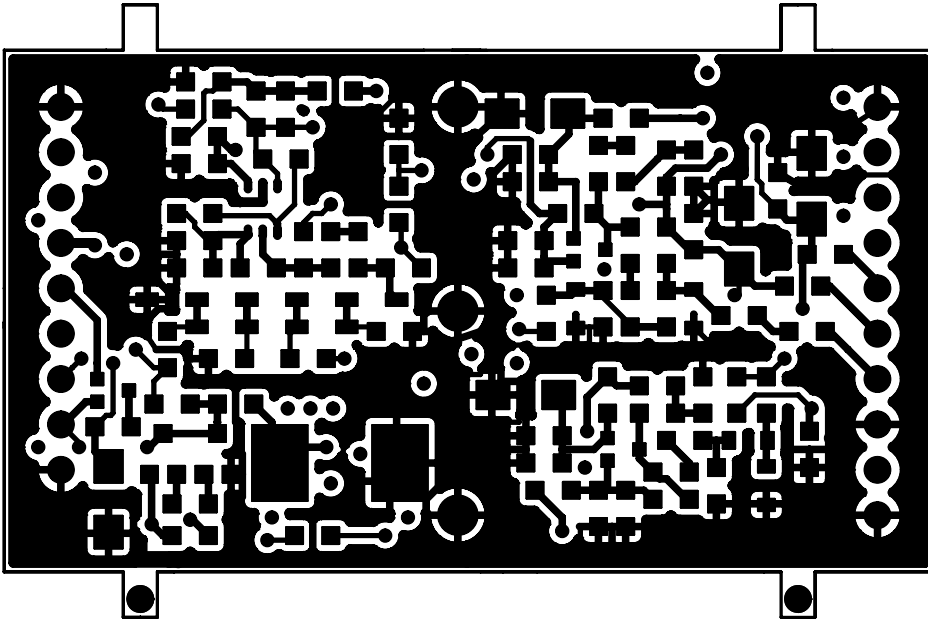

A SIDE

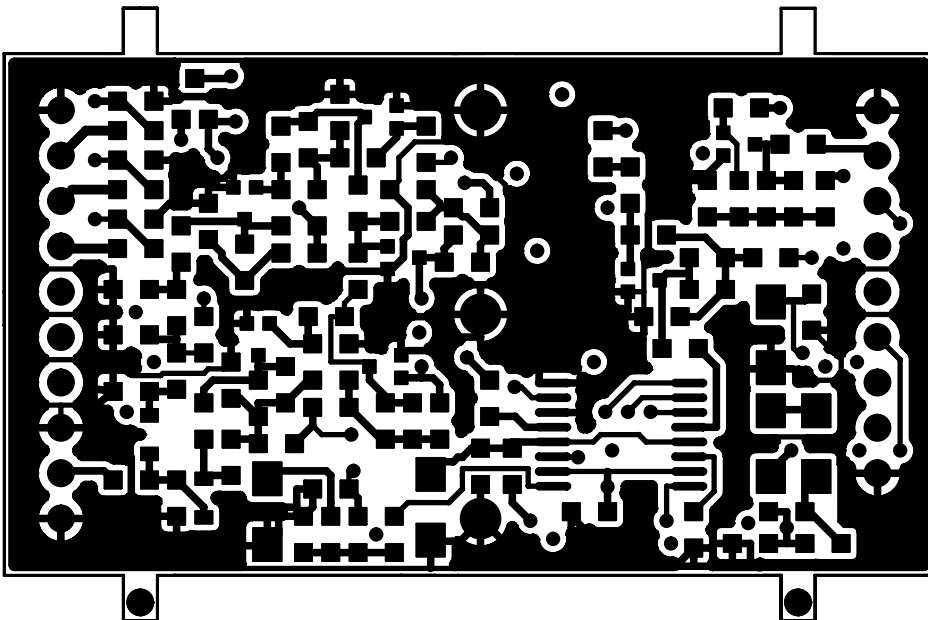

B SIDE



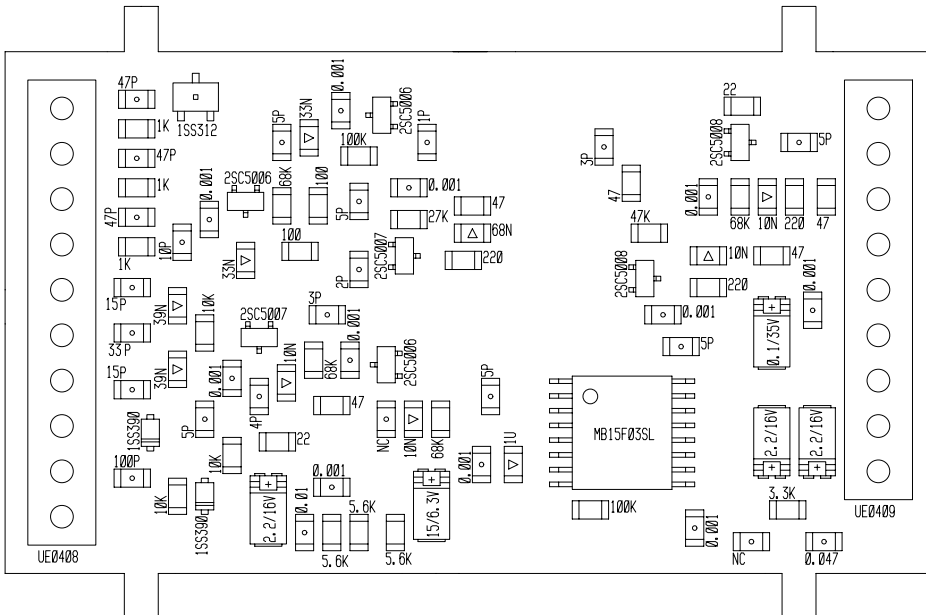
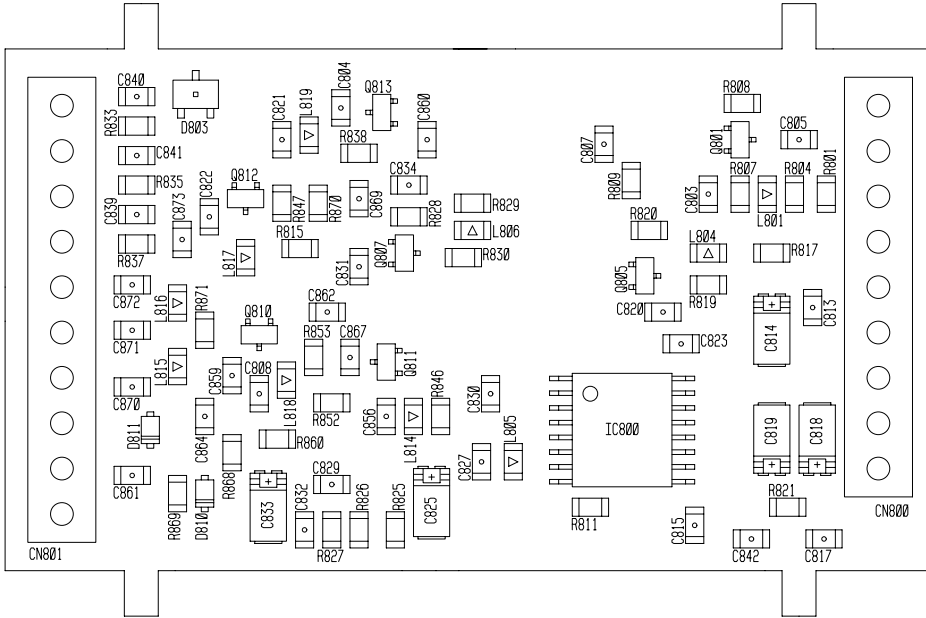

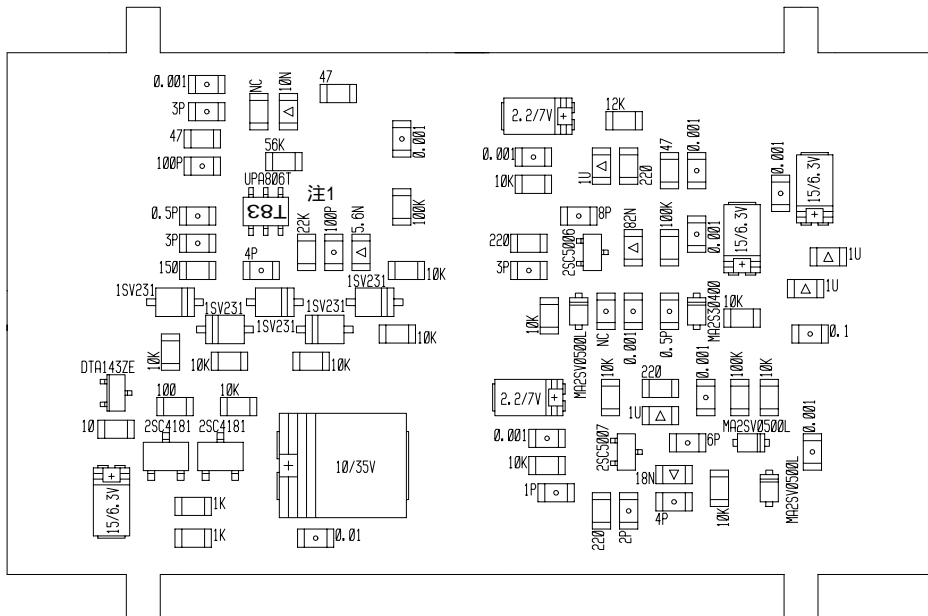
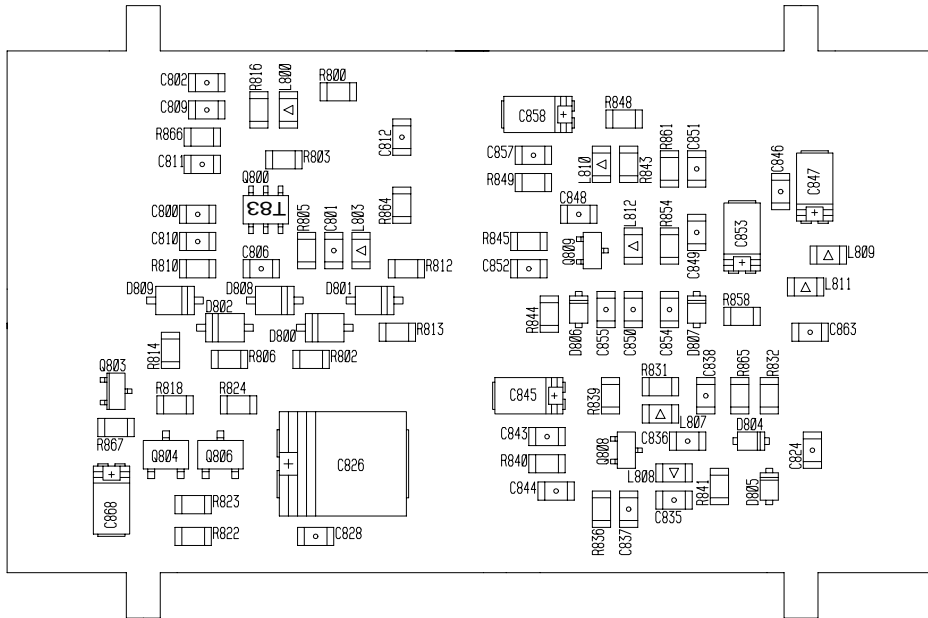



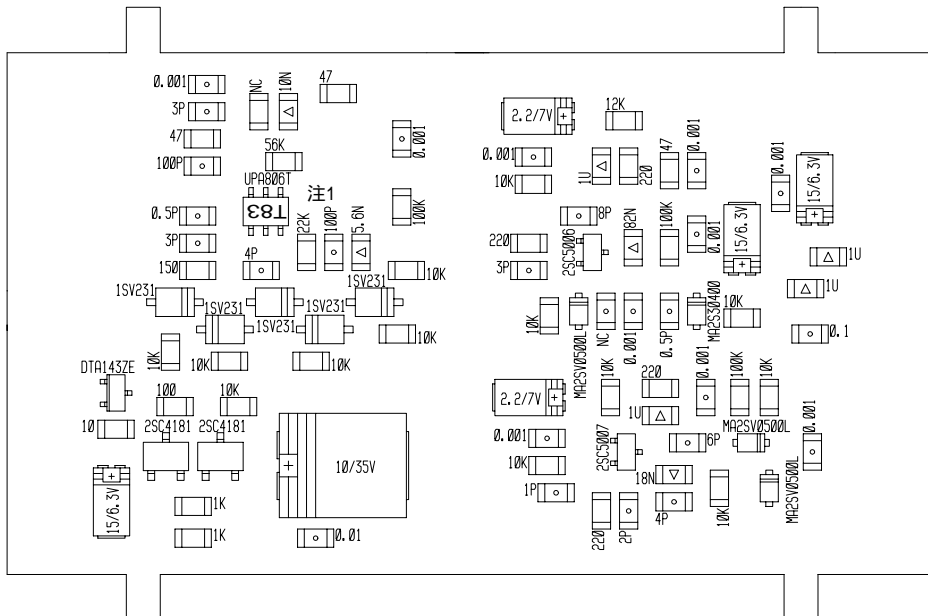
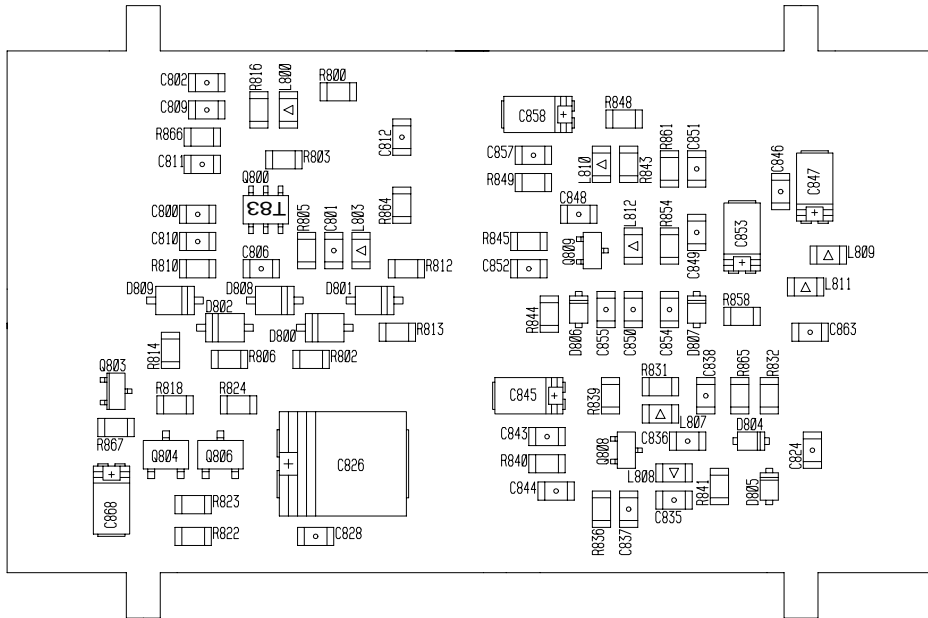



A SIDE

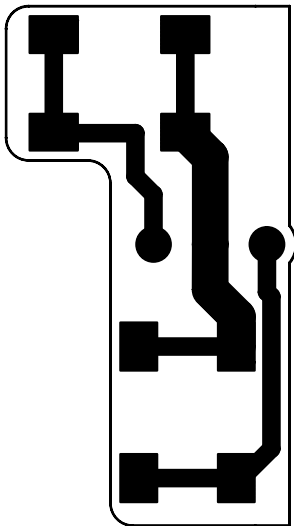

B SIDE

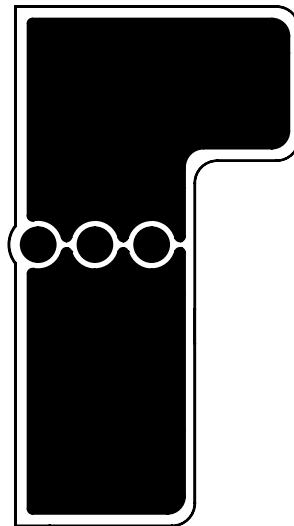

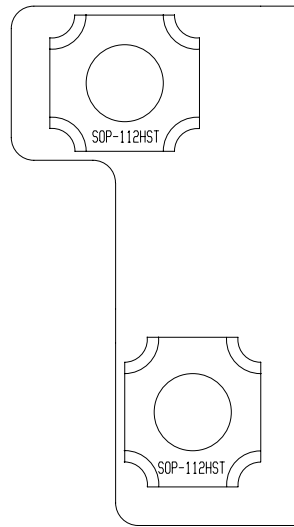
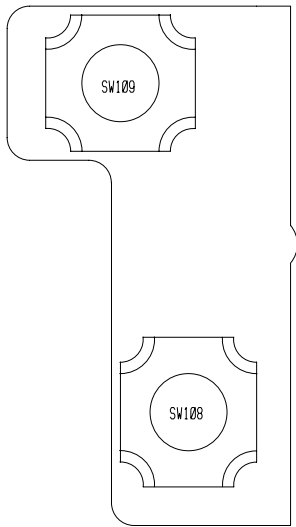

DJ-X2000 SW A SIDE

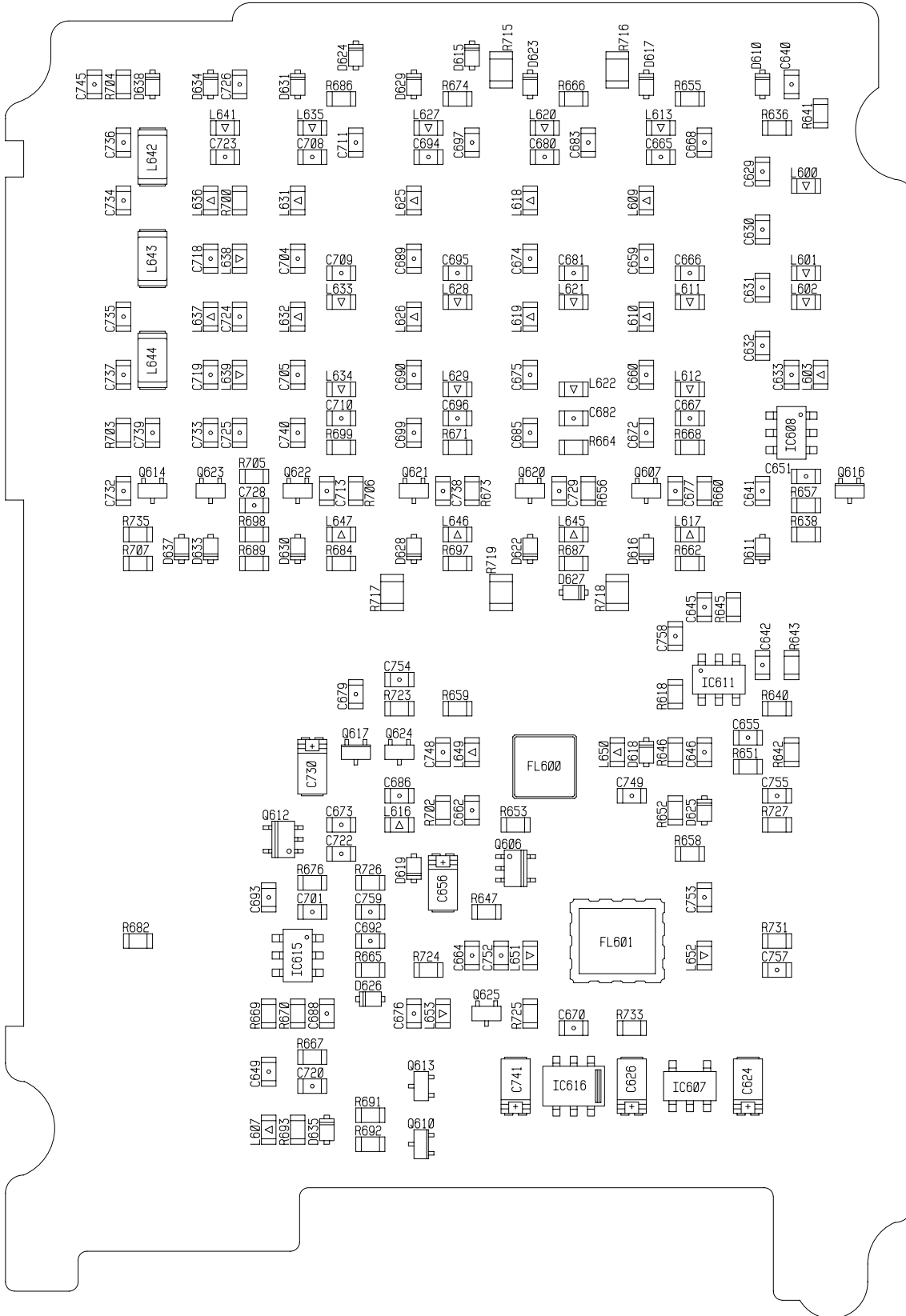

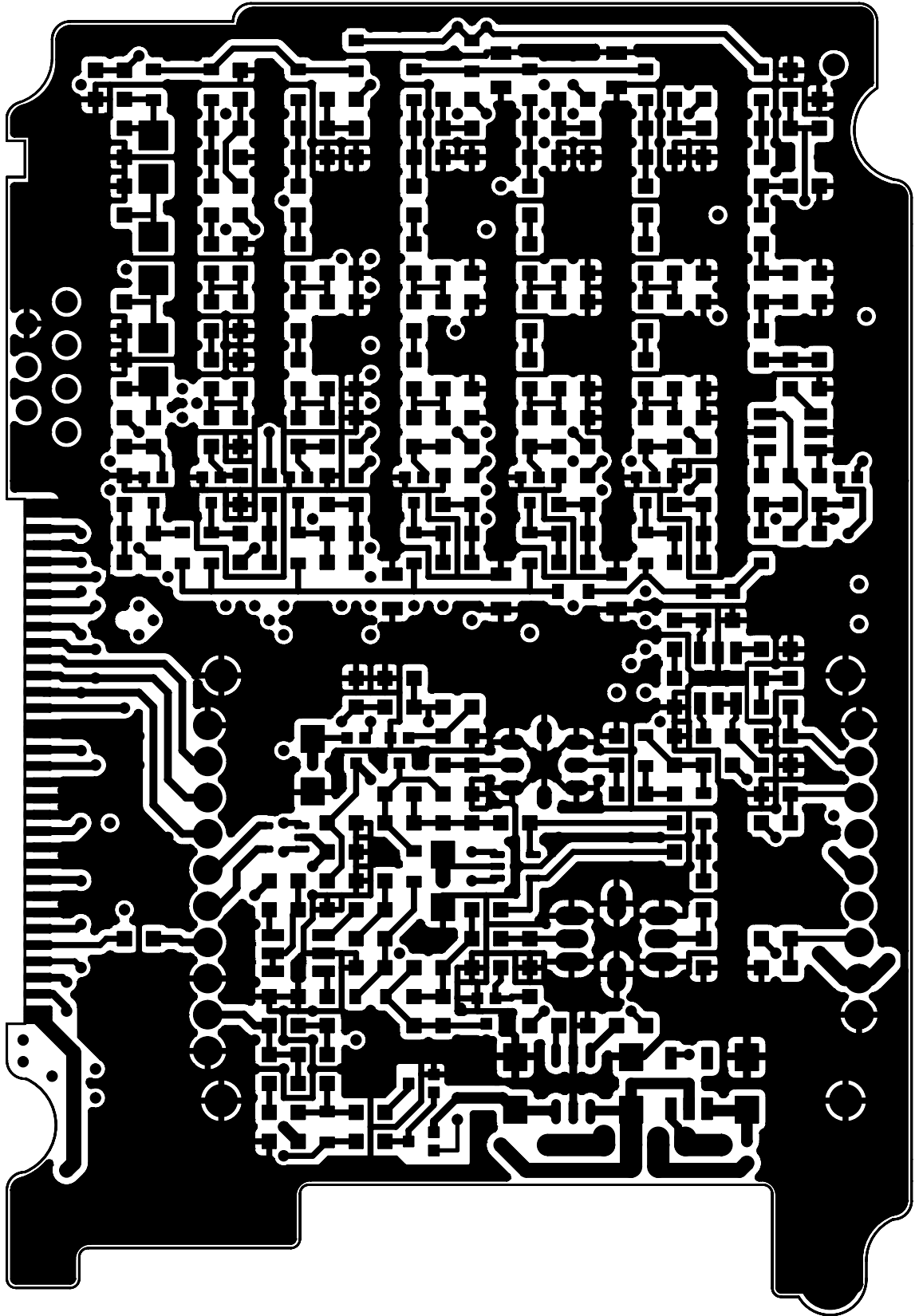

DJ-X2000 RF B SIDE PATTERN

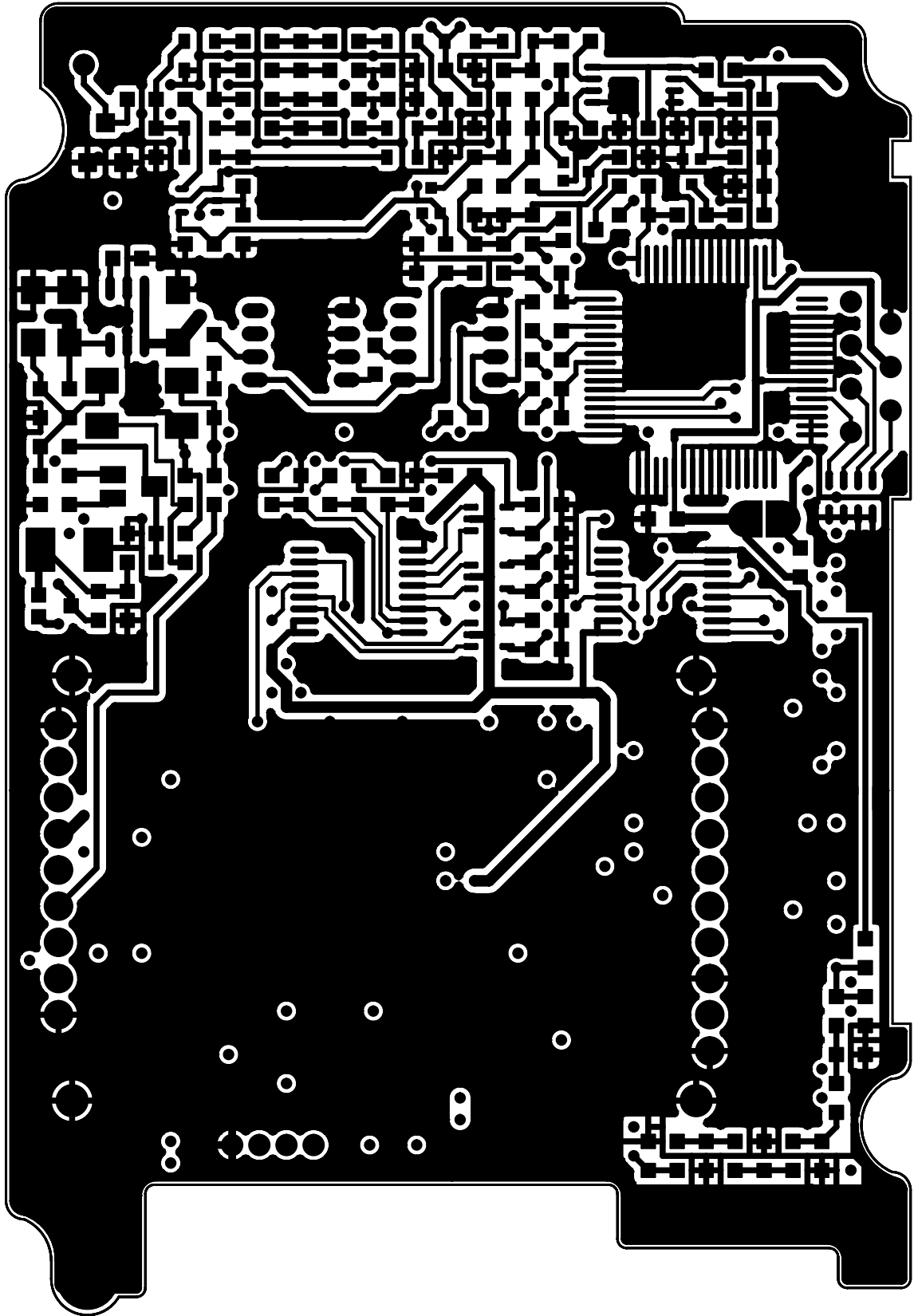

DJ-X2000 RF A SIDE PATTERN

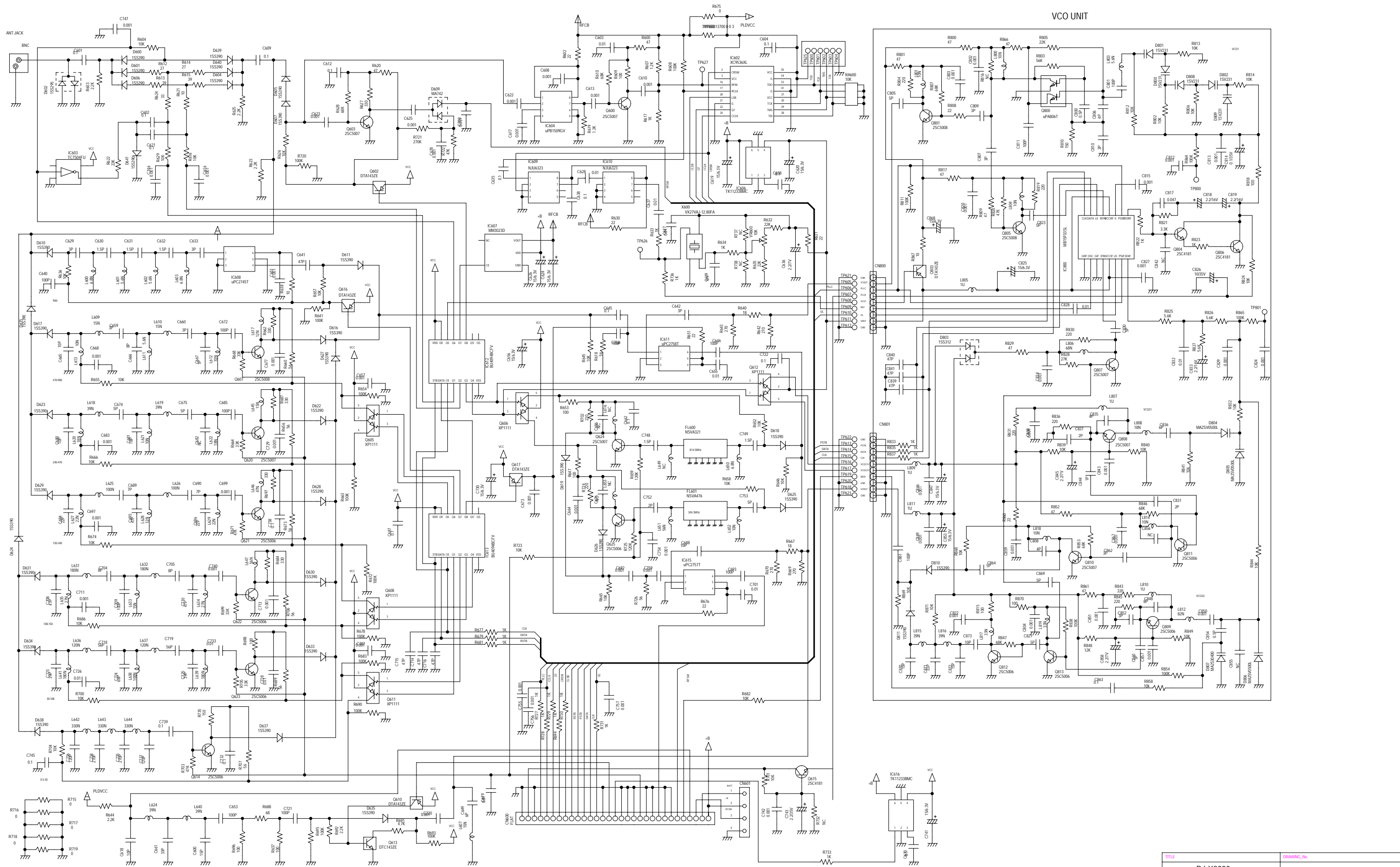

TITLE		DRAWING No.	
DJ-X2000			
RF CIRCUIT		ALINCO INC.	
SHEET	DATE	DESIGN	
1 / 1	0009/02	Y.M	

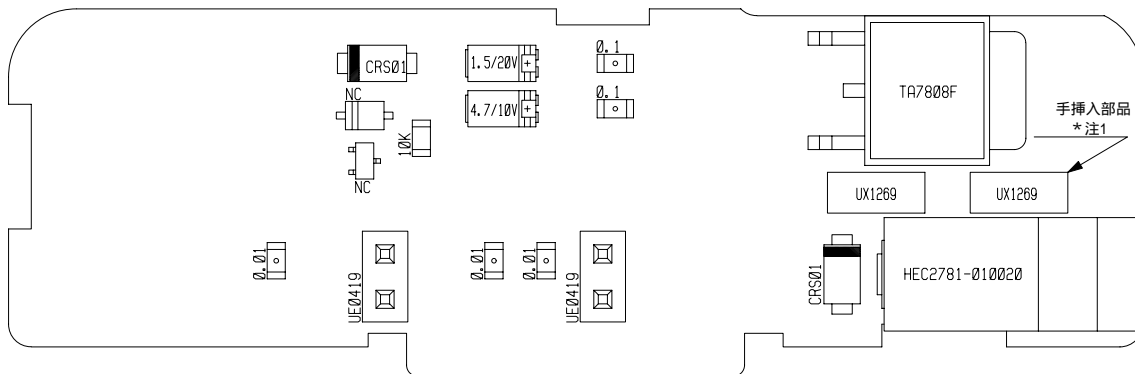
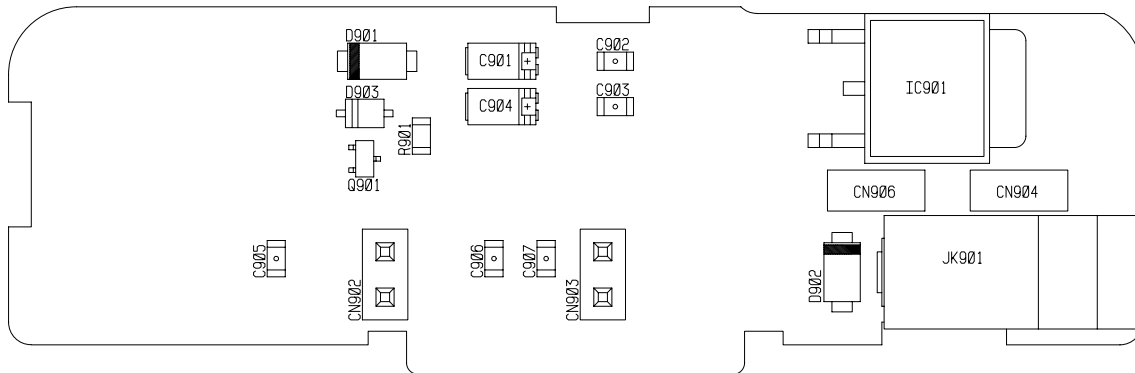





A SIDE

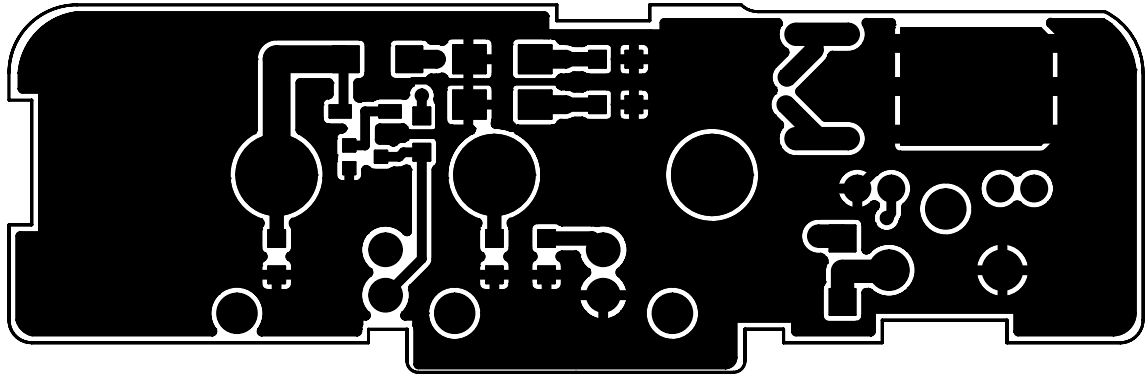

B SIDE

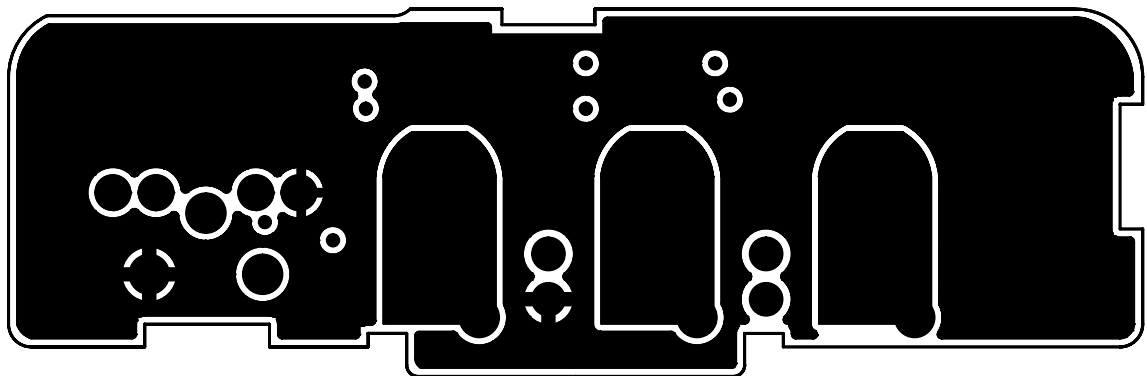

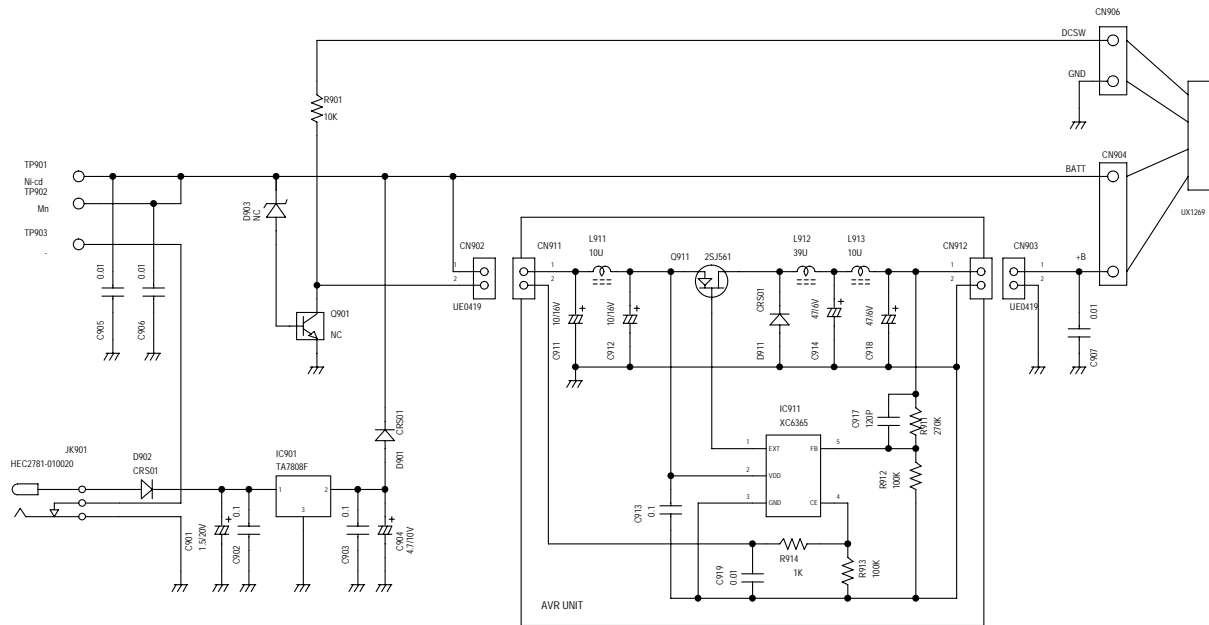

TITLE		DRAWING No.	
DJ-X2000		ALINCO INC.	
REG UNIT			
SHEET	DATE	DESIGN	
1 / 1	2000/06/30	Y.M	

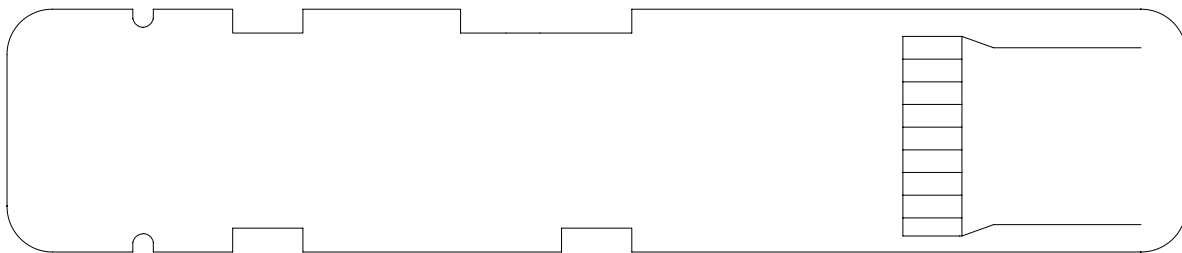
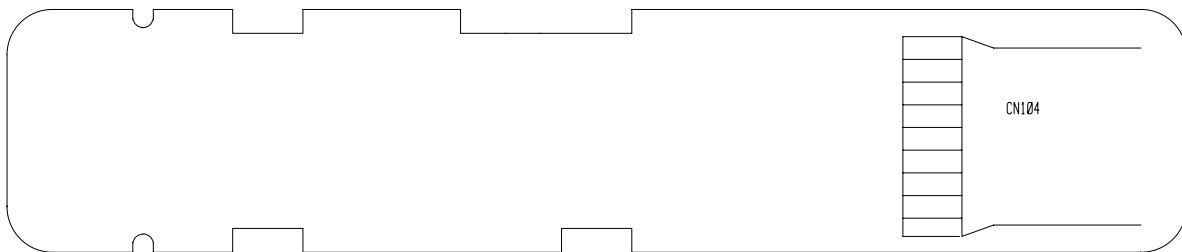
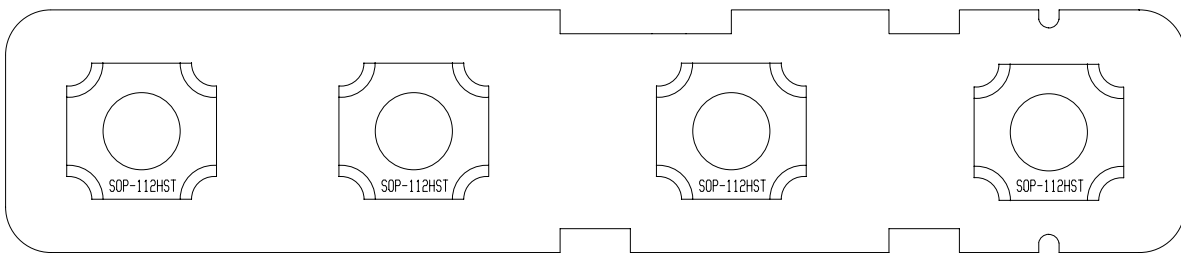
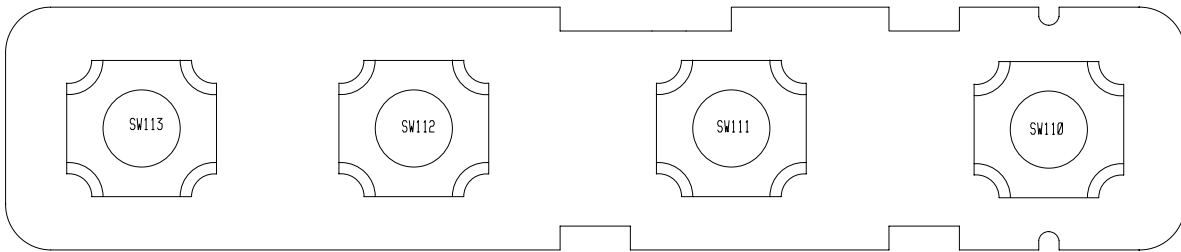



A SIDE

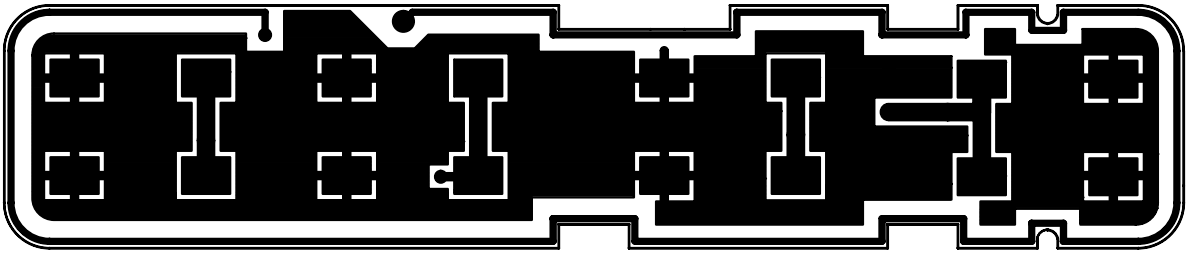

B SIDE



DJ-X2000 PTT PATTERN

# DJ-X2000 parts list

UNIT		AVR			
Ref. No.	Parts No.	DESCRIPTION	Parts Name	LOC	RMKS
	TN0013		Adapter X2000	H	
C911	CS0372	TANTALUM	TMCMB1C106MTR	A	
C912	CS0372	TANTALUM	TMCMB1C106MTR	A	
C913	CU3111	CERAMIC	C1608JB1C104KT-N	A	
C914	CS0394	TANTALUM	TMCMB0J476MTR	A	
C917	CU3024	CERAMIC	C1608CH1H121JT-AS	A	
C918	CS0394	TANTALUM	TMCMB0J476MTR	A	
C919	CU3047	CERAMIC	C1608JB1H103KT-N	A	
D911	XD0352	DIODE	CRS01(TE85L)	A	
IC911	XA0796	IC	XC6365B103MR	A	
L911	QC0635	COIL	NLC322522T-100K	A	
L912	QL0017	COIL	C5-K3L(R-12T724EH)	A	
L913	QC0635	COIL	NLC322522T-100K	A	
Q911	XE0043	FET	2SJ561-TD	A	
R911	RK3067	RESISTOR	MCR03EZHZ274	A	
R912	RK3062	RESISTOR	MCR03EZHZ104	A	
R913	RK3062	RESISTOR	MCR03EZHZ104	A	
R914	RK3038	RESISTOR	MCR03EZHZ102	A	

UNIT		CPU			
Ref. No.	Parts No.	DESCRIPTION	Parts Name	LOC	RMKS
	MBCL02AA	WIRE	#30B02-20-02	H	
	YX0004	OTHERS	TAPE	H	
	DG0027Y		LCDライト XH605	H	
	EY0019	コンデンサマイク	EM-123	H	
	TL0017		Sheet XH605	H	
	TL0020	SHADE	Sheet DJX10	H	
	MRCL02AA	WIRE	#30R02-20-02	H	
C101	CS0057	TANTALUM	TMCSA0J225MTR	B	
C102	CS0408	TANTALUM	6MCM156MATER	B	
C103	CU3111	CERAMIC	C1608JB1C104KT-N	B	
C104	CU3012	CERAMIC	C1608CH1H120JT-AS	B	
C105	CU3012	CERAMIC	C1608CH1H120JT-AS	B	
C106	CU3012	CERAMIC	C1608CH1H120JT-AS	B	
C107	CU3012	CERAMIC	C1608CH1H120JT-AS	B	
C108	CU3023	CERAMIC	C1608CH1H101JT-AS	A	
C109	CU3023	CERAMIC	C1608CH1H101JT-AS	A	

C110	CU3023	CERAMIC	C1608CH1H101JT-AS	A
C111	CU3111	CERAMIC	C1608JB1C104KT-N	B
C112	CU3047	CERAMIC	C1608JB1H103KT-N	B
C113	CS0057	TANTALUM	TMCSA0J225MTR	B
C116	CU3111	CERAMIC	C1608JB1C104KT-N	B
C117	CU3111	CERAMIC	C1608JB1C104KT-N	A
C118	CU3111	CERAMIC	C1608JB1C104KT-N	A
C119	CU3111	CERAMIC	C1608JB1C104KT-N	A
C120	CU3111	CERAMIC	C1608JB1C104KT-N	A
C121	CU3111	CERAMIC	C1608JB1C104KT-N	A
C122	CU3111	CERAMIC	C1608JB1C104KT-N	A
C123	CS0208	TANTALUM	TMCMA0J475MTR	A
C124	CU3111	CERAMIC	C1608JB1C104KT-N	A
C125	CU3111	CERAMIC	C1608JB1C104KT-N	A
C126	CS0408	TANTALUM	6MCM156MATER	A
C127	CS0408	TANTALUM	6MCM156MATER	B
C128	CU3023	CERAMIC	C1608CH1H101JT-AS	A
C129	CU3047	CERAMIC	C1608JB1H103KT-N	B
C130	CU3031	CERAMIC	C1608JB1H471KT-AS	B
C131	CS0408	TANTALUM	6MCM156MATER	B
C132	CU3111	CERAMIC	C1608JB1C104KT-N	B
C133	CU3023	CERAMIC	C1608CH1H101JT-AS	B
C134	CU3111	CERAMIC	C1608JB1C104KT-N	B
C135	CU3111	CERAMIC	C1608JB1C104KT-N	B
C136	CU3111	CERAMIC	C1608JB1C104KT-N	B
C137	CU3023	CERAMIC	C1608CH1H101JT-AS	B
C138	CU3111	CERAMIC	C1608JB1C104KT-N	B
C139	CU3111	CERAMIC	C1608JB1C104KT-N	B
C140	CU3023	CERAMIC	C1608CH1H101JT-AS	A
C141	CU3047	CERAMIC	C1608JB1H103KT-N	B
C142	CU3047	CERAMIC	C1608JB1H103KT-N	B
C143	CU3047	CERAMIC	C1608JB1H103KT-N	B
C144	CU3047	CERAMIC	C1608JB1H103KT-N	B
C145	CU3035	CERAMIC	C1608JB1H102KT-AS	B
C146	CU3035	CERAMIC	C1608JB1H102KT-AS	B
C147	CU3111	CERAMIC	C1608JB1C104KT-N	B
C148	CS0408	TANTALUM	6MCM156MATER	B
C149	CU3047	CERAMIC	C1608JB1H103KT-N	B
C150	CS0385	TANTALUM	TMCMD1V106MTR	B
C151	CS0408	TANTALUM	6MCM156MATER	B
C152	CS0408	TANTALUM	6MCM156MATER	B

C153	CS0370	TANTALUM	TMCME1A107MTR	B
C155	CU3111	CERAMIC	C1608JB1C104KT-N	B
C156	CU3035	CERAMIC	C1608JB1H102KT-AS	B
C157	CS0057	TANTALUM	TMCSA0J225MTR	B
CN101	UE0255	CONNECTOR	6027B-03Z003	M
CN103	UE0406	CONNECTOR	AXK3S50035P	B
CN105	UE0256	CONNECTOR	CFP0508-0201	B
D101	XD0291	DIODE	MA729-TX	B
D102	XD0291	DIODE	MA729-TX	A
D106	XL0028	LED	BRPG1201W TR	A
D107	XL0036	LED	SML-310MTT86	A
D108	XL0036	LED	SML-310MTT86	A
D109	XL0036	LED	SML-310MTT86	A
D110	XL0036	LED	SML-310MTT86	A
D111	XL0060	LED	PY1101F-TR	A
D112	XL0060	LED	PY1101F-TR	A
D113	XL0060	LED	PY1101F-TR	A
D114	XL0060	LED	PY1101F-TR	A
IC102	XA0759	IC	PST3225NR	B
IC103	XA0772	IC	PST3238NR	B
IC105	XA0782	IC	NJU7018R-TE1	B
IC105	XA0782	IC	NJU7018R-TE1	B
IC106	XA0781	IC	24LC256T-I/SM	B
IC107	XA0781	IC	24LC256T-I/SM	B
IC108	XA0780	IC	ML2500TA	B
IC109	XA0348	IC	TC4W53FU(TE12)	B
IC110	XA0573	IC	NJM2904V-TE1	B
IC110	XA0573	IC	NJM2904V-TE1	B
IC111	XA0468	IC	TK11819MTL	B
IC112	XA0783	IC	MM3023DNRE	B
IC113	XA0783	IC	MM3023DNRE	B
L101	QC0502	COIL	667MA-102N	B
LCD101	EL0051	LCD	TC223DGFN-N(DJX20)	H
Q101	XU0155	TRANSISTOR	DTB123YK T146	A
Q102	XU0182	DIG TR.	UN9112-TX	B
Q104	XU0152	TRANSISTOR	UMC5NTR	B
Q110	XU0186	DIG TR.	DTC143ZEA TL	B
Q111	XU0186	DIG TR.	DTC143ZEA TL	B
R101	RK3062	RESISTOR	MCR03EZHZ104	B
R102	RK3062	RESISTOR	MCR03EZHZ104	B
R103	RK3042	RESISTOR	MCR03EZHZ222	B

R104	RK3042	RESISTOR	MCR03EZHJ222	B
R105	RK3066	RESISTOR	MCR03EZHJ224	B
R106	RK3064	RESISTOR	MCR03EZHJ154	B
R107	RK3026	RESISTOR	MCR03EZHJ101	B
R109	RK3038	RESISTOR	MCR03EZHJ102	A
R110	RK3062	RESISTOR	MCR03EZHJ104	B
R111	RK3026	RESISTOR	MCR03EZHJ101	B
R112	RK3074	RESISTOR	MCR03EZHJ105	B
R113	RK3050	RESISTOR	MCR03EZHJ103	B
R114	RK3074	RESISTOR	MCR03EZHJ105	B
R115	RK3050	RESISTOR	MCR03EZHJ103	B
R116	RK3038	RESISTOR	MCR03EZHJ102	A
R117	RK3038	RESISTOR	MCR03EZHJ102	B
R119	RK3062	RESISTOR	MCR03EZHJ104	A
R120	RK3038	RESISTOR	MCR03EZHJ102	A
R121	RK3039	RESISTOR	MCR03EZHJ122	A
R122	RK3033	RESISTOR	MCR03EZHJ391	A
R123	RK3033	RESISTOR	MCR03EZHJ391	A
R124	RK3033	RESISTOR	MCR03EZHJ391	A
R125	RK3033	RESISTOR	MCR03EZHJ391	A
R126	RK3033	RESISTOR	MCR03EZHJ391	A
R127	RK3033	RESISTOR	MCR03EZHJ391	A
R128	RK3033	RESISTOR	MCR03EZHJ391	A
R129	RK3033	RESISTOR	MCR03EZHJ391	A
R130	RK3033	RESISTOR	MCR03EZHJ391	A
R131	RK3026	RESISTOR	MCR03EZHJ101	A
R132	RK3042	RESISTOR	MCR03EZHJ222	A
R133	RK3022	RESISTOR	MCR03EZHJ470	B
R134	RK3052	RESISTOR	MCR03EZHJ153	B
R135	RK3050	RESISTOR	MCR03EZHJ103	B
R136	RK3050	RESISTOR	MCR03EZHJ103	B
R137	RK3070	RESISTOR	MCR03EZHJ474	B
R138	RK3056	RESISTOR	MCR03EZHJ333	B
R139	RK3050	RESISTOR	MCR03EZHJ103	B
R140	RK3050	RESISTOR	MCR03EZHJ103	B
R141	RK3068	RESISTOR	MCR03EZHJ334	B
R142	RK3050	RESISTOR	MCR03EZHJ103	B
R143	RK3104	RESISTOR	MCR03EZHJ303	B
R144	RK3053	RESISTOR	MCR03EZHJ183	A
R145	RK3050	RESISTOR	MCR03EZHJ103	A
R146	RK3001	RESISTOR	MCR03EZHJ000	B



R147	RK3001	RESISTOR	MCR03EZHJ000	B
R150	RK3001	RESISTOR	MCR03EZHJ000	B
R152	RK3058	RESISTOR	MCR03EZHJ473	B
R153	RK3050	RESISTOR	MCR03EZHJ103	B
R154	RK3001	RESISTOR	MCR03EZHJ000	B
R155	RK3001	RESISTOR	MCR03EZHJ000	B
RA101	RA0029	RES.ARRAY	EXBV4V104JV	B
RA102	RA0008	RES.ARRAY	EXBV4V102JV	B
RA103	RA0009	RES.ARRAY	EXBV8V102JV	B
RA104	RA0021	RES.ARRAY	EXBV4V103JV	B
RA105	RA0009	RES.ARRAY	EXBV8V102JV	B
RA106	RA0030	RES.ARRAY	EXBV8V104JV	B
RA107	RA0008	RES.ARRAY	EXBV4V102JV	B
RA108	RA0009	RES.ARRAY	EXBV8V102JV	B
RA109	RA0030	RES.ARRAY	EXBV8V104JV	B
RA110	RA0029	RES.ARRAY	EXBV4V104JV	B
RA112	RA0030	RES.ARRAY	EXBV8V104JV	B
SW101	UU0018	SWITCH	SOP-112HST	A
SW102	UU0018	SWITCH	SOP-112HST	A
SW103	UU0018	SWITCH	SOP-112HST	A
SW104	UU0019	SWITCH	SKQLLC	A
SW105	UU0019	SWITCH	SKQLLC	A
SW106	UU0019	SWITCH	SKQLLC	A
SW107	UU0019	SWITCH	SKQLLC	A
X101	XQ0119	XTAL	DSX151GA 4.91520MHZ	B
X102	XQ0134	XTAL	SP-T2A 32.768KHZ	B

UNIT		IF			
Ref. No.	Parts No.	DESCRIPTION	Parts Name	LOC	RMKS
C302	CU3088	CERAMIC	C1608CH1H200JT-AS	A	
C303	CU3047	CERAMIC	C1608JB1H103KT-N	A	
C304	CU3047	CERAMIC	C1608JB1H103KT-N	A	
C305	CS0408	TANTALUM	6MCM156MATER	A	
C307	CU3002	CERAMIC	C1608CH1H010CT-AS	A	
C308	CS0408	TANTALUM	6MCM156MATER	A	
C309	CU3047	CERAMIC	C1608JB1H103KT-N	A	
C310	CU3035	CERAMIC	C1608JB1H102KT-AS	A	
C311	CU3047	CERAMIC	C1608JB1H103KT-N	A	
C312	CU3035	CERAMIC	C1608JB1H102KT-AS	A	
C313	CU3047	CERAMIC	C1608JB1H103KT-N	B	
C314	CU3014	CERAMIC	C1608CH1H180JT-AS	A	
C315	CU3012	CERAMIC	C1608CH1H120JT-AS	A	

C316	CS0408	TANTALUM	6MCM156MATER	B
C317	CU3019	CERAMIC	C1608CH1H470JT-AS	A
C318	CU3019	CERAMIC	C1608CH1H470JT-AS	A
C319	CU3111	CERAMIC	C1608JB1C104KT-N	A
C320	CU3111	CERAMIC	C1608JB1C104KT-N	A
C321	CU3047	CERAMIC	C1608JB1H103KT-N	A
C322	CU3023	CERAMIC	C1608CH1H101JT-AS	B
C324	CU3051	CERAMIC	C1608JB1E223KT-NS	A
C325	CU3111	CERAMIC	C1608JB1C104KT-N	A
C326	CU3111	CERAMIC	C1608JB1C104KT-N	A
C327	CU3011	CERAMIC	C1608CH1H100DT-AS	A
C328	CU3023	CERAMIC	C1608CH1H101JT-AS	A
C329	CU3116	CERAMIC	C1608CH1H471JT-AS	A
C330	CU3035	CERAMIC	C1608JB1H102KT-AS	A
C331	CU3111	CERAMIC	C1608JB1C104KT-N	B
C332	CS0408	TANTALUM	6MCM156MATER	B
C333	CU3047	CERAMIC	C1608JB1H103KT-N	A
C334	CU3035	CERAMIC	C1608JB1H102KT-AS	A
C335	CU3047	CERAMIC	C1608JB1H103KT-N	B
C336	CU3035	CERAMIC	C1608JB1H102KT-AS	B
C337	CS0408	TANTALUM	6MCM156MATER	A
C338	CU3111	CERAMIC	C1608JB1C104KT-N	A
C339	CS0408	TANTALUM	6MCM156MATER	A
C340	CU3111	CERAMIC	C1608JB1C104KT-N	A
C351	CU3012	CERAMIC	C1608CH1H120JT-AS	B
C353	CU3035	CERAMIC	C1608JB1H102KT-AS	B
C354	CU3035	CERAMIC	C1608JB1H102KT-AS	B
C356	CU3024	CERAMIC	C1608CH1H121JT-AS	B
C357	CU3047	CERAMIC	C1608JB1H103KT-N	B
C358	CU3047	CERAMIC	C1608JB1H103KT-N	B
C359	CU3035	CERAMIC	C1608JB1H102KT-AS	A
C360	CU3047	CERAMIC	C1608JB1H103KT-N	A
C361	CU3047	CERAMIC	C1608JB1H103KT-N	A
C362	CU3047	CERAMIC	C1608JB1H103KT-N	A
C363	CU3047	CERAMIC	C1608JB1H103KT-N	A
C364	CU3011	CERAMIC	C1608CH1H100DT-AS	B
C365	CU3047	CERAMIC	C1608JB1H103KT-N	B
C366	CU3011	CERAMIC	C1608CH1H100DT-AS	B
C367	CU3024	CERAMIC	C1608CH1H121JT-AS	A
C370	CU3047	CERAMIC	C1608JB1H103KT-N	A
C381	CS0408	TANTALUM	6MCM156MATER	B

C382	CU3111	CERAMIC	C1608JB1C104KT-N	B
C383	CU3019	CERAMIC	C1608CH1H470JT-AS	B
C384	CU3019	CERAMIC	C1608CH1H470JT-AS	B
C385	CU3019	CERAMIC	C1608CH1H470JT-AS	B
C386	CS0408	TANTALUM	6MCM156MATER	A
C387	CU3111	CERAMIC	C1608JB1C104KT-N	A
C389	CU3111	CERAMIC	C1608JB1C104KT-N	A
C390	CS0408	TANTALUM	6MCM156MATER	A
C391	CU3111	CERAMIC	C1608JB1C104KT-N	B
C392	CS0057	TANTALUM	TMCSA0J225MTR	B
C411	CU3047	CERAMIC	C1608JB1H103KT-N	B
C414	CU3019	CERAMIC	C1608CH1H470JT-AS	B
C415	CU3111	CERAMIC	C1608JB1C104KT-N	A
C416	CU3111	CERAMIC	C1608JB1C104KT-N	B
C418	CU3111	CERAMIC	C1608JB1C104KT-N	B
C421	CS0408	TANTALUM	6MCM156MATER	B
C422	CU3111	CERAMIC	C1608JB1C104KT-N	B
C423	CU3111	CERAMIC	C1608JB1C104KT-N	B
C424	CS0408	TANTALUM	6MCM156MATER	B
C425	CU3111	CERAMIC	C1608JB1C104KT-N	B
C426	CU3111	CERAMIC	C1608JB1C104KT-N	B
C427	CS0408	TANTALUM	6MCM156MATER	B
C429	CU3047	CERAMIC	C1608JB1H103KT-N	B
C430	CS0408	TANTALUM	6MCM156MATER	B
C431	CU3111	CERAMIC	C1608JB1C104KT-N	B
C432	CU3027	CERAMIC	C1608CH1H221JT-AS	B
C465	CU3047	CERAMIC	C1608JB1H103KT-N	B
C466	CU3047	CERAMIC	C1608JB1H103KT-N	B
C467	CU0108	CERAMIC	LMK212BJ105KG	B
C468	CU3111	CERAMIC	C1608JB1C104KT-N	A
C469	CU0108	CERAMIC	LMK212BJ105KG	A
C470	CU3111	CERAMIC	C1608JB1C104KT-N	B
C471	CS0408	TANTALUM	6MCM156MATER	B
C472	CS0378	TANTALUM	TMCMC0G107MTR	A
C473	CS0378	TANTALUM	TMCMC0G107MTR	A
C474	CU3111	CERAMIC	C1608JB1C104KT-N	B
C475	CS0378	TANTALUM	TMCMC0G107MTR	A
C476	CU3035	CERAMIC	C1608JB1H102KT-AS	B
C481	CU3111	CERAMIC	C1608JB1C104KT-N	B
C482	CU0108	CERAMIC	LMK212BJ105KG	B
C483	CU3047	CERAMIC	C1608JB1H103KT-N	B

C484	CU3047	CERAMIC	C1608JB1H103KT-N	B
C485	CU3045	CERAMIC	C1608JB1H682KT-NS	B
C486	CU3045	CERAMIC	C1608JB1H682KT-NS	B
C487	CU3111	CERAMIC	C1608JB1C104KT-N	B
C488	CU0108	CERAMIC	LMK212BJ105KG	B
C489	CU3023	CERAMIC	C1608CH1H101JT-AS	B
C490	CU3111	CERAMIC	C1608JB1C104KT-N	B
C491	CU3111	CERAMIC	C1608JB1C104KT-N	B
C492	CS0408	TANTALUM	6MCM156MATER	B
C493	CU3035	CERAMIC	C1608JB1H102KT-AS	B
C494	CU3047	CERAMIC	C1608JB1H103KT-N	B
C495	CU0108	CERAMIC	LMK212BJ105KG	B
C496	CU0108	CERAMIC	LMK212BJ105KG	B
C497	CS0408	TANTALUM	6MCM156MATER	B
C498	CU0108	CERAMIC	LMK212BJ105KG	A
C499	CU3111	CERAMIC	C1608JB1C104KT-N	B
C501	CU3120	CERAMIC	C1608JB1C683KT-NS	B
C502	CU3051	CERAMIC	C1608JB1E223KT-NS	B
C503	CU3047	CERAMIC	C1608JB1H103KT-N	B
C504	CU3049	CERAMIC	C1608JB1E153KT-NS	B
C505	CS0408	TANTALUM	6MCM156MATER	B
C506	CS0408	TANTALUM	6MCM156MATER	B
C507	CU3047	CERAMIC	C1608JB1H103KT-N	A
C508	CU3047	CERAMIC	C1608JB1H103KT-N	A
C509	CU3047	CERAMIC	C1608JB1H103KT-N	A
C510	CU3047	CERAMIC	C1608JB1H103KT-N	A
C511	CU3047	CERAMIC	C1608JB1H103KT-N	A
C512	CU3047	CERAMIC	C1608JB1H103KT-N	A
C513	CU3043	CERAMIC	C1608JB1H472KT-NS	A
C514	CU3035	CERAMIC	C1608JB1H102KT-AS	A
C515	CU3043	CERAMIC	C1608JB1H472KT-NS	A
C516	CU3035	CERAMIC	C1608JB1H102KT-AS	A
C517	CS0408	TANTALUM	6MCM156MATER	A
C518	CS0408	TANTALUM	6MCM156MATER	A
C519	CU3111	CERAMIC	C1608JB1C104KT-N	A
C520	CU3044	CERAMIC	C1608JB1H562KT-NS	A
C521	CU3035	CERAMIC	C1608JB1H102KT-AS	A
C522	CU3044	CERAMIC	C1608JB1H562KT-NS	A
C523	CU3035	CERAMIC	C1608JB1H102KT-AS	A
C524	CU3111	CERAMIC	C1608JB1C104KT-N	A
C525	CU3013	CERAMIC	C1608CH1H150JT-AS	A

C526	CS0408	TANTALUM	6MCM156MATER	A
C527	CS0408	TANTALUM	6MCM156MATER	A
C528	CU3111	CERAMIC	C1608JB1C104KT-N	A
C529	CU3043	CERAMIC	C1608JB1H472KT-NS	A
C530	CU3111	CERAMIC	C1608JB1C104KT-N	A
C531	CU3039	CERAMIC	C1608JB1H222KT-AS	B
C532	CU3039	CERAMIC	C1608JB1H222KT-AS	B
C533	CU3039	CERAMIC	C1608JB1H222KT-AS	B
C534	CU3039	CERAMIC	C1608JB1H222KT-AS	B
C535	CU3111	CERAMIC	C1608JB1C104KT-N	B
C536	CU3039	CERAMIC	C1608JB1H222KT-AS	B
C537	CU3039	CERAMIC	C1608JB1H222KT-AS	B
C538	CU3039	CERAMIC	C1608JB1H222KT-AS	B
C539	CU3039	CERAMIC	C1608JB1H222KT-AS	B
C540	CU3111	CERAMIC	C1608JB1C104KT-N	B
C541	CS0408	TANTALUM	6MCM156MATER	B
C542	CS0408	TANTALUM	6MCM156MATER	B
C560	CU3029	CERAMIC	C1608JB1H331KT-AS	B
C561	CU3111	CERAMIC	C1608JB1C104KT-N	B
C562	CU3047	CERAMIC	C1608JB1H103KT-N	B
C563	CU3051	CERAMIC	C1608JB1E223KT-NS	B
C564	CU3035	CERAMIC	C1608JB1H102KT-AS	B
C565	CU3019	CERAMIC	C1608CH1H470JT-AS	A
C566	CU3019	CERAMIC	C1608CH1H470JT-AS	B
C567	CU3111	CERAMIC	C1608JB1C104KT-N	B
C568	CU3019	CERAMIC	C1608CH1H470JT-AS	B
C569	CU3019	CERAMIC	C1608CH1H470JT-AS	A
CN301	UE0407	CONNECTOR	AXK4S50535P	B
CN302	UP0282	P.C.BOARD	DJG5 IF-RF FLEX.	H
D301	XD0307	DIODE	1SS312(TE85L)	A
D302	XD0313	DIODE	HVU350TRF	A
D303	XD0313	DIODE	HVU350TRF	A
D304	XD0272	DIODE	1SS356 TW11	A
D305	XD0230	DIODE	DAN202U T106	B
D306	XD0230	DIODE	DAN202U T106	B
D307	XD0272	DIODE	1SS356 TW11	A
D308	XD0290	DIODE	MA111-TX	B
D309	XD0252	DIODE	MA741WK TX	A
D310	XD0350	DIODE	HN2V02H-B(TE12R)	B
D312	XD0272	DIODE	1SS356 TW11	B
D313	XD0351	DIODE	PS7200B-1A-E3	A

D315	XD0250	DIODE	MA742 TX	A
FL301	XF0048	XTAL FILTER	45S30B2 (RE63SM115)	A
FL302	XC0024	CERA.FILTER	CFWM455F	M
FL303	XC0025	CERA.FILTER	CFWM455I	M
FL304	XC0078	CERA.FILTER	SFT10.7MA5-Z	M
IC301	XA0666	IC	TK10931VTL	A
IC302	XA0506	IC	BU4094BCFV-E2	B
IC303	XA0506	IC	BU4094BCFV-E2	B
IC304	XA0783	IC	MM3023DNRE	A
IC305	XA0524	IC	TC7S66FU(TE85L)	B
IC306	XA0523	IC	TC7SU04FU(TE85L)	B
IC307	XA0348	IC	TC4W53FU(TE12)	B
IC308	XA0667	IC	TA4101F (TE12L)	B
IC310	XA0348	IC	TC4W53FU(TE12)	B
IC315	XA0465	IC	TC75S51F(TE85L)	B
IC316	XA0786	IC	LA3335M-TE-L	B
IC317	XA0787	IC	CXA1622M T4	B
IC501	XA0573	IC	NJM2904V-TE1	B
IC501	XA0573	IC	NJM2904V-TE1	B
IC502	XA0596	IC	NJM2902V-TE1	A
IC502	XA0596	IC	NJM2902V-TE1	A
IC502	XA0596	IC	NJM2902V-TE1	A
IC502	XA0596	IC	NJM2902V-TE1	A
IC503	XA0573	IC	NJM2904V-TE1	A
IC503	XA0573	IC	NJM2904V-TE1	A
IC504	XA0785	IC	TC4051BFT(EL)	A
IC505	XA0342	IC	NJM2100V-TE1	A
IC506	XA0596	IC	NJM2902V-TE1	B
IC506	XA0596	IC	NJM2902V-TE1	B
IC506	XA0596	IC	NJM2902V-TE1	B
IC506	XA0596	IC	NJM2902V-TE1	B
IC507	XA0798	IC	TC75W56FU(TE12L)	B
IC507	XA0798	IC	TC75W56FU(TE12L)	B
IC510	XA0348	IC	TC4W53FU(TE12)	A
JK301	UJ0019	CONNECTOR	HSJ1493-01-010	M
JK302	UJ0022	CONNECTOR	HSJ1102-01-540	M
L301	QC0507	COIL	LK16081R0K-T	A
L302	QA0160	COIL	K5-S2/33331 PK1-0042	A
L303	QA0159	COIL	K5-S2/33331 R12T521Y	A
L304	QC0507	COIL	LK16081R0K-T	B
L305	QC0522	COIL	LQH1N1R5J04	B

L306	QC0548	COIL	LK1608 R68K-T	A
L307	QC0522	COIL	LQH1N1R5J04	A
Q301	XT0108	TRANSISTOR	2SC4649-TLN	A
Q302	XU0063	TRANSISTOR	UN9211 TX	A
Q303	XT0150	TRANSISTOR	2SC4738(TE85L)	A
Q304	XE0033	FET	2SK425-T1B X13 X14	A
Q305	XU0063	TRANSISTOR	UN9211 TX	B
Q306	XE0042	FET	3SK254-T2	B
Q307	XT0108	TRANSISTOR	2SC4649-TLN	A
Q308	XT0108	TRANSISTOR	2SC4649-TLN	B
Q309	XU0171	TRANSISTOR	XP1111-TX	B
Q310	XU0171	TRANSISTOR	XP1111-TX	B
Q312	XT0088	TRANSISTOR	2SA1213Y TE12R	B
Q313	XU0172	TRANSISTOR	XP1501-TX	B
Q314	XU0063	TRANSISTOR	UN9211 TX	B
Q316	XU0164	TRANSISTOR	XN1212-TX	B
Q317	XU0063	TRANSISTOR	UN9211 TX	B
Q318	XU0047	TRANSISTOR	UMC3NTR	B
Q319	XU0063	TRANSISTOR	UN9211 TX	A
Q320	XU0153	TRANSISTOR	UMG7NTR	A
Q322	XU0063	TRANSISTOR	UN9211 TX	A
Q501	XU0185	DIG TR.	DTA143ZEA TL	B
Q502	XU0185	DIG TR.	DTA143ZEA TL	A
R301	RK3031	RESISTOR	MCR03EZHJ271	A
R302	RK3050	RESISTOR	MCR03EZHJ103	A
R303	RK3050	RESISTOR	MCR03EZHJ103	A
R304	RK3040	RESISTOR	MCR03EZHJ152	A
R306	RK3070	RESISTOR	MCR03EZHJ474	A
R307	RK3026	RESISTOR	MCR03EZHJ101	A
R308	RK3066	RESISTOR	MCR03EZHJ224	A
R309	RK3062	RESISTOR	MCR03EZHJ104	A
R310	RK3062	RESISTOR	MCR03EZHJ104	A
R311	RK3026	RESISTOR	MCR03EZHJ101	A
R312	RK3043	RESISTOR	MCR03EZHJ272	A
R313	RK3035	RESISTOR	MCR03EZHJ561	A
R314	RK3058	RESISTOR	MCR03EZHJ473	A
R315	RK3042	RESISTOR	MCR03EZHJ222	A
R316	RK3072	RESISTOR	MCR03EZHJ684	B
R317	RK3047	RESISTOR	MCR03EZHJ562	A
R318	RK3050	RESISTOR	MCR03EZHJ103	B
R319	RK3050	RESISTOR	MCR03EZHJ103	B

R320	RK3046	RESISTOR	MCR03EZHJ472	B
R321	RK3050	RESISTOR	MCR03EZHJ103	B
R322	RK3050	RESISTOR	MCR03EZHJ103	B
R323	RK3050	RESISTOR	MCR03EZHJ103	B
R324	RK3070	RESISTOR	MCR03EZHJ474	A
R325	RK3046	RESISTOR	MCR03EZHJ472	A
R326	RK3054	RESISTOR	MCR03EZHJ223	A
R327	RK3046	RESISTOR	MCR03EZHJ472	B
R328	RK3050	RESISTOR	MCR03EZHJ103	A
R329	RK3055	RESISTOR	MCR03EZHJ273	A
R330	RK3038	RESISTOR	MCR03EZHJ102	A
R331	RK3022	RESISTOR	MCR03EZHJ470	B
R332	RK3050	RESISTOR	MCR03EZHJ103	A
R333	RK3050	RESISTOR	MCR03EZHJ103	B
R334	RK3050	RESISTOR	MCR03EZHJ103	B
R335	RK3038	RESISTOR	MCR03EZHJ102	A
R336	RK3026	RESISTOR	MCR03EZHJ101	A
R338	RK3058	RESISTOR	MCR03EZHJ473	A
R339	RK3050	RESISTOR	MCR03EZHJ103	A
R340	RK3050	RESISTOR	MCR03EZHJ103	B
R351	RK3054	RESISTOR	MCR03EZHJ223	B
R352	RK3054	RESISTOR	MCR03EZHJ223	B
R353	RK3054	RESISTOR	MCR03EZHJ223	B
R356	RK3026	RESISTOR	MCR03EZHJ101	B
R357	RK3026	RESISTOR	MCR03EZHJ101	A
R359	RK3061	RESISTOR	MCR03EZHJ823	A
R361	RK3026	RESISTOR	MCR03EZHJ101	A
R362	RK3050	RESISTOR	MCR03EZHJ103	A
R363	RK3026	RESISTOR	MCR03EZHJ101	B
R364	RK3068	RESISTOR	MCR03EZHJ334	B
R365	RK3034	RESISTOR	MCR03EZHJ471	B
R370	RK3050	RESISTOR	MCR03EZHJ103	A
R371	RK3001	RESISTOR	MCR03EZHJ000	A
R372	RK3046	RESISTOR	MCR03EZHJ472	A
R373	RK3001	RESISTOR	MCR03EZHJ000	A
R381	RK3062	RESISTOR	MCR03EZHJ104	B
R382	RK3056	RESISTOR	MCR03EZHJ333	B
R383	RK3042	RESISTOR	MCR03EZHJ222	B
R384	RK3058	RESISTOR	MCR03EZHJ473	B
R385	RK3043	RESISTOR	MCR03EZHJ272	B
R386	RK3038	RESISTOR	MCR03EZHJ102	B



R387	RK3038	RESISTOR	MCR03EZHJ102	B
R388	RK3038	RESISTOR	MCR03EZHJ102	B
R391	RK3031	RESISTOR	MCR03EZHJ271	A
R392	RK3017	RESISTOR	MCR03EZHJ180	A
R401	RK3050	RESISTOR	MCR03EZHJ103	A
R402	RK3074	RESISTOR	MCR03EZHJ105	A
R403	RK3050	RESISTOR	MCR03EZHJ103	A
R404	RK3074	RESISTOR	MCR03EZHJ105	B
R405	RK3050	RESISTOR	MCR03EZHJ103	B
R406	RK3026	RESISTOR	MCR03EZHJ101	A
R407	RK3050	RESISTOR	MCR03EZHJ103	B
R409	RK3026	RESISTOR	MCR03EZHJ101	B
R410	RK3026	RESISTOR	MCR03EZHJ101	B
R413	RK3074	RESISTOR	MCR03EZHJ105	A
R415	RK3026	RESISTOR	MCR03EZHJ101	B
R417	RK3022	RESISTOR	MCR03EZHJ470	B
R418	RK3022	RESISTOR	MCR03EZHJ470	B
R443	RK3072	RESISTOR	MCR03EZHJ684	B
R472	RK3038	RESISTOR	MCR03EZHJ102	B
R473	RK3050	RESISTOR	MCR03EZHJ103	B
R474	RK3038	RESISTOR	MCR03EZHJ102	B
R475	RK3046	RESISTOR	MCR03EZHJ472	B
R476	RK3001	RESISTOR	MCR03EZHJ000	B
R477	RK3068	RESISTOR	MCR03EZHJ334	B
R478	RK3068	RESISTOR	MCR03EZHJ334	A
R479	RK3055	RESISTOR	MCR03EZHJ273	A
R480	RK3038	RESISTOR	MCR03EZHJ102	A
R482	RK3022	RESISTOR	MCR03EZHJ470	B
R483	RK3028	RESISTOR	MCR03EZHJ151	A
R485	RK3062	RESISTOR	MCR03EZHJ104	B
R486	RK3062	RESISTOR	MCR03EZHJ104	A
R487	RK3034	RESISTOR	MCR03EZHJ471	A
R488	RK3026	RESISTOR	MCR03EZHJ101	A
R489	RK3026	RESISTOR	MCR03EZHJ101	A
R490	RK3044	RESISTOR	MCR03EZHJ332	A
R491	RK3058	RESISTOR	MCR03EZHJ473	A
R492	RK3034	RESISTOR	MCR03EZHJ471	A
R493	RK3028	RESISTOR	MCR03EZHJ151	A
R494	RK3074	RESISTOR	MCR03EZHJ105	A
R495	RK3059	RESISTOR	MCR03EZHJ563	B
R501	RK3040	RESISTOR	MCR03EZHJ152	B

R502	RK3044	RESISTOR	MCR03EZHJ332	B
R503	RK3043	RESISTOR	MCR03EZHJ272	B
R504	RK3049	RESISTOR	MCR03EZHJ822	B
R505	RK3049	RESISTOR	MCR03EZHJ822	B
R506	RK3050	RESISTOR	MCR03EZHJ103	B
R507	RK3022	RESISTOR	MCR03EZHJ470	B
R508	RK3052	RESISTOR	MCR03EZHJ153	B
R509	RK3050	RESISTOR	MCR03EZHJ103	B
R510	RK3055	RESISTOR	MCR03EZHJ273	A
R511	RK3064	RESISTOR	MCR03EZHJ154	A
R512	RK3055	RESISTOR	MCR03EZHJ273	A
R513	RK3064	RESISTOR	MCR03EZHJ154	A
R514	RK3055	RESISTOR	MCR03EZHJ273	A
R515	RK3055	RESISTOR	MCR03EZHJ273	A
R516	RK3052	RESISTOR	MCR03EZHJ153	A
R517	RK3055	RESISTOR	MCR03EZHJ273	A
R518	RK3055	RESISTOR	MCR03EZHJ273	A
R519	RK3052	RESISTOR	MCR03EZHJ153	A
R520	RK3052	RESISTOR	MCR03EZHJ153	A
R521	RK3050	RESISTOR	MCR03EZHJ103	A
R522	RK3022	RESISTOR	MCR03EZHJ470	A
R523	RK3066	RESISTOR	MCR03EZHJ224	A
R524	RK3068	RESISTOR	MCR03EZHJ334	A
R525	RK3064	RESISTOR	MCR03EZHJ154	A
R526	RK3066	RESISTOR	MCR03EZHJ224	A
R527	RK3068	RESISTOR	MCR03EZHJ334	A
R528	RK3064	RESISTOR	MCR03EZHJ154	A
R529	RK3064	RESISTOR	MCR03EZHJ154	A
R530	RK3064	RESISTOR	MCR03EZHJ154	A
R531	RK3001	RESISTOR	MCR03EZHJ000	A
R532	RK3064	RESISTOR	MCR03EZHJ154	A
R533	RK3056	RESISTOR	MCR03EZHJ333	A
R534	RK3001	RESISTOR	MCR03EZHJ000	A
R535	RK3068	RESISTOR	MCR03EZHJ334	A
R536	RK3056	RESISTOR	MCR03EZHJ333	B
R537	RK3050	RESISTOR	MCR03EZHJ103	A
R538	RK3066	RESISTOR	MCR03EZHJ224	A
R539	RK3022	RESISTOR	MCR03EZHJ470	A
R540	RK3052	RESISTOR	MCR03EZHJ153	A
R541	RK3050	RESISTOR	MCR03EZHJ103	A
R542	RK3054	RESISTOR	MCR03EZHJ223	A

R543	RK3068	RESISTOR	MCR03EZHJ334	A
R544	RK3065	RESISTOR	MCR03EZHJ184	B
R545	RK3040	RESISTOR	MCR03EZHJ152	B
R546	RK3065	RESISTOR	MCR03EZHJ184	B
R547	RK3039	RESISTOR	MCR03EZHJ122	B
R548	RK3072	RESISTOR	MCR03EZHJ684	B
R549	RK3050	RESISTOR	MCR03EZHJ103	B
R550	RK3050	RESISTOR	MCR03EZHJ103	B
R551	RK3074	RESISTOR	MCR03EZHJ105	B
R552	RK3065	RESISTOR	MCR03EZHJ184	B
R553	RK3039	RESISTOR	MCR03EZHJ122	B
R554	RK3072	RESISTOR	MCR03EZHJ684	B
R555	RK3065	RESISTOR	MCR03EZHJ184	B
R556	RK3040	RESISTOR	MCR03EZHJ152	B
R557	RK3072	RESISTOR	MCR03EZHJ684	B
R558	RK3050	RESISTOR	MCR03EZHJ103	B
R559	RK3050	RESISTOR	MCR03EZHJ103	B
R560	RK3074	RESISTOR	MCR03EZHJ105	B
R561	RK3022	RESISTOR	MCR03EZHJ470	B
R562	RK3052	RESISTOR	MCR03EZHJ153	B
R563	RK3050	RESISTOR	MCR03EZHJ103	B
R571	RK3070	RESISTOR	MCR03EZHJ474	B
R572	RK3070	RESISTOR	MCR03EZHJ474	B
R573	RK3058	RESISTOR	MCR03EZHJ473	B
R574	RK3058	RESISTOR	MCR03EZHJ473	B
R580	RK3044	RESISTOR	MCR03EZHJ332	B
R581	RK3056	RESISTOR	MCR03EZHJ333	B
R582	RK3068	RESISTOR	MCR03EZHJ334	B
R584	RK3074	RESISTOR	MCR03EZHJ105	B
R585	RK3062	RESISTOR	MCR03EZHJ104	B
R587	RK3038	RESISTOR	MCR03EZHJ102	A
R588	RK3038	RESISTOR	MCR03EZHJ102	B
R589	RK3038	RESISTOR	MCR03EZHJ102	B
R590	RK3038	RESISTOR	MCR03EZHJ102	A
RE301	UR0012	PULSE SWITC	EC09P20-289	H
VR301	RH0144	VARIABLE R.	MVR22HXBRN223	A
VR302	RH0144	VARIABLE R.	MVR22HXBRN223	A
VR303	RH0142	VARIABLE R.	MVR22HXBRN103	A
VR304	RH0142	VARIABLE R.	MVR22HXBRN103	A
VR305	RH0146	VARIABLE R.	MVR22HXBRN473	A
VR306	RH0142	VARIABLE R.	MVR22HXBRN103	A

VR307	RH0146	VARIABLE R.	MVR22HXBRN473	A
X301	XQ0136	XTAL	TOPB44.595MRE0501400	A
X302	XQ0137	XTAL	TOPB34.35M(RE0501300	B
X303	XC0027	CERA.FILTER	CSK455J	M

<b>UNIT</b>		PTT			
<b>Ref. No.</b>	<b>Parts No.</b>	<b>DESCRIPTION</b>	<b>Parts Name</b>	<b>LOC</b>	<b>RMKS</b>

CN104	UP0281	P.C.BOARD	DJG5 CPU-PTT FLEX.	H	
SW110	UU0018	SWITCH	SOP-112HST	A	
SW111	UU0018	SWITCH	SOP-112HST	A	
SW112	UU0018	SWITCH	SOP-112HST	A	
SW113	UU0018	SWITCH	SOP-112HST	A	

<b>UNIT</b>		REG			
<b>Ref. No.</b>	<b>Parts No.</b>	<b>DESCRIPTION</b>	<b>Parts Name</b>	<b>LOC</b>	<b>RMKS</b>

	TN0010		SHIELD PLATE DJX20	H	
	UX1269	WIRE	DJX20 W10	H	
C901	CS0225	TANTALUM	TMCMA1D155MTR	A	
C902	CU3111	CERAMIC	C1608JB1C104KT-N	A	
C903	CU3111	CERAMIC	C1608JB1C104KT-N	A	
C904	CS0237	TANTALUM	TMCMA1A475MTR	A	
C905	CU3047	CERAMIC	C1608JB1H103KT-N	A	
C906	CU3047	CERAMIC	C1608JB1H103KT-N	A	
C907	CU3047	CERAMIC	C1608JB1H103KT-N	A	
CN902	UE0419	CONNECTOR	9210B-1-02Z087-T	H	
CN903	UE0419	CONNECTOR	9210B-1-02Z087-T	H	
D901	XD0352	DIODE	CRS01(TE85L)	A	
D902	XD0352	DIODE	CRS01(TE85L)	A	
IC901	XA0816	IC	TA7808F(TE16L)	A	
JK901	UJ0015	CONNECTOR	HEC2781 010020	M	
R901	RK3050	RESISTOR	MCR03EZHJ103	A	

<b>UNIT</b>		RF			
<b>Ref. No.</b>	<b>Parts No.</b>	<b>DESCRIPTION</b>	<b>Parts Name</b>	<b>LOC</b>	<b>RMKS</b>

	UP0410B	P.C.BOARD	DJX2000 INTEGRATED	A	
	RD0108	RESISTOR	J1/6Z	H	
	TN0009		RF SHIELD DJX20	H	
C600	CU3013	CERAMIC	C1608CH1H150JT-AS	A	T E
C601	CU3111	CERAMIC	C1608JB1C104KT-N	A	
C602	CU3111	CERAMIC	C1608JB1C104KT-N	A	
C603	CU3047	CERAMIC	C1608JB1H103KT-N	A	
C604	CU3111	CERAMIC	C1608JB1C104KT-N	A	
C608	CU3035	CERAMIC	C1608JB1H102KT-AS	A	

C609	CU3111	CERAMIC	C1608JB1C104KT-N	A	
C610	CU3035	CERAMIC	C1608JB1H102KT-AS	A	
C612	CU3111	CERAMIC	C1608JB1C104KT-N	A	
C613	CU3035	CERAMIC	C1608JB1H102KT-AS	A	
C616	CU3035	CERAMIC	C1608JB1H102KT-AS	A	
C617	CU3035	CERAMIC	C1608JB1H102KT-AS	A	
C618	CU3011	CERAMIC	C1608CH1H100DT-AS	A	T E
C619	CS0408	TANTALUM	6MCM156MATER	A	
C620	CS0408	TANTALUM	6MCM156MATER	A	
C621	CU3111	CERAMIC	C1608JB1C104KT-N	A	
C622	CU3035	CERAMIC	C1608JB1H102KT-AS	A	
C623	CU3035	CERAMIC	C1608JB1H102KT-AS	A	
C624	CS0408	TANTALUM	6MCM156MATER	B	
C625	CU3035	CERAMIC	C1608JB1H102KT-AS	A	
C626	CS0408	TANTALUM	6MCM156MATER	B	
C627	CU3047	CERAMIC	C1608JB1H103KT-N	A	
C628	CU3047	CERAMIC	C1608JB1H103KT-N	A	
C629	CU3004	CERAMIC	C1608CH1H030CT-AS	B	
C630	CU3064	CERAMIC	C1608CH1H1R5CT-AS	B	
C631	CU3064	CERAMIC	C1608CH1H1R5CT-AS	B	
C632	CU3064	CERAMIC	C1608CH1H1R5CT-AS	B	
C633	CU3004	CERAMIC	C1608CH1H030CT-AS	B	
C635	CU3111	CERAMIC	C1608JB1C104KT-N	A	
C636	CS0057	TANTALUM	TMCSA0J225MTR	A	
C637	CU3047	CERAMIC	C1608JB1H103KT-N	A	
C638	CU3111	CERAMIC	C1608JB1C104KT-N	A	
C639	CU3111	CERAMIC	C1608JB1C104KT-N	A	
C640	CU3023	CERAMIC	C1608CH1H101JT-AS	B	
C641	CU3019	CERAMIC	C1608CH1H470JT-AS	B	
C642	CU3004	CERAMIC	C1608CH1H030CT-AS	B	
C645	CU3111	CERAMIC	C1608JB1C104KT-N	B	
C646	CU3023	CERAMIC	C1608CH1H101JT-AS	B	
C651	CU3035	CERAMIC	C1608JB1H102KT-AS	B	
C653	CU3023	CERAMIC	C1608CH1H101JT-AS	A	T E
C655	CU3047	CERAMIC	C1608JB1H103KT-N	B	
C656	CS0408	TANTALUM	6MCM156MATER	B	
C657	CU3035	CERAMIC	C1608JB1H102KT-AS	A	
C658	CU3111	CERAMIC	C1608JB1C104KT-N	A	
C659	CU3004	CERAMIC	C1608CH1H030CT-AS	B	
C660	CU3004	CERAMIC	C1608CH1H030CT-AS	B	
C661	CU3017	CERAMIC	C1608CH1H330JT-AS	A	T E

C662	CU3111	CERAMIC	C1608JB1C104KT-N	B
C664	CU3035	CERAMIC	C1608JB1H102KT-AS	B
C665	CU3011	CERAMIC	C1608CH1H100DT-AS	B
C666	CU3009	CERAMIC	C1608CH1H080CT-A	B
C667	CU3002	CERAMIC	C1608CH1H010CT-AS	B
C668	CU3035	CERAMIC	C1608JB1H102KT-AS	B
C670	CU3111	CERAMIC	C1608JB1C104KT-N	B
C672	CU3023	CERAMIC	C1608CH1H101JT-AS	B
C673	CU3035	CERAMIC	C1608JB1H102KT-AS	B
C674	CU3006	CERAMIC	C1608CH1H050CT-AS	B
C675	CU3006	CERAMIC	C1608CH1H050CT-AS	B
C677	CU3035	CERAMIC	C1608JB1H102KT-AS	B
C678	CU3035	CERAMIC	C1608JB1H102KT-AS	A
C679	CU3047	CERAMIC	C1608JB1H103KT-N	B
C680	CU3011	CERAMIC	C1608CH1H100DT-AS	B
C681	CU3014	CERAMIC	C1608CH1H180JT-AS	B
C683	CU3035	CERAMIC	C1608JB1H102KT-AS	B
C685	CU3023	CERAMIC	C1608CH1H101JT-AS	B
C687	CU3111	CERAMIC	C1608JB1C104KT-N	A
C688	CU3011	CERAMIC	C1608CH1H100DT-AS	B
C689	CU3008	CERAMIC	C1608CH1H070CT-A	B
C690	CU3008	CERAMIC	C1608CH1H070CT-A	B
C692	CU3035	CERAMIC	C1608JB1H102KT-AS	B
C693	CU3023	CERAMIC	C1608CH1H101JT-AS	B
C694	CU3015	CERAMIC	C1608CH1H220JT-AS	B
C695	CU3019	CERAMIC	C1608CH1H470JT-AS	B
C696	CU3015	CERAMIC	C1608CH1H220JT-AS	B
C697	CU3035	CERAMIC	C1608JB1H102KT-AS	B
C699	CU3035	CERAMIC	C1608JB1H102KT-AS	B
C700	CU3035	CERAMIC	C1608JB1H102KT-AS	A
C701	CU3047	CERAMIC	C1608JB1H103KT-N	B
C704	CU3009	CERAMIC	C1608CH1H080CT-A	B
C705	CU3009	CERAMIC	C1608CH1H080CT-A	B
C707	CU3035	CERAMIC	C1608JB1H102KT-AS	A
C708	CU3019	CERAMIC	C1608CH1H470JT-AS	B
C709	CU3023	CERAMIC	C1608CH1H101JT-AS	B
C710	CU3019	CERAMIC	C1608CH1H470JT-AS	B
C711	CU3035	CERAMIC	C1608JB1H102KT-AS	B
C713	CU3035	CERAMIC	C1608JB1H102KT-AS	B
C714	CU3019	CERAMIC	C1608CH1H470JT-AS	A
C715	CU3019	CERAMIC	C1608CH1H470JT-AS	A

C716	CU3019	CERAMIC	C1608CH1H470JT-AS	A	
C718	CU3020	CERAMIC	C1608CH1H560JT-AS	B	
C719	CU3020	CERAMIC	C1608CH1H560JT-AS	B	
C720	CU3035	CERAMIC	C1608JB1H102KT-AS	B	T E
C721	CU3023	CERAMIC	C1608CH1H101JT-AS	A	T E
C722	CU3111	CERAMIC	C1608JB1C104KT-N	B	
C723	CU3018	CERAMIC	C1608CH1H390JT-AS	B	
C724	CU3021	CERAMIC	C1608CH1H680JT-AS	B	
C725	CU3018	CERAMIC	C1608CH1H390JT-AS	B	
C726	CU3047	CERAMIC	C1608JB1H103KT-N	B	
C728	CU3047	CERAMIC	C1608JB1H103KT-N	B	
C729	CU3035	CERAMIC	C1608JB1H102KT-AS	B	
C730	CS0408	TANTALUM	6MCM156MATER	B	
C732	CU3111	CERAMIC	C1608JB1C104KT-N	B	
C733	CU3047	CERAMIC	C1608JB1H103KT-N	B	
C734	CU3028	CERAMIC	C1608CH1H271JT-AS	B	
C735	CU3028	CERAMIC	C1608CH1H271JT-AS	B	
C736	CU3024	CERAMIC	C1608CH1H121JT-AS	B	
C737	CU3024	CERAMIC	C1608CH1H121JT-AS	B	
C738	CU3111	CERAMIC	C1608JB1C104KT-N	B	
C739	CU3111	CERAMIC	C1608JB1C104KT-N	B	
C740	CU3035	CERAMIC	C1608JB1H102KT-AS	B	
C741	CS0408	TANTALUM	6MCM156MATER	B	
C742	CU3035	CERAMIC	C1608JB1H102KT-AS	A	
C743	CS0384	TANTALUM	TMCMB1V225MTR	A	
C745	CU3111	CERAMIC	C1608JB1C104KT-N	B	
C746	CU3035	CERAMIC	C1608JB1H102KT-AS	A	
C747	CU3035	CERAMIC	C1608JB1H102KT-AS	A	
C748	CU3064	CERAMIC	C1608CH1H1R5CT-AS	B	
C749	CU3064	CERAMIC	C1608CH1H1R5CT-AS	B	
C752	CU3003	CERAMIC	C1608CH1H020CT-AS	B	
C753	CU3119	CERAMIC	C1608UJ1H050CT-A	B	
C754	CU3035	CERAMIC	C1608JB1H102KT-AS	B	
C755	CU3035	CERAMIC	C1608JB1H102KT-AS	B	
C756	CU3035	CERAMIC	C1608JB1H102KT-AS	A	
C757	CU3035	CERAMIC	C1608JB1H102KT-AS	B	
C758	CU3023	CERAMIC	C1608CH1H101JT-AS	B	
C759	CU3035	CERAMIC	C1608JB1H102KT-AS	B	
D600	XD0342	DIODE	1SS390 TE61	A	
D601	XD0342	DIODE	1SS390 TE61	A	
D602	XD0306	DIODE	1SS295(TE85L)	A	

D604	XD0342	DIODE	1SS390 TE61	A	
D605	XD0342	DIODE	1SS390 TE61	A	
D606	XD0342	DIODE	1SS390 TE61	A	
D607	XD0342	DIODE	1SS390 TE61	A	
D609	XD0250	DIODE	MA742 TX	A	
D610	XD0342	DIODE	1SS390 TE61	B	
D611	XD0342	DIODE	1SS390 TE61	B	
D615	XD0342	DIODE	1SS390 TE61	B	
D616	XD0342	DIODE	1SS390 TE61	B	
D617	XD0342	DIODE	1SS390 TE61	B	
D618	XD0342	DIODE	1SS390 TE61	B	
D619	XD0342	DIODE	1SS390 TE61	B	
D622	XD0342	DIODE	1SS390 TE61	B	
D623	XD0342	DIODE	1SS390 TE61	B	
D624	XD0342	DIODE	1SS390 TE61	B	
D625	XD0342	DIODE	1SS390 TE61	B	
D626	XD0342	DIODE	1SS390 TE61	B	
D627	XD0342	DIODE	1SS390 TE61	B	
D628	XD0342	DIODE	1SS390 TE61	B	
D629	XD0342	DIODE	1SS390 TE61	B	
D630	XD0342	DIODE	1SS390 TE61	B	
D631	XD0342	DIODE	1SS390 TE61	B	
D633	XD0342	DIODE	1SS390 TE61	B	
D634	XD0342	DIODE	1SS390 TE61	B	
D635	XD0342	DIODE	1SS390 TE61	B	T E
D637	XD0342	DIODE	1SS390 TE61	B	
D638	XD0342	DIODE	1SS390 TE61	B	
D639	XD0342	DIODE	1SS390 TE61	A	
D640	XD0342	DIODE	1SS390 TE61	A	
D641	XD0342	DIODE	1SS390 TE61	A	
FL600	XC0076	SAW FILTER	NSVA321	B	
FL601	XC0077	SAW FILTER	NSVA476	B	
IC602	XA0802	IC	XC9536XL-10VQ64C	A	T
IC602	XA0801	IC	XC9536XL-10VQ64C	A	E
IC603	XA0495	IC	TC7S04FU-TE85L	A	
IC604	XA0788	IC	UPB1509GV-E1	A	
IC606	XA0595	IC	TK11233BMCL	A	
IC607	XA0783	IC	MM3023DNRE	B	
IC608	XA0564	IC	UPC2745T-E3	B	
IC609	XA0790	IC	NJU6323-TE1#ZF	A	
IC610	XA0790	IC	NJU6323-TE1#ZF	A	



IC611	XA0546	IC	UPC2758T	B	
IC612	XA0506	IC	BU4094BCFV-E2	A	
IC613	XA0506	IC	BU4094BCFV-E2	A	
IC615	XA0743	IC	UPC2757T-E3	B	
IC616	XA0595	IC	TK11233BMCL	B	
L600	QC0559	COIL	LL1608-FH6N8J	B	
L601	QC0558	COIL	LL1608-FH5N6S	B	
L602	QC0558	COIL	LL1608-FH5N6S	B	
L603	QC0559	COIL	LL1608-FH6N8J	B	
L609	QC0563	COIL	LL1608-FH15NJ	B	
L610	QC0563	COIL	LL1608-FH15NJ	B	
L611	QC0558	COIL	LL1608-FH5N6S	B	
L612	QC0561	COIL	LL1608-FH10NJ	B	
L613	QC0561	COIL	LL1608-FH10NJ	B	
L617	QC0616	COIL	LL1608-FS12NJ	B	
L618	QC0568	COIL	LL1608-FH39NJ	B	
L619	QC0568	COIL	LL1608-FH39NJ	B	
L620	QC0564	COIL	LL1608-FH18NJ	B	
L621	QC0561	COIL	LL1608-FH10NJ	B	
L622	QC0564	COIL	LL1608-FH18NJ	B	
L624	QC0568	COIL	LL1608-FH39NJ	A	T E
L625	QC0573	COIL	LL1608-FHR10J	B	
L626	QC0573	COIL	LL1608-FHR10J	B	
L627	QC0565	COIL	LL1608-FH22NJ	B	
L628	QC0562	COIL	LL1608-FH12NJ	B	
L629	QC0565	COIL	LL1608-FH22NJ	B	
L631	QC0633	COIL	MLF1608DR18K-T	B	
L632	QC0633	COIL	MLF1608DR18K-T	B	
L633	QC0563	COIL	LL1608-FH15NJ	B	
L634	QC0566	COIL	LL1608-FH27NJ	B	
L635	QC0566	COIL	LL1608-FH27NJ	B	
L636	QC0546	COIL	LK1608 R12K-T	B	
L637	QC0546	COIL	LK1608 R12K-T	B	
L638	QC0573	COIL	LL1608-FHR10J	B	
L639	QC0633	COIL	MLF1608DR18K-T	B	
L640	QC0568	COIL	LL1608-FH39NJ	A	T E
L641	QC0633	COIL	MLF1608DR18K-T	B	
L642	QC0512	COIL	LQH1NR33K04	B	
L643	QC0512	COIL	LQH1NR33K04	B	
L644	QC0512	COIL	LQH1NR33K04	B	
L645	QC0563	COIL	LL1608-FH15NJ	B	

L646	QC0623	COIL	LL1608-FS47NJ	B	
L647	QC0570	COIL	LL1608-FH56NJ	B	
L650	QC0559	COIL	LL1608-FH6N8J	B	
L651	QC0570	COIL	LL1608-FH56NJ	B	
L652	QC0615	COIL	LL1608-FS10NJ	B	
Q600	XT0152	TRANSISTOR	2SC5007-T1-FB	A	
Q602	XU0185	DIG TR.	DTA143ZEA TL	A	
Q603	XT0152	TRANSISTOR	2SC5007-T1-FB	A	
Q605	XU0171	TRANSISTOR	XP1111-TX	A	
Q606	XU0171	TRANSISTOR	XP1111-TX	B	
Q607	XT0153	TRANSISTOR	2SC5008-T1-FB	B	
Q608	XU0171	TRANSISTOR	XP1111-TX	A	
Q610	XU0185	DIG TR.	DTA143ZEA TL	B	T E
Q611	XU0171	TRANSISTOR	XP1111-TX	A	
Q612	XU0171	TRANSISTOR	XP1111-TX	B	
Q613	XU0186	DIG TR.	DTC143ZEA TL	B	T E
Q614	XT0151	TRANSISTOR	2SC5006-T1-FB	B	
Q615	XT0149	TRANSISTOR	2SC4181-T1-L18	A	
Q616	XU0185	DIG TR.	DTA143ZEA TL	B	
Q617	XU0185	DIG TR.	DTA143ZEA TL	B	
Q620	XT0152	TRANSISTOR	2SC5007-T1-FB	B	
Q621	XT0151	TRANSISTOR	2SC5006-T1-FB	B	
Q622	XT0151	TRANSISTOR	2SC5006-T1-FB	B	
Q623	XT0151	TRANSISTOR	2SC5006-T1-FB	B	
Q624	XT0152	TRANSISTOR	2SC5007-T1-FB	B	
Q625	XT0151	TRANSISTOR	2SC5006-T1-FB	B	
R600	RK3022	RESISTOR	MCR03EZHJ470	A	
R602	RK3018	RESISTOR	MCR03EZHJ220	A	
R603	RK3042	RESISTOR	MCR03EZHJ222	A	
R604	RK3050	RESISTOR	MCR03EZHJ103	A	
R607	RK3039	RESISTOR	MCR03EZHJ122	A	
R608	RK3062	RESISTOR	MCR03EZHJ104	A	
R609	RK3026	RESISTOR	MCR03EZHJ101	A	
R610	RK3060	RESISTOR	MCR03EZHJ683	A	
R612	RK3019	RESISTOR	MCR03EZHJ270	A	
R613	RK3021	RESISTOR	MCR03EZHJ390	A	
R614	RK3019	RESISTOR	MCR03EZHJ270	A	
R615	RK3021	RESISTOR	MCR03EZHJ390	A	
R616	RK3050	RESISTOR	MCR03EZHJ103	A	
R617	RK3038	RESISTOR	MCR03EZHJ102	A	
R618	RK3023	RESISTOR	MCR03EZHJ560	B	

R619	RK3039	RESISTOR	MCR03EZHJ122	A	
R620	RK3022	RESISTOR	MCR03EZHJ470	A	
R621	RK3014	RESISTOR	MCR03EZHJ100	A	
R622	RK3054	RESISTOR	MCR03EZHJ223	A	
R623	RK3042	RESISTOR	MCR03EZHJ222	A	
R624	RK3020	RESISTOR	MCR03EZHJ330	A	
R625	RK3042	RESISTOR	MCR03EZHJ222	A	
R626	RK3050	RESISTOR	MCR03EZHJ103	A	
R627	RK3032	RESISTOR	MCR03EZHJ331	A	
R628	RK3060	RESISTOR	MCR03EZHJ683	A	
R629	RK3050	RESISTOR	MCR03EZHJ103	A	
R630	RK3018	RESISTOR	MCR03EZHJ220	A	
R631	RK3018	RESISTOR	MCR03EZHJ220	A	
R632	RK3054	RESISTOR	MCR03EZHJ223	A	
R633	RK3038	RESISTOR	MCR03EZHJ102	A	
R634	RK3038	RESISTOR	MCR03EZHJ102	A	
R635	RK3054	RESISTOR	MCR03EZHJ223	A	
R636	RK3050	RESISTOR	MCR03EZHJ103	B	
R637	RK3026	RESISTOR	MCR03EZHJ101	A	T E
R638	RK3014	RESISTOR	MCR03EZHJ100	B	
R640	RK3017	RESISTOR	MCR03EZHJ180	B	
R641	RK3062	RESISTOR	MCR03EZHJ104	B	
R642	RK3031	RESISTOR	MCR03EZHJ271	B	
R643	RK3031	RESISTOR	MCR03EZHJ271	B	
R644	RK3042	RESISTOR	MCR03EZHJ222	A	T E
R645	RK3050	RESISTOR	MCR03EZHJ103	B	
R646	RK3050	RESISTOR	MCR03EZHJ103	B	
R647	RK3026	RESISTOR	MCR03EZHJ101	B	
R651	RK3018	RESISTOR	MCR03EZHJ220	B	
R652	RK3050	RESISTOR	MCR03EZHJ103	B	
R653	RK3026	RESISTOR	MCR03EZHJ101	B	
R654	RK3062	RESISTOR	MCR03EZHJ104	A	
R655	RK3050	RESISTOR	MCR03EZHJ103	B	
R656	RK3023	RESISTOR	MCR03EZHJ560	B	
R657	RK3050	RESISTOR	MCR03EZHJ103	B	
R658	RK3050	RESISTOR	MCR03EZHJ103	B	
R659	RK3063	RESISTOR	MCR03EZHJ124	B	
R660	RK3023	RESISTOR	MCR03EZHJ560	B	
R662	RK3032	RESISTOR	MCR03EZHJ331	B	
R663	RK3062	RESISTOR	MCR03EZHJ104	A	
R664	RK3056	RESISTOR	MCR03EZHJ333	B	

R665	RK3050	RESISTOR	MCR03EZHJ103	B	
R666	RK3050	RESISTOR	MCR03EZHJ103	B	
R667	RK3017	RESISTOR	MCR03EZHJ180	B	
R668	RK3056	RESISTOR	MCR03EZHJ333	B	
R669	RK3031	RESISTOR	MCR03EZHJ271	B	
R670	RK3031	RESISTOR	MCR03EZHJ271	B	
R671	RK3058	RESISTOR	MCR03EZHJ473	B	
R672	RK3062	RESISTOR	MCR03EZHJ104	A	
R673	RK3023	RESISTOR	MCR03EZHJ560	B	
R674	RK3050	RESISTOR	MCR03EZHJ103	B	
R675	RK3001	RESISTOR	MCR03EZHJ000	A	
R676	RK3018	RESISTOR	MCR03EZHJ220	B	
R677	RK3038	RESISTOR	MCR03EZHJ102	A	
R678	RK3062	RESISTOR	MCR03EZHJ104	A	
R679	RK3038	RESISTOR	MCR03EZHJ102	A	
R681	RK3038	RESISTOR	MCR03EZHJ102	A	
R682	RK3050	RESISTOR	MCR03EZHJ103	B	
R683	RK3062	RESISTOR	MCR03EZHJ104	A	
R684	RK3032	RESISTOR	MCR03EZHJ331	B	
R686	RK3050	RESISTOR	MCR03EZHJ103	B	
R687	RK3032	RESISTOR	MCR03EZHJ331	B	
R688	RK3024	RESISTOR	MCR03EZHJ680	A	T E
R689	RK3023	RESISTOR	MCR03EZHJ560	B	
R690	RK3062	RESISTOR	MCR03EZHJ104	A	
R691	RK3046	RESISTOR	MCR03EZHJ472	B	T E
R692	RK3042	RESISTOR	MCR03EZHJ222	B	T E
R693	RK3062	RESISTOR	MCR03EZHJ104	B	T E
R694	RK3038	RESISTOR	MCR03EZHJ102	A	
R695	RK3062	RESISTOR	MCR03EZHJ104	A	T E
R696	RK3026	RESISTOR	MCR03EZHJ101	A	T E
R697	RK3032	RESISTOR	MCR03EZHJ331	B	
R698	RK3026	RESISTOR	MCR03EZHJ101	B	
R699	RK3056	RESISTOR	MCR03EZHJ333	B	
R700	RK3050	RESISTOR	MCR03EZHJ103	B	
R701	RK3050	RESISTOR	MCR03EZHJ103	A	
R702	RK3030	RESISTOR	MCR03EZHJ221	B	
R703	RK3058	RESISTOR	MCR03EZHJ473	B	
R704	RK3050	RESISTOR	MCR03EZHJ103	B	
R705	RK3056	RESISTOR	MCR03EZHJ333	B	
R706	RK3023	RESISTOR	MCR03EZHJ560	B	
R707	RK3023	RESISTOR	MCR03EZHJ560	B	

R715	RK0107	RESISTOR	ERJ6GEY0R00V	B
R716	RK0107	RESISTOR	ERJ6GEY0R00V	B
R717	RK0107	RESISTOR	ERJ6GEY0R00V	B
R718	RK0107	RESISTOR	ERJ6GEY0R00V	B
R719	RK0107	RESISTOR	ERJ6GEY0R00V	B
R720	RK3062	RESISTOR	MCR03EZHJ104	A
R721	RK3067	RESISTOR	MCR03EZHJ274	A
R722	RK3058	RESISTOR	MCR03EZHJ473	A
R723	RK3050	RESISTOR	MCR03EZHJ103	B
R724	RK3030	RESISTOR	MCR03EZHJ221	B
R725	RK3063	RESISTOR	MCR03EZHJ124	B
R726	RK3023	RESISTOR	MCR03EZHJ560	B
R727	RK3038	RESISTOR	MCR03EZHJ102	B
R728	RK3038	RESISTOR	MCR03EZHJ102	A
R729	RK3038	RESISTOR	MCR03EZHJ102	A
R730	RK3038	RESISTOR	MCR03EZHJ102	A
R731	RK3038	RESISTOR	MCR03EZHJ102	B
R733	RK3038	RESISTOR	MCR03EZHJ102	B
R735	RK3028	RESISTOR	MCR03EZHJ151	B
R736	RK3038	RESISTOR	MCR03EZHJ102	A
RA600	RA0011	RES.ARRAY	EXBV8V103JV	A
VR600	RH0142	VARIABLE R.	MVR22HXBRN103	A
X600	XQ0135	XTAL	VX27VJ-12.80FA	A

UNIT		SW			
Ref. No.	Parts No.	DESCRIPTION	Parts Name	LOC	RMKS
	FP0097		SW SPACER	H	
SW108	UU0018	SWITCH	SOP-112HST	A	
SW109	UU0018	SWITCH	SOP-112HST	A	

UNIT		VCO			
Ref. No.	Parts No.	DESCRIPTION	Parts Name	LOC	RMKS
	TN0011		VCO SEPARATOR DJX20	H	
	TS0163		VCO CASE DJX20	H	
C800	CU3001	CERAMIC	C1608CH1H0R5CT-AS	A	
C801	CU3023	CERAMIC	C1608CH1H101JT-AS	A	
C802	CU3035	CERAMIC	C1608JB1H102KT-AS	A	
C803	CU3035	CERAMIC	C1608JB1H102KT-AS	B	
C804	CU3035	CERAMIC	C1608JB1H102KT-AS	B	
C805	CU3006	CERAMIC	C1608CH1H050CT-AS	B	
C806	CU3005	CERAMIC	C1608CH1H040CT-AS	A	
C807	CU3004	CERAMIC	C1608CH1H030CT-AS	B	

C808	CU3005	CERAMIC	C1608CH1H040CT-AS	B
C809	CU3004	CERAMIC	C1608CH1H030CT-AS	A
C810	CU3004	CERAMIC	C1608CH1H030CT-AS	A
C811	CU3023	CERAMIC	C1608CH1H101JT-AS	A
C812	CU3035	CERAMIC	C1608JB1H102KT-AS	A
C813	CU3035	CERAMIC	C1608JB1H102KT-AS	B
C814	CS0063	TANTALUM	TMCSA1V104MTR	B
C815	CU3035	CERAMIC	C1608JB1H102KT-AS	B
C817	CU3101	CERAMIC	C1608JB1C473KT-NS	B
C818	CS0220	TANTALUM	TMCMA1C225MTR	B
C819	CS0220	TANTALUM	TMCMA1C225MTR	B
C820	CU3035	CERAMIC	C1608JB1H102KT-AS	B
C821	CU3006	CERAMIC	C1608CH1H050CT-AS	B
C822	CU3035	CERAMIC	C1608JB1H102KT-AS	B
C823	CU3006	CERAMIC	C1608CH1H050CT-AS	B
C824	CU3035	CERAMIC	C1608JB1H102KT-AS	A
C825	CS0408	TANTALUM	6MCM156MATER	B
C826	CS0385	TANTALUM	TMCMD1V106MTR	A
C827	CU3035	CERAMIC	C1608JB1H102KT-AS	B
C828	CU3047	CERAMIC	C1608JB1H103KT-N	A
C829	CU3035	CERAMIC	C1608JB1H102KT-AS	B
C830	CU3006	CERAMIC	C1608CH1H050CT-AS	B
C831	CU3003	CERAMIC	C1608CH1H020CT-AS	B
C832	CU3047	CERAMIC	C1608JB1H103KT-N	B
C833	CS0220	TANTALUM	TMCMA1C225MTR	B
C834	CU3035	CERAMIC	C1608JB1H102KT-AS	B
C835	CU3005	CERAMIC	C1608CH1H040CT-AS	A
C836	CU3007	CERAMIC	C1608CH1H060CT-A	A
C837	CU3003	CERAMIC	C1608CH1H020CT-AS	A
C838	CU3035	CERAMIC	C1608JB1H102KT-AS	A
C839	CU3019	CERAMIC	C1608CH1H470JT-AS	B
C840	CU3019	CERAMIC	C1608CH1H470JT-AS	B
C841	CU3019	CERAMIC	C1608CH1H470JT-AS	B
C843	CU3035	CERAMIC	C1608JB1H102KT-AS	A
C844	CU3002	CERAMIC	C1608CH1H010CT-AS	A
C845	CS0057	TANTALUM	TMCSA0J225MTR	A
C846	CU3035	CERAMIC	C1608JB1H102KT-AS	A
C847	CS0408	TANTALUM	6MCM156MATER	A
C848	CU3009	CERAMIC	C1608CH1H080CT-A	A
C849	CU3035	CERAMIC	C1608JB1H102KT-AS	A
C850	CU3035	CERAMIC	C1608JB1H102KT-AS	A

C851	CU3035	CERAMIC	C1608JB1H102KT-AS	A
C852	CU3004	CERAMIC	C1608CH1H030CT-AS	A
C853	CS0408	TANTALUM	6MCM156MATER	A
C854	CU3001	CERAMIC	C1608CH1H0R5CT-AS	A
C857	CU3035	CERAMIC	C1608JB1H102KT-AS	A
C858	CS0057	TANTALUM	TMCSA0J225MTR	A
C859	CU3035	CERAMIC	C1608JB1H102KT-AS	B
C860	CU3002	CERAMIC	C1608CH1H010CT-AS	B
C861	CU3023	CERAMIC	C1608CH1H101JT-AS	B
C862	CU3004	CERAMIC	C1608CH1H030CT-AS	B
C863	CU3111	CERAMIC	C1608JB1C104KT-N	A
C864	CU3006	CERAMIC	C1608CH1H050CT-AS	B
C867	CU3035	CERAMIC	C1608JB1H102KT-AS	B
C868	CS0408	TANTALUM	6MCM156MATER	A
C869	CU3006	CERAMIC	C1608CH1H050CT-AS	B
C870	CU3013	CERAMIC	C1608CH1H150JT-AS	B
C871	CU3017	CERAMIC	C1608CH1H330JT-AS	B
C872	CU3013	CERAMIC	C1608CH1H150JT-AS	B
C873	CU3011	CERAMIC	C1608CH1H100DT-AS	B
CN800	UE0409	CONNECTOR	9210B-1-09Z482-T	H
CN801	UE0408	CONNECTOR	9210B-1-10Z482-T	H
D800	XD0260	DIODE	1SV231 TPH4	A
D801	XD0260	DIODE	1SV231 TPH4	A
D802	XD0260	DIODE	1SV231 TPH4	A
D803	XD0307	DIODE	1SS312(TE85L)	B
D804	XD0324	DIODE	MA2SV0500L	A
D805	XD0324	DIODE	MA2SV0500L	A
D806	XD0324	DIODE	MA2SV0500L	A
D807	XD0343	DIODE	MA2S304001AR	A
D808	XD0260	DIODE	1SV231 TPH4	A
D809	XD0260	DIODE	1SV231 TPH4	A
D810	XD0342	DIODE	1SS390 TE61	B
D811	XD0342	DIODE	1SS390 TE61	B
IC800	XA0791	IC	MB15F03SLPFV1-GBNDEF	B
L800	QC0561	COIL	LL1608-FH10NJ	A
L801	QC0561	COIL	LL1608-FH10NJ	B
L803	QC0558	COIL	LL1608-FH5N6S	A
L804	QC0561	COIL	LL1608-FH10NJ	B
L805	QC0507	COIL	LK16081R0K-T	B
L806	QC0571	COIL	LL1608-FH68NJ	B
L807	QC0507	COIL	LK16081R0K-T	A

L808	QC0564	COIL	LL1608-FH18NJ	A
L809	QC0507	COIL	LK16081R0K-T	A
L810	QC0507	COIL	LK16081R0K-T	A
L811	QC0507	COIL	LK16081R0K-T	A
L812	QC0572	COIL	LL1608-FH82NJ	A
L814	QC0561	COIL	LL1608-FH10NJ	B
L815	QC0568	COIL	LL1608-FH39NJ	B
L816	QC0568	COIL	LL1608-FH39NJ	B
L817	QC0567	COIL	LL1608-FH33NJ	B
L818	QC0561	COIL	LL1608-FH10NJ	B
L819	QC0567	COIL	LL1608-FH33NJ	B
Q800	XA0792	IC	UPA806T-T1	A
Q801	XT0153	TRANSISTOR	2SC5008-T1-FB	B
Q803	XU0185	DIG TR.	DTA143ZEA TL	A
Q804	XT0149	TRANSISTOR	2SC4181-T1-L18	A
Q805	XT0153	TRANSISTOR	2SC5008-T1-FB	B
Q806	XT0149	TRANSISTOR	2SC4181-T1-L18	A
Q807	XT0152	TRANSISTOR	2SC5007-T1-FB	B
Q808	XT0152	TRANSISTOR	2SC5007-T1-FB	A
Q809	XT0151	TRANSISTOR	2SC5006-T1-FB	A
Q810	XT0152	TRANSISTOR	2SC5007-T1-FB	B
Q811	XT0151	TRANSISTOR	2SC5006-T1-FB	B
Q812	XT0151	TRANSISTOR	2SC5006-T1-FB	B
Q813	XT0151	TRANSISTOR	2SC5006-T1-FB	B
R800	RK3022	RESISTOR	MCR03EZHJ470	A
R801	RK3022	RESISTOR	MCR03EZHJ470	B
R802	RK3050	RESISTOR	MCR03EZHJ103	A
R803	RK3059	RESISTOR	MCR03EZHJ563	A
R804	RK3030	RESISTOR	MCR03EZHJ221	B
R805	RK3054	RESISTOR	MCR03EZHJ223	A
R806	RK3050	RESISTOR	MCR03EZHJ103	A
R807	RK3060	RESISTOR	MCR03EZHJ683	B
R808	RK3018	RESISTOR	MCR03EZHJ220	B
R809	RK3022	RESISTOR	MCR03EZHJ470	B
R810	RK3028	RESISTOR	MCR03EZHJ151	A
R811	RK3062	RESISTOR	MCR03EZHJ104	B
R812	RK3050	RESISTOR	MCR03EZHJ103	A
R813	RK3050	RESISTOR	MCR03EZHJ103	A
R814	RK3050	RESISTOR	MCR03EZHJ103	A
R815	RK3026	RESISTOR	MCR03EZHJ101	B
R817	RK3022	RESISTOR	MCR03EZHJ470	B



R818	RK3026	RESISTOR	MCR03EZHJ101	A
R819	RK3030	RESISTOR	MCR03EZHJ221	B
R820	RK3058	RESISTOR	MCR03EZHJ473	B
R821	RK3044	RESISTOR	MCR03EZHJ332	B
R822	RK3038	RESISTOR	MCR03EZHJ102	A
R823	RK3038	RESISTOR	MCR03EZHJ102	A
R824	RK3050	RESISTOR	MCR03EZHJ103	A
R825	RK3047	RESISTOR	MCR03EZHJ562	B
R826	RK3047	RESISTOR	MCR03EZHJ562	B
R827	RK3047	RESISTOR	MCR03EZHJ562	B
R828	RK3055	RESISTOR	MCR03EZHJ273	B
R829	RK3022	RESISTOR	MCR03EZHJ470	B
R830	RK3030	RESISTOR	MCR03EZHJ221	B
R831	RK3030	RESISTOR	MCR03EZHJ221	A
R832	RK3050	RESISTOR	MCR03EZHJ103	A
R833	RK3038	RESISTOR	MCR03EZHJ102	B
R835	RK3038	RESISTOR	MCR03EZHJ102	B
R836	RK3030	RESISTOR	MCR03EZHJ221	A
R837	RK3038	RESISTOR	MCR03EZHJ102	B
R838	RK3062	RESISTOR	MCR03EZHJ104	B
R839	RK3050	RESISTOR	MCR03EZHJ103	A
R840	RK3050	RESISTOR	MCR03EZHJ103	A
R841	RK3050	RESISTOR	MCR03EZHJ103	A
R843	RK3030	RESISTOR	MCR03EZHJ221	A
R844	RK3050	RESISTOR	MCR03EZHJ103	A
R845	RK3030	RESISTOR	MCR03EZHJ221	A
R846	RK3060	RESISTOR	MCR03EZHJ683	B
R847	RK3060	RESISTOR	MCR03EZHJ683	B
R848	RK3051	RESISTOR	MCR03EZHJ123	A
R849	RK3050	RESISTOR	MCR03EZHJ103	A
R852	RK3022	RESISTOR	MCR03EZHJ470	B
R853	RK3060	RESISTOR	MCR03EZHJ683	B
R854	RK3062	RESISTOR	MCR03EZHJ104	A
R858	RK3050	RESISTOR	MCR03EZHJ103	A
R860	RK3018	RESISTOR	MCR03EZHJ220	B
R861	RK3022	RESISTOR	MCR03EZHJ470	A
R864	RK3062	RESISTOR	MCR03EZHJ104	A
R865	RK3062	RESISTOR	MCR03EZHJ104	A
R866	RK3022	RESISTOR	MCR03EZHJ470	A
R867	RK3014	RESISTOR	MCR03EZHJ100	A
R868	RK3050	RESISTOR	MCR03EZHJ103	B

---

R869	RK3050	RESISTOR	MCR03EZHJ103	B
R870	RK3026	RESISTOR	MCR03EZHJ101	B
R871	RK3050	RESISTOR	MCR03EZHJ103	B

---



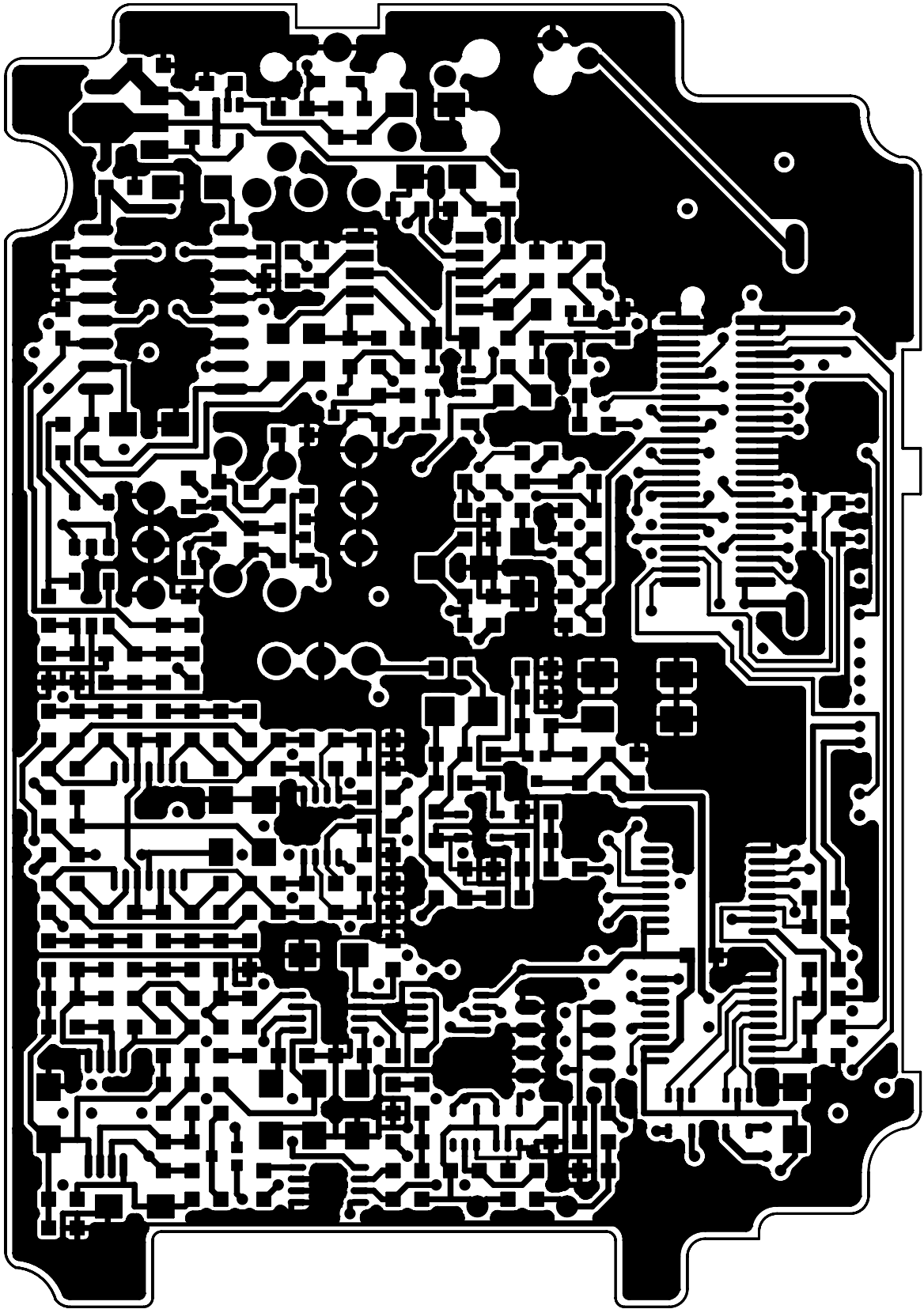

DJ-X2000 IF B SIDE PATTERN

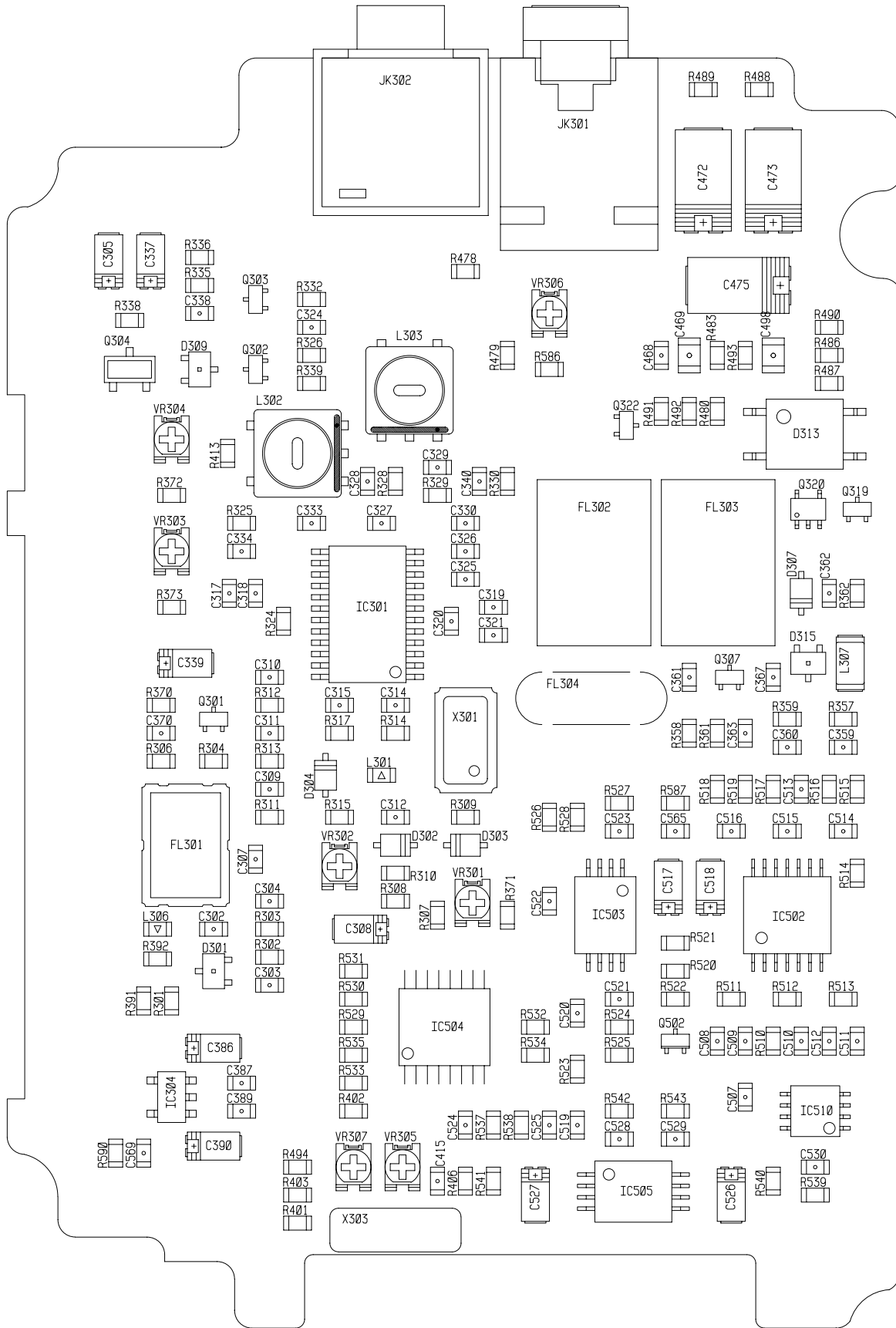

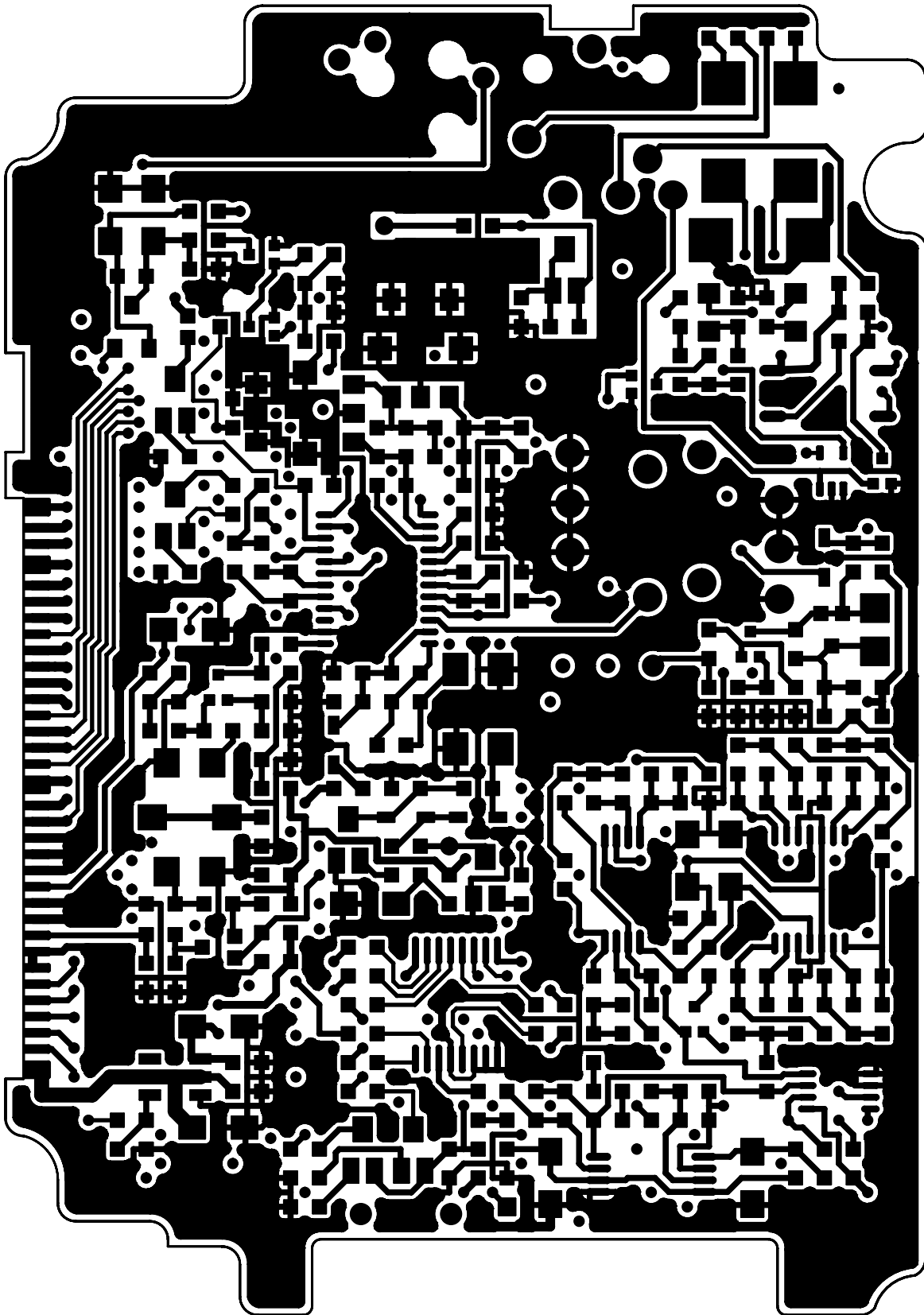

DJ-X2000 IF A SIDE PATTERN

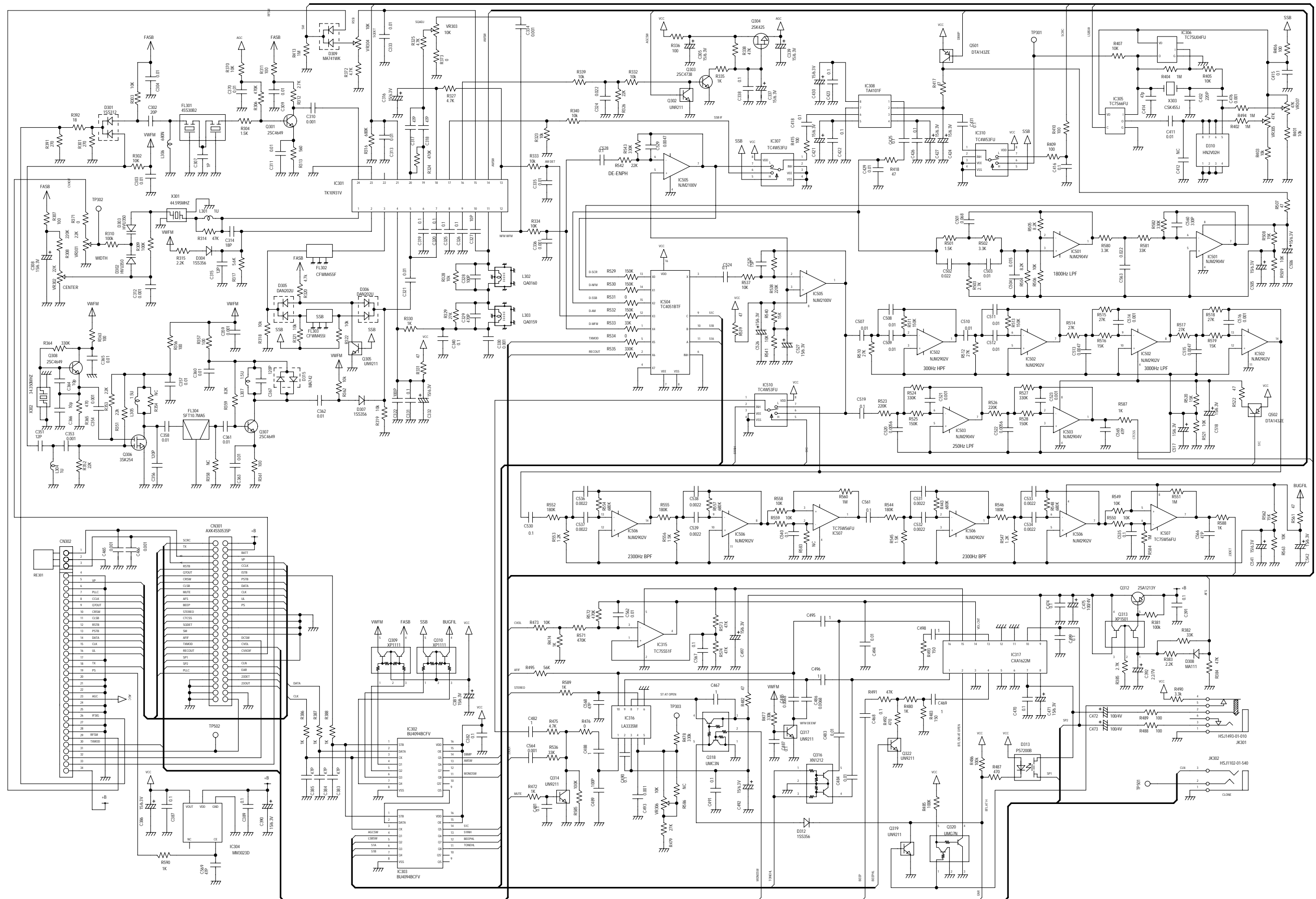

TITLE		DRAWING No.	
DIX2000		ALINCO INC.	
IF CIRCUIT			
SHEET	DATE	DESIGN	
1 / 1	2000/08/17	Y.M	

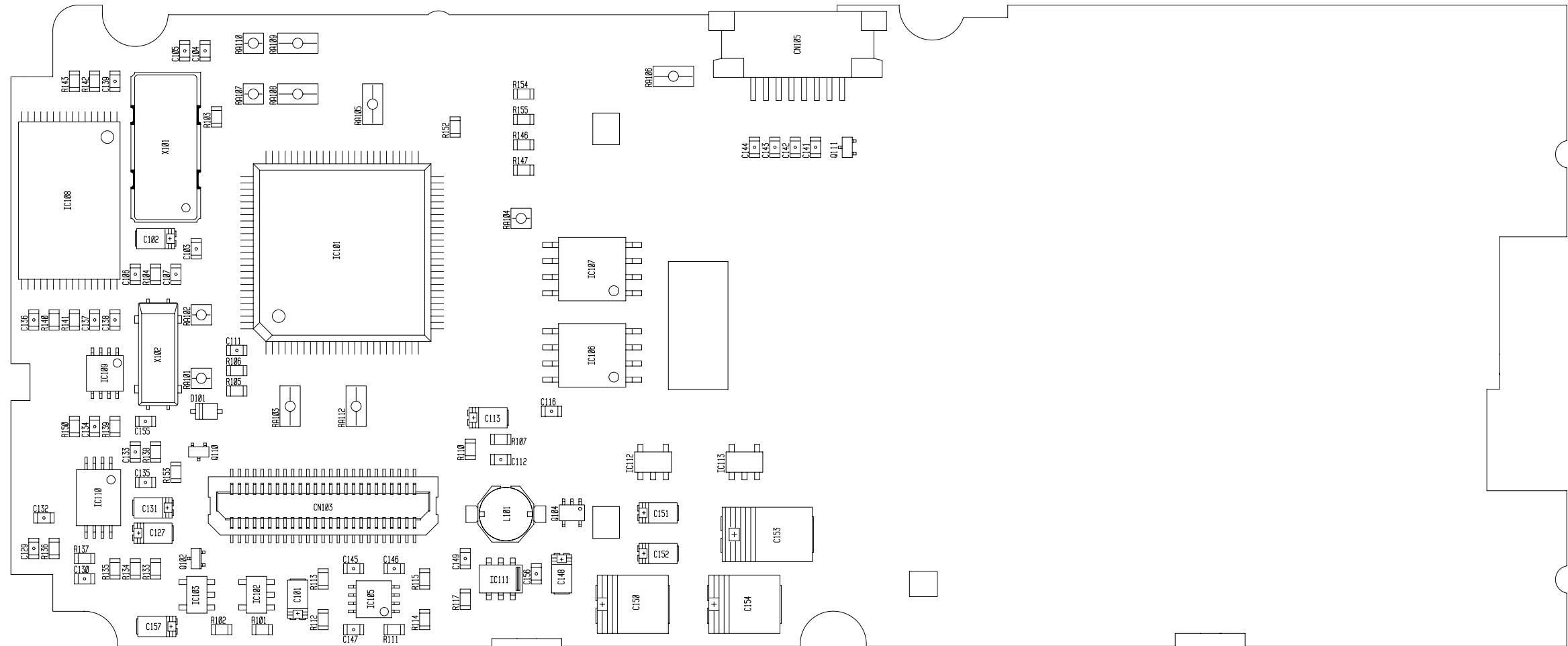



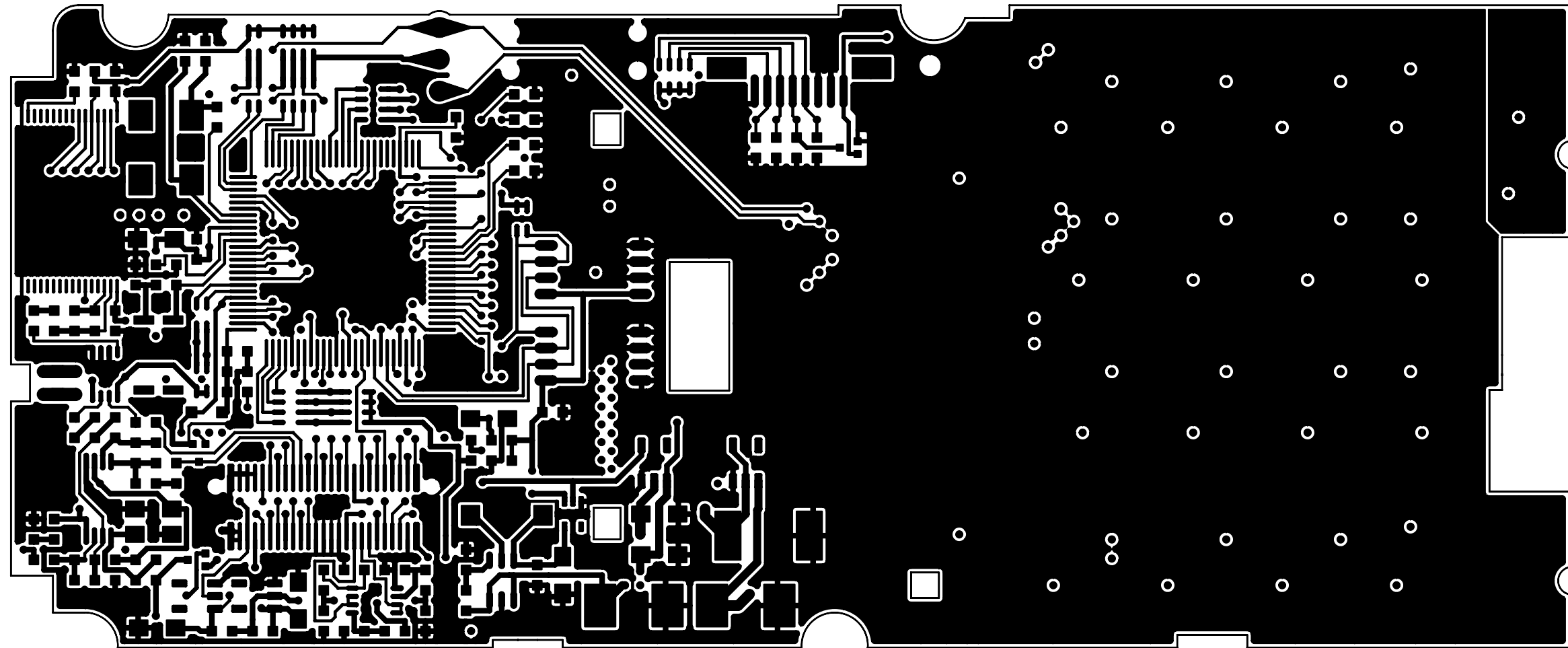

DJ-X2000 CPU B SIDE PATTERN

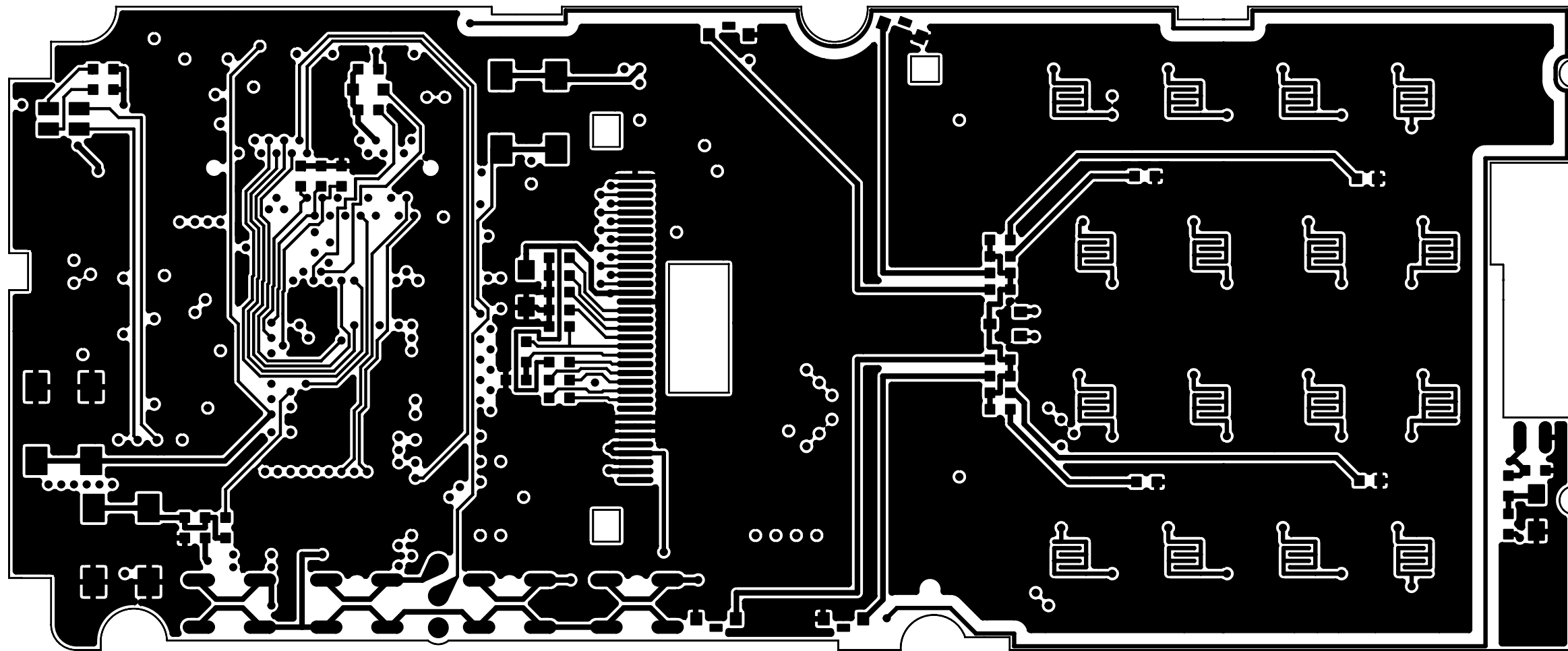

DJ-X2000 CPU A SIDE PATTERN



A SIDE

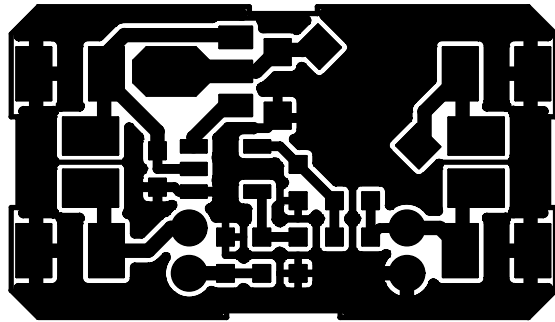

B SIDE

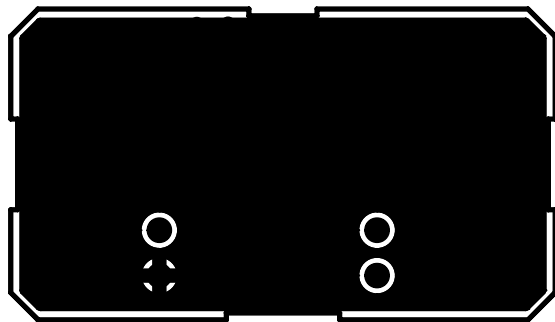

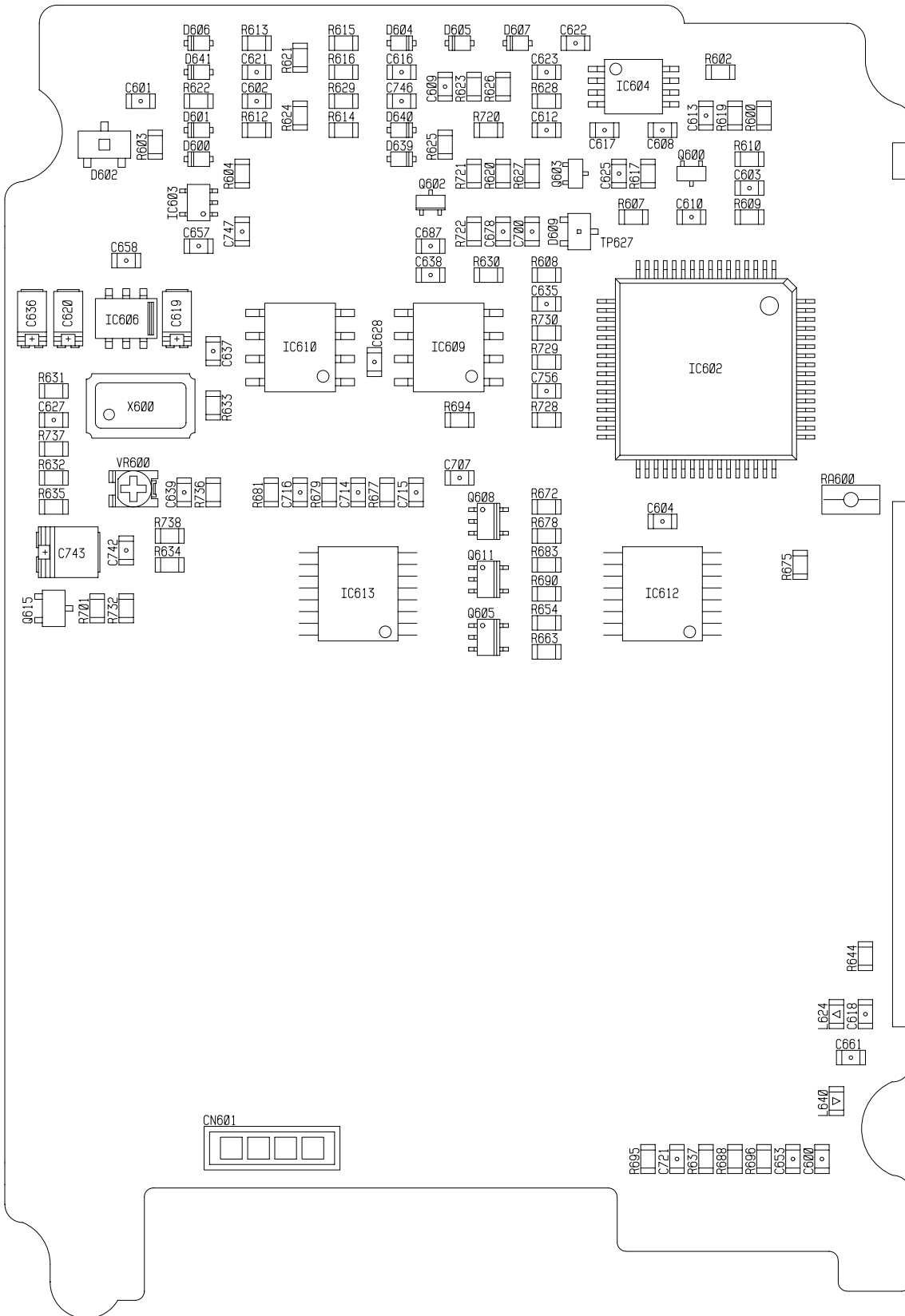

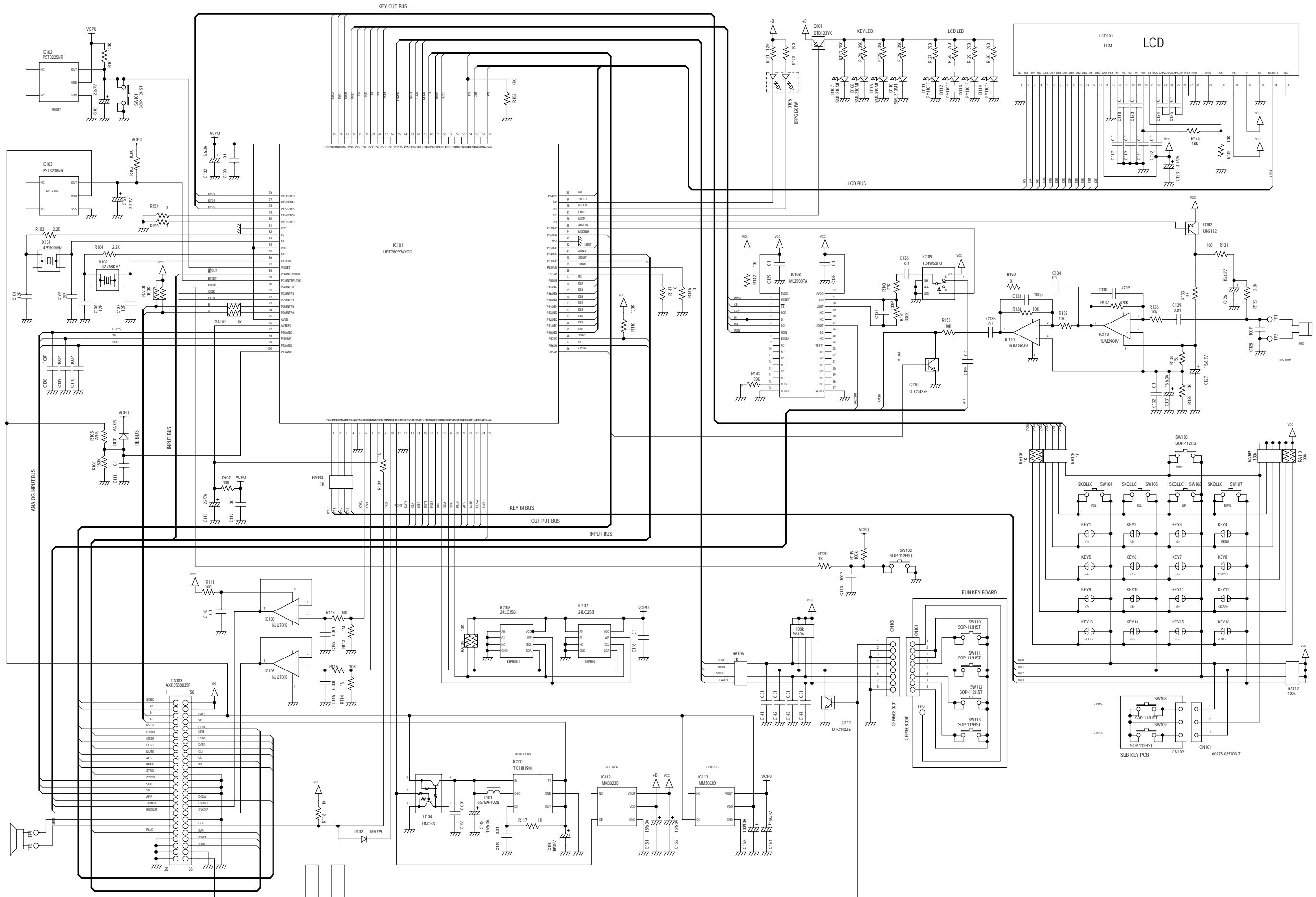

TITLE		DRAWING No.	
DJ-X2000		ALINCO INC.	
CPU CIRCUIT			
SHEET	DATE	DESIGN	
1 / 1	2000/6/16	Y.M	

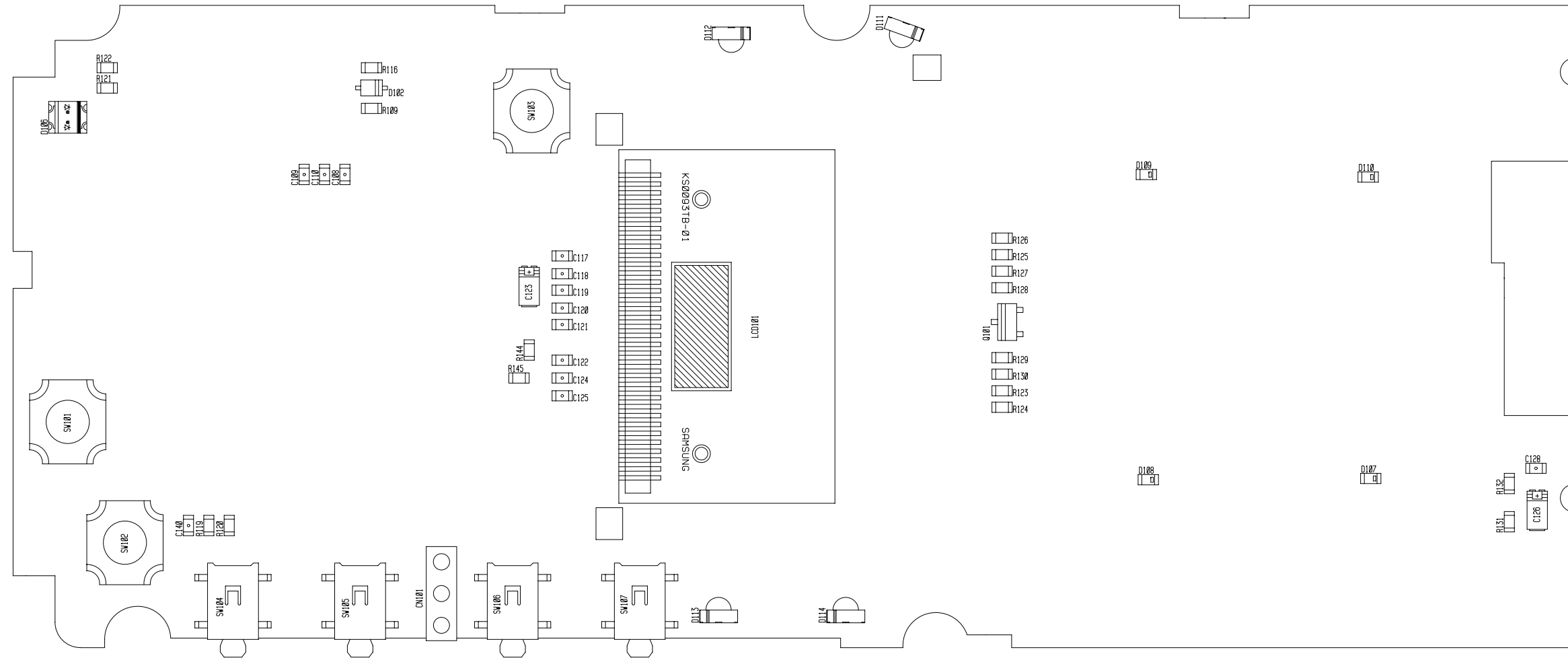

DJ-X2000 CPU A SIDE