

# ILLUSTRATION

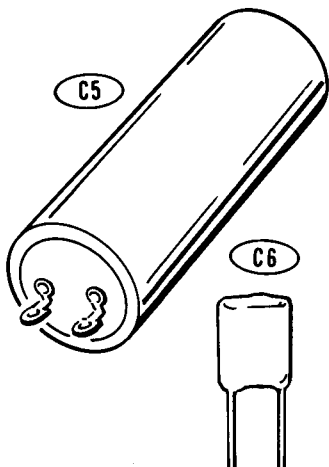

**D1**

NOTE: HEATH PART NUMBERS ARE STAMPED ON MOST DIODES.

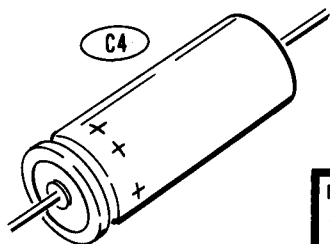
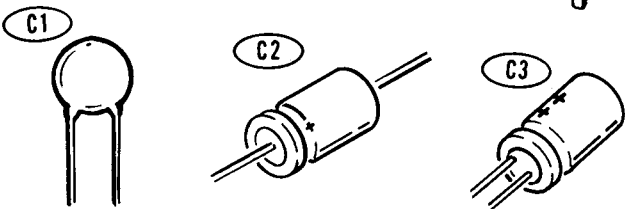
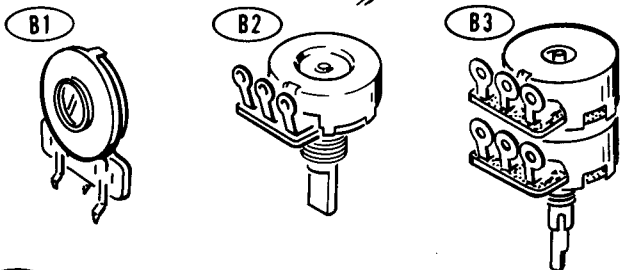
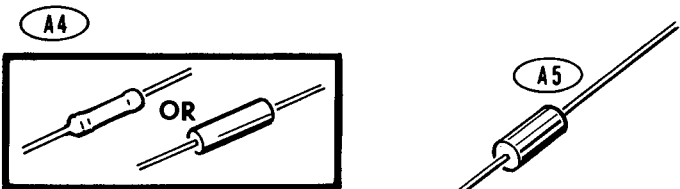
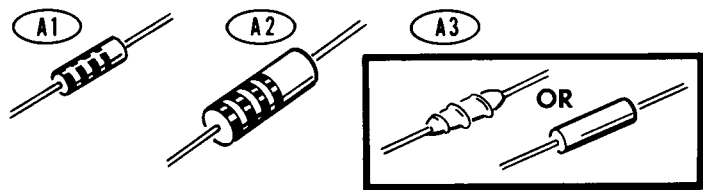
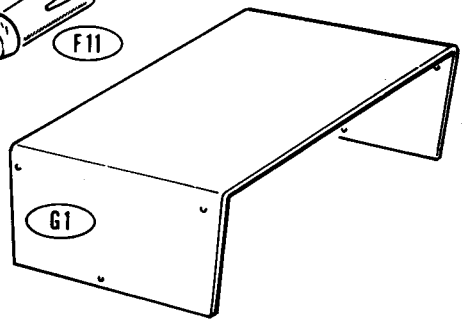
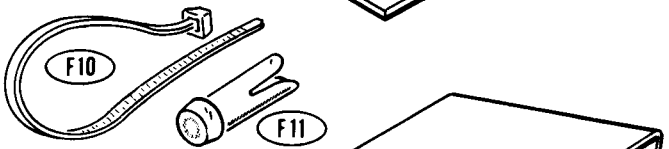
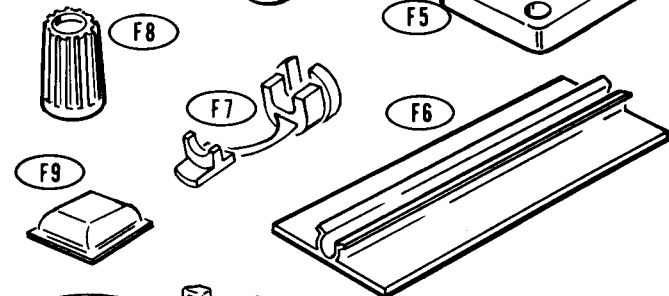
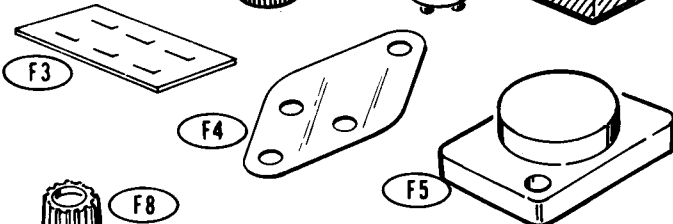
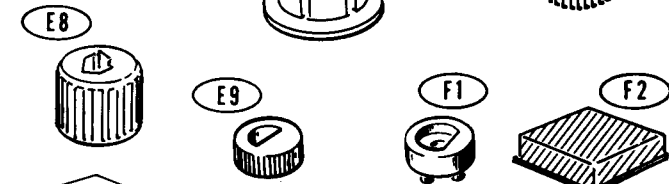
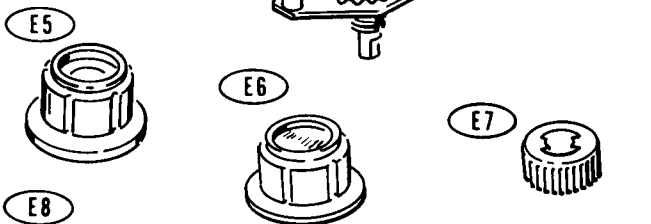
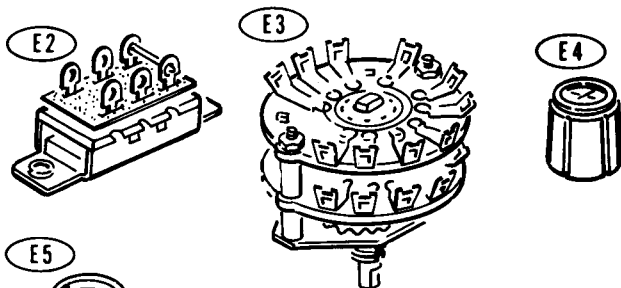
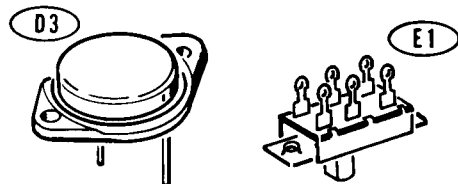
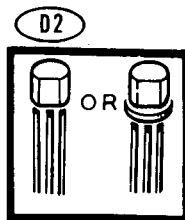

# TION BOOKLET

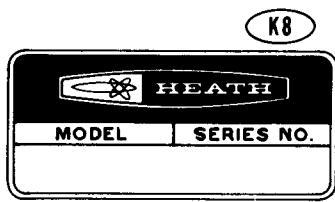
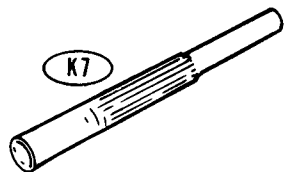
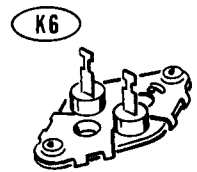
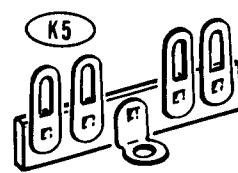
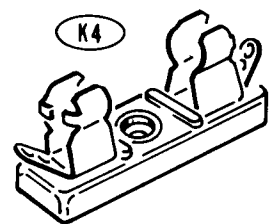
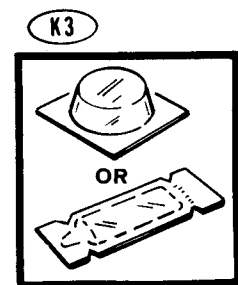
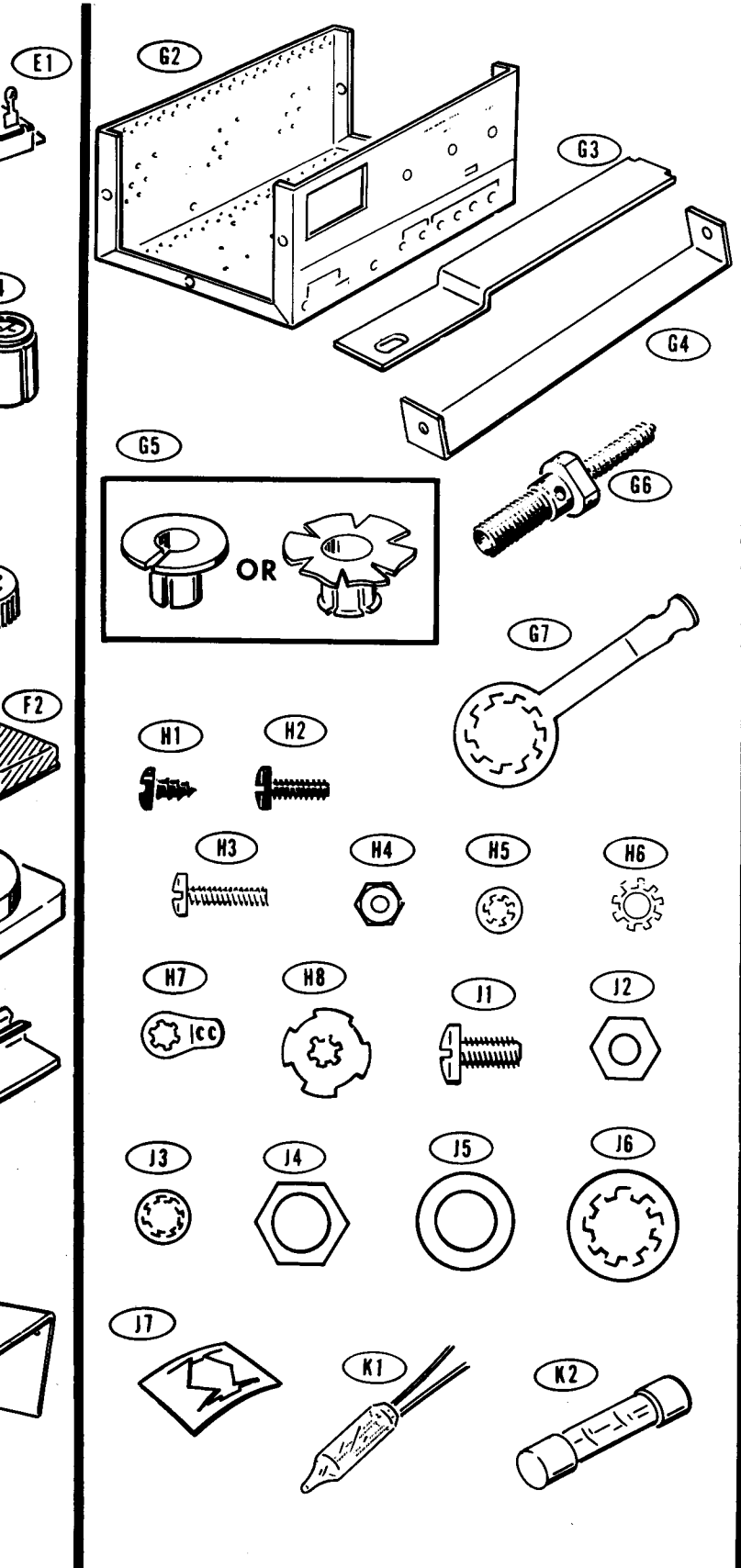

**K9**: CAUTION: FOR CONTINUED PROTECTION AGAINST FIRE HAZARD, REPLACE FUSE ONLY WITH SAME TYPE AND RATING. 290-1255

Model IP-2718

Copyright © 1976  
Heath Company  
All Rights Reserved

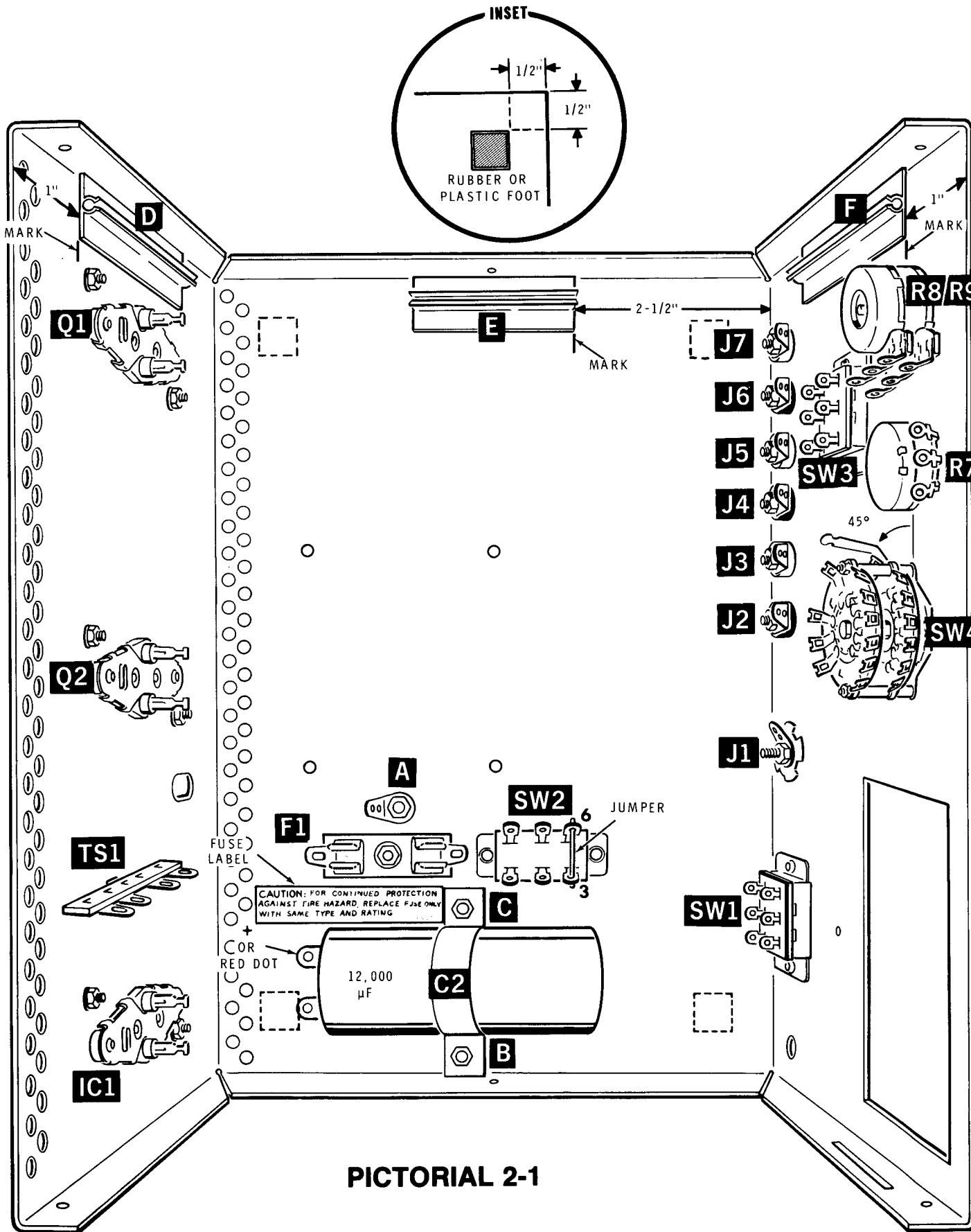

**PICTORIAL 2-1**

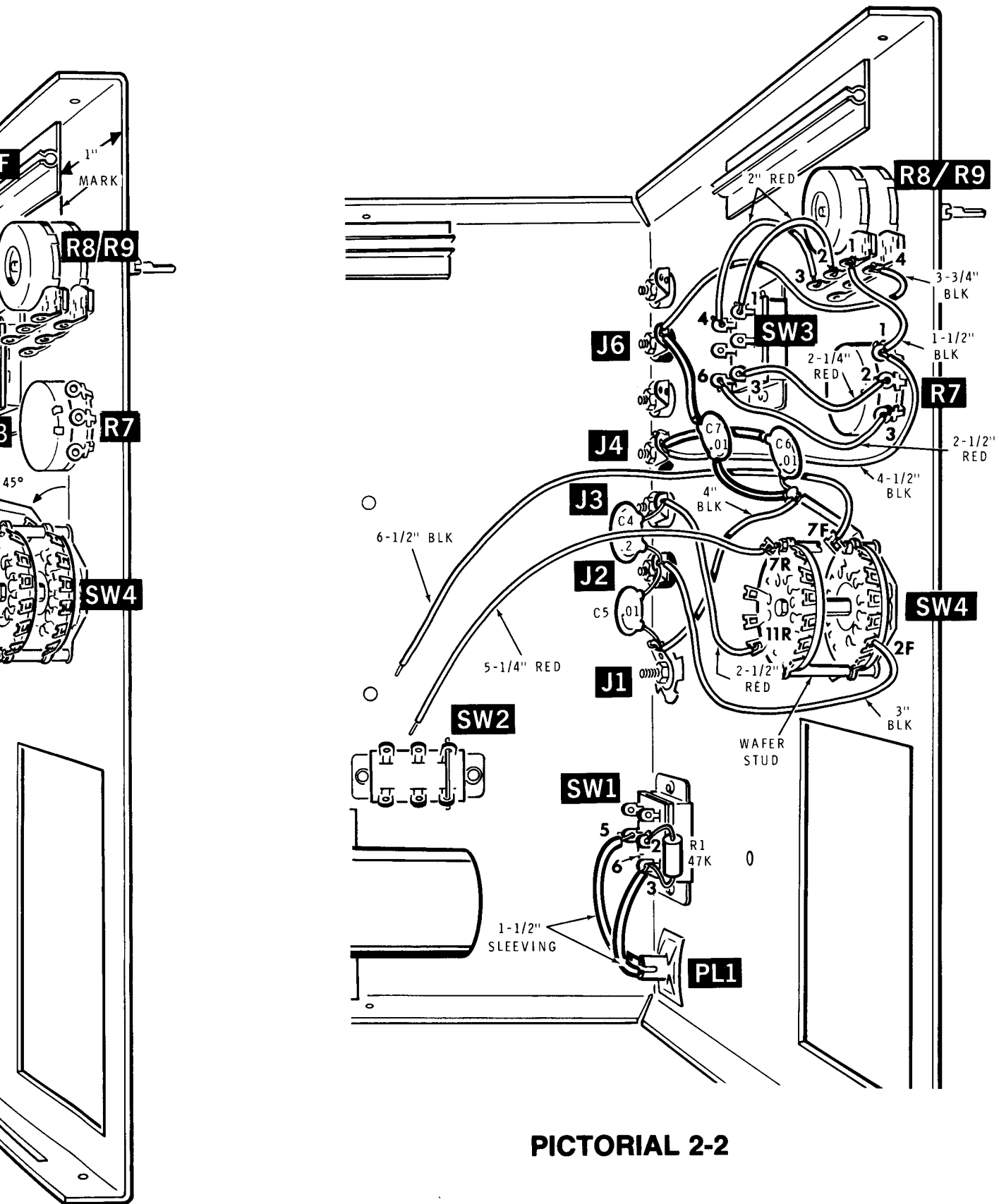

**PICTORIAL 2-2**

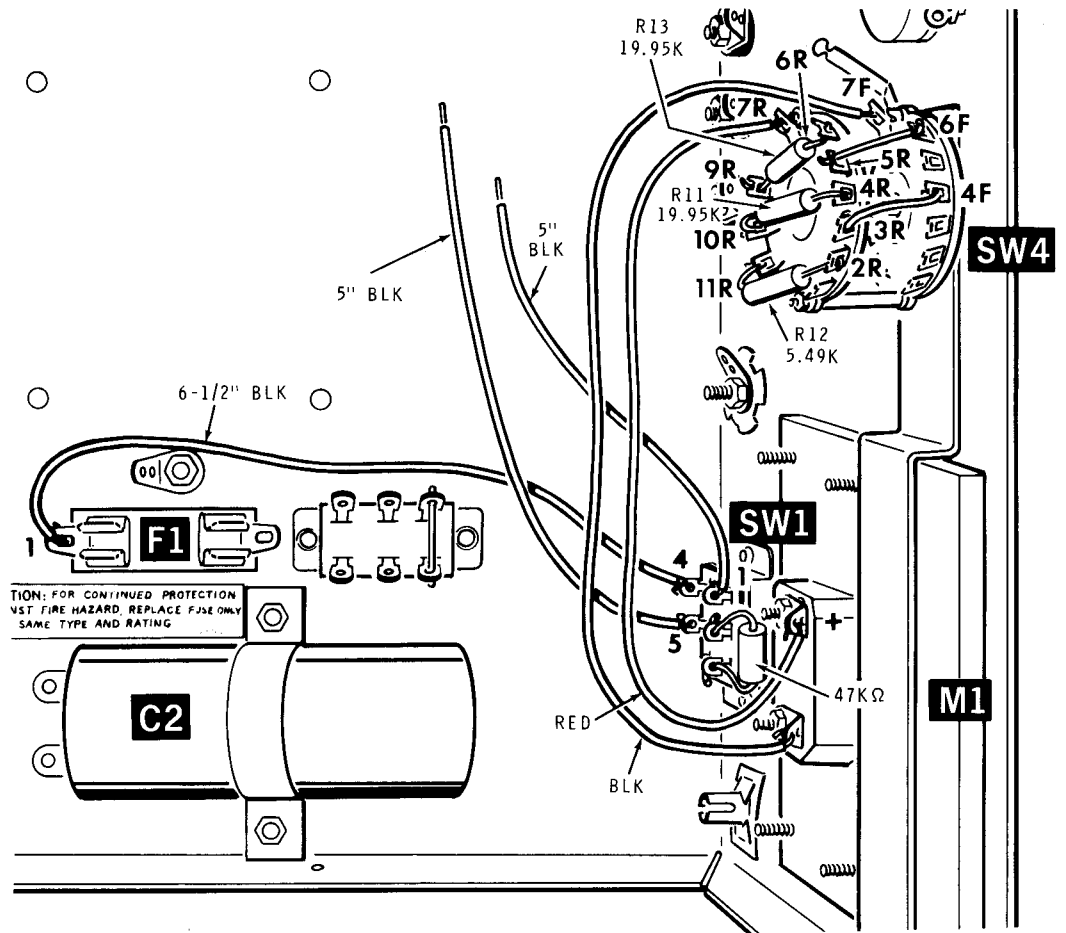

**PICTORIAL 2-3**

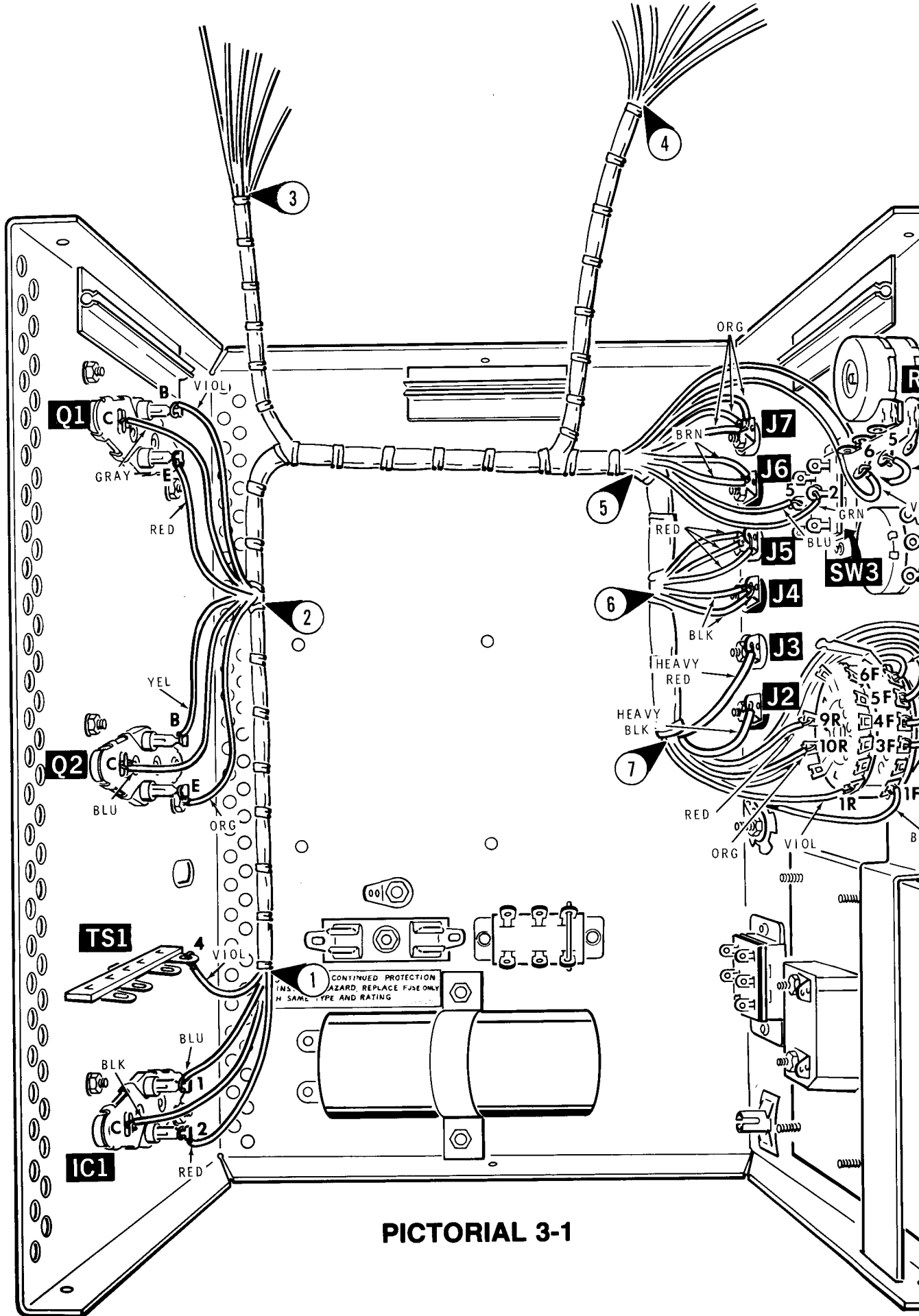

**PICTORIAL 3-1**

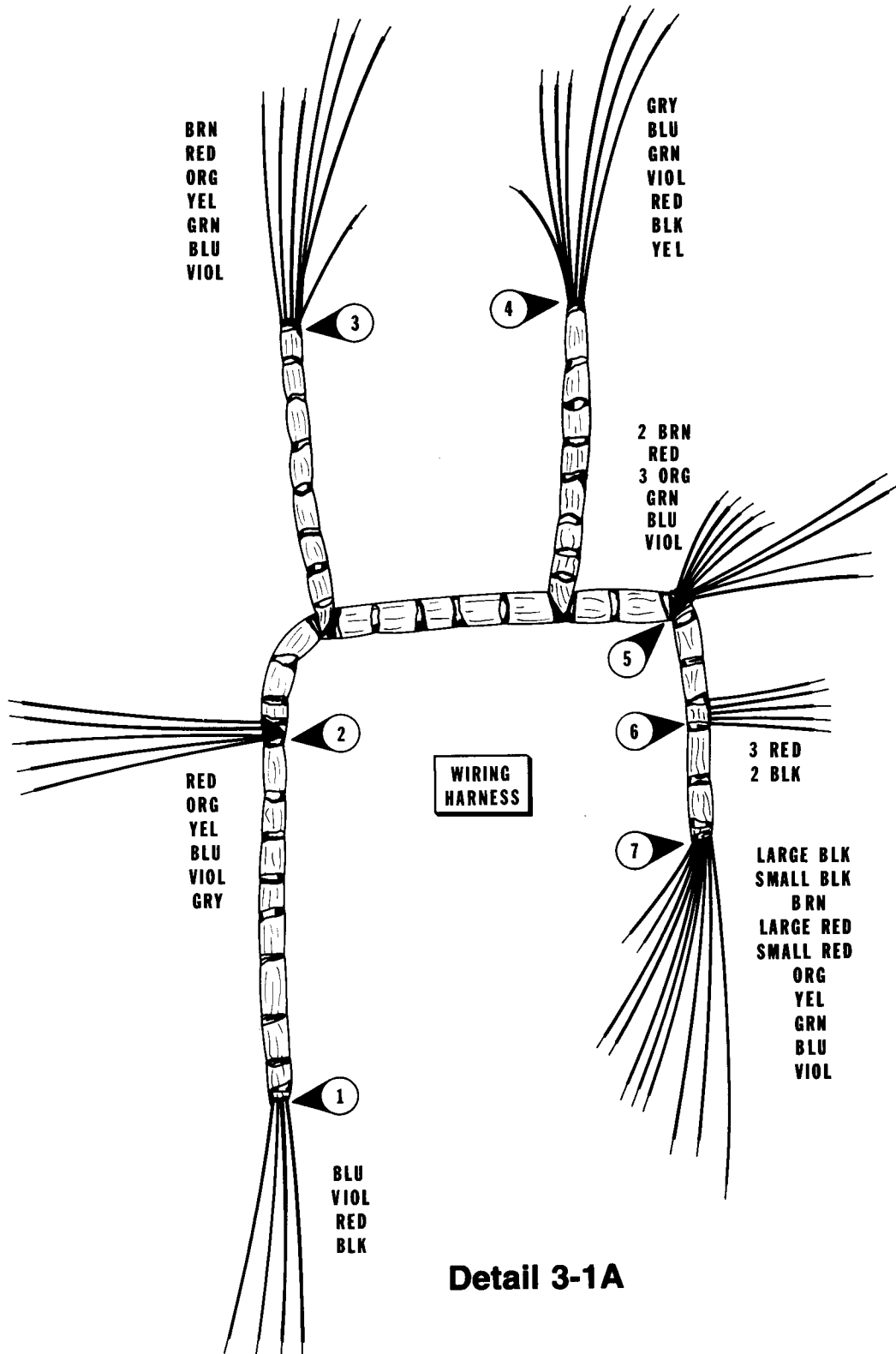
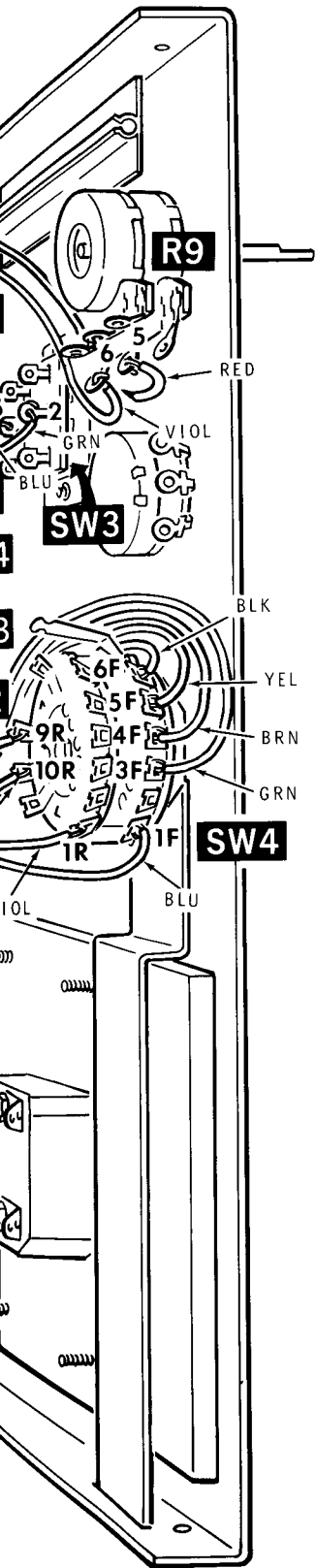

**Detail 3-1A**

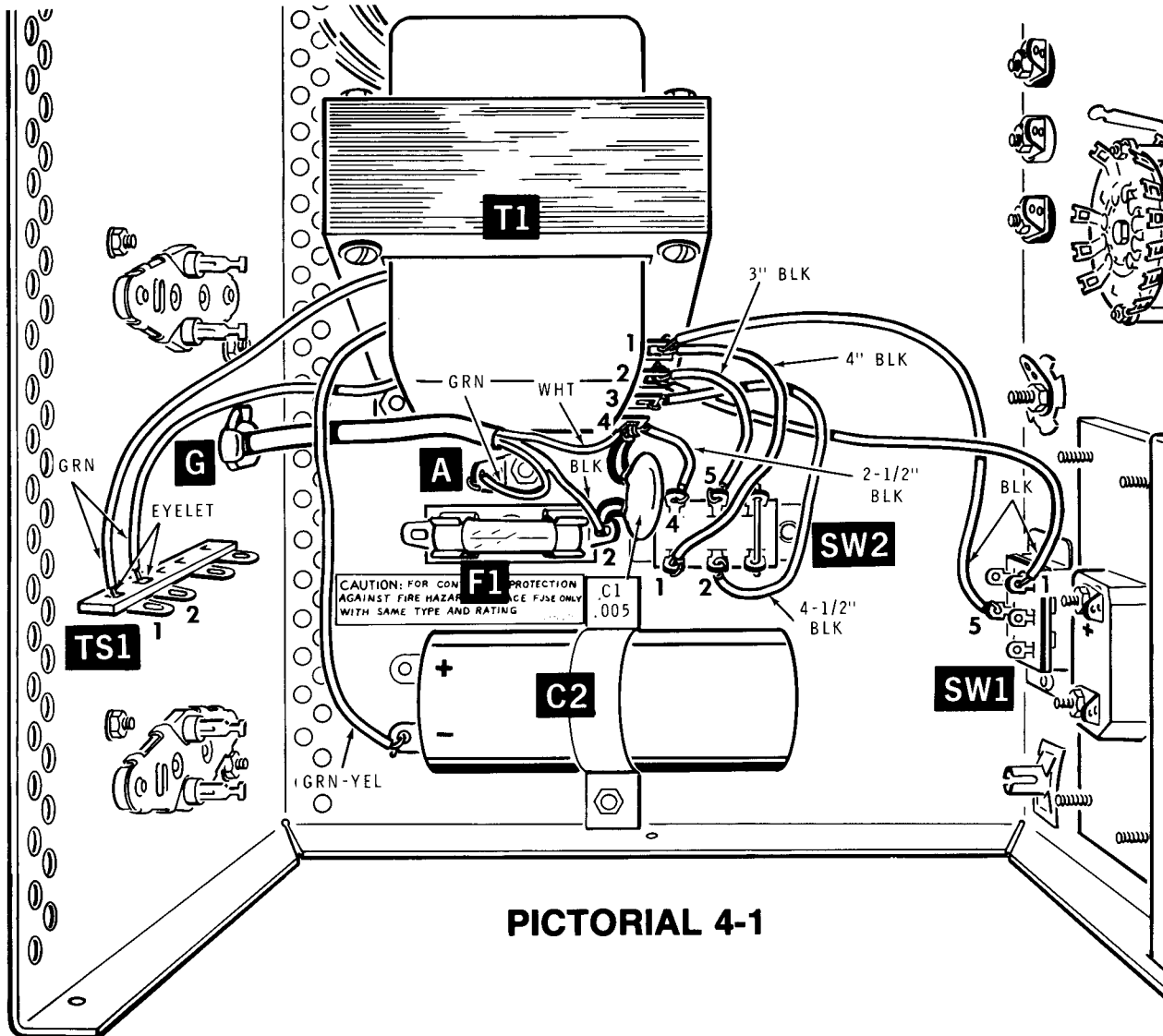

**PICTORIAL 4-1**



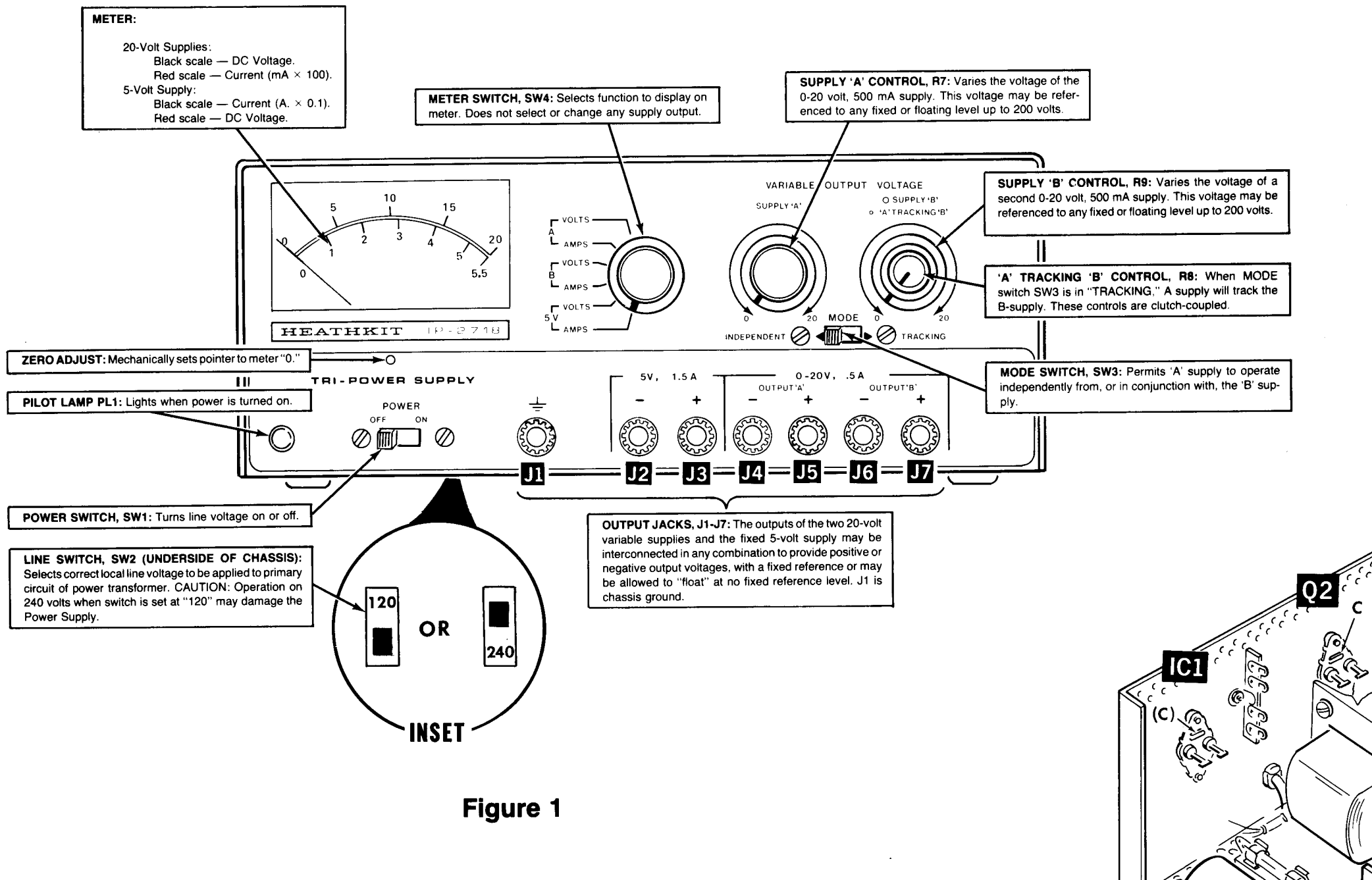
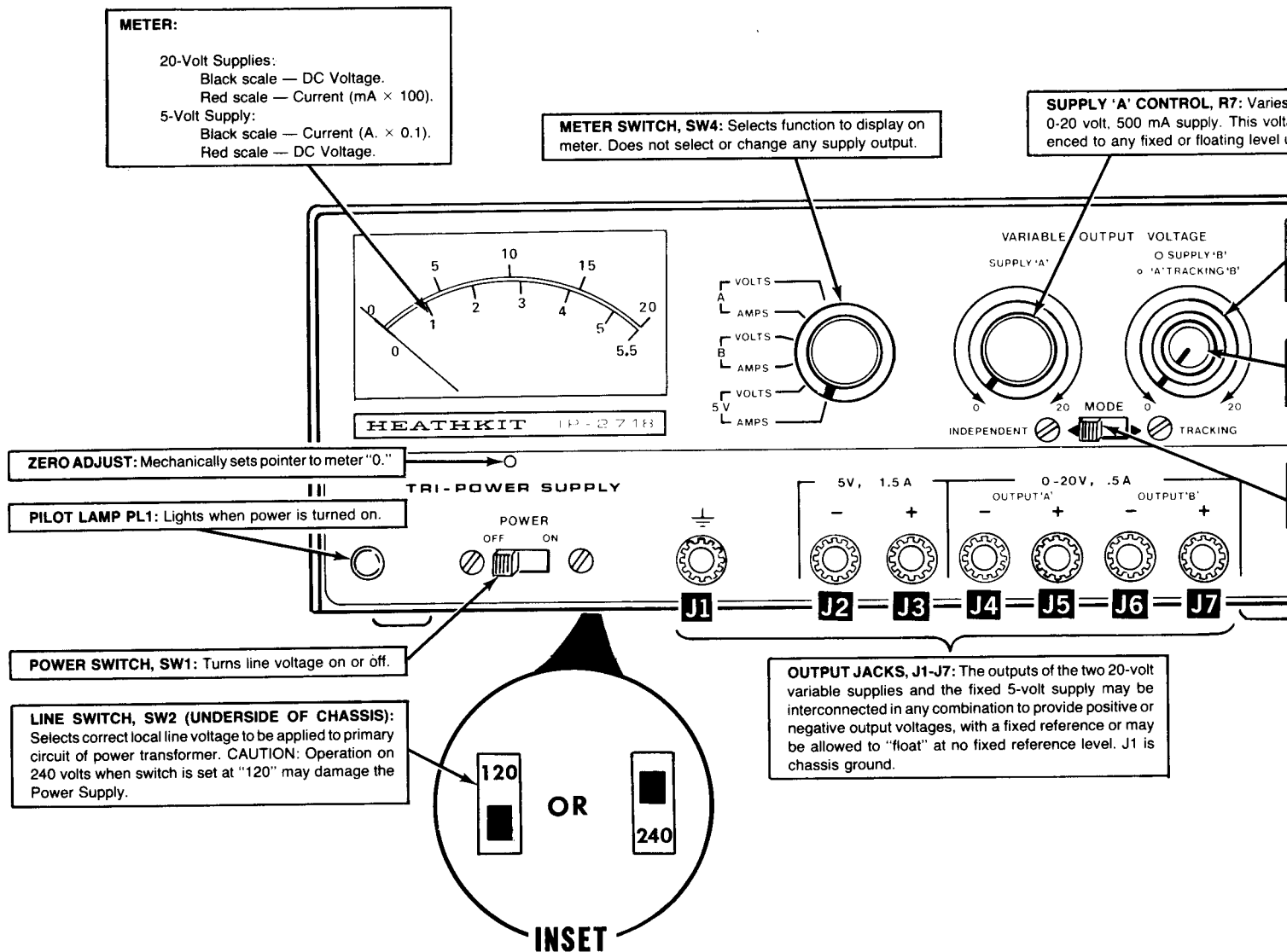

Figure 1



**Figure 1**

**CONTROL, R7:** Varies the voltage of the 0-20 volt, 500 mA supply. This voltage may be referred to any fixed or floating level up to 200 volts.

OUTPUT VOLTAGE  
 ○ SUPPLY 'B'  
 ● 'A' TRACKING 'B'

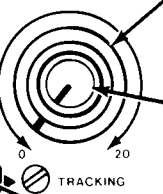

**SUPPLY 'B' CONTROL, R9:** Varies the voltage of a second 0-20 volt, 500 mA supply. This voltage may be referred to any fixed or floating level up to 200 volts.

**'A' TRACKING 'B' CONTROL, R8:** When MODE switch SW3 is in "TRACKING," A supply will track the B-supply. These controls are clutch-coupled.

**MODE SWITCH, SW3:** Permits 'A' supply to operate independently from, or in conjunction with, the 'B' supply.

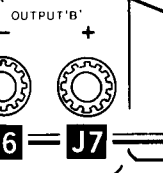

0-20 volt  
 may be  
 referred to  
 any fixed or  
 floating level  
 up to 200 volts

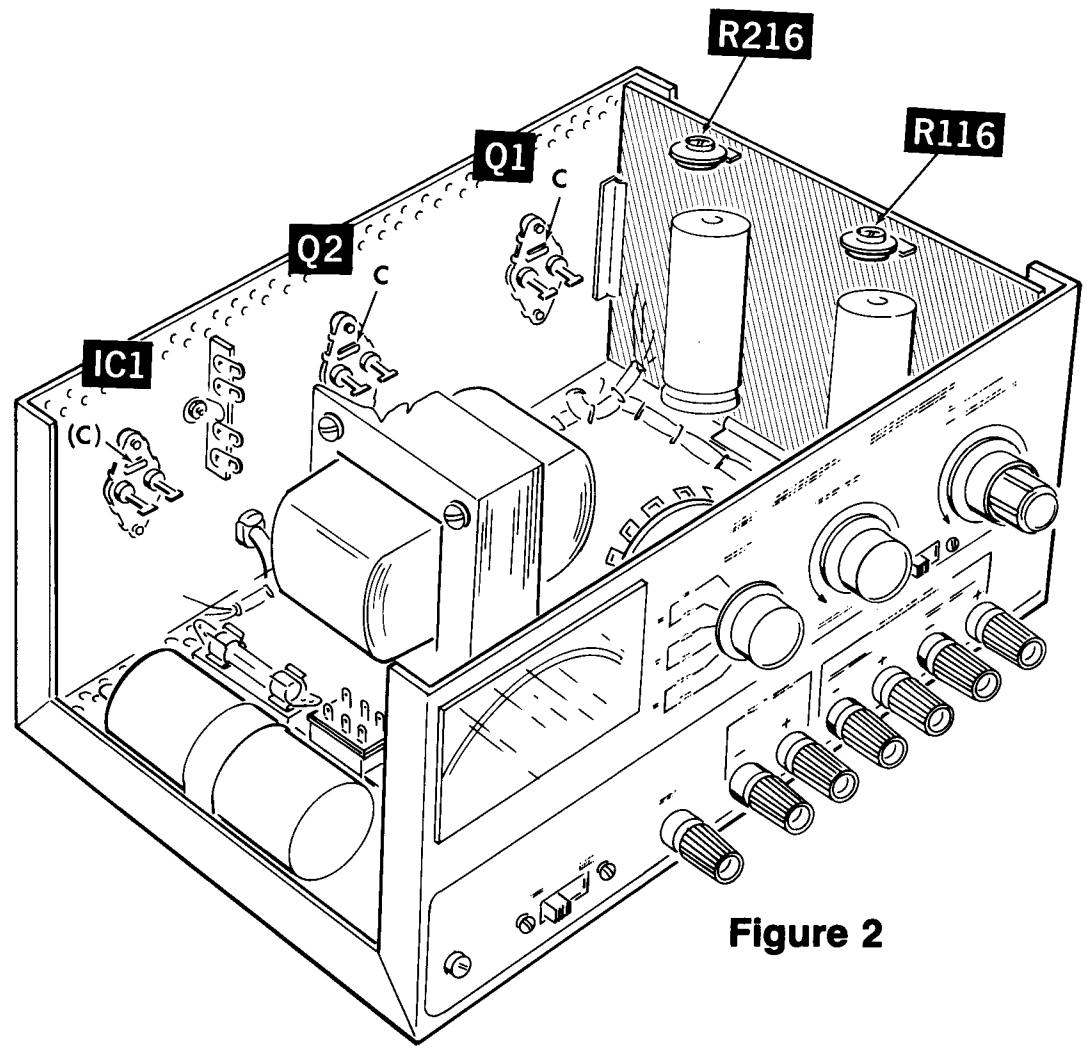

**Figure 2**