

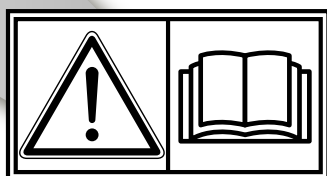

MODEL

EX13D/EX17D
EX21D/EX27D



US INSTRUCTIONS FOR USE (USA only) **US**

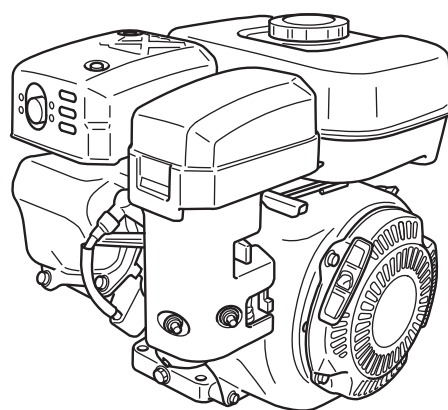

ISSUE EMD-EU1622

2ZZ9990063

Robin Engines

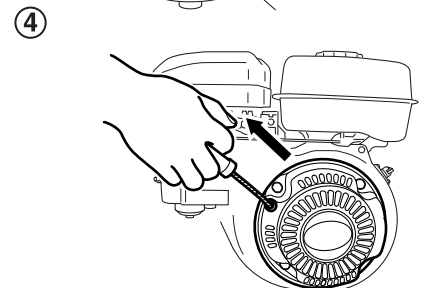
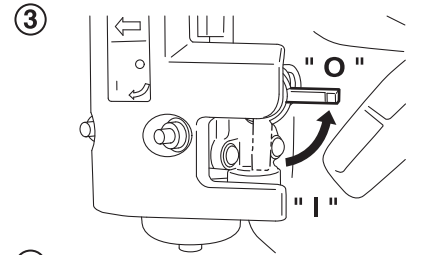
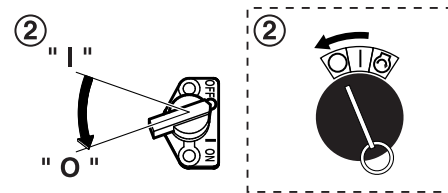
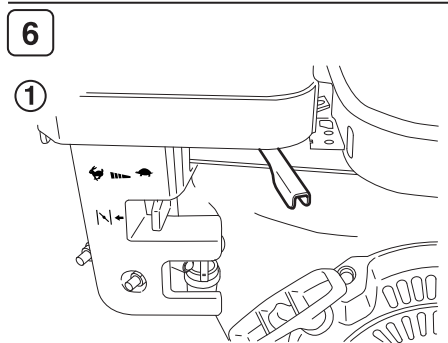
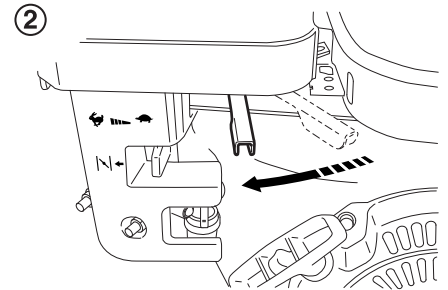
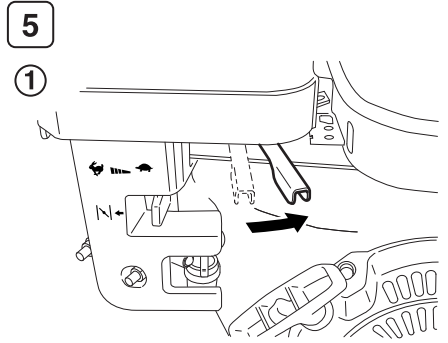
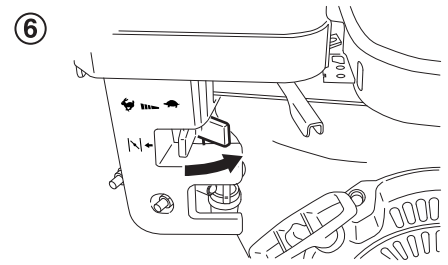
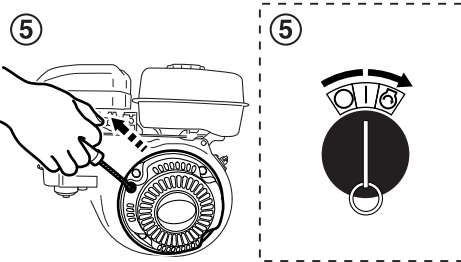
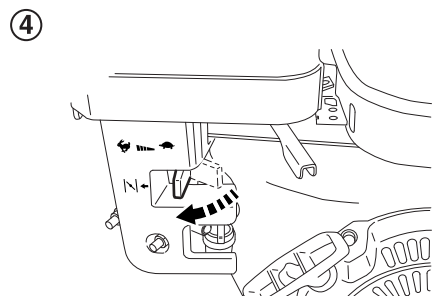
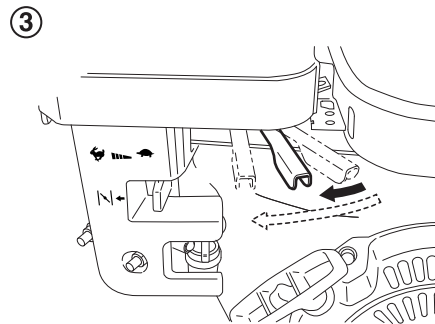
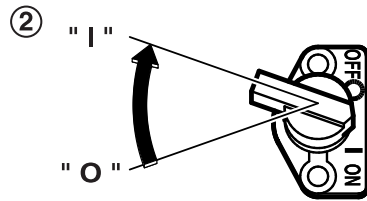
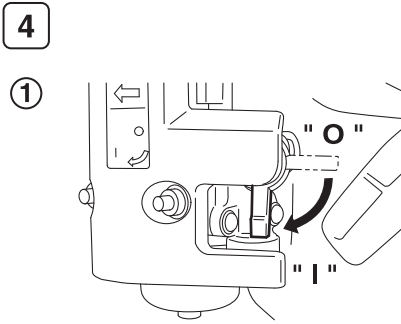
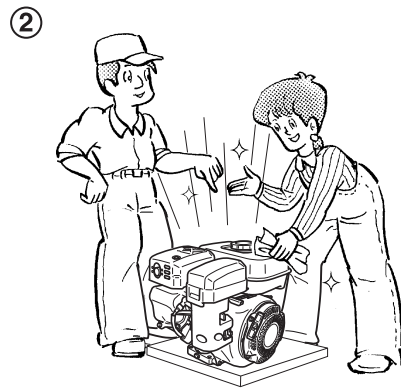
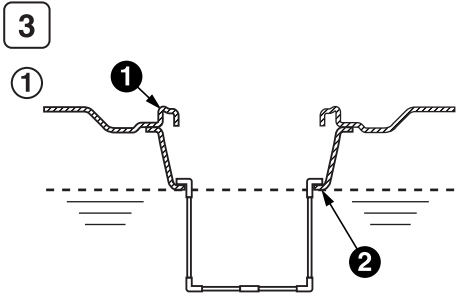
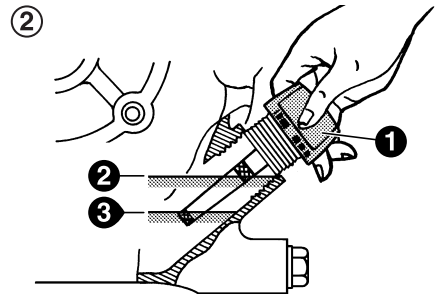
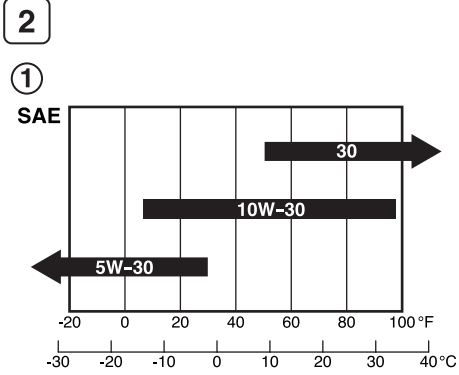
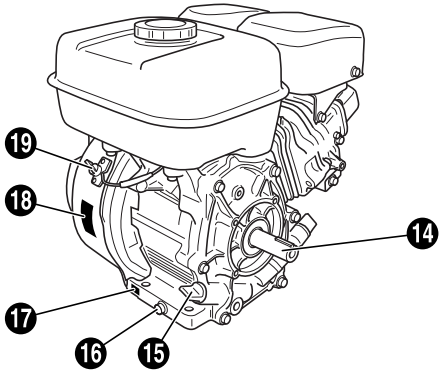
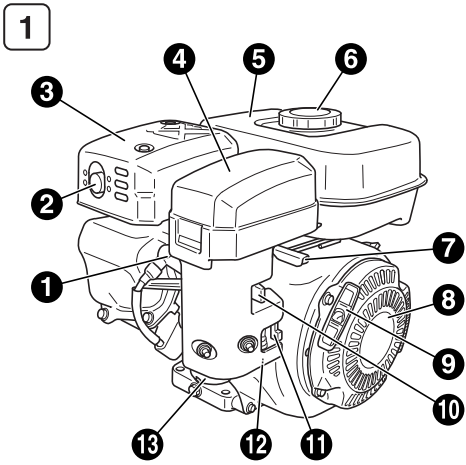

⚠ WARNING ⚠

The engine exhaust from this product contains chemicals known to the State of California to cause cancer, birth defects or other reproductive harm.

NOTICE

FEDERAL EMISSION COMPONENT DEFECT WARRANTY and CALIFORNIA EMISSION CONTROL WARRANTY are applicable to only those engines complied with EPA (Environmental Protection Agency) and CARB (California Air Resources Board) emission regulations.

US

AIR INDEX

An Air Index Information hang tag was supplied to this engine in accordance with the emission regulations of the California Air Resources Board.

The bar graph on the hang tag shows the emissions performance of this engine. The bar graph can be used to compare the emissions performance with other available engines. The lower the Air Index, the less pollution.

The following durability description is to provide you with information relating to the emission durability period of the engine.

<u>Descriptive Term</u>	<u>Applicable to Emissions Durability Period</u>
Moderate	- 125 hours (greater than 65 cc)
Intermediate	- 250 hours (greater than 65 cc)
Extended	- 500 hours (greater than 65 cc)

Notice : The Air Index Information hang tag must remain on the engine or on the equipment until it is sold to the ultimate purchaser. Remove the hang tag before operating the engine.

FEDERAL EMISSIONS COMPONENT DEFECT WARRANTY

EMISSIONS COMPONENT DEFECT WARRANTY COVERAGE

This emission warranty is applicable in all States, except the State of California.

Fuji Heavy Industries Ltd. and Robin America Inc., Wood Dale Illinois, (herein "ROBIN AMERICA") warrant(s) to the initial retail purchaser and each subsequent owner, that this Nonroad engine (herein "engine") has been designed, built, and equipped to conform at the time of initial sale to all applicable regulations of the U.S. Environmental Protection Agency (EPA), and that the engine is free of defects in materials and workmanship which would cause this engine to fail to conform with EPA regulations during its warranty period.

For the components listed under PARTS COVERED, the service dealer authorized by ROBIN AMERICA will, at no cost to you, make the necessary diagnosis, repair, or replacement necessary to ensure that the engine complies with applicable U.S. EPA regulations.

EMISSION COMPONENT DEFECT WARRANTY PERIOD

The warranty period for this engine begins on the date of sale to the initial purchaser and continues for a period of 2 years.

PARTS COVERED

Listed below are the parts covered by the Emission Components Defect Warranty. Some of the parts listed below may require scheduled maintenance and are warranted up to the first scheduled replacement point for that part.

- (1) Fuel Metering System
 - (i) Carburetor and internal parts (and/or pressure regulator or fuel injection system).
 - (ii) Air/fuel ratio feedback and control system, if applicable.
 - (iii) Cold start enrichment system, if applicable.
 - (iv) Regulator assy (gaseous fuel, if applicable)
- (2) Air Induction System
 - (i) Intake manifold, if applicable
 - (ii) Air filter.
- (3) Ignition System
 - (i) Spark plugs.
 - (ii) Magneto or electronic ignition system.
 - (iii) Spark advance/retard system, if applicable.
- (4) Exhaust manifold, if applicable
- (5) Miscellaneous Items Used in Above Systems
 - (i) Electronic controls, if applicable
 - (ii) Hoses, belts, connectors, and assemblies.
 - (iii) Filter lock assy (gaseous fuel, if applicable)

OBTAINING WARRANTY SERVICE

To obtain warranty service, take your engine to the nearest authorized Robin America service dealer. Bring your sales receipts indicating date of purchase for this engine. The service dealer authorized by ROBIN AMERICA will perform the necessary repairs or adjustments within a reasonable amount of time and furnish you with a copy of the repair order. All parts and accessories replaced under this warranty become the property of ROBIN AMERICA.

WHAT IS NOT COVERED

- * Conditions resulting from tampering, misuse, improper adjustment (unless they were made by the service dealer authorized by ROBIN AMERICA during a warranty repair), alteration, accident, failure to use the recommended fuel and oil, or not performing required maintenance services.
- * The replacement parts used for required maintenance services.
- * Consequential damages such as loss of time, inconvenience, loss of use of the engine or equipment, etc.
- * Diagnosis and inspection charges that do not result in warranty-eligible service being performed.
- * Any non-authorized replacement part, or malfunction of authorized parts due to use of non-authorized parts.

OWNER'S WARRANTY RESPONSIBILITIES

As the engine owner, you are responsible for the performance of the required maintenance listed in your owner's manual. ROBIN AMERICA recommends that you retain all receipts covering maintenance on your engine, but ROBIN AMERICA cannot deny warranty solely for the lack of receipts or for your failure to ensure the performance of all scheduled maintenance.

As the engine owner, you should however be aware that ROBIN AMERICA may deny warranty coverage if your engine or a part has failed due to abuse, neglect, improper maintenance or unapproved modifications.

You are responsible for presenting your engine to the nearest service dealer authorized by ROBIN AMERICA when a problem exists.

If you have any questions regarding your warranty rights and responsibilities, you should contact the Robin America customer service department at 1-630-350-8200 for the information.

THINGS YOU SHOULD KNOW ABOUT THE EMISSION CONTROL SYSTEM WARRANTY MAINTENANCE AND REPAIRS

You are responsible for the proper maintenance of the engine. You should keep all receipts and maintenance records covering the performance of regular maintenance in the event questions arise. These receipts and maintenance records should be transferred to each subsequent owner of the engine. ROBIN AMERICA reserves the right to deny warranty coverage if the engine has not been properly maintained. Warranty claims will not be denied, however, solely because of the lack of required maintenance or failure to keep maintenance records.

MAINTENANCE, REPLACEMENT OR REPAIR OF EMISSION CONTROL DEVICES AND SYSTEMS MAY BE PERFORMED BY ANY REPAIR ESTABLISHMENT OR INDIVIDUAL; HOWEVER, WARRANTY REPAIRS MUST BE PERFORMED BY A SERVICE DEALER AUTHORIZED BY ROBIN AMERICA. THE USE OF PARTS THAT ARE NOT EQUIVALENT IN PERFORMANCE AND DURABILITY TO AUTHORIZED PARTS MAY IMPAIR THE EFFECTIVENESS OF THE EMISSION CONTROL SYSTEM AND MAY HAVE A BEARING ON THE OUTCOME OF A WARRANTY CLAIM.

If other than the parts authorized by ROBIN AMERICA are used for maintenance replacements or for the repair of components affecting emission control, you should assure yourself that such parts are warranted by their manufacturer to be equivalent to the parts authorized by ROBIN AMERICA in their performance and durability.

HOW TO MAKE A CLAIM

All repair qualifying under this limited warranty must be performed by a service dealer authorized by ROBIN AMERICA. In the event that any emission-related part is found to be defective during the warranty period, you shall notify Robin America customer service department at 1-630-350-8200 and you will be advised of the appropriate warranty service dealer or service providers where the warranty repair can be performed.

CALIFORNIA EMISSION CONTROL WARRANTY STATEMENT YOUR WARRANTY RIGHTS AND OBLIGATIONS

The California Air Resources Board and Fuji Heavy Industries Ltd. (herein "FUJI") are pleased to explain the emission control system warranty on your 2002 and later Small Off-Road engine (herein "engine"). In California, the engine must be designed, built and equipped to meet the State's stringent anti-smog standards. FUJI must warrant the emission control system on your engine for the periods of time described below, provided there has been no abuse, neglect or improper maintenance of your engine. Your emission control system may include parts such as the carburetor or fuel-injection system, and the ignition system. Also included may be hoses, belts, connectors and other emission-related assemblies. Where a warrantable condition exists, FUJI will repair your engine at no cost to you including diagnosis, parts and labor.

MANUFACTURER'S WARRANTY COVERAGE:

The 2002 and later engines are warranted for two (2) years. If any emission related part on your engine is defective, the part will be repaired or replaced by FUJI.

OWNER'S WARRANTY RESPONSIBILITIES:

- As the engine owner, you are responsible for the performance of the required maintenance listed in your Owner's Manual. FUJI recommends that you retain all receipts covering maintenance on your engine, but FUJI cannot deny warranty solely for the lack of receipts or for your failure to ensure the performance of all scheduled maintenance.
- As the engine owner, you should, however, be aware that FUJI may deny you warranty coverage if your engine or a part has failed due to abuse, neglect, improper maintenance or unapproved modifications.
- You are responsible for presenting your engine to a service dealer or warranty station authorized by ROBIN AMERICA Inc. 940 Lively Blvd., Wood Dale, IL 60191 (herein ROBIN AMERICA) as soon as a problem exists. The warranty repairs should be completed in a reasonable amount of time, not to exceed 30 days.

If you have any questions regarding your warranty rights and responsibilities, you should contact the Robin America Inc. Customer Service Department at 1-630-350-8200.

US

LIMITED WARRANTY on Emission Control Systems -California Only-

FUJI warrants to the owner of the 2002 and later engine that the engine (1) has been designed, built and equipped so as to conform at the time of manufacture with the applicable regulations of the California Air Resources Board, and (2) is free from defects in materials and workmanship that could cause it to fail to conform with those regulations as may be applicable in the terms and conditions stated below.

A. COMMENCEMENT DATE

The warranty period begins on the date the engine is delivered to a first retail purchaser.

B. LENGTH OF COVERAGE

FUJI warrants to a first retail purchaser and each subsequent purchaser that the engine is free from defects in materials and workmanship that cause the failure of a warranted emission-related part for a period of two (2) years after the date of delivery to the first retail purchaser.

C. WHAT IS COVERED:

1. REPAIR OR REPLACEMENT PARTS

Repairs and replacement of any warranted part will be performed at no charge to you by an authorized service dealer or a warranty station. You may contact the Robin America Inc. Customer Service Department at 1-630-350-8200 to obtain the name of the nearest appropriate location where your warranty repairs are performed.

2. WARRANTY PERIOD

This warranty continues for a period of two (2) years and applies only to the repair, replacement or adjustment of the component parts that are not scheduled for replacement as required maintenance. Further, component parts which are scheduled only for regular inspection to the effect of "repair or replace as necessary" are warranted for the warranty period. Any warranted part which is scheduled for replacement as required maintenance is warranted for the period of time up to the first scheduled replacement point for that part.

3. DIAGNOSIS

You will not be charged for diagnostic labor that leads to the determination that a warranted part is defective, if the diagnostic work is performed at an authorized service dealer or warranty station.

4. DAMAGES

If a warranted part failed causing damage to other engine components, consult an warranty station.

D. WHAT IS NOT COVERED

1. This limited warranty does not cover any part which malfunctions, fails or is damaged due to failure to follow the maintenance and operating instructions set forth in the 2002 and later Owner's Manual including:
 - (1) improper or inadequate maintenance of any warranted parts
 - (2) improper installation, adjustment or repair of the engine or of any warranted part unless performed by an authorized service dealer
 - (3) failure to follow recommendations on fuel use contained in the 2002 and later Owner's Manual
 - (4) repairs performed outside of the authorized warranty service dealers
 - (5) use of parts which are not authorized by FUJI.
2. Add-on or modified parts
This warranty does not cover any part that malfunctions, fails or is damaged due to alterations by changing, adding to or removing parts from the engine.
3. Expenses incurred by processing warranty claims
FUJI, any authorized service dealer and warranty station shall not be liable for any loss of use of the engine, for any alternative usage, for any damage to goods, loss of time or inconvenience.

E. HOW TO FILE A CLAIM

All repairs qualifying under this Limited Warranty must be performed by a dealer who sold you the engine or warranty station authorized by ROBIN AMERICA. In the event that any emission-related part is found to be defective during the warranty period, you must notify the Robin America Inc. Customer Service Department at 1-630-350-8200 and you will be advised of the appropriate warranty service facilities where the warranty repair is to be performed.

F. WHERE TO OBTAIN WARRANTY SERVICE

It is recommended that warranty service be performed by the authorized dealer who sold you the engine, although warranty service will be performed by any authorized service dealers or warranty stations anywhere in the United States.

When warranty repair is needed, the engine must be brought to an authorized service dealer or warranty station's place of business during normal business hours. In all cases, a reasonable time, not to exceed 30 days, must be allowed for the warranty repair to be completed after the engine is received by the authorized service dealer or warranty station.

G. MAINTENANCE, REPLACEMENT AND REPAIR OF EMISSION-RELATED PARTS

Only warranted engine replacement parts approved by FUJI should be used in the performance of any warranty maintenance or repairs on emission-related parts. If other than authorized parts are used for maintenance, replacement or repair of components affecting emission control, you should assure yourself that such parts are warranted by their manufacturer to be equivalent to authorized parts in performance and durability. FUJI, however, assumes no liability under this warranty with respect to parts other than authorized parts. The use of non-authorized replacement parts does not invalidate the warranty on other components unless the non-authorized parts cause damage to warranted parts.

H. PARTS COVERED UNDER THE CALIFORNIA EMISSIONS WARRANTY

- (1) Fuel Metering System
 - (i) Carburetor and internal parts (and/or pressure regulator or fuel injection system).
 - (ii) Air/fuel ratio feedback and control system, if applicable.
 - (iii) Cold start enrichment system, if applicable.
 - (iv) Regulator assy (gaseous fuel, if applicable)
- (2) Air Induction System
 - (i) Intake manifold, if applicable
 - (ii) Air filter.
- (3) Ignition System
 - (i) Spark plugs.
 - (ii) Magneto or electronic ignition system.
 - (iii) Spark advance/retard system, if applicable.
- (4) Exhaust manifold, if applicable
- (5) Miscellaneous Items Used in Above Systems
 - (i) Electronic controls, if applicable
 - (ii) Hoses, belts, connectors, and assemblies.
 - (iii) Filter lock assy (gaseous fuel, if applicable)

US

I. MAINTENANCE STATEMENTS

It is your responsibility to have all scheduled inspection and maintenance services performed at the times recommended in the 2002 and later Owner's Manual and to retain proof that inspection and maintenance services are performed at the times when recommended. FUJI will not deny a warranty claim solely because you have no record of maintenance; however, FUJI may deny a warranty claim if your failure to perform required maintenance resulted in the failure of warranted part. The proof which you maintain should be given to each subsequent owner of the engine. You are responsible for performing the scheduled maintenance described below based on the procedures specified in the 2002 and later Owner's Manual. The scheduled maintenance below is based on a normal engine operating schedule.

PROCEDURE	INTERVAL
1) Clean engine and check bolts & nuts	: Every 8 hours (daily)
2) Check and refill engine oil	: Every 8 hours (refill daily up to upper limit)
3) Change engine oil	: Initial 20 hours and every 100 hours afterward
4) Clean spark plug	: Every 50 hours (weekly)
5) Clean air cleaner	: Every 50 hours (weekly)
6) Replace air cleaner element	: Every 200 hours (monthly)
7) Clean fuel filter	: Every 200 hours (monthly)
8) Clean and adjust spark plug and electrodes	: Every 200 hours (monthly)
9) Replace spark plug	: Every 500 hours
10) Remove carbon from cylinder head	: Every 500 hours
11) Check and adjust valve clearance	: Every 500 hours
12) Clean and adjust carburetor	: Every 500 hours
13) Replace fuel lines	: Every 1000 hours (yearly)
14) Overhaul engine	: Every 1000 hours

Note: More frequent maintenance may be necessary under dusty, dirty or severe conditions.

FOREWORD

Thank you very much for purchasing a **ROBIN ENGINE**.

Your **ROBIN ENGINE** can supply the power to operate various sorts of machines and equipment.

Please take a moment to familiarize yourself with the proper operation and maintenance procedures in order to maximize the safe and efficient use of this product.

Keep this owner's manual at hand, so that you can refer to it at any time.

Due to constant efforts to improve our products, certain procedures and specifications are subject to change without notice.

When ordering spare parts, always give us the **MODEL**, **PRODUCTION NUMBER** and **SERIAL NUMBER** of your engine.

Please fill in the following blanks after checking the production number on your engine. (Location of label is different depending on the engine specification.)

PROD NO.									

SER NO.				

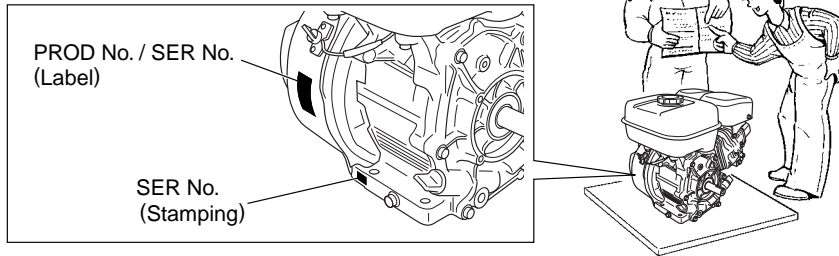

CONTENTS

	Page
1. SAFETY PRECAUTIONS.....	2
2. COMPONENTS	4
3. PRE-OPERATION CHECKS.....	5
4. ELECTRIC STARTER MODELS	5
5. OPERATING YOUR ENGINE	6
6. MAINTENANCE	7
7. PREPARATIONS FOR STORAGE	9
8. OIL SENSOR INSTRUCTIONS (OPTIONAL)	9
9. EASY TROUBLESHOOTING	9
10. SPECIFICATIONS	10

NOTE Please refer to the illustrations on the back page of the front cover or back cover for Fig. ① to ⑩ indicated in the sentence.

US

1. SAFETY PRECAUTIONS

Please make sure you review each precaution carefully.
Pay special attention to statement preceded by the following words.

⚠ WARNING “WARNING” indicates a strong possibility of severe personal injury or loss of life if instructions are not followed.

⚠ CAUTION “CAUTION” indicates a possibility of personal injury or equipment damage if instructions are not followed.

⚠ WARNING : EXHAUST PRECAUTIONS

Never inhale exhaust gasses.

They contain carbon monoxide, a colorless, odorless and extremely dangerous gas which can cause unconsciousness or death.

Never operate the engine indoors or in a poorly ventilated area, such as tunnel, cave, etc.

Exercise extreme care when operating the engine near people or animals.

Keep the exhaust pipe free of foreign objects.

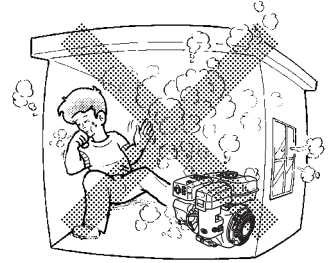

⚠ WARNING : REFUELING PRECAUTIONS

Gasoline is extremely flammable and its vapors can explode if ignited.

Do not refuel indoors or in a poorly ventilated area.

Be sure to stop the engine prior to refueling.

Do not remove fuel tank cap nor fill fuel tank while engine is hot or running.
Allow engine to cool at least 2 minutes before refueling.

Do not overfill the fuel tank.

If fuel is spilt, wipe it away carefully and wait until the fuel has dried before starting the engine.

After refueling, make sure that the fuel cap is secured to prevent spillage.

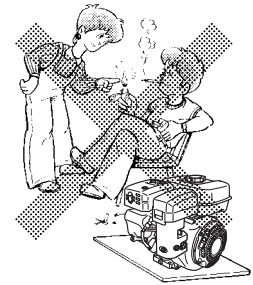
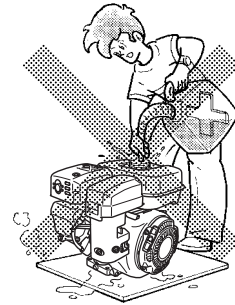

⚠ WARNING : FIRE PREVENTION

Do not operate the engine while smoking or near an open flame.

Do not use around dry brush, twigs, cloth rags, or other flammable materials.

Keep cooling air intake (recoil starter area) and muffler side of the engine at least 1 meter (3 feet) away from buildings, obstructions and other burnable objects.

Keep the engine away from flammables and other hazardous materials (trash, rags, lubricants, explosives).

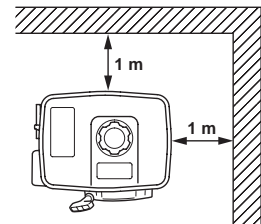

⚠ WARNING : OTHER SAFETY PRECAUTIONS

Place the protective covers over the rotating parts.

If rotating parts such as the drive shaft, pulley, belt, etc. are left exposed, they are potentially hazardous. To prevent injury, equip them with protective covers or shrouds.

Be careful of hot parts.

The muffler and other engine parts become very hot while the engine is running or just after it has stopped. Operate the engine in a safe area and keep children away from the running engine.

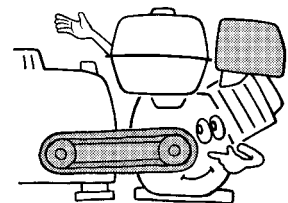

Do not touch the spark plug and ignition cable when starting and operating the engine.

Never make adjustments on the machinery while it is connected to the engine, without first removing the ignition cable from the spark plug. Turning the crankshaft by hand during adjusting or cleaning might start the engine, and cause serious injury to the operator.

Operate the engine on a stable, level surface.

If the engine is tilted, fuel spillage may result.

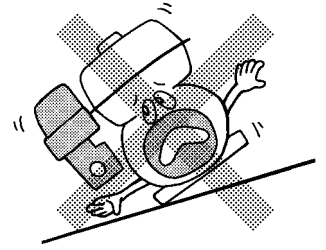

NOTE

Operating the engine at a steep incline may cause seizure due to improper lubrication even with a maximum oil level.

Do not transport the engine with fuel in tank or with fuel strainer cock open.

Do not move the engine while in operation when it has been removed from the equipment.

Keep the unit dry (do not operate it in rainy conditions).

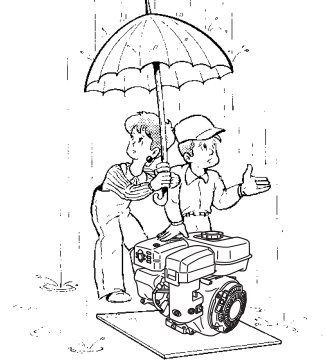

⚠ WARNING : WHEN CHARGING THE BATTERY

Battery electrolyte contains sulphuric acid. Protect your eyes, skin and clothing. In case of contact, flush thoroughly with water and get prompt medical attention, especially if your eyes are affected.

Batteries generate hydrogen gas, which can be highly explosive. Do not smoke or allow flames or sparks near a battery, especially during charging.

Charge the battery in a fully ventilated location.

Be sure to confirm Battery polarity.

⚠ CAUTION : PRE-OPERATION CHECKS

Carefully check fuel hoses and joints for looseness and fuel leakage. Leaked fuel creates a potentially dangerous situation.

Check bolts and nuts for looseness. A loose bolt or nut may cause serious engine trouble.

Check the engine oil and refill if necessary.

Check the fuel level and refill if necessary. Take care not to overfill the tank.

Keep cylinder fins and recoil starter free of dirt, grass and other debris.





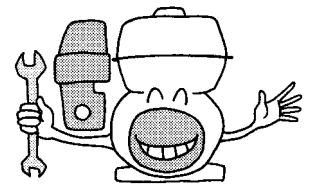





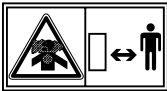

Wear snug fitting working clothes when operating the engine.

Loose aprons, towels, belt, etc., may be caught in the engine or drive train, causing a dangerous situation.



US

SYMBOLS

	Read the owner's manual.		
	Stay clear of the hot surface.		
	Exhaust gas is poisonous. Do not operate in an unventilated area.		
	Stop the engine before refueling.		
	Fire, open flame and smoking prohibited.		
	On (Run)		Plus ; Positive polarity
	Off (Stop)		Battery
	Engine oil		Engine start (Electric start)
	Add oil		

2. COMPONENTS

(See Fig. 1)

NOTE Please refer to the illustrations on the back page of the front cover or back cover for Fig. 1 to 10 indicated in the sentence.

- | | |
|-------------------------------|---------------------------------|
| ① SPARK PLUG | ⑪ FUEL COCK |
| ② EXHAUST OUTLET | ⑫ FUEL CUP |
| ③ MUFFLER COVER | ⑬ CARBURETOR |
| ④ AIR CLEANER | ⑭ P.T.O. SHAFT |
| ⑤ FUEL TANK | ⑮ OIL GAUGE (OIL FILLER) |
| ⑥ FUEL TANK CAP (FUEL FILLER) | ⑯ OIL DRAIN PLUG |
| ⑦ SPEED CONTROL LEVER | ⑰ ENGINE SERIAL NO. (STAMPING) |
| ⑧ RECOIL STARTER | ⑱ ENGINE NAME LABEL (SPEC. No.) |
| ⑨ STARTER HANDLE | ⑲ STOP SWITCH |
| ⑩ CHOKE LEVER | |

3. PRE-OPERATION CHECKS

NOTE

Engine shipped from our factory is without oil.
Before starting engine, fill with oil. Do not over-fill.

1. CHECK ENGINE OIL (See Fig. ②)

Before checking or refilling engine oil, be sure the engine is located on stable, level surface and stopped.

Do not screw the oil gauge into the oil filler neck to check oil level. If the oil level is low, refill to the upper level with the following recommended oil.

Use 4-stroke automotive detergent oil of API service class SE or higher grade.

Select the viscosity based on the air temperature at the time of operation as shown in the table. (See Fig. ②-①)

OIL CAPACITY : EX13/17/21: 0.6 liter
EX27: 1.1 liter

Explanation of Fig. ②-②

- ① Oil Gauge
- ② Upper Level
- ③ Lower Level

2. CHECK FUEL (See Fig. ③)

⚠ WARNING

Do not refuel while smoking, near an open flame or other such potential fire hazards. Otherwise fire accident may occur.

Use unleaded automotive gasoline only.

Fuel Tank Capacity

EX13 : 2.7 liter / EX17 : 3.6 liter
EX21 : 3.6 liter / EX27 : 6.1 liter

Close the fuel cock before filling the fuel tank.

Do not fill above the top of the fuel filter screen (marked ②), or the fuel may overflow when it heats up later and expands.

When filling the fuel tank, always use the fuel filter screen.

Wipe off any spilled fuel before starting the engine.
(See Fig. ③-②)

4. ELECTRIC STARTER MODELS

For electric starter operation, proper electric wiring arrangements are needed before normal engine operation.

1. BATTERY

Use a battery rated 12V-24AH or larger.

⚠ WARNING

Battery electrolyte contains sulphuric acid. Protect your eyes, skin and clothing. In case of contact, flush thoroughly with water and get prompt medical attention, especially if your eyes are affected.

Batteries generate hydrogen gas, which can be highly explosive. Do not smoke or allow flames or sparks near a battery, especially during charging.

Charge the battery in a fully ventilated location.

Be sure to confirm Battery polarity. Connect positive (+) terminal first when mounting battery, and disconnect negative (-) terminal first when dismantling.

US

2. BATTERY CABLE

Use a proper cable and ground wire to connect battery.

For GROUND WIRE, use a flat braided wire of 20 sq. mm. or larger sectional area.

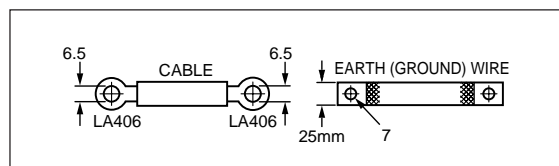

Cable length	Cable dia.	Wire gauge		
		AWG (BS) BWG	SAE	JIS
Less than 1.5m	7.3 mm	1	6	AV15
1.5 m to 2.5 m	8.4 mm	0	4	AV20
2.5 m to 4 m	10.8 mm	3/0	2	AV30

3. KEY SWITCH CABLE

If a remote key switch is used, select wires of proper gauge to connect it and magnetic switch of the engine.

Cable length	Cable dia.	Wire gauge		
		AWG (BS)	BWG	JIS
Less than 1.5 m	1.5 mm	14	16	AV1.25
1.5 m to 3 m	1.9 mm	12	14	AV2
3 m to 5 m	2.4 mm	10	13	AV3

4. WIRING

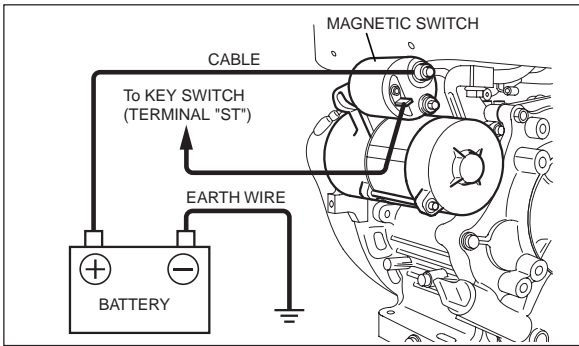

- (1) Connect positive (+) terminal of the magnetic switch and positive (+) terminal of the battery with battery cable.
- (2) Ground negative terminal of the battery to the engine body or machine with ground wire.
- (3) When installing the key switch on the machine, install with its drain hole at the bottom.

NOTE

Tighten bolts and nuts on terminals securely so that they will not be loosened by vibration.

5. WIRING DIAGRAM (RECOIL STARTER MODELS)

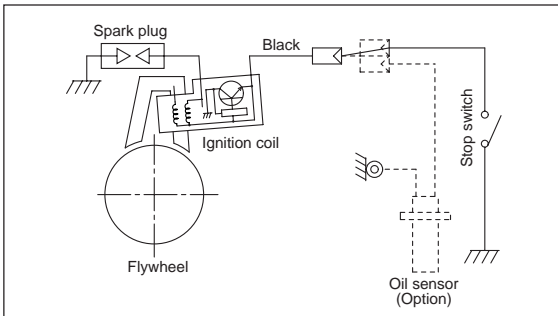

WIRING DIAGRAM (ELECTRIC STARTER MODELS)

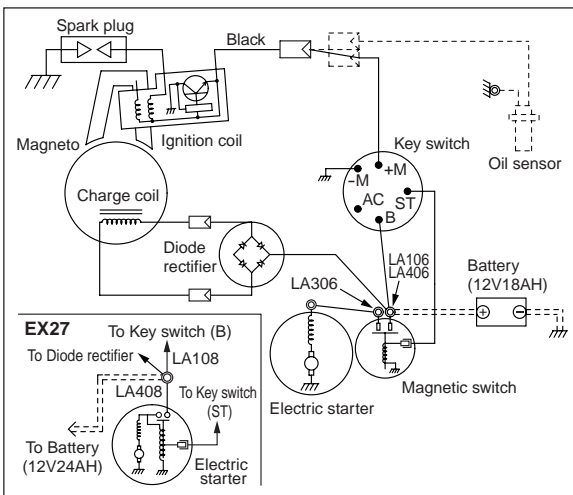

Optional hardware shown by dotted lines.

5. OPERATING YOUR ENGINE

(See Fig. 4)

1. STARTING

- (1) Open the fuel cock. (See Fig. 4-1)
- (2) Turn the STOP SWITCH to the position "I" (ON). (See Fig. 4-2)
- (3) Set the speed control lever 1/3 of the way towards the high speed position. (See Fig. 4-3)
- (4) Close the choke lever. (See Fig. 4-4)

If the engine is cold or the ambient temperature is low, close the choke lever fully.

If the engine is warm or the ambient temperature is high, open the choke lever half-way, or keep it fully open.

- (5) Pull the starter handle slowly until resistance is felt. This is the "compression" point. Return the handle to its original position and pull swiftly. Do not pull out the rope all the way. After starting the engine, allow the starter handle to return to its original position while still holding the handle. (See Fig. 4-5)

FOR ELECTRIC STARTER MODELS.

Insert the key into the key slot and set it at the "I" (ON) position. Turn it to the right (START position) to start the engine. (See Fig. 4-5)

Do not operate the electric starter continuously for more than 5 seconds, even if the engine does not start.

If the engine failed to start, set the key to the "I" (ON) position and wait for about 10 seconds before retrying.

Never turn the key switch to the START position while engine is running.

- (6) After starting the engine, gradually open choke by turning the choke lever and finally keep it fully opened. Do not fully open the choke lever immediately when the engine is cold or the ambient temperature is low, because the engine may stop. (See Fig. 4-6)

2. RUNNING

- (1) After the engine starts, set the speed control lever at the low speed position (L) and warm it up without load for a few minutes. (See Fig. 5-1)
- (2) Gradually move the speed control lever toward the high speed position (H) and set it at the required engine speed. (See Fig. 5-2)

Whenever high speed operation is not required, slow the engine down (idle) by moving the speed control lever to save fuel and extend engine life.

3. STOPPING

- (1) Set the speed control lever at the low speed position and allow the engine to run at low speed for 1 or 2 minutes before stopping. (See Fig. 6-1)
- (2) Turn the STOP SWITCH (or KEY SWITCH) counterclockwise to the position " " (OFF). (See Fig. 6-2)

- (3) Close the fuel cock. (See Fig. 6-3)
- (4) Pull the starter handle slowly and return the handle to its original position when resistance is felt. This operation is necessary to prevent outside moist air from intruding into the combustion chamber. (See Fig. 6-4)

STOPPING ENGINE WITH THE FUEL COCK

Close the fuel cock and wait for a while until the engine stops. Avoid to let the fuel remain in the carburetor over long periods, or the passages of the carburetor may become clogged with impurities, and malfunctions may result.

6. MAINTENANCE

(See Fig. 7)

1. DAILY INSPECTION (See Fig. 7-1)

Before running the engine, check the following service items.

- ① Loose or broken bolts and nuts
- ② Clean air cleaner element
- ③ Enough clean engine oil
- ④ Leakage of gasoline and engine oil
- ⑤ Enough gasoline
- ⑥ Safe surroundings
- ⑦ Excessive vibration, noise

2. PERIODIC INSPECTION

Periodic maintenance is vital to the safe and efficient operation of your engine.

Check the table below for periodic maintenance intervals.

IT IS ALSO NECESSARY FOR THE USER OF THIS ENGINE TO CONDUCT THE MAINTENANCE AND ADJUSTMENTS ON THE EMISSION-RELATED PARTS LISTED BELOW TO KEEP THE EMISSION CONTROL SYSTEM EFFECTIVE.

The emission control system consists of the following parts :

- (1) Carburetor and internal parts
- (2) Cold start enrichment system, if applicable
- (3) Intake manifold, if applicable
- (4) Air cleaner elements
- (5) Spark plug
- (6) Magneto or electronic ignition system
- (7) Spark advance/ retard system, if applicable
- (8) Exhaust manifold, if applicable.
- (9) Hoses, belts, connectors, and assemblies

The maintenance schedule indicated in the following table is based on the normal engine operation.

Should the engine be operated in extremely dusty condition or in heavier loading condition, the maintenance intervals must be shortened depending on the contamination of oil, clogging of filter elements, wear of parts, and so on.

Periodic Maintenance Schedule table

Maintenance Items	Every 8 hours (Daily)	Every 20 hours	Every 50 hours (Weekly)	Every 200 hours (Monthly)	Every 500 hours	Every 1000 hours
CLEAN ENGINE AND CHECK BOLTS AND NUTS	(Daily)					
CHECK AND REFILL ENGINE OIL	(Refill daily up to upper level)					
CHANGE ENGINE OIL (*Note 1)		(Initial)	(Every 100 hours)			
CLEAN SPARK PLUG						
CLEAN AIR CLEANER						
REPLACE AIR CLEANER ELEMENT						
CLEAN FUEL CUP						
CLEAN AND ADJUST SPARK PLUG AND ELECTRODES						
REPLACE SPARK PLUG						
REMOVE CARBON FROM CYLINDER HEAD (*Note 2)						
CHECK AND ADJUST VALVE CLEARANCE (*Note 2)						
CLEAN AND ADJUST CARBURETOR (*Note 2)						
REPLACE FUEL LINES						(yearly)
OVERHAUL ENGINE IF NECESSARY (*Note 2)						

*Note: 1. Initial oil change should be performed after first twenty (20) hours of operation. Thereafter change oil every hundred (100) hours. Before changing oil, check for a suitable way to dispose of old oil. Do not pour it down into sewage drains, onto garden soil or into open streams. Your local zoning or environmental regulations will give you more detailed instructions on proper disposal.

*Note: 2. As to the procedures for these items, please refer to the SERVICE MANUAL or consult your nearest Robin service dealer.

3. INSPECTING THE SPARK PLUG

(See Fig. 7-2)

- (1) Clean off carbon deposits on the spark plug electrode using a plug cleaner or wire brush.
- (2) Check electrode gap. The gap should be 0.6 mm to 0.7 mm (0.02 inch.-0.03 inch.). Adjust the gap, if necessary, by carefully bending the side electrode.

**Recommended Spark Plug : NGK BR-6HS
(CHAMPION RL86C)**

4. ENGINE OIL CHANGE (See Fig. 7-3,4)

**Initial oil change : After 20 hours of operation
Thereafter : Every 100 hours of operation**

- (1) When changing oil, stop the engine and loosen the drain plug. Drain the used oil while the engine is warm. Warm oil drains quickly and completely.

CAUTION

To prevent injury, pay attention to the hot oil.

- (2) Re-install the drain plug before refilling oil.

**OIL CAPACITY : EX13/17/21: 0.6 liter
EX27: 1.1 liter**

- (3) Refer to page 5 for the recommended oil.

Always use the best grade and clean oil. Contaminated oil, poor quality oil and shortage of oil cause damage to engine or shorten the engine life.

5. CLEANING FUEL CUP

(See Fig. 7-5)

WARNING Flame Prohibited

- (1) Inspect fuel cup for water and dirt.
(See Fig. 7-5-1)
- (2) To remove water and dirt, close the fuel cock and remove the fuel cup.
- (3) After removing dirt and water, wash the fuel cup with kerosene or gasoline. Reinstall securely to prevent leakage.

6. CLEANING AIR CLEANER

(See Fig. 7-6,7)

A dirty air cleaner element will cause starting difficulty, power loss, engine malfunctions, and shorten engine life extremely. Always keep the air cleaner element clean.

WARNING Flame Prohibited

- (1) Urethane Foam Element Type
(See Fig. 7-6)

Remove the element and wash it in kerosene or diesel fuel. Then saturate it in a mixture of 3 parts kerosene or diesel fuel and 1 part engine oil. Squeeze the element to remove the mixture and install it in the air cleaner.

- (2) Urethane Foam Dual Element Type
(See Fig. 7-7)

Urethane Foam cleaning (See Fig. 7-7-2)
Wash and clean the urethane foam with detergent. After cleaning, dry it. Clean the urethane foam element every 50 hours.

Second element (See Fig. 7-7-1)

Clean by tapping gently to remove dirt and blow off dust. Never use oil. Clean the paper element every 50 hours of operation, and replace element set every 200 hours.

Clean and replace air cleaner elements more often when operating in dusty environments.

7. FUEL HOSE REPLACEMENT (See Fig. 7-8)

WARNING

Take extreme caution when replacing fuel hose ; gasoline is extremely flammable.

Replace the fuel hose every 1,000 hours or every year. If fuel leaks from fuel hose, replace the fuel hose immediately.

8. CHECKING BOLTS, NUTS AND SCREWS

Retighten loose bolts and nuts.

Check for fuel and oil leaks.

Replace damaged parts with new ones.

9. CHECK BATTERY

WARNING Flame Prohibited

If the electrolyte fluid is below level line, refill with distilled water to the upper level line.

7. PREPARATIONS FOR STORAGE

1. DISCHARGE FUEL (See Fig. 8-1)

⚠ WARNING Flame Prohibited

If you do not use the engine more than 1 month, discharge fuel to prevent gum in the fuel system and carburetor parts.

Remove the fuel cup, place it over a container and open the fuel cock to discharge fuel from the fuel tank.

Remove the drain screw of the carburetor float chamber and discharge fuel.

2. ENGINE OIL (See Fig. 8-2)

Change the engine oil with fresh oil.

Remove the spark plug, pour about 5 cc of engine oil into the cylinder, slowly pull the starter handle of the recoil starter 2 or 3 times, and reinstall the spark plug.

3. CLEAN AND STORE

Slowly pull the recoil starter handle until resistance is felt and leave it in that position.

Clean the engine thoroughly with an oiled cloth, put the cover on, and store the engine indoors in a well ventilated, low humidity area.

8. OIL SENSOR INSTRUCTIONS

(OPTIONAL)

1. FUNCTION OF OIL SENSOR

The engine will stop automatically when the oil level falls below the safety limit. The engine cannot be started unless the level is raised above the prescribed limit.

(See Fig. 2-2)

2. RESTARTING

- (1) Fill the crankcase with oil up to the proper level.
- (2) As for restarting and operating the engine, refer to section "5. OPERATING YOUR ENGINE" on page 6 .

Check the wire connector from the engine. It must be connected securely to the wire from oil sensor.

When selecting the engine oil, refer to page 5 for the recommended oil.

9. EASY TROUBLESHOOTING

(See Fig. 10)

WHEN ENGINE WILL NOT START :

Perform the following checks before you take the engine to your Robin dealer. If you still have trouble after completing the checks, take the engine to your nearest Robin dealer.

1. Is there a strong spark across the electrode ? (See Fig. 10-2)

- (1) Is the stop switch at position " I " (ON)?
- (2) Remove and inspect the spark plug.
If the electrode is fouled, clean or replace it with new one.
- (3) Remove the spark plug and connect it to the plug cap. Pull the starter handle while grounding spark plug against engine body. Try with a new spark plug if the spark is weak or there is no spark.
The ignition system is faulty if there is no spark with a new spark plug.

⚠ WARNING

Wipe out spilled fuel carefully before testing. Place spark plug as far away from spark plug hole as possible.

Do not hold spark plug by hand while pulling recoil starter.

NOTE

The engine with oil sensor will stop automatically when the oil level falls below the prescribed limit.

Unless the oil level is raised above the prescribed limit, the engine will stop immediately after starting.

2. Is there enough compression?

(See Fig. 10-3)

Pull the starter handle slowly and check if resistance is felt. If little force is required to pull the starter handle, check if the spark plug is tightened firmly. If the spark plug is loose, tighten it.

3. Is the spark plug wet with gasoline?

(See Fig. 10-4)

- (1) Is the fuel cock opened?
- (2) Choke (close choke lever) and pull the starter handle five or six times. Remove the plug and check if its electrode is wet. If the electrode is wet, fuel is well supplied to your engine.
- (3) When the electrode is dry, check where the fuel stops. (Check the fuel intake of the carburetor.)
- (4) In case the engine does not start with well supplied fuel, try using fresh fuel.

4. Is the battery well charged?

If the battery for the electric starter is discharged, the engine will not start.

10. SPECIFICATIONS

MODEL		EX13D	EX17D	EX21D	EX27D
Type		Air-cooled, 4-cycle single cylinder, overhead camshaft, gasoline engine			
Displacement	mL (cc)	126	169	211	265
Continuous Output	kW/rpm (HP/rpm)	2.2/3600 (3.0/3600)	2.9/3600 (4.0/3600)	3.7/3600 (5.0/3600)	5.1/3600 (7.0/3600)
Maximum Output	kW/rpm (HP/rpm)	3.2/4000 (4.3/4000)	4.2/4000 (5.7/4000)	5.1/4000 (7.0/4000)	6.6/4000 (9.0/4000)
Direction of Rotation		Counterclockwise, as Viewed from P.T.O. Shaft side			
Lubricant		Automotive detergent oil (API/ SE or higher grade, SAE/ 10W-30 etc.)			
Oil Capacity	Liter	0.6			1.1
Fuel		Automotive Gasoline (Unleaded)			
Fuel Tank Capacity	Liter	2.7	3.6		6.1
Spark Plug		NGK BR-6HS (CHAMPION RL86C)			
Starting System		Recoil starter	Recoil starter / Electric starter		
Dry Weight	kg	14	15	16	21
Dimensions (L x W x H)	mm	297 x 341 x 318	304 x 354 x 335	311 x 366 x 335	355 x 420 x 410
Emissions Durability Period (California only)		500 hours			

7

1

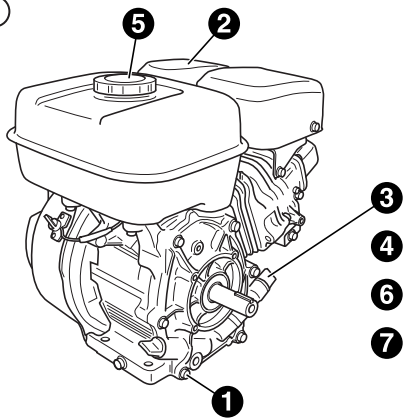

2

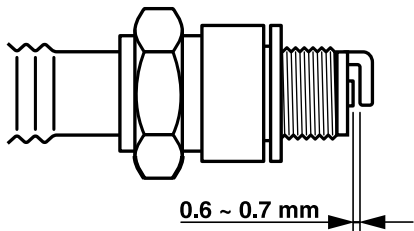

3

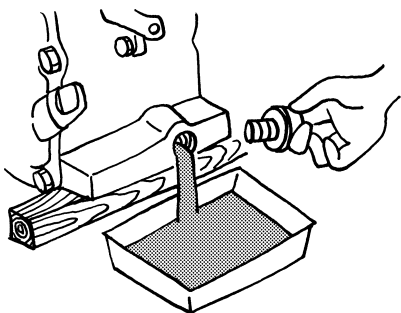

4

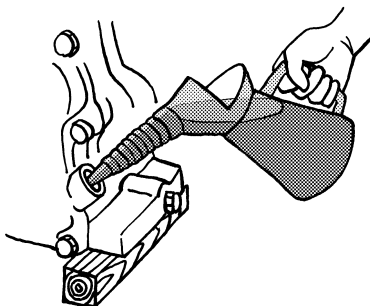

5

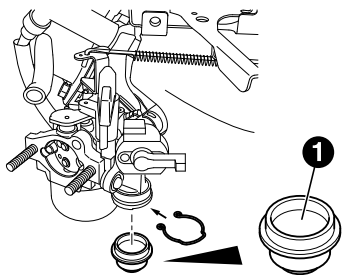

6

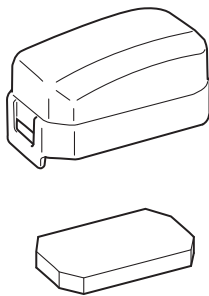

7

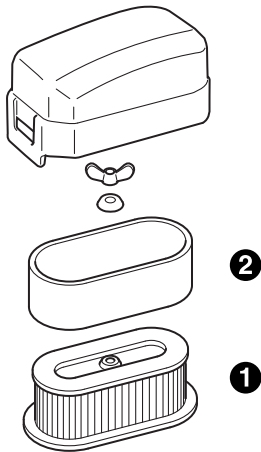

8

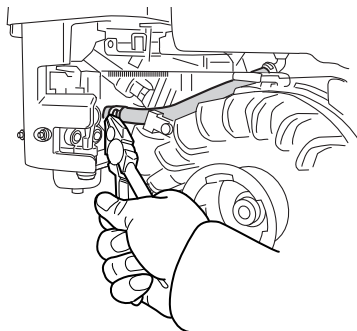

8

1

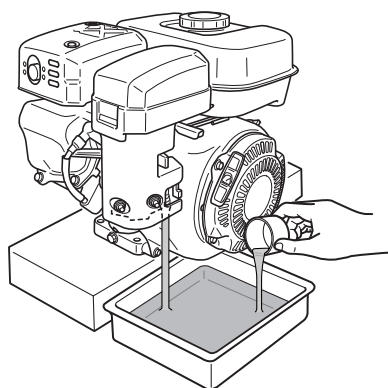

2

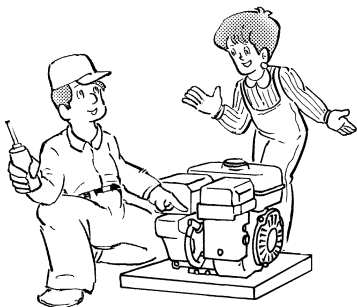

9

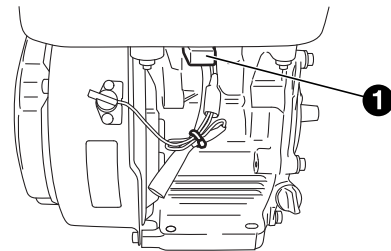

10

1



2



3



4

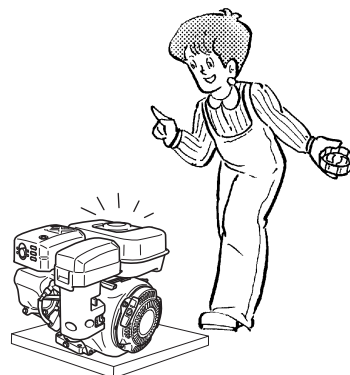



富士重工業株式会社

産業機器カンパニー 〒364-8511 埼玉県北本市朝日4-410

サービス部

国内技術サービス課 TEL:048-593-7857 FAX 7965

部品課 TEL:048-593-7780 FAX 7797

国内営業部

東部営業課 TEL:048-593-7847 FAX 7948

中部・北部営業課 TEL:048-593-7851

西部営業課 TEL:048-593-7841

FUJI HEAVY INDUSTRIES LTD.

INDUSTRIAL PRODUCTS COMPANY

4-410 Asahi, Kitamoto-shi,

Saitama, 364-8511, Japan

Phone +81(48) 593-7798

Fax +81(48) 593-7946

Web site <http://www.fhi.co.jp/robin/>