

LC-20E1U

**SHARP**<sup>®</sup>



**LC-20E1U**

ENGLISH

FRANÇAIS

ESPAÑOL

PORTUGUÊS

**SHARP**<sup>®</sup>  
**SHARP ELECTRONICS CORPORATION**  
Sharp Plaza, Mahwah, New Jersey 07430-2135  
**SHARP CORPORATION**

LIQUID CRYSTAL TELEVISION  
TÉLÉVISEUR ACL  
TELEVISOR CON PANTALLA  
DE CRISTAL LÍQUIDO  
TELEVISOR DE CRISTAL  
LÍQUIDO

**AQUOS**



OPERATION MANUAL  
MODE D'EMPLOI  
MANUAL DE OPERACIÓN  
MANUAL DE OPERAÇÃO

**NOM 1245**   
NYCE

**SHARP**<sup>®</sup>

Printed in Japan  
Imprimé au Japon  
Impreso en Japón  
Impresso no Japão  
TINS-A158WJN1  
02P06-JKG

Printed on post-consumer recycled paper.  
Imprimé sur du papier recyclé.  
Impreso en papel reciclado.  
Impresso em papel reciclado pós utilização.

# LC-20E1U

## LIQUID CRYSTAL TELEVISION

### ENGLISH



## OPERATION MANUAL

**IMPORTANT:**





To aid reporting in case of loss or theft, please record the TV's model and serial numbers in the space provided. The numbers are located at the rear of the TV.

Model No.:
Serial No.:

U.S.A. ONLY

## IMPORTANT INFORMATION

**WARNING:** TO REDUCE THE RISK OF FIRE OR ELECTRIC SHOCK, DO NOT EXPOSE THIS PRODUCT TO RAIN OR MOISTURE.

 <div style="border: 1px solid black; padding: 5px; text-align: center;"> <p><b>CAUTION</b></p> <p>RISK OF ELECTRIC SHOCK. DO NOT OPEN.</p> </div> 	 <p>The lightning flash with arrow-head symbol, within an equilateral triangle, is intended to alert the user to the presence of uninsulated "dangerous voltage" within the product's enclosure that may be of sufficient magnitude to constitute a risk of electric shock to persons.</p>
<p>CAUTION: TO REDUCE THE RISK OF ELECTRIC SHOCK, DO NOT REMOVE COVER (OR BACK). NO USER-SERVICEABLE PARTS INSIDE. REFER SERVICING TO QUALIFIED SERVICE PERSONNEL.</p>	 <p>The exclamation point within a triangle is intended to alert the user to the presence of important operating and maintenance (servicing) instructions in the literature accompanying the product.</p>

# IMPORTANT INFORMATION

---

**WARNING:** FCC Regulations state that any unauthorized changes or modifications to this equipment not expressly approved by the manufacturer could void the user's authority to operate this equipment.

U.S.A. ONLY

**CAUTION:** TO PREVENT ELECTRIC SHOCK, MATCH WIDE BLADE OF PLUG TO WIDE SLOT, FULLY INSERT.

"Note to CATV system installer: This reminder is provided to call the CATV system installer's attention to Article 820-40 of the National Electrical Code that provides guidelines for proper grounding and, in particular, specifies that the cable ground shall be connected to the grounding system of the building, as close to the point of cable entry as practical."

This product utilizes tin-lead solder, and fluorescent lamp containing a small amount of mercury. Disposal of these materials may be regulated due to environmental considerations. For disposal or recycling information, please contact your local authorities or the Electronic Industries Alliance: [www.eia.org](http://www.eia.org)

# DEAR SHARP CUSTOMER

Thank you for your purchase of the Sharp LCD Color TV product. To ensure safety and many years of trouble-free operation of your product, please read the Safety Precautions carefully before using this product.

## IMPORTANT SAFETY PRECAUTIONS

Electricity is used to perform many useful functions, but it can also cause personal injuries and property damage if improperly handled. This product has been engineered and manufactured with the highest priority on safety. However, improper use can result in electric shock and/or fire. In order to prevent potential danger, please observe the following instructions when installing, operating and cleaning the product. To ensure your safety and prolong the service life of your LCD color TV product, please read the following precautions carefully before using the product.

- Read instructions—All operating instructions must be read and understood before the product is operated.
- Keep this manual in a safe place—These safety and operating instructions must be kept in a safe place for future reference.
- Observe warnings—All warnings on the product and in the instructions must be observed closely.
- Follow instructions—All operating instructions must be followed.
- Attachments—Do not use attachments not recommended by the manufacturer. Use of inadequate attachments can result in accidents.
- Power source—This product must operate on a power source specified on the specification label. If you are not sure of the type of power supply used in your home, consult your dealer or local power company. For units designed to operate on batteries or another power source, refer to the operating instructions.
- Power cord protection—The power cords must be routed properly to prevent people from stepping on them or objects from resting on them. Check the cords at the plugs and product.
- If the AC adapter is misplaced or needs to be replaced, obtain the same type of adapter from a SHARP service center or your dealer.
- Overloading—Do not overload AC outlets or extension cords. Overloading can cause fire or electric shock.
- Entering of objects and liquids—Never insert an object into the product through vents or openings. High voltage flows in the product, and inserting an object can cause electric shock and/or short internal parts. For the same reason, do not spill water or liquid on the product.
- Servicing—Do not attempt to service the product yourself. Removing covers can expose you to high voltage and other dangerous conditions. Request a qualified service person to perform servicing.
- Repair—If any of the following conditions occurs, unplug the power cord from the AC outlet, and request a qualified service person to perform repairs.
  - a. When the power cord or plug is damaged.
  - b. When a liquid was spilled on the product or when objects have fallen into the product.
  - c. When the product has been exposed to rain or water.
  - d. When the product does not operate properly as described in the operating instructions. Do not touch the controls other than those described in the operating instructions. Improper adjustment of controls not described in the instructions can cause damage, which often requires extensive adjustment work by a qualified technician.
  - e. When the product has been dropped or damaged.
  - f. When the product displays an abnormal condition. Any noticeable abnormality in the product indicates that the product needs servicing.
- Replacement parts—In case the product needs replacement parts, make sure that the service person uses replacement parts specified by the manufacturer, or those with the same characteristics and performance as the original parts. Use of unauthorized parts can result in fire, electric shock and/or other danger.
- Safety checks—Upon completion of service or repair work, request the service technician to perform safety checks to ensure that the product is in proper operating condition.
- Wall or ceiling mounting—When mounting the product on a wall or ceiling, be sure to install the product according to the method recommended by the manufacturer.
- Polarization—This AC adapter may be equipped with a polarized alternating current line plug (a plug having one blade wider than the other). This plug will fit into the power outlet only one way. This is a safety feature. If you are unable to insert the plug fully into the outlet, try reversing the plug. If the plug should still fail to fit, contact your electrician to replace your obsolete outlet. Do not defeat the safety purpose of the polarized plug.

# IMPORTANT SAFETY PRECAUTIONS (Continued)

- **Cleaning**—Unplug the power cord from the AC outlet before cleaning the product. Use a damp cloth to clean the product. Do not use liquid cleaners or aerosol cleaners.

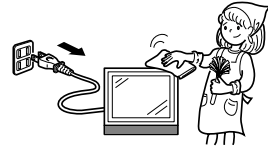

- **Water and moisture**—Do not use the product near water, such as bathtub, washbasin, kitchen sink and laundry tub, swimming pool and in a wet basement.



- **Stand**—Do not place the product on an unstable cart, stand, tripod or table. Placing the product on an unstable base can cause the product to fall, resulting in serious personal injuries as well as damage to the product. Use only a cart, stand, tripod, bracket or table recommended by the manufacturer or sold with the product. When mounting the product on a wall, be sure to follow the manufacturer's instructions. Use only the mounting hardware recommended by the manufacturer.



- When relocating the product placed on a cart, it must be moved with utmost care. Sudden stops, excessive force and uneven floor surface can cause the product to fall from the cart.



- **Ventilation**—The vents and other openings in the cabinet are designed for ventilation. Do not cover or block these vents and openings since insufficient ventilation can cause overheating and/or shorten the life of the product. Do not place the product on a bed, sofa, rug or other similar surface, since they can block ventilation openings. This product is not designed for built-in installation; do not place the product in an enclosed place such as a bookcase or rack, unless proper ventilation is provided or the manufacturer's instructions are followed.



- The LCD panel used in this product is made of glass. Therefore, it can break when the product is dropped or applied with impact. Be careful not to be injured by broken glass pieces in case the LCD panel breaks.

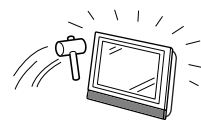

- **Heat sources**—Keep the product away from heat sources such as radiators, heaters, stoves and other heat-generating products (including amplifiers).

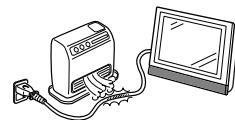

- The LCD panel is a very high technology product with 921,600 thin film transistors, giving you fine picture details. Occasionally, a few non-active pixels may appear on the screen as a fixed point of blue, green or red. Please note that this does not affect the performance of your product.

# IMPORTANT SAFETY PRECAUTIONS (Continued)

- If an outside antenna is connected to the television equipment, be sure the antenna system is grounded so as to provide some protection against voltage surges and built-up static charges. Section 810 of the National Electrical Code provides information with respect to proper grounding of the mast and supporting structure, grounding of the lead-in wire to an antenna discharge unit, size of grounding conductors, location of antenna-discharge unit, connection to grounding electrodes, and requirements for the grounding electrode.

EXAMPLE OF ANTENNA GROUNDING AS PER NATIONAL ELECTRICAL CODE

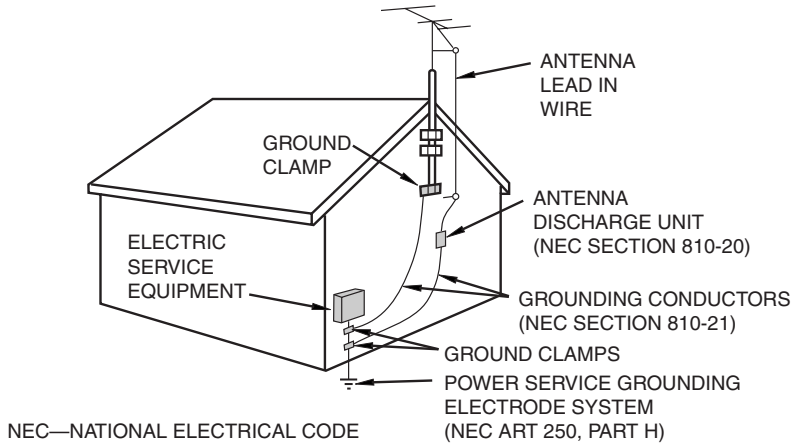

- For added protection for this television equipment during a lightning storm, or when it is left unattended and unused for long periods of time, unplug it from the wall outlet and disconnect the antenna. This will prevent damage to the equipment due to lightning and power-line surges.

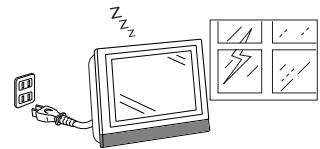

- An outside antenna system should not be located in the vicinity of overhead power lines or other electric light or power circuits, or where it can fall into such power lines or circuits. When installing an outside antenna system, extreme care should be taken to keep from touching such power lines or circuits as contact with them might be fatal.

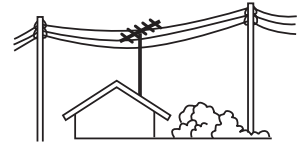



# CONTENTS

---

	Page
DEAR SHARP CUSTOMER .....	3
IMPORTANT SAFETY PRECAUTIONS .....	3-5
SUPPLIED ACCESSORIES .....	7
PREPARATION .....	8-10
Using the Remote Control .....	8
Batteries for the Remote Control .....	8
Power Connection .....	9
Antenna Connection .....	9, 10
FRONT AND REAR CONTROL OPTIONS .....	11-13
Removing the Back Cover .....	13
Listening with Headphones .....	13
EZ SETUP .....	14
EZ SETUP during the First Power On .....	14
REMOTE CONTROL .....	15
BASIC OPERATION .....	15-18
Turning on POWER .....	16
Switching TV/VIDEO [AV1/AV2/COMPONENT/TV] Modes .....	16
Sound Volume .....	17
ON/OFF Standby .....	17
Changing the Channels .....	18
SELECTING MENU ITEMS .....	19
Selecting Menu Items .....	19
ADJUSTMENT .....	20-37
Adjusting the SLEEP TIMER Settings .....	20
Adjusting the BRIGHTNESS Settings .....	21
Adjusting the PICTURE FLIP Settings .....	22
Adjusting the LANGUAGE Settings .....	23
Adjusting the VIDEO ADJUST Settings .....	24, 25
Adjusting the PRESET Settings .....	26
SET UP .....	27, 28
Adjusting the BLUE SCREEN Settings .....	29
Adjusting the CLOSED CAPTION Settings .....	30, 31
Adjusting the V-CHIP Settings .....	32-37
CONNECTING WITH EXTERNAL DEVICES .....	38-40
How to Fix the Cables .....	40
TROUBLESHOOTING .....	41, 42
SPECIFICATIONS .....	43
DIMENSIONAL DRAWINGS .....	44

# SUPPLIED ACCESSORIES

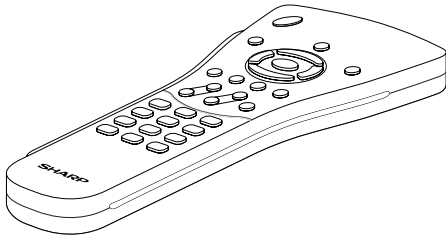
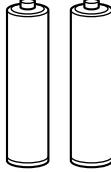
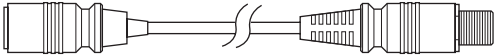
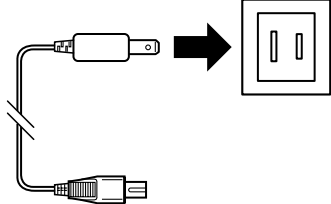
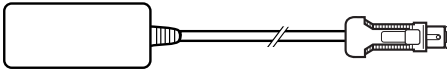
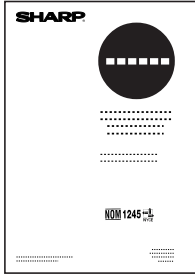
Make sure the following accessories are provided with the product.

Remote Control	“AAA” size (UM/SUM-4) Dry Battery (×2)	
 <p>RRMCGA077WJSA (LC-20E1U) RRMCGA077WJSB (LC-20E1UB) RRMCGA077WJSC (LC-20E1UW)</p>	 <p>UBATU0038CEZZ</p>	
Antenna Cable	AC Cord	
 <p>QCNWG0003CEPA</p>	 <p>QACCD3097CEPA</p>	
AC Adapter	Operation Manual	Cable Clamp
 <p>UADP-0243CEPZ</p>	 <p>TINS-A158WJN1</p>	 <p>LHLDW0109CESA (LC-20E1U, LC-20E1UW) LHLDW0109CESB (LC-20E1UB)</p>



# PREPARATION

## Using the Remote Control

- Use the remote control by pointing it towards the remote sensor window on the main unit. Objects between the remote control and sensor window may prevent proper operation.

### Cautions regarding use of remote control

- Do not expose the remote control to shock. In addition, do not expose the remote control to liquid, and do not place in an area with high humidity.
- Do not install or place the remote control under direct sunlight. The heat may cause deformation of the unit.
- The remote control may not work properly if the remote sensor window of the main unit is under direct sunlight or strong lighting. In such case, change the angle of the lighting or LCD TV set, or operate the remote control closer to the remote sensor window.

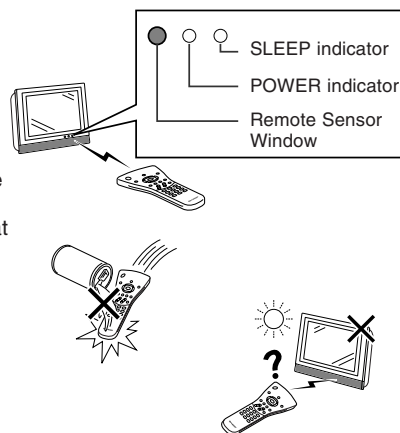

## Batteries for the Remote Control

Before using the LCD TV set for the first time, install two ("AAA" size, UM/SUM-4) batteries (supplied). When the batteries become depleted and the remote control fails to operate, replace the batteries with new ("AAA" size, UM/SUM-4) batteries.

- 1** Open the battery cover.

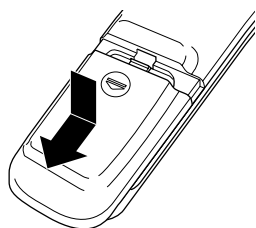

- Slide the cover while pressing the (▼) part.

- 2** Insert two ("AAA" size, UM/SUM-4) batteries.

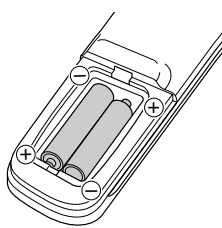

- Position the positive and negative ends of the batteries as indicated in the compartment.

- 3** Close the battery cover.

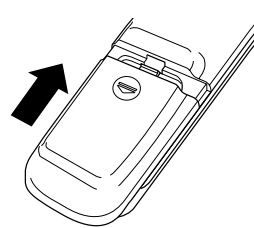

- Engage the claw on the cover into the battery housing and slide shut.

### ⚠ Caution!

#### Cautions regarding batteries

Improper use of batteries can result in chemical leakage and/or explosion. Be sure to follow the instructions below.

- Place batteries with their terminals corresponding to the (+) and (-) indications.
- Different types of batteries have different characteristics. Do not mix batteries of different types.
- Do not mix old and new batteries. Mixing old and new batteries can shorten the life of new battery and/or cause the old battery to leak chemicals.
- Remove batteries when they become weak. Chemicals that leak from batteries can cause a rash. If chemical leakage is found, wipe with a cloth.
- The batteries supplied with the product may have a shorter life expectancy due to storage conditions.
- If the remote control will not be used for an extended period of time, remove the batteries from the remote control.

# PREPARATION (Continued)

## Power Connection

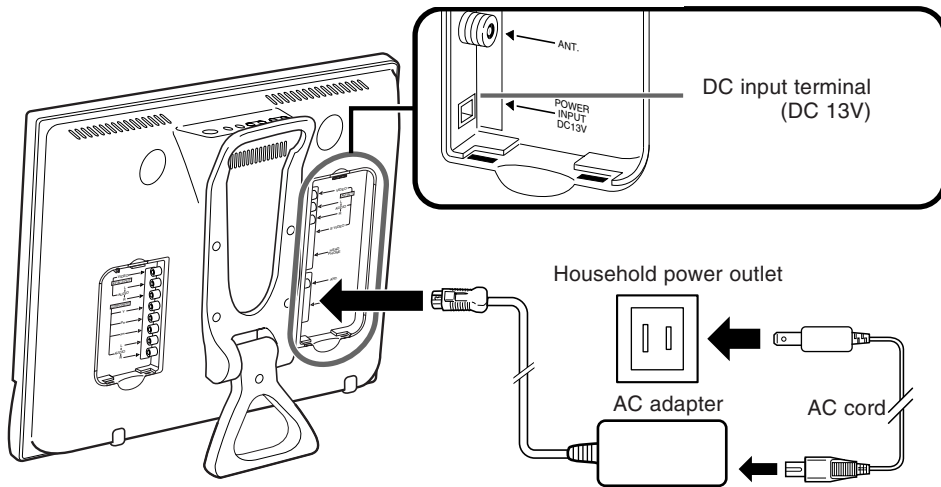

### NOTE

- Use a commercially available AC plug adapter, if necessary, depending on the design of the wall outlet.
- Always turn the **MAIN POWER** switch of the LCD TV set to off when connecting the AC adapter.
- Always unplug the AC adapter from the product and power outlet when not using for a long period of time.

## Antenna Connection

### CABLE TV (CATV) CONNECTION

- A 75-ohm coaxial cable connector is built into the set for easy hookup. When connecting the 75-ohm coaxial cable to the set, screw the 75-ohm cable to the ANT. terminal.
- Some cable TV companies offer “premium pay channels”. Since the signals of these premium pay channels are scrambled, a cable TV converter/descrambler is generally provided to the subscriber by the cable TV company. This converter/descrambler is necessary for normal viewing of the scrambled channels. (Set your TV to channel 3 or 4, typically one of these channels is used. If this is unknown, consult your cable TV company.) For more specific instructions on installing cable TV, consult your cable TV company. One possible method of utilizing the converter/descrambler provided by your cable TV company is explained below.

Please note: An RF switch provided with two inputs (A and B) is required (not supplied).

“A” position on the RF switch (not supplied) : You can view all unscrambled channels by using the TV’s channel keys.

“B” position on the RF switch (not supplied) : You can view the scrambled channels via the converter/descrambler by using the converter’s channel keys.

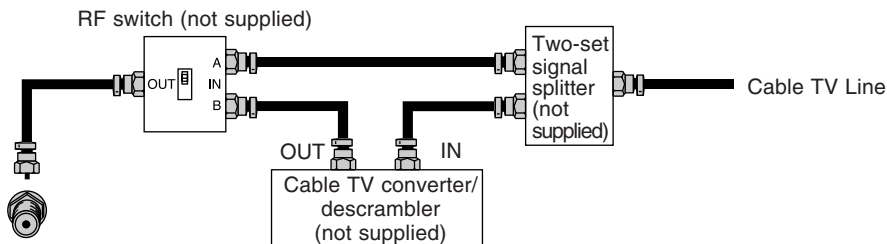

### NOTE

- Consult your SHARP Dealer or Service Center for the type of splitter, RF switch or combiner that might be required.

# PREPARATION (Continued)

## Antenna Connection (Continued)

### ANTENNAS

- The antenna requirements for good color television reception are more important than those for black & white television reception. For this reason, a good quality outdoor antenna is strongly recommended. The following is a brief explanation of the type of connections that are provided with the various antenna systems.

1. A 75-ohm system is generally a round cable with F-type connector that can easily be attached to a terminal without tools (not supplied).

F-type connector

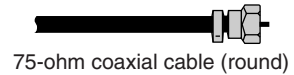

2. A 300-ohm system is a flat "twin-lead" cable that can be attached to a 75-ohm terminal through a 300-75-ohm adapter (not supplied).

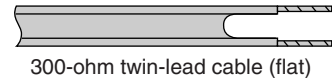

### OUTDOOR ANTENNA CONNECTION

- Use one of the following two diagrams if you connect an outdoor antenna.
  - A: Using a VHF/UHF combination outdoor antenna.
  - B: Using separate VHF and/or UHF outdoor antennas.
- Connect the outdoor antenna cable lead-in to the ANT. terminal on the rear of the TV set.

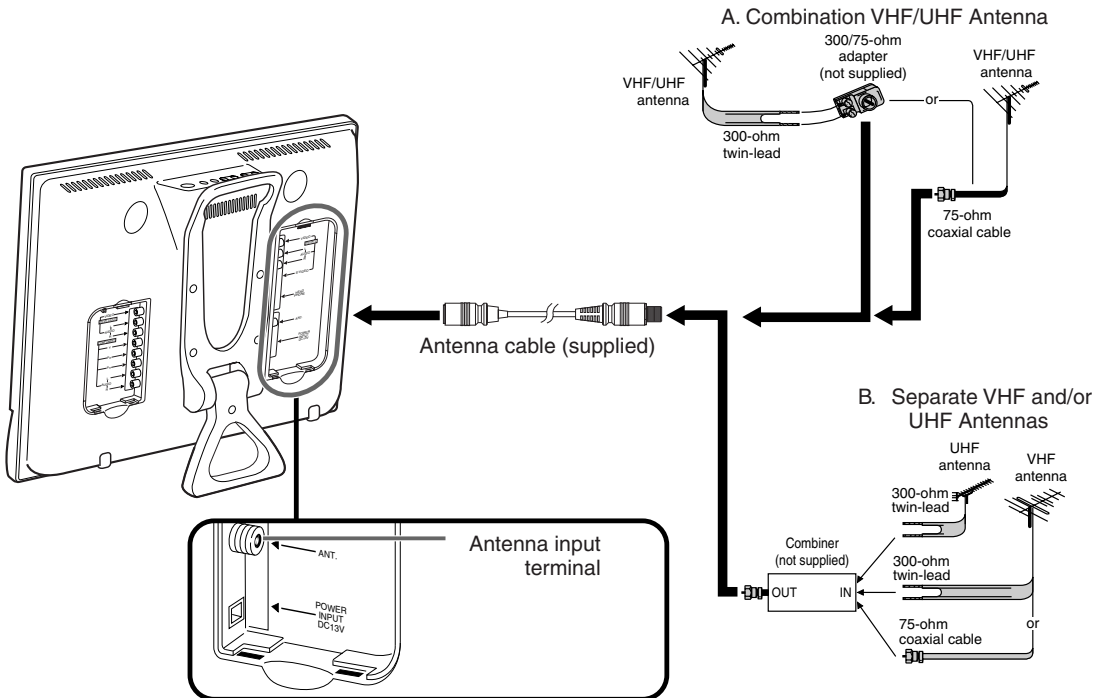

# FRONT AND REAR CONTROL OPTIONS

## Main unit (front view)

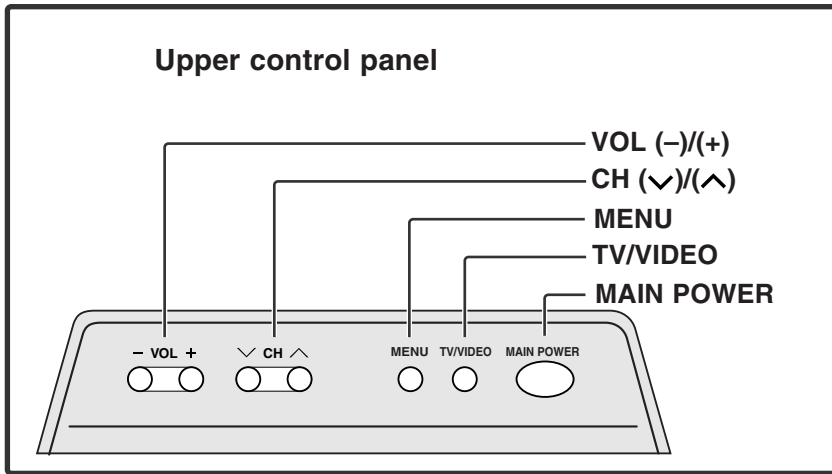

The screen can be adjusted backwards to an angle between 12 degrees and 35 degrees. The screen cannot be set up straight. When changing the angle, make sure to hold the stand and adjust the screen to the best viewable angle.

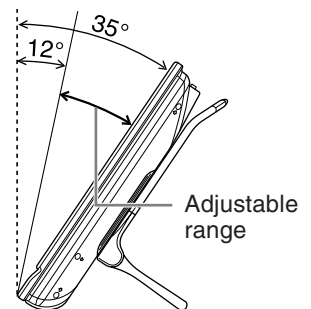

Remote sensor window

**SLEEP indicator**

The SLEEP indicator lights up red when the SLEEP TIMER is set to on.

**POWER indicator**

A green indicator lights when the power is on and a red indicator lights when in the standby mode (the indicator will not light when the main power is off).

### NOTE

- **TV/VIDEO**, **CH (v)/(^)**, **VOL (-)/(+)**, and **MENU** on the main unit have the same functions as the same buttons on the remote control. Basically, this operation manual provides a description based on operation with the remote control.

# FRONT AND REAR CONTROL OPTIONS (Continued)

## Main unit (rear view)

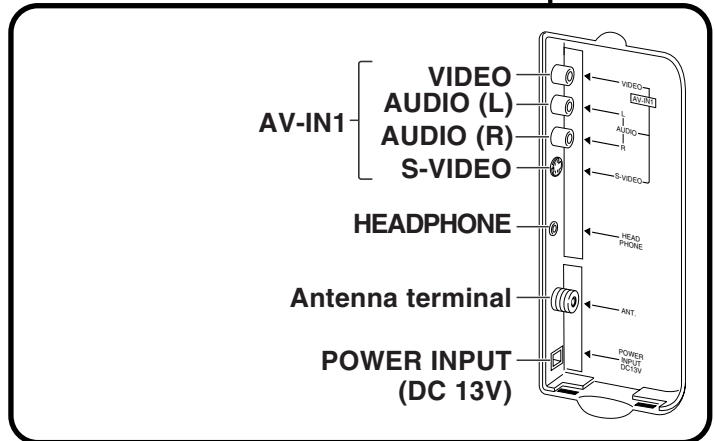
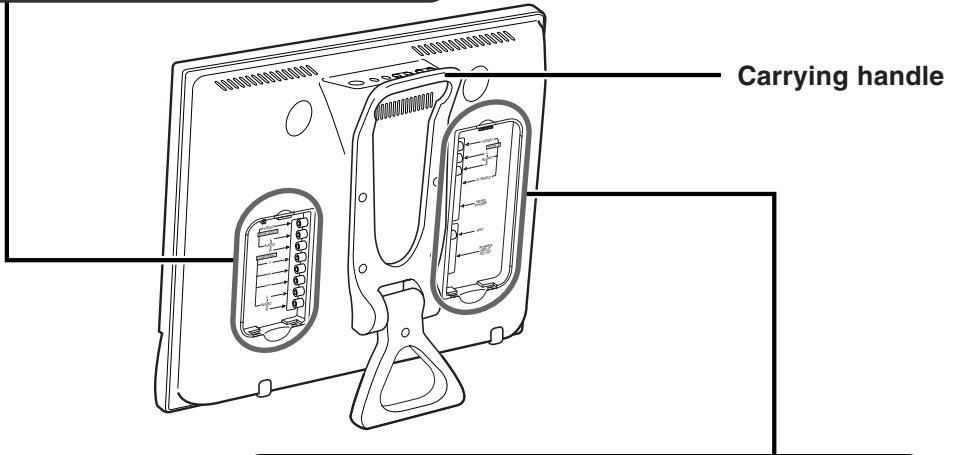
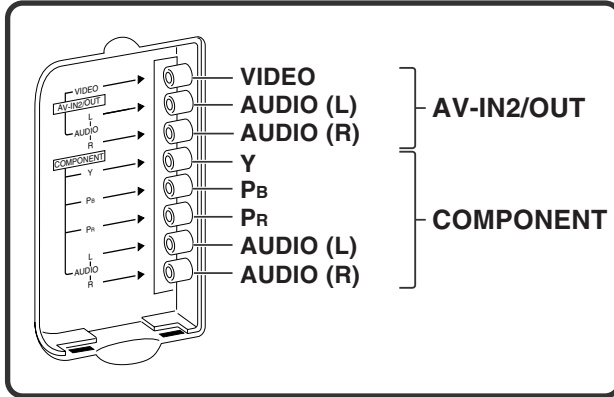

# FRONT AND REAR CONTROL OPTIONS (Continued)

## Removing the Back Cover

■ Before connecting a connection cord into the rear terminal, remove the back cover. Push in the tab and pull out the back cover carefully.

■ To mount the cover, insert the 2 hooks on the bottom of the cover into the cabinet and press on the upper part of the back cover until the tab locks in place with a click.

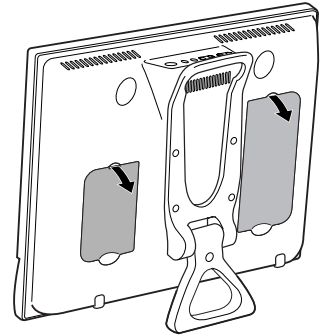

## Listening with Headphones

■ Plug the headphone mini-plug into the HEADPHONE jack located on the rear of the TV set.

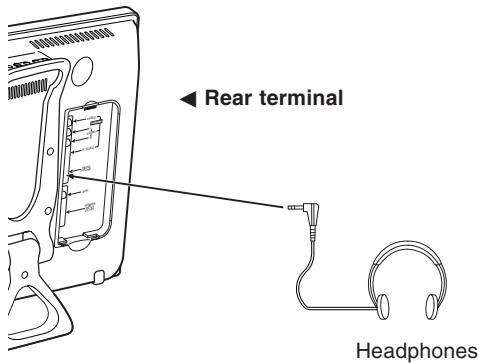

### ▼ On-screen display

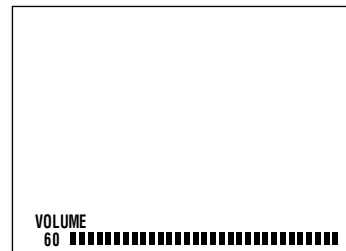

### NOTE

- Headphones are not included in the supplied accessories.
- No sound will be heard from the main unit speakers when a headphone mini-plug is connected into the HEADPHONE jack.

# EZ SETUP

## EZ SETUP during the First Power On

### Control section of main unit

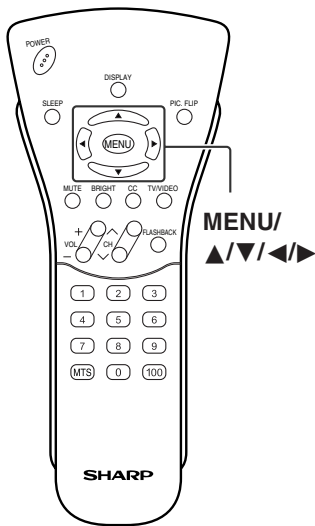
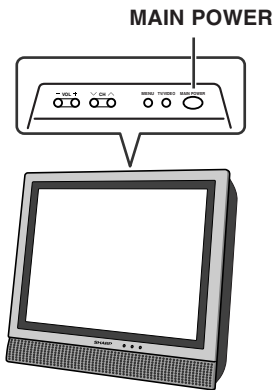

■ When you turn on the TV for the first time, it will automatically memorize the broadcasting channels. Please perform the following instructions before you press **MAIN POWER**.

- (1) Insert the batteries into the remote control. (See page 8.)
- (2) Connect the antenna cable to the TV set. (See page 10.)
- (3) Connect the AC adapter to the DC input terminal of the product and plug in the AC cord to the wall outlet. (See page 9.)

- 1 Press **MAIN POWER**, located on the upper side of the main unit, to turn on the TV. The **SELECT LANGUAGE** mode will be displayed.
- 2 Press **▲/▼** to select "ENGLISH", "ESPAÑOL (SPANISH)" or "FRANCAIS (FRENCH)".
- 3 Press **◀▶** to access **EZ SETUP** mode.

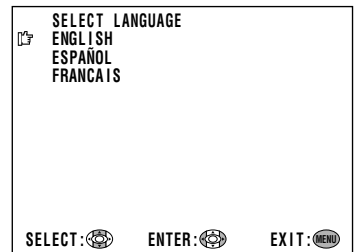

- 4 Press **▶**.  
 The tuner will automatically search for the broadcasting and cable TV channels. (The CH No. will automatically increase when it appears.)

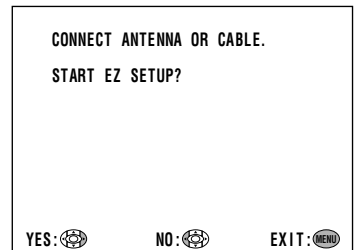

If you want to stop the **EZ SETUP** process once it has started, press **◀** and it will be canceled. If you want to **SET UP** again, please refer to pages 27 and 28 on **SET UP**.

### To cancel EZ SETUP

Press **◀**.



- 5 Once **EZ SETUP** is completed, the lowest channel number memorized will be displayed.

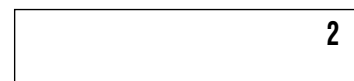

### NOTE

- Do not let the **EZ SETUP** screen display unattended for a long time.
- If **EZ SETUP** does not memorize all the channels in your region, please refer to pages 27 and 28 for more information on manually memorizing the channels using **CHANNEL SETTING**.
- It may be difficult to **PRESET** when the broadcasting signals are weak, the channel cycle frequency is incorrect or the frequency jamming is occurring around the area. Please refer to pages 27 and 28 for more information on manually memorizing channels using **CHANNEL SETTING**.

# REMOTE CONTROL

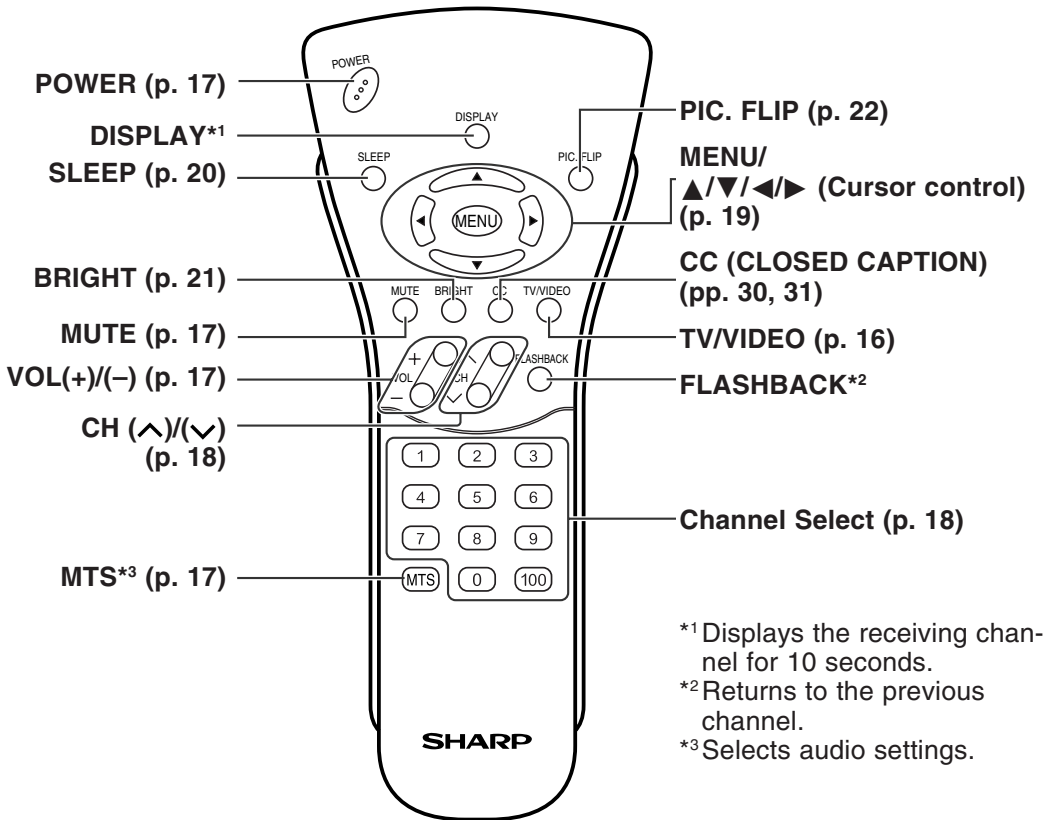

## BASIC OPERATION

This product is factory set to comply with the TV broadcasting system in the United States. For Brazil, Argentina and Uruguay, set the color system according to the country before using this product by following the table below.

Country	TV broadcasting system	Factory setting of color system		User setting
		TV	Video	TV/Video
U.S.A.	Color: NTSC TV ch: US ch	NTSC (N358) US ch	NTSC (N358) US ch	Not required or N/A
Canada, Mexico, Latin America	Color: NTSC TV ch: US ch	NTSC (N358) US ch	NTSC (N358) US ch	Not required or N/A
Brazil	Color: PAL-M TV ch: US ch	NTSC (N358) US ch	NTSC (N358) US ch	Set color system to PAL-M (see page 25)
Argentina, Uruguay	Color: PAL-N TV ch: US ch	NTSC (N358) US ch	NTSC (N358) US ch	Set color system to PAL-N (see page 25)

### NOTE

- The 3 Dimensional Y/C separation circuit\* only works when the color system is set to N358 in TV mode and Video mode.
- \*The 3 Dimensional Y/C separation circuit is used to remove flickering and color bleeding.



# BASIC OPERATION (Continued)

## Turning on POWER

### Control section of main unit

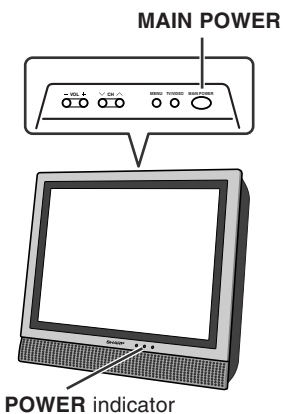

- 1 Press **MAIN POWER**, located on the upper side of the main unit, to on.
- 2 The **POWER** indicator instantaneously changes from red to green and the main unit is turned on.

#### NOTE

- The input mode indication disappears after several seconds.

#### ▼ On-screen display

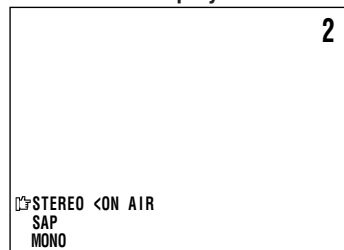

## Switching TV/VIDEO [AV1/AV2/COMPONENT/TV] Modes

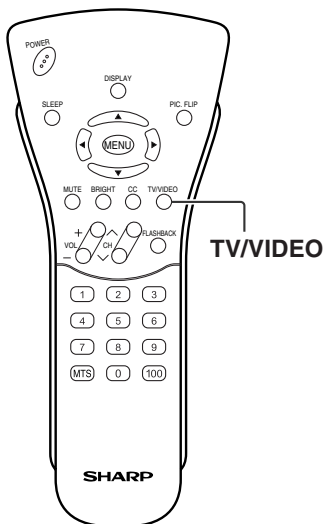

- 1 Turn on the power of the connected video equipment.
- 2 Press **TV/VIDEO** and select the applicable input source. The screen displays AV1, AV2, COMPONENT or TV mode each time **TV/VIDEO** is pressed.

#### NOTE

- The AV input mode indication remains for 3 seconds.
- AV1: Video equipment connected to the AV1 input terminals. An S-Video input terminal is additionally provided for the AV1 input. If both the S-Video terminal and normal video terminals are connected with cables, the S-Video input terminal takes priority.
- AV2: AV2 mode is used to adjust the preset settings and IN or OUT can be selected. AV2 indication is not displayed when OUT is selected. (For details on setting AV2-IN/OUT, see page 26.)
- COMPONENT: Video equipment connected to the COMPONENT input terminals.

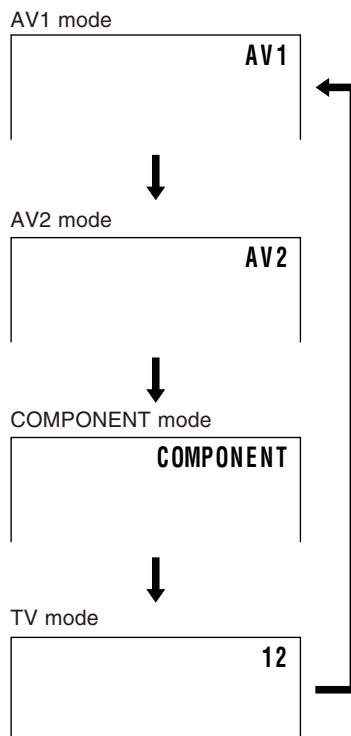

# BASIC OPERATION (Continued)

## Sound Volume

### POWER

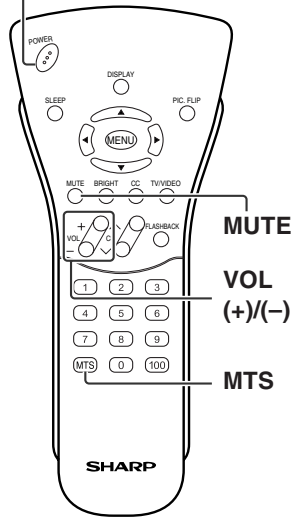

**1** Press **VOL (+)** to increase the sound volume. The segment of the indicator increases.



**2** Press **VOL (-)** to decrease the sound volume. The segment of the indicator decreases.

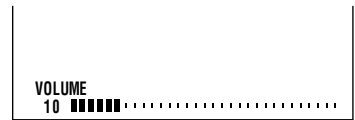

### To mute the sound

**1** Press **MUTE** to temporarily turn off the sound. The MUTE mark is displayed for 4 seconds.



**2** Press **MUTE** or **VOL (+)/(-)** to turn the sound back to the previous level. The mute function is automatically turned off when any of the following buttons are pressed: **POWER**, **VOL (+)/(-)** or **MTS**.

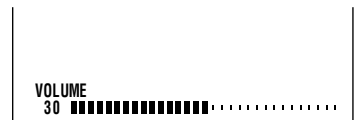

### To select MTS (Multi ch TV Sound)

**1** Press **MTS** to display the **MTS** screen.

**2** Press **MTS** to select the **MTS** settings.  
**STEREO:** stereo audio  
**SAP:** second audio program  
**MONO:** monophonic audio

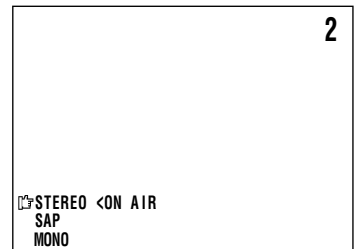

### NOTE

- <ON AIR appears when a STEREO or SAP broadcast is being aired.

## ON/OFF Standby

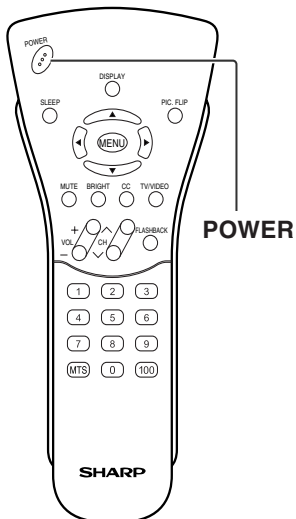

### To turn off the LCD TV

Press **POWER** on the remote control. The **POWER** indicator will turn red.

### To turn the LCD TV back on

Press **POWER** again. The **POWER** indicator will turn green.

# BASIC OPERATION (Continued)

## Changing the Channels

Changing channels by using **Channel Select** on the remote control

- This LCD TV set allows you to select up to 125 channels (1 to 125). To select a channel, enter a 2- or 3-digit number.

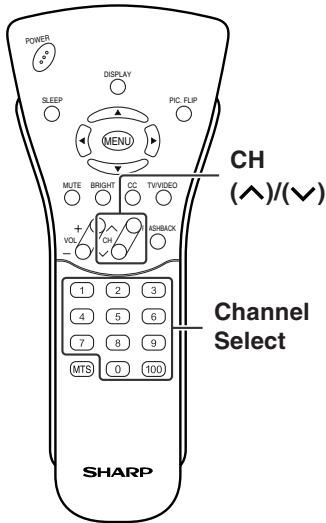

### To select a 1- or 2-digit channel number (e.g., Channel 5):

Complete the following procedure within 4 seconds.

- 1 Press the **⓪** button.
- 2 Press the **⑤** button.

#### NOTE

- When selecting a 1-digit channel number, do not fail to press the **⓪** button first.

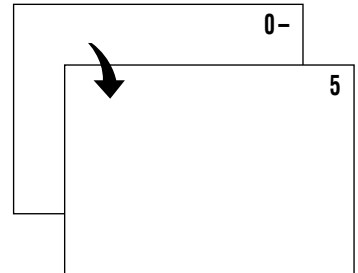

### To select a 3-digit channel number (e.g., Channel 115):

Complete the following procedure within 4 seconds.

- 1 Press the **⓪⓪** button.
- 2 Press the **⓪** button.
- 3 Press the **⑤** button.

#### NOTE

- The 3-digit channel number can be selected only when the receiving mode is set to CABLE in CH-SETTING. (For details on setting the receiving mode, see page 27.)

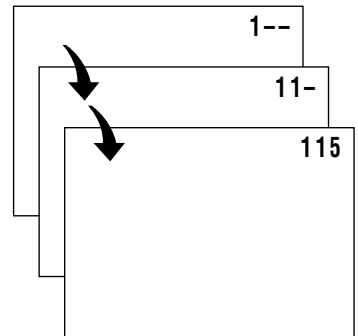

### Changing channels with CH (^)/(v) on the remote control

**Air** Press **CH (^)** and the channels change in the order shown below:

2 → 3 → ... → 68 → 69 → 2 → 3 → ...

Press **CH (v)** and the channels change in the order shown below:

3 → 2 → 69 → 68 → ... → 3 → 2 → ...

**Cable** Press **CH (^)** and the channels change in the order shown below:

1 → 2 → 3 → ... → 125 → 1 → 2 → 3 → ...

Press **CH (v)** and the channels change in the order shown below:

3 → 2 → 1 → 125 → ... → 3 → 2 → 1 → ...

# SELECTING MENU ITEMS

## Selecting Menu Items

- This LCD TV set allows you to adjust the various settings using the menu screen. Select the desired menu item by following the steps below and then refer to the indicated page for details.

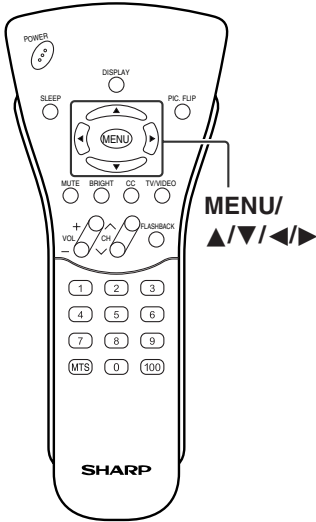

- 1 Press **MENU** to display the MENU screen.
- 2 Press **▲/▼** to select the desired menu item.
- 3 Press **◀/▶** to enter.
- 4 Press **MENU** to exit.

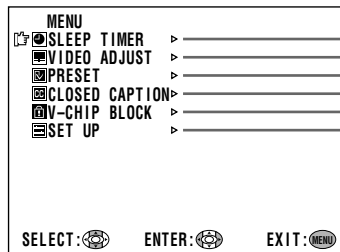

(Page 20)

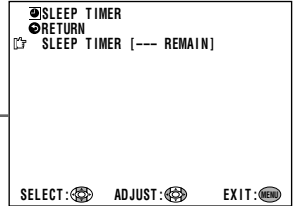

(Pages 24, 25)

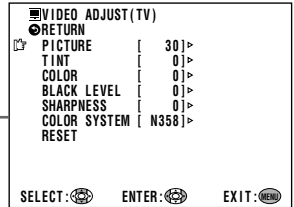

(Pages 21, 22 and 26)

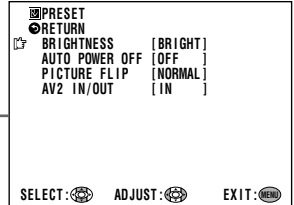

(Page 31)

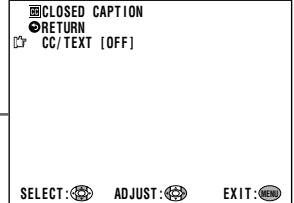

(Pages 34–37)



(Pages 23, 27–29)

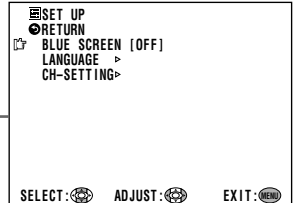

### NOTE

- The TINT display only appears when the color system is set to N358 or N443.
- The displayed items differ depending on the setting conditions.
- The selected item changes to yellow.
- Items in magenta cannot be selected.
- This product is factory set to comply with the color system in the United States (NTSC-N358). For Brazil (PAL-M), Argentina (PAL-N) and Uruguay (PAL-N), set the color system before using this product.
- To return to the previous screen, select RETURN.
- You can adjust some settings with the special buttons: CC, PIC. FLIP, SLEEP and BRIGHT (see pages 20, 21, 22 and 30).

\* The screen indications shown above are larger than actual for easy reading.

# ADJUSTMENT

## Adjusting the SLEEP TIMER Settings

You can set the SLEEP TIMER to automatically turn off the TV.

### Directly setting the SLEEP TIMER

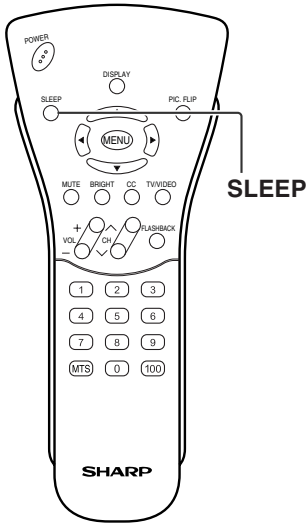

- 1 Press **SLEEP** to display the SLEEP TIMER screen.

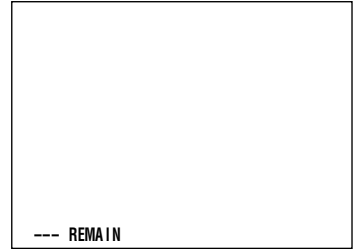

- 2 Press **SLEEP** to set the sleep timer (in minutes).

The time can be set in increments of 30 minutes and in the range between 30 and 120 minutes.

The SLEEP TIMER is turned off when --- is displayed.



#### NOTE

- The SLEEP TIMER screen automatically disappears in 3 seconds.

### Setting the SLEEP TIMER on the MENU screen

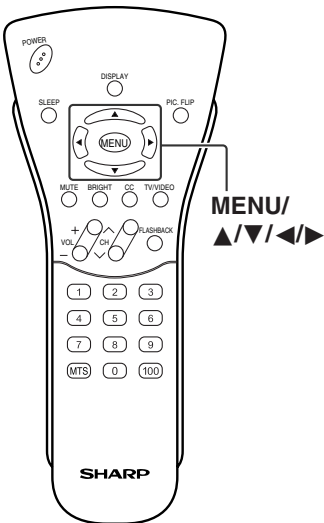

- 1 Press **MENU** to display the MENU screen.

- 2 Press **▲/▼** to move the cursor to SLEEP TIMER.

- 3 Press **◀/▶** to display the SLEEP TIMER screen.

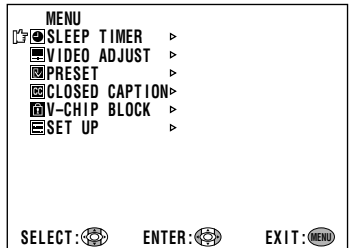

- 4 Press **◀/▶** to set the sleep timer (in minutes).

The time can be set in increments of 30 minutes and in the range between 30 and 120 minutes.

The SLEEP TIMER is turned off when --- is displayed.

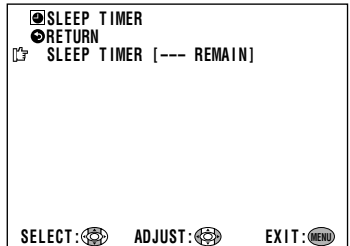

- 5 Press **MENU** to return to the main screen.

#### NOTE

- When you set the SLEEP TIMER, the SLEEP indicator lights.
- After you set the SLEEP TIMER, if you turn off the **MAIN POWER** on the TV set or press the **POWER** button on the remote control, the SLEEP TIMER setting is cancelled and the SLEEP indicator goes out.
- 5 minutes before the SLEEP TIMER turns off the TV, 5 REMAIN is displayed on the screen for 4 seconds. The SLEEP TIMER counts down and shows a similar 4-second display for each remaining minute until the timer turns off the TV.

# ADJUSTMENT (Continued)

## Adjusting the BRIGHTNESS Settings

You can set the brightness of the screen.

### Directly setting the BRIGHTNESS

- 1 Press **BRIGHT** to display the BRIGHTNESS screen.
- 2 Press **BRIGHT** to change the setting.

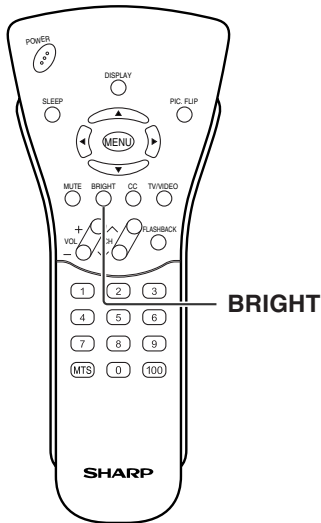
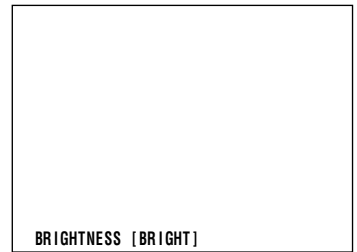

### NOTE

- The BRIGHTNESS screen automatically disappears in 3 seconds.
- [BRIGHT]: maximum brightness  
[NORMAL]: 60% brightness (suitable for viewing in a well-lit area and saves energy)  
[DARK]: 10% brightness (sufficiently bright when viewing in a dimly lit area)

### Setting the BRIGHTNESS on the MENU screen

- 1 Press **MENU** to display the MENU screen.
- 2 Press **▲/▼** to move the cursor to PRESET.
- 3 Press **◀/▶** to enter.

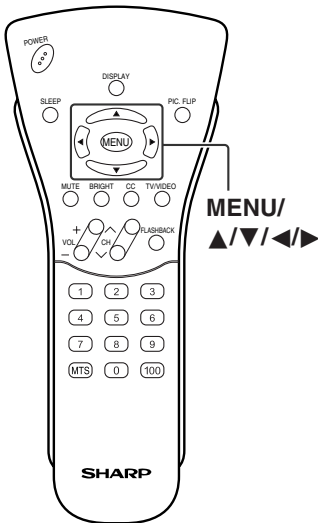
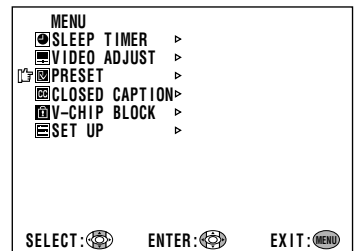

- 4 Press **▲/▼** to move the cursor to BRIGHTNESS.
- 5 Press **◀/▶** to set the brightness.
- 6 Press **MENU** to return to the main screen.

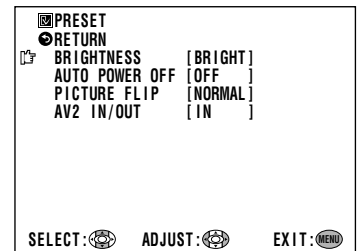

# ADJUSTMENT (Continued)

## Adjusting the PICTURE FLIP Settings

You can set the orientation of the picture.

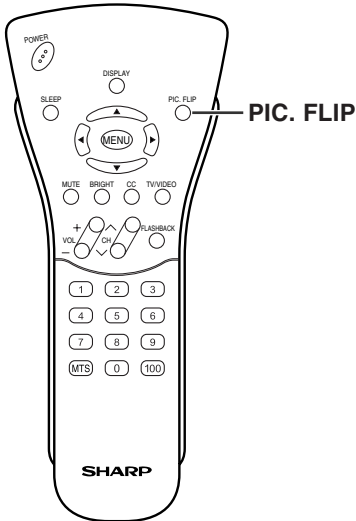

### Directly setting the PICTURE FLIP

- 1 Press **PIC. FLIP** to display the PICTURE FLIP screen.
- 2 Press **PIC. FLIP** to change the setting.



#### NOTE

- The PICTURE FLIP screen automatically disappears in 3 seconds.
- [NORMAL]: normal image
- [MIRROR]: mirror image
- [ROTATE]: rotated image
- [UPSIDE DOWN]: upside down image

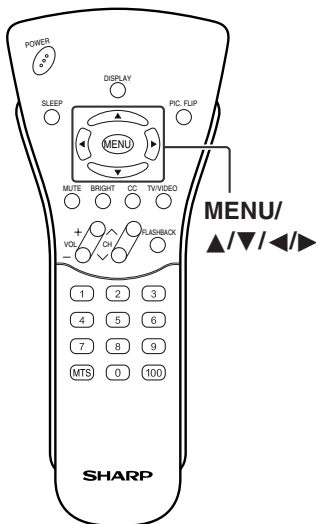
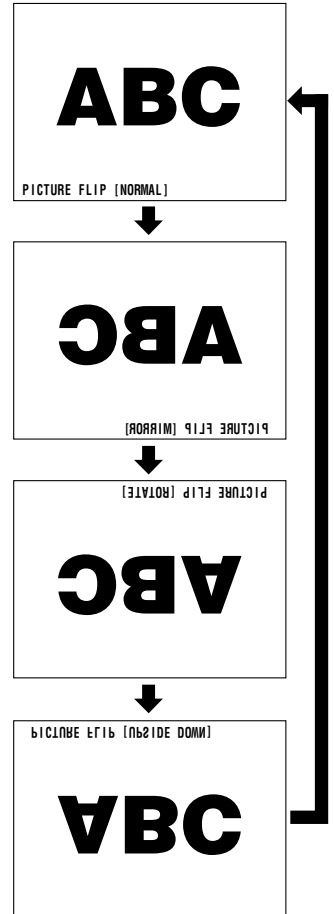

### Setting the PICTURE FLIP on the MENU screen

- 1 Press **MENU** to display the MENU screen.
- 2 Press **▲/▼** to move the cursor to PRESET.
- 3 Press **◀▶** to enter.
- 4 Press **▲/▼** to move the cursor to PICTURE FLIP.
- 5 Press **◀▶** to set the PICTURE FLIP.
- 6 Press **MENU** to return to the main screen.

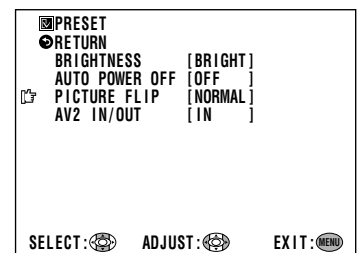
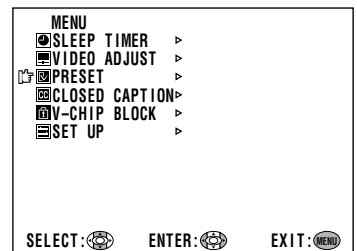

# ADJUSTMENT (Continued)

## Adjusting the LANGUAGE Settings

The language for the On-Screen Display can be ENGLISH, SPANISH or FRENCH.

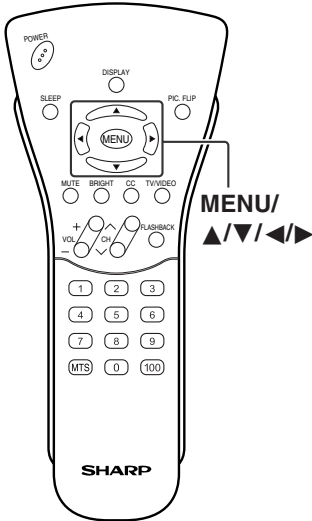

- 1 Press **MENU** to display the MENU screen.

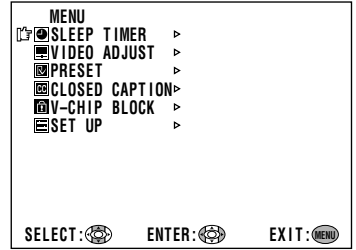

- 2 Press **▲/▼** to move the cursor to SET UP.

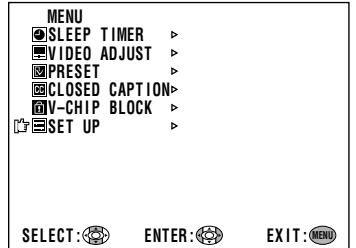

- 3 Press **◀▶** to enter.

- 4 Press **▲/▼** to move the cursor to LANGUAGE.

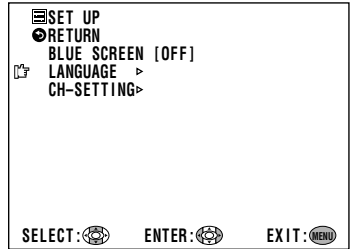

- 5 Press **◀▶** to enter.

- 6 Press **▲/▼** to select the language.

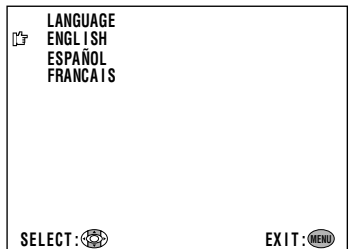

- 7 Press **MENU** to return to the main screen.



# ADJUSTMENT (Continued)

## Adjusting the VIDEO ADJUST Settings

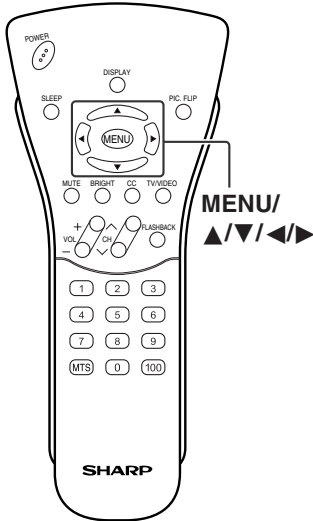

1 Press **MENU** to display the MENU screen.

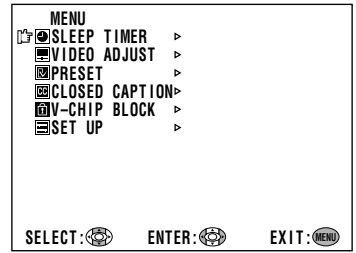

2 Press **▲/▼** to move the cursor to VIDEO ADJUST.

3 Press **◀/▶** to enter.

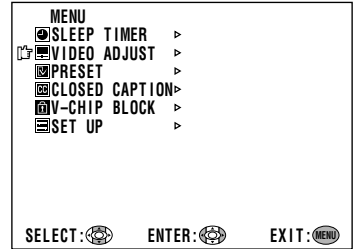

4 Press **▲/▼** to move the cursor to the desired item.

5 Press **◀/▶** to enter.

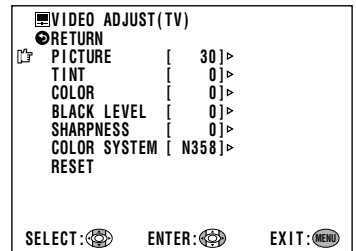

6 Press **◀/▶** to change the setting.

### NOTE

- See page 25 for the settings.

7 Press **MENU** to return to the main screen.

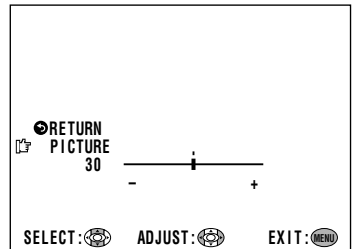

# ADJUSTMENT (Continued)

## Adjusting the VIDEO ADJUST Settings (Continued)

### TV mode

Selected item	Press ◀		Press ▶
PICTURE	Decrease contrast		Increase contrast
TINT	Toward purple		Toward green
COLOR	Lower color intensity		Higher color intensity
BLACK LEVEL	Less brightness		More brightness
SHARPNESS	Soft picture		Sharp picture
COLOR SYSTEM	◁ N358 ↔ PAL-M ↔ PAL-N ▷		

### AV mode

Selected item	Press ◀		Press ▶
PICTURE	Decrease contrast		Increase contrast
TINT	Toward purple		Toward green
COLOR	Lower color intensity		Higher color intensity
BLACK LEVEL	Less brightness		More brightness
SHARPNESS	Soft picture		Sharp picture
RED-BLUE	Stronger red		Stronger blue
GREEN	Weaker green		Stronger green
COLOR SYSTEM	Press ◀/▶ to select the COLOR SYSTEM. ▷ N358 ↔ N443 ↔ PAL ↔ PAL-M ↔ PAL-N ↔ SECAM ↔ PAL60 ◁  ■ When the COMPONENT mode is selected: ▷ NTSC ↔ PAL ◁		

#### NOTE

- TINT is displayed only when N358 or N443 is selected.
- In BLUE SCREEN, VIDEO ADJUST settings displayed in magenta cannot be selected.
- Selecting RESET will return all settings to the factory settings. (See page 24.)
- TV mode
  - This product is factory set to comply with the color system in the United States (NTSC-N358). For Brazil (PAL-M), Argentina (PAL-N) or Uruguay (PAL-N), adjust the color system before using this product.

# ADJUSTMENT (Continued)

## Adjusting the PRESET Settings

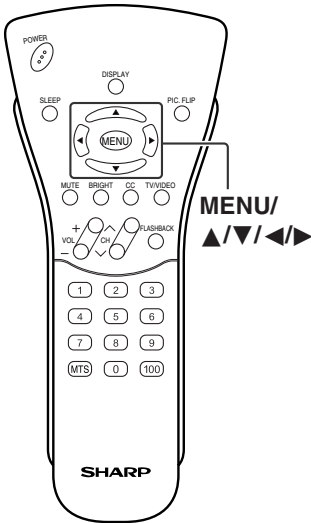

1 Press **MENU** to display the MENU screen.

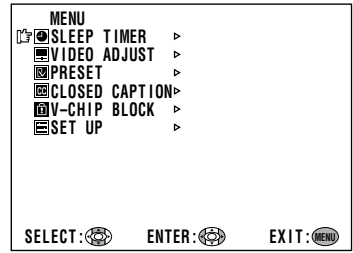

2 Press **▲/▼** to move the cursor to PRESET.

3 Press **◀/▶** to enter.

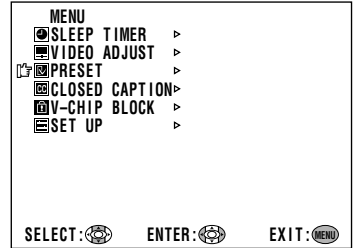





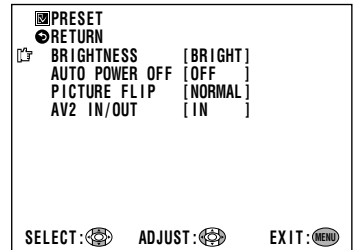

4 Press **▲/▼** to move the cursor to the desired item.

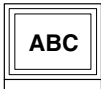
5 Press **◀/▶** to change the setting.



6 Press **MENU** to return to the main screen.

Selected item	Factory setting	Setting options
BRIGHTNESS	[BRIGHT] Maximum brightness	[NORMAL] Brightness 60% → Suitable for viewing in a well-lit area. Saves energy. [DARK] Brightness 10% → Sufficiently bright when viewing in a dimly lit area.
AUTO POWER OFF (only TV mode)	[OFF]	[ON] The power of the LCD TV set is turned off when there is no signal for 5 minutes. [OFF] This feature is inactive.
PICTURE FLIP	[NORMAL] Normal image orientation 	[MIRROR] Mirror image → To display mirror images for special uses.  [ROTATE] Rotated image → To display rotated images for special uses.  [UPSIDE DOWN] Upside down image → To display images upside down for special uses. 
AV2 IN/OUT	[IN]	[OUT  ] Line Output is selected, Output volume is fixed, Speaker output is available. [OUT  ] Line Output is selected, Output volume is variable, Speaker output is Mute.

# ADJUSTMENT (Continued)

## SET UP

### ■ CHANNEL SETTING

It is necessary to set the receiving mode to AIR or CABLE channels to receive locally broadcast TV programs.

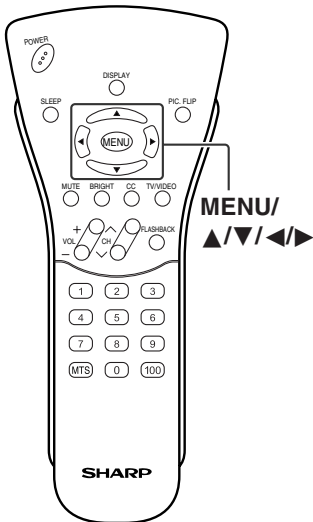

**1** Press **MENU** to display the MENU screen.

**2** Press **▲/▼** to move the cursor to SET UP.

**3** Press **◀▶** to enter.

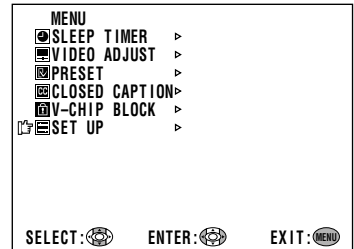

**4** Press **▲/▼** to move the cursor to CH-SETTING.

**5** Press **◀▶** to enter.

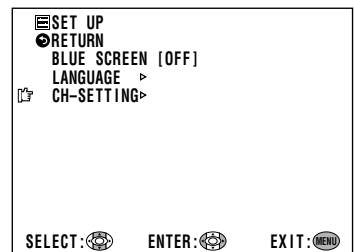

**6** Press **▲/▼** to move the cursor to AIR/CABLE.

**7** Press **◀▶** to enter.

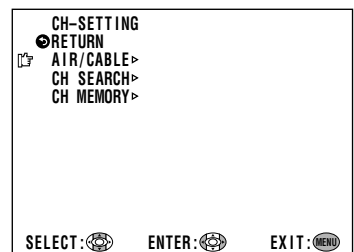

**8** Press **▲/▼** to move the cursor to the desired mode.

**9** Press **MENU** to return to the main screen.

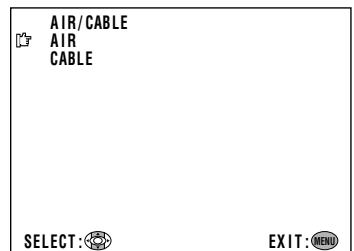

### NOTE

- Receivable channels of your TV set are:

AIR channels:  
VHF: 2 through 13.  
UHF: 14 through 69.

CABLE channels:  
1 (HRC and IRC mode only)  
2 through 125 (STD, HRC and IRC)

# ADJUSTMENT (Continued)

## SET UP (Continued)

### ■ Saving broadcast TV channels in the memory

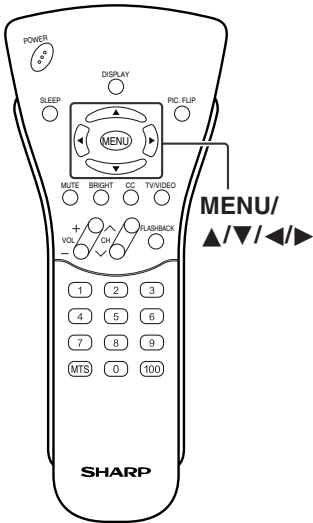

- 1 Press **MENU** to display the MENU screen, press **▲/▼** to move the cursor to SET UP, and press **◀/▶** to enter.
- 2 Press **▲/▼** to move the cursor to CH-SETTING, and press **◀/▶** to enter.
- 3 Press **▲/▼** to move the cursor to CH SEARCH, and press **◀/▶** to enter.
- 4 Press **▶**. The tuner will search through all available channels in your area and add them to the TV's memory.

**NOTE**

- To interrupt CH SEARCH, press **◀**. CH SEARCH will stop at the current channel and will not add any higher channels.

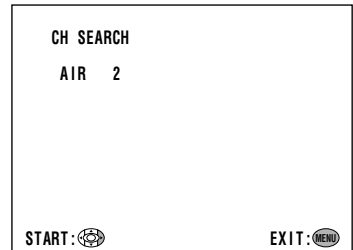

- 5 Press **MENU** to exit.

### ■ Adding weak or additional channels or erasing unwanted channels from TV memory

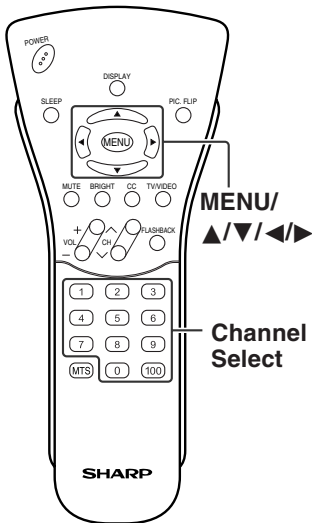

- 1 Press **MENU** to display the MENU screen, press **▲/▼** to move the cursor to SET UP, and press **◀/▶** to enter.
- 2 Press **▲/▼** to move the cursor to CH-SETTING, and press **◀/▶** to enter.
- 3 Press **▲/▼** to move the cursor to CH MEMORY, and press **◀/▶** to enter.
- 4 Use **▲/▼** or **Channel Select** to select each desired channel to add or erase.
- 5 Press **▶** to add the channel to the TV's memory or press **◀** to erase the channel from the TV's memory.
- 6 Press **MENU** to exit.

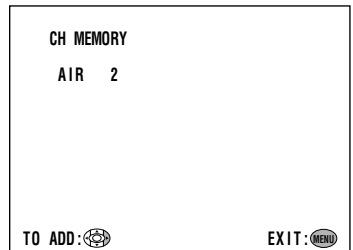
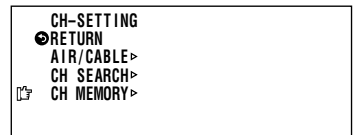

▶ to add channel 2 to the TV memory
◀ to erase channel 2 from the TV memory

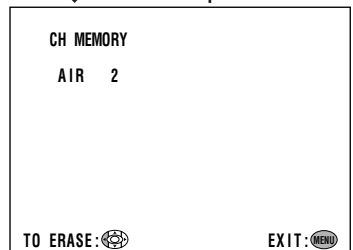

**NOTE**

- If CH SEARCH is performed again, the previously memorized channels will be lost.

# ADJUSTMENT (Continued)

## Adjusting the BLUE SCREEN Settings

### ■ BLUE SCREEN

Automatically turns the screen blue if a broadcast signal is not received.

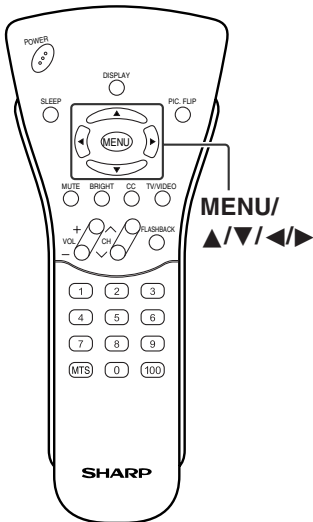

**1** Press **MENU** to display the MENU screen.

**2** Press **▲/▼** to move the cursor to SET UP.

**3** Press **◀/▶** to enter.

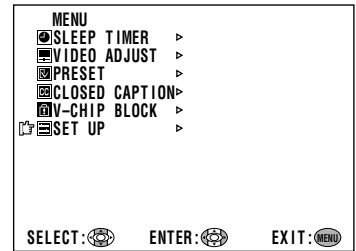

**4** Press **▲/▼** to move the cursor to BLUE SCREEN.

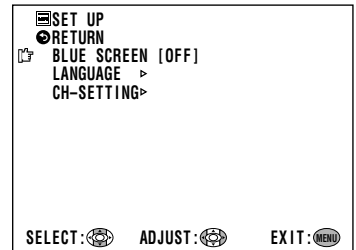

**5** Press **◀/▶** to select ON or OFF.

**6** Press **MENU** to return to the main screen.

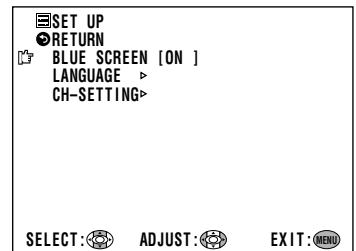

### NOTE

- When received signals are weak or interfered with by some other signals, the BLUE SCREEN function may be activated. To watch the TV under such conditions, set BLUE SCREEN to OFF.
- When the AV-1, AV-2 or COMPONENT input mode is selected, if no signal is being input, the BLUE SCREEN function is activated.

# ADJUSTMENT (Continued)

## Adjusting the CLOSED CAPTION Settings

### ■ SETTING CLOSED CAPTION

- This TV set is equipped with an internal Closed Caption decoder. "Closed Caption" is a system which allows conversations, narration, and sound effects in TV programs and home videos to be viewed as captions on the TV screen (see the illustration).
- Not all programs and videos will offer closed captioning. Please look for the "CC" symbol to ensure that captions will be shown.
- The Closed Caption broadcasts can be viewed in two modes: CAPTION and TEXT. For each mode, two channels are available: CH1 and CH2. The CAPTION mode shows subtitles of dialogs and commentaries of TV dramas and news programs while allowing a clear view of the picture. The TEXT mode displays various information over the picture (such as TV program schedules and weather forecasts, etc.) that is independent of the TV programs.



### Directly setting the CLOSED CAPTION

**1** Press **CC** to display the **CC/TEXT** screen.

**2** Press **CC** to change the setting.

→ OFF → CC 1 → CC 2 → T1 → T2 →

#### NOTE

- **CC1**: CAPTION mode for CH1 data
- **CC2**: CAPTION mode for CH2 data
- **T1**: TEXT mode for CH1 data
- **T2**: TEXT mode for CH2 data

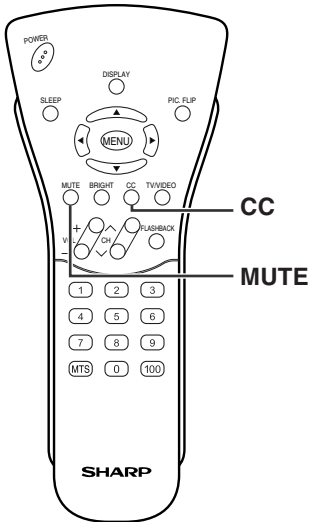
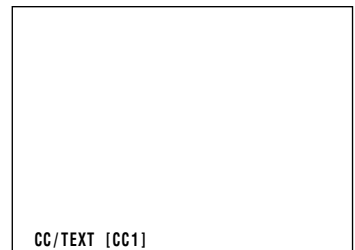

#### NOTE

- If a broadcast has CLOSED CAPTION and **MUTE** is pressed, the set enters CAPTION mode automatically. Pressing **MUTE** again will return the set to its previous condition.
- Closed Caption may malfunction (white blocks, strange characters, etc.) if signal conditions are poor or if there are problems at the broadcast source. This does not necessarily indicate a problem with your set.
- If any button is pressed to call up the On-Screen Display while viewing a Closed Caption broadcast, the closed captions will disappear momentarily.
- If no TEXT broadcast is being received while viewing in the TEXT mode, the screen may become dark and blank for some programs. Should this occur, switch the Closed Caption mode to OFF.

# ADJUSTMENT (Continued)

## Adjusting the CLOSED CAPTION Settings (Continued)

### ■ SETTING CLOSED CAPTION

Setting the CLOSED CAPTION on the MENU screen

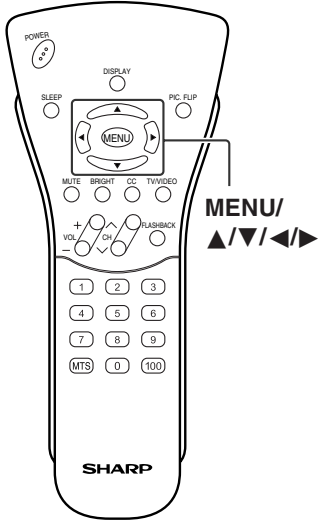

- 1 Press **MENU** to display the MENU screen.
- 2 Press **▲/▼** to move the cursor to CLOSED CAPTION.

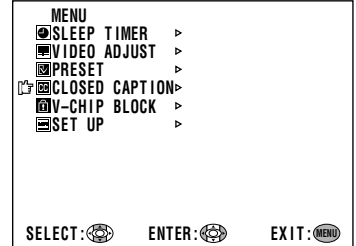

- 3 Press **◀/▶** to enter.
- 4 Press **▲/▼** to move the cursor to CC/TEXT.

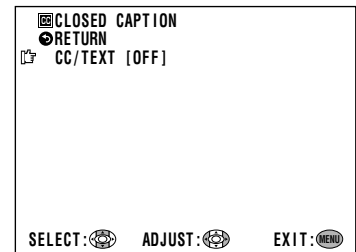

- 5 Press **◀/▶** to change the CLOSED CAPTION setting.

→ OFF → CC 1 → CC 2 → T1 → T2 →

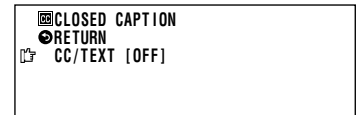

- 6 Press **MENU** to return to the main screen.



# ADJUSTMENT (Continued)

## Adjusting the V-CHIP Settings

### ■ V-CHIP

- This function allows TV programs to be restricted and TV usage to be controlled based on FCC data. It prevents children from watching violent or sexual scenes that may be harmful.
- Restriction of TV programs includes two ratings that contain information about the program: the MPAA rating and the TV Parental Guidelines. The MPAA rating is restricted by age. TV Parental Guidelines are restricted by age and content.
- Since a TV program may use either the MPAA rating or the TV Guidelines, both should be adjusted for complete control.

### [1] MPAA RATING

RATING		
age base	G	GENERAL AUDIENCES. All ages admitted.
	PG	PARENTAL GUIDANCE SUGGESTED. Some material may not be suitable for children.
	PG-13	PARENTS STRONGLY CAUTIONED. Some material may be inappropriate for children under 13.
	R	RESTRICTED. Under 17 requires accompanying parent or adult guardian.
	NC-17	NO ONE 17 AND UNDER ADMITTED.
	X	X is an older rating that is unified with NC-17 but may be encoded in the data of older movies.

### MPAA RATING (examples)

#### Example 1:

PG-13 in the age-based rating is blocked, this will also automatically block the higher ratings R, NC-17 and X.

#### 1. User setting

G	----
PG	----
PG-13	BLOCK
R	BLOCK
NC-17	BLOCK
X	BLOCK

#### 2. Block table

G	not to block
PG	not to block
PG-13	Select block
R	auto-block
NC-17	auto-block
X	auto-block

↑ age base ↓

#### Example 2:

R in the age-based rating is blocked, this will also automatically block the higher ratings NC-17 and X.

#### 1. User setting

G	----
PG	----
PG-13	----
R	BLOCK
NC-17	BLOCK
X	BLOCK

#### 2. Block table

G	not to block
PG	not to block
PG-13	not to block
R	Select block
NC-17	auto-block
X	auto-block

↑ age base ↓

### NOTE

- The MPAA rating is only age-based.

# ADJUSTMENT (Continued)

## Adjusting the V-CHIP Settings (Continued)

### [2] TV PARENTAL GUIDELINES

RATING		← content base →				
		FV (Fantasy Violence)	V (Violence)	S (Sexual Situation)	L (Adult Language)	D (Sexually Suggestive Dialog)
↑ age base ↓	TV-Y (All children)	☒	☒	☒	☒	☒
	TV-Y7 (Direct to Older Children)	×	☒	☒	☒	☒
	TV-G (General Audience)		☒	☒	☒	☒
	TV-PG (Parental Guidance Suggested)		×	×	×	×
	TV-14 (Parents Strongly Cautioned)		×	×	×	×
	TV-MA (Mature Audience Only)		×	×	×	

☒: The content rating can be set, but this rating is not normally broadcast by TV stations.  
 X: The content rating can be set.

### TV PARENTAL GUIDELINES (examples)

#### Example 1:

When TV-Y7 in the age-based rating is set to BLOCK, this will automatically block the higher ratings: TV-G, TV-PG, TV-14 and TV-MA. In addition, D, L, S, V and FV in CONTENT are automatically blocked unless you manually set BLOCK CONTENT.

#### 1. User setting

TV-Y	----
TV-Y7	BLOCK
TV-G	BLOCK
TV-PG	BLOCK
TV-14	BLOCK
TV-MA	BLOCK

BLOCK CONTENT (D L S V FV)

#### 2. Block table

		content base				
		FV	V	S	L	D
↑ age base ↓	TV-Y					
	TV-Y7	■	■	■	■	■
	TV-G	■	■	■	■	■
	TV-PG	■	■	■	■	■
	TV-14	■	■	■	■	■
	TV-MA	■	■	■	■	■

■ TV-Y7 Select block    ■ auto-block

#### Example 2:

When no item in the age-based rating is blocked, D in the content-based rating will be automatically blocked.

#### 1. User setting

TV-Y	----
TV-Y7	----
TV-G	----
TV-PG	----
TV-14	----
TV-MA	----

BLOCK CONTENT (D )

#### 2. Block table

		content base				
		FV	V	S	L	D
↑ age base ↓	TV-Y					
	TV-Y7					
	TV-G					
	TV-PG					■
	TV-14					■
	TV-MA					■

■ auto-block

### NOTE

- Age-based ratings can be modified by the content-based ratings, but only in the combinations indicated by an X in the table above.
- Choosing a lower age-based rating blocks the higher age-based ratings regardless of content rating settings.
- If you set TV-Y and TV-Y7 to BLOCK, CONTENT will display all items.

# ADJUSTMENT (Continued)

## Adjusting the V-CHIP Settings (Continued)

### ■ SETTING V-CHIP

#### [1] MPAA RATING

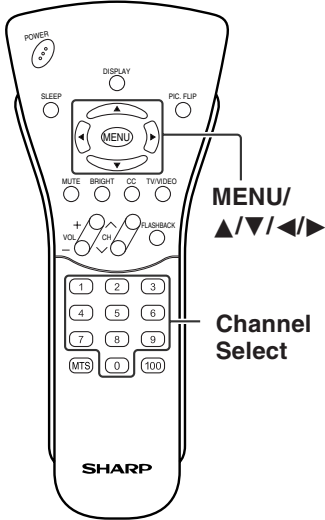

**1** Press **MENU** to display the MENU screen.

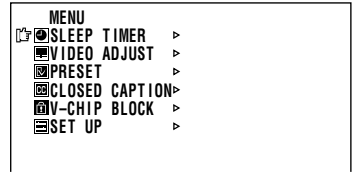

**2** Press ▲/▼ to move the cursor to V-CHIP BLOCK, and press ◀/▶ to enter.

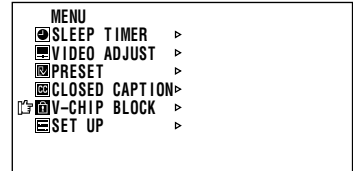

**3** INPUT SECRET NO. will display. Input the 4-digit secret number by using **Channel Select**.

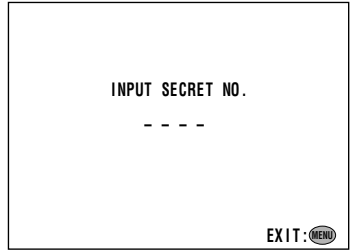

**NOTE** ▶

- When you input the secret number for the first time, press **MENU** to register. Otherwise, continue to step 4.

**4** Press ◀/▶ to move the cursor to MPAA, and press ◀/▶ to enter.

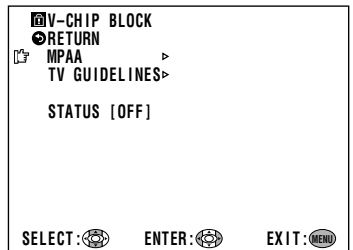

**5** Press ▲/▼ to move the cursor to PG, and then press ◀/▶ to select BLOCK. If you set PG to BLOCK, PG-13, R, NC-17 and X are automatically blocked.

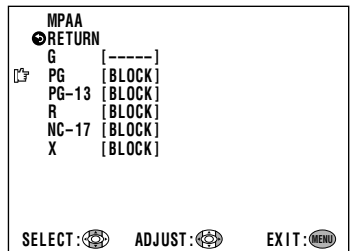

**6** Press **MENU** to return to the main screen.

**NOTE** ▶

- If you set G to BLOCK, all ratings are automatically blocked.
- If you set X to BLOCK, G, PG, PG-13, R and NC-17 are not blocked.

# ADJUSTMENT (Continued)

## Adjusting the V-CHIP Settings (Continued)

### [2] TV GUIDELINES

#### ● Setting TV GUIDELINES

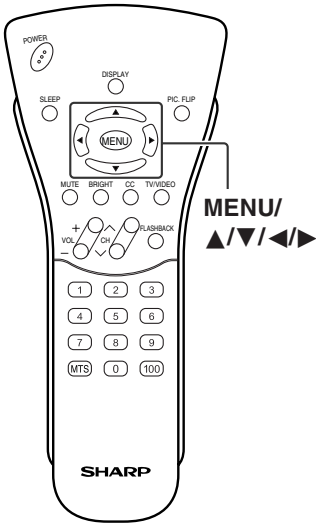

- 1 Repeat steps 1 to 3 of [1] **MPAA RATING**. (See page 34.)
- 2 Press ▲/▼ to move the cursor to TV GUIDELINES.
- 3 Press ◀/▶ to enter.

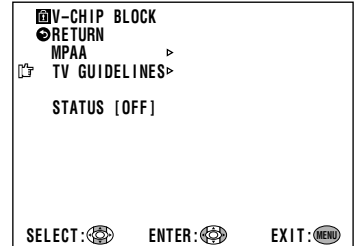

- 4 Press ▲/▼ to move the cursor to TV-Y7, and press ◀/▶ to select BLOCK. If you set TV-Y7 to BLOCK, TV-G, TV-PG, TV-14 and TV-MA are automatically blocked. In addition, D, L, S, V and FV in CONTENT are automatically blocked.

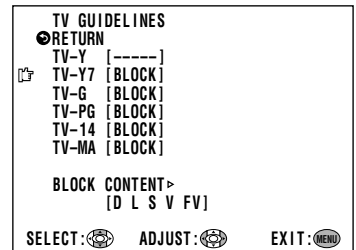

- 5 Press **MENU** to return to the main screen.

#### ● Setting BLOCK CONTENT

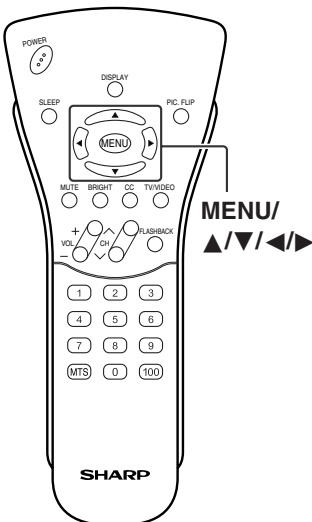

- 1 Press ▲/▼ to move the cursor to BLOCK CONTENT, and press ◀/▶ to enter.

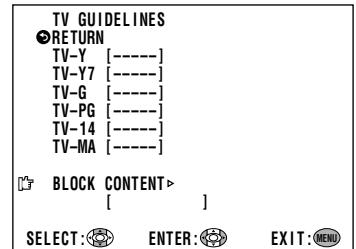

- 2 Press ▲/▼ to move the cursor to the desired item, and press ◀/▶ to select BLOCK or ----- (unblock).

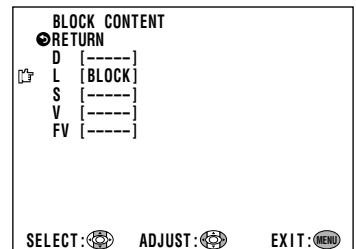

- 3 Press **MENU** to return to the main screen.

#### NOTE

- If you set TV-14 to BLOCK, TV-MA is automatically blocked. Contents D, L, S and V are automatically blocked by X in the table on page 33.

# ADJUSTMENT (Continued)

## Adjusting the V-CHIP Settings (Continued)

### [3] ACTIVATING V-CHIP BLOCK

#### ● Setting STATUS

You can activate V-CHIP BLOCK after setting [1] **MPAA RATING** and/or [2] **TV GUIDELINES**.

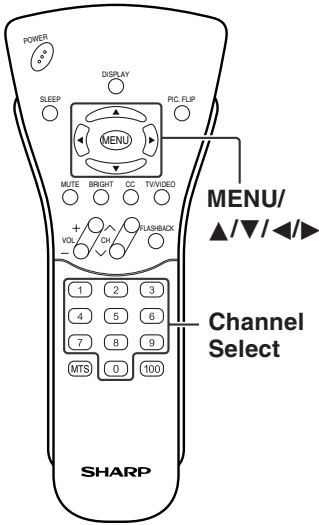

- 1 Repeat steps 1 to 3 of [1] **MPAA RATING**.
- 2 Press ▲/▼ to move the cursor to STATUS.
- 3 Press ◀/▶ to set STATUS to ON.

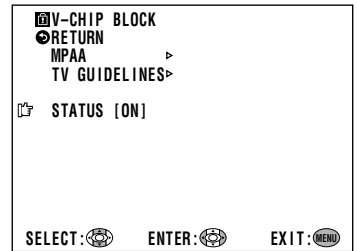

#### NOTE

- If STATUS is set to OFF, V-CHIP BLOCK will not be activated.

- 4 Press **MENU** to return to the main screen.

### [4] CANCELING THE V-CHIP BLOCK SCREEN WHILE V-CHIP BLOCK IS ACTIVATED

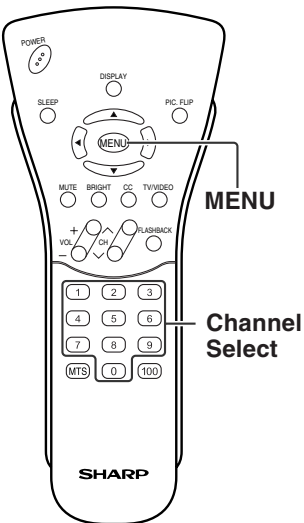

- 1 V-CHIP HAS BEEN ACTIVATED appears if you watch a program with the same Program Rating data you configured.

#### NOTE

- V-CHIP HAS BEEN ACTIVATED will not be displayed if STATUS is not configured to ON.

- 2 Press **MENU** to display INPUT SECRET NO.
- 3 Input the 4-digit secret number by using **Channel Select**; V-CHIP BLOCK is temporarily canceled. If you input an incorrect secret number, SECRET NO. IS INCORRECT is displayed. In this case, input the correct secret number.

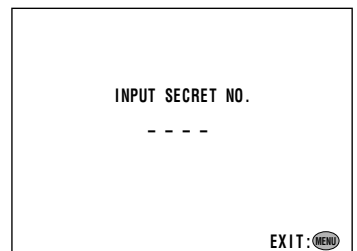

#### NOTE

- If you turn the power on from off, V-CHIP BLOCK will be activated again.
- If you select V-CHIP BLOCK again by using **MENU**, V-CHIP BLOCK will be turned on again.

# ADJUSTMENT (Continued)

## Adjusting the V-CHIP Settings (Continued)

### [5] CHANGING THE V-CHIP BLOCK SETTINGS

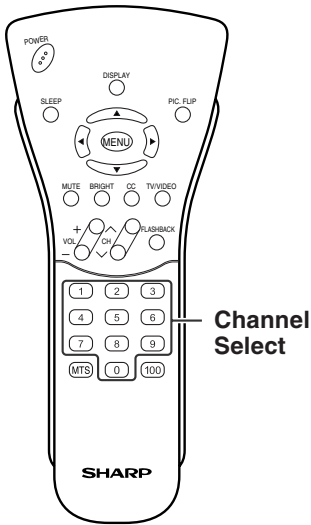

**1** Repeat steps 1 to 2 of [1] **MPAA RATING**, then **INPUT SECRET NO.** will be displayed.

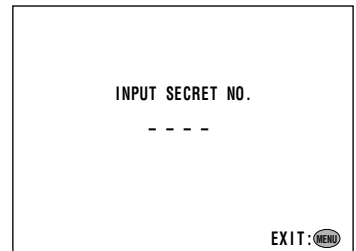

**2** Input the 4-digit secret number by using **Channel Select**; the V-CHIP select mode will be displayed. Set V-CHIP BLOCK again.

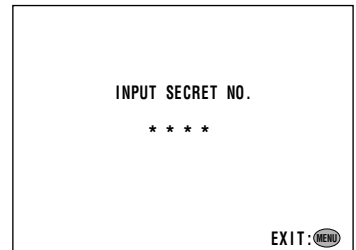

### [6] CHANGING OR CLEARING THE SECRET NUMBER

If you forget the secret number, clear the secret number as follows.

Upper control panel  
of the main unit

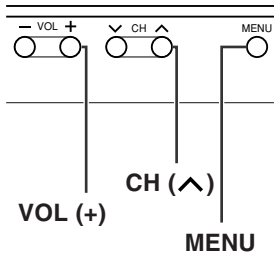

**1** Repeat steps 1 to 2 of [1] **MPAA RATING**, or 1 to 2 of [4] **CANCELING THE V-CHIP BLOCK SCREEN WHILE V-CHIP BLOCK IS ACTIVATED**, then **INPUT SECRET NO.** will be displayed.

**2** Press and hold both **CH (^)** and **VOL (+)** on the TV set simultaneously until the message **INPUT SECRET NO.** blinks.

**3** Press **MENU** to exit.

# CONNECTING WITH EXTERNAL DEVICES

You can enjoy picture and sound by connecting a VCR or a home video game system to the terminals located on the rear of the TV set.

When connecting an external device, turn off the power of the main unit first to prevent any possible damage.

## Example of external devices that can be connected

### External devices that can be connected to AV-IN2 terminal

<Example>

- VCR
- Laser disc player



### External devices that can be connected to AV-IN1 terminal

<Example>

- Video camera
- Home video game system

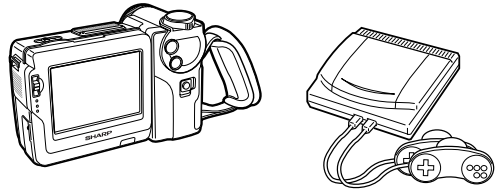

\* If your external device has an S-Video terminal, S-VIDEO connection is recommended.

### External devices that can be connected to COMPONENT terminal

<Example>

- DVD, etc.

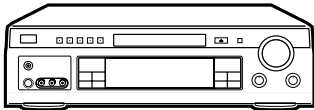

\* If your external device has a component terminal, COMPONENT connection is recommended (you can view high-quality pictures).

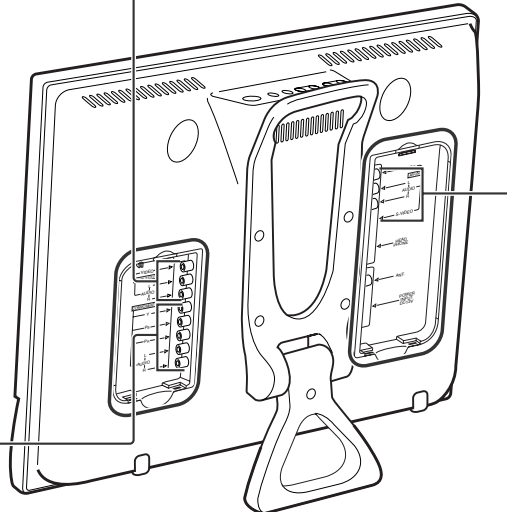

## NOTE

- PC connection is not possible.
- For the cable, use a commercially available audio/video cable.
- Only connect audio/video signals to AV-IN1 and 2 terminals. Connecting other signals may result in a malfunction.
- AV-IN1 has 2 video input terminals: VIDEO and S-VIDEO. When you connect external devices to both terminals (and if you select AV-IN1), you can only view pictures from the S-VIDEO terminal. To view the picture from the VIDEO terminal, do not connect any external device to the S-VIDEO terminal.
- For more information about external device connections, see the manuals of your external devices.

# CONNECTING WITH EXTERNAL DEVICES (Continued)

## Connecting a VCR, DVD player or a video camera (AV-IN1/2/COMPONENT)

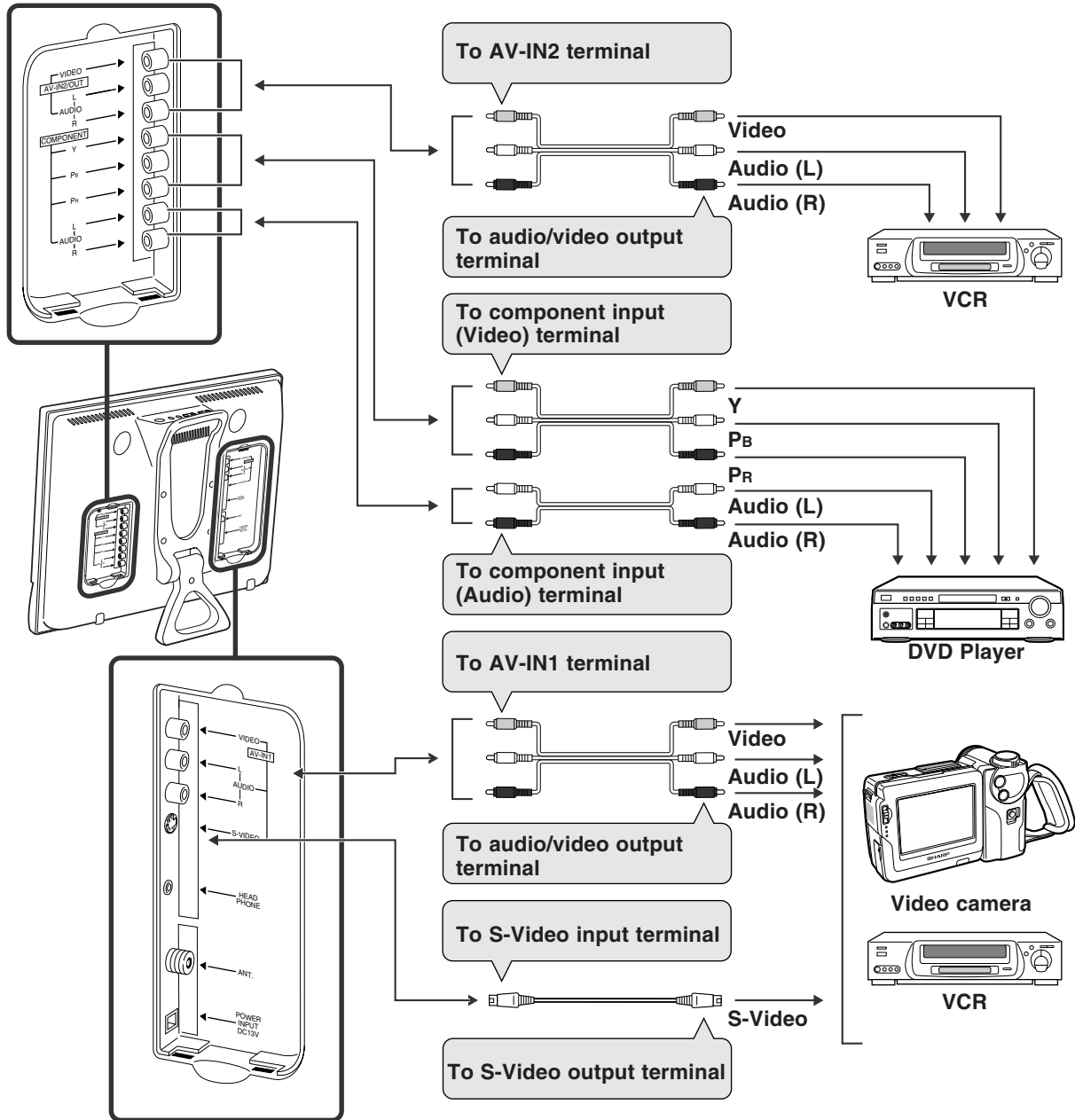

### NOTE

- If your VCR (or other external devices) has an S-Video terminal, S-VIDEO connection is recommended. (Use an S-Video cable.)
- When you connect external devices to both S-VIDEO and VIDEO terminals (and if you select AV-IN1), you can only view pictures from the S-VIDEO terminal.
- You cannot view multiple or synthesized pictures by connecting two or more external devices. When connecting an external device, use care to connect the video and audio cables to the corresponding terminals.
- Do not connect antennas or headphones to AV-IN1.



# CONNECTING WITH EXTERNAL DEVICES (Continued)

## Outputting video and audio (video output)

You can output video and audio data from the TV set through the AV output terminals (AV-OUT).

- When using as an OUTPUT terminal, select PRESET in the MENU and set AV2 IN/OUT to OUT. (See page 26.)
- The factory setting for AV2 IN/OUT is IN.

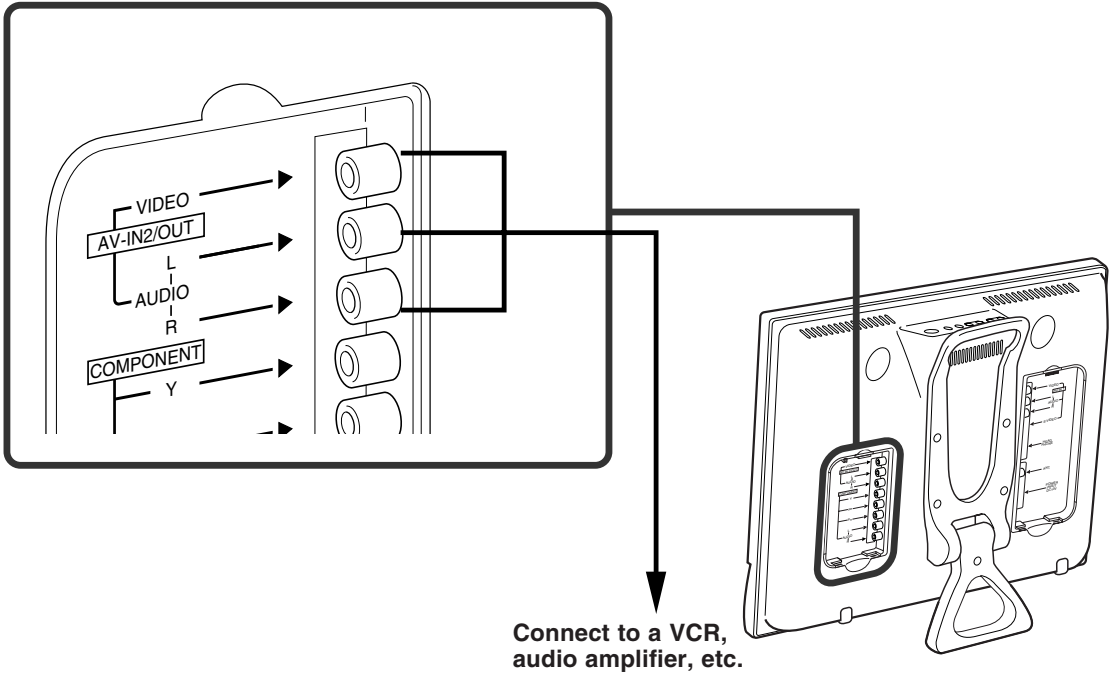

### NOTE

- AV2 has 2 OUT modes (see page 26).
- When using the S-Video input for AV-IN1, no video output will be made to the AV output terminal, but audio output will be made for connection to external audio systems.

## How to fix the cables



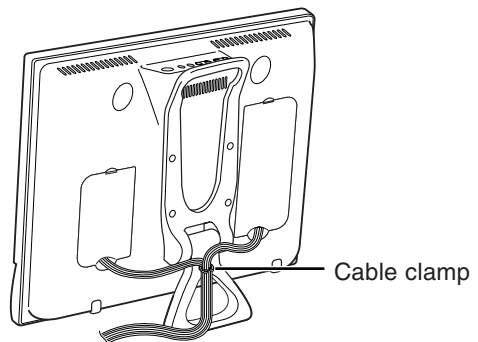

- Fix cables and cords with the attached cable clamp so that they do not get caught when mounting the cover.
- Connect the cables and cords after fixing the cable clamp.



# TROUBLESHOOTING

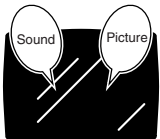
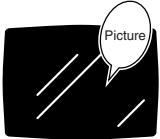

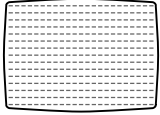
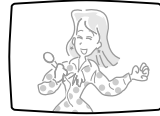

■ Before calling for repair service, check the following items for possible remedies to the encountered symptoms.

## TV set

Problem	Check item	Reference Pages
 <p>There is no picture or sound.</p>	<ul style="list-style-type: none"> <li>• Make sure the AC adapter is properly inserted in the power outlet.</li> <li>• Reception other than those of broadcasting stations can be considered.</li> <li>• Make sure the input mode is set to TV.</li> <li>• Make sure the main power switch of the main unit is on.</li> </ul>	<p>9</p> <p>–</p> <p>16</p> <p>16</p>
 <p>There is no picture. There is no picture from AV-IN1.</p>	<ul style="list-style-type: none"> <li>• Make sure the BLACK LEVEL is properly adjusted.</li> <li>• Fluorescent lamp may have reached the end of service life.</li> <li>• Make sure the S-Video terminal is free of connections.</li> </ul>	<p>24, 25</p> <p>43</p> <p>39</p>
 <p>There is no sound.</p>	<ul style="list-style-type: none"> <li>• Make sure the volume is not set to minimum.</li> <li>• Make sure the sound is not set to mute.</li> <li>• Make sure that headphones are not connected.</li> </ul>	<p>17</p> <p>17</p> <p>13</p>
 <p>There is no picture or sound, just noise.</p>	<ul style="list-style-type: none"> <li>• Make sure the antenna cable is properly connected.</li> <li>• Consider whether TV signals are being properly received.</li> </ul>	<p>9</p> <p>–</p>
 <p>Picture is not clear.</p>	<ul style="list-style-type: none"> <li>• Make sure the antenna cable is properly connected.</li> <li>• Consider whether TV signals are being properly received.</li> </ul>	<p>9</p> <p>–</p>
 <p>Picture is light or improperly tinted.</p>	<ul style="list-style-type: none"> <li>• Check color adjustment.</li> <li>• Check color system setting.</li> </ul>	<p>24, 25</p> <p>24, 25</p>
 <p>The picture is too dark.</p>	<ul style="list-style-type: none"> <li>• Press the BRIGHT button.</li> <li>• Check PICTURE and BLACK LEVEL adjustment.</li> <li>• Fluorescent lamp may have reached the end of service life.</li> </ul>	<p>15</p> <p>24, 25</p> <p>43</p>
<p>Remote control does not work.</p>	<ul style="list-style-type: none"> <li>• Check the batteries of the remote control.</li> <li>• Make sure the remote sensor window is not under strong lighting.</li> </ul>	<p>8</p> <p>8</p>

# TROUBLESHOOTING (Continued)

## Antenna

Problem	Check item
 <p>The picture is not sharp.</p>  <p>The picture moves.</p>	<ul style="list-style-type: none"> <li>• The reception may be weak.</li> <li>• The state of the broadcast may also be bad.</li> <li>• Make sure the antenna is facing the right direction.</li> <li>• Make sure the outside antenna is not disconnected.</li> </ul>
 <p>The picture is doubled or tripled.</p>	<ul style="list-style-type: none"> <li>• Make sure the antenna is facing the right direction.</li> <li>• There may be reflected electric waves from mountains or buildings.</li> </ul>
 <p>The picture is spotted.</p>	<ul style="list-style-type: none"> <li>• There may be interference from automobiles, trains, high voltage lines, neon lights, etc.</li> <li>• There may be interference between the antenna cable and AC cord. Try positioning them further apart.</li> </ul>
 <p>There are stripes on the screen or colors fade.</p>	<ul style="list-style-type: none"> <li>• Is the unit receiving interference from other devices? Transmission antennas of radio broadcasting stations, transmission antennas of amateur radios and cellular phones may also cause interference.</li> <li>• Use the unit as far apart as possible from devices that may cause possible interference.</li> </ul>

### ■ Cautions regarding use in high and low temperature environments

- When the unit is used in a low temperature space (e.g. room, office), the picture may leave trails or appear slightly delayed. This is not a malfunction, and the unit will recover when the temperature returns normal.
  - Do not leave the unit in a hot or cold location. Also, do not leave the unit in a location exposed to direct sunlight or near a heater, as this may cause the cabinet to deform and the LCD panel to malfunction.
- Storage temperature: -4°F to +140°F (-20°C to +60°C)

# SPECIFICATIONS

Items	Model	LC-20E1U
LCD panel		19.7" ASV & BLACK-TFT LCD
Number of dots		921,600 dots VGA
Video color systems		N358, N443, PAL, PAL-M, PAL-N, SECAM, PAL-60
TV function	Destination	USA/Latin A/Twn
	TV Standard (CCIR)	NTSC/PAL-M/PAL-N
	TV Tuning System	PLL 181 ch.
	STEREO	MTS+SAP
	CATV	125 ch.
3 Dimensional Y/C separation circuit		Yes (N358 only)
Digital comb filter		Yes
Brightness		430 cd/m <sup>2</sup>
Lamp life		60,000 hours
Viewing angles		H: 170° V: 170°
Audio amplifier		2.5 W × 2
Speakers		1 <sup>37</sup> / <sub>64</sub> × 2 <sup>3</sup> / <sub>4</sub> in. (4 × 7 cm), 2 pcs.
Terminals	AV1	AV-IN1, S-VIDEO-IN
	AV2	AV-IN2/AV-OUT
	COMPONENT	COMPONENT-IN, AUDIO-IN
	Antenna	F-Type
	Headphone	Mini-jack for stereo (ø 3.5 mm)
OSD language		English/French/Spanish
Power supply		DC 13 V, AC 110–240 V, 50/60 Hz
Weight		15.7 lbs (7.1 kg), w/o accessories
Accessories		Remote control, Batteries, Antenna cable, AC adapter, AC cord, Cable clamp, Operation Manual

As a part of policy of continuous improvement, SHARP reserves the right to make design and specification changes for product improvement without prior notice. The performance specification figures indicated are nominal values of production units. There may be some deviations from these values in individual units.

# DIMENSIONAL DRAWINGS

Unit: inch/(mm)

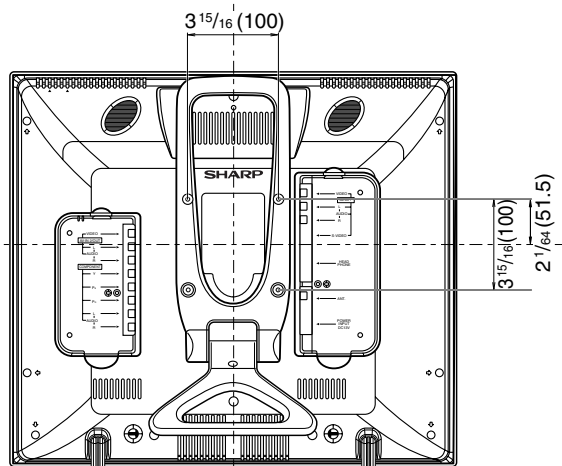
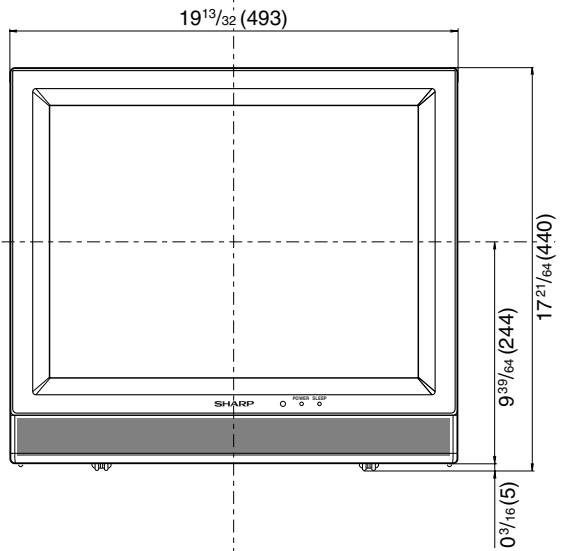
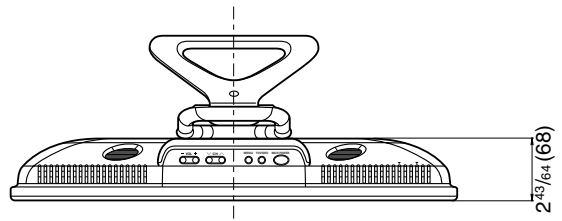
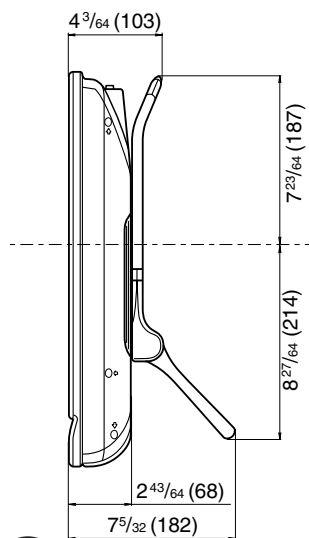
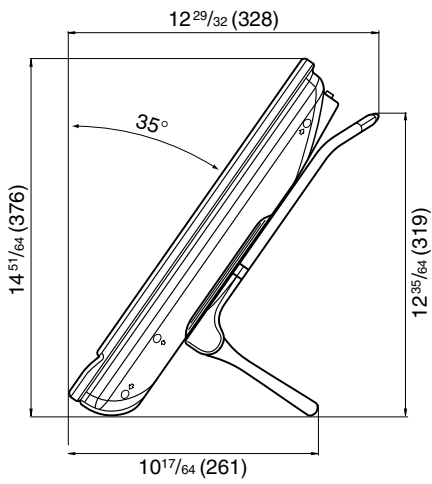
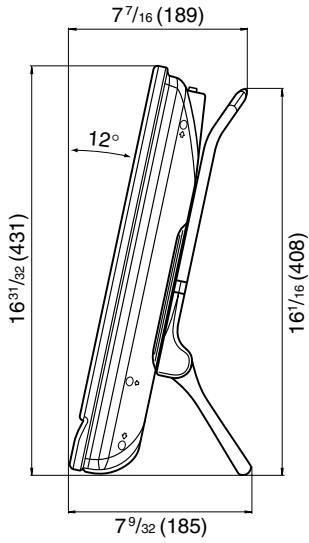

# CALLING FOR SERVICE

For location of the nearest Sharp Authorized Service, or to obtain product literature, accessories, supplies, or customer assistance, please call 1-800-BE-SHARP.

## LIMITED WARRANTY

### END-USER LIMITED WARRANTY

SHARP ELECTRONICS CORPORATION warrants to the first end user purchaser that this Sharp brand product (the "Product"), when shipped in its original container, will be free from defective workmanship and materials, and agrees that it will, at its option, either repair the defect or replace the defective Product or part thereof with a new or remanufactured equivalent at no charge to the purchaser for parts or labor for the period(s) set forth below.

This warranty does not apply to any appearance items of the Product nor to the additional excluded item(s) set forth below nor to any Product the exterior of which has been damaged or defaced, which has been subjected to improper voltage or other misuse, abnormal service or handling, or which has been altered or modified in design or construction.

In order to enforce the rights under this limited warranty, the purchaser should follow the steps set forth below and provide proof of purchase to the servicer.

To the extent permitted by applicable state law, the warranties set forth herein are in lieu of, and exclusive of, all other warranties, express or implied. Specifically, ALL OTHER WARRANTIES OTHER THAN THOSE SET FORTH ABOVE ARE EXCLUDED. ALL EXPRESS AND IMPLIED WARRANTIES INCLUDING THE WARRANTIES OF MERCHANTABILITY, FITNESS FOR USE, AND FITNESS FOR A PARTICULAR PURPOSE ARE SPECIFICALLY EXCLUDED. If, under applicable state law, implied warranties may not validly be disclaimed or excluded, the duration of such implied warranties is limited to the period(s) from the date of purchase set forth below.

Neither the sales personnel of the seller nor any other person is authorized to make any warranties other than those described herein, or to extend the duration of any warranties beyond the time period described herein on behalf of Sharp.

The warranties described herein shall be the sole and exclusive warranties granted by Sharp and shall be the sole and exclusive remedy available to the purchaser. Correction of defects, in the manner and for the period of time described herein, shall constitute complete fulfillment of all liabilities and responsibilities of Sharp to the purchaser with respect to the Product, and shall constitute full satisfaction of all claims, whether based on contract, negligence, strict liability or otherwise. In no event shall Sharp be liable, or in any way responsible, for any damages or defects in the Product which were caused by repairs or attempted repairs performed by anyone other than an authorized servicer. Nor shall Sharp be liable or in any way responsible for any incidental or consequential economic or property damage. Some states do not allow limits on warranties or on remedies for breach in certain transactions; in such states, the limits herein may not apply.

### Model Specific Section

<b><u>Your Product Model Number &amp; Description:</u></b>	LC-20E1U LCD Color Television (Be sure to have this information available when you need service for your Product.)
<b><u>Warranty Period for this Product:</u></b>	One (1) year parts and labor from the date of purchase.
<b><u>Additional Item(s) Excluded from Warranty Coverage (if any):</u></b>	None
<b><u>Where to Obtain Service:</u></b>	From a Sharp Authorized Servicer located in the United States. To find the location of the nearest Sharp Authorized Servicer, call Sharp toll free at 1-800-BE-SHARP.
<b><u>What to do to Obtain Service:</u></b>	Ship prepaid or carry in your Product to a Sharp Authorized Servicer. Be sure to have <b>Proof of Purchase</b> available. If you ship the Product, be sure it is insured and packaged securely.

TO OBTAIN PRODUCT INFORMATION, CALL 1-888-LCD-SHARP OR VISIT [www.sharppusa.com](http://www.sharppusa.com)

**SHARP®**  
**SHARP ELECTRONICS CORPORATION**  
Sharp Plaza, Mahwah, New Jersey 07430-2135  
**SHARP CORPORATION**

# SHARP®

## LIMITED WARRANTY

### Consumer Electronics Products

## Congratulations on your purchase!

Sharp Electronics of Canada Ltd. (hereinafter called "Sharp") gives the following express warranty to the first consumer purchaser for this Sharp brand product, when shipped in its original container and sold or distributed in Canada by Sharp or by an Authorized Sharp Dealer:

Sharp warrants that this product is free, under normal use and maintenance, from any defects in material and workmanship. If any such defects should be found in this product within the applicable warranty period, Sharp shall, at its option, repair or replace the product as specified herein.

This warranty shall not apply to:

- (a) Any defects caused or repairs required as a result of abusive operation, negligence, accident, improper installation or inappropriate use as outlined in the owner's manual.
- (b) Any Sharp product tampered with, modified, adjusted or repaired by any party other than Sharp, Sharp's Authorized Service Centres or Sharp's Authorized Servicing Dealers.
- (c) Damage caused or repairs required as a result of the use with items not specified or approved by Sharp, including but not limited to head cleaning tapes and chemical cleaning agents.
- (d) Any replacement of accessories, glassware, consumable or peripheral items required through normal use of the product including but not limited to earphones, remote controls, AC adapters, batteries, temperature probe, stylus, trays, filters, belts, ribbons, cables and paper.
- (e) Any cosmetic damage to the surface or exterior that has been defaced or caused by normal wear and tear.
- (f) Any damage caused by external or environmental conditions, including but not limited to transmission line/power line voltage or liquid spillage.
- (g) Any product received without appropriate model, serial number and CSA/cUL markings.
- (h) Any products used for rental or commercial purposes.
- (i) Any installation, setup and/or programming charges.

Should this Sharp product fail to operate during the warranty period, warranty service may be obtained upon delivery of the Sharp product together with proof of purchase and a copy of this LIMITED WARRANTY statement to an Authorized Sharp Service Centre or an Authorized Sharp Servicing Dealer. In home warranty service may be provided at Sharp's discretion on any Sharp television with the screen size of 27" or larger and on any Sharp Over-the-Range Microwave Oven.

This warranty constitutes the entire express warranty granted by Sharp and no other dealer, service centre or their agent or employee is authorized to extend, enlarge or transfer this warranty on behalf of Sharp. To the extent the law permits, Sharp disclaims any and all liability for direct or indirect damages or losses or for any incidental, special or consequential damages or loss of profits resulting from a defect in material or workmanship relating to the product, including damages for the loss of time or use of this Sharp product or the loss of information. The purchaser will be responsible for any removal, reinstallation, transportation and insurance costs incurred. Correction of defects, in the manner and period of time described herein, constitute complete fulfillment of all obligations and responsibilities of Sharp to the purchaser with respect to the product and shall constitute full satisfaction of all claims, whether based on contract, negligence, strict liability or otherwise.

#### WARRANTY PERIODS:

	Parts & Labour (exceptions noted)
Audio Products	1 year
Camcorder	1 year
DVD Products	1 year
LCD Projector	1 year (lamp 90 days)
LCD TV	1 year
Microwave Oven	2 years (magnetron component-3 additional years)
Television Products	1 year (picture tube component-1 additional year)
VCR Product	1 year
Vacuum Cleaner	1 year

To obtain the name and address of the nearest Authorized Sharp Service Centre or Dealer, please contact:  
SHARP ELECTRONICS OF CANADA LTD. 335 Britannia Road East Mississauga, Ontario L4Z 1W9

For more information on this Warranty, Sharp Extended Warranty Offers, Sharp Canada Products, Accessory Sales, Dealer or Service Locations, please call (905) 568-7140  
Visit our Web site: [www.sharp.ca](http://www.sharp.ca)

