

YASHICA

35



INSTRUCTION BOOKLET

YL

F 1.9

Description of the YASHICA **YL**

THIS IS YOUR YASHICA

A precision instrument capable of bringing you some of the finest photographs you have ever taken. Please read the following pages carefully. Follow the easy, step-by-step recommendations.

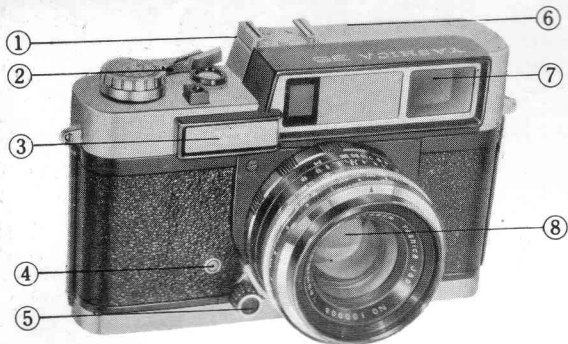

1. Accessory Shoe
2. Film Advance Lever
3. Name Plate
4. Flash Synchro-terminal
5. Focusing Lever
6. Rangefinder
7. Viewfinder
8. Lens (F: 1.9 45mm)
9. Cassette Supporting Shaft
10. Finder Eye-piece

- | | |
|------------------------------|----------------------------|
| 11. Finder Eye-piece | 21. Shutter Release Button |
| 12. Film Rewind Crank | 22. Film Exposure Counter |
| 13. Tripod Socket | 23. LVS Ring |
| 14. Sprocket | 24. Shutter Speed Scale |
| 15. Take-up Spool | 25. Cross Coupling Ring |
| 16. Film Pressure Plate | 26. Lens Opening Scale |
| 17. Self-timer Lever | 27. MX Synchro-selector |
| 18. Film Rewind Release Dial | 28. Depth-of-Field Scale |
| 19. Strap Holder | 29. Distance Scale |
| 20. Film Speed Dial | 30. Film Position Mark |

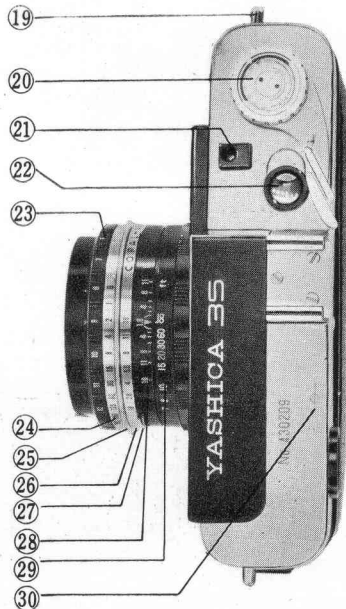
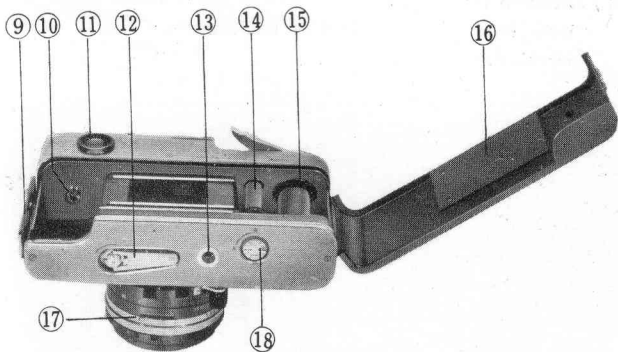

LOADING FILM

35 mm roll film
20 or 36 exposures per roll
24×36 mm size negative
Black and White or Color

- (1) To unlock back cover pull the Slide Lock down, and the hinged back cover will open.
- (2) Insert a new roll of 35 mm film in the film chamber.
- (3) Gently draw out the film leader from the cassette. Thread the film leader into the slot of the Take-Up Spool.
- (4) Advance the film with one stroke of the Advance Lever, and make sure the perforations in the film are threaded to the sprockets.

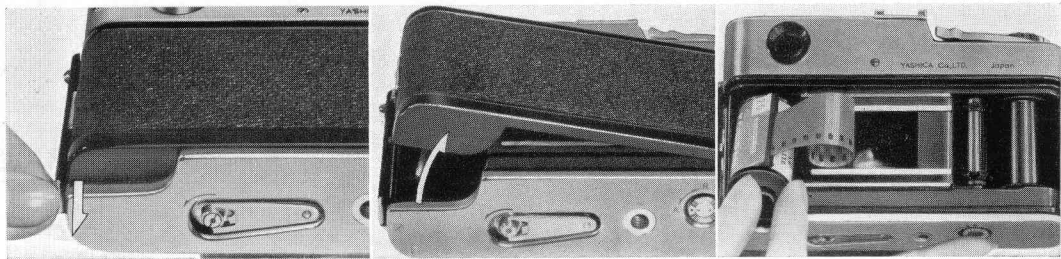

- (5) Close the back cover by pressing it with your fingers until it locks into position. Press the Shutter Release Button.
- (6) Repeat twice the operation of advancing the film, pressing the Shutter Release Button.
- (7) Now advance the film again and the figure 1 will appear opposite the red triangle in the Exposure Counter Window, and the camera is ready to take the first picture.

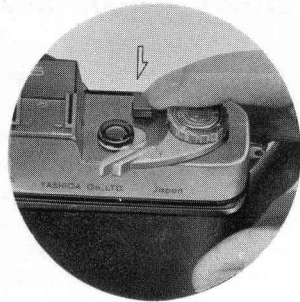

FILM SPEED SETTING

Set the ASA/DIN film speed dial which is on top of the Film Advance Lever to the corresponding ASA / DIN speed of the film loaded in the camera. This will serve to remind you of the type of film in your camera.

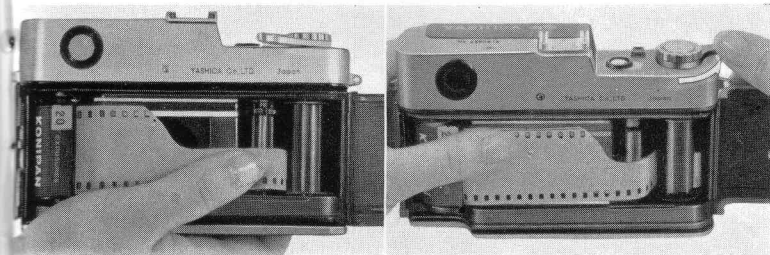

LIGHT VALUE SCALE SYSTEM SHUTTER

LVS-Light Value Scale or EVS-Exposure Value Scale as it is sometimes termed is a system of exposure setting incorporated in the shutter. When the LVS or EVS reading from an exposure meter (with LVS scale) is transferred to the LVS shutter, the aperture and shutter speed will be set corresponding to the meter reading to give the correct exposure. The Aperture and Shutter are linked together, therefore, the operation is simplified in obtaining the correct exposure for any combination of aperture opening and shutter speed - at small apertures for depth-of-field or higher shutter speeds for action without refiguring exposure.

SHUTTER SPEED : B • 1 • 1/2 • 1/4 • 1/8 • 1/15 •
1/30 • 1/60 • 1/125 • 1/250 •
1/500

LENS OPENING : F 1.9 2.8 4 5.6 8 11 16

LIGHT VALUE : 1~17

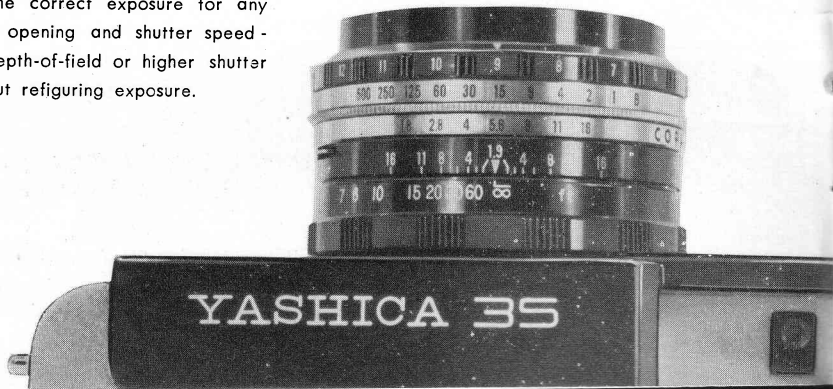



FOR EXAMPLE :

Assuming the LVS reading from the exposure meter is 9, turn the LVS ring on the shutter and set the figure 9 opposite the red triangle - the aperture will be f:5.6 and the shutter speed 1/15 second. This is the basic exposure which is the same as indicated on the exposure meter. If smaller apertures or higher shutter speeds are desired, turn the cross coupling ring and set the required aperture opening or shutter speed to the triangular mark and the correct exposure setting will be made in relation to the basic exposure.

LVS RING

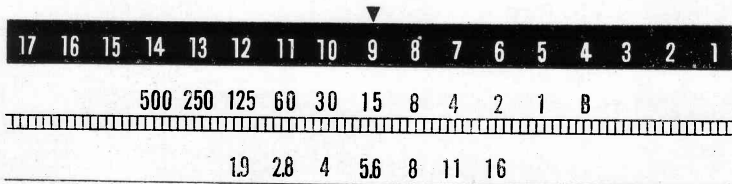

CONVENTIONAL EXPOSURE SETTING

Exposure readings from exposure meter without LVS numbers can also be set in the conventional manner with the LVS shutter on the YASHICA YL to the desired shutter speed and aperture (f. stop) which corresponds to the meter reading.

Individual setting of the shutter speed and aperture (f. stop) are done in the following steps:

1. Turn the LVS Ring and set the desired aperture (f. stop) number opposite to the base of the red triangle on the depth-of-field scale.
2. Hold the Coupling Ring between your fingers and stop it from rotating when the LVS Ring is turned.
3. Again, turn the LVS Ring and set the desired shutter speed opposite to the aperture (f. stop) number. Remove the fingers from the Coupling Ring.
4. Cock the shutter and advance the film with one stroke of the Film Advance Lever, and you are ready to take the picture.

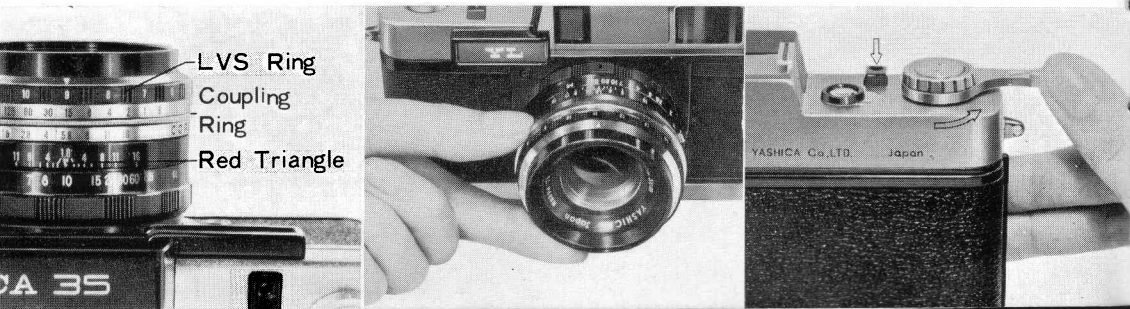

www.orphancameras.com

SIGHTING THE SUBJECT AND FOCUSING



The single window combines the viewfinder-rangefinder, which enables you to quickly sight, focus and frame the picture you wish to take. The extra large viewing window features a bright line frame indicating clearly the field of the 45mm lens. When you compose your picture within this frame you are assured of getting the same picture you are seeing through the viewfinder. When looking through the viewfinder, the small diamond appearing in the middle is the rangefinder of the super-imposed image type of focusing. To focus, sight the small diamond to the subject and move the Focusing Lever until the two images overlap and form one clear image. The camera is now in focus.

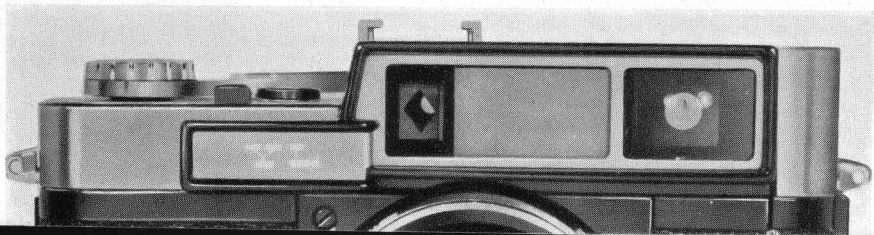

TAKING FLASH PICTURES

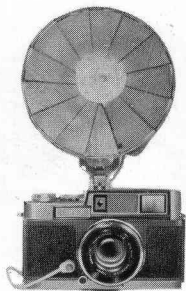

Your Yashica-YL offers M-X synchronization

Selector Position	M	X	X
Bulb used	Medium Peak	Short Peak	Medium Peak
Shutter Speed	Any Speed	1/50 or slower	1/25 or slower (When using self-timer)

Do not use Short Peak bulb with "M" Synchronization.

Move the selector to X position when using Electronic Flash.

Your camera dealer will be glad to supply the proper flash attachment for your camera.

As you become more proficient at taking picture, you will want to acquire accessories that increase the versatility of your camera. One of the first accessories you will want will be a flash unit.

Synchronization for flash is built-in. A standard FC connector plugs into the flash terminal. The battery case slips into the Accessory Shoe or attaches to the camera with an arm that screws into the tripod socket.

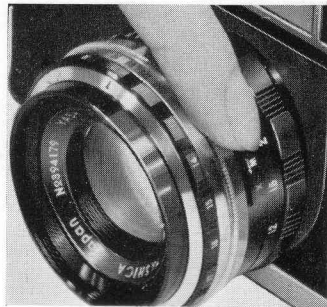
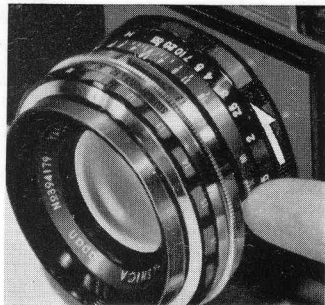

SINGLE STROKE FILM ADVANCE LEVER

The Single Stroke Film Advance Lever has the advantages of transporting the exposed film, cocking the shutter for the next exposure, and also preventing double exposure. Rapid sequence pictures are possible by quick operation of the Film Advance Lever.

The Yashica YL Film Advance Lever employs a fine, precision mechanism constructed to provide years of trouble-free performance. Like any instrument it should be treated with care and respect. It is important that one complete smooth stroke be given until it stops.

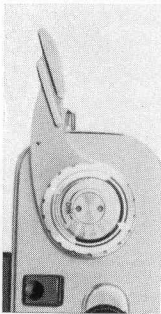

SELF-TIMER

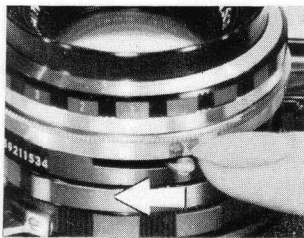

The Self-Timer, for taking self-portraits or group pictures, gives you about 8 seconds to get yourself into picture.

(A) Caution! Be sure to move the synchronization selector to the X position when using self-timer.

(B) Then set the speed, and move the Self-Timer in the direction shown by the arrow.

CABLE RELEASE

A standard cable release can be fitted to your Yashica. Screw the Cable Release into the socket provided on the Shutter Release Button. Your camera dealer will supply the proper cable release for your camera.

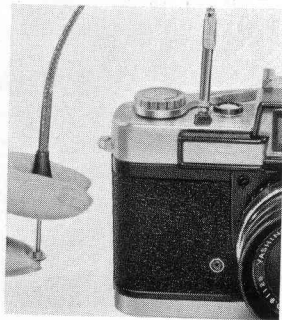

UNLOADING THE FILM

1. Turn the Film Release Dial which is located on the underside of the camera from "A" to "R", and the Film Rewind Crank will pop up.
2. Flip the crank handle to a horizontal position and wind in the direction of the arrow.
3. When the film is completely in the cassette, open the back cover and remove the cassette.
4. Turn the Film Release Dial from "R" to "A", and then fold the crank handle back in to the slot. Gently press the crank and it will lock itself flush to the camera base.

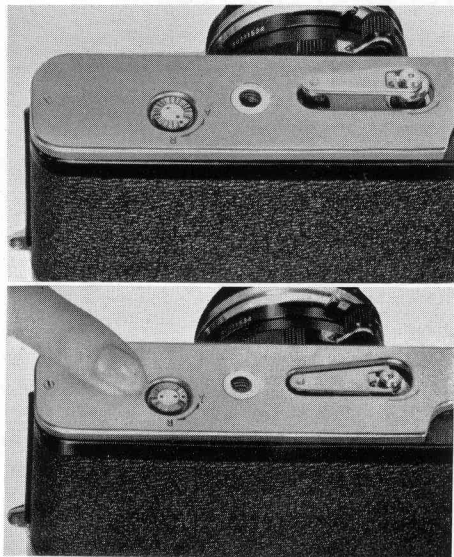

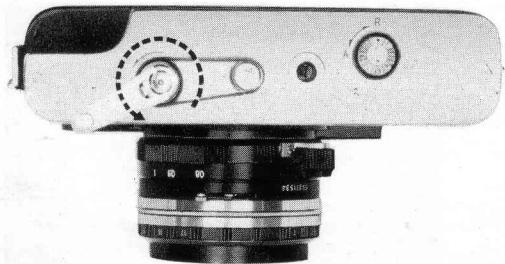

Note :

Towards the end of the film you will feel a slight resistance, but continue turning the rewind crank until the film pulls away from the slot on the Take-up Spool.

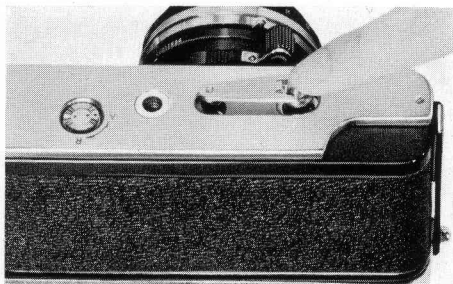
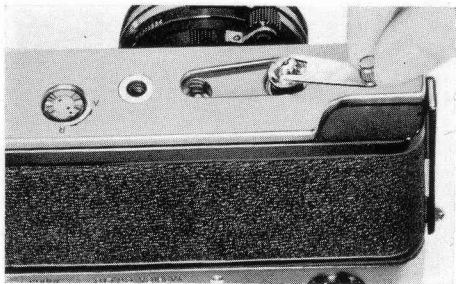

PARALLAX CORRECTION

Parallax or discrepancy between what the lens and viewfinder see is corrected automatically in the Yashica YL. The Yashica YL, with a tilting prism, fully coupled to the range-finder positively corrects for parallax and insures that the image on the film is identical to that seen through the parallax corrected viewfinder.



www.orphancameras.com
THE LENS OPENING

The Lens Aperture controls the amount of light that will pass through the lens onto light-sensitive film. Yashica YL, with its Yashinon lens, offers openings at $f: 1.9, 2.8, 4, 5.6, 8, 11$ & 16 . Notice that the lower the number, the larger the opening. $f: 1.9$ is the largest opening, and $f: 16$ the smallest. To set the lens opening, move the Cross Coupling Ring to set the desired number opposite the red triangle.

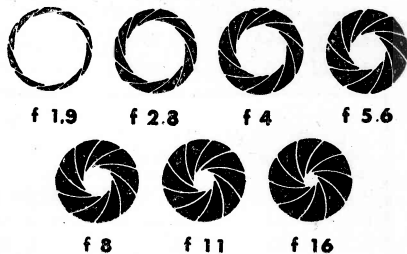

SHUTTER SPEED

The shutter speed controls the duration of the exposure. Shutter speeds on your Yashica YL with its fine Copal Shutter are $1, 1/2, 1/4, 1/8, 1/15, 1/30, 1/60, 1/125, 1/250, 1/500$ th of a second and 'B'. The 'B' setting is for taking pictures with an exposure longer than 1 second. Use a Tripod or Brace when using 'B'. When you press the Shutter Release Button on the 'B' setting the shutter stays open until you release pressure on the button.

It is advisable to set the shutter speed before you cock the shutter at all times.

Camera may be hand-held		Use a Tripod or Brace	
Average Pictures	Action Pictures	Time Exposure	Slow Speed
$1/30, 1/60, 1/125$	$1/250, 1/500$	'B'	1 sec $1/2, 1/4, 1/8$

EXPOSURE

Exposure means finding the right combination of lens-opening (aperture) and shutter speed in relation to the sensitivity (ASA) of your film. (ASA indicates American Standard Association). For example if you are using a film of ASA 100 (XX type) sensitivity, your correct exposure will be according to the following table :

DAYLIGHT EXPOSURE TABLE

Your shutter speed will be 1/100 with aperture numbers shown below.

	Bright Sun	Hazy Sun	Cloudy-Bright	Cloudy-Dull or Open Shade (4)
Light Subjects (1)	f/16	f/11	f/8	f/5.6
Average Subjects (2)	f/11	f/8	f/5.6	f/4
Dark Subjects (3)	f/8	f/5.6	f/4	f/2.8

- (1) Light Subjects : Distant landscapes, near-by people with sea, beach and snow scenes in the background.
- (2) Average Subjects : Near-by people, houses, gardens, buildings and places not in the shade. Advisable to use this class when light and dark objects are in about equal proportions.
- (3) Dark Subjects : People in dark clothing; trees, flowers, animals and large buildings.
- (4) Open Shade : Subjects shaded from the sun but lighted by a wide area of open sky. The less the open sky the larger the lens opening.

If you are using an ASA 50 film, you will make a larger lens-opening or lower your shutter speed (1/50). When in doubt, follow the film manufacturer's recommendations, and you will be assured of good pictures.

DEPTH OF FIELD

When you focus the camera on a subject there is a certain distance in front and back of the subject within which other objects will also appear sharp. This is known as the "Depth-of-Field", and it varies with the lens aperture, the smaller the aperture the greater the Depth-of-Field; it is much larger at $f:16$ than at $f:1.9$.

The Depth-of-Field scale will be found on the lens mount in the front part of the camera. You will notice that on either side of the $f:1.9$ figure is a similar set of numbers which represent the lens apertures. When the camera is focused on your subject, look for the aperture you are using on either side of the scale to determine the Depth-of-Field. Thus, if the camera is focused at 10 feet and the lens aperture is $f:8$, the Depth-of-Field (area in which all objects are sharp) is from about 7 ft. to 18 ft.

You can also use the Depth-of-Field to use your Yashica YL as a fixed-focus camera. In this case set the distance scale to 20 ft. (yellow figures) and the lens aperture to $f:8$. You will notice on the Depth-of-Field that anything from about 11 feet to infinity will be in focus.

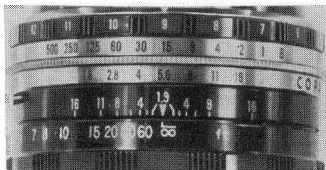

FILTERS

Initially, you will find a yellow filter ideal for bringing out clouds in landscape pictures and for general uses. An UV filter is suitable for color photography and also to protect the lens. As you become more advanced, you may want to use various filters, such as orange, green, etc., for different effects. Your camera dealer will give you complete information.

Notice

Be sure to replace the Lens Cap when your camera is not in use. Keep your camera away from dust and moisture. For cleaning the lens surface to remove dust or dirt, always wipe very lightly by using clean gauze or lens cleaning cloth. Do not wipe lens with a dirty handkerchief. When you are not using your camera for a long period do not leave the shutter set. In such cases place the Lens Cap over the lens to avoid exposure, and release the shutter.