

# STARPLUS<sup>®</sup>

*digital systems*

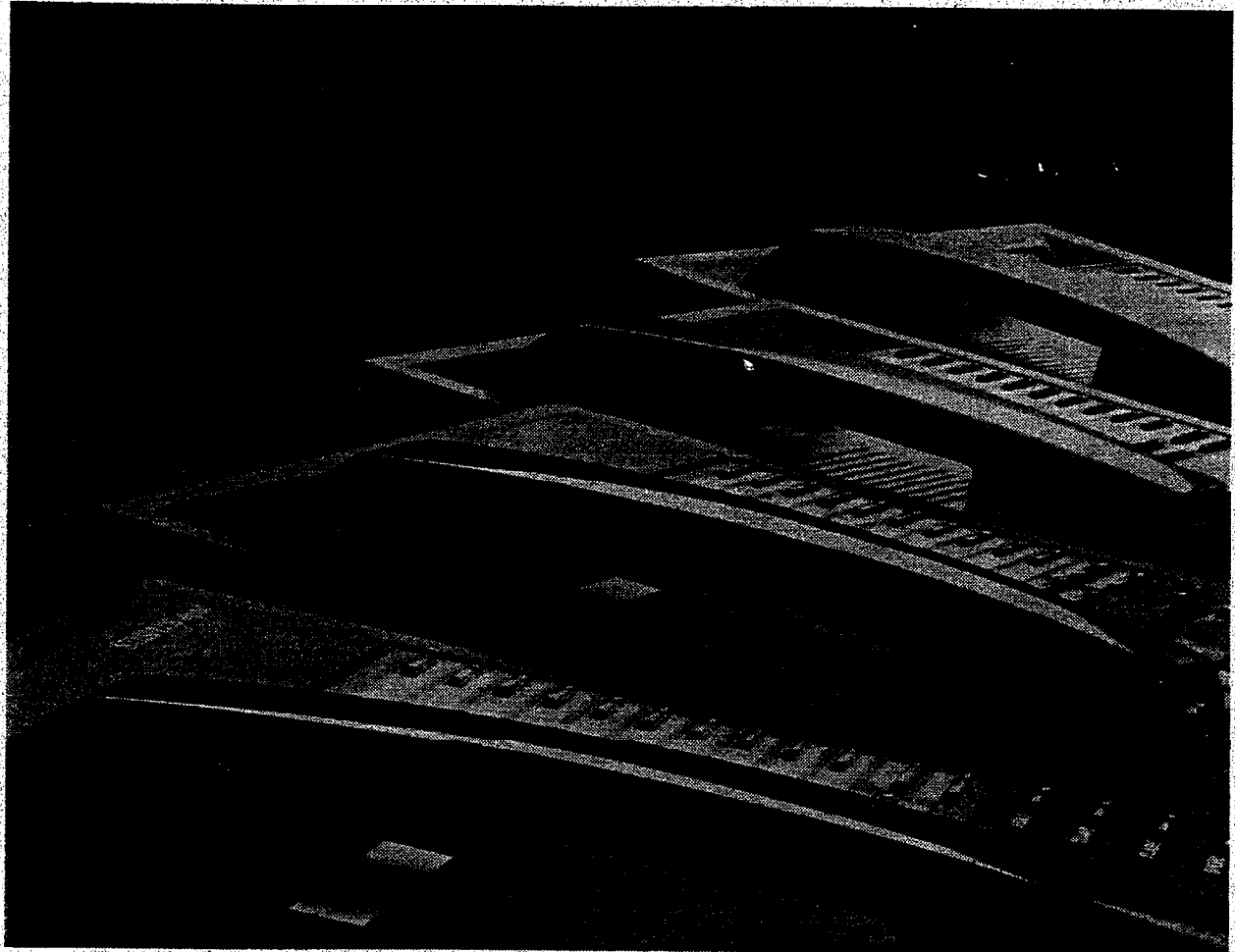

## SPD 4896

### HYBRID KEY TELEPHONE SYSTEM



COMMUNICATIONS  
SYSTEMS

QUICK REFERENCE TABLE OF CONTENTS

SECTION 100	INTRODUCTION .....	100-I
SECTION 200	KEY STATION FEATURE DESCRIPTION .....	200-I
SECTION 210	SINGLE LINE TELEPHONE FEATURE DESCRIPTION .....	210-1
SECTION 220	ATTENDANT FEATURE DESCRIPTION .....	220-I
SECTION 300	STATION FEATURE OPERATION .....	300-1
SECTION 305	BASIC KEYSET FEATURE OPERATION .....	305-1
SECTION 310	SLT FEATURE OPERATION .....	310-1
SECTION 320	ATTENDANT FEATURE OPERATION .....	320-1
SECTION 400	GENERAL DESCRIPTION .....	400-1
SECTION 500	INSTALLATION .....	500-I
SECTION 600	CUSTOMER DATA BASE PROGRAMMING .....	600-I
SECTION 610	SYSTEM PARAMETERS PROGRAMMING .....	610-1
SECTION 620	CO LINE ATTRIBUTES PROGRAMMING .....	620-1
SECTION 630	STATION ATTRIBUTES PROGRAMMING .....	630-1
SECTION 640	ICLID PROGRAMMING .....	640-1
SECTION 645	AUTOMATIC CALL DISTRIBUTION (ACD) .....	645-1
SECTION 650	UNIFORM CALL DISTRIBUTION (UCD) .....	650-1
SECTION 655	VOICE MAIL GROUPS (VM) .....	655-1
SECTION 660	EXCEPTION TABLES PROGRAMMING .....	660-1
SECTION 665	LEAST COST ROUTING (LCR) PROGRAMMING .....	665-1
SECTION 670	INITIALIZE DATABASE PARAMETERS .....	670-1
SECTION 675	PRINTING SYSTEM DATABASE PARAMETERS .....	675-1
SECTION 700	SYSTEM CHECK-OUT .....	700-1
SECTION 800	MAINTENANCE AND TROUBLESHOOTING .....	800-1
APPENDIX A	CUSTOMER DATABASE PROGRAMMING .....	A-1
APPENDIX B	DIGITAL SYSTEMS PART NUMBERS .....	B-1
APPENDIX C	ICLID GENERAL DESCRIPTION .....	C-1

## TABLE OF CONTENTS

<b>SECTION 100</b>	<b>INTRODUCTION .....</b>	<b>100-I</b>
100.1	PURPOSE.. .....	100-I
100.2	REGULATORY INFORMATION (U.S.A.) .....	100-I
	A. Telephone Company Notification .....	100-I
	B. Incidence of Harm .....	100-I
	C. Changes in Service .....	100-I
	D. Maintenance Limitations .....	100-I
	E. Notice of Compliance .....	100-I
	F. Hearing Aid Compatibility.. .....	100-I
	G. OPX Circuit .....	100-I
100.3	REGULATORY INFORMATION (CANADIAN) .....	100-2
	A. Notice .....	100-2
	B. Explanation of Load Number.....	100-2
	C. Maintenance Limitations .....	100-2
	D. Notice of Compliance .....	100-2
	E. OPX Circuit .....	100-2
100.4	UL/CSA SAFETY COMPLIANCE .....	100-2
100.5	TOLL FRAUD DISCLAIMER.. .....	100-3
<b>SECTION 200</b>	<b>KEY STATION FEATURE DESCRIPTION .....</b>	<b>200-I</b>
200.1	ACCOUNT CODES.. .....	200-1
200.2	ATTENDANT RECALL.....	200-1
200.3	AUTOMATIC CALL BACK TIMER.....	200-1
200.4	AUTOMATIC CALL DISTRIBUTION (ACD).....	200-1
	A. Agent Positions .....	200-1
	B. Alternate ACD Group Assignments.....	200-1
	C. Group Member Status.....	200-2
	D. Incoming CO Direct Ringing.....	200-2
	E. No-Answer Recall Timer .....	200-2
	F. No-Answer Retry Timer .....	200-2
	G. Overflow Station Assignments .....	200-2
	H. Recorded Announcements (RAN).....	200-2
	I. Guaranteed Message Announcement .....	200-2
	J. Supervisor Positions .....	200-2
	K. Supervisor/Agent Calls in Queue Display .....	200-3
	L. ACD Event Trace .....	200-3
200.5	AUTOMATIC LINE ACCESS .....	200-3
200.6	AUTOMATIC NIGHT SERVICE .....	200-3
200.7	AUTOMATIC PAUSE INSERTION WITH SPEED DIAL .....	200-3
200.8	AUTOMATIC PRIVACY .....	200-3
200.9	AUTOMATIC SELECTION .....	200-3
200.10	BACKGROUND MUSIC .....	200-3
200.11	BATTERY BACK-UP (MEMORY) .....	200-3

200.12	BUSY LAMP FIELD (BLF) .....	200-3
200.13	CALL ANNOUNCE - PRIVACY .....	200-3
200.14	CALL BACK .....	200-4
200.15	CALL COST DISPLAY FEATURE .....	200-4
200.16	CALL FORWARD: PRESET .....	200-4
	A. Preset Call Forward - ACD Groups .....	200-4
	B. Preset Call Forward - Hunt Groups .....	200-4
	C. Preset Call Forward - Off-Net .....	200-4
	D. Preset Call Forward - Stations .....	200-4
	E. Preset Call Forward - UCD Groups .....	200-4
	F. Preset Call Forward - VM Groups .....	200-4
200.17	CALL FORWARD: STATION .....	200-4
	A. Call Forward - All Calls .....	200-4
	B. Call Forward - Busy .....	200-5
	C. Call Forward - Busy/No Answer .....	200-5
	D. Call Forward - No Answer .....	200-5
	E. Call Forward - Off-Net .....	200-5
200.18	CALL PARK .....	200-5
200.19	CALL PICK-UP: .....	200-5
	A. Directed Call Pick-up .....	200-5
	B. Group Pick-up .....	200-5
200.20	CALL TRANSFER .....	200-5
200.21	CALLER ENTERED ICLID DIGITS .....	200-5
200.22	CALLING STATION TONE MODE OPTION .....	200-5
200.23	CAMP-ON .....	200-6
200.24	CAMP-ON RECALL .....	200-6
200.25	CANNED TOLL RESTRICTION .....	200-6
200.26	CENTREX COMPATIBILITY .....	200-6
	A. Flex Button Programming .....	200-6
	B. Off-Hook Preference .....	200-6
	C. Private Line Appearance .....	200-6
	D. Programmable Flash Timer .....	200-6
	E. Programming "*", "#", and Hook-Flashes into Speed Dial .....	200-6
200.27	CENTREX/PBX TRANSFER .....	200-6
200.28	CHAINING SPEED BINS .....	200-6
200.29	CO LINE ACCESS .....	200-6
200.30	CO LINE CLASS OF SERVICE .....	200-6
200.31	CO LINE CONTROL (CONTACT) .....	200-7
200.32	CO LINE GROUPS .....	200-7
200.33	CO LINE IDENTIFICATION .....	200-7
200.34	CO LINE INCOMING RINGING ASSIGNMENT .....	200-7
200.35	CO LINE LOOP SUPERVISION .....	200-7
200.36	CO LINE QUEUE .....	200-7
200.37	CO LINE RINGING OPTIONS .....	200-7
200.38	CO RING DETECT .....	200-7



## TABLE OF CONTENTS

200.39	CONFERENCE .....	200-7
	A. Add On Conference .....	200-7
	B. Multi-Line Conference .....	200-7
	C. Unsupervised Conference .....	200-8
200.40	CONFERENCE ENABLE/DISABLE .....	200-8
200.41	DATA FEATURE.. .....	200-8
200.42,	DATABASE PRINTOUT (DUMP). .....	200-8
200.43	DATABASE UPLOAD/DOWNLOAD .....	200-8
200.44	DAY/NIGHT CLASS OF SERVICE (COS). .....	200-8
200.45	DEFAULT BUTTON MAPPING .....	200-8
200.46	DIAL BY NAME .....	200-8
200.47	DIAL PULSE SENDING. ....	200-8
200.48	DIALING PRIVILEGES .....	200-8
200.49	DIRECT INWARD SYSTEM ACCESS (DISA) .....	200-8
	A. CO Line Group Access .....	200-11
	B. Programmable Access .....	200-11
	C. Station Access .....	200-11
	D. Trunk-to-Trunk, .....	200-11
	E. DISA Call Forwarding; .....	200-11
200.50	DIRECT STATION SELECTION .....	200-11
200.51	DIRECTED CALL PICK-UP .....	200-11
	A. Call Pick-up - Station .....	200-11
	B. Call Pick-up - ACD/UCD Groups. ....	200-11
200.52	DIRECTORY DIALING .....	200-11
200.53	DISABLE OUTGOING CO LINE ACCESS .....	200-11
200.54	DISTINCTIVE RINGING (User Selectable) .....	200-11
200.55	DO NOT DISTURB (DND) .....	200-1 1
	A. One-Time Do Not Disturb (DND) .....	200-1 2
200.56	DTMF SENDING .....	700-1 2
200.57	EMERGENCY TRANSFER .....	200-1 2
200.58	END TO END SIGNALING .....	200-12
200.59	EXCLUSIVE HOLD .....	200-1 2
200.60	EXECUTIVE OVERRIDE .....	200-1 2
200.61	EXECUTIVE/SECRETARY TRANSFER .....	200-12
200.62	EXTERNAL NIGHT RINGING. ....	200-12
200.63	FLASH. ....	200-12
200.64	FLASH ON INTERCOM .....	200-1 2
200.65	FLASH RATES (Programmable) .....	200-12
200.66	FLASH WITH SPEED DIAL .....	200-12
200.67	FLEXIBLE ATTENDANT .....	200-13
200.68	FLEXIBLE BUTTON ASSIGNMENT .....	200-13
200.69	FLEXIBLE PORT ASSIGNMENTS .....	200-13
200.70	FORCED ACCOUNT CODES .....	200-13
200.71	FORCED LEAST COST ROUTING (LCR) .....	200-13
200.72	GROUP CALL PICK-UP .....	200-13
200.73	GROUP LISTENING .....	200-13

200.74	HANDSET RECEIVER GAIN .....	200-13
200.75	HEADSET COMPATIBILITY .....	200-13
200.76	HEADSET MODE.....	200-14
200.77	HEARING AID COMPATIBLE .....	200-I 4
200.78	HOLD PREFERENCE .....	200-14
200.79	HOLD RECALL.....	200-14
200.80	HOT LINE/RING DOWN.....	200-14
200.81	HUNT GROUPS.....	200-14
	A. Hunt Group Chaining .....	200-I 4
	B. Pilot Hunting .....	200-I 4
	C. Station Hunting .....	200-I 4
200.82	ICLID FEATURE.....	200-I 4
	A. Calling Number/Name Display.....	200-14
	B. Incoming Number/Name for SMDR Records.....	200-14
	C. Unanswered Call Management .....	200-I 5
200.83	IDLE SPEAKER MODE .....	200-I 5
200.84	INCOMING CO LINES OFF-NET FORWARD (VIA SPEED DIAL) .....	200-15
200.85	INTERCOM CALLING .....	200-15
200.86	INTERCOM SIGNALING SELECT .....	200-I 5
200.87	KEYSET SELF TEST .....	200-I 5
200.88	LAST NUMBER REDIAL (LNR) .....	200-I 5
200.89	LCD INTERACTIVE DISPLAY .....	200-I 5
200.90	LEAST COST ROUTING (LCR) .....	200-I 5
	A. 3-Digit Table .....	200-I 5
	B. B-Digit Table (Office Codes) .....	200-I 6
	C. Route List Tables.....	200-I 6
	D. Insert/Delete Tables.....	200-I 6
	E. Weekly Time Tables .....	200-I 6
	F. Daily Start Time Tables .....	200-I 6
	G. Exception Tables .....	200-I 6
	H. Default LCR Data Base .....	200-I 6
	I. LCR Routing for Toil Information .....	200-I 6
200.91	LOCAL NUMBER/NAME TRANSLATION TABLE .....	200-I 6
200.92	LOOP BUTTON CO LINE ACCESS.....	200-I 6
200.93	MEET ME PAGE .....	200-I 6
200.94	MESSAGE WAITING .....	200-I 6
200.95	MESSAGE WAITING REMINDER TONE.....	200-16
200.96	MESSAGES - PERSONALIZED .....	200-I 7
	A. Date and Time Entry to Personalized Message(s) .....	200-I 7
	B. Messages - Custom .....	200-I 7
	C. Personalized Message Code on a Flex Key.....	200-I 7
<b>200.97</b>	MUSIC ON HOLD.....	200-17
200.98	MUTE KEY .....	200-I 7
200.99	NAME IN DISPLAY .....	200-I 7
200.100	NIGHT SERVICE FEATURE.....	200-17

## TABLE OF CONTENTS

200.101	NIGHT SERVICE MODE .....	200-17
	A. Automatic Night Mode Operation .....	200-17
	B. External Night Ringing .....	200-17
	C. Manual Operation .....	200-17
	D. Night Class of Service (COS) .....	200-17
	E. Night Ringing Assignments .....	200-17
	F. Universal Night Answer (UNA) .....	200-18
	G. Weekly Night Mode Schedule .....	200-18
200.102	OFF HOOK VOICE OVER .....	200-18
200.103	OFF-HOOK PREFERENCE .....	200-18
	A. Auto Feature Access .....	200-18
	B. Auto Line Access .....	200-18
	C. Hot Line/Ring Down .....	200-18
	D. Intercom Access .....	200-18
	E. User Programmable Preference .....	200-18
200.104	OFF-HOOK SIGNALING .....	200-18
200.105	OFF-PREMISE EXTENSIONS (OPX) .....	200-18
200.106	ON-HOOK DIALING .....	200-18
200.107	ON LINE PROGRAMMING .....	200-18
200.108	PAGE/RELAY CONTROL .....	200-19
200.109	PAGING .....	200-19
	A. External Paging .....	200-19
	B. Internal Paging .....	200-19
	C. Paging Access Restriction .....	200-19
200.110	PAUSE TIMER .....	200-19
200.111	PERSONAL PARK .....	200-19
200.112	PBX DIALING CODES .....	200-19
200.113	POOL BUTTON OPERATION .....	200-19
200.114	PREFERRED LINE ANSWER .....	200-19
200.115	PRIVACY RELEASE .....	200-19
	A. Per CO Line Option .....	200-19
	B. Per Station Option .....	200-20
200.116	PRIVATE LINE .....	200-20
200.117	PULSE-TO-TONE SWITCHOVER .....	200-20
200.118	RANGE PROGRAMMING .....	200-20
200.119	RELEASE KEY .....	200-20
200.120	REMOTE ADMINISTRATION .....	200-20
	A. Database Upload/Download .....	200-20
200.121	REMOTE SYSTEM MONITOR AND MAINTENANCE .....	200-20
	A. Remote System Maintenance .....	200-20
	B. Remote System Monitor .....	200-20
200.122	SAVE NUMBER REDIAL (SNR) .....	200-21
200.123	SINGLE LINE TELEPHONE (SLT) COMPATIBILITY .....	200-21
200.124	SPEAKERPHONE .....	200-21
200.125	STATION CLASS OF SERVICE (COS) .....	200-21

200.126	STATION MESSAGE DETAIL RECORDING (SMDR).....	200-21
200.127	STATION RELOCATION FEATURE.....	200-21
200.128	STATION SPEED DIAL.....	200-21
200.129	SYSTEM CAPACITY .....	200-21
	A. Up to 48x96 Configuration .....	<b>200-21</b>
200.130	SYSTEM HOLD.....	200-21
200.131	SYSTEM SPEED DIAL.....	200-21
200.132	TEXT MESSAGING (Silent Response) .....	200-21
200.133	TOLL RESTRICTION (TABLE DRIVEN).....	200-22
200.134	TRANSFER RECALL .....	<b>200-22</b>
200.135	UNIFORM CALL DISTRIBUTION (UCD) .....	200-22
	A. Alternate UCD Group Assignments.....	<b>200-22</b>
	B. Auto Wrap-Up w/Timer.....	200-22
	C. Available/Unavailable Mode .....	200-22
	D. Incoming CO Direct Ringing .....	<b>200-22</b>
	E. No-Answer Recall Timer.....	200-22
	F. No-Answer Retry Timer .....	200-22
	G. Overflow Station Assignments.....	200-22
	H. Recorded Announcements (RAN) .....	200-22
	I. Agent Queue Status Display.....	200-22
200.136	UNIVERSAL NIGHT ANSWER (UNA) .....	200-23
200.137	VOICE MAIL GROUPS (VM).....	200-23
	A. VM Disconnect Signal - Pass Thru .....	200-23
	B. VM In-Band Signaling Integration.....	200-23
	C. VM Message Waiting Indication .....	200-23
	D. VM Tone Mode Calling Option.....	200-24
	E. VM Transfer/Forward .....	200-24
	F. VM Transfer with ID Digits.....	200-24
200.138	VOLUME CONTROLS .....	200-24
<b>SECTION 210</b>	<b>SINGLE LINE TELEPHONE FEATURE DESCRIPTION .....</b>	<b>210-1</b>
210.1	ACCOUNT CODE .....	210-1
210.2	AUTOMATIC LINE ACCESS.....	210-1
210.3	CALL FORWARD .....	210-1
210.4	CAMP ON.....	210-1
210.5	CONFERENCE .....	210-1
210.6	CONFERENCE /WITH PERSONAL PARK.....	210-1
210.7	DIRECT OUTSIDE LINE GROUP ACCESS.....	210-1
210.8	DIRECT OUTSIDE LINE RINGING.....	210-1
210.9	DIRECTED CALL PICK-UP.....	210-1
210.10	DO NOT DISTURB (DND).....	210-1
210.11	GROUP CALL PICK-UP.....	210-1
210.12	HANDSET RECEIVER GAIN .....	210-2
210.13	INTERCOM CALLING .....	210-2
210.14	LOOP INTERRUPT OPTION .....	210-2
210.15	MESSAGE WAITING/CALL BACK.....	210-2

## TABLE OF CONTENTS

210.16	MESSAGES . PERSONALIZED.....	210-2
	A. Messages . Custom .....	210-2
210.17	NIGHT SERVICE .....	210-2
210.18	OFF-HOOK PREFERENCE.....	210-2
210.19	PERSONAL PARK.....	210-2
210.20	QUEUING .....	210-2
210.21	STATION SPEED DIAL .....	210-2
210.22	SYSTEM SPEED DIAL .....	210-2
210.23	TRANSFER.....	210-2
<b>SECTION 220</b>	<b>ATTENDANT FEATURE DESCRIPTION .....</b>	<b>220-1</b>
220.1	ATTENDANT DISABLE OUTGOING ACCESS.....	220-1
220.2	ATTENDANT OVERFLOW.....	220-1
220.3	ATTENDANT OVERRIDE.....	220-1
220.4	ATTENDANT POSITION .....	220-1
220.5	ATTENDANT RECALL.....	220-1
220.6	AUTOMATIC NIGHT MODE.....	220-1
220.7	HANDSET RECEIVER GAIN.....	220-1
220.8	INCOMING CO LINE OFF-NET FORWARD.....	220-1
220.9	NIGHT SERVICE FEATURE .....	220-1
220.10	TIME AND DATE PROGRAMMING .....	220-1
220.11	ATTENDANT SEARCH .....	220-2
220.12	BUSY LAMP FIELD INDICATORS .....	220-2
220.13	DIRECT STATION CALLING.....	220-2
220.14	MAPPING OPTIONS .....	220-2
220.15	MESSAGES . CUSTOM .....	220-2
220.16	RELEASE KEY .....	220-2
<b>SECTION 300</b>	<b>STATION FEATURE OPERATION .....</b>	<b>300-1</b>
300.1	INTRODUCTION.....	300-1
300.2	KEY TELEPHONE STATION FEATURES .....	300-1
300.3	ANSWERING AN OUTSIDE CALL .....	300-4
300.4	PLACING AN OUTSIDE CALL ON HOLD.....	300-4
300.5	ANSWERING A RECALL.....	300-4
300.6	ACCOUNT CODES.....	300-4
300.7	DISABLE OUTGOING CO LINE ACCESS.....	300-4
300.8	PLACING AN OUTSIDE CALL (Automatic Line Selection) .....	300-4
300.9	AUTOMATIC CALL DISTRIBUTION (ACD).....	300-4
	A. Agent Login/Logout Feature .....	300-4
	B. ACD Agent "HELP" button .....	300-5
	C. ACD Call Qualification.....	300-5
	D. ACD Agent Queue Status Display .....	300-6
	E. ACD Available/Unavailable Mode .....	300-6
	F. ACD Overflow Station . Available/Unavailable Mode.....	300-6
	G. Supervisor Login/Logout Feature.....	300-6
	H. Supervisor Monitor With Barge-In.....	300-7
	I. Supervisor Queue Status Display .....	300-7

	J.	ACD Group Member Status .....	300-8
300.10		BACKGROUND MUSIC (Optional) .....	300-8
300.11		AUTOMATIC SELECTION .....	300-8
300.12		CALL BACK .....	300-8
300.13		CALL FORWARD: STATION .....	300-9
	A.	Call Forward - All Calls .....	300-9
	B.	Call Forward - No Answer .....	300-9
	C.	Call Forward - Busy .....	300-9
	D.	Call Forward - Busy/No Answer .....	300-9
	E.	Call Forward - Off-Net (via speed dial) .....	300-10
	F.	Call Forward - ACD or UCD Groups .....	300-I 0
	G.	Call Forward - Voice Mail Groups .....	300-10
	H.	Call Forward - Hunt Groups .....	300-I 1
300.14		CALL FORWARD: PRESET .....	300-I 1
300.15		CALL FORWARD: CO LINES .....	300-I 1
	A.	Incoming CO Lines Off-Net (via speed dial) .....	300-I 1
300.16		CALLING STATION TONE MODE OPTION .....	300-I 1
300.17		CALL PARK .....	300-I 1
300.18		CALL PICK-UP: GROUP .....	300-12
300.19		CALL TRANSFER .....	300-I 2
300.20		TRANSFERRING CO CALLS TO A STATION FORWARDED TO VM .....	300-12
300.21		CAMP-ON .....	300-12
300.22		CO LINE ACCESS .....	300-I 3
300.23		CO LINE QUEUING .....	300-I 3
300.24		CONFERENCE COMBINATIONS .....	300-13
300.25		DATA FEATURE .....	300-13
300.26		DIAL BY NAME .....	300-14
300.27		DIRECTED CALL PICK-UP .....	300-I 5
300.28		DIRECTORY DIALING - Stations .....	300-I 5
300.29		DIRECT INWARD SYSTEM ACCESS (DISA) .....	300-I 6
300.30		DISTINCTIVE RINGING .....	300-I 6
300.31		DO NOT DISTURB .....	300-I 8
	A.	One-Time Do Not Disturb .....	300-I 8
300.32		EXCLUSIVE HOLD .....	300-18
300.33		EXECUTIVE OVERRIDE .....	300-I 8
300.34		EXECUTIVE/SECRETARY TRANSFER .....	300-I 9
300.35		FLASH .....	300-19
300.36		FLASH ON INTERCOM .....	300-19
300.37		FLEXIBLE BUTTON ASSIGNMENT .....	300-19
300.38		GROUP LISTENING .....	300-20
300.39		HANDSET RECEIVER GAIN .....	300-20
300.40		HEADSET MODE .....	300-21
300.41		ICLID UNANSWERED CALL MANAGEMENT TABLE .....	300-21
300.42		INTERCOM CALLING .....	300-21
300.43		INTERCOM TRANSFER .....	300-22

## TABLE OF CONTENTS

300.44	KEYSET SELF TEST.....	300-22
	A.    Keypad LCD/LED Test.....	300-22
	B.    Keypad Button Test.....	300-22
	C.    DSS LED/Button Test .....	300-22
300.45	LAST NUMBER REDIAL.....	300-23
300.46	LEAST COST ROUTING .....	300-23
300.47	MEET ME PAGE.....	300-23
300.48	MESSAGE WAITING.....	300-23
300.49	MUTE KEY.....	300-23
300.50	NIGHT SERVICE FEATURE .....	300-23
300.51	OFF-HOOK PREFERENCE .....	300-24
300.52	OFF HOOK VOICE OVER (OHVO) .....	300-24
300.53	PAGING .....	300-25
300.54	PBX/CENTREX TRANSFER .....	300-25
300.55	PERSONAL PARK.....	300-25
300.56	PERSONALIZED MESSAGES .....	300-26
	A.    Personalized Message - Date & Time Entry .....	300-26
	5.    Personalized Messages - Custom .....	300-26
	C.    Personalized Message Code On A Flex Button.....	300-27
300.57	PRIME FLEX BUTTON PROGRAMMING.....	300-27
300.58	PROGRAMMING YOUR NAME INTO THE LCD DISPLAY.....	300-27
300.59	PULSE-TO-TONE SWITCHOVER.....	300-28
300.60	SAVE NUMBER REDIAL.....	300-28
300.61	PROGRAMMING PBX/CENTREX CODES ONTO FLEX BUT-I-ON.....	300-28
300.62	SPEAKERPHONE .....	300-28
300.63	STATION RELOCATION FEATURE .....	300-28
300.64	STATION SPEED DIAL .....	300-28
300.65	STORING SPEED NUMBERS.....	300-29
300.66	SYSTEM SPEED DIAL.....	300-29
300.67	TEXT MESSAGING (Silent Response).....	300-29
300.68	UNIFORM CALL DISTRIBUTION (UCD) .....	300-30
	A.    UCD Calls in Queue Display.....	300-30
	B.    UCD Available/Unavailable Mode .....	300-30
<b>300.69</b>	UNIVERSAL NIGHT ANSWER (UNA).....	300-31
300.70	VOICE MAIL OPERATION (VM).....	300-31
	A.    Voice Mail Transfer with ID .....	300-31
	B.    VM Tone Mode Calling Option .....	300-31
300.71	RELEASE BUTTON .....	300-31
300.72	VOLUME CONTROLS .....	300-32
<b>SECTION 305</b>	<b>BASIC KEYPAD FEATURE OPERATION .....</b>	<b>305-1</b>
305.1	INTRODUCTION .....	305-1
305.2	BASIC KEY STATION FEATURES .....	305-1
305.3	AUTOMATIC CALL DISTRIBUTION (ACD).....	305-4
	A.    Agent Login/Logout Feature.....	305-4
	B.    ACD Agent "HELP" button .....	305-4

	C.	ACD Call Qualification .....	305-5
	D.	ACD Available/Unavailable Mode.. .....	305-5
	E.	ACD Overflow Station - Available/Unavailable Mode .....	305-5
305.4		CALL FORWARD: STATION .....	305-5
	A.	Call Forward - All Calls .....	305-5
	B.	Call Forward - No Answer .....	305-6
	c.	Call Forward - Busy .....	305-6
	D.	Call Forward - Busy/No Answer .....	305-6
	E.	Call Forward - Off-Net (via speed dial) .....	305-6
	F.	Call Forward - ACD or UCD Groups.. .....	305-7
	G.	Call Forward - Voice Mail Groups .....	305-7
	H.	Call Forward - Hunt Groups.. .....	305-7
305.5		CONFERENCE WITH PERSONAL PARK.....	305-8
305.6		CO LINE QUEUING .....	305-8
305.7		DIRECTED CALL PICK-UP .....	305-8
305.8		DO NOT DISTURB .....	305-8
305.9		MESSAGE WAITING .....	305-8
305.10		MUTE KEY .....	305-9
305.11		PBX/CENTREX TRANSFER .....	305-g
305.12		PERSONAL PARK (Flip-Flop) .....	305-9
305.13		PROGRAMMING YOUR NAME INTO THE LCD DISPLAY .....	305-9
305.14		VOLUME CONTROL .....	305-9
<b>SECTION 310</b>		<b>SLT FEATURE OPERATION .....</b>	<b>310-1</b>
310.1		INTRODUCTION .....	310-1
310.2		ACCOUNT CODE .....	310-1
310.3		AUTOMATIC CALL DISTRIBUTION (ACD) .....	310-1
	A.	Agent Login/Logout Feature .....	310-1
	B.	ACD Agent "HELP" button .....	310-1
	C.	ACD Available/Unavailable Mode .....	31 o-4
310.4		CALL BACK .....	31 o-4
310.5		CALL FORWARDING .....	310-4
310.6		CALLING STATION TONE MODE OPTION .....	31 o-4
310.7		CAMP-ON .....	31 o-4
310.8		CALL PARK (System) .....	31 o-4
310.9		CALL TRANSFER* .....	31 o-5
310.10		CLEAR CALL FORWARD, DND, PERSONALIZED MESSAGES. ....	310-5
310.11		CO LINE QUEUING .....	310-5
310.12		CONFERENCE .....	31 o-5
310.13		CONFERENCE WITH PERSONAL PARK.....	31 o-5
310.14		DIRECT OUTSIDE LINE ACCESS .....	31 o-5
310.15		DIRECTED CALL PICK-UP .....	31 o-5
310.16		DO NOT DISTURB .....	310-5
310.17		PBX/CENTREX TRANSFER (Flash Command to CO Line). ....	31 O-5
310.18		GROUP CALL PICK-UP .....	310-6
310.19		PLACING CALLS ON EXCLUSIVE HOLD.. .....	310-6



## TABLE OF CONTENTS

310.20	HANDSET RECEIVER GAIN .....	310-6
310.21	INTERCOM CALLING .....	310-6
310.22	LEAST COST ROUTING .....	310-6
310.23	MESSAGE WAITING.. .....	310-6
310.24	OFF-HOOK PREFERENCE .....	310-6
310.25	PERSONALIZED MESSAGES .....	310-6
310.26	PAGING .....	310-7
310.27	MEET ME PAGE .....	310-7
310.28	PERSONAL PARK (Flip-Flop) .....	310-7
310.29	PROGRAMMING YOUR NAME INTO THE LCD DISPLAY .....	310-7
310.30	STATION SPEED DIAL .....	310-8
310.31	STORING STATION SPEED NUMBERS .....	310-8
310.32	SYSTEM SPEED DIAL .....	310-8
310.33	UNIVERSAL NIGHT ANSWER (UNA) .....	310-8
310.34	UCD AVAILABLE/UNAVAILABLE .....	310-8
<b>SECTION 320</b>	<b>ATTENDANT FEATURE OPERATION .....</b>	<b>320-1</b>
320.1	INTRODUCTION .....	320-1
320.2	ATTENDANT KEY TELEPHONE STATION FEATURES .....	320-1
320.3	ANSWERING AN OUTSIDE CALL .....	320-4
320.4	PLACING OUTSIDE LINE ON HOLD .....	320-4
320.5	ANSWERING A RECALLING OUTSIDE LINE .....	320-4
320.6	ATTENDANT DISABLE OUTGOING ACCESS .....	320-4
320.7	ATTENDANT OVERRIDE .....	320-4
320.8	ATTENDANT RECALL .....	320-4
320.9	DATA FEATURE .....	320-4
320.10	DIAL BY NAME.. .....	320-5
320.11	DISTINCTIVE RINGING .....	320-6
320.12	EXECUTIVE OVERRIDE .....	320-7
320.13	HANDSET RECEIVER GAIN .....	320-7
320.14	ICLID UNANSWERED CALL MANAGEMENT TABLE .....	320-7
320.15	INTERCOM CALLING .....	320-8
320.16	INCOMING CO LINES OFF-NET (via speed dial) .....	320-8
320.17	KEYSET SELF TEST .....	320-9
	A.    Keypad LCD/LED Test.. .....	320-9
	B.    Keypad Button Test .....	320-9
	C.    DSS LED/Button Test .....	320-9
320.18	MESSAGES - CUSTOM .....	320-9
320.19	DIRECTORY DIALING - Attendant .....	320-10
	A.    Programming - Attendant .....	320-11
320.20	NIGHT SERVICE .....	320-13
320.21	OFF HOOK VOICE OVER (OHVO) .....	320-13
320.22	SETTING SYSTEM TIME AND DATE .....	320-14
320.23	STORING SYSTEM SPEED NUMBERS .....	320-15
320.24	TEXT MESSAGING (Silent Response) .....	320-15
320.25	ATTENDANT TRANSFER SEARCH .....	320-16

320.26	PLACING AN OUTSIDE CALL (Automatic tine Selection).....	320-I 6
320.27	CALL PARK.....	320-I 6
320.28	DO NOT DISTURB INDICATION .....	320-16
320.29	RETRIEVING A PARKED CALL .....	<b>320-16</b>
320.30	CALL TRANSFER .....	320-16
320.31	CAMP-ON .....	320-I 6
320.32	FLEXIBLE BUTTON PROGRAMMING .....	320-I 7
320.33	MEET ME PAGE .....	320-17
320.34	PAGING.....	320-I 7
	A. External Paging .....	320-I 7
	B. Internal Paging.....	320-I 7
	C. All Call Paging (Internal/External).....	320-I 7
320.35	RELEASE BUTTON .....	320-I 7
330.1	LCD DISPLAYS .....	330-I
<b>SECTION 400</b>	<b>GENERAL DESCRIPTION .....</b>	<b>400-I</b>
400.1	SYSTEM TECHNOLOGY .....	400-I
400.2	COMMON EQUIPMENT FOR THE SPD 4896 SYSTEM .....	400-2
	A. Equipment Cabinet With Power Supply (KSU).....	400-2
	B. Central Processor Unit (CPU).....	400-4
	C. Voice Control Board (VCB).....	400-6
	D. Key Telephone Board (KT12) .....	400-7
	E. Single Line Board (SL12).....	400-8
	F. CO Loop Interface Board (C012) .....	400-9
400.3	APPLICATION MODULES .....	400-I 0
	A. 4-Circuit DTMF Receiver Module (DTM4) .....	400-I 0
	B. Tri-Output Power Supply .....	400-I 0
	C. Backplane I/O Expansion Module.....	400-I 0
400.4	DIGITAL TERMINALS .....	400-I 1
	A. Executive (Display) Terminal .....	400-I 1
	B. Executive/PC Interface Terminal (ICLID).....	400-I 3
	C. Enhanced Digital Terminal.....	400-I 3
	D. Basic Digital Terminal .....	400-I 5
	E. Digital DSS/DLS Console .....	400-I 7
400.5	SLT ADAPTER / OFF-PREMISE EXTENSION MODULE.....	400-22
400.6	RELAY / SENSOR INTERFACE MODULE.....	400-23
40G.7	POWER FAILURE TRANSFER UNIT (PFTU) .....	400-24
400.8	DATA FEATURE .....	400-26
400.9	SYSTEM SPECIFICATIONS AND CAPACITY .....	400-28
<b>SECTION 500</b>	<b>INSTALLATION.....</b>	<b>500-I</b>
500.1	SITE PLANNING .....	500-I
	A. System Grounding .....	500-I
	B. Lightning Protection .....	500-I
500.2	INSTALLATION PLANNING FOR THE SPD 4896 SYSTEM.....	500-2
500.3	SYSTEM COMPONENTS FOR THE SPD 4896 SYSTEM.....	500-2

## TABLE OF CONTENTS

	A.	Equipment Cabinet With Power Supply (KSU) .....	500-2
	B.	Cabinet Installation.. .....	500-2
	c.	Central Processor Unit ( <b>CPU</b> ) .....	500-6
	D.	Voice Control Board ( <b>VCB</b> ) .....	500-10
	E.	Key Telephone Board (KT12) .....	500-1 1
	F.	Single Line Board (SL12) .....	500-1 4
	G.	CO Loop Interface Board ( <b>CO12</b> ) .....	500-1 6
500.4		APPLICATION MODULES.. .....	500-18
	A.	4-Circuit DTMF Receiver Module (DTM4).. .....	500-18
<b>500.5</b>		Tri-Output Power Supply Installation .....	500-18
500.6		Backplane I/O Expansion Module Installation .....	500-19
500.7		DIGITAL TERMINALS .....	500-20
	A.	Digital Terminals Installation: .....	500-20
	B.	Digital DSS Console Installation: .....	500-20
	C.	Wall Mounting the Executive Telephone .....	500-22
	D.	Single Line Telephone Installation .....	500-22
	E.	SLT Adapter / Off-Premise Extension Module (OPX) .....	500-22
500.8		POWER FAILURE TRANSFER .....	500-24
	A.	Relay / Sensor Interface Module .....	500-24
	B.	Power Failure Transfer Unit (PFTU) .....	500-24
<b>500.9</b>		INSTALLING RECORDED ANNOUNCEMENT DEVICE (RAN) .....	500-30
500.10		DATA FEATURE.. .....	500-31
<b>SECTION 600</b>		<b>CUSTOMER DATA BASE PROGRAMMING .....</b>	<b>600-1</b>
600.1		INTRODUCTION .....	600-1
600.2		PROGRAM MODE ENTRY (Key Station) .....	600-1
600.3		PROGRAM MODE ENTRY (Data Terminal or PC) .....	600-1 1
600.4		BEGINNING TO PROGRAM .....	600-1 1
600.5		INITIALIZATION.. .....	600-1 1
600.6		CUSTOMER DATA WORKSHEETS .....	600-1 1
600.7		DATA BASE FIELDS .....	600-1 1
600.8		DATABASE UPLOAD/DOWNLOAD ROUTINE.. .....	600-12
	A.	Using the PC to Upload/Download thru Remote Administration..	600-12
<b>SECTION 610</b>		<b>SYSTEM PARAMETERS PROGRAMMING .....</b>	<b>610-1</b>
610.1		SYSTEM TIMERS .....	610-1
	A.	System Hold Recall Timer .....	610-2
	B.	Exclusive Hold Recall Timer .....	610-2
	C.	Attendant Recall Timer .....	610-3
	D.	Transfer Recall Timer .....	610-3
	E.	Preset Forward Timer .....	610-4
	F.	Call Forward No/Answer Timer .....	610-4
	G.	Pause Timer .....	610-5
	H.	Call Park Recall Timer .....	610-5
	I.	Conference/DISA Timer .....	610-6
	J.	Paging Timeout Timer .....	610-6

	K.	CO Ring Detect Timer.....	610-7
	L.	SLT DTMF Receiver Timer.....	610-7
	M.	Message Wait Reminder Tone .....	610-8
	N.	SLT Hook Flash Timer .....	610-8
	O.	SLT Hook Flash <b>Debounce</b> Timer .....	610-9
	P.	SMDR <b>Call</b> Qualification Timer.. .....	610-10
	Q.	Automatic Call Back Timer .....	610-10
	R.	Reminder Ring Timer.. .....	610-11
	S.	Release Guard Timer .....	610-11
610.2		SYSTEM FEATURES PROGRAMMING.. .....	610-12
	A.	Attendant Override .....	610-13
	B.	Hold Preference.. .....	610-13
	C.	External Night Ring.....	610-14
	D.	Executive Override Warning Tone.. .....	610-14
	E.	Page Warning Tone.. .....	610-15
	F.	Background Music Channel.. .....	610-15
	G.	LCR Enable .....	610-16
	H.	Account Codes - Forced .....	610-16
	I.	Group Listening .....	610-17
	J.	idle Speaker Mode.. .....	610-17
	K.	Call Cost Display Feature.. .....	610-18
	L.	Music On Hold .....	610-18
	M.	Handset Receiver Gain.....	610-19
	N.	Call Qualifier Tone Option .....	610-20
610.3		ADDITIONAL SYSTEM FEATURES PROGRAMMING.. .....	610-21
	A.	Privacy Release Tone Option .....	610-21
610.4		FLASH RATES (Programmable) .....	610-22
	A.	incoming CO Line Ringing.....	610-22
	B.	Incoming Intercom Ringing.....	610-23
	C.	Call Forward .....	610-23
	D.	Message Waiting .....	610-23
610.5		ATTENDANT STATION ASSIGNMENT.. .....	610-24
610.6		SYSTEM TIME AND DATE.. .....	610-24
610.7		PBX DIALING CODES .....	610-25
810.8		EXECUTIVE/SECRETARY PAIRS .....	610-25
610.9		RELAY/SENSOR PROGRAMMING.. .....	610-26
	A.	Programming relay for External Paging: .....	610-27
	B.	Programming relay for RAN Starting: .....	610-27
	C.	Programming relay for Power Failure Transfer: .....	610-28
	D.	Programming relay for Loud Bell Control: .....	610-29
	E.	Programming relay for CO Line Control: .....	610-30
	F.	Assign Relay/Sensor Interface Module to a station: .....	610-30
	G.	Program sensing circuit as a RAN Sensing (RAN END) circuit: ..	610-31
610.10		BAUD RATE ASSIGNMENTS.. .....	610-32

## TABLE OF CONTENTS

610.11	ACCESS CODES.....	610-33
	A.    DISA Access Code.....	610-33
	B.    Database Admin. Password.....	610-34
610.12	STATION MESSAGE DETAIL RECORDING (SMDR) .....	61 0-35
	A.    SMDR Enable/Disable .....	61 0-35
	B.    Long Distance/Local Assignment .....	61 0-35
	C.    Character Print Assignment .....	610-36
	D.    Baud Rate Display .....	610-36
	E.    SMDR Port Assignments .....	610-36
610.13	WEEKLY NIGHT MODE SCHEDULE .....	610-37
	A.    Automatic/Manual Operation .....	610-37
	B.    Day of Week programming .....	610-37
610.14	DIRECTORY DIALING.....	610-38
610.15	FLEXIBLE CARD ASSIGNMENTS.....	610-41
610.16	HUNT GROUPS.....	610-42
	A.    Hunt Group Programming .....	61 0-42
	B.    Station/Pilot Hunting Assignment .....	61 0-42
610.17	LOCAL NUMBER/NAME TRANSLATION TABLE .....	610-43
<b>SECTION 620</b>	<b>CO LINE ATTRIBUTES PROGRAMMING .....</b>	<b>620-1</b>
620.1	INTRODUCTION.....	620-1
	A.    DTMF/Dial Pulse Programming .....	620-2
	B.    CO/PBX Programming .....	620-2
	C.    UNA Programming .....	620-3
	D.    DISA Trunk-to-Trunk (Per CO Line).....	620-3
	E.    Privacy .....	620-4
	F.    Loop Supervision Programming .....	620-5
	G.    DISA Programming .....	620-6
	H.    Flash Timer Programming .....	620-7
	I.    Line Group Programming .....	620-7
	J.    Class of Service (COS) Programming .....	620-8
	K.    CO Line Ringing Assignments .....	620-9
	L.    CO Line Identification Display .....	620-1 0
	M.    Trunk Direction .....	620-1 1
	N.    Ring Delay Timer .....	620-1 1
620.2	DIAL PULSE PARAMETERS.....	620-12
620.3	FLEXIBLE PORT ASSIGNMENT FEATURE .....	620-1 3
<b>SECTION 630</b>	<b>STATION ATTRIBUTES PROGRAMMING .....</b>	<b>630-1</b>
630.1	INTRODUCTION .....	630-1
	A.    Paging Access .....	630-2
	B.    Do Not Disturb .....	630-2
	C.    Conference Enable/Disable (Per Station).....	630-3
	D.    Executive Override .....	630-3
	E.    Privacy (Per Station) .....	630-4
	F.    System Speed Dial Access .....	630-5

	G.	Line Queuing .....	630-5
	H.	Preferred time Answer .....	630-6
	I.	Off-Hook Voice Over.....	630-6
	J.	Call Forwarding .....	630-7
	K.	Forced Least Cost Routing (LCR) .....	630-7
	L.	ACD Supervisor Monitor w/Barge-In.....	630-8
	M.	Executive Override Blocking.....	630-8
	N.	CO Line Ringing Options.. .....	630-9
630.2		PAGE "B" INTRODUCTION .....	630-10
	A.	Station identification .....	630-11
	B.	Station Class of Service (COS) .....	630-14
	C.	Speakerphone/Headset Programming .....	630-15
	D.	Pick-Up Group(s) Programming .....	630-15
	E.	Paging Zone(s) Programming.. .....	630-16
	F.	Preset Call Forward Programming .....	630-17
	G.	CO Line Group Access.....	630-18
	H.	LCR Class of Service (COS) .....	630-18
	I.	Off-Hook Preference Programming .....	630-19
	J.	Flexible Button Programming .....	630-20
	K.	Display Flexible Buttons .....	630-22
630.3		DIGITAL DATA INTERFACE UNIT (DDIU) .....	630-23
	A.	Baud Rate Options .....	630-23
	B.	Character Length Option .....	630-24
	C.	Stop Bit(s) Option .....	630-24
630.4		FLEXIBLE PORT ASSIGNMENT FEATURE .....	630-25
<b>SECTION 640</b>		<b>ICLID PROGRAMMING .....</b>	<b>640-1</b>
640.1		INTRODUCTION .....	640-1
	A.	Calling Number/Name Display.....	640-1
	B.	Incoming Number/Name for SMDR .....	640-1
	C.	Unanswered Call Management .....	640-1
640.2		ICLID RINGING ASSIGNMENT .....	640-2
640.3		ICLID FEATURES .....	640-4
	A.	Enable/Disable.....	640-4
	B.	Name in Display.....	640-4
	C.	Baud Rate Display.....	640-5
	D.	Port Assignment .....	640-5
<b>SECTION 646</b>		<b>AUTOMATIC CALL DISTRIBUTION (ACD).....</b>	<b>645-1</b>
645.1		ACD GROUP PROGRAMMING.. .....	645-1
	A.	Alternate ACD Group Assignment.....	645-2
	B.	ACD Overflow Station Assignment.....	645-2
	c.	ACD Recorded Announcement Assignment(s) (RAN) .....	645-3
	D.	ACD Supervisor Programming .....	645-4
	E.	ACD Station Assignment(s).....	645-5

## TABLE OF CONTENTS

645.2	ACD TIMERS .....	645-6
	A.    ACD Ring Timer .....	645-6
	B.    ACD Message Interval Timer .....	645-7
	C.    ACD Overflow Timer .....	645-7
	D.    ACD Auto Wrap-Up Timer .....	645-8
	E.    ACD No-Answer Recall Timer .....	645-8
	F.    ACD No-Answer Retry Timer .....	645-9
	G.    Guaranteed Message Timer .....	645-9
645.3	ACD RAN ANNOUNCEMENT TABLES .....	645-10
645.4	ACD EVENT TRACE .....	645-11
	A.    ACD Event Trace Enable/Disable .....	645-11
	B.    Trace Port Assignment .....	645-12
	C.    Baud Rate Display .....	645-12
645.5	ACD GROUP PROGRAMMING .....	645-13
	A.    Alternate ACD Group Assignment .....	645-14
	B.    ACD Overflow Station Assignment .....	645-14
	C.    ACD Recorded Announcement Assignment(s) (RAN) .....	645-15
	D.    ACD Supervisor Programming .....	645-16
	E.    ACD Station Assignment(s) .....	645-17
<b>SECTION 650</b>	<b>UNIFORM CALL DISTRIBUTION (UCD) .....</b>	<b>650-1</b>
650.1	UCD GROUP PROGRAMMING .....	650-1
	A.    Alternate UCD Group Assignment .....	650-2
	B.    UCD Overflow Station Assignment .....	650-2
	C.    UCD Recorded Announcement Assignment(s) (RAN) .....	650-3
	D.    UCD Station Assignment(s) .....	650-4
650.2	UCD TIMERS .....	650-5
	A.    UCD Ring Timer .....	650-5
	B.    UCD Message interval Timer .....	650-6
	C.    UCD Overflow Timer .....	650-6
	D.    UCD Auto Wrap-Up Timer .....	650-7
	E.    UCD No-Answer Recall Timer .....	650-7
	F.    UCD No-Answer Retry Timer .....	650-8
650.3	UCD RAN ANNOUNCEMENT TABLES .....	650-9
<b>SECTION 655</b>	<b>VOICE MAIL GROUPS (VM) .....</b>	<b>655-1</b>
655.1	VOICE MAIL PROGRAMMING .....	655-1
	A.    Alternate Voice Mail Group .....	655-2
	B.    "Leave" Mail Index Entry .....	655-2
	C.    "Retrieve" Mail Index Entry .....	655-3
	D.    Station Assignment(s) .....	655-3
655.2	VOICE MAIL OUTPUTSING TABLE .....	655-4
	A.    Voice Mail In-Band Signaling .....	655-4
	B.    Voice Mail Disconnect Table .....	655-5
655.3	VOICE MAIL IN-BAND FEATURES .....	655-6
	A.    Voice Mail In-Band Digits .....	655-6

	B.	Voice Mail Transfer/Forward.....	655-7
<b>SECTION 660</b>		<b>EXCEPTION TABLES PROGRAMMING.....</b>	<b>660-1</b>
660.1		EXCEPTION TABLES PROGRAMMING..	660-1
660.2		RELATED ITEMS TO TOLL RESTRICTION..	660-2
	A.	CO/PBX Lines.....	660-2
	B.	Forced Account Codes .....	660-2
	C.	SLT DTMF Receivers .....	660-2
	D.	LCR vs. Toll Restriction .....	660-3
660.3		TOLL RESTRICTION PROGRAMMING .....	660-4
	A.	Entering Toll Table Programming..	660-4
	B.	Allow Table Programming..	660-5
	C.	Deny Table Programming..	660-7
	D.	Special Table Programming .....	660-8
	E.	Displaying Toll Table Entries..	660-9
<b>SECTION 665</b>		<b>LEAST COST ROUTING (LCR) PROGRAMMING .....</b>	<b>665-1</b>
665.1		INTRODUCTION .....	665-1
	A.	LCR Operation..	665-1
665.2		LCR TABLES PROGRAMMING..	665-4
	A.	3-Digit Area/Office Code Table..	665-5
	B.	6-Digit Office Code Table .....	665-6
	C.	Exception Code Table .....	665-7
	D.	Route List Table.....	665-8
	E.	insert/Delete Table .....	665-1 0
	F.	Daily Start Time Table .....	665-1 1
	G.	Weekly Schedule Table..	665-1 2
	H.	LCR Routing for Toll Information .....	665-1 3
	I.	Default LCR Database..	665-1 4
<b>SECTION 670</b>		<b>INITIALIZE DATABASE PARAMETERS.....</b>	<b>670-1</b>
670.1		INTRODUCTION .....	670-1
	A.	Initialize System Parameters .....	670-2
	B.	Initialize CO Line Attributes .....	670-5
	C.	Initialize Station Attributes .....	670-6
	D.	Initialize Station and CO Port Parameters .....	670-9
	E.	Initialize Exception Tables .....	670-1 0
	F.	Initialize System Speed Numbers..	670-1 1
	G.	Initialize LCR Tables .....	670-1 2
	H.	Initialize System Database and Reset (all parameters).....	670-1 3
	I.	Initialize ICLID Parameters .....	670-14
	J.	initialize Directory Dialing Table Parameters.....	670-1 5
	K.	Initialize Hunt Group Parameters..	670-1 6
	L.	Initialize ACD or UCD Group Parameters..	670-17
	M.	Initialize VM Group Parameters .....	670-1 8
	N.	System Reset .....	670-1 9



<b>SECTION 675</b>	<b>PRINTING SYSTEM DATABASE PARAMETERS</b> .....675-1
675.1	INTRODUCTION ..... 675-1
	A. Printing System Parameters ..... 675-2
	B. Printing CO Line Attributes..... 675-4
	C. Printing Station Attributes.. ..... 675-6
	D. Printing CO and Station Port Parameters ..... 675-8
	E. Printing Exception Tables ..... 675-10
	F. Printing System Speed Bins..... 675-12
	G. Printing LCR Tables ..... 675-14
	H. Printing Entire System Data Base..... 675-23
	I. Printing ICLID Tables ..... 675-24
	J. Printing Directory Dialing Table Parameters..... 675-27
	K. Printing Hunt Group Parameters.. ..... 675-29
	L. Printing ACD or UCD Group Parameters..... 675-31
	M. Printing Voice Mail Group Parameters..... 675-33
	N. Abort Printing ..... 675-35
<b>SECTION 700</b>	<b>SYSTEM CHECK-OUT</b> .....700-1
700.1	INTRODUCTION ..... 700-1
700.2	PRELIMINARY PROCEDURES ..... 700-1
700.3	POWER UP SEQUENCE ..... 700-1
<b>SECTION 600</b>	<b>MAINTENANCE AND TROUBLESHOOTING</b> ..... 800-1
800.1	PRINTED CIRCUIT BOARD (PCB) TROUBLESHOOTING CHARTS..... 800-1
800.2	REMOTE MAINTENANCE..... 800-4
	A. General Overview ..... 800-4
	B. Overview of Maintenance Commands ..... 800-4
	C. Maintenance Password ..... 800-4
	D. Exit Maintenance ..... 800-4
	E. System Configuration ..... 800-5
	F. CO/Station Configuration ..... 800-6
	G. Event Trace Buffer ..... 800-7
800.3	REMOTE SYSTEM MONITOR ..... 800-8
	A. General Overview ..... 800-8
	B. Monitor Password ..... 800-8
	C. Help Menu (?)..... 800-8
	D. Dump Memory Data.. ..... 800-8
	E. Event Trace Mode..... 800-9
	F. Modify Memory command..... 800-10
	G. Baud Rate Command ..... 800-10
	H. Exit the Monitor mode ..... 800-10
<b>APPENDIX A</b>	<b>CUSTOMER DATABASE PROGRAMMING</b> ..... A-1
<b>APPENDIX B</b>	<b>DIGITAL SYSTEMS PART NUMBERS</b> ..... B-1

<b>APPENDIX C</b>	<b>ICLID GENERAL DESCRIPTION .....</b>	<b>C-I</b>
1.	INTRODUCTION .....	c-1
2.	SYSTEM CONFIGURATION .....	C-1
3.	FUNCTIONAL PERFORMANCE.....	C-1
	A. Calling Number/Name Display.....	C-2
	B. Incoming Number/Name SMDR .....	C-2
	C. Unanswered Call Management .....	C-2
	D. Local Name Translation.. .....	C-2
4.	ICLID Display Phone Operation .....	C-2
	A. Information from the Phone to the PC .....	C-3
	B. Information from the PC to the Phone .....	C-3
5.	IMPLEMENTATION PLAN .....	c-4
	A. ICLID KTU Display Phone.....	C-4
	B. Table Structures .....	C-5

## LIST OF FIGURES

<b>SECTION 100</b>	<b>INTRODUCTION</b> .....*	<b>100-1</b>
<b>SECTION 200</b>	<b>KEY STATION FEATURE DESCRIPTION</b> .....	<b>200-1</b>
	Figure 200-1 Executive Keypad Default Button Map .....	200-9
	Figure 200-2 Basic Keypad Default Button Map .....	200-10
<b>SECTION 210</b>	<b>SINGLE LINE TELEPHONE FEATURE DESCRIPTION</b> ..	<b>210-1</b>
<b>SECTION 220</b>	<b>ATTENDANT FEATURE DESCRIPTION</b> .....	<b>220-1</b>
<b>SECTION 300</b>	<b>STATION FEATURE OPERATION</b> .....	<b>300-1</b>
	Figure 300-1 Executive Digital Display Terminal..	300-2
<b>SECTION 305</b>	<b>BASIC KEYPAD FEATURE OPERATION</b> .....	<b>305-1</b>
	Figure 305-1 Basic Digital Terminal .....	305-2
<b>SECTION 310</b>	<b>SLT FEATURE OPERATION</b> .....	<b>310-1</b>
<b>SECTION 320</b>	<b>ATTENDANT FEATURE OPERATION</b> .....	<b>320-1</b>
	Figure 320-1 Attendant Display Terminal .....	320-2
<b>SECTION 400</b>	<b>GENERAL DESCRIPTION</b> .....	<b>400-1</b>
	Figure 400-1 Basic KSU Cabinet..	400-3
	Figure 400-2 Central Processing Unit (CPU) .....	400-5
	Figure 400-3 Voice Control Board (VCB) .....	400-6
	Figure 400-4 Key Telephone Board (KT12) .....	400-7
	Figure 400-5 Single Line Telephone Board (SL12). .....	400-8
	Figure 400-6 12-Circuit CO Line Board (CO1 2) .....	400-9
	Figure 400-7 Executive Digital Terminal..	400-12
	Figure 400-8 Enhanced Digital Terminal .....	400-14
	Figure 400-9 Basic Digital Terminal .....	400-16
	Figure 400-10 48-Button DSS/DLS Console .....	400-18
	Figure 400-14 Off-Premise Extension (OPX) Module .....	400-22
	Figure 400-15 Relay / Sensor Interface Module .....	400-23
	Figure 400-16 Power Failure Transfer Wiring Options .....	400-24
	Figure 400-17 Power Failure Transfer Circuit .....	400-25
	Figure 400-18 Digital Data Interface Unit (DDIU) wiring .....	400-27
<b>SECTION 500</b>	<b>INSTALLATION</b> .....	<b>500-1</b>
	Figure 500-1 Basic KSU Cabinet Mounting Arrangement .....	500-3
	Figure 500-2 Basic KSU Equipment Cabinet .....	500-4
	Figure 500-3 Basic KSU Cabinet Mounting Dimensions .....	500-5
	Figure 500-4 Central Processor Unit (CPU) .....	500-7
	Figure 500-5 RS-232C Printer Connections on CPU Board .....	500-8
	Figure 500-6 RS-232C Computer Connections on CPU Board .....	500-9
	Figure 500-7 Voice Control Board (VCB) .....	500-10
	Figure 500-8 Key Telephone Board (KT12) .....	500-12
	Figure 500-9 Shielded Cable Terminations .....	500-13
	Figure 500-10 Single Line Telephone Board (SL12) .....	500-14

Figure 500-I 1 CO Line Board (CO12) .....	500-17
Figure 500-I 2 <b>Backplane I/O</b> Expansion Module Connections .....	500-I 9
Figure 500-I 3 Digital Terminal Modular Block Wiring.....	500-21
Figure 500-I 4 Digital Terminal Wall Mounting.....	500-23
Figure 500-I 5 Off-Premise Extension (OPX) Module.....	500-25
Figure 500-I 6 Relay / Sensor Interface Module .....	500-26
Figure 500-I 7 Power Failure Transfer Wiring Options .....	500-27
Figure 500-I 8 Power Failure Transfer Circuit.....	500-28
Figure 500-I 9 CO and SLT RAN Connections.....	500-30
Figure 500-20 Digital Data Interface Unit (DDIU) wiring.....	500-31
<b>SECTION 600 CUSTOMER DATA BASE PROGRAMMING .....</b>	<b>600-I</b>
Figure 600-I Data Terminal Program Codes Cross Reference.....	600-2
Figure 600-2 Programming Button Mapping .....	600-3
<b>SECTION 610 SYSTEM PARAMETERS PROGRAMMING .....</b>	<b>610-I</b>
Figure 610-I Hook Switch Activity .....	610-9
<b>SECTION 620 CO LINE ATTRIBUTES PROGRAMMING .....</b>	<b>620-I</b>
<b>SECTION 630 STATION ATTRIBUTES PROGRAMMING.....</b>	<b>630-I</b>
<b>SECTION 640 ICLID PROGRAMMING .....</b>	<b>640-I</b>
<b>SECTION 645 AUTOMATIC CALL DISTRIBUTION (ACD).....</b>	<b>645-I</b>
<b>SECTION 650 UNIFORM CALL DISTRIBUTION (UCD) .....</b>	<b>650-I</b>
<b>SECTION 655 VOICE MAIL GROUPS (VM) .....</b>	<b>655-I</b>
<b>SECTION 660 EXCEPTION TABLES PROGRAMMING .....</b>	<b>660-I</b>
<b>SECTION 665 LEAST COST ROUTING (LCR) PROGRAMMING .....</b>	<b>665-I</b>
Figure 665-I LCR Flowchart.....	665-3
Figure 665-2 Ex: 3-Digit Area/Office Code Table Pgm Form.....	665-5
Figure 665-3 Ex: 6-Digit Office Code Table Pgm Form .....	665-6
Figure 665-4 Ex: Exception Code Table Pgm Form .....	665-7
Figure 665-5 Ex: Insert/Delete Pgm Form .....	665-10
Figure 665-6 Daily Start Time & Weekly Schedule Tables.....	665-I 1
Figure 665-7 Ex: Daily & Weekly Start Time Tables.....	665-12
Figure 665-8 Ex: LCR Toll Information Routing Pgm Form .....	665-13
<b>SECTION 670 INITIALIZE DATABASE PARAMETERS .....</b>	<b>670-I</b>
Figure 670-I 34-Button Default Button Mapping .....	670-7
Figure 670-2 14-Button Default Button Mapping .....	670-8
<b>SECTION 675 PRINTING SYSTEM DATABASE PARAMETERS .....</b>	<b>675-I</b>
Figure 675-I DB Printout of System Parameters.....	675-3
Figure 675-2 DB Printout of CO Line Attributes.....	675-5
Figure 675-3 DB Printout of Station Attributes .....	675-7
Figure 675-4 DB Printout of CO/Station Parameters .....	675-9
Figure 675-5 DB Printout of Exception Tables.....	675-I 1

**LIST OF FIGURES**

Figure 675-6 DB Printout of System Speed Numbers .....	675-13
Figure 675-7 DB Printout of LCR Tables.....	675-15
Figure 675-9 DB Printout of ICLID Table.....	675-25
Figure 675-I 2 DB Printout of Directory Dial Table .....	675-28
Figure 675-I 3 DB Printout of Hunt Group Parameters.....	675-30
Figure 675-I 4 DB Printout of ACD Group Parameters.....	675-32
Figure 675-I 5 DB Printout of Voice Mail Group Parameters.....	675-34
<b>SECTION 700</b>	
<b>SYSTEM CHECK-OUT.....</b>	<b>700-I</b>
<b>SECTION 800</b>	
<b>MAINTENANCE AND TROUBLESHOOTING .....</b>	<b>800-I</b>
Figure 800-1 Remote Maintenance Help Menu.....	800-4
Figure 800-2 System Configuration w/LCR .....	800-5
Figure 800-3 CO/Station Configuration .....	800-6
Figure 800-4 Event Trace as it appears on Display .....	800-10
<b>APPENDIX A</b>	
<b>CUSTOMER DATABASE PROGRAMMING.....</b>	<b>A-I</b>
<b>APPENDIX B</b>	
<b>DIGITAL SYSTEMS PART NUMBERS .....</b>	<b>B-1</b>
<b>APPENDIX C</b>	
<b>ICLID GENERAL DESCRIPTION .....</b>	<b>C-I</b>
Figure 1 ICLID System Configuration.....	C-I

## LIST OF TABLES

<b>SECTION 100</b>	<b>INTRODUCTION.....*</b>	<b>100-I</b>
<b>SECTION 200</b>	<b>KEY STATION FEATURE DESCRIPTION .....</b>	<b>200-I</b>
	Table 200-I Key Station Features/Software Packages .....	200-i
<b>SECTION 210</b>	<b>SINGLE LINE TELEPHONE FEATURE DESCRIPTION .....</b>	<b>210-1</b>
	Table 21 O-I SLT Station Features/Software Packages .....	21 O-i
<b>SECTION 220</b>	<b>ATTENDANT FEATURE DESCRIPTION .....</b>	<b>220-I</b>
	Table 220-I Attendant Features/Software Packages .....	220-i
<b>SECTION 300</b>	<b>STATION FEATURE OPERATION .....</b>	<b>300-I</b>
	Table 300-I Digital Terminal Numbering Plan .....	300-3
	Table 300-2 Flex Button Programming Codes.....	300-I 9
<b>SECTION 305</b>	<b>BASIC KEYSSET FEATURE OPERATION .....</b>	<b>305-I</b>
	Table 305-I Basic Keypad Numbering Plan .....	305-3
<b>SECTION 310</b>	<b>SLT FEATURE OPERATION .....</b>	<b>31 o-1</b>
	Table 31 O-I SLT Numbering Plan .....	31 O-3
<b>SECTION 320</b>	<b>ATTENDANT FEATURE OPERATION .....</b>	<b>320-I</b>
	Table 320-I Attendant Numbering Plan.....	320-3
	Table 330-I Liquid Crystal Displays (LCD).....	330-I
<b>SECTION 400</b>	<b>GENERAL DESCRIPTION .....</b>	<b>400-I</b>
	Table 400-I Digital System Capacities.....	400-30
	Table 400-2 Electrical Specifications.....	400-31
	Table 400-3 Environmental Specifications.....	400-31
	Table 400-4 Loop Limits .....	400-32
	Table 400-5 Dialing Specifications.....	400-32
	Table 400-6 FCC Registration Numbers.....	400-32
	Table 400-7 Trunk Ordering Info: Public Network Lines.....	400-32
	Table 400-8 Dimensions and Weight.....	400-33
	Table 400-9 Miscellaneous Specifications.....	400-33
	Table 400-I 0 Digital Terminal Audible Signals.....	400-34
	Table 400-I 1 Single Line Telephone Audible Signals .....	400-34
	Table 400-I 2 OPX Telephone Audible Signals .....	400-35
	Table 400-I 3 DSS/BLF Button Visual Indicators.....	400-36
	Table 400-I 4 CO Line Button Visual Indicators.....	400-36
	Table 400-I 5 Function Button Visual Indicators .....	400-36
<b>SECTION 500</b>	<b>INSTALLATION .....</b>	<b>500-I</b>
	Table 500-i Key Telephone Board (KT12) .....	500-i 1
	Table 500-2 Single Line Telephone Board (SL12).....	500-I 5
	Table 500-3 CO Line Board (CO1 2) Connections .....	500-I 6
	Table 500-4 PFTU Conn A Connecting Block .....	500-29
	Table 500-5 PFTU Conn B Connecting Block .....	500-29
	Table 500-6 SMDR Printout.....	500-34

**LIST OF TABLES**

<b>SECTION 600</b>	<b>CUSTOMER DATA BASE PROGRAMMING .....</b>	<b>600-I</b>
	Table 600-I Default Values.....	600-4
<b>SECTION 610</b>	<b>SYSTEM PARAMETERS PROGRAMMING .....</b>	<b>61 0-1</b>
<b>SECTION 620</b>	<b>CO LINE ATTRIBUTES PROGRAMMING .....</b>	<b>620-I</b>
	Table 620-I Class of Service (COS) .....	620-8
<b>SECTION 630</b>	<b>STATION ATTRIBUTES PROGRAMMING.....</b>	<b>630-I</b>
	Table 630-I Class of Service (COS) .....	630-14
	Table 630-2 Flexible Button Display Designations..	630-22
<b>SECTION 640</b>	<b>ICLID PROGRAMMING .....</b>	<b>640-I</b>
<b>SECTION 645</b>	<b>AUTOMATIC CALL DISTRIBUTION (ACD).....</b>	<b>645-I</b>
<b>SECTION 650</b>	<b>UNIFORM CALL DISTRIBUTION (UCD) .....</b>	<b>650-I</b>
<b>SECTION 655</b>	<b>VOICE MAIL GROUPS (VM) .....</b>	<b>655-I</b>
<b>SECTION 660</b>	<b>EXCEPTION TABLES PROGRAMMING .....</b>	<b>660-I</b>
	Table 660-I Class of Service (COS) .....	660-1
	Table 660-2 Allow/Deny Toil Table.....	660-2
<b>SECTION 665</b>	<b>LEAST COST ROUTING (LCR) PROGRAMMING .....</b>	<b>665-I</b>
	Table 665-I LCR Class of Service Table .....	665-9
<b>SECTION 670</b>	<b>INITIALIZE DATABASE PARAMETERS .....</b>	<b>670-I</b>
<b>SECTION 675</b>	<b>PRINTING SYSTEM DATABASE PARAMETERS .....</b>	<b>675-I</b>
<b>SECTION 700</b>	<b>SYSTEM CHECK-OUT.....</b>	<b>700-I</b>
<b>SECTION 800</b>	<b>MAINTENANCE AND TROUBLESHOOTING .....</b>	<b>600-I</b>
	Table 800-I Central Processor Unit (CPU) .....	800-1
	Table 800-2 CPU Static RAM Memory Size .....	800-1
	Table 800-3 CPU EPROM Memory Size.....	800-2
	Table 800-4 Single Line Board (SL12) .....	800-2
	Table 800-5 Key Telephone Board (KT12).....	800-2
	Table 800-6 Single Line Telephone Adapter (OPX) .....	800-3
	Table 800-7 CO Line Loop Board (C012). .....	800-3
	Table 800-8 Voice Control Board (VCB) .....	800-3
	Table 800-9 4-circuit DTMF Module (DTM4).....	800-3
	Table 800-I 0 Backplane I/O Expansion Module (IOM) .....	800-3
<b>APPENDIX A</b>	<b>CUSTOMER DATABASE PROGRAMMING .....</b>	<b>A-I</b>
	Appendix A-1 System Parameters .....	A-1
	Appendix A-2 Hunt Group, ACD and UCD Group Parameters .....	A-4
	Appendix A-2 Hunt, ACD, UCD Group Parameters (Cont'd) .....	A-5
	Appendix A-3 Voice Mail Group Parameters.....	A-6
	Appendix A-4 CO Line Programming (Flash 40) .....	A-7
	Appendix A-5 CO Line Ringing Assignment Chart .....	A-9
	Appendix A-6 Station Programming (Flash 50) .....	A-I 0

Appendix A-7 Button Assignment Chart (Flash 50) .....	A-I 1
Appendix A-8 System Speed Dial Numbers .....	A-I 2
Appendix A-9 Exception Tables (Flash 70).....	A-I 4
Appendix A-I 0 Least Cost Routing (Flash 75) .....	A-I 6
Appendix A-I 1 Route List Table .....	A-I 7
Appendix A-I 2 Insert/Delete Tables .....	A-21
Appendix A-I 3 3-Digit Area/Office Code Route List Table .....	A-23
Appendix A-I 4 6-Digit Office Code Table .....	A-24
Appendix A-I 5 LCR Exception Code Table.....	A-25
<b>APPENDIX B                    DIGITAL SYSTEMS PART NUMBERS .....</b>	<b>B-I</b>
Appendix B-I Digital System Component List .....	B-I
<b>APPENDIX C                    ICLID GENERAL DESCRIPTION .....</b>	<b>* ..... C-I</b>



**ISSUE CONTROL SHEET**

ISSUE	DATE	CHANGE
Issue 1	March 1994	Initial Release of the <b>Starplus SPD 4896</b> Digital System General Description, Installation and Maintenance Manual

## SECTION 100 INTRODUCTION

### 100.1 PURPOSE

This manual provides the information necessary to program, install, operate and maintain the Starplus Digital Key Telephone System.

### 100.2 REGULATORY INFORMATION (U.S.A.)

The Federal Communications Commission (FCC) has established rules which allow the direct connection of the Starplus Digital Key Telephone System to the telephone network. Certain actions must be undertaken or understood before the connection of customer provided equipment is completed.

#### A. Telephone Company Notification

Before connecting the Starplus Digital Key Telephone System to the telephone network, the local serving telephone company must be given advance notice of intention to use customer provided equipment and provided with the following information:

- The telephone numbers to be connected to the system.
- The Ringer Equivalence Number also located on the KSU: 1.9B
- The Universal System Ordering Code (USOC) jack required for direct interconnection with the telephone network: RJ21 X

#### FCC Registration Numbers:

- For systems configured as a key system:  
(button appearances)  
DLPHKG-74722-KF-E
- For systems configured as a Hybrid system:  
(dial access codes)  
DLPHKG-74723-MF-E

#### B. Incidence of Harm

If the telephone company determines that the customer provided equipment is faulty and possibly causing harm or interruption to the telephone network, it should be disconnected until repairs can be made. If this is not done, the telephone company may temporarily disconnect service.

#### C. Changes in Service

The local telephone company may make changes in its communications facilities or procedures. If these changes should affect the use of the Starplus Digital Key Telephone System

or compatibility with the network, the telephone company must give written notice to the user to allow uninterrupted service.

#### D. Maintenance Limitations

Maintenance on the Starplus Digital Key Telephone System is to be performed only by the manufacturer or its authorized agent. The user may not make any changes and/or repairs except as specifically noted in this manual. If unauthorized alterations or repairs are made, any remaining warranty and the software license for the system will be voided.

#### E. Notice of Compliance

The Starplus Digital Key Telephone System complies with rules regarding radiation and radio frequency emissions by Class A computing devices. In accordance with FCC Standard 15 (Subpart J), the following information must be supplied to the end user:

#### CAUTION

"This equipment generates and uses RF energy and if not installed and used in accordance with the Instruction Manual, may cause interference to Radio Communications. It has been tested and found to comply with the limits for a Class A computing device, pursuant to Subpart J of Part 15 of the FCC Rules, which are designed to provide reasonable protection against such interference, when operated in a commercial environment. Operation of this equipment in a residential area is likely to cause interference, in which case the user, at his own expense, will be required to take whatever measures may be required to correct the interference."

#### F. Hearing Aid Compatibility

All Starplus Digital Terminals are Hearing Aid Compatible, as defined in Section 68.316 of Part 68 FCC Rules and Regulations.

#### G. OPX Circuit

The Starplus Digital Key Telephone System may be equipped with Single Line Adapters (OPX) modules which provide a 48V FCC registered 2500-type single line off-premise extension interface pot-t.

- Each OPX port when used to support an off-premise extension requires an OL13C network circuit.
- An FCC registered interface such as a RJ11 C/W is also required to connect to the public network.

## INTRODUCTION

**100.3 REGULATORY INFORMATION (CANADIAN)**

- Department of Communications (DOC)  
Certification Number: 526 2933 **A**
- Load Number: 20
- Standard Connector: CA1 1 A/CA21 A
- Canadian Standards Association (CSA)  
File Number: LR57228

**A. Notice**

The Canadian Department of Communications' label identifies certified equipment. This certification means that the equipment meets certain telecommunications network protective, operational and safety requirements. This Department does not guarantee the equipment will operate to the user's satisfaction.

Before installing this equipment, users should ensure that it is permissible to be connected to the facilities of the local telecommunications company. The equipment must also be installed using an acceptable method of connection. In some cases, the company's inside wiring associated with single line individual service may be extended by means of a certified connector assembly (telephone extension cord). The customer should be aware that compliance with the above condition may not prevent degradation of service in some situations.

Repairs to certified equipment should be made by an authorized Canadian maintenance facility designated by the supplier. Any repairs or alterations made by the user to this equipment, or equipment malfunctions, may give the telecommunications company cause to request the user to disconnect the equipment.

Users should ensure for their own protection that the electrical ground connections of the power utility, telephone lines and internal metallic water pipe system, if present, are connected together. This precaution may be particularly important in rural areas.

**CAUTION**

Users should not attempt to make such connections themselves, but should contact the appropriate electric inspection authority, or electrician, as appropriate.

**B. Explanation of Load Number**

The Load Number (LN) assigned to each terminal device denotes the percentage of the total load to be connected to a telephone loop which is used by the device to prevent overloading. The termination on a loop may consist of any combination of devices subject only to the requirement that the total of the load numbers of all the devices does not exceed 100.

**C. Maintenance Limitations**

Maintenance on the Starplus Digital Key Telephone System is to be performed only by the manufacturer or its authorized agent. The user may not make any changes and/or repairs except as specifically noted in this manual. If unauthorized alterations or repairs are made, any remaining warranty and the software license for the system will be voided.

**D. Notice of Compliance**

The Starplus Digital Key Telephone System complies with Class **A** or Class **B** limits of the Canadian Radio Interference Regulations. In accordance with FCC Standard 15 (Subpart J), the following information must be supplied to the end user:

**CAUTION**

"This equipment generates and uses RF energy and if not installed and used in accordance with the Instruction Manual, may cause interference to Radio-Communications. It has been tested and found to comply with the limits for a Class A or Class B computing device, pursuant to Subpart J or Part 15 of the FCC Rules, which are designed to provide reasonable protection against such interference, when operated in a commercial environment. Operation of this equipment in a residential area is likely to cause interference, in which case the user, at his own expense, will be required to take whatever measures may be required to correct the interference."

**E. OPX Circuit**

The Starplus Digital Key Telephone System may be equipped with Single Line Adapters (OPX) modules which provide a 48V FCC registered 2500-type single line off-premise extension interface port.

- A DOC registered interface such as a CA11 is also required to connect to the public network.

**100.4 UUCSA SAFETY COMPLIANCE**

The Starplus Digital Key Telephone System has met all safety requirements and was found to be in compliance with the Underwriters Laboratories (UL) 1459 Second Edition and Canadian Standards Association (CSA) C22.2, No. 225 Standard. The Starplus Digital Key Telephone System is authorized to bear the UL and CSA marks. --

**100.5 TOLL FRAUD DISCLAIMER**

“WHILE THIS DEVICE IS DESIGNED TO BE REASONABLY SECURE AGAINST INTRUSIONS FROM FRAUDULENT CALLERS, IT IS BY NO MEANS INVULNERABLE TO FRAUD. THEREFORE NO EXPRESS OR IMPLIED WARRANTY IS MADE AGAINST SUCH FRAUD INCLUDING INTERCONNECTION TO THE LONG DISTANCE NETWORK.”

“WHILE THIS DEVICE IS DESIGNED TO BE REASONABLY SECURE AGAINST INVASION OF PRIVACY, IT IS BY NO MEANS INVULNERABLE TO SUCH INVASIONS. THEREFORE NO EXPRESS OR IMPLIED WARRANTY IS MADE AGAINST UNLAWFUL OR UNAUTHORIZED UTILIZATION WHICH RESULTS IN THE INVASION OF ONE’S RIGHT OF PRIVACY.”

**Table 200-I Key Station Features/Software Packages**

FEATURE	STANDARD FEATURES	ENHANCED FEATURES	CALL PROCESSING FEATURES	NETWORK & TRUNKING	COMBINATION PKG	ADDITIONAL EQUIPMENT REQUIRED
<b>A</b>						
Account Codes ..... 200-1		•	•	•	•	N
Attendant Recall ..... 200-1	•	•	•	•	•	N
Automatic Call Back Timer ..... 200-1	•	•	•	•	•	N
Automatic Call Distribution (ACD)..... 200-1			•		•	N
Agent Positions..... 200-1			•		•	N
Alternate ACD Group Assignments..... 200-1			•		•	N
Group Member Status ..... 200-1			•		•	Ⓚ
Guaranteed Message Announcement..... 200-2			•		•	RAN Device(s)
Incoming CO Direct Ringing ..... 200-2			•		•	N
No-Answer Recall Timer..... 200-2			•		•	N
No-Answer Retry Timer ..... 200-2			a		•	Ⓚ
Overflow Station Assignments..... 200-2			•		•	Ⓚ
ACD Event Trace..... 200-3			•		•	PC/Terminal/Printer
Recorded Announcements (RAN) ..... 200-2			•		•	RAN Device(s)
Supervisor Positions..... 200-2			•		•	Ⓚ
Supervisor/Agent Calls in Queue Display ..... 200-3			•		•	Ⓚ
Automatic Line Access..... 200-3	•	•	•	•	•	Ⓚ
Automatic Night Service ..... 200-3	•	•	•	•	•	Ⓚ
Automatic Pause Insertion w/Speed Dial ..... 200-3	•	•	•	•	•	Ⓚ
Automatic Privacy ..... 200-3	•	•	•	•	•	Ⓚ
Automatic Selection..... 200-3	e	•	•	•	•	Ⓚ
<b>B</b>						
Background Music ..... 200-3	•	•	•	•	•	Music Source
Battery Back-up (Memory) ..... 200-3	•	•	•	•	•	Ⓚ
Busy Lamp Field (BLF) ..... 200-3	•	•	•	•	•	Ⓚ

N=No additional hardware required

**Table 200-I Key Station Features/Software Packages**

FEATURE	STANDARD FEATURES	ENHANCED FEATURES	CALL PROCESSING FEATURES	NETWORK & TRUNKING	COMBINATION PKG	ADDITIONAL EQUIPMENT REQUIRED
C						
Call Announce - Privacy..... 200-3	●	•	●	•	●	N
Call Back ..... 200-3	•	•	●	●	●	N
Call Cost Display Feature ..... 200-3				•	•	⊗
Call Forward: Preset ..... 200-4	•	●	●	•	•	⊗
ACD Groups..... 200-4			•		•	⊗
Hunt Groups..... 200-4	●	•	●	•	•	⊗
Off-Net..... 200-4	●	●	•	•	•	⊗
Stations..... 200-4	●	•	•	•	•	⊗
UCD Groups ..... 200-4	•	•	●	•	•	⊗
VM Groups..... 200-4		●	●	•	●	VM System
Call Forward: Station..... 200-4	•	•	•	•	●	N
All Calls..... 200-4	●	●	•	•	•	N
Busy ..... 200-4	•	•	●	•	•	⊗
Busy/No Answer ..... 200-5	•	•	•	•	•	N
No Answer ..... 200-5	•	●	●	•	•	N
Off -Net ..... 200-5	●	•	•	•	•	N
Call Park..... 200-5	•	•	•	•	•	N
Call Pick-up ..... 200-5	•	•	•	•	●	N
Directed Call Pick-up ..... 200-5	•	●	●	•	•	N
Group Pick-up..... 200-5	•	•	•	•	●	N
Call Transfer ..... 200-5	•	•	●	•	●	N
Caller Entered ICLID Digits..... 200-5			•		•	N
Calling Station Tone Mode Option ..... 200-5	•	●	•	•	•	N
Camp-On..... 200-5	●	●	•	•	● I	N
Camp-On Recall..... 200-6	•	●	•	•	•	⊗
Canned Toll Restriction..... 200-6	•	●	●	•	•	N
Centrex Compatibility..... 200-6	•	●	•	•	•	⊗

N=No additional hardware required

**Table 200-I Key Station Features/Software Packages**

FEATURE	STANDARD FEATURES	ENHANCED FEATURES	CALL PROCESSING FEATURES	NETWORK & TRUNKING	COMBINATION PKG	ADDITIONAL EQUIPMENT REQUIRED
Flex Button Programming ..... 200-6	•	•	•	•	•	N
Off-Hook Preference ..... 200-6	•	•	•	•	• †	- ‡
Private Line Appearance ..... 200-6	•	•	•	•	•	N
Programmable Flash Timer ..... 200-6	•	•	•	•	•	N
Programming *, #, and Hook-Flashes into Speed Dial ..... 200-6	•	•	•	•	•	N
Centrex/PBX Transfer ..... 200-6	•	•	•	•	•	N
Chaining Speed Bins ..... 200-6	•	•	•	•	•	N
CO Line Access ..... 200-6	•	•	•	•	•	N
CO Line Class of Service ..... 200-6	•	•	•	•	•	N
CO Line Control (Contact) ..... 200-6	•	•	•	•	•	Gen & Bells
CO Line Groups ..... 200-7	•	•	•	•	•	N
CO Line Identification ..... 200-7	•	•	•	•	•	N
CO Line Incoming Ringing Assignment ..... 200-7	•	•	•	•	•	N
CO Line Loop Supervision ..... 200-7	•	•	•	•	•	N
CO Line Queue ..... 200-7	•	•	•	•	•	N
CO Line Ringing Options ..... 200-7	•	•	•	•	•	N
CO Ring Detect ..... 200-7	•	•	•	•	•	N
Conference ..... 200-7	•	•	•	•	•	N
Add-On Conference ..... 200-7	•	•	•	•	•	‡
Multi-Line Conference ..... 200-7	•	•	•	•	•	N
Unsupervised Conference ..... 200-7	•	•	•	•	•	N
Conference Enable/Disable ..... 200-8	•	•	•	•	•	N
<b>D</b>						
Data Feature ..... 200-8	•	•	•	•	•	PC/Terminal
DataBase Printout (Dump) ..... 200-8	•	•	•	•	•	Printer/Terminal
Database Upload/Download ..... 200-8	•	•	•	•	•	Printer/Terminal
Day/Night Class of Service (COS) ..... 200-8	•	•	•	•	•	N

N=No additional hardware required

Table 200-I Key Station Features/Software Packages

FEATURE	STANDARD FEATURES	ENHANCED FEATURES	CALL PROCESSING FEATURES	NETWORK & TRUNKING	COMBINATION PKG	ADDITIONAL EQUIPMENT REQUIRED
Default Button Mapping .....200-8	●	●	●	●	□	⊗
Dial By Name.....200-8	●	●	●	●	□	⊗
Dial Pulse Sending ..... 200-8	●	□	□	●	●	⊗
Dialing Privileges ..... 200-8	●	●	●	●	0	N
Direct Inward-System Access (DISA)..... 200-8	0	●	0	0	0	DTMF Rcvr
CO Line Group Access ..... 200-8	0	0	0	0	0	N
DISA Call Forwarding ..... 200-11	0	0	0	0	0	N
Programmable Access ..... 200-8	0	0	0	0	0	N
Station Access ..... 200-11	0	0	●	0	0	N
Trunk-to-Trunk ..... 200-11	0	0	0	●	0	N
Direct Station Selection ..... 200-11	0	0	0	0	0	N
Directed Call Pick-up ..... 200-11	0	0	0	0	0	N
Call Pick-up - Station ..... 200-11	0	0	0	0	0	N
Call Pick-up - UCD Groups ..... 200-11	0	●	●	0	0	N
Directory Dialing..... 200-11	0	0	●	0	0	N
Disable Outgoing Call Access ..... 1	0	0	0	0	0	N
Distinctive Ringing (User Selectable) . . . . .	0	0	0	0	0	N
Do Not Disturb (DND) ..... 200-11	0	0	0	●	●	⊗
One-Time Do Not Disturb (DND) . . . . . 200-11	0	0	●	0	0	N
DTMF Sending ..... 200-12	0	0	0	0	0	N
<b>E</b>						
Emergency Transfer .....200-12	0	0	●	0	●	OPX/48v supply PFTU/12v supply
End to End Signalling..... 200-12	●	●	●	0	0	⊗
Exclusive Hold..... 200-12	0	0	0	0	●	⊗
Executive Override..... 200-12	●	0	●	0	0	⊗
Executive/Secretary Transfer..... 200-12	0	●	0	0	0	N
External Night Ringing ..... 200-12	0	0	0	0	0	Paging Equipment

N=No additional hardware required



**Table 200-I Key Station Features/Software Packages**

FEATURE	STANDARD FEATURES	ENHANCED FEATURES	CALL PROCESSING FEATURES	NETWORK & TRUNKING	COMBINATION PKG	ADDITIONAL EQUIPMENT REQUIRED
<b>F</b>						
Flash ..... 200-I 2	•	•	•	•	•	N
Flash On Intercom ..... 200-12	•	•	•	☒	•	N
Flash Rates (Programmable) ..... 200-12	•	•	•	•	•	N
Flash with Speed Dial ..... 200-12	•	•	•	•	•	N
Flexible Attendant ..... 200-13	•	•	•	•	•	N
Flexible Button Assignment ..... 200-13	•	•	•	•	•	<b>34-Btn/14-Btn</b>
Flexible Port Assignments ..... 200-13	•	•	•	•	•	N
Forced Account Codes ..... 200-13	•	•	•	•	•	N
Forced Least Cost Routing (LCR) ..... 200-I 3				•	•	N
<b>G</b>						
Group Call Pick-up ..... 200-I 3	•	•	•	•	•	N
Group Listening ..... 200-I 3	•	•	•	•	•	N
<b>H</b>						
Handset Receiver Gain ..... 200-I 3	•	•	•	•	•	N
Headset Compatibility ..... 200-13	•	•	•	•	•	Headset
Headset Mode ..... 200-14	•	•	•	•	•	Headset
Hearing Aid Compatible ..... 200-14	•	•	•	•	•	N
Hold Preference ..... 200-14	•	•	•	•	•	N
Hold Recall ..... 200-14	•	•	•	•	•	N
Hot Line/Ring Down ..... 200-14	•	•	•	•	•	N
Hunt Groups ..... 200-14	•	•	•	•	•	N
Hunt Group Chaining ..... 200-14	•	•	•	•	•	N
Pilot Hunting ..... 200-14	•	•	•	•	•	N
Station Hunting ..... 200-14	•	•	•	☒	•	N
<b>I</b>						
ICLID Feature ..... 200-14			•		•	<b>ICLID Keypad</b>
Calling Number/Name Display ..... 200-14			•		•	<b>ICLID Keypad</b>

N=No additional hardware required

**Table 200-I Key Station Features/Software Packages**

FEATURE	STANDARD FEATURES	ENHANCED FEATURES	CALL PROCESSING FEATURES	NETWORK & TRUNKING	COMBINATION PKG	ADDITIONAL EQUIPMENT REQUIRED
Incoming Number/Name for SMDR Records..... 200-14			•		•	ICLID Keyset
Unanswered Call Management.. 200-15			•		•	ICLID Keyset
Idle Speaker Mode..... 200-15	•	•	•	•	•	N
Incoming CO Lines Off-Net Forward via Speed Dial. 200-15	•	•	•	•	•	N
Intercom Calling ..... 200-I 5	•	•	•	•	•	N
Intercom Signaling Select . . . . . 200-I 5	•	•	•	•	•	N
<b>K</b>						
Keyset Self Test ..... 200-15	•	•	•	•	•	34-Btn keyset
<b>L</b>						
Last Number Redial (LNR). . . . . 200-15	•	•	•	•	•	N
LCD Interactive Display ..... 200-I 5	•	•	•	•	•	Exec Keyset
Least Cost Routing (LCR) ..... 200-15				•	•	N
6-Digit Table.. . . . . 200-16				•	•	N
Daily Start Time Tables ..... 200-16				•	•	N
Default LCR Data Base ..... 200-I 6				•	•	N
Exception Tables ..... 200-I 6				•	•	N
Insert/Delete Tables.. . . . . 200-I 6			•••••	•	•	N
LCR Routing for Toll Information ..... 200-16				•	•	N
Route List Tables ..... 200-I 5				•	•	N
Weekly Time Tables ..... 200-16				•	•	N
3-Digit Table ..... 200-I 5				•	•	N
Local Number/Name Translation Table ..... 200-I 6	•	•	•	•	•	N
Loop Button CO Line Access..... 200-I 6	•	•	•	•	•	N
<b>M</b>						
Meet Me Page ..... 200-I 6	•	•	•	•	•	N
Message Waiting..... 200-I 6	•	•	•	•	•	N
Message Waiting Reminder Tone ..... 200-I 6	•	•	•	•	•	N

N=No additional hardware required



**Table 200-I Key Station Features/Software Packages**

FEATURE	STANDARD FEATURES	ENHANCED FEATURES	CALL PROCESSING FEATURES	NETWORK & TRUNKING	COMBINATION PKG	ADDITIONAL EQUIPMENT REQUIRED
Messages - Personalized ..... 200-17	.	•	•	•	•	N
Custom Messages ..... 200-17	•	•	•	•	•	N
Date and Time Entry Personalized						
Message(s) ..... 200-17	a	•	•	•	•	N
--Message Code on a Flex Key ..... 200-17	•	•	•	•	•	N
Music On Hold ... 2 ..... 0 ..... 0 ..... 1 ..... 7	•	•	•	•	•	Music Source
Mute Key ..... 200-17	•	•	•	•	•	N
N						
Name in Display . 0 ..... 0 ..... 1 ..... 7	•	•	•	•	•	Exec Keypad
Night Service Feature ..... 200-17	•	•	•	•	•	N
Night Service Mode ..... 200-17	4	•	•	•	•	N
Automatic Night Mode Operation ..... 200-17	•	•	•	•	•	N
External Night Ringing ..... 0 ..... 1 ..... 7	•	•	•	•	•	N
Manual Operation ..... 200-17	•	•	•	•	•	N
Night Class of Service ..... 200-17	•	•	•	•	•	N
Night Ringing Assignments ..... 0 ..... 1 ..... 7	•	•	•	•	•	N
Universal Night Answer (UNA) ..... 200-18	•	•	•	•	•	N
Weekly Night Mode Schedule ..... 200-18	•	•	•	•	•	N
0						
Off Hook Voice Over (OHVO) ..... 200-18		•	•	•	•	OHVO Keypad
Off-Hook Preference ..... 200-18	•	•	•	•	•	N
Auto Feature Access ..... 200-18	•	•	•	•	•	N
Auto Line Access ..... 200-18	•	•	•	•	•	N
Hot Line/Ring Down ..... 200-18	•	•	•	•	•	N
Intercom Access ..... 200-18	•	•	•	•	•	N
User Programmable Preference ..... 200-18	•	•	•	•	•	N
Off-Hook Signalling ..... 200-18	•	•	•	•	•	N
Off-Premise Extensions (OPX) ..... 200-18	•	•	•	•	•	SLA/OPX/48v

N=No additional hardware required

Table 200-1 Key Station Features/Software Packages

FEATURE	STANDARD FEATURES	ENHANCED FEATURES	CALL PROCESSING FEATURES	NETWORK & TRUNKING	COMBINATION PKG	ADDITIONAL EQUIPMENT REQUIRED
On Hook Dialing	•	•	•	•	•	N
On Line Programming	•	•	•	•	•	N
<b>P</b>						
Page/Relay Control	•	•	•	•	•	Relay/Sensor unit
Paging	•	•	•	•	•	Paging Equipment
External Paging	•	•	•	•	•	Paging Equipment
Internal Paging	•	•	•	•	•	Paging Equipment
Paging Access Restriction	•	•	•	•	•	N
Pause Timer	•	•	•	•	•	N
PBX Dialing Codes	•	•	•	•	•	N
Pool Button Operation	•	•	•	•	•	N
Preferred Line Answer	•	•	•	•	•	N
Privacy Release	•	•	•	•	•	N
Per CO Line Option	•	•	•	•	•	N
Per Station Option	•	•	•	•	•	N
Private Line	•	•	•	•	•	N
Pulse-To-Tone Switchover	•	•	•	•	•	N
<b>R</b>						
Range Programming	•	•	•	•	•	N
Release Key	•	•	•	•	•	N
Remote Administration	•	•	•	•	•	PC/Term/Modem
Database Upload/Download	•	•	•	•	•	PC/Term/Modem
Remote System Monitor & Maintenance	•	•	•	•	•	PC/Term/Modem
Remote System Maintenance	•	•	•	•	•	PC/Term/Modem
Remote System Monitor	•	•	•	•	•	PC/Term/Modem
<b>S</b>						
Save Number Redial (SNR)	•	•	•	•	•	N

N=No additional hardware required

**Table 200-I Key Station Features/Software Packages**

FEATURE	STANDARD FEATURES	ENHANCED FEATURES	CALL PROCESSING FEATURES	NETWORK & TRUNKING	COMBINATION PKG	ADDITIONAL EQUIPMENT REQUIRED
<b>S</b> Single Line Telephone (SLT) Compatibility* ..... 200-21 *A Single Line Telephone board (SL12), or Single Line Adapter (OPX) w/48v supply can be used for SLT operations		●	●	●	0	2500 type
Speakerphone ..... 200-21	●	●	0	0	0	34-Btn/14-Btn
Station Class of Service (COS) ..... 200-21	0	0	0	0	0	N
Station Message Detailed Recording ..... 200-21		0	●	0	0	Printer/Terminal
Station Relocation Feature ..... 200-21	0	●	0	0	●	N
Station Speed Dial ..... 200-21	0	0	●	0	□	N
System ..... 200-21	0	0	0	0	□	N
System Configuration ..... 200-21	0	0	0	0	□	N
System Hold ..... 200-21	0	0	●	0	□	N
System Speed Dial ..... 200-21	0	●	0	0	□	N
<b>T</b> Text Messaging (Silent Response) ..... 200-21	0	0	0	0	□	Exec Keyset
Toll Restriction (Table Driven) ..... 200-22	●	□	□	□	□	N
Transfer Recall ..... 200-22	0	0	0	0	□	N
<b>U</b> Uniform Call Distribution (UCD) ..... 200-22	●	□	●	□	□	N
Agent Queue Status Display ..... 200-22	0	0	0	0	□	N
Alternate UCD Group Assignments ..... 200-22	0	0	0	0	□	N
Auto Wrap-Up w/Timer ..... 200-22	0	0	●	0	□	N
Available/Unavailable Mode ..... 200-22	●	0	0	0	□	N
Incoming CO Direct Ringing ..... 200-22	0	0	●	0	□	N
No-Answer Recall Timer ..... 200-22	0	0	0	0	□	N
No-Answer Retry Timer ..... 200-22	●	0	0	●	□	N
Overflow Station Assignments ..... 200-22	●	●	●	●	●	N
Recorded Announcements (RAN) ..... 200-22	●	●	●	●	□	RAN Device(s)
Universal Night Answer (UNA) ..... 200-23	●	●	●	●	□	N

N=No additional hardware required

Table 200-1 Key Station Features/Software Packages

FEATURE	STANDARD FEATURES	ENHANCED FEATURES	CALL PROCESSING FEATURES	NETWORK & TRUNKING	COMBINATION PKG	ADDITIONAL EQUIPMENT REQUIRED
<b>V</b> Voice Mail Groups (VM) .....		•	•	•	•	VM System
In-Band Signaling Integration .....		•	•	•	•	VM System
Message Waiting Indication .....		•	•	•	•	VM System
Tone Mode Calling Option .....		•	•	•	•	VM System
Transfer/Forward .....		•	•	•	•	VM System
VM Disconnect Signal .....		•	•	•	•	VM System
VM Transfer with ID Digits .....		•	•	•	•	VM System
Volume Controls .....	•	■	•	•	•	N

N=No additional hardware required

## SECTION 200

# KEY STATION FEATURE DESCRIPTION

The System and Key Station features of the Starplus Digital Key Telephone System are listed and described below in alphabetical order. An abbreviated feature index is provided in Table 200-I Key Station Features/Software Packages.

### 200.1 ACCOUNT CODES

*This feature is available with optional software.*

An account code is the last field within Station Message Detail Recording (SMDR), that provides the ability to track specific calls by entering a non-verified, variable length (up to 12-digits) identifier. The use of forced Account Codes is optional, offered on a system wide basis. SMDR must be enabled in order for the account code to be included as part of the SMDR record.

### 200.2 ATTENDANT RECALL

When a line has been left on hold for a programmable period of time, the station placing that line on hold will be recalled. If that station fails to answer the recall, the call will be recalled to the attendant(s) for handling. There can be three attendants per system. Transferred, Parked and Camp-on recalls will also recall the Attendant.

### 200.3 AUTOMATIC CALL BACK TIMER

To accommodate the reduced number of buttons on the Starplus Basic keyset, an automatic call back feature has been implemented. This feature will invoke a call back anytime a user listens to busy tone for a preset period of time. By default, this timer is disabled and is variable from 00 to 99 seconds.

### 200.4 AUTOMATIC CALL DISTRIBUTION (ACD)

*This feature is available with optional software.*

When purchased, Uniform Call Distribution (UCD) is not used and is replaced by the ACD functions identified in the following. 16 Automatic Call Distribution (ACD) groups can be programmed, each containing up to 16 three-digit station numbers (up to the system station maximum). Each group is assigned a pilot number. When this number is dialed, the first available agent in that group is rung. Calls are routed to the station that has been on-hook for the longest period of time.

#### A. Agent Positions

- Agent Login/Logout w/Agent ID Feature: The Agent Login/Logout Feature provides a means for an agent to log into one of the

ACD groups and receive calls. The Agent ID entered in the login process identifies the agent and places that agent in the available agent list for the ACD group specified in the login process. This feature allows an agent to log into any ACD group from any station in the system and receive calls.

- Agent Identification: Each ACD Agent has a unique Agent ID code (0000-9999) which he uses during login and logout procedures. This unique ID code is not verified or stored as part of the system database.
- Agent Available/Unavailable Mode: Stations programmed into a ACD group may remove themselves from their assigned ACD group by dialing the Available/Unavailable code. When an agent is in the Available mode, that agent will receive ACD calls in the normal manner. When an agent is in the Unavailable mode, that agent will no longer receive ACD type calls, however he may receive non-ACD calls. Agents that have gone Unavailable will receive a visual reminder with a flashing LED and or a LCD display message.
- Agent Help Request: The HELP feature provides a means for an ACD agent to signal his assigned supervisor for assistance. The agent while on a call can press the HELP button to signal the assigned supervisor. The supervisor may respond by use of his HELP button and his ACD Barge-In feature.
- Agent Call Qualification: This feature provides a means for an agent to enter codes on ACD type calls that identify the call. This feature will permit up to 12-digits to be entered, however, only the first four digits are provided for in the SMDR record. A programmable confirmation tone option has been added to the Agent Call Qualification feature on a system-wide basis.

#### B. Alternate ACD Group Assignments

An alternate ACD group can be programmed so that if stations in one group are busy, the alternate group will be checked for an available station.

**KEY STATION FEATURE DESCRIPTION****C. Group Member Status**

The Supervisors Group Member Status feature provides a means for an ACD supervisor to view the status of each of the 16 ACD groups in the system individually. This display will tell the supervisor which stations are logged into the group, and if the station logged in is available, unavailable, out of service, in DND, or busy on a call. The supervisor can use this display to determine why there are a lot of queued calls in a specific group.

**D. Incoming CO Direct Ringing**

CO Lines can be programmed to ring directly into a ACD group. When all agents are busy and RAN is enabled, the system will answer the caller and present the 1 st RAN announcement automatically.

**E. No-Answer Recall Timer**

if a call routed to a station via ACD is not answered by the ACD Agent/Station before the No-Answer Recall timer expires, the call will be returned to ACD Queue with the highest priority. In addition, the station that failed to answer the ringing ACD call will be placed into an out of service (OOS) state.

**F. No-Answer Retry Timer**

When the No-Answer Recall timer expires, a station that failed to answer the ringing ACD call is placed into an out-of-service (OOS) state. The station that was taken out-of-service (OOS) will be placed back in service if the agent hits his available flex button or dials the available flex code. In addition, the agent will be placed back in service if the No-Answer Retry timer expires. If the agent does not answer his next ACD call, he will again be taken out-of-service. This cycle will continue until the station answers calls, logs out, or goes unavailable.

**G. Overflow Station Assignments**

An overflow station may be assigned to route callers in queue to a designated station after a specified time. The Overflow station may remove themselves from their assigned group by dialing the Overflow Available/Unavailable code. When the Overflow station is in the available mode, that station will receive ACD calls in the normal manner. When the Overflow station is in the Unavailable mode, that station will no longer receive ACD type calls, however they may receive non-ACD calls. The Overflow station that has gone Unavailable will receive a visual reminder with a flashing LED and/or an LCD display message. The overflow station may NOT be one of the ACD group stations.

**NOTE** *if no stations are logged into the ACD Group, ACD calls will overflow to the Attendant station.*

**H. Recorded Announcements (RAN)**

Recorded announcement devices can be assigned to provide up to eight different messages per system, if all stations in a ACD group are busy. The eight messages are available to all 16 ACD groups in different configurations with a maximum of 2 per group. A RAN device can provide an announcement to one caller at a time. Subsequent callers will be queued onto the message on a first-in basis.

**I. Guaranteed Message Announcement**

This feature provides a means to force incoming callers to an announcement before being placed into an ACD Queue or routed to an agent. The outside callers are presented with the entire message before being routed to the ACD Group. Agents in an ACD Group with a Guaranteed Message enabled will receive incoming callers only after the caller has heard the designated recorded announcement in its entirety.

**J. Supervisor Positions**

- Supervisor Login/Logout Feature: The Supervisor Login/Logout Feature will provide a means for a supervisor to log into one of the ACD groups. The Supervisor ID entered in the login process identifies the supervisor for the specific ACD group he is assigned to. This feature will allow a supervisor to log into any ACD group from any station in the system. However, to have the supervisor monitor with barge-in feature, the supervisor must log in at a station with monitor barge-in capability.
- Supervisor Identification: Each ACD Supervisor has a unique Supervisor ID code (0000-9999) which he uses during login and logout procedures. This unique ID code is not verified or stored as part of the system database.
- Supervisor Help Request: The HELP feature provides a means for an ACD agent to signal his assigned supervisor-for assistance. The agent while on a call can press the HELP button to signal the assigned supervisor. The supervisor may respond by use of his HELP button and his ACD Barge-In feature.
- Supervisor Monitor w/Barge-In Feature: The ACD Supervisor Monitor with Barge-In feature provides a means for an ACD supervisor to monitor an agent's call in pro-



gress in order to coach sales techniques or customer relations skills. When used, a supervisor may intrude onto an agent's call in a listen only mode or in a true conference mode. This feature is available with or without a warning tone.

**NOTE**

*The use of silent monitor and barge-in is limited by federal law and may also be limited or prohibited by state or local law, so check the relevant laws in your area before employing these features.*

- Supervisor Station Assignment Feature: The ACD Supervisor Station Assignment feature provides a means to assign each ACD group a supervisor. This supervisor station can receive the calls in queue display in real time, receives No Answer/Out of Service, receives "HELP" displays from the groups that the supervisor is assigned to and can barge in on active calls in his ACD group or groups.

**K. Supervisor/Agent Calls in Queue Display**

This feature provides a means for an agent and ACD supervisor to view the status of their ACD group. This display is an idle state display and will prompt a supervisor that his agents in the group are having problems answering all their calls. The display will tell the agent and his supervisor how many calls are in queue, how many agents are logged into the ACD group, and the length of time in minutes that the oldest call has been in queue.

**L. ACD Event Trace**

The ACD Event Trace provides a series of events trace output which would provide input to a customer-developed ACD Reporting package.

**200.5 AUTOMATIC LINE ACCESS**

Each station, key or SLT, may have their phone programmed to access a particular CO Line such as a private line or a line from a Group of CO lines upon going off-hook. This is useful in Centrex or PBX applications when station users have dedicated or individual lines. Outside line dial tone is received just by going off-hook, without the need to dial an access code.

**200.6 AUTOMATIC NIGHT SERVICE**

The system may optionally be programmed to go into and out-of night service automatically. This method does not require the attendant to activate or deactivate night service on a daily basis. The automatic night service is enabled and disabled on a programmable daily schedule including Saturday and Sunday schedules. A time can be set to enable Night

Service and to Disable Night Service on a per day basis.

**200.7 AUTOMATIC PAUSE INSERTION WITH SPEED DIAL**

If a flash command is placed into system speed dial numbers or station speed dial numbers, a pause will automatically be inserted after the flash. A pause will also be automatically inserted after a PBX dialing code has been used. Manually dialing a flash during a call will cause only those numbers dialed after the flash to be redialed for a Last Number re-dialed number or for a Save Number re-dialed number.

**200.8 AUTOMATIC PRIVACY**

Privacy is automatically provided on all calls. If one station is conversing, another station cannot intrude on that line. The Automatic Privacy feature can be disabled, allowing one other station to join in on existing CO line conversations.

**NOTE**

*Disabling of the privacy feature may be limited by federal, state or local law, so check the relevant laws in your area before disabling privacy.*

**200.9 AUTOMATIC SELECTION**

The user can select an outside line, intercom station, speed dial button, or dial a feature and automatically place the phone in the dialing mode without pressing the ON/OFF button or lifting the handset.

**200.10 BACKGROUND MUSIC**

Each Digital Terminal user may receive music over their speaker when an optional music source is connected to the system. This feature can be allowed or denied on a system-wide basis by programming.

**200.11 BATTERY BACK-UP (MEMORY)**

A NICAD battery is located on the Central Processing Unit (CPU) of the Starplus SPD 4896 system to protect system memory in case of commercial power outage or the system power being turned off for a period of time. Battery Back-up Memory retains all system features including both system and station speed dial during a power outage.

**200.12 BUSY LAMP FIELD (BLF)**

When a button on a Digital Terminal is assigned as a DSS, it also serves as a Busy Lamp Field to display the status of that telephone.

**200.13 CALL ANNOUNCE - PRIVACY**

Each telephone user can set their intercom signaling switch to receive intercom call announcements without having the calling party hear any conversations in progress.

**KEY STATION FEATURE DESCRIPTION****200.14 CALL BACK**

A station can initiate a call back request to another busy station. As soon as that station becomes idle, the station that left the call back request is signaled.

**200.15 CALL COST DISPLAY FEATURE**

*This feature is available with optional software.*

The Call Cost Display Feature allows a user to view the approximate cost of each call made. This approximate cost will also be printed as part of the SMDR record.

The Call Cost Display will replace the call duration display when a call is made using LCR. This display is enabled in programming.

The cost information is programmable by selecting one of the 16 route list tables and one of the four time periods. This allows the user to program four separate costs based on the time of day for each of 16 routes. The costs entered in the tables will be a cost for one minute, however, costs are calculated using a 1/10th of a minute value. These costs are rounded down and are based on the start time of the call, even if the call extends into a different time period. The SMDR printout will contain a cost calculated using a 1/10th of a minute increment and the display will update approximately every 30 seconds. The user must have LCR enabled to get the call cost display.

**200.16 CALL FORWARD: PRESET**

This feature allows the system database to be configured so that incoming CO Lines, which are programmed to ring at a particular station, can be forwarded elsewhere in the system predetermined by programming. This feature is active if the station ringing is not answered in a specified time. This is particularly useful in "overflow" applications where a Voice Mail or Auto Attendant may be in use.

- A station may have one designated preset forward location defined in the database.
- Preset Call Forward is chainable only to other predetermined preset forward stations specified in the database up to a chain of 5 stations.
- Chainable Preset Call Forwarding will force the incoming CO Line to ring at each station preassigned in the database for the Preset Forward Ring Timer specified in the database before forwarding.
- Each station in the system may, independently, have incoming CO calls preset forwarded to the following destinations:

**A. Preset Call Forward - ACD Groups**

CO Lines can be preset forwarded to ring into a ACD Group from any station. A CO line will

not preset forward to a busy ACD group, however each time the preset forward timer expires (for a total of five attempts) the group will be checked for an idle station. If a member of the group is idle the call will then be presented to that member.

**B. Preset Call Forward - Hunt Groups**

CO Lines can be preset forwarded to ring into a Hunt Group from any station. A CO line will not preset forward to a busy Hunt group, however each time the preset forward timer expires (for a total of five attempts) the group will be checked for an idle station. If a member of the group is idle the call will then be presented to that member.

**C. Preset Call Forward - Off-Net**

CO Lines can be preset forwarded to ring Off-Net via speed dial from any station. After the expiration of the preset forward timer, the system will select an idle CO line and dial the off-net location, then connect the two CO lines.

**D. Preset Call Forward - Stations**

Each Digital Terminal user may have preset in the database Initial Ringing Incoming to be directed to another station in the system, if the call goes unanswered for a predetermined amount of time.

**E. Preset Call Forward -UCD Groups**

CO Lines can be preset forwarded to ring into a UCD Group from any station. A CO line will not preset forward to a busy UCD group, however each time the preset forward timer expires (for a total of five attempts) the group will be checked for an idle station. If a member of the group is idle the call will then be presented to that member.

**F. Preset Call Forward - YM Groups**

CO Lines can be preset forwarded to ring into a Voice Mail Group from any station. A CO line will not preset forward to a busy Voice Mail group, however each time the preset forward timer expires (for a total of five attempts) the group will be checked for an idle Voice Mail port. If a VM port is idle the call will then be presented to Voice Mail.

**NOTE** *Calls will forward only if they ring nowhere else.*

**200.17 CALL FORWARD: STATION****A. Call Forward - All Calls**

This feature allows a station the ability to have all their calls (internal or external) forwarded immediately to a designated station, an ACD or

UCD group pilot number, Voice Mail group number, or Hunt group. (See Note)

### B. Call Forward - Busy

This feature allows a station the ability to have their calls forwarded to a designated station, an ACD or UCD group pilot number, Voice Mail group number, or Hunt group when their station is busy. (See Note)

### C. Call Forward - Busy/No Answer

Allows a stations the ability to forward a combination busy/no answer calls to a designated station, an ACD or UCD group pilot number, Voice Mail group number, or Hunt group. No answer calls forward when the system-wide "no answer timer" expires. initial CO ringing, transferred CO ringing and intercom ringing calls can all be forwarded. Calls that ring to an idle station will be call forwarded after expiration of the No Answer ring timer.(See Note)

### D. Call Forward - No Answer

This feature allows a station the ability to have their calls forwarded to a designated station, an ACD or UCD group pilot number, Voice Mail group number or Hunt group number when there is no answer at the station. No answer calls forward when the system-wide "no answer timer" expires. (See Note)

### E. Call Forward - Off-Net

Stations will be allowed to forward intercom and transferred CO line calls to an off-net location. This allows a station to reroute calls that would normally be lost. Calls can be forwarded to home or another off-net site. Initially ringing CO calls cannot be forwarded with this feature (see Incoming CO lines Off-Net Forward feature).

#### NOTE

*Initial Ringing Incoming calls will forward to groups, (i.e.: ACD, UCD, Voice Mail, Hunt) if the station forwarded is the only station assigned to ring on the CO line.*

### 200.18 CALL PARK

An outside line can be placed into one of eight parking locations and can be retrieved by any station that has a direct line appearance or an available loop button. Parked calls have their own recall timer and will recall the originating station and if still unanswered, the attendant(s).

### 200.19 CALL PICK-UP:

#### A. Directed Call Pick-up

A station can pick up an intercom call, transferred, incoming, or recalling outside line call to a specific unattended station. The call must be a tone ringing call.

### B. Group Pick-up

Stations can be placed in one or more of four pick-up groups. Stations within a group can pick up tone ringing intercom calls, transferred, incoming, or recalling outside line calls for another station in that group.

#### NOTE

*By default, all Voice Mail stations are placed in Pickup Group 1. You may need to change this default setting.*

### 200.20 CALL TRANSFER

An outside CO line can be transferred from one keyset to another. By using the TRANS button, screened (announced) or unscreened transfers can be made. The line being transferred rings on the keyset and provides Exclusive Hold flashing indication to the receiving party's keyset. Any number of attempts can be made to locate someone by calling different keysets without losing the call. If a line is transferred to a busy station, it will receive muted ringing.

### 200.21 CALLER ENTERED ICLID DIGITS

*This feature is available with optional software.*

The Guaranteed Message announcement feature provides a means to force incoming callers to an announcement before being placed into an ACD Queue or routed to an agent. The outside callers are presented with the entire message before being routed to the ACD Group. Agents in an ACD Group with a Guaranteed Message enabled will receive incoming callers only after the caller has heard the designated recorded announcement in its entirety.

In addition, the Guaranteed Message feature provides an option to capture digits dialed by the incoming caller which can be inserted as ICLID incoming number identification.

If the Guaranteed Message announcement is programmed in Admin, incoming ACD calls will be routed to the Guaranteed Message RAN before going to the ACD Group. If the ICLID option is selected, digits received before the announcement time-out will be captured and inserted as incoming ICLID number information. When the ICLID option is selected, a [#] will be recognized as a termination of the announcement and a [\*] will be recognized as an entry error. An entry error will cause the ICLID number to be removed and the incoming caller can re-enter his phone number.

### 200.22 CALLING STATION TONE MODE OPTION

This feature will provide an easy means for a Calling station to override a desired stations "H" (handsfree) or "P" (call announce) intercom switch setting. A dial

**KEY STATION FEATURE DESCRIPTION**

code has been added that is dialed in front of the extension number to force the tone ringing.

**200.23 CAMP-ON**

A station may alert a busy party that an outside line is on hold and waiting for them by using the **CAMP-ON** button. To camp on a call, press the **TRANS** button to transfer the call to the desired busy station, then press the **CAMP ON** button. The busy party will receive a muted ring over the **keyset** speaker, and a visual flashing **CAMP ON LED**. By pressing the **CAMP ON** button, the person called places his existing outside call on hold and is connected to the person placing the Camp On. He can then pick up the call on the appropriate line. Calls cannot be camped on when a station is in **DND** or in **Conference**.

**200.24 CAMP-ON RECALL**

When a station does not answer a Camp On, that call will recall the person placing the Camp On, and if unanswered by them, will recall the attendant(s).

**200.25 CANNED TOLL RESTRICTION**

The system provides an easy means of applying the most common form of toll restriction where 1+ and 0+ along with 976, 555, and 411 type of calls are denied and 1-800, 911, 1-911, and I-611 type of calls are allowed. This canned toll restriction is applied through the use of a single pre-built Class-of-Service and can be assigned to stations using range programming.

**200.26 CENTREXCOMPATIBILITY**

The Star-plus Digital Key Telephone System provides features that are **Centrex** compatible so that **Centrex** users can utilize the Starplus Digital Key Telephone System to enhance their **Centrex** capabilities. The system actually simplifies and provides easier access to many **Centrex** features by offering the following features:

**A. Flex Button Programming**

Flexible button programming allows **Centrex** users to program complex **Centrex** dial codes onto a **keyset** button for easy one touch access to **Centrex** features.

**B. Off-Hook Preference**

Both Digital Terminals and Single line telephones may be programmed to have their personal **Centrex** line accessed automatically just by lifting the handset or pressing the **ON/ OFF** button. Internal features to the Starplus Digital Key Telephone System are still made available to Digital Terminals by accessing intercom before going off-hook.

**C. Private Line Appearance**

The **Starplus** Digital Key Telephone System allows for private line assignment on an unlimited basis. Each station may have sole access to a particular outside line if desired and may also be assigned to receive incoming ringing on that line.

**D. Programmable Flash Timer**

**CO** line flash is a momentary opening on a **CO** line used for signaling. When using the **Starplus** Digital Key Telephone System in a **Centrex** environment the **CO** line flash is to signal the intention to transfer a caller using **Centrex** transfer. The **CO** line flash timer is programmable on a per **CO** line bases to facilitate a mixture of **Centrex** and **CO** lines within the same system.

**E. Programming “\*”, “#”, and Hook-Flashes into Speed Dial**

Many **Centrex** codes utilize a hook-flash followed by in many cases the digit [\*] and or [#]. The **Starplus** Digital Key Telephone System allows these codes to be programmed as a pan of system or station speed dial sequences.

**200.27 CENTREX/PBXTRANSFER**

When **Centrex** or **PBX** lines are connected to the **Starplus** Digital Key Telephone System, users may, by using the **Flash** button, transfer callers to other **Centrex** or **PBX** extensions. Additionally, the **Flash** command may be included within a **Speed Bin** and programmed onto a **flex** button for one button transfer.

**200.28 CHAINING SPEED BINS**

**Speed dial** bins may be chained together by simply pressing one **speed bin**, then another and another as required.

This is helpful for accessing **Long Distance** carriers or **banking** services when **account codes** may be required.

**200.29 CO LINE ACCESS**

Through programming, telephones are allowed or denied access to particular outside lines or line groups.

**200.30 CO LINE CLASS OF SERVICE**

Each **CO** Line may be programmed with a **Class-of-Service** to provide dialing privileges. The **Starplus** Digital Key Telephone System uses an array between **CO** Line **Class-of-Service** and **Station Class-Of-Service** to offer a wide variety of dialing privilege possibilities.

**200.31 CO LINE CONTROL (CONTACT)**

On the Starplus SPD 4896 system, there are 12 control contacts which may be individually programmed as either CO Line Control (to control ancillary equipment) or Loud Bell Control to control a customer provided ringing device to external areas. When programmed as CO Line Control and assigned to a CO line, the corresponding contact will close whenever that CO line is accessed by a station. Since no "on-board" relay contacts are available on the Starplus SPD 4896 system for CO Line Control, the Relay/Sensor Interface module is used for this purpose.

**200.32 CO LINE GROUPS**

Outside lines can be placed in one of eight groups if the customer's business requires such grouping. Stations are then individually assigned access to these groups and given the ability to dial on particular lines.

**200.33 CO LINE IDENTIFICATION**

This feature allows a name to be entered into the database programming for each individual line (trunk) connected to the system. The name may be entered in any combination up to **12-characters in length** (this will represent **24-digits** entered). Once entered, LCD digital terminals including the attendant station(s) will receive the programmed line "name" in place of the default "LINE XX" message. This applies to all line call processing conditions where the current "LINE XX" message appears.

SMDR will continue to print out the line number in place of the programmed name. If the line name has not been programmed, then the current "LINE XX" display will be used as the default. A programmable data field is available for each line in the system.

**NOTE** *This feature is for LCD Display appearance only!*

**200.34 CO LINE INCOMING RINGING ASSIGNMENT**

Each CO line may be programmed (in database admin) so that incoming ringing on the specified CO line(s) may be assigned initial ringing to one of the following destinations:

- one or more stations (Keypad or SLT)
- To an ACD, UCD, Voice Mail or Hunt Group
- Off-Net (via Speed Dial)

The ring-in will follow Day Ring assignments unless Night Service mode is active, in which case all incoming CO calls will follow Night Ring assignments.

When ringing is assigned to a **keyset**, a direct line appearance or an idle Loop button must be available to receive the call. Station call forwarding of initial

ringing CO call is possible and can be directed to other **keysets** with an available Loop button or direct appearance.

If the initially ringing CO call cannot ring at the destination assigned, it will ring at the first Attendant station.

**NOTE**

**You cannot Station Call Forward an initially ringing CO call to ACD, UCD, Voice Mail, or Hunt groups if the line is assigned to ring at more than one station.**

**200.35 CO LINE LOOP SUPERVISION**

The Starplus Digital Key Telephone System can be programmed to monitor CO lines while on-hold or connected to RAN devices or Voice Mail systems or in Trunk-to-Trunk connections for disconnect signal provided by the Telco.

After a disconnect signal is detected, the Starplus Digital Key Telephone System will release the CO lines and automatically place them back in service.

**200.36 CO LINE QUEUE**

When all the outside lines in a group are busy, stations can be placed in queue awaiting a line in the same group to become available. If a station doesn't answer the queue signal within 15 seconds, that station is dropped from the queue.

**200.37 CO LINE RINGING OPTIONS**

When a CO call rings at a busy station, the call rings at the station using a muted ring signal. This option allows a user to receive a reminder ring at his busy station, instead of muted ringing. In addition, a reminder ring timer has been added to the system to provide the reminder ring every time the timer expires, as long as the incoming CO line remains connected. The system defaults this option to muted ringing.

**200.38 CO RING DETECT**

The duration of the ringing signal from the CO or the PBX is matched with ringing detection circuitry in the KSU. The ring detect can range from 200 to 900 msec, programmed in 100 msec increments. This timer helps prevent false ringing.

**200.39 CONFERENCE ---**

There are three different types of conferencing:

**A. Add On Conference**

Up to five internal parties can engage in a conference, or four internal parties with a limit of one external party.

**B. Multi-Line Conference**

One internal station can engage in a conference with two outside parties.

**KEY STATION FEATURE DESCRIPTION****C. Unsupervised Conference**

The conference initiator can exit a conference with two outside parties and leave them in an unsupervised conference. The initiator can re-enter the conference at any time. The **Starplus** Digital Key Telephone System can automatically terminate the call when both parties hang up, when Loop Supervision is provided by the **telco** and enabled in the database.

A programmable conference timer will disconnect the unsupervised conference if the initiator does not re-enter.

**200.40 CONFERENCE ENABLE/DISABLE**

This feature will allow the system conference feature to be administered on a per station basis for the ability of a station to initiate a conference.

**200.41 DATA FEATURE**

The Data Feature offers the ability to transmit data information between personal computers, printers, plotters, modems, CRT terminals, and main frame computer ports. To establish a data call, a Digital Data Interface Unit (DDIU) is required to be connected to each data communications device. The Digital Data Interface Unit (DDIU) allows any serial data communications device (which conforms to RS-232C) to be connected to the **Starplus** Digital system. This requires a station port.

**200.42 DATABASE PRINTOUT (DUMP)**

Through a system programming command, either portions of or a complete database dump can be printed using the RS-232C connector located on the Central Processing Unit (CPU) on the **Starplus** Digital Key Telephone System.

**200.43 DATABASE UPLOAD/DOWNLOAD**

DataBase Upload/Download feature provides a maintenance facility which has been added to the Remote Administration routine. This routine will permit the database to be downloaded to a PC, when a software change is made or when the system needs to be initialized and re-programmed. In addition, the routine will facilitate the programming of a database on an in-house system which can be downloaded to a PC and then uploaded to a system in the field. After the system maintenance is completed, the file saved in the PC can then be uploaded to the system.

**200.44 DAY/NIGHT CLASS OF SERVICE (COS)**

This feature allows stations that are a certain COS during the day, to be assigned a different COS when the system is put in the night mode. The night COS goes into affect when the system is placed into the

night mode, manually or automatically. This prevents the misuse of phones after hours.

**200.46 DEFAULT BUTTON MAPPING**

The **Starplus** Digital Key Telephone System allows for 28 flexible buttons on each Enhanced or Executive Digital Terminals to be flexibly assigned to **CO/PBX** lines, DSS buttons, Speed Dial or Feature buttons. However, the system will power up with a default button mapping as shown in Figure 200-1 Executive **Keypad** Default Button Map . The **Starplus** Digital Key Telephone System also supports a Basic Digital Terminal with 6 fixed feature buttons, 8 flexible buttons, and speakerphone capability on intercom calls. This **keyset** provides the same functionality that the standard non-display **34-button keyset** provides. The Basic Digital Terminal default button map is shown in Figure 200-2 Basic **Keypad** Default Button Map.

**200.46 DIAL BY NAME**

The system will allow station users to dial extension numbers, or speed bins by entering the name of a person that has been programmed for that station. The system database will allow entry of a name (alphanumeric) up to 24 digits in length for each station. The programmed name can be used for dial-by-name station users and in directory dialing. This feature should not be confused with the Name In Display feature.

**200.47 DIAL PULSE SENDING**

Each CO interface circuit for outside lines can be programmed to send dial pulse or DTMF signals. Dialing speed and break/make ratios are programmable.

**200.48 DIALING PRIVILEGES**

The system provides a flexible means of providing toll or dialing restriction. Through the assignment of class of service (both station and outside line) many combinations of allow and deny numbers can be set. Both area and office codes can be screened for allow/deny privileges.

**200.49 DIRECT INWARD SYSTEM ACCESS (DISA)**

Allows an unlimited number of outside line calls to be programmed to provide direct access to the system and the use of features such as WATS lines, intercom dial tone or the ability to dial out on outgoing trunks without going through the attendant. The duration of a Trunk-to-Trunk DISA call can be set by the system administrator. DISA callers may also access LCR, All Internal/External paging, All Call paging, Call Park pick-up, and Meet-Me paging.

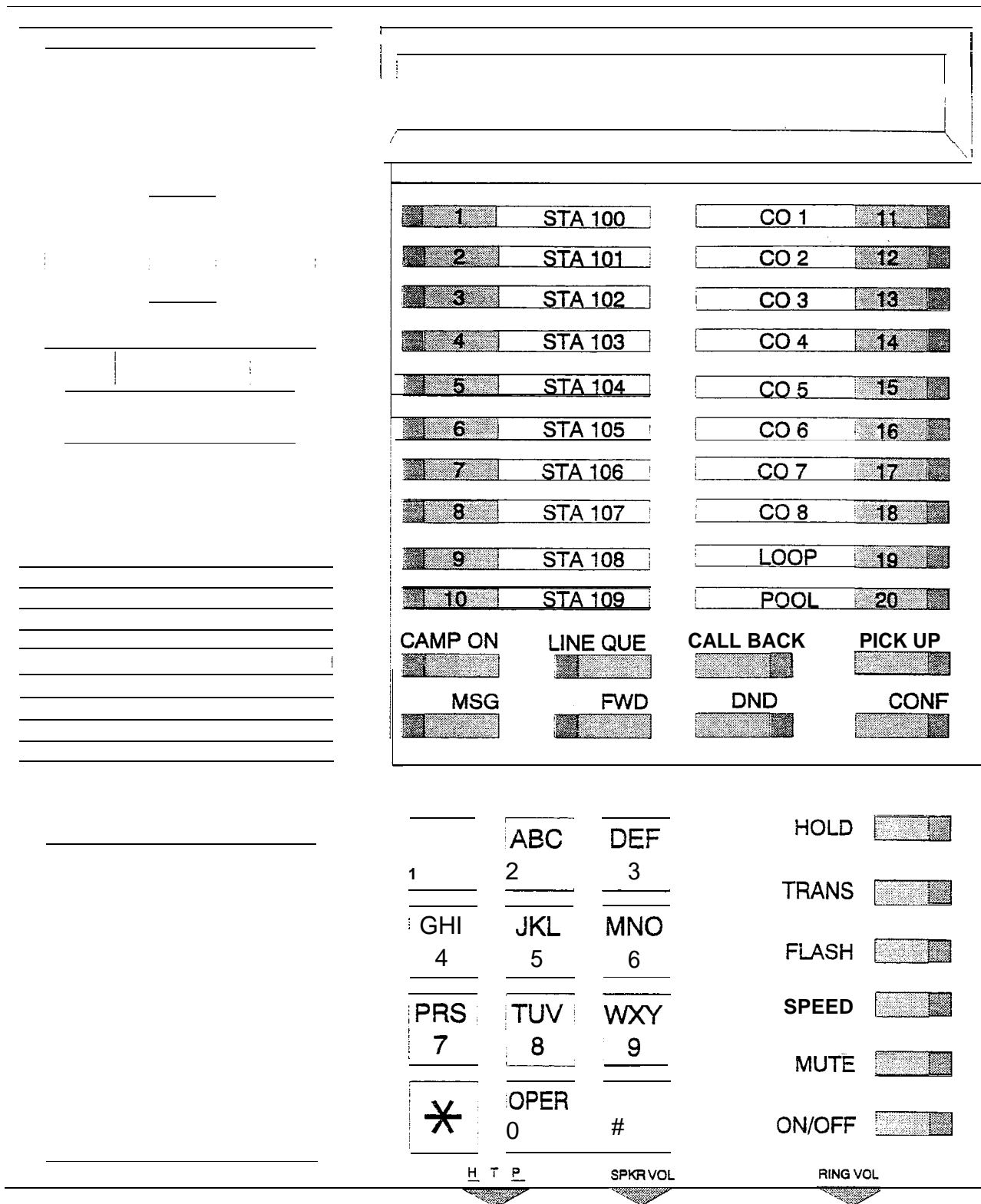

Figure 200-1 Executive Keypad Default Button Map

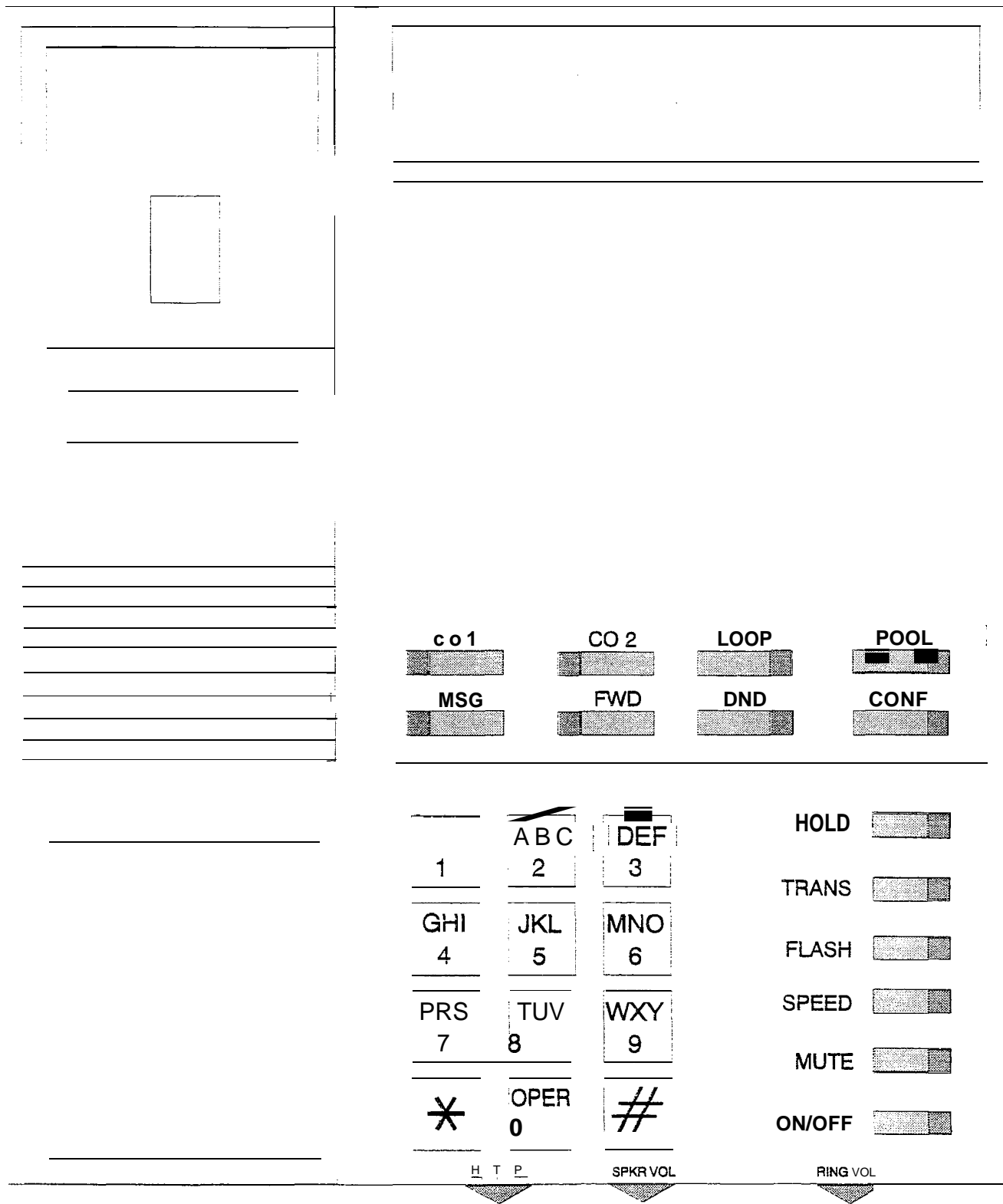

Figure 200-2 Basic Keypad Default Button Map



**A. CO Line Group Access**

Incoming DISA callers may access all line groups such as FX or WATS lines or other outgoing services from home or while away from the office.

**B. Programmable Access**

A three-digit security code can be assigned in the system database to restrict unwanted use of the DISA circuits. Each DISA line can be programmed independently for 24 hour DISA use or night DISA use only.

**C. Station Access**

DISA callers may dial any station directly without going thru the attendant.

If a DISA caller attempts to call a station that is busy or does not answer the system will return ICM dial tone at the end of a programmable timer (Preset Forward Timer). This will allow the DISA caller to try another station without having to dial into the system again.

**D. Trunk-to-Trunk:**

The DISA Trunk-to-Trunk (or Conference) option on the CO line governs a DISA callers ability to access other outside lines. CO lines must have DISA Trunk-to-Trunk enabled to allow a DISA caller to establish an outgoing trunk-to-trunk connection. This allows for specific CO line access restriction on DISA calls.

**E. DISA Call Forwarding:**

Two options provide a DISA line to be 24 hours or at night only, which converts the incoming DISA line to an incoming line with ringing assignments at the station number dialed.

The CO line ringing at a station will follow preset forward or no-answer call forward using the preset forward timer that same as an initially ringing CO line does. It will follow direct forward and busy forward the same as an initially ringing CO line. If the preset forward timer is set to 00 (disabled) the first forward of the DISA ringing call at a station will take 15 seconds.

**200.50 DIRECT STATION SELECTION**

The user with DSS buttons assigned at their Digital Terminal can call an intercom station by simply pressing the appropriate DSS button. The called station is automatically signaled.

**200.51 DIRECTED CALL PICK-UP****A. Call Pick-up - Station**

A station can pick up a tone-ringing intercom call, transferred, incoming, or recalling outside

line call to a specific unattended station. The call must be a tone ringing call.

**B. Call Pick-up - ACD/UCD Groups**

Stations outside of an ACD or UCD group can pick up a tone-ringing intercom call, transferred, incoming, or recalling outside line call ringing to a specific UCD station. The call must be a tone ringing call.

**200.52 DIRECTORY DIALING**

Directory dialing allows station users to obtain a directory of station users and have the system dial the extension that is currently on the display. The Starplus SPD 4896 system provides locations for up to 200 names.

Directory dialing also allows users to program a "name" along with a speed dial bin for use in later locating a speed dial number. When prompted to do so, the system will display the name associated with a speed dial number on the LCD display so that when the desired name is shown, the user may then have the system dial the number.

Directory dialing also allows users to associate a "name" with an entry in the local number/name translation table. When prompted to do so, the system will display the name associated with the table on the LCD display so that when the desired name is shown, the user may then have the system dial the number. The Starplus SPD 4896 system provides locations for up to 200 names.

**200.53 DISABLE OUTGOING CO LINE ACCESS**

This feature allows the first Attendant station to dial a code and disable a CO line from outgoing CO calls. This applies to all station(s) that have access to that line. Incoming status is not affected. This feature is a part of the "Maintenance" package.

**200.54 DISTINCTIVE RINGING (User Selectable)**

The tone ring signal, used to notify stations of an incoming call can be changed by each station user to provide distinctive ringing among a group of stations. Each station user may select a distinctive ringing tone that will be used to ring their station. The system provides 81 different ring patterns that the station users may select from.

**200.55 DO NOT DISTURB (DND)**

Placing a keyset in DND will eliminate incoming outside line ringing, intercom calls, transfers and paging announcements. A ringing station may go into DND to silence ringing. The attendant can override a station in DND. The station in DND can use the telephone to make normal outgoing calls. A

**KEY STATION FEATURE DESCRIPTION**

station can be denied this feature through programming.

**A. One-Time Do Not Disturb (DND)**

Allows a station user to turn off muted ringing that occurs while off hook (handset or ON/OFF) on another call. Useful when having an important conversation and do not wish to be disturbed by ringing. The station, while off hook, (ON/OFF or handset) depresses the DND button which eliminates muted ringing. When the station goes on-hook the DND button is extinguished and DND is canceled.

**200.56 DTMF SENDING**

Each CO interface circuit for outside lines can be individually programmed to send DTMF (tone) or dial pulse signals.

**200.57 EMERGENCY TRANSFER**

Each OPX box will provide power transfer to specified customer provided SLT's, or up to 12 CO lines using the Power Failure Transfer Unit (PFTU).

**200.58 END TO END SIGNALING**

This feature indicates the capability of the system to accept DTMF tones from stations, send them through the public network and have them received at the distant end for computer access, or a variety of control functions or inward call completion at a distant switching system.

**200.59 EXCLUSIVE HOLD**

When a line is placed on Exclusive Hold, no other station in the system can retrieve this call. Hold may be programmed to be activated on the first or second depression of the Hold button. CO Lines while in a transfer hold are always placed in an Exclusive Hold condition.

**200.60 EXECUTIVE OVERRIDE**

This feature allows certain stations to be designated as executive stations with the ability to "override" and "Barge in" on other keysets engaged in conversation on a CO line or intercom call.

In addition to the station programmable option, a system programmable option will enable or disable a warning tone when the station marked as an executive is cut-thru to the conversation. This is useful for an ACD agent supervisors or training personnel who require a service observing option.

A separate condition has been added to this feature which will allow or disallow an Executive to override an extension. This prevents an extension with override capability from overriding an Executive's station.

**CAUTION**

**USE OF THIS FEATURE WHEN THE EXECUTIVE OVERRIDE WARNING TONE IS DISABLED MAY BE INTERPRETED AS A VIOLATION OF FEDERAL OR STATE LAWS, AND AN INVASION OF PRIVACY. CONSULT COUNSEL WITH RESPECT TO APPLICABLE LAW BEFORE INTRUDING ON CALLS USING THIS FEATURE.**

**NOTE**

*A change in volume may occur on the CO line or intercom call after the barge-in occurs.*

**200.61 EXECUTIVE/SECRETARY TRANSFER**

There are four sets of Executive/ Secretary pairings available. When the Executive station is busy or in DND, the Secretary station will receive intercom calls and transfers. The Secretary station can signal the Executive in DND by using the Camp On feature.

**200.62 EXTERNAL NIGHT RINGING**

The system can be programmed so that CO lines marked for UNA will provide ringing out the external page ports when the system is placed into Night mode.

**200.63 FLASH**

Provides telephone users with the ability to terminate an outside call or transfer a call behind a PBX or Centrex and restore dial tone without hanging up the handset. A FLASH button is located on each Digital Terminal.

**200.64 FLASH ON INTERCOM**

This feature enables key station users to utilize the Flash Key to terminate pages and intercom calls. While connected to a page zone or another internal station pressing the Flash key will terminate the call and return intercom dial tone.

**200.65 FLASH RATES (Programmable)**

The flash rates for the following features can now be programmed to 16 different options in admin programming:

- Incoming CO line ringing: defaults to 30 ipm flash
- Incoming intercom ringing: defaults to 120 ipm flutter
- Call Forward: defaults to 30 ipm flash
- Message Waiting: defaults to 15 ipm flash

All other flash rates in the system are fixed at the rates shown in Table 400-I 3 DSS/BLF Button Visual Indicators, Table 400-14 CO Line Button Visual indicators, and Table 400-I 5 Function Button Visual Indicators.

**200.66 FLASH WITH SPEED DIAL**

A flash can be programmed within a speed dial number. When this is done, a pause will automat-

ically be inserted before the remaining speed dial digits are sent.

### 200.67 FLEXIBLE ATTENDANT

Any three Digital Terminals in the system can be assigned as attendant stations. These stations will receive recalls and can place the system into Night Service. The attendant stations must be either Enhanced or Executive stations.

### 200.68 FLEXIBLE BUTTON ASSIGNMENT

Each 34-button digital terminal has 28 flexible buttons which can be individually programmed. Each Basic Digital Terminal has 8 flexible buttons which can be individually programmed. One of the following operations can be selected for each button. Refer to Section 300.37, Flexible Button Assignment.

- Outside line: Automatically accesses assigned line. (Assigned in database)
- DSS/BLF: Automatically signal assigned station and provides BLF for off-hook and DND. (User programmable)
- Feature: Any feature with a dialing code (i.e.: Personalized Messages, Paging, Account Code, Call Park, Music, etc.) can be assigned to a flexible button. (User programmable)
- Group Access: (i.e. ACD, UCD, Hunt, Voice Mail group pilot numbers) (User programmable)
- Speed dial: Automatically dials a Speed number. (System, Station, Saved Number Redial, Last Number Redial) (User programmable)
- Pooled group access: Some or all outside lines can be grouped: pressing this button accesses the highest numbered unused **CO** line in that group. (Assigned in database)
- Loop: Used to answer a transferred call on a line for which a user does not have a button assigned. (Assigned in database)

### 200.69 FLEXIBLE PORT ASSIGNMENTS

The Flexible Port Assignment feature will provide a means to assign stations and CO line numbers to any station or CO line port in the system. This provides complete flexibility in determining station and CO line numbers within the system as long as they stay within the system numbering plan. Therefore a station can be assigned any number between 100 and 195 on the Starplus SPD 4896 system. A CO line can be assigned any number between 01 and 48 on the Starplus SPD 4896 system. This

restriction is required to minimize memory requirements on the smaller systems.

### 200.70 FORCED ACCOUNT CODES

*This feature is available with optional software.*

The Starplus Digital Key Telephone System allows the system to be arranged so that station users must enter an account code before placing an outside call. Account codes can also be used as a Traveling Class-of-Service to upgrade a restricted stations class-of-service for unrestricted dialing. Account codes must be entered before the call when forced.

### 200.71 FORCED LEAST COST ROUTING (LCR)

*This feature is available with optional software.*

The Starplus Digital Key Telephone System may be programmed on a per station basis to force the use of LCR for outgoing accessed. This allows the system administrator to maintain greater control over dialing patterns and the lines used for placing outgoing CO calls.

### 200.72 GROUP CALL PICK-UP

Stations can be placed in one or more of four pick-up groups. Stations within a group can pick up tone-ringing intercom calls, transferred, incoming, or re-calling outside line calls for another station in that group.

### 200.73 GROUP LISTENING

All digital key stations have built-in speakerphones. Station users may use the speaker to monitor a call while using the handset to converse with the outside party. This enables other people in the room to listen to both parties in the conversation.

#### NOTE

*This feature is not available when the station is in headset mode.*

### 200.74 HANDSET RECEIVER GAIN

This feature provides the user with a flexible button that can be programmed on their keyset. When programmed, allows the user to increase/decrease the handset receiver gain while on a CO call or intercom call. This volume setting is stored on a per station basis until changed.

### 200.75 HEADSET COMPATIBILITY

The Starplus Digital Terminals are designed to allow the connection of an industry standard, electret mic compatible, modular headset. The user connects the modular headset to the handset jack on the telephone leaving the handset in place. The ON/OFF button on the Digital Terminal is then used to activate the headset.

**KEY STATION FEATURE DESCRIPTION****200.76 HEADSET MODE**

Each digital terminal can be individually programmed for headset operation. When programmed, an industry standard headset with its adapter box may be connected to a digital terminal for headset use. This allows handset or headset operation by switching the selector switch on the adapter box. Speakerphone operation and call announce on intercom are disabled while a station has enabled headset mode.

Once programmed in station programming, the user may then select between headset mode or normal handset/speakerphone mode by simply dialing a code or pressing a user programmable flex button.

**200.77 HEARING AID COMPATIBLE**

All Electronic Digital Terminals and Single Line Telephones are hearing aid compatible in compliance with the FCC Part 68, Section 68.316. This allows the telephone to be used in conjunction with users wearing hearing aids.

**200.78 HOLD PREFERENCE**

This allows either Exclusive or System hold as the primary hold on the first depression of the HOLD button, depending on programming.

**200.79 HOLD RECALL**

When an outside call has been on Hold for a programmable length of time, recall ringing tone is sent to the station placing the call on Hold. If this station does not answer the recall, a recall tone is sent to the attendant(s).

**200.80 HOT LINE/RING DOWN**

Digital terminals may be programmed to immediately call or ring down a particular station or outside number upon going off hook. This is done by programming the stations Off-Hook preference to activate a DSS or Speed dial feature key. This feature can be overridden if the station user selects a CO line first when going off-hook.

**200.81 HUNT GROUPS**

The system can be arranged for up to eight Hunt groups. Each Hunt group can contain up to eight stations each. Each Hunt group is independently arranged to utilize either a pilot hunting technique or station hunting technique.

**A. Hunt Group Chaining**

Hunt Groups can be chained or joined together forming larger Hunt Groups. This is accomplished by assigning a pilot hunt group number as the last member of a group.

**B. Pilot Hunting**

Incoming CO, transferred CO, and intercom calls can be directed to a pilot extension number of a Hunt group. The system will search sequentially (in the order the extensions were entered in the database programming) for an idle station in the group and will ring that station. Calls directed directly to stations (by calling the extension number) within the hunt group will not hunt but receive call progress tones of the extension dialed.

**C. Station Hunting**

Incoming CO, transferred CO, and intercom calls that are presented to a busy, or DND station, that is a member of a Station Hunt group, will search sequentially (in the order the extensions were entered in database programming) for an idle station in the group and will ring that station. Calls can also be directed to the groups pilot number for hunting.

**200.82 ICLID FEATURE**

*This feature is available with optional software.*

The ICLID (Incoming Calling Line IDentification) feature has been added to the Starplus Digital Key Telephone System. However, in order for this feature to operate properly, it must be activated from the central office so that the numbers of the calling party will be delivered over the individual tip and ring of the CO lines during the first silent interval between ringing. The following features have been implemented:

**A. Calling Number/Name Display**

This feature is intended as the basic offering of the ICLID service when associated with the Starplus Digital Key Telephone System. Whenever an incoming call is received at the system, the number received along with the ringing signal will be stored in the line control tables and used at various points in the processing of the call.

The primary function will be that the calling number will be displayed (if available) at any point at which the "LINE RINGING" is displayed in the system.

In addition, with the availability of the calling name feature, if the calling name is provided, the system will deliver that to the display instead of the calling number.

**B. Incoming Number/Name for SMDR Records**

This feature will operate normally in the absence of ICLID information or the failure of the ICLID equipment. If the information is present at the time that an SMDR record is generated

for a call, it will alter the content and format of the SMDR output record.

If the calling number is available, the number will be output in the SMDR record in the same location as the dialed number is located in the outgoing calls.

If the calling name is present, an additional line will be output in the SMDR record identifying the name. This record will immediately follow the normal SMDR record. The normal SMDR record will include an indicator which identifies that a following record with name identification is present.

Unanswered calls will be recorded in the SMDR record for incoming with an indicator to allow the identification of callers for statistical and call-back purposes.

### C. Unanswered Call Management

An Unanswered Call Management Table with 100 entry capacity is maintained in the system database. The calling number/name information pertaining to any unanswered call will be placed in this table at the time the system has determined that the call has been abandoned.

This table may be interrogated from any station so that the unanswered calls may be reviewed and handled by the end user. Only the 1st Attendant station can delete an entry from this table.

#### 200.83 IDLE SPEAKER MODE

This feature allows the system to determine whether the first digit dialed is heard over the digital terminal speaker. This feature is allowed or denied on a system-wide basis in programming.

#### 200.84 INCOMING CO LINES OFF-NET FORWARD (VIA SPEED DIAL)

Allows the first attendant to forward incoming CO calls to an off-net location. The attendant can forward a group of CO lines, all CO lines, or an individual CO line to a off-net location. The attendant must have a direct appearance of the CO line(s) to be forwarded. Off-net forwarding is accomplished via use of a speed dial bin,

#### 200.85 INTERCOM CALLING

The system's architecture allows non-blocking of intercom calls. A station is reached on intercom by dialing the associated three-digit number.

#### 200.86 INTERCOM SIGNALING SELECT

Users can control the method by which they receive intercom calls and signals. A convenient intercom signal switch is located on each Digital Terminal for easy selection. The choices are:

- Handsfree (H)(left position). The station user, upon hearing a tone burst and voice announcement over the speaker, can reply handsfree.
- Tone Ringing (T)(center position). A standard tone ring notifies the party of an incoming intercom call. The called party answers by lifting the handset or moving the switch to the handsfree (H) position or pressing the ON/OFF button.
- Privacy (P)(right position). The station user receives a burst of tone and a voice announcement over his/her speaker. The microphone is deactivated for privacy. The called party must lift the handset or press the MUTE button to answer the call.

#### 200.87 KEYSSET SELF TEST

The Starplus Digital Key Telephone System contains a test mode feature that supports the off-line testing of digital terminals and DSS consoles. The term off-line means that the unit under test is disconnected from the system during the test operation. Digital terminals not under test continue to operate in the normal manner. Tests are provided to verify the keyset and DSS LED, LCD, and keypad button operations.

#### 200.88 LAST NUMBER REDIAL (LNR)

Permits the automatic redialing of the last telephone number dialed on an outside line. Up to 32 digits can be stored. Outside line selection of the same line used is automatic.

#### 200.89 LCD INTERACTIVE DISPLAY

The 34-button Executive Digital Terminal provides the user with visual indication of call status, Calls to and from other extensions, number dialed, line used and camp-on are some of the features displayed.

#### 200.90 LEAST COST ROUTING (LCR)

*This feature is available with optional software.*

Allows the system to automatically select the least costly route available according to the number dialed, the time of day/day of week, the class of service (COS) assigned to the station/trunk-group priority level assigned.

#### A. 3-Digit Table

This table is divided into 2 sections: "Leading 1" ("1" is dialed before the number) and "Non Leading 1" (no "1" is dialed before the number). This gives the system the ability to handle call routing in areas that require a "1" before a long distance number as well as in areas that do not require the "1".

**B. 6-Digit Table (Office Codes)**

The 6-Digit Table can include 20 office code maps. Each map can be programmed to route up to 800 office codes to one of the 16 possible route lists. Each map must be associated with a specific area code in the 3-Digit Table. Several different office code maps can be used with the same area code to provide additional routing flexibility.

**C. Route List Tables**

Up to 16 different routes can be programmed. Each route can contain up to four route lists - one for each of the 4 time periods. Up to seven CO line groups (routing choices) and their corresponding Insert/Delete Tables may be programmed within each route list.

**D. Insert/Delete Tables**

There are 20 Insert/Delete Tables. Up to 20-digits, including pauses, can be inserted and up to 16-digits deleted. Digits can be inserted before or after the number dialed, but can be deleted only from the beginning of a number dialed.

**E. Weekly Time Tables**

The least costly route for a particular dialed number may be different at different times of the day and on different days of the week. To accommodate this situation, there are two Time-of-Day tables: a Daily Start Time Table and a Weekly Schedule Table.

The Weekly Time table determines which one of the four Routes LCR should use based on the Time-of-Day and Day-of-the-Week.

**F. Daily Start Time Tables**

The Daily Start Time tables allow the user to match the Time Periods discount structure to the carriers rate schedule.

**G. Exception Tables**

This table is used to route operator assisted calls and any other calls which would use a one- or two-digit number rather than a three-digit area code.

**H. Default LCR Data Base**

In an effort to decrease installation and set up time usually associated with LCR a default LCR database has been incorporated. The default LCR database will provide basic routing for all local and long distance dialing.

**I. LCR Routing for Toll Information**

This feature adds provisions to the LCR call processing which will allow common call routing for all toll information calls.

1 -(XXX)555-1 212, (XXX)555-1 212, I-555-121 2 and 555-I 212 calls will all be intercepted and sent to a selected route in the Route List Table. Numbers dialed will be integrated and if it is determined to be a toll information call, either preceded with an area code or without or with a leading digit 1 or not, the call will be sent to the route designated in programming.

**200.91 LOCAL NUMBER/NAME TRANSLATION TABLE**

An administrable table provides a local translation from a received calling number to a name. This 200 entry table can be administered by the customer from the attendant console location. This table is also shared by the ICLID features. In cases of conflict between the name delivered from the CO and that in the local translation table, the local translation table shall rule.

**200.92 LOOP BUTTON CO LINE ACCESS**

A station not having a direct appearance for a CO line will receive incoming CO calls and transferred CO calls under the loop button. Only one call at a time can be connected to a keyset on the loop button. If more than one loop button is on a key set, the loop buttons may be conferenced together. If all programmed Loop buttons on a keyset are busy or have a CO call on hold, the party attempting to transfer a CO line to that station will receive busy tone and cannot transfer the call to that station. If a transfer is attempted, the CO line will recall the initiator immediately.

CO lines are also presented to a Loop when dialing out using LCR or when using speed dial to dial out and the line chosen does not appear on the key station.

**200.93 MEET ME PAGE**

Users may answer a page call from any phone in the system by dialing a special code. The party who initiated the page must remain off-hook.

**200.94 MESSAGE WAITING**

Stations that are busy, unattended, or in DND can be left a message indication by other stations in the system. Up to five messages can be left at one keyset. Upon return to the station, the user can press the flashing MSG WAIT button to ring each party in sequential order.

**200.95 MESSAGE WAITING REMINDER TONE**

A key station with a message waiting can be reminded at a programmed timed interval with a tone.

**200.96 MESSAGES - PERSONALIZED**

Each station (Key and SLT) can select a pre-assigned message to be displayed on the LCD of the digital key terminal calling that station. There are ten possible messages which can be displayed:

- 00= Clears Messages
- 01= ON VACATION
- 02= RETURN AM
- 03= RETURN P.M.
- 04= RETURN TOMORROW
- 05= RETURN NEXT WEEK
- 06= ON TRIP
- 07= IN MEETING
- 08= AT HOME
- 09= ON BREAK
- 10= AT LUNCH

**A. Date and Time Entry to Personalized Message(s)**

As an enhancement to the original personalized message(s), station users can activate certain messages that will allow the user to enter a specific time or a date of return. These messages will appear on calling stations display to alert them of the desired party's return time or date.

- 11= ON VACATION UNTIL: MM/DD
- 12= RETURN: HH:MM xm or MM/DD
- 13= ON TRIP UNTIL: MM/DD
- 14= MEETING UNTIL: HH:MM xm
- 15= AT HOME UNTIL: HH:MM xm
- 16= ON BREAK UNTIL: HH:MM xm
- 17= AT LUNCH UNTIL: HH:MM xm

**3. Messages - Custom**

This feature allows the system administrator to enter up to ten custom messages for use by station users of the system. These messages may be specified and customized by the customer on a system-wide basis.

**C. Personalized Message Code on a Flex Key**

This feature allows a key station user to program the personalized message code [633#] onto a flex button. This speeds access of the pre-selected messages.

**200.97 MUSIC ON HOLD**

A music source, when connected to the system, provides music to all lines on Hold, parked calls, transferred calls and calls waiting to be answered by Automatic Call Distribution (ACD) or Uniform Call Distribution (UCD). This feature can be allowed or denied on a system-wide basis in programming.

**200.98 MUTE KEY**

Pressing the MUTE button while in the speakerphone mode or using the handset will disable the microphone but not affect the speech coming over the speaker or handset. Pressing the illuminated MUTE button again will reactivate the microphone.

**200.99 NAME IN DISPLAY**

This feature allows every extension (Key or SLT) the capability to program the users name, for that station, so that people using display telephones will see the name instead of the station number on their display. The name is programmed at each station by the user and may be up to seven letters in length.

**200.100 NIGHT SERVICE FEATURE**

The Night Service feature will provide a means to put the system in night mode from any keyset or remove the system from night mode from any keyset as long as the system was put in night mode by the night service feature flex button. If the system was placed in night mode by the attendant using her DND button or if the system was placed in night mode by the automatic schedule, the night service flex button can not remove the system from night mode.

**200.101 NIGHT SERVICE MODE****A. Automatic Night Mode Operation**

The Starplus Digital Key Telephone System can be programmed so that the system is automatically placed into night mode.

The Attendant(s) can override the Automatic Night mode schedule simply by pressing the NIGHT (DND) button.

**B. External Night Ringing**

The system can be programmed so that CC lines marked for UNA will ring on the external page speakers.

**C. Manual Operation**

The Attendant(s) can control the use of Night Mode manually by pressing the NIGHT (DND) button. An LED will indicate when the system is in Night Mode operation.

**D. Night Class of Service (COS)**

The system allows each station to be assigned a different COS for night operation. The night COS goes into effect when the system is put into night mode manually or via the automatic schedule. Prevents the misuse of phones after hours.

**E. Night Ringing Assignments**

Each CO line may be individually programmed for Night ringing to other stations, to Hunt groups, ACD groups, UCD groups, Voice Mail

**KEY STATION FEATURE DESCRIPTION**

groups, or off-net via speed dial. When the system is placed into night mode, manually or automatically, ringing will follow the night ringing assignments for each CO line.

**F. Universal Night Answer (UNA)**

Incoming CO lines can be programmed for Universal Night Answer (UNA). Stations which do not have access to a line during the day can answer that line while the System is in the Night Mode by dialing a UNA code.

**G. Weekly Night Mode Schedule**

A programmable weekly night mode schedule provides for 24 hour, 7 day a week automatic night mode operation. The system can be put into and out of night mode automatically on a daily basis.

**200.102 OFF HOOK VOICE OVER**

This feature allows users, off-hook on a call (CO or Intercom), to receive a voice announcement through the handset receiver without interrupting the existing call. The Voice Over is muted so **as** not to "override" or "drown" out the existing conversation. The overridden party may then respond to the calling party using CAMP-ON procedures to talk to the calling party or use Silent Text Messaging to respond to the calling party via LCD displays. The calling (originating) station and receiving station **MUST** be a digital terminal. The receiving station **MUST** also be programmed to receive OHVO calls.

**NOTE**

*The calling station is placed in a one-time DND mode upon initiating the Voice Over. One-Time DND cannot be toggled during the OHVO call. The station receiving the OHVO call must be off-hook and in the "H" mode.*

**200.103 OFF-HOOK PREFERENCE****A. Auto Feature Access**

In addition to auto line access Digital Terminals have the ability to have their off-hook preference select a DSS or feature button upon going off-hook or pressing the ON/OFF button.

**B. Auto Line Access**

Each station, key or SLT, may have their phone programmed to access a particular CO Line such as a private line or a line from a Group of CO lines upon going off-hook. This is useful in Centrex or PBX applications when station users have dedicated lines. Outside line dial tone is received just by going off-hook, without the need to dial an access code.

**C. Hot Line/Ring Down**

Electronic Digital Terminals may be programmed to immediately call or ring down a

particular station or outside number upon going off hook. This is done by programming the **stations Off-Hook preference to activate a DSS or Speed dial feature key**. This feature can be overridden if the station user selects a CO line first when going off-hook.

**D. Intercom Access**

When off-hook preference is enabled, at a key station, that station may still obtain intercom dial tone for accessing internal stations or other system features. This is done either by pressing an intercom button or dialing their own intercom station number prior to going off-hook.

**E. User Programmable Preference**

Based on a station programmable option Digital Terminals may be given the ability to enable, disable or change their off-hook preference by dialing a code. This option can be denied in station programming on a per key station basis.

**200.104 OFF-HOOK SIGNALING**

If a station has been programmed to receive direct outside line ringing and is busy on another call, the call rings at the station using a muted ring signal. This option allows a user to receive a reminder ring at his busy station, instead of muted ringing. In addition, a reminder ring timer has been added to the system to provide the reminder ring every time the timer expires, as long as the incoming CO line remains connected. The system defaults this option to muted ringing. Additionally CO calls may be "camped-on" to a busy station and receive muted ringing.

**200.105 OFF-PREMISE EXTENSIONS (OPX)**

The Off-Premise Extension Box (OPX) provides one FCC registered 2500-type single line interface port. This enables the use of one Off-Premise 2500 telephone set. A precise tone plan is provided to OPX stations. A 48v powersupply is required when installing an OPX box.

**200.106 ON-HOOK DIALING**

The Digital Terminal user can place calls without lifting the handset. If the speakerphone is disabled, the handset must be lifted to converse. ..

**200.107 ON LINE PROGRAMMING**

Changes to the system database can be made without interrupting normal system operation. Programming may be performed using a key station terminal connected to the system (Station 100) or via a external terminal either on-site or remotely.



**200.108 PAGE/RELAY CONTROL**

The Starplus Digital Key Telephone System offers relays that may be individually programmed for: External Page, Loud Bell Control, CO Line Control, Power Failure Transfer, and Recorded Announcement uses. Up to four Relay/Sensor interface modules may be installed on the system. Each relay/sensor interface module contains three independent relays and three sensing input circuits.

**200.109 PAGING****A. External Paging**

There are seven external paging zones available in the Starplus SPD 4896 system. External Paging requires a three-digit dialing code. External paging requires an externally provided amplifier and paging system. Since no "on-board" relay contacts are available on the SPD 4896 for external paging, the Relay/Sensor Interface module is used for this purpose.

**B. Internal Paging**

There are four internal paging zones available in the Starplus Digital Key Telephone System. A station can be in any or all zones or in no zone at all. Stations not assigned to a page group can still make page announcements, if allowed in station programming. Stations can be assigned to a page group in order to receive pages but not allowed to make page announcements.

**c. Paging Access Restriction**

Programming on a per-station basis, can deny any station the ability to make any type of page.

**200.170 PAUSE TIMER**

When dialing a speed number, a timed pause between digit sending can be placed in the number. The length of this pause can be programmed in the system database.

**200.111 PERSONAL PARK**

Each digital terminal in the system can place a call into a personal park location and then later retrieve that call from the originating station. intercom calls and CO line calls can be placed into the stations' personal park location. Calls parked in a personal park location are subject to the "system" call park recall timer. A station retrieving a personal parked CO call must have either a direct CO line appearance or an available loop button to retrieve the parked call.

**NOTE**

*Only one call can be parked in a Personal Call Park location at one time. When dialing the Personal Park location and the location is already occupied, the initiating station will receive the previously parked call and the second call is then parked.*

**200.112 PBX DIALING CODES**

The System will allow five one or two-digit access codes to be entered into memory. When one of these codes is dialed, this signals the KSU that the user is dialing a PBX access code and not dialing directly over an outside CO line and that toll restriction is to be applied to the next dialed digits after the code. Therefore, toll restriction will not be applied to the station unless one of these five PBX codes is dialed first. This allows the dialing of PBX extensions 100, 110, 111, etc. This functions on lines marked as PBX type lines in programming.

**200.113 POOL BUTTON OPERATION**

The Pool Group Key is used primarily to access CO lines that do not appear on a station so that outgoing calls may be made. Pooled group keys are associated to CO line groups and may be programmed for use on any of the flexible line buttons. CO lines are accessed in descending order of priority starting with the highest numbered available (not busy) CO line in a CO line group.

Stations may have as many POOL buttons as their are CO line groups. Multiple POOL buttons for the same group are also allowed.

**200.114 PREFERRED LINE ANSWER**

A station with Preferred Line Answer can answer any assigned outside, transferred, or recalling line, or queue callbacks by lifting the handset or pressing the ON/OFF button. The station MUST be physically ringing, to function properly.

**200.115 PRIVACY RELEASE**

Privacy is insured on all communications in the system. if desired, the customer may elect to disable the Automatic Privacy feature, thus allowing up to three other stations to join in on an existing CO Line conversations.

**NOTE**

*Disabling of the privacy feature may be limited by federal, state or local law, so check the relevant laws in your area before disabling privacy.*

**A. Per CO Line Option**

This feature allows each CO line to be individually programmed for privacy. This feature is useful for maintaining security on such lines as Data lines, Private lines, or special circuits requiring privacy. if privacy is disabled on a CO line then, while in use, another station may enter the conversation simply by pressing the CO line button. A programmable warning tone is presented to all parties prior to actual cut-thru. The station attempting to enter the conversation must also have privacy disabled.

**B. Per Station Option**

Each station may be programmed to give the station the capability to join an existing conversation simply by pressing the CO line button that is in use. A programmable warning tone is presented to all parties when the station enters the conversation. The CO line must also have privacy disabled to allow the cut-thru.

**200.116 PRIVATE LINE**

Private line programming allows certain lines to ring at a specific station only. When placed on Hold, these lines are active at the programmed station only. A private line can be transferred to other stations, provided the station receiving the call has a loop button or direct appearance of that CO line.

**200.117 PULSE-TO-TONE SWITCHOVER**

When commanded, the system will change the signaling on an outside line from dial pulse to DTMF (tone), allowing the use of common carriers behind a dial pulse outside line. This can be done manually when dialing, or can be stored within a speed dial number.

**200.118 RANGE PROGRAMMING**

The Starplus Digital Key Telephone System allows for range programming when programming CO lines and Stations. Range programming allows you to program all parameters alike for the entire range or you can change or modify a few items that will be copied to all members in the range.

**200.119 RELEASE KEY**

Allows the station and attendant users to disconnect calls while off-hook, speeding up call handling time.

**200.120 REMOTE ADMINISTRATION**

The Remote Administration feature allows authorized personnel to access the administration programming via a terminal device (portable terminal device or personal computer with communications software package).

The feature permits the review and entry of the customer database in the same manner as via the digital terminal at "ADMIN" Station 100. The terminal device can be connected directly to the RS-232C connector on the Central Processor Unit (CPU), or can be accessed by a telephone modem linking the CPU's RS-232C connector (via a CO line) to a remote location. When entering the system remotely via a terminal device, access to the on-board 1200 modem (future) is accomplished by accessing Port 499 either through a direct ringing assignment or through DISA or by being transferred to Port 499 by any internal station.

**A. Database Upload/Download**

DataBase Upload/Download provides a maintenance facility which will be added to the Remote Administration routine. This routine permits the database to be downloaded to a PC, when a software changes is made or when the system needs to be initialized and re-programmed. In addition, the routine facilitates the programming of a database on an in-house system which can be downloaded to a PC and then uploaded to a system in the field. After the system maintenance is completed, the file saved in the PC can then be uploaded to the system.

**200.121 REMOTE SYSTEM MONITOR AND MAINTENANCE****A. Remote System Maintenance**

The Remote Maintenance feature allows the Interconnects' technical staff to review the systems configuration data and individual card slot configuration data. This can be done "on site" using a data terminal or remotely using a modem to access a remote data terminal. When entering the system remotely via a terminal device, access to the on-board 1200 modem (future) is accomplished by accessing Port 499 either through a direct ringing assignment or through DISA or by being transferred to Port 499 by any internal station.

**B. Remote System Monitor**

The Remote Monitor feature provides remote access to the installed system for diagnostic purposes. These capabilities benefit Service personnel enabling them to support the end user remotely. Different levels of access, via password, allows authorized personnel to trace, monitor and "up-load" critical information directly from the Star-plus Digital Key Telephone System. This provides a more accurate means of acquiring system information that leads to a quick resolution of problems that may occur. This is all done without interfering with ongoing call processing or normal system operation, and in many cases may be performed without a site visit.

Capabilities allowed and reserved for this "High level troubleshooting" in addition are:

- Monitor Mode
- Enable & Disable Event "Trace"
- Dump "Trace Buffer" (up-load)

**200.122 SAVE NUMBER REDIAL (SNR)**

Any number dialed on an outside line can be saved permanently to be used at any time. This number is saved until a new number is stored.

**200.123 SINGLE LINE TELEPHONE (SLT) COMPATIBILITY**

The Starplus Digital Key Telephone System supports industry standard 2500 Type (DTMF) single line instruments. When the Single Line Telephone Board (SL12) is installed, a maximum of 12 single line telephones may be supported. The Starplus SPD 4896 system will support up to 84 single line telephones through the use of single line boards and/or SWOPX boxes.

**200.124 SPEAKERPHONE**

Both Enhanced and Executive Digital Terminals are equipped with a speakerphone. However, the speakerphone can be programmed to work in one of three ways:

- Normal speakerphone operation.
- Disabled for outgoing and incoming CO calls but handsfree on intercom allowed.
- Headset operation allowed.

**200.125 STATION CLASS OF SERVICE (COS)**

Each station is assigned a Class of Service which governs that stations dialing privileges. Day Class of Service and Night Class of Service assignments to stations provide the system administrator additional control over station dialing, preventing misuse of phones after hours. Six uniquely defined Classes of Service are available for assignment to stations on a per station basis and all six are available for day and night assignment. Station Class of Service works in conjunction with CO line Class of Service to provide the most flexible means for offering custom toll restriction. As a part of the Dialing privilege assignment through Class of Service the system offers two programmable Allow and Deny tables for additional customization of a toll restriction plan for a particular customer. In addition, each station can reference up to four special area code tables.

**200.126 STATION MESSAGE DETAIL RECORDING (SMDR)**

*This feature is available with optional software.*

The Starplus Digital Key Telephone System provides one industry standard RS-232C port for dual purpose use and a second port is optional for SMDR output, each allowing connection to an external printer or call accounting device. The system provides details on both incoming and outgoing calls. This feature is programmable to allow all calls or just outgoing long distance calls to be recorded. The

system tracks calls by outside line, number dialed, time of day, date, station that placed the call and duration of call. Account codes may also be entered and recorded.

**200.127 STATION RELOCATION FEATURE**

The Station Relocation feature provides a means to allow a user to unplug their station and plug it in at another location. Then by dialing a code followed by the old station number, all station attributes, including extension number, button mapping, speed dial, and class of service are transferred to the new location.

**NOTE**

*If a station is assigned to a specific port and that station user unplugs their station and plugs it in at another location, the database administration programming will be updated to reflect the new port change.*

**200.128 STATION SPEED DIAL**

Each station user can program up to 20 frequently dialed numbers of up to 24-digits in length. Pauses, flash commands, pulse-to-tone switchover, and NO-DISPLAY characters take up digit spaces. In the Starplus SPD 4896 system, there are a total of 1920 speed locations to be divided among all telephones.

Numbers are dialed by use of the SPEED button and a two-digit code. This feature can additionally be assigned to any of the buttons in the flexible button field on each keyset for one-button activation.

**200.129 SYSTEM CAPACITY****A. Up to 48x96 Configuration**

The SPD 4896 system will support a maximum of 48 outside CO circuits and 96 station circuits,

**200.130 SYSTEM HOLD**

When a line is placed on System Hold? any station in the system with an appearance of that line can retrieve the call.

**200.131 SYSTEM SPEED DIAL**

Up to 80 commonly dialed numbers can be programmed into System Speed Dial for use by stations allowed this feature. These numbers can be up to 24-digits including pauses, flash commands, pulse-to-tone switchover, and no-display characters. The last 40 numbers will not be monitored by toll restriction.

**200.132 TEXT MESSAGING (Silent Response)**

This feature allows a station user to use text messages to respond to a caller that has either Camped-On or has used the Off-Hook Voice Over (OHVO) feature to alert a busy station of a waiting call or message. The "camped-on" station may respond to the caller via the personalized, custom, and re-

**KEY STATION FEATURE DESCRIPTION**

sponse text (LCD) messages. The text messages appear on the calling party LCD display. The calling (originating) station and receiving station MUST be a digital terminal. The receiving station MUST also be programmed to allow OHVO calls.

**200.133 TOLL RESTRICTION (TABLE DRIVEN)**

The system provides a flexible means of providing toll restriction to internal stations of the Starplus Digital Key Telephone System. Each station is assigned a Class of Service for day mode operation and one for night mode operation these station COS's work in conjunction with a CO line Class of service to allow for customized toll restriction. Two Allow and Deny tables along with four special tables afford the system administrator to devise a variety of complex toll restriction or dialing privilege schemes.

**200.134 TRANSFER RECALL**

Screened and unscreened transfers will recall the initiating party if unanswered for a programmable length of time, and then if unanswered, will recall the attendant.

**200.135 UNIFORM CALL DISTRIBUTION (UCD)**

Eight Uniform Call Distribution (UCD) groups can be programmed, each containing up to eight three-digit station numbers. Each group is assigned a pilot number. When this number is dialed, the first available agent in that group is rung. Calls are routed to the station that has been on-hook for the longest period of time.

**A. Alternate UCD Group Assignments**

An alternate UCD group can be programmed so that if stations in one group are busy, the alternate group will be checked for an available station.

**B. Auto Wrap-Up w/Timer**

After completion of a UCD call (on-hook) the agent will not be subjected to another UCD call for the duration of the Auto Wrap-Up timer (regardless of the number of calls in queue), allowing the agent to finish call related work or access other facilities. This will allow agents to remove themselves from the group (i.e.. DND, Unavailable, Call Forward or originate another call). The auto wrap-up timer is programmed as part of the UCD database. (System-wide)

**C. Available/Unavailable Mode**

Stations programmed into a UCD group may log off and on to their assigned UCD group by dialing an Available/Unavailable code. When an agent is in the Available mode that agent will receive UCD calls in the normal manner. When

an agent is in the Unavailable mode that **agent** will no longer receive UCD type calls, however may receive non-UCD calls. Agents that have logged off by going Unavailable will receive a visual reminder that they are logged off with a flashing LED and or a LCD display message.

**D. Incoming CO Direct Ringing**

CO Lines can be programmed to ring directly into a UCD group. When all agents are busy and RAN is enabled, the system will answer the caller and present the 1st RAN announcement automatically.

**E. No-Answer Recall Timer**

If a call routed to a station via UCD is not answered by the UCD Agent/Station before the No-Answer Recall timer expires, the call will be returned to UCD Queue with the highest priority. In addition, the station that failed to answer the ringing UCD call will be placed into an Out-Of-Service (OOS) state.

**F. No-Answer Retry Timer**

When the No-Answer Recall timer expires, a station that failed to answer the ringing UCD call is placed into an out of service (OOS) state. The station that was taken out of service (OOS) will be placed back in service if the agent hits his available flex button or dials the available flex code. In addition, the agent will be placed back in service if the No-Answer Retry timer expires. If the agent does not answer his next UCD call, he will again be taken out of service. This cycle will continue until the station answers calls, logs out, or goes unavailable.

**G. Overflow Station Assignments**

An overflow station may be assigned to route callers in queue to a designated station after a specified time. The overflow station may not be one of the UCD group stations.

**H. Recorded Announcements (RAN)**

Recorded announcement devices can be assigned to provide up to eight different messages, if all stations in a UCD group are busy. The eight messages are available to all eight UCD groups in different configurations. A RAN table can be the answer port for unanswered incoming calls to a UCD group, while another table can provide the secondary message. Each RAN device can provide an announcement to one caller at a time. Subsequent callers will be queued onto the message on a first-in basis.

**I. Agent Queue Status Display**

The Agent Queue Status feature provides a means for an agent and UCD supervisor to view

the status of their UCD group. This display is an idle state display and will prompt a supervisor that Agents in a group are having problems answering all their calls. The display will tell the agent and his supervisor how many calls are in queue, how many agents are available or logged into the group, and the length of time in minutes that the oldest call has been in queue. The agent will receive the calls in queue display whenever there is a call in queue.

There are two methods of viewing UCD Group call queue status.

1. In-service UCD agents and the assigned overflow station will see the quantity of calls in queue on the LCD of their station for the UCD group of which they are a member. If every member of a UCD group is busy and calls are in queue, the Supervisor/Agent Queue Status display will be seen at all UCD members of that group.

**NOTE**

*If a UCD member is taken out of the group (i.e., DND; All Call Forward, Unavailable, etc.) they will not receive calls in queue information.*

2. Any station not assigned in a UCD group can view the number of calls in queue for any given UCD Group. To view the number of calls in queue the station user dials the Calls In Queue code (or presses a programmed FLEX button with this code) then enters the UCD group desired. The LCD will display, on a real time basis, the number of calls in queue for that group.

**200.136 UNIVERSAL NIGHT ANSWER (UNA)**

Incoming CO lines can be programmed for Universal Night Answer (UNA). Stations which do not have access to a line during the day can answer that line while the System in the Night Mode by dialing a UNA code. In order to utilize this feature, a loop button or an appearance of the trunk must be present on the station.

**200.137 VOICE MAIL GROUPS (VM)**

*This feature is available with optional software.*

The Voice Mail feature automatically handles unanswered calls. Stations may forward calls to a voice mail group (for leaving mail) or may call the voice mail group directly (to retrieve mail) with no assistance from the attendant. Up to eight voice mail groups can be configured, each group containing up to eight voice mail stations. Each station interfaces with a port on the Single Line Board (SL12) on the SPD 4896 system. Each voice mail "station" can be shared by a number of actual users. A Single Line Board (SL12) is required when utilizing the Starplus

Digital Key Telephone System Voice Mail "In-Band" integration.

In addition, calls that are transferred from a Voice Mail group will NOT recall to the VM group. Instead, the call will recall to the Attendant station. If no Attendant station is programmed in the system, the call will continue to recall this station. This is useful for Voice Mail system that only provides unsupervised transfer capability.

**NOTE**

*By default, all Voice Mail stations are placed into Pickup Grp 1. You may need to change the default setting.*

**A. VM Disconnect Signal - Pass Thru**

To avoid Voice Mail ports from being tied up, as a result of CO line callers abandoning the call or not exiting the VM system properly, a disconnect signal has been provided to notify the VM system that a CO or intercom caller has hung up or abandon the call. "Silence" is provided to the VM port followed by "busy tone" to aid the VM system to recognize that an intercom caller has abandoned the call.

**B. VM In-Band Signaling Integration**

The Starplus Digital Key Telephone System allows the system to be programmed so that if a station programmed to receive incoming CO line ringing is forwarded to Voice Mail they may have direct incoming callers routed directly into their stations voice mail box through the use of "In-Band" signaling. Alternately, incoming CO lines can be programmed to ring directly into the Voice Mail system. In this case, callers will be answered by the Voice Mail or Auto Attendant Main greeting.

Incoming CO callers can be Station Call Forwarded into voice mail only when the ringing CO line is programmed to ring at one station. Additionally CO lines programmed to ring at an attendant station will station call forward into the Voice Mail system (if programmed to ring only at one attendant station) and be presented to the main greeting (not the attendant stations mail box) even when ID digits are enabled.

**C. VM Message Waiting Indication**

When Voice Mail has received a voice message for a user who has a station on the Starplus Digital Key Telephone System, the VM connected to the system can leave a message waiting indication at the VM users station. When the station user retrieves their mail, the VM system can cancel the message waiting indication left at a station via a VM port.

The message waiting indication will appear on the programmed Voice Mail (group) button. If

**KEY STATION FEATURE DESCRIPTION**

---

such a button has not been programmed, a voice mail message waiting indication will appear on the MSG WAIT button as a normal message waiting signal.

**D. VM Tone Mode Calling Option**

Voice mail systems and/or Automated Attendants can utilize the Calling Station Tone Mode option. This is useful when using supervised transfer or call screening options on voice mail or auto attendant(s) requiring ring back tone for proper call handling.

**E. VM Transfer/Forward**

This feature allows Voice Mail calls, upon reaching a forwarded to VM station, to forward back into the Voice Mail unit. This is useful when VM ports are being used as both Auto Attendant and VM ports. This feature can be enabled/disabled for all VM groups.

**F. VM Transfer with ID Digits**

This feature provides an attendant or station user a way to transfer a caller directly into a voice mail box. This allows the station identification digits to be entered by the transferring party. Using this feature, a caller can be transferred to a voice mail box when 1) a station user on the system is not forwarded to VM or 2) the destination voice mail box owner is not a station user. CO trunks and internal calls may be transferred into voice mail using this feature. If no voice mail ID digits are dialed by the transferring station, then the identification digits of the transferring station will be sent to the voice mail.

**200.136 VOLUME CONTROLS**

Both speaker and tone ringing volumes can be separately adjusted by utilizing the two slide switches on the front of the digital terminal.

Table 210-I SLT Station Features/Software Packages

FEATURE	STANDARD FEATURES	ENHANCED FEATURES	CALL PROCESSING FEATURES	NETWORK & TRUNKING	COMBINATION PKG	ADDITIONAL EQUIPMENT REQUIRED
<b>A</b>						
Account Code ..... 210-1		•	•	•	•	N
Automatic Line Access ..... 210-1	•	•	•	•	•	N
<b>C</b>						<u><u>N</u></u>
Call Forward ..... 210-1	•	•	•	•	•	N
Camp-On ..... 210-1	•	•	•	•	•	N
Conference ..... 210-1	•	•	•	•	•	N
Conference w/Personal Park ..... 210-1	•	•	•	•	•	N
<b>D</b>						
Direct Outside Line Access ..... 210-1	•	•	•	•	•	N
Direct Outside Line Ringing ..... 210-1	•	•	•	•	•	N
Directed Call Pick-Up ..... 210-1	•	•	•	•	•	N
Do Not Disturb (DND) ..... 210-1	•	•	•	•	•	N
<b>G</b>						
Group Call Pick-Up ..... 210-1	•	•	•	•	•	N
<b>H</b>						
Handset Receiver Gain ..... 210-2	•	•	•	•	•	N
<b>I</b>						
Intercom Calling ..... 210-2	•	•	•	•	•	N
<b>L</b>						
Loop Option ..... 210-2	•	•	•	•	•	N
<b>M</b>						
Message Waiting/Call Back ..... 210-2	•	•	•	•	•	N
Messages - Personalized ..... 210-2	•	•	•	•	•	N
Custom Messages ..... 210-2	•	•	•	•	•	N
<b>N</b>						
Night Service ..... 210-2	•	•	•	•	•	N

N=No additional hardware required

Table 210-1 SLT Station Features/Software Packages

FEATURE	STANDARD FEATURES	ENHANCED FEATURES	CALL PROCESSING FEATURES	NETWORK & TRUNKING	COMBINATION PKG	ADDITIONAL EQUIPMENT REQUIRED
<b>O</b> Off-Hook Preference.....210-2	•	•	•	•	•	N
<b>P</b> Personal Park.....210-2	•	•	•	•	•	N
<b>Q</b> Queuing.....210-2	•	•	•	•	•	N
<b>S</b> Station Speed Dial.....210-2	•	•	•	•	•	N
System Speed Dial.....210-2	•	•	•	•	•	N
<b>T</b> Transfer.....210-2	•	•	•	•	•	N

N=No additional hardware required



## SECTION 210

# SINGLE LINE TELEPHONE FEATURE DESCRIPTION

Single Line telephones have access to most of the system and station features listed in the previous section, however, the additional features listed below are unique to Single Line Telephones. The Single Line Telephone Board (SL12) is required in the Starplus SPD 4896 System for proper SLT operation. A Single Line Adapter (OPX) box and 48v Power Supply may also provide single line operation. An abbreviated feature index is provided in Table 21 O-1 SLT Station Features/Software Packages.

### 210.1 ACCOUNT CODE

*This feature is available with optional software.*

SLJ stations may enter an account code, up to 12-digits in length, to identify calls for billing/tracking purposes. The account code may be entered either before the call or during the call (the outside caller is placed on hold while the account code is entered if during the call.). The account code is recorded on the SMDR printout. Account codes are non-verified and can vary in length from 1 to 12 digits.

### 210.2 AUTOMATIC LINE ACCESS

SLT's may have their station programmed to access a particular CO Line such as a private line or a line from a Group of CO lines upon going off-hook. This is useful in Centrex or PBX applications when station users have dedicated or individual lines. Outside line dial tone is received just by going off-hook, without the need to dial access codes.

### 210.3 CALL FORWARD

Single line telephones may direct intercom calls and transferred CO lines to be forwarded to another station. SLTs have access to all forwarding options that Key station users have:

- Call Forward - All Calls
- Call Forward - No Answer [7]
- Call Forward - Busy [8]
- Call Forward - Busy/No Answer [9]
- Call Forward - Off-Net [\*]
- Preset Call Forward

### 210.4 CAMP ON

A busy station can be notified that an outside line is on hold and waiting for them. The busy station is notified of this by a beep tone. Single line telephones

can receive a camp on indication or initiate one by using an access code.

### 210.6 CONFERENCE

An SLT user can initiate a conference with an outside line and one other internal station.

### 210.6 CONFERENCE /WITH PERSONAL PARK

Single Line Telephones (SLT) can initiate a conference between two outside (CO) calls. The Personal Park feature is used in conjunction with the SLT conference code to make this possible. A combination of features are derived from these dial codes (Personal Park, Flip/Flop, and Multi-line Conference).

### 210.7 DIRECT OUTSIDE LINE GROUP ACCESS

Single line telephones can access outside lines by dialing CO line group access codes 9 or 81-87.

### 210.8 DIRECT OUTSIDE LINE RINGING

Single line telephones can be set up to receive direct outside line ringing. SLTs may be programmed to receive incoming CO Ringing on more than one CO line. However, an SLT can answer only ONE call at a time. If a SLT is busy when a CO call rings in, camp-on tone will be given to that SLT station.

### 210.9 DIRECTED CALL PICK-UP

Tone ringing intercom calls, initial Ringing CO calls and transferred outside line calls to specific stations can be picked up by single line telephones. For this type of pickup, the stations do not have to be in the same pickup group.

### 210.10 DO NOT DISTURB (DND)

Each telephone user can be allowed to place their phone in Do Not Disturb. The user will receive error tone if they are not allowed this feature. They will also receive a confidence tone when lifting the handset to remind them they are in Do Not Disturb. The attendant can override a station in DND.

### 210.11 GROUP CALL PICK-UP

Tone ringing intercom calls, transferred outside line calls, and initially ringing calls can be picked up by single line telephones by dialing a special pickup code. The telephones must be in the same pickup group.

**SINGLE LINE TELEPHONE FEATURE DESCRIPTION****210.12 HANDSET RECEIVER GAIN**

This feature allows an SLT user while on a CO call to hookflash and dial a code to increase/decrease the handset volume.

**210.13 INTERCOM CALLING**

Single line telephones can make and receive intercom calls.

**210.14 LOOP INTERRUPT OPTION**

This feature allows Single Line telephone ports to provide a Loop Disconnect signal to any devices that are connected to an SLT port. This is an inherent operation, no programming is necessary.

The signal is provided when a CO line, marked with Loop Supervision, connected to an slt port receives Loop Supervision from the Central Office.

When an internal call to an SLT is terminated, the SLT will provide the Loop Interrupt signal.

The Loop Interrupt signal consists of an open for 700ms with less than 5ma.

**210.15 MESSAGE WAITING/CALL BACK**

Single Line Telephones calling a station that is busy, idle, or in Do Not Disturb can leave a message waiting indication to signal the station to call back.

**210.16 MESSAGES - PERSONALIZED**

Each SLT station can select a pre-assigned message to be displayed on the LCD of the Digital Terminal receiving that message. There are ten possible messages which can be displayed:

- 00= Clears Messages
- 01= ON VACATION
- 02= RETURN AM
- 03= RETURN PM
- 04= RETURN TOMORROW
- 05= RETURN NEXT WEEK
- 06= ON TRIP
- 07= IN MEETING
- 08= AT HOME
- 09= ON BREAK
- 10= AT LUNCH

**A. Messages - Custom**

This feature allows the system administrator to enter up to ten custom messages for use by station users of the system. These messages may be specified and customized by the customer on a system-wide basis.

**210.17 NIGHT SERVICE**

When outside lines are marked UNA and the system is placed into night service, a single line telephone can answer incoming calls on lines it does not nor-

mally have access to by dialing [#5]. When External Night Ringing is enabled in database programming, ringing is outputted on the external page ports.

**210.18 OFF-HOOK PREFERENCE**

SLT's may have their station programmed to access a particular CO Line such as a private line or a line from a Group of CO lines upon going off-hook. This is useful in Centrex or PBX applications when station users have dedicated lines. Outside line dial tone is received just by going off-hook, without the need to dial access codes.

**210.19 PERSONAL PARK**

Single line telephones can be connected to two calls (Intercom or CO lines) at the same time and "flip/flop" between the two calls. This can be performed with originated or received calls. This feature is also used with SLT multi-line conference feature.

**210.20 QUEUING**

Single line telephones can be placed in a queue awaiting the first available outside line in a group to become available.

**210.21 STATION SPEED DIAL**

Each SLT user may program up to 20 individual speed dial numbers. Each speed dial number can be up to 24-digits in length.

**210.22 SYSTEM SPEED DIAL**

Each SLT user can be allowed access to system speed dial numbers on a programmable basis. The last forty system speed numbers override toll restriction.

**210.23 TRANSFER**

Outside lines may be transferred by or to single line telephones. These transfers can be either announced or unannounced.

**Table 220-I Attendant Features/Software Packages**

FEATURE	STANDARD FEATURES	ENHANCED FEATURES	CALL PROCESSING FEATURES	NETWORK & TRUNKING	COMBINATION PKG	ADDITIONAL EQUIPMENT REQUIRED
<b>A</b>						
Attendant Disable Outgoing Access ..... 220-1	●	●	●	●	●	N
Attendant Overflow ..... 220-1	●	●	●	●	0	N
Attendant Override ..... 220-1	●	●	●	●	●	N
Attendant Position ..... 220-1	●	●	●	●	●	N
Attendant Recall ..... 220-1	☒	☒	●	●	●	N
Attendant Search ..... 220-2	●	●	●	●	●	N
Automatic Night Mode ..... 220-1	●	●	●	●	●	N
<b>B</b>						
Busy Lamp Field ..... 220-2	●	●	●	●	●	N
<b>D</b>						
Direct Station Calling ..... 220-2	●	●	●	●	☒	N
<b>H</b>						
Handset Receiver Gain ..... 220-1	●	●	●	●	●	N
<b>I</b>						
Incoming CO Line Off-Net Forward ..... 220-1	●	●	●	●	●	N
<b>M</b>						
Mapping Options ..... 220-2	●	●	●	●	●	N
Messages - Custom ..... 220-2	●	●	●	●	●	N
<b>N</b>						
Night Service Feature ..... 220-1	●	●	●	☒ ☒ ☒ ☒ ☒	●	N
<b>R</b>						
Release Key ..... 220-2	●	●	●	☒	☒	N
<b>T</b>						
Time and Date Programming ..... 220-1	●	●	●	●	●	N

N=No additional hardware required

## SECTION 220

# ATTENDANT FEATURE DESCRIPTION

The Attendant and Attendant(s) with DSS/DLS features of the Starplus Digital Key Telephone System are listed and described below in alphabetical order. An abbreviated feature index is provided in Table 220-I Attendant Features/Software Packages.

### 220.1 ATTENDANT DISABLE OUTGOING ACCESS

The first attendant can disable CO lines, preventing outgoing access to those lines. This is useful for removing a faulty line from service, or for reserving CO lines for important use. All stations that can normally make calls on the lines are affected, but incoming calls are not affected. A CO line may be disabled while it is being used. When the trunk becomes idle, further outgoing access will be prevented.

### 220.2 ATTENDANT OVERFLOW

System programming allows the attendant station to be programmed so that if the attendant is busy or not there, the call will be automatically forwarded to another predetermined station, VM Group, Hunt Group, ACD or UCD group after a programmed period of time. (Refer to Call Forward, Station and Preset)

### 220.3 ATTENDANT OVERRIDE

Attendant stations may override a busy station or ring a station in DND. While busy, pressing the override key provides override tone and a five second delay before voice cut-through to the called party occurs, automatically placing any outside line call on Hold. The Attendant Override function may be programmed on to a flex button and can be enabled or disabled in programming.

### 220.4 ATTENDANT POSITION

The system identifies a maximum of three programmable stations as attendants for line recalls and attendant features. The first programmed attendant can enter system date and time information as well as System Speed numbers from this position without entering the programming mode. The Starplus Digital Key Telephone System is placed in Night Service by any programmed attendant pressing the NIGHT (DND) button or dialing the NIGHT code.

### 220.6 ATTENDANT RECALL

A held CO call left unattended by a station will recall the attendant(s) after a programmable period of time has elapsed. A recalling CO line flashes at a distinc-

tive rate and has an LCD display that identifies the originating station of the unanswered call.

### 220.6 AUTOMATIC NIGHT MODE

In addition to the attendants capability to place the system into and out of night mode manually, by pressing the Night key, an automatic night mode schedule has been added to the system. The automatic schedule is determined in database programming on a weekly basis, including Saturday and Sunday. The Attendant can override the automatic schedule by pressing the NIGHT (DND) button.

### 220.7 HANDSET RECEIVER GAIN

This feature provides the user with a flexible button that can be programmed on their keyset. When programmed, allows the user to increase/decrease the handset receiver gain while on a CO call or intercom call.

### 220.8 INCOMING CO LINE OFF-NET FORWARD

Allows the first attendant to forward incoming CO calls to an Off-Net location. The attendant must have a direct appearance of the CO line to be forwarded. Forwarding can be established on a per CO line group basis, all CO lines, or an individual CO line may be simultaneously forwarded to an off-net location.

### 220.9 NIGHT SERVICE FEATURE

The Night Service feature will provide a means to put the system in night mode from any keyset or remove the system from night mode from any keyset as long as the system was put in night mode by the night service feature flex button. If the system was placed in night mode by the attendant using her DND button or if the system was placed in night mode by the automatic schedule, the night service flex button can not remove the system from night mode.

### 220.10 TIME AND DATE PROGRAMMING

This feature allows the first programmed attendant to set the time and date without entering the programming mode.

**ATTENDANT FEATURE DESCRIPTION****ATTENDANT W/DSS/DLS FEATURES****220.11 ATTENDANT SEARCH**

Allows a user to make a series of intercom calls without hanging up the handset. An intercom connection is switched to another station whenever a DSS key is pressed. Pressing the next DSS key terminates the previous intercom call.

**220.12 BUSY LAMP FIELD INDICATORS**

Each station key on the DSS console has a corresponding indicator which shows whether the station is idle or busy. The indicator is lit when the station is busy and unlit if the station is idle. A station in DND mode is shown by a flashing indicator.

**220.13 DIRECT STATION CALLING**

Enables the user to make an intercom voice call to any Digital Terminal in the system. Permits you to automatically put an outside caller on hold and simultaneously make an intercom call to an internal station. Also allows you to transfer an intercom call or outside call that is on hold to another station.

**220.14 MAPPING OPTIONS**

The DSS/DLS Console unit can access Stations, Direct Appearing CO Lines, or features that may be assigned to any of the flexible buttons.

A DSS/DLS unit may be assigned to one of the different MAP configurations available. Any one of the four MAP configurations may be assigned to the DSS/DLS and any number of maps may be assigned to one station. However, MAPs that have buttons assigned as CO lines cannot be changed, buttons assigned as Stations can be changed by the user. Up to three maps may be assigned to one station.

There are four pre-defined MAPs for the DSS/DLS console with default button programming. Refer to Figure 220-1 DSS Console Map 1, Figure 220-2 DSS Console Map 2 and Map 3, and Figure 220-3 DSS Console Map 4 for a button layout of each DSS Console Map. Each Attendant may have up to three DSS/DLS Consoles assigned to work with one Attendant station.

**220.15 MESSAGES - CUSTOM**

This feature allows the first programmed attendant (system administrator) to enter up to ten custom messages for use by station users of the system. Up to 24-characters may be entered as the custom message (this will represent 48 digits entered). A station user may store any of the available messages under a flexible button assigned as a Message Access button. These messages may be specified and customized by the customer on a system-wide basis. Message status is stored in battery protected area of memory for retention in the

event of a power failure or system reset (soft or hard).

**220.16 RELEASEKEY**

Allows the user to disconnect calls while off-hook, speeding up call handling time.

MAP #1 has by default the first 12 CO lines and the first 36 Stations, 100-135. This provides a default layout of a 12x36 configuration.

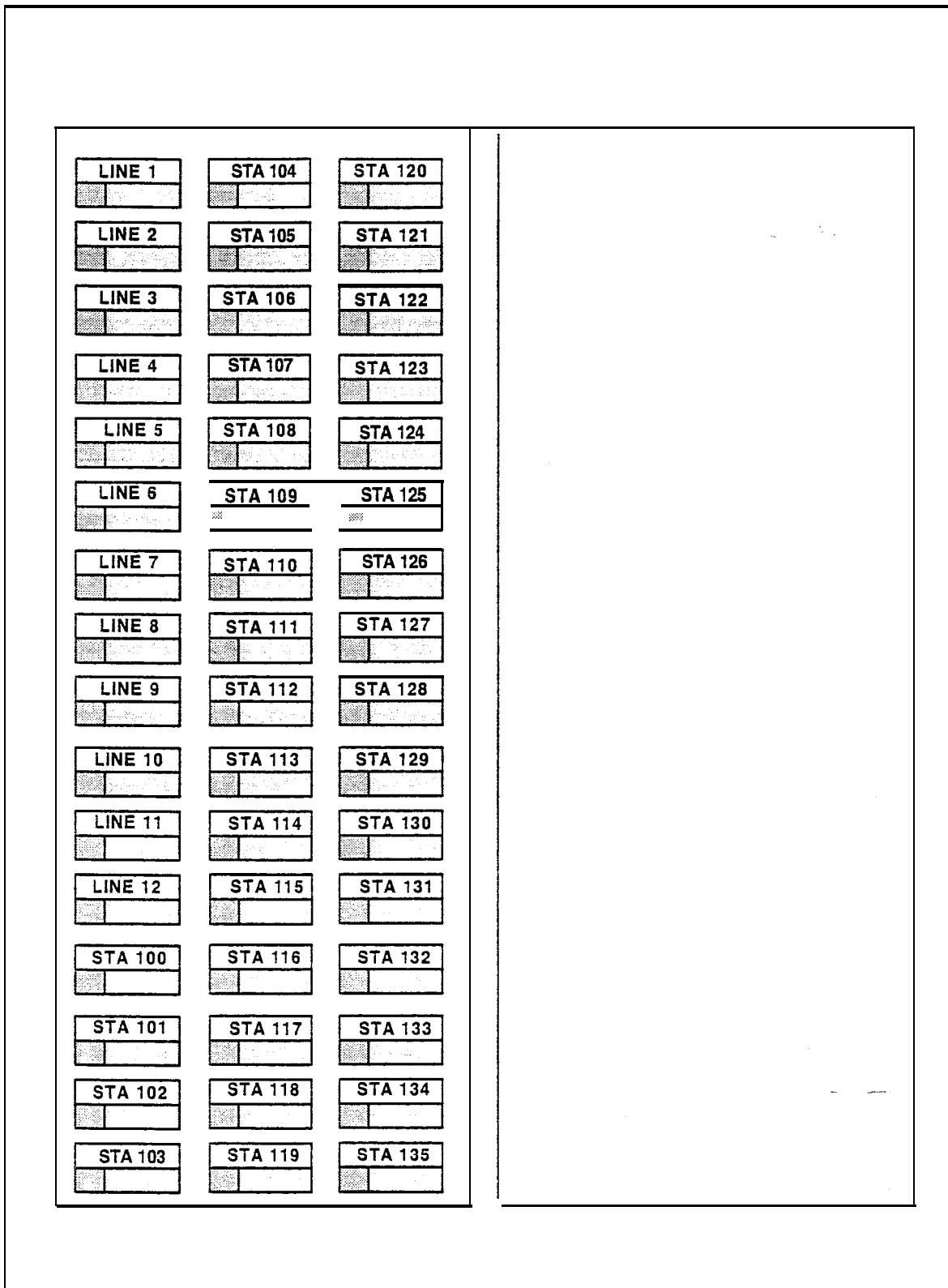

Figure 220-I DSS Console Map 1

**MAP #2** has by default the first 48 Stations, 100-147. All buttons on Map #2 are flexible and can be changed by the station user. This map can be duplicated on another DSS/DLS Console and assigned to the same station.

**MAP #3** by default is intended to be used with Map #2 in that it has the remaining stations, 148-195 to provide a full Station mapping. All of the buttons on Map #3 are flexible and can be changed by the user. This map can be duplicated on another DSS/DLS Console and assigned to the same station.

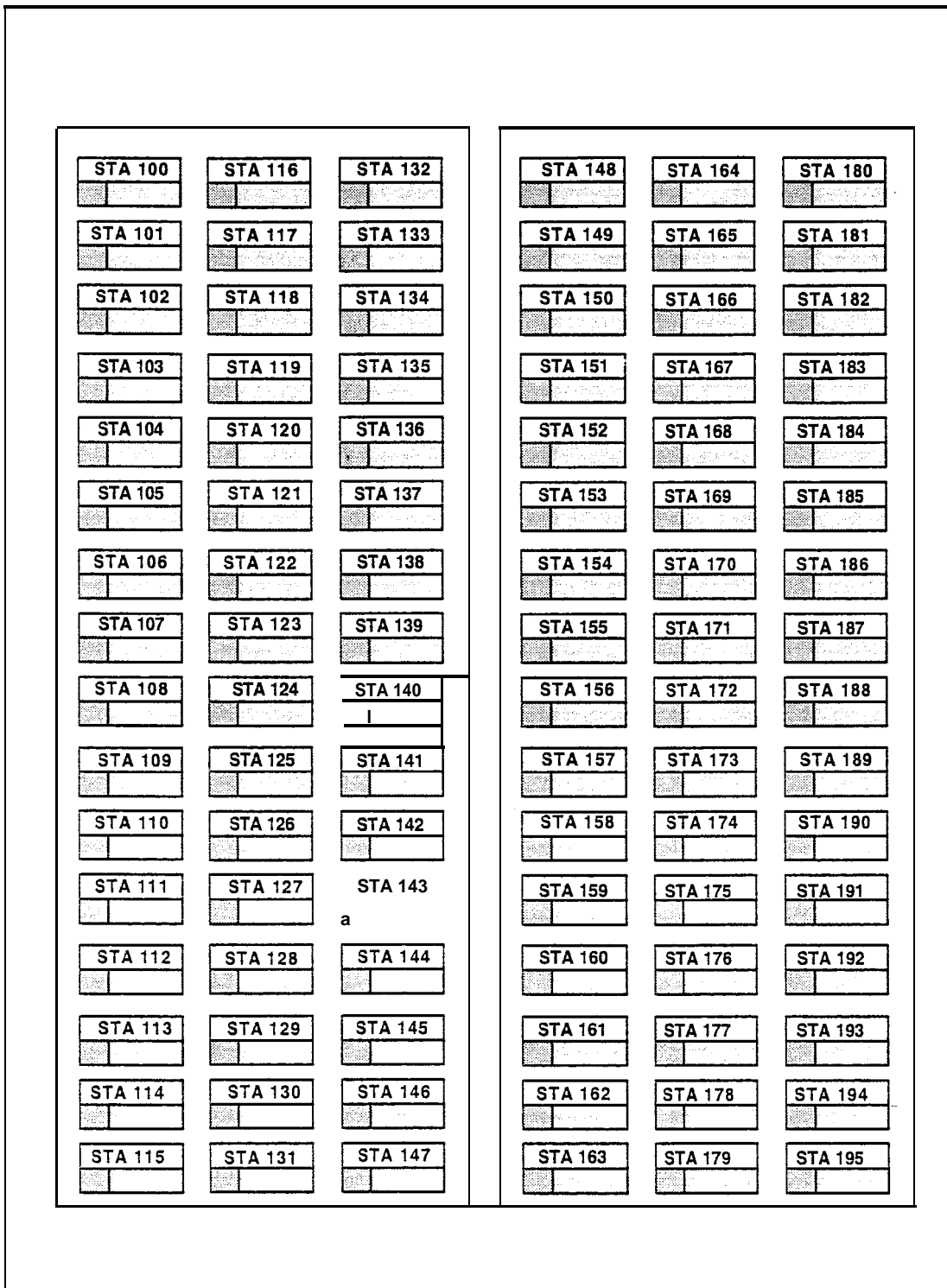

Figure 220-2 DSS Console Map 2 and Map 3

MAP #4 by default contains all 48 CO lines to provide a full CO Line mapping.

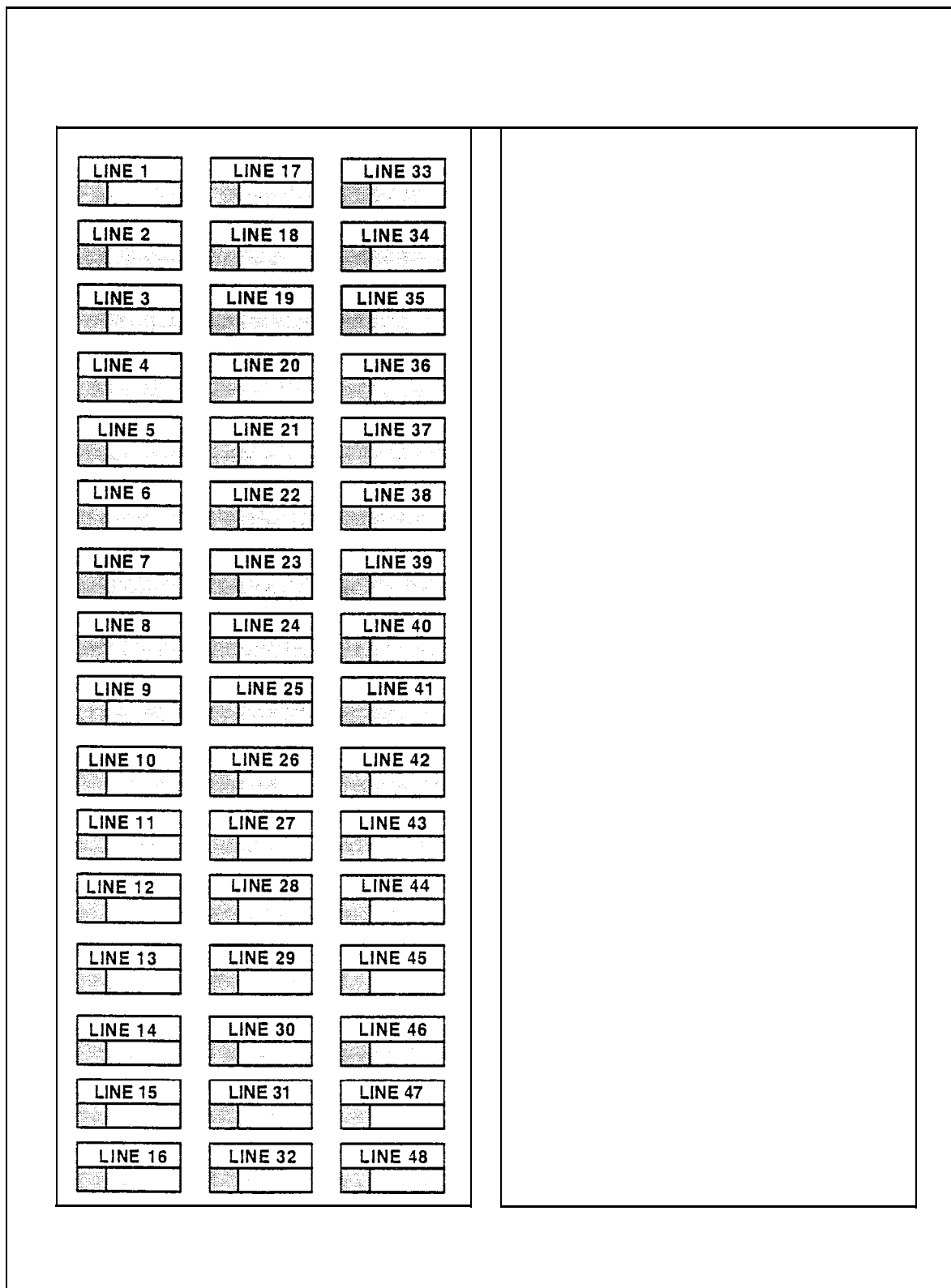

Figure 220-3 DSS Console Map 4



## SECTION 300

# STATION FEATURE OPERATION

### 300.1 INTRODUCTION

The Starplus Digital Key Telephone System has a wide variety of features and flexible programming, allowing each telephone user to program his/her telephone to meet his/her own individual needs.

This section of the manual contains the operating instructions for Digital Key Terminals and includes an illustration of the key telephone used in the Starplus Digital Key Telephone System and description of the keys on the telephones and their functions. It is designed to provide step-by-step instructions for operating the Digital Key Terminals in the system. Visual and audible cues which accompany the various steps in the operation of the features are also included.

Literature similar to these operating instructions has been prepared for use by the customer in the form of a Station User's Guides.

### 300.2 KEY TELEPHONE STATION FEATURES

Each Starplus Digital Key Telephone System provides the following keys, indicators and features:

**HANDSET AND SPEAKER** are located at the left side of the front panel. A handset is provided to allow confidential conversation when desired. Lifting the handset from its cradle (going off-hook) disengages the station's built-in speaker.

The speaker is located directly below the center portion of the handset. The station may be operated with the handset on-hook. When this occurs, audio is transmitted to the station user through the station's speaker.

**FLEXIBLE BUTTONS** are used to access idle outside lines, provide DSS/BLF for internal stations, access speed dial number and activate features. These buttons are programmed by the individual station user. The default flex feature buttons are described below:

**CAMP-ON** (flex) button enables you to alert a busy party that an outside line is on hold and waiting for them. A flex button must be assigned to use this feature.

**LINE QUEUE** (flex) button allows you to queue onto an outside line when all lines in a group are busy. Your station is placed in queue awaiting a line in the same group to become available. A flex button must be assigned to use this feature.

**CALL BACK** (flex) button allows you to initiate an automatic call back request to another busy station. As soon as that station becomes idle, the station that left the call back request is signalled. A flex button must be assigned to use this feature.

**PICK UP** (flex) button allows you to pick up a tone ringing intercom call, transferred, incoming, or recalling outside line call to a specific unattended station either by group or directed call pick-up.

**MSG WAIT (MESSAGE WAIT)** (flex) button allows you to initiate a message waiting indication at stations that are busy, unattended, or in Do Not Disturb. Message Waiting Callback request left at your station will be indicated by a flashing Msg Wait LED.

**FWD (CALL FORWARD)** (flex) button allows you to forward your calls to another station.

**DND (DO NOT DISTURB)** (flex) button allows the user to place his/her telephone into a Do Not Disturb mode to eliminate incoming outside line ringing, intercom calls, transfers and paging announcements. The station in DND can use the telephone to make normal outgoing calls. On Attendant stations, this button becomes the system Night Mode button. A flex button must be assigned to use this feature.

**CONF (CONFERENCE)** (flex) button is used to establish and build conference calls.

#### FIXED FEATURE BUTTONS:

**HOLD** button enables you to place an outside caller on hold.

**TRANSFER (TRANS)** button is used to transfer an outside call from one station to another.

**FLASH** button is used to terminate an outside call and restore dial tone without having to hang up the handset. It is also used to transfer calls behind a PBX or Centrex within those systems.

**SPEED** button provides you with access to speed dialing, save number redial and last number redial. This button is also used to access speed dial and flex button programming.

**MUTE** button allows you to switch the built-in microphone on or off when using the speakerphone, or the handset microphone when using the handset. A flex button must be assigned to use this feature.

**STATION FEATURE OPERATION**

**ON/OFF** button enables you to make a telephone call without lifting the handset. It turns the telephone on and off when using the speakerphone.

**OUTSIDE CALLS** are announced by a tone signal repeated every 3.2 seconds. The corresponding outside line indicator will flash slowly.

**INTERCOM CALLS** can be tone ringing or voice announce. If it is voice announced, the receiving station will receive 2 bursts of tone prior to the announcement. If it is a tone ringing call, the receiving station will hear a tone ring every 2.4 seconds.

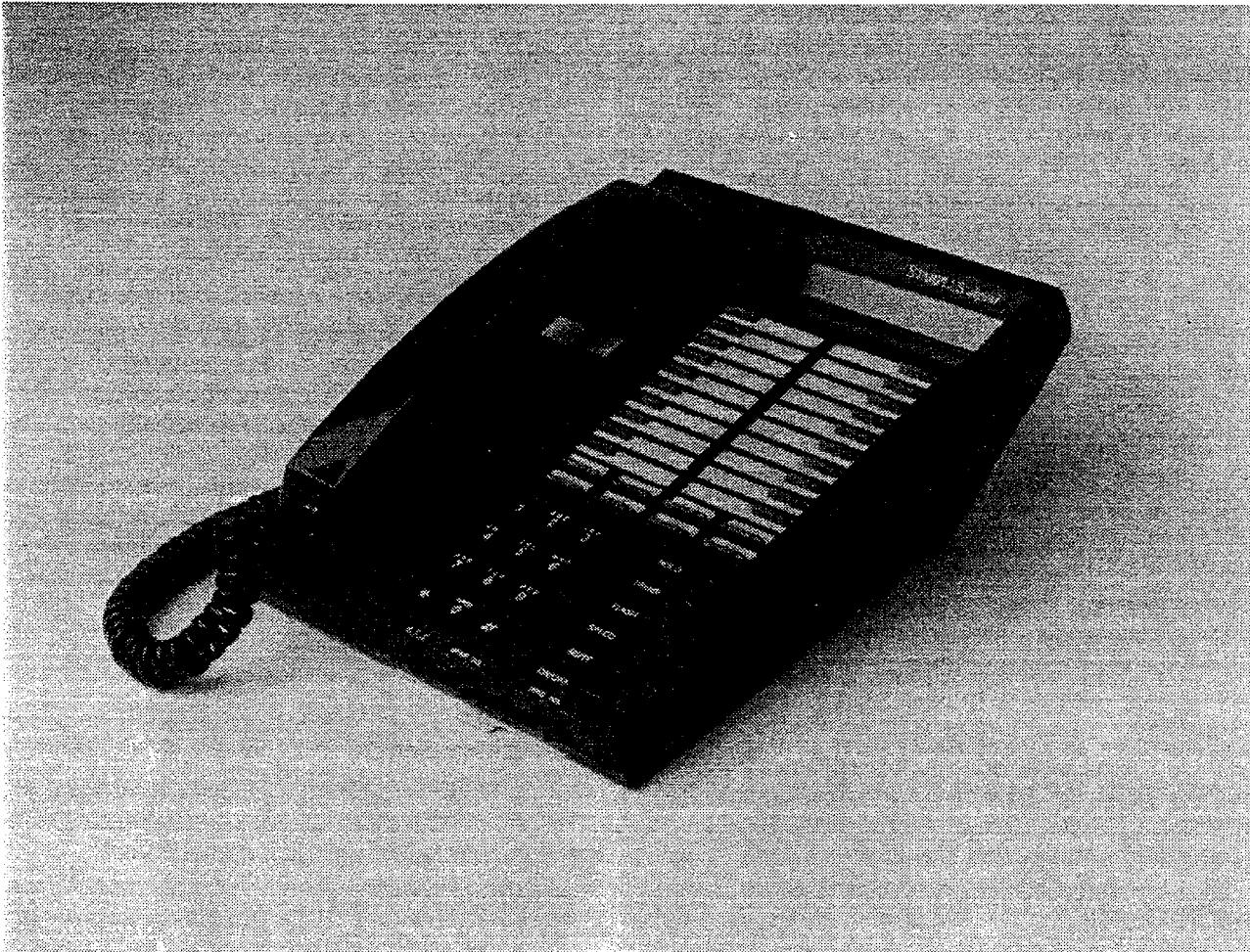

Figure 300-I Executive Digital Display Terminal

Table 300-I Digital Terminal Numbering Plan

100-195	Station intercom Numbers	[FWD]+[9]	Busy/No Answer - Call Forward
420 [XXX]	Voice Mail* enable MSG Wait	[FWD]+[*]	Off-Net - Call Forward
421 [XXX]	Voice Mail* cancel MSG Wait	641	Release Key (Key and Attendant)
43 [C]	Call Park Location O-7 (system)	662	Clear Call Fwd, DND, Personalized Msgs
438	Personal Park	680	Dial Speed Directory
44 [V]	Voice Mail* Group Pilot Numbers O-7	690	Name in Display Programming
45 [H]	Hunt Group Pilot Numbers O-7	691 [BB]	Off-Hook Preference Programming
499	Modem via DISA access or transfer	692	Time & Date Programming (1st programmed Attendant)
55 [U]	ACD* Group Pilot Numbers O-9	695	Distinctive Ringing
55 [U]	UCD Group Pilot Numbers O-7	70	All Call Page (internal & External)
56 [U]	ACD* Group Pilot Numbers IO-15	71	Internal Page Zone 1
566	ACD* or UCD Available/Unavailable	72	Internal Page Zone 2
567 55 [U]	ACD* or UCD Calls in Queue Display	73	Internal Page Zone 3
570 [BB]	ACD* Call Qualifier	74	Internal Page Zone 4
571	ACD' Agent Logout	75	internal All Call Page
572 55 [U]	ACD* Agent Login	76 [O]	External All Call Page (All Zones)
573	ACD* Group Member Status	76 [P]	External Page Zones 1-7
574	ACD* Agent Help	77	Meet-Me-Page Answer
575	ACD* Supervisor Logout	81	CO Line Group 1 (if LCR* is enabled)
576 55 [U]	ACD* Supervisor Login	82	CO Line Group 2
577 55 [U]	ACD' Supervisor Queue Status Display	83	CO Line Group 3
578	ACD* Overflow Sta Available/Unavailable	84	CO Line Group 4
6# [XXX]	Tone Mode Ring Option	85	CO Line Group 5
6*	Dial By Name	86	CO Line Group 6
601	Attendant Override	87	CO Line Group 7
602	Disable Outgoing CO Line Access	88	All CO line Groups (CO Line Off-Net Forward)
603	CO Line Off-Net Forward	9	LCR* or CO Line Group 1 (if LCR' is disabled)
604	Night Service	0	Attendant
620	Camp-On	#0	Group Call Pick Up (Key & SLT)
621	Line Queue	#43 [C]	Call Park Pickup (Key and SLT)
622	Call Back	#5	Universal Night Answer
623	Message Wait	[SPEED] [YY]	Speed Dial Access (00-1 9 Station) (20-99 System)
624	Conference	[SPEED]+[*]	Save Number Redial
625	Executive Override/ ACD* Supervisor Monitor Barge-in	[SPEED]+[#]	Last Number Redial
626	LCR* Queue Cancel		
627	Account Code* Enter		
628	OHVO Enable		
629	MUTE feature		
631	Do Not Disturb		
632	Background Music		
633 [#]	Personalized Message on a Flex Button		
633 [ZZ]	Personalized Messages		
633 [00]	Clear Personalized Messages		
634	Headset Mode		
635	ICLID* Display - (unanswered calls)		
636 [XXX]	Station Relocate		
638+0	Handset Receiver Gain w/display		
[FWD]	All Call Forward		
[FWD]+[7]	No Answer - Call Forward		
[FWD]+[8]	Busy - Call Forward		

XXX = Intercom Station Numbers  
 YY = Speed Dial Bin numbers  
 ZZ = Personalized Messages  
 BB = Button Number  
 U = ACD\* (O-15) or UCD (O-7) Group Number  
 C = Call Park Location O-7  
 H = Hunt Group Number O-7  
 V = Voice Mail\* Group Number O-7  
 P = External Page Zone Number 1-7

\* Features available with optional software

**STATION FEATURE OPERATION****300.3 ANSWERING AN OUTSIDE CALL**

- a. Lift handset or press ON/OFF button.
- b. Press slow flashing outside line button, or Loop button. (If your telephone is programmed with Preferred Line Answer, you may answer an outside line by lifting the handset, or pressing the ON/OFF button.)

**300.4 PLACING AN OUTSIDE CALL ON HOLD**

- a. If your system is programmed for Exclusive Hold Preference, press HOLD button once for Exclusive Hold and twice for System Hold.
- b. If your system is programmed for System Hold Preference, press HOLD button once for System Hold and twice for Exclusive Hold.

**300.5 ANSWERING A RECALL**

When an outside line has remained on hold for an extended period of time, you will be reminded with a recalling ring. (If Preferred Line Answer is enabled, skip step a.)

- a. Press outside line, Loop or Pool button flashing at very fast rate.
- b. Lift handset or press ON/OFF button to converse.

**300.6 ACCOUNT CODES**

*This feature available with optional software.*

When connected to an outside line call:

- a. Press pre-programmed\* ACCOUNT CODE button.
- b. Dial account code up to 12-digits. (The other party will not hear the digits being dialed).
  - if account code is less than 12-digits, an [\*] must be entered to return to the call.
  - If account codes are forced the account code must be entered prior to dialing the outside number.

**NOTE**

*SMDR must be enabled in order for the account code to become part of the SMDR record.*

\*Refer to Sec. 300.37: Flexible Button Assignment.

**300.7 DISABLE OUTGOING CO LINE ACCESS**

The first attendant station can disable CO lines, preventing outgoing CO calls.

- a. Lift handset or press ON/OFF button.
- b. Dial [602] on the dial pad. Confirmation tone is heard
- c. Depress the line button(s) of the CO Line(s) to be disabled. Confirmation tone is heard and the CO Line Button LED is flashing.

To re-activate the CO Line(s), repeat the steps followed to disable it.

**300.8 PLACING AN OUTSIDE CALL (Automatic Line Selection)**

- a. Press outside line or Pool button. ON/OFF button LED will light and dial tone will be heard.
- b. Dial the desired party.
- c. When called party answers, lift handset to converse or use speakerphone.

Station user may also dial the individual trunk group access code to access an outside line.

**300.9 AUTOMATIC CALL DISTRIBUTION (ACD)**

*This feature available with optional software.*

When purchased, Uniform Call Distribution (UCD) is not used and is replaced by the ACD functions identified in the following. 16 Automatic Call Distribution (ACD) groups can be programmed, each containing up to 16 three-digit station numbers.

**A. Agent Login/Logout Feature**

The Agent Login/Logout feature provides a means for an agent to log into one of the ACD groups and receive calls. For an agent to be placed into an active ACD state, the agent must first login. The agent logs in by performing the following steps:

1. Dial the LOGIN CODE [572] on the dial pad, followed by the ACD group number (5xx) that the agent is going to log into.  
or  
Press a pre-programmed\* LOGIN flex button.
2. The agent enters his unique AGENT ID code (0000-9999). The LOGIN flex button LED will be lit steady. Confirmation tone is heard and the agent is logged onto the ACD group. The ON/OFF LED will extinguish if the agent started the sequence in the handsfree mode. When the agent logs in, an ACD login event is sent to the SMDR port, if active.

**NOTE**

*The ACD Agent Log-in LED will only light for the ACD group that is assigned to that button.*

**NOTE**

*If a member is assigned to a specific ACD group and uses the login-logout codes to enter and exit an ACD group other than his assign& group, the database is changed to reflect the different group.*

For an agent to remove himself from the ACD group as an active agent:

1. Dial the LOGOUT CODE [571] on the dial pad,  
or  
Press a pre-programmed\* LOGOUT flex button. LOGIN flex button LED will extinguish.

When the agent logs out and removes himself from the ACD group, an ACD **logout** event is sent to the SMDR port, if active.

**NOTE**

*When an ACD agent has a Login flex button programmed onto his station, that flex button can be used to Login and Logout of the assigned ACD group.*

Conditions:

- If an agent logs into an ACD group from a station that is logged into another ACD group, the station will be automatically removed from the previous ACD group.
- An agent may log out while in wrap-up, or unavailable.
- An agent logging in will first be placed in wrap-up mode before receiving an ACD call.
- If an agent attempts to log into an ACD group that already has 16 members, that agent will receive error tone.
- The Starplus Digital System will not verify agent's ID codes, other than requiring four digits to be entered.

\*Refer to Sec. 300.37, Flexible Button Assignment.

### B. ACD Agent "HELP" button

The ACD Agent "HELP" feature provides a means for an ACD agent to signal his assigned supervisor for assistance. A flex button must be programmed for this feature to operate. Refer to Sec. 300.37, Flexible Button Assignment.

While on a call in progress, the agent:

1. Presses his pre-programmed\* "HELP" flex button. Confirmation tone will be heard by the agent. The agent will see his "HELP" button illuminate if a supervisor is logged into his ACD group. If no supervisor is logged in, the agent will receive a burst of error tone and his "HELP" button will not illuminate.

The ACD supervisor station receives a "HELP" message if a member of one of the ACD groups he is assigned to initiates a "HELP" request. The "HELP" function also sends a Camp-On tone to the speaker of the supervisors keyset. The "HELP" message takes precedence over any other message and can be cleared by the supervisor by pressing his "HELP" button.

At the time the supervisor receives a "HELP" request, he can press his "HELP" flex button followed by his override feature button to bridge onto the ACD group members call. The "HELP" button will place an intercom call to the station requesting "HELP". The "HELP" message will be cleared after the supervisor's

"HELP" button is depressed. In addition, the "HELP" message will be **cleared** if the agent was on a call and **went back on** hook before the supervisor could respond. In this case, the "HELP" message will be converted to a message wait indication. The agent can also clear the "HELP" request by hitting his "HELP" button a second time.

Conditions:

- Up to five messages can be left at any supervisor station.
- The supervisor can cancel the "HELP" request signal by depressing his flashing "HELP" button. In addition, a call will be placed to the agent requesting "HELP". If the agent is on a call, the supervisor can press his barge-in button to monitor the call or give assistance on the call.

**NOTE**

*Only digital terminals can utilize this feature, since a flexible button is required to be programmed.*

### C. ACD Call Qualification

The CALL QUALIFICATION feature provides a means for an Agent to enter codes on ACD type calls that identify the call. This feature provides up to four digits for the ACD SMDR reporting function. This feature permits up to 12 digits to be entered, however only the first four digits are provided for in the SMDR Record.

The QUALIFY button is programmed using flex code [570#]. If the agent wishes to enter his qualify code in a speed bin, he can do so using the standard speed bin programming sequence. Then when he programs his flex button, he can enter 570 followed by the bin number. This will provide an agent with a series of buttons with qualify codes under them. Refer to Sec. 300.37, Flexible Button Assignment.

While on a call, the agent:

1. Presses the pre-programmed CALL QUALIFY flex button, followed by the four-digit qualify code. Enter a [\*] to complete the sequence. A short burst of confirmation tone will be heard thru the keyset speaker, if programmed.

Conditions:

- The outside party will not hear the (qualify code) account code being entered.
- The qualify code uses the first four digits of the account code. Therefore the account code record in the SMDR will contain the qualify code in the first four digits.
- The qualify code must be entered during CO talk state.

## STATION FEATURE OPERATION

- Speed dial entries can contain all digits including the [\*], which will terminate the entry and return the ACD agent to his CO party.

**D. ACD Agent Queue Status Display**

From an idle key telephone:

1. Dial [567] on the dial pad, or press pre-programmed\* flex button.
2. Dial the three-digit ACD group number (5xx). ON/OFF button LED lights steady.
  - The Agent Queue Status display shows the following information:

<p><b>ACD5xx 00 CALLS IN QUEUE</b>  <b>MM/DD/YY      HH:MM am</b></p>
---

Where

– 5xx = ACD Group (550-565)

The above display is an idle state display and will tell the agent and/or his supervisor how many calls are in queue.

3. Replace the handset or press the ON/OFF button to terminate the display.

**NOTE**

*This feature cannot be used with a call in progress and the station will be considered busy for incoming calls during this operation.*

The agent will automatically receive an enhanced Calls in Queue display whenever there is a call in queue.

The display shows the following information:

<p><b>5xx: CIQ: xx AL: xx OC:.. MMM</b>  <b>MM/DD/YY      HH:MM am</b></p>
--

Where

– 5xx = ACD Group (550-565)

– CIQ:xx = Calls in queue

– AL:xx = Agents logged in

– OC:mmm = Oldest call in minutes

\*Refer to Sec. 300.37, Flexible Button Assignment.

**E. ACD Available/Unavailable & Iode**

If you are a ACD agent, you may place your station in the Available mode to receive ACD type of calls or you may place your station in the Unavailable mode to block ACD type calls from ringing your station.

To go Available:

1. Dial [566] on the dial pad, or press the pre-programmed\* Available/Unavailable button. You may now receive ACD calls.

To go Unavailable:

1. Dial [566] on the dial pad, or press the pre-programmed\* Available/Unavailable button. You are now blocked from receiving ACD calls.

\*Refer to Sec. 300.37, Flexible Button Assignment.

**F. ACD Overflow Station - Available/Unavailable Mode**

If you are a ACD Overflow station, you may place your station in the Available mode to receive ACD type of calls or you may place your station in the Unavailable mode to block ACD type calls from ringing your station.

To go Available:

1. Dial [578] on the dial pad, or press the pre-programmed\* Available/Unavailable button. You may now receive ACD calls.

To go Unavailable:

1. Dial [578] on the dial pad, or press the pre-programmed\* Available/Unavailable button. You are now blocked from receiving ACD calls.

**NOTE**

*If no stations are logged into the ACD Group, ACD calls will overflow to the Attendant station,*

\*Refer to Sec. 300.37, Flexible Button Assignment.

**G. Supervisor Login/Logout Feature**

The Supervisor Login/Logout feature provides a means for an supervisor to log into one of the ACD groups and monitor calls.

1. Dial the LOGIN CODE [576] on the dial pad, followed by the ACD group number (5xx) that the supervisor is going to log into, or Press a pre-programmed\* LOGIN flex button. (Flex button must have 576+5xx programmed onto it.)
2. The supervisor enters his unique SUPERVISOR ID code (0000-9999). The LOGIN flex button LED will be lit steady. Confirmation tone is heard and the supervisor is logged onto the ACD group. The ON/OFF LED will extinguish if the supervisor started the sequence in the handsfree mode. When the supervisor logs in, an ACD login event is sent to the SMDR port, if active.

For an supervisor to remove himself from the ACD group as an active supervisor:

1. Dial the LOGOUT CODE [575] on the dial pad, followed by the ACD group number (5xx)

that the supervisor is going to log out of, or  
Press a pre-programmed\* LOGOUT flex button. (Flex button must have 575+5xx programmed onto it). The LOGIN flex button LED will extinguish. When the supervisor logs out and removes himself from the ACD group, an ACD logout event is sent to the SMDR port, if active.

<b>NOTE</b>	<b>The ACD Supervisor Log-in LED will only light for the ACD group that is assigned to that button.</b>
<b>NOTE</b>	<b>When an AC5 Login flex button is programmed in the system, that same flex button can be used to toggle the Login/Logout feature.</b>

Conditions:

- If a supervisor logs into an ACD group from a station that is logged into another ACD group, the station will remain in the previous ACD group.
- A supervisor may log out while in wrap-up, or unavailable.
- A supervisor logging in will first be placed in wrap-up mode before receiving an ACD call.
- If a supervisor attempts to log into an ACD group as an agent and that group already has 16 members, the supervisor will receive error tone.
- The Starplus Digital System will not verify supervisor's ID codes, other than requiring four digits to be entered.

\*Refer to Sec. 300.37, Flexible Button Assignment.

**H. Supervisor Monitor With Barge-in**

The Supervisor Monitor with Barge-In feature will provide a means for an ACD supervisor to monitor an agent's call in progress in order to coach sales techniques or customer relations skills. When used, a supervisor may intrude onto an agent's call in a listen only mode or in a true conference mode by use of the barge-in feature. This feature is available with or without a warning tone.

<b>NOTE</b>	<b>The use of silent monitor and barge-in is limited by federal law and may also be limited or prohibited by state or local law, so check the relevant laws in your area before employing these features.</b>
-------------	---

The ACD supervisor can intrude on an agent's call in the listen only mode by:

1. Dial the three-digit station number of the agent's station. Upon hearing busy tone, press the pre-programmed\* Barge-in flex button. The conversation in progress will be

heard by the Supervisor on the handset receiver and the Supervisor's MUTE button LED is lit indicating that the Supervisor's transmit is muted. If the Supervisor wishes to participate in the conversation in a true conference mode, he can depress his MUTE button which removes mute.

<b>NOTE</b>	<b>The Executive Override Code, [625] is used to program Supv Monitor with Barge-In feature onto a flex button.</b>
<b>NOTE</b>	<b>Only digital terminals or SLT stations may be intruded using this feature.</b>

Conditions:

- Supervisors are granted the Barge-In option if they log in at a station with the Supervisor Barge-In/Executive Override enabled in programming.
- Supervisors can only Barge-In on calls of members of the ACD group(s) that they are logged into.
- Warning tone is enabled and disabled using the Executive override warning tone option (FLASH 05, button 4).
- Supervisor stations must be digital terminals.

**1. Supervisor Queue Status Display**

The Supervisor Queue Status feature will provide a means for an ACD supervisor to view the status of their ACD group. This display is an idle state display and will prompt a Supervisor that a group is having problems answering all their calls. The display will tell the supervisor how many calls are in queue, how many agents are logged into the ACD group, and the length of time in minutes that the oldest call has been in queue.

The supervisor station logged onto the ACD group can obtain the Queue Status display by:

1. Dialing the Queue Status code [577] on the dial pad, followed by the ACD group (5xx) the supervisor wants to observe,  
or

Press the pre-programmed\* flex button. The Queue Status display show the following information:

---

**5xx: CIQ: xx AL: xx OC: MMM  
MM/DD/YY      HH:MM am**

---

Where

- 5xx = ACD Group (550-565)
- CIQ:xx = Calls in queue
- AL:xx = Agents logged in
- OC:mmm = Oldest call in minutes

**STATION FEATURE OPERATION**

If the supervisor wants to change the display to a different group:

1. Dials the Queue Status code [577] on the dial pad, followed by the ACD group that he wishes to observe,  
or  
Presses the pre-programmed\* flex button.

Conditions:

- To receive the Supervisor's Queue Status display, the station must be logged in as a Supervisor and dial the flex code for the appropriate group.
- ACD Supervisors will receive the Queue Status display in real time.
- The Queue Status display is only given when the **ACD** group member or Supervisor's station is not receiving a higher priority display, such as "HELP" or Out-Of-Service, or other applicable off-hook events are taking place at the station.
- The Supervisor's Queue Status display is saved in battery backed memory.
- When a Supervisor logs out of the group he is presently displaying, he must enter a new request for Queue Status display.

**J. ACD Group Member Status**

The ACD Group Member Status feature provides a means for an ACD Supervisor/Agent to view the status of the eight ACD groups in the system. This display will tell the Supervisor/Agent which stations are logged into the group, and if the station logged in is Available/Unavailable, Out-Of-Service, in DND, or busy on a call. The Supervisor/Agent could use this display to determine why there are a lot of queued calls in a specific group.

Any station (Supervisor or Agent) logged onto the ACD group can bring up the group members display by:

1. Dialing the ACD Group Member Status code [573] on the dial pad,  
or  
Pressing the pre-programmed\* flex button.  
The display now shows ACD Group 550.

The status of the ACD agents will be displayed with a letter following the station number that the agent is logged in at.

<b>ACD5xx: 110A 111A 112A 1130 114U 115D 116B 117N</b>
--

The status will be displayed with the following priority:

Where:

- (N) = Not Equipped
- (D) = Do not Disturb
- (O) = Out of service
- (U) = Unavailable
- (B) = Busy on a-call
- (A) = Available

i.e.: If an agent made a call while out of service his status would be out of service, not busy.

2. Dial an [\*] on the dial pad to scroll up to the next **ACD** Group. If more than eight members are in the ACD group, the next depression of the [\*] will display the additional members,  
or  
Dial a [#] on the dial pad to scroll down to the previous ACD Group. To return to an idle display, the Supervisor/Agent station returns to on-hook condition.

Conditions:

- The ACD Group Members Status display will be updated at the time the code is dialed.

**300.10 BACKGROUND MUSIC (Optional)**

- a. Dial [632] on the dial pad,  
or  
press the pre-programmed\* flexible button.  
(music is heard)
- b. Dial [632] on the dial pad again,  
or  
press the pre-programmed\* flexible button again, and music is discontinued.
- c. When you pick up the handset  
or  
Press the ON/OFF button, music is discontinued automatically.

\*Refer to Sec. 300.37, Flexible Button Assignment.

**300.11 AUTOMATIC SELECTION**

Pressing an outside line button, or pool button; a speed button; a station button; or dialing a number in the Starplus Digital Key Telephone System numbering plan, will automatically activate the speakerphone and light the ON/OFF button, if your keyset is programmed as a speakerphone.

**300.12 CALL BACK**

If you dial a telephone that is busy and want to activate Call Back:

- a. Press the pre-programmed\* CALL BACK button.
- b. Hang up.



- c. When busy station hangs up, you will be signaled.
- d. Answer the call; station you called will then be signaled. (If your station is busy when signaled, an automatic MSG will be left at your phone.)

**NOTE**

*When the Automatic CallBack Timer is enabled, a call back request will automatically be invoked anytime a user listens to intercom busy tone for a preset period of time.*

**NOTE**

*Only one Call Back request can be left at a station; the second request will be converted to a message wait call back request*

\*A flex button must be programmed for this feature to operate. Refer to Sec. 300.37, Flexible Button Assignment.

**300.13 CALL FORWARD: STATION****A. Call Forward - All Calls**

If you have been given the ability to forward your calls:

1. Lift handset or press ON/OFF button.
2. Press the pre-programmed\* FWD button.
3. Press DSS button of desired station, or  
Dial the three-digit extension number where calls are to be forwarded, including ACD or UCD, Voice Mail, and Hunt group pilot numbers.
4. Replace the handset or press the ON/OFF button.

Refer to Sec. 305.4, Call Forward-Stations for 8-button operation of this feature.

Conditions:

- Line Queue, Call back requests, message wait requests, and pre-selected messages are canceled when a station activates call forward.
- Call back requests are not allowed at a station where a call is forwarded.
- CO Line calls can be transferred by the receiving station back to the original forwarded station.
- A station in the call forward mode may still make outgoing calls.

To remove Call Forwarding:

1. Lift handset or press ON/OFF button.
2. Press the pre-programmed\* FWD flex button. Confirmation tone will be heard and the FWD LED is extinguished.

\*Refer to Sec. 300.37, Flexible Button Assignment.

**B. Call Forward - No Answer**

If you have been given the ability to forward your calls:

1. Lift the handset or press ON/OFF button.
2. Press the pre-programmed\* FWD button.
3. Dial the Call Forward No-Answer code [7] on the dial pad.
4. Dial the three-digit extension number where calls are to be forwarded. Confirmation tone will be heard.
5. Replace the handset or press the ON/OFF button.

Refer to Sec. 305.4, Call Forward-Stations for 8-button operation of this feature.

To remove Call Forwarding:

1. Lift the handset or press the ON/OFF button.
2. Press the pre-programmed\* FWD button. Confirmation tone will be heard and the FWD LED is extinguished.

\*Refer to Sec. 300.37, Flexible Button Assignment.

**C. Call Forward - Busy**

If you have been given the ability to forward your calls:

1. Lift the handset or press ON/OFF button.
2. Press the pre-programmed\* FWD button.
3. Dial the Call Forward Busy code [8] on the dial pad.
4. Dial the three-digit extension number where calls are to be forwarded. Confirmation tone will be heard.
5. Replace the handset or press the ON/OFF button.

Refer to Sec. 305.4, Call Forward-Stations for 8-button operation of this feature.

To remove Call Forwarding:

1. Lift the handset or press the ON/OFF button.
2. Press the pre-programmed\* FWD button. Confirmation tone will be heard and the FWD LED is extinguished.

\*Refer to Sec. 300.37, Flexible Button Assignment.

**D. Call Forward - Busy/No Answer**

If you have been given the ability to forward your calls:

1. Lift the handset or press ON/OFF button.
2. Press the pre-programmed\* FWD button.
3. Dial the Call Forward Busy/No Answer code [9] on the dial pad.

**STATION FEATURE OPERATION**

4. Dial the three-digit extension number where calls are to be forwarded. Confirmation tone will be heard.
5. Replace the handset or press the ON/OFF button.

Refer to Sec. 305.4, Call Forward-Stations for 8-button operation of this feature.

To remove Call Forwarding:

1. Lift the handset or press the ON/OFF button.
2. Press the pre-programmed\* FWD button. Confirmation tone will be heard and the FWD LED is extinguished.

\*Refer to Sec. 300.37, Flexible Button Assignment.

**E. Call Forward - Off-Net (via speed dial)**

This feature allows stations to forward intercom and transferred CO calls to an off-net location.

In a speed dial bin, store the number of the off-net location where calls are to be forwarded. Follow instructions provided for storing station or system speed dial numbers.

1. Lift handset or press ON/OFF button.
2. Press the pre-programmed\* FWD button.
3. Dial [X] on the dial pad. Dial the speed bin number that contains the number where calls are to be forwarded. Confirmation tone is heard. FWD button LED is flashing.
4. Replace the handset or press the ON/OFF button.

Refer to Sec. 305.4, Call Forward-Stations for 8-button operation of this feature.

Conditions:

- Line Queue, Call back requests, message wait requests, and pre-selected messages are canceled when a station activates call forward.
- Call back requests are not allowed at a station where a call is forwarded.
- CO Line calls can be transferred by the receiving station back to the original forwarded station.
- A station in the call forward mode may still make outgoing calls.

To remove Off-Net Forwarding

1. Lift handset or press ON/OFF button.
2. Press the pre-programmed\* FWD button. Confirmation tone will be heard and the FWD button LED is extinguished.

\*Refer to Sec. 300.37, Flexible Button Assignment.

**F. Call Forward - ACD or UCD Groups**

If you have been given the ability to forward your calls:

1. Lift the handset or press ON/OFF button.
2. Press the pre-programmed\* FWD button.
3. Dial the desired code:
  - [7] = no answer calls
  - [8] = busy calls
  - [9] = busy and no answer calls.

**NOTE** Skip the preceding step for immediate forwarding.

4. Dial the three-digit ACD or UCD group pilot number (550-565) for the group (1-1 6) where calls are to be forwarded. Confirmation tone will be heard.
5. Replace the handset or press the ON/OFF button.

Refer to Sec. 305.4, Call Forward-Stations for 8-button operation of this feature.

\*Refer to Sec. 300.37, Flexible Button Assignment.

To remove Call Forwarding:

1. Lift the handset or press the ON/OFF button.
2. Press the pre-programmed\* FWD button. Confirmation tone will be heard and the FWD LED is extinguished.

\*Refer to Sec. 300.37, Flexible Button Assignment.

**G. Call Forward - Voice Mail Groups**

Intercom and Transferred CO callers may be routed directly to your mail box by forwarding your phone to a voice mail group. Callers will then be greeted by your personal voice mail greeting if available.

If you have been given the ability to forward your calls:

1. Lift the handset or press ON/OFF button.
2. Press the pre-programmed\* FWD button.
3. Dial the desired code:
  - [7] = no answer calls
  - [8] = busy calls
  - [9] = busy and no answer calls.

**NOTE** Skip the preceding step for immediate forwarding.

4. Dial the three-digit Voice Mail group pilot number (440-447) for the group (1-8) where calls are to be forwarded. Confirmation tone will be heard.
5. Replace the handset or press the ON/OFF button.

Refer to Sec. 305.4, Call Forward-Stations for 8-button operation of this feature.

To remove Call Forwarding:

1. Lift the handset or press the ON/OFF button.
2. Press the pre-programmed\* FWD button. Confirmation tone will be heard and the FWD LED is extinguished.

\*Refer to Sec. 300.37, Flexible Button Assignment.

#### H. Call Forward - Hunt Groups

If you have been given the ability to forward your calls:

1. Lift the handset or press ON/OFF button.
2. Press the pre-programmed\* FWD button.
3. Dial the desired code:
  - [7] = no answer calls
  - [8] = busy calls
  - [9] = busy and no answer calls.

#### NOTE

*Skip the preceding step for immediate forwarding.*

4. Dial the three-digit Hunt group pilot number (450-457) for the group (1-8) where calls are to be forwarded. Confirmation tone will be heard.
5. Replace the handset or press the ON/OFF button.

Refer to Sec. 305.4, Call Forward-Stations for 8-button operation of this feature.

To remove Call Forwarding:

1. Lift the handset or press the ON/OFF button.
2. Press the pre-programmed\* FWD button. Confirmation tone will be heard and the FWD LED is extinguished.

\*Refer to Sec. 300.37, Flexible Button Assignment.

#### 300.14 CALL FORWARD: PRESET

If a CO Line forwarded by Preset Call Forward encounters a manually forwarded station (Call Forward - Station), or a station in DND, then the incoming CO Line will bypass that station and forward to the next in the chain. If that station is the last in the chain, then the call will not forward any further and will continue to ring at that station until answered or terminated.

#### 300.15 CALL FORWARD: CO LINES

##### A. Incoming CO Lines Off-Net (via speed dial)

This feature allows the first attendant station to forward incoming CO calls to an off-net location.

In a speed dial bin, store the number of the off-net location where calls are to be forwarded.

Follow instructions provided for storing station or system speed dial numbers.

1. Dial [603] on the dial pad.
2. Dial the CO group access code for the CO Line group to be forwarded, or  
Press an individual CO Line button.
  - [81] = CO Group 1
  - [82] = CO Group 2
  - [83] = CO Group 3
  - [84] = CO Group 4
  - [85] = CO Group 5
  - [86] = CO Group 6
  - [87] = CO Group 7
  - [88] = All CO Lines
3. Dial the speed bin number that contains the number where calls are to be forwarded. Confirmation tone is heard.

To remove Off-Net Forwarding

- a. Dial [603] on the dial pad.
- b. Dial the CO group access code, or  
press an individual CO Line button.
- c. Dial [#] on the dial pad. Confirmation tone is heard.

#### 300.16 CALLING STATION TONE MODE OPTION

Allows a calling station to override a called stations "H" or "P" intercom switch settings.

When placing a call to a station and Tone ringing is desired:

- a. Dial [6#] on the dial pad.
- b. Dial the three-digit extension number, or  
Press DSS button of desired station. (call tone rings station).

#### 300.17 CALL PARK

To place an outside call in park and consult with page, or call an internal party:

While connected to an outside line:

- a. Press TRANS button. The-caller is put on Exclusive hold.
- b. Dial parking location (430 to 437). Confirmation tone is heard.
- c. If you hear busy tone, press TRANS twice and dial another parking location.

Retrieving a Parked Call

- a. Lift handset or press ON/OFF button.
- b. Press the pound [#] button.

## STATION FEATURE OPERATION

- c. Dial parking location (430 to 437) where the call was parked.

## 300.18 CALL PICK-UP: GROUP

When intercom tone ringing, transferred outside line ringing, recall ringing or initially ringing call is heard at an unattended telephone:

- Lift the handset or press the ON/OFF button.
- Dial [#0] on the dial pad, or press the pre-programmed\* PICK UP button to be connected to the calling party.

**NOTE**

*You must be in the same pick up group as the ringing telephone to pickup the call.*

## 300.19 CALL TRANSFER

Outside lines can be transferred from one phone to another within the system. The transfer can be either screened (announced) or unscreened to either an idle or busy station, ACD or UCD Group, or Hunt Group.

## Screened Transfer

While connected to an outside line:

- Press station button where call is to be transferred (if programmed on your telephone), or press TRANS button and dial three-digit station number (100 to 195).
- The called extension signals according to the intercom signal switch position.
- When that extension answers, announce the transfer.
- Hang up to complete transfer.

## Unscreened Transfer

When the called extension begins to signal, hang up to transfer the call (Recall timer starts).

## Transfer Search

When attempting to locate a party:

- Press a station button to signal the desired station.
- If the party is not located, press another station button to continue the search.

If the party is not located:

- Press another station button to continue the search.
- When the called party answers, hang up to complete the transfer.

## Answering a Screened Transfer

- Your intercom will be signaling according to the intercom signal switch position.

- Answer the intercom and receive the transfer notice.

- Press the outside line button or loop button flashing on hold.

## 300.20 TRANSFERRING CO CALLS TO A STATION FORWARDED TO VM

While connected to a CO line:

- Press the TRANS button and dial the extension number of the station forwarded to voice mail.
- The transferring station hangs up. The CO call will be directed to the mailbox of the forwarded station.

**NOTE**

*If the transferring station attempts to supervise the transfer or just waits until the voice mail system answers, then it becomes necessary to m-access the CO line and re-transfer them and go on-hook before the voice mail system answers. This will ensure that the CO party will hear the personal greeting of the mailbox user and any applicable instructions.*

## 300.21 CAMP-ON

If you call a station that is busy and wish to alert them to your call:

- Press the CAMP-ON button. Called station will receive one-burst of ringing. Wait for their response
- When called party answers, consult with them or hang up to transfer the call.

**NOTE**

*If a station is in DND, on/y the attendant can Camp On using the attendant override feature.*

## Answering a Camp-On

If you are on a connected call, hear one burst of muted ringing, and your CAMP-ON button is flashing, you have a call waiting for you.

To answer:

- Press the CAMP-ON button. Any outside line you are connected to will be placed on hold. You may converse with the station placing the call.
- Press flashing outside line button, if a call is being transferred.

If you do not have a Camp-On button either:

- Go on-hook with present call. Camp-On will ring through, or place present call on hold. Then go on-hook. Camp-On will ring through.

**300.22 CO LINE ACCESS**

To access outside line:

- a. Press idle CO line button, Pool button, or dial CO line group access code or LCR access code.
- b. Dial number desired for outside call.
- c. Lift handset to converse or use speakerphone.

**300.23 CO LINE QUEUING**

A station can queue only one line at a time. If you see that a particular outside line is busy and you wish to be placed on a list waiting for that line to become available:

To Place a Queue:

- a. Press desired busy outside line button, or pool button. (Busy tone is heard)
- b. Press pre-programmed\* LINE QUEUE button.
- c. Replace handset or press ON/OFF button.

To Answer a Queue:

If you hear ringing and an outside line of the line group (or a Loop or Group Key), you queued onto is rapidly flashing:

- a. Lift handset or press ON/OFF button.
- b. Press flashing outside line button to answer.

**NOTE**

*If your station has been programmed for Preferred Line Answer, you will have the line automatically upon lifting the handset.*

\*A flex button must be programmed for this feature to operate. Refer to Sec. 300.37, Flexible Button Assignment.

**300.24 CONFERENCE COMBINATIONS**

Only stations that have conference enabled will be able to institute a conference.

- Add-on Conference: Four internal and one external or five party internal
- Multi-Line Conference: One internal and two external.

**NOTE**

*A maximum of five parties can be included in a conference.*

Establishing a Conference

- a. Lift handset.
- b. Select intercom station or dial desired outside party.
- c. When called party answers, press the pre-programmed\* CONF button.
- d. Add next conference party by selecting another outside line or intercom station.

e. When party answers, press the pre-programmed\* CONF button twice.

f. All parties are connected.

Exiting a Conference (Controller only)

There are three methods of exiting a conference:

1. -Press the ON/OFF button to ON, press the MUTE button; and replace the handset (to monitor a conference).

Use the following method only if multi-line conference is in progress:

2. Press HOLD button to place outside parties on hold. Hold timer starts. If one of the two parties is internal, that party will be dropped.
3. Press the pre-programmed\* CONF and hang up or press the ON/OFF button to leave the other conference parties still connected in an unsupervised conference. CONF button will flash and timer will start. There will be a warning tone before the other parties are dropped.

Re-entering a Conference

When the controller re-enters the conference, the disconnect timer is reset.

- a. Lift handset to re-enter a monitored conference.
- b. To re-enter a conference placed on hold, repeat steps for establishing a conference.
- c. To re-enter an unsupervised conference, lift handset and press flashing pre-programmed\* CONF button. The CONF button lights steady and confirmation tone will be heard.

Terminating a Conference

To terminate a conference, the conference initiator who is actively in the conference:

- a. Replaces handset or push ON/OFF button to OFF.

To terminate an unsupervised conference:

- a. Pressing the flashing pre-programmed\* CONF button while on hook, all parties will be dropped.

\*Refer to Sec. 300.37, Flexible Button Assignment.

**300.25 DATA FEATURE**

The Data Feature is a time division switched, point to point data transmission capability-which permits simultaneous voice and data communications (within the same system but not the same port). The Data Feature offers the ability to transmit data information between personal computers, printers, plotters, modems, CRT terminals, and main frame computer ports.

To establish a Data call a Digital Data Interface Unit (DDIU) is required to be connected to each data communications device. Data information can be switched through the system at speeds of 300, 1200,

**STATION FEATURE OPERATION**

2400, 4800, 9600, 19.2K and 38.4K baud asynchronous.

To establish a connection to any idle data port:

- a. A user with an associated **DDIU** dials the station number of the **DDIU** or the group access number of the groups that the **DDIU** has been inserted into or depresses a **DSS** button representing the **DDIU**. The key system will then determine the baud rate setting for the called **DDIU** and convert the user's associated **DDIU** to the same baud rate. The system will then complete the connection,

A second method to establish a connection between two **DDIU** is done by the first attendant.

- a. The first attendant dials the extension number of one data unit. Dial tone is received and the display will show the **BAUD RATE**.
- b. The first attendant then dials the station number of the second data unit. Confirmation tone is heard. This connection will be maintained until the first attendant dials the station number of one **DDIU** followed by pressing the **FLASH** button.

To break down an established connection:

- a. The user dials his associated **DDIU** number or depress the **DSS** button for the associated **DDIU**.
- b. Press the "FLASH" button.

A station user can configure his associated **DDIU** by:

- a. Dialing the **DDIU** access code [637] on the dial pad.
- b. Enter the three-digit extension number of the **DDIU**. The display will show the Baud Rate setting, the character length (8 or 9), and the number of stop bits (1 or 2).

To change the Baud Rate:

- a. Press the **HOLD** button, Then enter the desired one-digit Baud Rate.
  - [1] = 300
  - [2] = 1200
  - [3] = 2400
  - [4] = 4800
  - [5] = 9600
  - [6] = 19.2K
  - [7] = 38.4K
- b. Press the **SPEED** button to save any changes made.

To change the character length:

- a. Press the **TRANS** button. Then enter the desired one-digit character length, either 8 or 9.

- b. Press the **SPEED** button to save any changes made.

To change the number of stop bits:

- a. Press the **MUTE** button. Then enter the desired one-digit stop bit, 1 or 2.
- b. Press the **SPEED** button to save any changes made.

Refer to Station Attributes Programming, 630.2, Station Identification for programming the Station ID of the Digital Data Interface Unit (**DDIU**). Also refer to Sec. 630.3, Digital Data Interface Unit (**DDIU**) for programming the parameters of the Digital Data Interface Unit (**DDIU**).

Conditions:

- The system is transparent to the devices being connected. Therefore each **DDIU** must be configured with a specific baud rate, number of data bits and number of stop bits. This configuration will be done by the first attendant or in the case of an associated data unit can be configured by the user.
- Data ports can be arranged in **ACD/UCD** Groups or **Hunt** Groups.
- Data ports do not have to be associated with a **keyset**, however to connect two **DDIU** devices one of them must be associated with a **keyset** unless the connection is made by the first attendant.
- When the data connection has been completed, the baud rate used in the connection will be displayed on the **keyset**.
- Non associated **DDIU** connections can be broken down by the first attendant.
- A **DDIU** has a **DCE** interface. Therefore a straight through **RS-232C** cable can be used connect to a **DTE** device (printer, PC, etc.).
- Each **DDIU** requires a digital terminal port.

### 300.26 DIAL BY NAME

The system will allow station users to dial extension numbers by entering a name of a person that has been programmed for that station. The system database will allow entry of a name (alphanumeric) up to 24-characters in length for each station. This programmed name can be used for dialing-by-name station users and in some cases **LCD** displays.

To dial a station user by name:

- a. Dial the Dial-By-Name code [6\*] on the dial pad, or

press the pre-programmed\* DIAL-BY-NAME flex button.

- b. Dial the desired person's name using the keys on the key pad. For example: if you wanted to call Linda Murphy, and last names were entering into the directory dialing list, you would press the digit 6 (M), then the digit 8 (U), then the digit 7 (R), the digit 7 again (P), the digit 4 (H) and finally the digit 9 (Y).

ALPHA NUMERIC CHARACTER	DIGIT
A,B,C	2
D,E,F	3
G,H,I	4
J,K,L	5
M,N,O	6
P,Q*,R,S	7
T,U,V	8
W,X,Y,Z*	9
*does not appear on dial pad.	

- When the system finds a unique numeric match (MURPHY=687749) to the name being dialed, the call will be placed to the station matching the name. The intercom call will signal the station according to the H-T-P switch setting. If fewer than 8 digits are dialed, the numeric match will be dialed after a 10 sec. interdigit time-out occurs, or if a "#" (pound), is pressed.

\*Refer to Sec. 300.37, Flexible Button Assignment.

Conditions:

- The system will dial the station that matches the dialed name when a unique match is found. If multiple names are located (found) after 8 digits, the first one is dialed.
- The names will be entered as a part of the system attributes database. Numbers may be entered as part of a name. To avoid conflicts, all names must have a unique numerical sequence.

**300.27 DIRECTED CALL PICK-UP**

When incoming, transferred, or recalling outside line ringing, intercom ringing, or Camp On ringing is heard at an unattended telephone:

- a. Dial the station number of the known ringing telephone. Receive ringback tone, or call announce tone.
- b. Press the pre-programmed\* PICK UP button to answer the call.

\*A flex button must be programmed for this feature to operate. Refer to Sec. 300.37, Flexible Button Assignment.

Conditions:

- User must have access to the specific outside line or a Loop button to do a directed call pickup.

**3 0 0 . 2 8 DIRECTORY DIALING - Stations**

Directory dialing allows station users to obtain a directory of station users and have the system dial the extension that is currently on the display. The Starplus SPD 4896 system provides locations for up to 200 names.

Directory dialing also allows users to program a "name" along with a speed dial bin for use in later locating a speed dial number. When prompted to do so, the system will display the name associated with a speed dial number on the LCD display so that when the desired name is shown, the user may then have the system dial the number.

Directory dialing also allows users to associate a "name" with an entry in the local number/name translation table. When prompted to do so, the system will display the name associated with the table on the LCD display so that when the desired name is shown, the user may then have the system dial the number. The Starplus SPD 4896 system provides locations for up to 200 names.

The Directory Dialing list may be programmed and maintained at the first assigned attendant station in one of two ways, however this admin routine provides a means for the directory list to be maintained by the system programmer either locally (at Station 100) or remotely via modem access.

Directory dialing may also be used to transfer a call from one station to another.

To view the directory list:

- a. Dial the Directory List dial code [680] on the dial pad, or press the pre-programmed\* flex button programmed as a directory dialing button.
- b. Press a button on the key pad, once, twice or three times, to represent the letter of the alphabet, to begin viewing the list of names. (i.e. the first depression of the digit "2" produces the names beginning with an "A". The second depression of the digit "2" produces the names beginning with a "B", while the third depression of the digit "2" produces the names beginning with a "C".) The letters of the alphabet are represented on the key pad as follows:

ALPHA NUMERIC CHARACTER	DIGIT
A,B,C	2
D,E,F	3

## STATION FEATURE OPERATION

G,H,I	4
J,K,L	5
M,N,O	6
P,Q*,R,S	7
T,U,V	8
<del>W,X,Y,Z*</del>	<del>9</del>
*does not appear on dial pad.	

- c. Names beginning with the letter chosen will appear on the LCD display.

**NOTE**

*If there are no names in the Directory List beginning with the desired letter, a name with the next higher letter will be shown on the LCD display.*

- d. Dial an [\*] on the dial pad to scroll up (next entry) through the list,  
or  
Dial a [#] on the dial pad to scroll down (previous entry) through the list,  
or  
press another button to view the list for a different letter of the alphabet.
- e. When the desired name is shown on the LCD display, pressing the SPEED button will automatically dial the destination station or outside phone number (via speed dial).

## Conditions:

- If the desired party is an intercom station, that station will be signaled according to that station's intercom selector switch (SLT stations will tone ring).
- If the desired party is associated to a speed dial bin, the system will select a CO line and dial the number programmed into the speed dial bin. Call progress tones will then be heard.

## To Transfer a Call using Directory Dialing:

## While on a call:

- Press the TRANS button.
- Dial the Directory Dial Code [680] on the dial pad,  
or  
press a pre-programmed\* flex button programmed for directory dialing.
- Press the digit associated with the person's name and when it is displayed, press the SPEED button to automatically dial the destination station.
- Hang up to complete the transfer.

**NOTE**

*Calls may only be transferred to internal stations only. An attempt to transfer a call off-net (via a Speed dial bin) will result in the call recalling upon going on-hook*

\*Refer to Sec. 300.37, Flexible Button Assignment.

**300.29 DIRECT INWARD SYSTEM ACCESS (DISA)**

- Call the phone number the system administrator specified as the DISA line. The system answers and returns intercom dial tone.
- Enter the DISA access code also specified by the system administrator; if applicable. Dial tone is returned.

To place an outgoing call:

- Dial a group access code: 9, 81 - 87. CO Dial tone is returned.
- Dial the desired telephone number.

**NOTE**

*LCR cannot be accessed from DISA. If LCR is enabled, DISA users may dial 81 to access lines in trunk group 1.*

**NOTE**

*The conference timer (Refer to Sec. 610.1, System Timers) will monitor a DISA "trunk-to-trunk" call and release the lines one (1) minute after the time expires.*

To reach an internal station:

- Dial the three-digit station number. Ringback tone will be heard.
- Converse when party answers.

**NOTE**

*If the station dialed is unattended, busy or in DND, intercom dial tone will be returned. (after the Preset Call Forward Timer expires) Refer to Sec. 610.7, System Timers.*

**300.30 DISTINCTIVE RINGING**

The tone ring signal used to notify stations of an incoming call can be changed by each station user to provide distinctive ringing among a group of stations. Each station user may select a distinctive ringing tone that will be used to ring their station. The system provides 81 different ring patterns that each station user may select from.

To select a distinctive ring tone for a station:

- Dial the Tone Ring program code [695] on the dial pad.
- Enter the two-digit tone number. The telephone speaker will sound a steady tone that correlates to the two digit entry.
- When the desired tone is selected, press the SPEED button to save this as the tone to be presented when the station is tone rung. Confirmation tone will be heard. This tone will be presented as a result of an incoming CO or intercom call, recalling CO line or Transferred CO line or at any other time the station is tone rung (refer to conditions that follow).



The 81 ringing choices are as follows:

TONE #	FREQ	DURATION
00	1209/1477	50ms/50ms
01	697'770	50ms/50ms
02	697'1852	50ms/50ms
03	697'941	50ms/50ms
04	697'1209	50ms/50ms
05	697/1336	50ms/50ms
06	697/1477	50ms/50ms
07	697'1633	50ms/50ms
08	697'OFF	burst
10	770'697	50ms/50ms
11	770'770	50ms/50ms
12	770'852	50ms/50ms
13	770'941	50ms/50ms
14	770'1209	50ms/50ms
15	770/1336	50ms/50ms
16	770'1477	50ms/50ms
17	770'1633	50ms/50ms
18	770'OFF	burst
20	852'697	50ms/50ms
21	852'770	50ms/50ms
22	852'852	50ms/50ms
23	852'941	50ms/50ms
24	852'1209	50ms/50ms
25	852'1336	50ms/50ms
26	852'1477	50ms/50ms
27	852'1633	50ms/50ms
28	852'OFF	burst
30	941'697	50ms/50ms
31	941'770	50ms/50ms
32	941'852	50ms/50ms
33	941'941	50ms/50ms
34	941'1209	50ms/50ms
35	941'1336	50ms/50ms
36	941'1477	50ms/50ms
37	941'1633	50ms/50ms
38	941'OFF	burst
40	1209'697	50ms/50ms
41	1209'770	50ms/50ms
42	1209'852	50ms/50ms
43	1209'941	50ms/50ms
44	1209'1209	50ms/50ms
45	1209'1336	50ms/50ms
46	1209'1477	50ms/50ms
47	1209'1633	50ms/50ms
48	1209'OFF	burst
50	1336'697	50ms/50ms
51	1336'770	50ms/50ms

52	1336/852	50ms/50ms
53	1336/941	50ms/50ms
<del>54</del>	<del>1336/1209</del>	<del>50ms/50ms</del>
55	1336/1336	50ms/50ms
56	1336/1477	50ms/50ms
57	1336/1633	50ms/50ms
58	'1336'OFF	burst
60	1477'697	50ms/50ms
61	1477/770	50ms/50ms
62	1477'852	50ms/50ms
63	1477'941	50ms/50ms
64	1477'1209	50ms/50ms
65	1477'1336	50ms/50ms
66	1477'1477	50ms/50ms
67	1477'1633	50ms/50ms
68	1477'OFF	burst
70	1633'697	50ms/50ms
71	1633'770	50ms/50ms
72	1633'852	50ms/50ms
73	1633'941	50ms/50ms
74	1633'1209	50ms/50ms
75	1633'1336	50ms/50ms
76	1633'1477	50ms/50ms
77	1633'1633	50ms/50ms
78	1633'OFF	burst
80	OFF/697	50ms/50ms
81	OFF/770	50ms/50ms
82	OFF/852	50ms/50ms
83	OFF/941	50ms/50ms
84	OFF/1209	50ms/50ms
85	OFF/1336	50ms/50ms
86	OFF/1477	50ms/50ms
87	OFF/1633	50ms/50ms
88	No ring	No ring

Conditions:

- Station users may listen to all tones by dialing the two-digit codes one after another. The tone that is sounding when the SPEED button is pressed will be saved as that station's tone ringing selection.
- A station's tone ringing selection will be maintained in a battery protected area of memory. Therefore if a system experiences a power failure, or a soft or hard restart, a station's tone ringing selection will be restored.
- The tone selected will be used to provide "TONE" ringing normal or muted to the station whenever the station is commanded to tone ring. (i.e. this does not apply to

**STATION FEATURE OPERATION**

camp-on tone programming confirmation tone or other specific tones that are not considered "TONE" ringing.)

The selected tone will be used to notify the station in the following cases:

Incoming CO Call  
 Incoming Intercom Call  
 Transferred CO Line  
 Recalling CO Line  
 Call Back Notification  
 Message Wait Call Back  
 All types of forwarded calls  
 Executive/Secretary calls  
 Line Queue Call Back  
 LCR Queue Call Back

**DO NOT DISTURB**

If you have been given the ability to place your phone in Do Not Disturb:

- a. Press the pre-programmed\* DND button. DND button lights steady.

The DND button can be pressed while the phone is ringing to stop the ringing. (Refer to One-Time Do Not Disturb below.)

Removing Do Not Disturb

- a. Press the pre-programmed\* DND button. The button LED extinguishes and DND is canceled.

\*A flex button must be programmed for this feature to operate. Refer to Sec. 300.37, Flexible Button Assignment.

**A. One-Time Do Not Disturb**

Allows you to prevent calls from ringing at your station while you're on a call. The One-Time DND condition will automatically cancel when you end your call.

- a. Press the pre-programmed\* DND button while you're off-hook and connected to a CO line or intercom call. The DND button LED lights and off-hook tones at your station are canceled.

To cancel:

- a. Replace the handset. The DND button LED extinguishes and DND is canceled.

\*A flex button must be programmed for this feature to operate. Refer to Sec. 300.37, Flexible Button Assignment.

**300.32 EXCLUSIVE HOLD**

When a line is placed on Exclusive Hold, no other station in the system can retrieve this call. Exclusive Hold may be programmed to be activated on the first or second depression of the Hold button. CO Lines

while in a transfer hold are always placed in an Exclusive Hold condition.

**300.33 EXECUTIVE OVERRIDE**

Allows stations designated as "Executive" the ability to override and "bargue in" on other keysets engaged in conversation.

If you call a busy station:

- a. Press the pre-programmed\* EXECUTIVE OVERRIDE button. Executive station will be bridged onto the CO line conversation in progress at the called station. Optional warning tone is heard and presented to all parties prior to cut-thru.
- b. Replace handset at Executive station to terminate the override.

Conditions:

- An error tone will occur:
  - if the called party is in a conference.
  - if the called party is already on an OHVO call.
  - if the called party has a Camp-On at his station
- If the Executive joins a call and one of the members does a hook-flash or depresses his transfer button, the Executive will be dropped.
- If the Executive does a hook-flash or depresses his transfer button, it will be ignored.
- When the Executive jumps in on an intercom call or CO call and the Executive is not in a mute condition, and any member of the party hangs up, the call will be converted to a two-party conversation.
- When the Executive jumps in on an intercom call or CO call and the Executive is in the mute condition and either of the two parties in the intercom call hang up, the call will be dropped. If the Executive hangs up, the call will remain as a two-party conversation.

\*A Flex button must be programmed for this feature to operate. Refer to Sec. 300.37, Flexible Button Assignment.

**CAUTION**

**USE OF THIS FEATURE WHEN THE EXECUTIVE OVERRIDE /WARNING TONE IS DISABLED MAY BE INTERPRETED AS A VIOLATION OF FEDERAL, STATE OR LOCAL LAWS, AND AN INVASION OF PRIVACY. CHECK APPLICABLE LAWS IN YOUR AREA BEFORE INTRUDING ON CALLS USING THIS FEATURE.**

**NOTE**

*A change in volume may occur on the CO line or intercom call after the barge-in occurs.*

**300.34 EXECUTIVE/SECRETARY TRANSFER**

- If you are designated the Executive station and your phone is busy or in DND, all calls will be routed to the Secretary station.
- If you are the designated Secretary station, you can signal the Executive that is busy or in DND by using the Camp On feature.

**300.35 FLASH**

When connected to an outside line:

- Press FLASH button to disconnect outside line and reseed outside line dial tone.

**300.36 FLASH ON INTERCOM**

When connected to a page zone or another internal party, press FLASH button to disconnect page or intercom call. Intercom dial tone will be heard.

**300.37 FLEXIBLE BUTTON ASSIGNMENT**

If you have buttons on your telephone which have NOT been assigned as CO lines, Pooled group, or Loop buttons, you may program them to suit your own individual needs. There are five possible functions you may assign to these buttons:

- **DSS/BLF:** This button, when pressed, will automatically signal the assigned intercom station. DSS/BLF buttons are programmed by the station user.

**Table 300-2 Flex Button Programming Codes**

100-195	Station intercom Numbers	633+[ZZ]	Personalized Messages
43 [C]	Call Park Location 1-7 (system)	633+00	Clear Personalized Messages
438	Personal Park	634	Headset Mode
44 [V]	Voice Mail* Group Pilot Numbers O-7	635	ICLID* Display (unanswered calls)
45 [H]	Hunt Group Pilot Numbers O-7	638+[0]	Handset Receiver Gain w/Display
55 [U]	ACD* Group Pilot Numbers O-09	640	All Call Forward
55 [U]	UCD Group Pilot Numbers O-7	641	Release Key (Stations/Attendants)
56 [U]	ACD* Group Pilot Numbers 10-15	680	Dial Speed Directory
566	ACD*/UCD Available/Unavailable	6.95	Distinctive Ringing
567	ACD*/UCD Calls in Queue Display	70	All Call Page (Internal & External)
571	ACD* Agent Logout	71	internal Page Zone 1
572 55 [U]	ACD* Agent Login	72	Internal Page Zone 2
573	ACD* Group Member Status Display	73	Internal Page Zone 3
574	ACD' Agent Help	74	Internal Page Zone 4
575	ACD* Supervisor Logout	75	Internal All Call Page
576 55 [U]	ACD* Supervisor Login	76 [0]	External All Call Page (All Ext Zones)
577 55 [U]	ACD* Supervisor Queue Status Display	76 [P]	External Page I-7
578	ACD* Overflow Avail/Unavailable	77	Meet-Me-Page Answer
601	Attendant Override	9	Least Cost Routing* (LCR) Access
602	Disable Outgoing CO Line Access	#0	Group Call Pick Up
603	CO Line Off-Net Forward	#5	Universal Night Answer (UNA)
604	Night Service	[SPEED]+YY	Speed Dial Access (00-1 9 Station) (20-99 System)
620	Camp-On	[SPEED]+[*]	Save Number Redial
621	Line Queue	[SPEED]+[#]	Last Number Redial
622	Call Back		
623	Message Wait		
624	Conference	YY = Speed Dial Bin numbers	
625	Executive Override/Monitor Barge-in	ZZ = Personalized Messages,	
626	LCR* Queue Cancel	U = ACD* (O-15) or UCD (O-7) Group Number	
627	Account Code* Enter	C = Call Park Location O-7	
628	OHVO On	H = Hunt Group Number O-7	
629	MUTE feature	V = Voice Mail* Group Number O-7	
631	Do Not Disturb	P = External Page Zone Number I-7	
632	Background Music	*Features available with optional software.	

**STATION FEATURE OPERATION**

- **FEATURES:** This button can be programmed so that when pressed it will activate a particular feature, thus eliminating the need for dialing the feature code. Some features require a flex button to be programmed for that feature to be accessible to the station user. Where this is the case, it is so designated in this Feature Operation Section and user guide. Feature buttons are programmed by the station user. Refer to Table 300-2 Flex Button Programming Codes for a complete listing of code/features that may be programmed onto a flexible button.
- **SPEED DIAL:** This button can be programmed to automatically access a speed number location for one-step operation. PBX and **Centrex** codes can be programmed into a speed dial bin and accessed by one button depression.
- **POOLED GROUP ACCESS:** A group of outside lines can be placed under one button. When this button is pressed, the system will select an available line from this group for the user to place a call on. Pool buttons are assigned in database administration.
- **LOOP:** This button will act as the direct appearing button for outside lines that do not appear on the user's individual telephone. Any phone that doesn't have all lines appear on it must have a loop button. There is NO limit to the number of LOOP buttons a station may have. Loop buttons are assigned in database administration.

To program flexible buttons:

- Press the SPEED button twice.
- Press the assigned button to be programmed (it must be programmed in database as a multi-function button).
- Dial the desired code. Refer to Table 300-2 Flex Button Programming Codes.

To erase a flexible button:

- Press the SPEED button twice.
- Press the button to be erase
- Press the FLASH button. Confirmation tone will be heard.
- Replace the handset or press the ON/OFF button.

**300.38 GROUP LISTENING**

All digital key stations have built in speakerphones. Station users may use the speaker to monitor a call while using the handset to converse with the outside party. This enables other people in the room to listen to both parties in the conversation.

- While conversing, on the handset, press the ON/OFF button. Both parties of the conversation can then be heard on the digital station's

speaker. The speakerphone microphone will be muted while the handset is off-hook.

To deactivate Group Listening while off-hook, the ON/OFF button must be depressed.

Conditions:

- While talking using the speakerphone, then lifting the handset will turn off of the speakerphone. To activate group listening, the ON/OFF button must be pressed (to ON) while the handset is off-hook.
- While in group listening mode, pressing the MUTE button will cause the transmit from the handset to be muted (the speakerphone microphone is already muted). However the distant end can still be heard over both the handset receiver and the station speaker.
- If full speakerphone operation is desired while in group listening mode, simply set the handset on-hook.
- Group listening is not available when the station is in headset mode.
- When placing the handset on-hook to go to full speakerphone operation, it is normal for a "squeal" caused by audio feedback to be heard.

**300.39 HANDSET RECEIVER GAIN**

This feature provides the user with a flexible button that can be programmed on their keyset. When programmed, allows the user to increase/decrease the handset receiver gain while on a CO or intercom call.

While on a CO call:

- Press pre-programmed\* Handset Receiver Gain flex button to enter the volume adjustment mode.
- Dial a one-digit entry [0] through [9] (0=iowest, 9=highest) on the dial pad,  
or  
Press the [#] to increase or [\*] to decrease one level at a time.
- Two volume settings are stored in the system. One level for CO calls, another level for intercom calls. The LCD will display the settings as they occur, if the flex button has been programmed using the code [638]+[0].
- Press pre-programmed\* Handset Receiver Gain flex button again to exit the volume adjustment mode.

**NOTE**

*When the above procedure is used, your transmit path is momentarily interrupted as the dial pad button is depressed.*

- A flex button can be programmed to decrease the Handset Receiver Gain using the code [638]+[\*].
- Another flex button can be programmed to increase the Handset Receiver Gain using the code [638]+[#].
- A flex button can also be programmed to have a certain volume setting using the code [638]+[0 thru 9].

\*A Flex button must be programmed for this feature to operate. Refer to Sec. 300.37, Flexible Button Assignment.

### 300.40 HEADSET MODE

If you wish to use a headset and have been given the ability to do so in programming.

To activate Headset Mode:

- Dial [634] on the dial pad,  
or  
press pre-programmed\* HEADSET MODE button. LED will light steady.

**NOTE** While Headset mode is active, the ON/OFF button will activate the headset and disable speakerphone and intercom call announce operation at your station.

To de-activate Headset Mode:

- Dial [634] on the dial pad,  
or  
press the pre-programmed\* HEADSET MODE button. LED will extinguish.

\*Refer to Sec. 300.37, Flexible Button Assignment.

### 308.41 ICLID UNANSWERED CALL MANAGEMENT TABLE

*This feature available with optional software.*

An Unanswered Call Management Table with 100 entry capacity for the Starplus SPD 4896 system is maintained in the system. The calling number/name information pertaining to any unanswered call will be placed in this table at the time the system has determined that the call has been abandoned.

This table may be interrogated from any station user so that the unanswered calls may be reviewed and handled by the end user. Only the 1st Attendant station can delete an entry from the table, one entry at a time. Upon entry into the review process, the functions available to a phone are:

Function	Function Button
1. Go to beginning of table	Dial Code <b>635</b>
2. Review next item in this table entry	MUTE
3. Step to next table entry.	HOLD
4. Delete this table entry.	FLASH <sup>1</sup>

5. Exit table review function.	ON/OFF
6. Step to previous table entry.	TRANS
7. Call Back	SPEED
<sup>1</sup> Only the 1st Attendant station can delete an entry from this table.	

To interrogate the ICLID Unanswered Call Management Table from any station in the system:

- Dial the access code [635] on the dial pad.
- When the desired table entry is displayed on the LCD, press the SPEED button to automatically dial the table entry.

To review the next item in this entry:

- Press the MUTE button to toggle to the next item.
- Press the ON/OFF button to exit the review function.

To review the next table entry:

- Press the HOLD button.

To review the previous table entry:

- Press the TRANS button.

### 300.42 INTERCOM CALLING

Placing an Intercom Call

- Press the DSS button of the party to be called (if programmed at your phone),  
or  
Dial the three-digit extension number (100 to 195).

**NOTE** Dialing a number in the numbering plan activates the telephone automatically.

- You will hear ringing if called station is in the "T" answering mode; or two bursts of tone if called station is in the "H" or "P" position.
- Lift the handset or use the speakerphone, after the two tone bursts stop.
- Hang up to end the call.

Answering an Intercom Call

With your intercom signal switch in the "T" (center) mode, you will hear repeated bursts of intercom tone ringing and the HOLD button will slow flash.

- Lift the handset or press the ON/OFF button to answer,  
or  
Move the intercom signal switch to the "H" mode to reply.
- Replace the handset to end the call.

In the "P" mode, you will hear two bursts of tone and one-way announcement. The calling party cannot hear conversations in progress.

**STATION FEATURE OPERATION**

- a. Lift the handset or press the ON/OFF button to answer,  
or  
Move the intercom signal switch to the "H" mode to reply.

In the "H" mode, you will hear two bursts of tone and an announcement. Reply handsfree or lift the handset for privacy.

**300.43 INTERCOM TRANSFER**

Intercom transfer without DSS buttons:

- a. Receive or make an intercom call.
- b. Press the TRANS button. Intercom dial tone is heard.
- c. Dial the station where the call is to be transferred.
- d. When the 2nd station answers, you are in a supervised transfer mode (1 st station is staged for transfer).
- e. Hang up (station 1 and 2 are connected).

Intercom transfer using DSS buttons:

- a. Receive or make an intercom call using a DSS button.
- b. Press the TRANS button. intercom dial tone is heard.
- c. Press the DSS button where call is to be transferred.
- d. Hang up (station 1 and 2 are connected).

**300.44 KEYSSET SELF TEST**

The Starplus Digital Key System contains a test mode feature that supports the off line testing of digital keysets and DSS units. The term off line means that the unit under test is disconnected from the switch during the test operation. Keysets not under test continue to operate in the normal manner. Tests are provided to verify the keyset and DSS LED, LCD, and keyboard button operations.

- a. The test mode is entered by taking a keyset's handset off hook.
- b. Press the SPEED button and dial [7#] on the dial pad. This keystroke sequence disconnects the keyset from the system and brings up the Test Mode Menu on the keyset's LCD. The test mode is exited by putting the handset back on hook. This reconnects the keyset to the system.

**SELECT 1:LCDLED 2:KEYBTN  
3: DSSBTN**

Test Mode Menu: The menu allows the operator to select a test mode by pressing the mode number at the dial pad. The operator can al-

ways return to the main test menu by pressing [##].

**A. Keyset LCD/LED Test**

This test outputs a series of continuously repeated LCD string messages to LCD lines 1 and 2. The set of strings consists of the letters 'A' through 'X' and 'a' through 'x'. The next set of strings are:

**"PICKUP TRUCK SPEED ZONE!"  
"\*\*\* STANDING BACK \*\*\*"**

- The strings are alternately displayed on lines 1 and 2 of the LCD display.
- In addition, all the LEDs are flashed at the rate of 15 IPM.

**B. Keyset Button Test**

1. Pressing a keyset button turns on the LED and displays an LCD message identifying the button number.

**PRESS KEYSSET BUTTONS  
\*\*\*\*\***

In addition switching the "H-T-P" switch from one position to another will cause the letter "H\_POS", "T\_POS", or "P\_POS" to be displayed.

2. Pressing dial pad keys displays an LCD message that indicates which digit was pressed.
3. LEDs can be tested independently of the KEYS by pressing the flex LED number at the dial pad. For example, LED 10 is turned on by pressing dial pad digits "1" "0". As each set of new numbers is entered the previously lit LED is turned off and the new LED is turned on. Invalid flexvalues (ex. 00,99) turn off currently lit LED.

**C. DSS LED/Button Test**

When the DSS test is selected and a DSS test is invoked ALL DSSs associated with the keyset running the test are placed in test mode.

**PRESS DSS BUTTONS  
\*\*\*\*\***

If no DSS unit is associated with the keyset, the keyset display will indicate "NO DSS". The DSS LED test will cause all the LEDs to flash at a 15 IPM rate. Once started the DSS LED test will continue until a DSS flex button is depressed. Pressing a DSS flex button turns on the flex key LED and displays an LCD message on the associated keyset identifying the flex button number (01 to 48). In addition, it turns off the previously selected flex LED.

Conditions

- Test mode interrupts the normal operation of a **keyset** or DSS.

300.45 **LAST NUMBER REDIAL**

- Press the SPEED button.
- Press the pound [#] key. The last number dialed over an outside line will be automatically re-dialed.
  - The system will automatically select the original line used to place the call and redial the number.
  - If that line is busy, the system will automatically select another line from the same group and redial the number.
  - If no lines are available in the same group, station will receive busy tone and can queue for a line.
  - If the station user preselects a line before activating LNR, the preselection will override the line which was used originally.

300.46 **LEAST COST ROUTING**

*This feature available with optional software.*

To place an outside call when LCR has been enabled in the system:

- Dial [9] on the dial pad.
- Dial the desired seven-digit telephone number (i.e.: 1+ area code+7-digit number).
- Wait for an answer. lift the handset or use the speakerphone to converse.

If all lines available to you are busy, remain off-hook for four seconds to automatically be queued onto LCR for an available line.

If an LCR Queue Callback has been activated:

- When telephone is signaled, answer the call.
- Desired telephone number will automatically be re-dialed.

**NOTE**

*Only one LCR Queue Call Back request may be initiated by a station. When a second request is made, the first request is canceled.*

If an LCR Queue Callback has been activated and you wish to cancel that callback request:

- Dial the LCR Queue Cancel code, [626] on the dial pad.
- Replace the handset or press the ON/OFF button.

300.47 **MEET ME PAGE**

To request another party to meet you on a page:

- Dial the desired two-digit or three-digit paging code,

or

- press pre-programmed\* PAGING button.
- Request that party meet you on the page.
- Do not hang up; wait for the requested party to answer. **As** soon as the paged party answers and is connected to you, the page circuit is released.

Answering a Meet Me Page

- Go to the nearest telephone and dial [77] on the dial pad,  
or  
press the pre-programmed\* MEET ME PAGE ANSWER button. You will be connected to the party that paged you.

\*Refer to Sec. 300.37, Flexible Button Assignment.

300.48 **MESSAGE WAITING**

Leaving a Message Waiting Indication:

If you dial a station that is busy, unattended, or in DND, you can leave a message waiting indication.

- Lift the handset or press the ON/OFF button.
- Dial the desired intercom station. Busy tone or DND tone is heard.
- Press the pre-programmed MSG button. Confirmation tone is heard. Called party's MSG button will slow flash.
- Replace the handset or press the ON/OFF button to end the call.

**NOTE** *Up to five messages can be left at any Station.*

Answering a Message Waiting Indication:

If your MSG button is flashing at a slow rate, you have a message waiting for you. The first message left will be the first one called.

- Press flashing MSG button. Station that left message will be signaled with tone ringing.
- If called station does not answer, press MSG button once to leave message.

300.49 **MUTE KEY**

The MUTE button provides privacy during speakerphone or handset operation by disabling the microphone.

- Press the MUTE button while off-hook on speakerphone or handset to activate.
- Press the MUTE button again to deactivate.

The mute feature automatically deactivates upon call termination.

300.50 **NIGHT SERVICE FEATURE**

The Night Service feature will provide a means to put the system in night mode from any **keyset** or remove the system from night mode from any **keyset** as long

**STATION FEATURE OPERATION**

as the system was put in night mode by the Night Service feature flex button. If the system was placed in night mode by the attendant using her Night Service (DND) button or if the system was placed in night mode by the automatic schedule, the Night Service flex button can not remove the system from night mode.

From an idle station:

- a. Press the pre-programmed\* Night Service flex button. The system is now in the Night Service Mode.

To remove the Night Service Mode:

- b. Press the pre-programmed\* Night Service flex button again. The system is now removed from the Night Service Mode.

\*A Flex button must be programmed for this feature to operate. Refer to Sec. 300.37, Flexible Button Assignment.

**300.51 OFF-HOOK PREFERENCE**

If your phone has been programmed for Off-Hook Preference, you will access an outside line, or a feature by going off-hook or pressing the ON/OFF button.

While Off-Hook Preference is enabled, you may access internal intercom dial tone by:

- a. Pressing your pre-programmed\* ICM button, or dial your own three-digit intercom number. (Do not lift handset or press ON/OFF button before dialing intercom number.) LED lights steady and intercom dial tone will be heard.
- b. You may now dial an internal station or Feature Access code.

\*Refer to Sec. 300.37, Flexible Button Assignment.

**300.52 OFF HOOK VOICE OVER (OHVO)**

This feature allows users, off-hook on a call (CO or Intercom), to receive a voice announcement through the handset receiver without interrupting the existing call. The Voice Over is muted so as not to "override" or "drown" out the existing conversation. The overridden party may then respond to the calling party using CAMP-ON procedures to talk to the calling party or may use Silent Text Messaging to respond to the calling party via LCD Displays,

Placing an Off-Hook Voice Over (OHVO) call:

When an OHVO station calls a busy OHVO station, and busy tone is received,

- a. The calling OHVO station dials the OHVO code [628] on the dial pad, or presses a pre-programmed\* OHVO button to initiate an OHVO announcement. The HOLD

button LED will flash at the called OHVO station.

- b. The OHVO receiving station will receive a one-beep warning tone. The station receiving the OHVO call must be off-hook and in the "H" mode, and, then the calling OHVO party may begin the voice announcement to the called OHVO party. The called OHVO station's existing conversation will not be interrupted and the voice over announcement will not "drown" out the existing conversation. The calling OHVO station will not be connected to or otherwise be able to hear the-called station's conversation (the connection will only allow the calling station to transmit to the called station).

**NOTE** *The calling station is placed in a one-time DND mode upon initiating the Voice Over. One-Time DND cannot be toggled during the OHVO call. The station receiving the OHVO call must be off-hook and in the "H" mode.*

Responding to an Off-Hook Voice Over (OHVO):

After receiving an OHVO announcement, two options are available to respond to the calling party;

1. The called OHVO station may respond to the calling OHVO station by using the Camp-On feature. The called OHVO station presses the flashing HOLD button to consult with the calling station. The existing call (CO line) goes on Exclusive Hold automatically. This method, then follows Camp-On procedures and operation.
2. The called station may respond to the calling station by using the Silent Text Messaging (this feature is only available to digital key terminals, and the calling station must be a digital display terminal.) The called OHVO station may press pre-programmed Message button to respond to the voice over announcement without being released from the current call, (i.e. by pressing a flex button pre-programmed for the message "IN MEETING"), the calling station will receive this message on the calling station's LCD display.

Conditions

- The station receiving the OHVO call MUST be off-hook and in the "H" mode,
- The receiving station must have OHVO enabled.
- When the dialed station responds via Camp-On all conditions and options available to Camp-On apply (refer to the feature description for Camp-On).
- OHVO may be used to notify the called party of a transferred call (CO Line or Intercom) by announcing the call, then releasing



to complete the transfer. When this occurs, the receiving station does not need to respond to the OHVO.

- When a call is transferred via OHVO, the receiving station will receive muted ringing after the transfer is complete.
- Any messages including "CANNED", "CUSTOM", or "SILENT RESPONSE" text messaging may be used to respond to an OHVO call. The message will appear on the calling station and called station LCD displays.
- If the calling station is a non-LCD terminal, the called station will receive error tone when responding via text messaging.
- The called station may press a flex button programmed as a Text Message button, [633+XX]. This flex button can be pressed and the two-digit message number dialed to respond to the calling station. DTMF digits will not be heard by either party.
- The receiving station must be programmed to allow OHVO calls.
- When silent messaging is used to respond to an OHVO call, the existing call on the called station will not be disconnected, while the messages are being sent to the calling station.
- The calling station of an OHVO call must remain off-hook to receive silent messages. The calling station's voice transmit will remain connected to the called station and may respond verbally to the text messages. The OHVO call ends when the calling station goes on-hook.
- If the receiving station is on-hook in speakerphone mode and a calling party initiates OHVO, the receiving station will receive a Camp-On warning tone and normal Camp-On procedures are followed.
- The called station may send (multiple messages) and even after sending a message, may press the Camp-On button to talk to the calling station. Each time a message is sent, the splash tone will be heard and both displays will be updated.
- LEDs will follow Camp-On LED lamping sequences.

Each station can be programmed to allow receiving OHVO calls as part of Station Programming. Each station may be programmed for OHVO in one of two ways, as follows:

- OHVO disallowed (may not receive OHVO calls).
- May receive OHVO calls.

### 300.53 PAGING

If you have been given the ability to make page announcements:

- a. Lift the handset. or press the ON/OFF button.
- b. Dial the two-digit or three-digit paging code, or press pre-programmed\* PAGE button.
  - [70] = All Call - Internal & External
  - [71] = Internal Zone 1
  - [72] = Internal Zone 2
  - [73] = Internal Zone 3
  - [74] = Internal Zone 4
  - [75] = Internal All Call
  - [76[0] = External All Call (All Ext Zones)
  - [76[Z] = External Zones 1-7)
- c. Speak in normal tone of voice to deliver message.

**NOTE** Stations off-hook or in DND will not hear the internal page announcement.

**NOTE** When making a zone page or All Call page and the zone is busy, the page initiator will receive ringback tone until the zone becomes available. You will then hear a warning tone and can make the page announcement.

### 300.54 PBX/CENTREX TRANSFER

While connected to an outside line (PBX/Centrex):

- a. Press the FLASH button. Receive transfer dial tone.
- b. Dial a PBX/Centrex station number.
- c. Hang up to complete transfer.

### 300.55 PERSONAL PARK

Each station in the system can place a call into a personal park location and then later retrieve that call from the originating station.

While connected to an outside line:

- a. Press the TRANS button. The caller is put on Exclusive Hold.
- b. Dial the Personal Park location [438] on the dial pad,  
or  
Press the pre-programmed\* PERSONAL PARK button. Dial tone will be heard.

**NOTE** When dialing the personal park location and that location is already occupied, the initiating station will receive the previously parked call and the second call is parked.

## STATION FEATURE OPERATION

## Retrieving a Parked Call:

- a. Dial the Personal Call Park location code [438] on the dial pad,  
or  
Press the pre-programmed\* PERSONAL PARK button.  
A talk path is established between the two parties.

## Conditions:

- Intercom calls and CO line calls can be placed into the station's personal park location.
- Calls parked in a personal park location are subject to the "system" call park recall timer.
- A CO call parked in a personal call park location will recall to the station that parked the call when the call park recall timer expires. The CO call will ring into this station until the system hold timer expires. The CO call will then recall to the attendant(s) (at this point, the attendant station and the initiating station are ringing), and the attendant recall timer is initiated. When the attendant recall timer expires, the CO call will be disconnected.

**300.56 PERSONALIZED MESSAGES**

Each station can select a pre-assigned message to be displayed on the LCD of any key telephone calling that station.

There are ten possible messages which can be left.

- a. Dial [633] on the dial pad,  
or  
press a pre-programmed\* MSG button.
- b. Dial the two-digit code for the message which will appear. Confirmation tone will be heard and the DND button LED will be flashing.
  - [00] = clears message
  - [01] = ON VACATION
  - [02] = RETURN AM
  - [03] = RETURN PM
  - [04] = RETURN TOMORROW
  - [05] = RETURN NEXT WEEK
  - [06] = ON TRIP
  - [07] = IN MEETING
  - [08] = AT HOME
  - [09] = ON BREAK
  - [10] = AT LUNCH

**NOTE** This feature is not available to the attendant(s).

**A. Personalized Message - Date & Time Entry**

As an enhancement to the original canned messages, station users can activate certain messages that will allow the user to enter a specific time or a date of return. These messages will appear on calling station's display to alert them of the desired party's return time or date.

To activate a message with a custom return time or date, the station user:

- a. Dials the Message Access code [633] on the dial pad.
- b. Then dial the desired message number [11 - 17].

Users may activate the following messages and be prompted to enter a time or date of return:

- [11] = VACATION UNTIL: MM/DD
- [12] = RETURN: HH:MM xm or MM/DD
- [13] = ON TRIP UNTIL: MM/DD
- [14] = MEETING UNTIL: HH:MM xm
- [15] = AT HOME UNTIL: HH:MMxm
- [16] = ON BREAK UNTIL: HH:MM xm
- [17] = AT LUNCH UNTIL: HH:MM xm

- c. Enter the date/time by using buttons on the dial pad as follows:

A =21	M =61	1 =1#	" =01
B =22	N =62	2 =2#	, =02
C =23	0 =63	3 =3#	? =03
D =31	P =71	4 =4#	/ =04
E =32	Q =74	5 =5#	! =*1
F =33	R =72	6 =6#	\$ =*2
G =41	s =73	7 =7#	& =*4
H =42	T =81	8 =8#	* =*#
I =43	U =82	9 =9#	( =#1
J =51	V =83	0 =0#	) =#2
K =52	w =91	Space =11	+ =#3
L =53	x =92	: =12	= =#4
	Y =93	- =13	# =##
	Z =94	' =14	

- d. Press HOLD to enter message. Confirmation tone is received and DND button LED is flashing.

To cancel the message:

- a. Dials the Message Access Code [633] + [00] and replace handset. DND button LED is extinguished.

**B. Personalized Messages - Custom**

Each station can select from ten possible custom messages to be displayed on the LCD of any key telephone calling that station. These messages are programmed from the first attendant station.

1. Dial [633] on the dial pad, or press a pre-programmed\* MSG button.
2. Dial the desired two-digit code (21-30) for the custom message desired. The first attendant should provide a list of messages to each station user.

**C. Personalized Message Code On A Flex Button**

You can program the code [633] onto a flexible button to speed access of preselected messages.

1. Press the SPEED button twice.
2. Press the desired flex button. LED flashes.
3. Dial [633] + [#] on the dial pad. Confirmation tone is heard. The user can now press that flex button and dial the two-digit canned message number (00-10), or the two-digit custom message number (21-30), two-digit text message number (31-51) to activate the message. Confirmation tone will be heard and DND button LED is flashing.

Conditions:

- The telephone receiving the message must be a display telephone.
- Both key telephones and SLT's may activate the message. SLT's are notified that they have an active message with a warning tone when going off-hook.
- Incoming and outgoing calls are not inhibited in any way with a message displayed.
- When a message is displayed by a key telephone, the DND button LED flashes at 15 ipm.
- When DND is invoked on the telephone the message is canceled.
- Message Access (with a desired message) may be assigned to a flex button.
- Messages may be entered while off-hook on a call if an intercom call has camped-on to the station. This will cause the station calling to see the message.
- Messages are retained in battery protected area of memory in the event of power failure or system reset.

**300.57 PRIME FLEX BUT-TON PROGRAMMING**

If your phone is programmed for Off-Hook Preference and have been given the ability to enable or change the prime flex button.

- a. Dial [691] on the dial pad

- b. Dial the two-digit button number. Refer to following chart.

1	11		
2	12		
3	13		
4	14		
5	15		
6	16		
7	17		
8	18		
9	19		
10	20		
21	22	23	24
25	26	27	28

To disable Off-Hook Preference:

- a. Dial [691] on the dial pad.
- b. Dial [00] on the dial pad.

**300.58 PROGRAMMING YOUR NAME INTO THE LCD DISPLAY**

Every extension (key and SLT) has the capability to program the users name so that people using display telephones will see the name instead of the station number.

- a. Dial [690] on the dial pad.
- b. Enter the name (up to 7 characters may be entered) by using keys on the dial pad as follows:

A=21	M=61	1=1#	"=01
B=22	N=62	2=2#	,=02
C=23	O=63	3=3#	?=03
D=31	P=71	4=4#	/=04
E=32	Q=74	5=5#	!=*1
F=33	R=72	6=6#	\$=*2
G=41	s=73	7=7#	&=*4
H=42	T=81	8=8#	*=*#
I=43	U=82	9=9#	(=#1
J=51	V=83	0=0#	)=#2
K=52	W=91	Space=11	+=#3
L=53	x=92	: =12	==#4
	Y=93	- =13	# =##
	z=94	' =14	

- c. Press the SPEED button to complete the programming process.

To erase your name:

- a. Dial [690] on the dial pad.

**STATION FEATURE OPERATION**

- b. Press the SPEED button to complete the erasing process.

**300.59 PULSE-TO-TONE SWITCHOVER**

The signaling on an outside line can be changed from dial pulse to tone (DTMF) manually while dialing out.

To perform the change-over

- a. Dial an [\*] on the dial pad. The remaining digit(s) will be sent using DTMF.

The Pulse to Tone Switchover command may also be included into a speed dial bin. Refer to Sec. 300.65, Storing Speed Numbers for Speed Dial programming.

**300.60 SAVE NUMBER REDIAL**

If you wish to save the last number you dialed for use later:

- a. After placing an outside call, keep handset off-hook.  
b. Press the SPEED button twice.

To Dial a number that was saved using the steps above:

- a. Press the SPEED button.  
b. Dial the asterisk [\*] button.
- System will automatically select the original line used to place the call and redial the number.
  - If that line is busy, the system will automatically select another line from the same group and redial the number.
  - If no lines are available in the same group, station will receive busy tone and can queue for a line.
  - If the station user preselects a line before activating SNR, the preselection will override the line which was used originally.

**300.61 PROGRAMMING PBX/CENTREX CODES ONTO FLEX BUTTON**

For easy one-button access to Centrex or PBX features, perform the following steps:

- a. Program the Centrex or PBX code into a station or system speed dial bin, including hook-flash (flash key), [\*], and [#] commands. Refer to station or system speed dial programming.  
b. Program that speed bin onto a flexible\* button.

\*Refer to Sec. 300.37, Flexible Button Assignment.

**300.62 SPEAKERPHONE**

- a. Press ON/OFF button to "ON". Intercom dial tone will be heard.  
b. Press the DSS button of the desired party, or press an available outside line button and dial number. Speakerphone is activated.  
c. Press ON/OFF button to "OFF" to end the call.

**NOTE**

*For further references in this section where "lift handset" is specified, you may also use the method of pressing the "ON/OFF" button, if the telephone is programmed to be 8 true two-way speakerphone.*

**300.63 STATION RELOCATION FEATURE**

The Station Relocation Feature will provide a means to allow a user to unplug their station and plug it in at another location. Then by dialing a simple code followed by his old station number, bring all the station attributes including extension number, button mapping, speed dial, and class of service to the new location.

- a. A station can be relocated by unplugging it and then plugging it in at a new location.  
b. Dial [636] on the dial pad. Then dial the extension number of the station being relocated. Once this is done, all station attributes are copied to the current station.

**NOTE**

*If a station is assigned to a specific port and that user unplugs his station and plugs it in at another location, the database administration programming will be updated to reflect the new port change.*

Conditions:

- The station number that is dialed as the relocated station must be currently out of service.
- The relocated station will be given the station attributes of the station doing the relocating. The two stations have traded station numbers and station attributes.
- If a keyset is plugged into the relocated position it will have all the station attributes of the relocating station.
- This feature only is applicable to keysets.
- If the relocated station is in service, error tone will be received.

**300.64 STATION SPEED DIAL**

If no outside line has been specified in programming, one will be chosen automatically or you can choose one now.

- a. Press the SPEED button and dial bin location, or

press the pre-programmed\* speed bin button. Station Speed numbers are 00 to 19.

- b. When the called party answers, pick up the handset or use the speakerphone to converse.

\*Refer to Sec. 300.37, Flexible Button Assignment.

### 300.65 STORING SPEED NUMBERS

Station Speed numbers can be entered by keyset users. System Speed numbers must be entered by the first programmed attendant. If no attendant is specified, enter at Station 100.

- a. Press the SPEED button once.
- b. Press a desired outside line button or pool button  
or  
select an outside line automatically by pressing the SPEED button a second time.
- c. Dial the speed bin location.
  - 00 to 19 for Station Speed numbers;
  - 20 to 99 for System Speed numbers.
- d. Dial the desired telephone number. (including special codes described below)
  - TRANS - Pressing the TRANS button during number entry initiates a Pulse-To-Tone switchover.
  - HOLD - Pressing the HOLD button during number entry inserts a Pause.
  - FLASH - Pressing the FLASH button inserts a Flash into the speed number.
  - TRANS - Pressing the TRANS button as the first entry in the speed bin inserts a no-display character causing the numbers stored in the bin not to appear on the Digital Terminals display when the bin is accessed.
- e. Press the SPEED button.
- f. Replace the handset to end the speed bin programming.

To program several speed numbers in a row, press the SPEED button twice to conclude programming a number and then just enter the next speed number bin to be programmed. If the station has no line appearance for the line programmed into the speed bin, that line will come up under the Loop button or Pool button when accessed.

To erase an existing speed bin:

1. Press the SPEED button twice.
2. Dial the speed bin location:
  - 00 to 19 for Station speed numbers
  - 20 to 99 for System speed numbers
3. Press the SPEED button again. Confirmation tone will be heard.

### 300.66 SYSTEM SPEED DIAL

If no outside line has been specified in programming, one will be chosen automatically or you can choose one now.

- a. Press the SPEED button.
- b. Dial the speed bin location,  
or  
press the pre-programmed\* speed bin button.
  - System Speed numbers are 20 to 99.
- c. When the called party answers, pick up the handset or use the speakerphone to converse.

\*Refer to Sec. 300.37, flexible Button Assignment.

### 300.67 TEXT MESSAGING (Silent Response)

This a feature allows a station user to use text messages to respond to a caller that has either Camped-On or has used the Off-Hook Voice Over feature to alert a busy station user of a waiting call or message. The "camped-on" station may respond to the caller via the canned, custom, and silent response text (LCD) messages. The text messages appear on the calling party LCD Display.

While receiving a Camp-On, or OHVO call:

- a. The called party may press a pre-programmed\* Text Message button with a specific message [633+xx]. Example : [633] + [38] means that a telephone calling the station will receive the message 'WHO IS IT?'

The additional messages (with their codes) listed below can also be sent as a text response:

- [31] = I WILL TAKE CALL
- [32] = TAKE MESSAGE
- [33] = TRANSFER TO SECRETARY
- [34] = PUT CALL ON HOLD
- [35] = CALL BACK
- [36] = ONE MOMENT PLEASE
- [37] = I WILL CALL BACK
- [38] = WHO IS IT?
- [39] = IS IT LONG DISTANCE?
- [40] = IS IT PERSONAL?
- [41] = IS IT AN EMERGENCY?
- [42] = IS IT IMPORTANT?
- [43] = IS IT URGENT?
- [44] = SEND CALL TO VOICE MAIL
- [45] = PARK CALL
- [46] = OUT OF OFFICE
- [47] = PUT CALL THROUGH
- [48] = I AM BUSY
- [49] = O.K.
- [50] = NO
- [51] = YES

**STATION FEATURE OPERATION**

## Conditions:

- If the station receiving the text message response was doing a camp-on, he will first receive a short burst of tone on the speaker, then the display will show the message that has been activated by the called station.
- If the station receiving the text message response is on an OHVO call, no tone will be received.
- All canned and custom messages may be used to respond to a calling party.
- Text response messages will automatically clear when the calling station (station receiving the messages) goes on-hook.
- A station can receive only one message at a time.
- Text messages may be chained (i.e. multiple messages sent to one caller).
- Text message responses may only be activated by digital terminals and the receiving station must be a Digital Display telephone.
- The text message responses will appear on both the calling station and the called station (station activating) text responses) LCD displays.
- If the calling station is a non-LCD terminal, the called station will receive error tone when responding via text messaging.
- The called station may press a flex button programmed as a Text Message button, [633+XX]. This flex button can be pressed and two-digit message number dialed to respond to the calling station. DTMF digits will not be heard by either party.
- When silent messaging is used to respond to a call, the existing call of the called station will not be disconnected while the messages are being sent to the calling station.
- The calling station must remain off-hook to receive silent messages.
- If the called station responds with a text message, the text message will appear on the LCD.
- LEDs will follow that of the CAMP-ON or OHVO.
- Each individual message may be programmed onto a flexible button including a flex button on a DSS/BLF console.

**NOTE**

*The calling station must be a digital display telephone and the called station must be a keyset.*

### 300.68 UNIFORM CALL DISTRIBUTION (UCD)

Eight Uniform Call Distribution (UCD) groups can be programmed, each containing up to eight three-digit station numbers. Each group is assigned a pilot number. When this number is dialed, the first available agent in that group is rung. Calls are routed to the station that has been on-hook for the longest period of time.

#### A. UCD Calls In Queue Display

From an idle display key telephone:

1. Dial [567] on the dial pad, followed by the three-digit UCD group number (55x),  
or  
press pre-programmed\* flex button. ON/OFF button LED lights steady.  
This display is an idle state display and will prompt a Supervisor that a group is having problems answering all their calls. The display will tell the agent and his supervisor how many calls are in queue, how many agent are available or logged into the group, and the length of time in minutes that the oldest call has been in queue. The agent will automatically receive the calls in queue display whenever their is a call in queue.
2. Hang up the handset or press the ON/OFF button to terminate the display.

**NOTE**

*This feature cannot be used with a call in progress and the station will be considered busy for incoming calls during this operation.*

\*Refer to Sec. 300.37, Flexible Button Assignment.

#### B. UCD Available/Unavailable Mode

If you are a UCD agent, you may place your station in the Available mode to receive UCD type of calls or you may place your station in the Unavailable mode to block UCD type calls from ringing your station.

To go Available:

1. Dial [566] on the dial pad,  
or  
press the pre-programmed\* Available/Unavailable button. You may now receive UCD calls.

To go Unavailable:

1. Dial [566] on the dial pad,  
or  
press the pre-programmed\* Available/Unavailable button. You are now blocked from receiving UCD calls.

\*Refer to Sec. 300.37, Flexible Button Assignment.

### 300.69 UNIVERSAL NIGHT ANSWER (UNA)

If you hear outside line ringing at another station and wish to answer it:

- a. Dial [#5] on the dial pad. The connected outside line can be transferred or disconnected.

**NOTE**

*Each telephone utilizing Universal Night Answer must have a loop button appearance if the ringing outside line does not appear at their phone.*

### 300.70 VOICE MAIL OPERATION (VM)

**This feature available with optional software.**

Forward Callers to your Mail box

Intercom and Transferred CO callers may be routed directly to your mail box by forwarding your phone to a voice mail group. Callers will then be greeted by your personal voice mail greeting if available (Refer to Call Forward - Voice Mail Operation)

Retrieving Voice Messages

If your Message Waiting button or programmed Voice Mail group button is flashing, you may have a voice message waiting for you.

To enter the voice mail system to check for mail:

- a. Dial the Voice Mail group number,  
or  
press the pre-programmed\* voice mail group button or flashing Message Wait button.
- b. You will immediately be prompted to enter your password for your mail box.

Receiving a Voice Mail Message Wait

To receive a message waiting indication that a voice message has been taken for you, the Voice Mail system must be programmed to provide such an indication.

After the voice mail system receives a voice message for a station user:

- a. The voice mail must go off-hook and dial the voice mail message wait code [420] on the dial pad.
- b. Dial the three-digit extension number of the station user who received a voice message.

Turning the Message Waiting Lamp Off

When a station user retrieves the voice messages from the voice mail system, the voice mail system must:

- a. Be programmed to go off-hook and dial the message cancel code [421] on the dial pad.
- b. Dial the three-digit extension number of the station user who retrieved the voice message.

\*Refer to Sec. 300.37, Flexible Button Assignment.

### A. Voice Mail Transfer with ID

This feature provides an Attendant or station user a way to transfer a caller directly into a voice mail box. This allows the station identification digits to be entered by the transferring party. Using this feature a caller can be transferred to a voice mail box when: 1) a station user on the system is not forwarded to VM, or 2) the destination Voice Mail Box owner is not a station user.

When a caller wishes to be transferred into a users Voice Mail box and the desired user's station is not forwarded into voice mail, then the attendant or a station user may initiate a Voice Mail Transfer.

While on a call and the distant end wishes to leave a Voice Message for a VM user

- a. The initiating station presses the TRANS button.
- b. Dial the Voice Mail Group number,  
or  
press the pre-programmed\* VM group button.
- c. Dial the VMID (Mail Box location) of the desired party and go on-hook. The system will then make the connection to an available Voice Mail port and send the Leave Mail Prefix (if any) + the digits dialed as the VM ID number + then the Leave Mail Suffix digits (if any). The system will then cut through the transferred caller.

**NOTE**

*The VMID (mail box location) can be any number between 100 through 227.*

Conditions:

- CO Trunks and Internal Calls may be transferred into Voice Mail using this feature.
- If no VM ID digits are dialed by the transferring station then the identification digits of the transferring station will be sent to the VM.

### B. VM Tone Mode Calling Option

Allows the Voice Mail system to override a called stations "H" or "P" intercom switch settings.

When placing a call to a station and Tone ringing is desire (the Voice Mail system MUST be programmed to:

- a. Dial [6#] on the dial pad.
- b. Dial the three-digit station extension (call tone rings station).

### 300.71 RELEASE BUTTON

Allows the station user to disconnect calls while off-hook (on handset, not speakerphone), speeding up call handling time.

**STATION FEATURE OPERATION**

---

While off-hook (on handset, not speakerphone), on an intercom call, transfer sequence, page announcement or CO call:

1. Press the pre-programmed RELEASE button to terminate intercom call, transfer sequence, page announcement or CO call.

\*A flex button must be programmed for this feature to operate. Refer to Sec. 300.37, Flexible Sutton Assignment.

**300.72 VOLUME CONTROLS**

There are two volume control slide switches on the front of the **34-button** digital key terminal. Sliding the switch to the left decreases the volume. The left slide switch controls the volume for voice, background music, and speakerphone volume. The right slide switch controls the volume for tone ringing volume.



## SECTION 305

# BASIC KEYSSET FEATURE OPERATION

### 305.1 INTRODUCTION

The Starplus Digital Key Telephone System has a wide variety of features and flexible programming, allowing each telephone user to program his/her telephone to meet his/her own individual needs.

This section of the manual contains the operating instructions for features that work differently on the Basic Digital Terminal than on the 34-button display telephone. Also included is an illustration of the Basic Digital Key telephone used in the Starplus Digital Key Telephone System and description of the keys on the telephone and its functions. It is intended that this section be used in conjunction with the Station Operation section to provide a complete set of instructions to all features in the system. Visual and audible cues which accompany the various steps in the operation of the features are also included.

Literature similar to these operating instructions has been prepared for use by the customer in the form of a Station Users Guide.

### 305.2 BASIC KEY STATION FEATURES

The Starplus Digital Key Telephone System provides the following keys, indicators and features on the Basic Digital terminal:

**HANDSET AND SPEAKER** are located at the left side of the front panel. A handset is provided to allow confidential conversation when desired. Lifting the handset from its cradle (going off-hook) disengages the station's built-in speaker.

The speaker is located directly below the center portion of the handset. The station may be operated with the handset on-hook. When this occurs, audio is transmitted to the station user through the station's speaker.

**FLEXIBLE BUTTONS** are used to access idle outside lines, provide **DSS/BLF** for internal stations, access speed dial number and activate features. These buttons are programmed by the individual station user. The default flex feature buttons are described below:

**DSS/BLF** (flex) button allows you to automatically signal the assigned intercom station. **DSS/BLF** buttons are programmed by the station user. By default, flex buttons 1 and 2 are set for Stations 100 and 101.

**LOOP** (flex) button will act as the direct appearing button for outside lines that do not appear on the user's individual telephone. Any digital

terminal that doesn't have all lines appear on it must have a loop button. There is NO limit to the number of **LOOP** buttons a station may have. Loop buttons are assigned in database administration.

**POOL** (flex) button enables a group of outside lines to be placed under one button. When this button is pressed, the system will select an available line from this group for the user to place a call on. Pool buttons are assigned in database administration.

**MSG (MESSAGE WAIT)** (flex) button allows you to initiate a message waiting indication at stations that are busy, unattended, or in Do Not Disturb. Message Waiting Callback request left at your station will be indicated by a flashing Msg Wait LED.

**FWD (CALL FWD)** (flex) button allows you to forward your calls to another station.

**DND (DO NOT DISTURB)** (flex) button allows the user to place his/her telephone into a Do Not Disturb mode to eliminate incoming outside line ringing, intercom calls, transfers and paging announcements. The station in DND can use the telephone to make normal outgoing calls. On Attendant stations, this button becomes the system Night Mode button. A flex button must be assigned to use this feature.

**CONF (CONFERENCE)** (flex) button is used to establish and build conference calls.

#### FIXED FEATURE BUTTONS:

**HOLD** button enables you to place an outside caller on hold.

**TRANS (TRANSFER)** button is used to transfer an outside call from one station to another.

**FLASH** button is used to terminate an outside call and restore dial tone without having to hang up the handset. It is also used to transfer calls behind a PBX or Centrex within those systems.

**SPEED** button provides you with access to speed dialing, save number redial and last number redial. This button is also used to access flex button programming.

**MUTE** button allows you to switch the built-in microphone on or off when using the speakerphone, or the handset microphone when using the handset.

**BASIC KEYSSET FEATURE OPERATION**

**ON/OFF** button enables you to make a telephone call without lifting the handset. It turns the telephone on and off when using the **speakerphone**.

**OUTSIDE CALLS** are announced by a tone signal repeated every 3.2 seconds. The corresponding outside line indicator will flash slowly.

**INTERCOM CALLS** can be tone ringing or voice announce. If it is voice announced, the receiving station will receive 2 bursts of tone prior to the announcement. If it is a tone ringing call, the receiving station will hear a tone ring every 2.4 seconds.



Figure 305-I Basic Digital Terminal

Table 305-I Basic Keypad Numbering Plan

100-195	Station Intercom Numbers	664	Conference <b>W</b> / Personal Park
43 [C]	Call Park Location O-7 (system)	690	Name in Display Programming
438	Personal Park	691 [BB]	Off-Hook Preference
44 [V]	Voice Mail* Group Pilot Numbers O-7	695	Distinctive Ringing
45 [H]	Hunt Group Pilot Numbers O-7	70	All Call Page (Internal & External)
55 [U]	ACD* Group Pilot Numbers O-Q	71	Internal Page Zone 1
55 [U]	UCD Group Pilot Numbers O-7	72	Internal Page Zone 2
56 [U]	ACD' Group Pilot Numbers 1 O-I 5	73	Internal Page Zone 3
566	ACDYUCD Available/Unavailable	74	Internal Page Zone 4
570 [BB]	ACD* Call Qualifier	75	internal All Call Page
571	ACD' Agent <b>Logout</b>	76 [0]	External All Call Page (All Zones)
572 55 [U]	ACD* Agent <b>Login</b>	76 [P]	External Page Zones I-7
573	ACD* Group Member Status	77	Meet-Me-Page Answer
574	ACD* Agent Help Request	81	CO Line Group 1 (if <b>LCR*</b> is enabled)
578	ACD* Overflow Sta Available/Unavailable	82	CO Line Group 2
6# [XXX]	Tone Mode Ring Option	83	CO Line Group 3
604	Night Service Feature	84	CO Line Group 4
620	Camp-On	85	CO Line Group 5
621	Line Queue	86	CO Line Group 6
622	Call Back	87	CO Line Group 7
623	Message Wait	88 [YY]	All CO line Groups (CO Line Off-Net Forward)
624	Conference	9	<b>LCR*</b> or CO Line Group 1 (if <b>LCR*</b> is disabled)
626	<b>LCR*</b> Queue Cancel	0	Attendant
627	Account Code' enter	#0	Group Call Pick Up
629	MUTE Button	#43 [C]	Call Park Pickup
631	Do Not Disturb	#5	Universal Night Answer
632	Background Music	[SPEED][YY]	Speed Dial Access (00-I 9 Station)(20-99 System)
633 [ZZ]	Personalized Messages	[SPEED]+[*]	Save Number Redial
633 [00]	Clear Personalized Messages	[SPEED]+[#]	Last Number Redial
634	Headset Mode		
636 [XX]	Station Relocation		
638+[0]	Handset Receiver Gain		
638+[*]	Handset Receiver Gain Increase		
638+[#]	Handset Receiver Gain Decrease		
640	All Call Forward		
640 [7]	No Answer - Call Forward		
640 [8]	Busy - Call Forward		
640 [9]	Busy/No Answer - Call Forward		
640 [*]	Off-Net - Call Forward		
641	Release Button (Key and Attendant)		
660	Flash Command to CO Line		
662	Clear - Call Forward, DND, Personal Messages		
663	Message Wait return		

XXX = intercom Station Numbers  
 YY = Speed Dial Bin numbers  
 ZZ = Personalized Messages  
 U = ACD\* (O-I 5) or UCD (O-7) Group Number  
 C = Call Park Location O-7  
 H = Hunt Group Number O-7  
 V = Voice Mail\* Group Number O-7  
 P = External Page Zone Number 1-7

\*Features available with optional software.

**BASIC KEYSSET FEATURE OPERATION****305.3 AUTOMATIC CALL DISTRIBUTION (ACD)**

*This feature is available with optional software.*

When purchased, Uniform Call Distribution (UCD) is not used and is replaced by the ACD functions identified in the following. 16 Automatic Call Distribution (ACD) groups can be programmed, each containing up to 16 three-digit station numbers.

**A. Agent Login/Logout Feature**

The Agent Login/Logout feature provides a means for an agent to log into one of the ACD groups and receive calls. For an agent to be placed into an active ACD state, the agent must first login. The agent logs in by performing the following steps:

1. Dial the LOGIN CODE [572] on the dial pad, followed by the ACD group number (5xx) that the agent is going to log into.  
or  
Press a pre-programmed\* LOGIN flex button.
2. The agent enters his unique AGENT ID code (0000-9999). The LOGIN flex button LED will be lit steady. Confirmation tone is heard and the agent is logged onto the ACD group. The ON/OFF LED will extinguish if the agent started the sequence in the handsfree mode. When the agent logs in, an ACD login event is sent to the SMDR port, if active.

**NOTE**

*If a member is assigned to a specific ACD group and uses the login-logout codes to enter and exit an ACD group other than his assigned group, the database is changed to reflect the different group.*

For an agent to remove himself from the ACD group as an active agent:

1. Dial the LOGOUT CODE [571] on the dial pad,  
or  
Press a pre-programmed\* LOGOUT flex button. The LOGIN flex button LED will extinguished. When the agent logs out and removes himself from the ACD group, an ACD logout event is sent to the SMDR port, if active.

**NOTE**

*When an ACD Agent has a Login flex button programmed onto his station, that same flex button can be used to Login and Logout of the assigned ACD group.*

Conditions:

- If an agent logs into an ACD group from a station that is logged into another ACD group, the station will be automatically removed from the previous ACD group.

- An agent may log out while in wrap-up, or unavailable.
- An agent logging in will first be placed in wrap-up mode before receiving an ACD call.
- If an agent attempts to log into an ACD group that already has 16 members, that agent will receive error tone.
- The Starplus Digital System will not verify agent's ID codes, other than requiring four digits to be entered.

\*Refer to Sec. 300.37, Flexible Button Assignment.

**B. ACD Agent "HELP" button**

The ACD Agent "HELP" feature provides a means for an ACD agent to signal his assigned supervisor for assistance. A flex button must be programmed for this feature to operate.

\*Refer to Sec. 300.37, Flexible Button Assignment.

While on a call in progress, the agent:

1. Presses his pre-programmed\* "HELP" flex button. Confirmation tone will be heard by the agent. The agent will see his "HELP" button illuminate if a supervisor is logged into his ACD group. If no supervisor is logged in, the agent will receive a burst of error tone and his "HELP" button will not illuminate.

The ACD supervisor station receives a "HELP" message if a member of one of the ACD groups he is assigned to initiates a "HELP" request. The "HELP" function also sends a Camp-On tone to the speaker of the supervisors keyset. The "HELP" message takes precedence over any other message and can be cleared by the supervisor by pressing his "HELP" button.

At the time the supervisor receives a "HELP" request, he can press his "HELP" flex button followed by his override feature button to bridge onto the ACD group members call. The "HELP" button will place an intercom call to the station requesting "HELP". The "HELP" message will be cleared after the supervisor's "HELP" button is depressed. In addition, the "HELP" message will be cleared if the agent was on a call and went back on hook before the supervisor could respond. In this case, the "HELP" message will be converted to a message wait indication. The agent can also clear the "HELP" request by hitting his "HELP" button a second time.

Conditions:

- Up to five messages can be left at any supervisor station.

- The supervisor can cancel the "HELP" request signal by depressing his flashing "HELP" button. In addition, a call will be placed to the agent requesting "HELP". If the agent is on a call, the supervisor can press his barge-in button to monitor the call or give assistance on the call.

**NOTE**

*Only digital terminals can utilize this feature, since a flexible button is required to be programmed.*

**C. ACD Call Qualification**

The CALL QUALIFICATION feature provides a means for an Agent to enter codes on ACD type calls that identify the call. This feature provides up to four digits for the ACD SMDR reporting function. This feature permits up to 12 digits to be entered, however only the first four digits are provided for in the SMDR record.

The QUALIFY button is programmed using flex code [570#]. If the agent wishes to enter his qualify code in a speed bin, he can do so using the standard speed bin programming sequence. Then when he programs his flex button, he can enter 570 followed by the bin number. This will provide an agent with a series of buttons with qualify codes under them. Refer to Sec. 300.37, Flexible Button Assignment.

While on a call, the agent:

1. Presses the pre-programmed CALL QUALIFY flex button, followed by the four-digit qualify code. Enter a [\*] to complete the sequence. A short burst of confirmation tone will be heard thru the keyset speaker, if programmed.

Conditions:

- The outside party will not hear the (qualify code) account code being entered.
- The qualify code uses the first four digits of the account code. Therefore the account code record in the SMDR will contain the qualify code in the first four digits.
- The qualify code must be entered during CO talk state.
- Speed dial entries can contain all digits including the [\*], which will terminate the entry and return the ACD agent to his CO party.

**D. ACD Available/Unavailable Mode**

If you are a ACD agent, you may place your station in the Available mode to receive ACD type of calls or you may place your station in the Unavailable mode to block ACD type calls from ringing your station.

To go Available:

1. Dial [566] on the dial pad, or press the pre-programmed\* Available/Unavailable button. You may now receive ACD calls,

To go Unavailable:

1. Dial [566] on the dial pad, or press the pre-programmed\* Available/Unavailable button. You are now blocked from receiving ACD calls.

\*Refer to Sec. 300.37, Flexible Button Assignment.

**E. ACD Overflow Station - Available/Unavailable Mode**

If you are a ACD Overflow station, you may place your station in the Available mode to receive ACD type of calls or you may place your station in the Unavailable mode to block ACD type calls from ringing your station.

To go Available:

1. Dial [578] on the dial pad, or press the pre-programmed\* Available/Unavailable button. You may now receive ACD calls.

To go Unavailable:

1. Dial [578] on the dial pad, or press the pre-programmed\* Available/Unavailable button. You are now blocked from receiving ACD calls.

**NOTE**

*If no stations are logged into the ACD Group, ACD calls will overflow to the Attendant station.*

\*Refer to Sec. 300.37, Flexible Button Assignment.

**305.4 CALL FORWARD: STATION****A. Call Forward - All Calls**

If you have been given the ability to forward your calls:

1. Lift handset or press ON/OFF button.
2. Dial the Call Forward code [640] on the dial pad, or Press the pre-programmed\* FWD flex button.
3. Press DSS button of desired station, or dial the three-digit extension number where calls are to be forwarded, including ACD or UCD Group, Voice Mail Group, and Hunt group pilot numbers.

**BASIC KEYSSET FEATURE OPERATION**

- Replace the handset or press the ON/OFF button.

## Conditions:

- Line Queue, Call back requests, message wait requests, and pre-selected messages are canceled when a station activates call forward.
- Call back requests are not allowed at a station where a call is forwarded.
- CO Line calls can be transferred by the receiving station back to the original forwarded station.
- A station in the call forward mode may still make outgoing calls.

## To Remove Call Forwarding:

- Lift handset or press ON/OFF button.
- Dial the Call Forward Cancel code, [662] on the dial pad,  
or  
Press the pre-programmed\* FWD flex button. Confirmation tone will be heard.

\*Refer to Sec. 300.37, Flexible Button Assignment.

**B. Call Forward - No Answer**

If you have been given the ability to forward your calls:

- Lift the handset or press ON/OFF button.
- Dial the Call Forward code [640] on the dial pad,  
or  
Press the pre-programmed\* FWD flex button.
- Dial the Call Forward No-Answer code [7] on the dial pad.
- Dial the three-digit extension number where calls are to be forwarded. Confirmation tone will be heard.
- Replace the handset or press the ON/OFF button.

## To cancel Call Forwarding:

- Lift the handset or press the ON/OFF button.
- Dial the Call Forward Cancel code, [662] on the dial pad,  
or  
Press the pre-programmed\* FWD flex button. Confirmation tone will be heard.

\*Refer to Sec. 300.37, Flexible Button Assignment.

**C. Call Forward - Busy**

If you have been given the ability to forward your calls:

- Lift the handset or press ON/OFF button.

- Dial the Call Forward code, [640] on the dial pad,  
or  
Press the pre-programmed\* FWD flex button.
- Dial the Call Forward Busy code [8] on the dial pad.
- Dial the three-digit extension number where calls are to be forwarded. Confirmation tone will be heard.
- Replace the handset or press the ON/OFF button.

## To cancel Call Forwarding:

- Lift the handset or press the ON/OFF button.
- Dial the Call Forward Cancel code, [662] on the dial pad,  
or  
Press the pre-programmed\* FWD flex button. Confirmation tone will be heard.

\*Refer to Sec. 300.37, Flexible Button Assignment.

**D. Call Forward - Busy/No Answer**

If you have been given the ability to forward your calls:

- Lift the handset or press ON/OFF button.
- Dial the Call Forward code, [640] on the dial pad,  
or  
Press the pre-programmed\* FWD flex button.
- Dial the Call Forward Busy/No Answer code [9] on the dial pad.
- Dial the three-digit extension number where calls are to be forwarded. Confirmation tone will be heard.
- Replace the handset or press the ON/OFF button.

## To cancel Call Forwarding:

- Lift the handset or press the ON/OFF button,
- Dial the Call Forward Cancel code, [662] on the dial pad,  
or  
Press the pre-programmed\* FWD flex button. Confirmation tone will be heard.

\*Refer to Sec. 300.37, Flexible Button Assignment.

**E. Call Forward - Off-Net (via speed-dial)**

In a speed dial bin, store the number of the off-net location where calls are to be forwarded. Follow instructions provided for storing station or system speed dial numbers.

This feature allows stations to forward intercom and transferred CO calls to an off-net location.

- Lift handset or press ON/OFF button.

2. Dial the Call Forward code, [640] on the dial pad,  
or  
Press the pre-programmed\* FWD flex button.
3. Dial [\*] on the dial pad. Then dial the speed bin number that contains the number where calls are to be forwarded. Confirmation tone is heard. FWD button LED is flashing.
4. Replace the handset or press the ON/OFF button.

## Conditions:

- Line Queue, Call back requests, message wait requests, and pre-selected messages are canceled when a station activates call forward.
- Call back requests are not allowed at a station where a call is forwarded.
- CO Line calls can be transferred by the receiving station back to the original forwarded station.
- A station in the call forward mode may still make outgoing calls.

## Canceling Off-Net Forwarding

1. Lift handset or press ON/OFF button.
2. Dial the Call Forward Cancel code, [662] on the dial pad,  
or  
Press the pre-programmed\* FWD flex button.  
CALL FWD button LED is extinguished.

\*Refer to Sec. 300.37, Flexible Button Assignment.

## F. Call Forward - ACD or UCD Groups

If you have been given the ability to forward your calls:

1. Lift the handset or press ON/OFF button.
2. Dial the Call Forward code, [640] on the dial pad,  
or  
Press the pre-programmed\* FWD flex button.
3. Dial the desired code:
  - [7] = no answer calls
  - [8] = busy calls
  - [9] = busy and no answer calls.

**NOTE** Skip the preceding step for immediate forwarding.

4. Dial the three-digit ACD Group Pilot number (550-565) for groups I-I 6, or UCD group pilot number (550-557) for the groups 1-8 where calls are to be forwarded. Confirmation tone will be heard.
5. Replace the handset or press the ON/OFF button.

\*Refer to Sec. 300.37, Flexible Button Assignment.

To cancel Call Forwarding:

1. Lift the handset or press the ON/OFF button.
2. Dial the Call Forward Cancel code, [662] on the dial pad,  
or  
Press the pre-programmed\* FWD flex button.  
Confirmation tone will be heard.

\*Refer to Sec. 300.37, Flexible Button Assignment.

## G. Call Forward - Voice Mail Groups

***This feature is available With optional software.***

Intercom and Transferred CO callers may be routed directly to your mail box by forwarding your phone to a voice mail group. Callers will then be greeted by your personal voice mail greeting if available.

If you have been given the ability to forward your calls:

1. Lift the handset or press ON/OFF button.
2. Dial the Call Forward code, [640] on the dial pad,  
or  
Press the pre-programmed\* FWD flex button.
3. Dial the desired code:
  - [7] = no answer calls
  - [8] = busy calls
  - [9] = busy and no answer calls.

**NOTE** Skip the preceding step for immediate forwarding.

4. Dial the three-digit Voice Mail group pilot number (440-447) for the group (I-8) where calls are to be forwarded. Confirmation tone will be heard.
5. Replace the handset or press the ON/OFF button.

To cancel Call Forwarding:

1. Lift the handset or press the ON/OFF button.
2. Dial the Call Forward Cancel code, [662] on the dial pad,  
or  
Press the pre-programmed\* FWD flex button.  
Confirmation tone will be heard.

\*Refer to Sec. 300.37, Flexible Button Assignment.

## H. Call Forward - Hunt Groups

If you have been given the ability to forward your calls:

1. Lift the handset or press ON/OFF button.
2. Dial the Call Forward code, [640] on the dial pad,  
or  
Press the pre-programmed\* FWD flex button.

3. Dial the desired code:
  - [7] = no answer calls
  - [8] = busy calls
  - [9] = busy and no answer calls.

**NOTE** Skip the preceding step for immediate forwarding.

4. Dial the three-digit Hunt group pilot number (450-457) for the group (1-8) where calls are to be forwarded. Confirmation tone will be heard.
5. Replace the handset or press the ON/OFF button.

To cancel Call Forwarding:

1. Lift the handset or press the ON/OFF button.
2. Dial the Call Forward Cancel code, [662] on the dial pad,  
or  
Press the pre-programmed\* FWD flex button.

\*Refer to Sec. 300.37, Flexible Button Assignment.

### 305.5 CONFERENCE WITH PERSONAL PARK

While connected to an outside line:

- a. Press the TRANS button. Transfer dial tone is heard.
- b. Dial [438] on the dial pad. (1st call is placed in personal park).
- c. Dial desired number for 2nd call.
- d. Press the TRANS button again. Transfer dial tone is heard.
- e. Dial [664] on the dial pad. All three parties are conferenced.
- f. Replace the handset to terminate conference.

### 305.6 CO LINE QUEUING

A station can queue only one line at a time. If you see that a particular outside line is busy and you wish to be placed on a list waiting for that line to become available:

To Place a Queue:

- a. Press the Pool button. Busy tone is heard.
- b. Press the pre-programmed\* LINE QUEUE button.
- c. Replace the handset.

To Answer a Queue:

If you hear ringing and an outside line of the line group (or a Loop or Group Key), you queued onto is rapidly flashing:

- a. Lift handset or press ON/OFF button.
- b. Press flashing Pool button to answer.

**NOTE** If your station has been programmed for Preferred Line Answer, you will have the line automatically upon lifting the handset.

\*A flex button must be programmed for this feature to operate. Refer to Sec. 300.37, Flexible Button Assignment.

### 305.7 DIRECTED CALL PICK-UP

When incoming, transferred, or recalling outside line ringing, intercom ringing, or Camp On ringing is heard at an unattended telephone:

- a. Dial the station number of the known ringing telephone. Receive ringback tone, or call announce tone.
- b. Press the pre-programmed\* PICK UP button to answer the call.

\*A flex button must be programmed for this feature to operate. Refer to Sec. 300.37, Flexible Button Assignment.

Conditions:

- User must have access to the specific outside line or a Loop button to do a directed call pickup.

### 305.8 DO NOT DISTURB

If you have been given the ability to place your phone in Do Not Disturb:

- a. Lift the handset or press the ON/OFF button.
- b. Dial the Do Not Disturb code [631] on the dial pad,  
or  
Press the pre-programmed\* DND button. DND button lights steady.

Removing Do Not Disturb

- a. Dial the Do Not Disturb code [631] on the dial pad,  
or  
Press the pre-programmed\* DND button. The button LED extinguishes and DND is canceled.

\*Refer to Sec. 300.37, Flexible Button Assignment.

### 305.9 MESSAGE WAITING

If you dial a station that is busy, unattended, or in DND, you can leave a message waiting indication.

- a. Lift the handset or press the ON/OFF button.
- b. Dial the desired intercom station. Busy tone or DND tone is heard.
- c. Press the TRANS button. Transfer dial tone is heard.
- d. Dial the Message Wait code [623] on the dial pad. Confirmation tone is heard.
- e. Replace the handset or press ON/Off button to end the call.



**NOTE** *Up to five messages can be left at any Station.*

**Answering a Message Waiting Indication**

If your MSG WAIT lamp is flashing, you have a message waiting for you. The first message left will be the first one called.

- a. Lift the handset or press the ON/OFF button.
- b. Dial the message wait return code [663] on the dial pad. Station that left message will be signaled with tone ringing.
- c. If called station does not answer, press the TRANS button. After receiving transfer tone, dial the message wait code [623] to leave message.

\*Refer to Sec. 300.37, Flexible Button Assignment.

**305.10 MUTE KEY**

The MUTE feature provides privacy during speakerphone or handset operation by disabling the microphone.

To activate the Mute feature:

- a. Press the pre-programmed\* MUTE button while off-hook on speakerphone or handset to activate.

To de-activate the Mute feature:

- a. Press the pre-programmed\* MUTE button again to deactivate.

**NOTE** *The mute feature automatically deactivates upon call termination.*

**305.11 PBX/CENTREX TRANSFER**

While connected to an outside line (PBX/Centrex):

- a. Press the TRANS button. Receive transfer dial tone.
- b. Dial [660] on the dial pad. A flash command will be presented to the PBX or Centrex line. PBX or Centrex studder tone will be heard.
- c. Dial desired outside number.
- d. Replace handset to complete transfer.

**305.12 PERSONAL PARK (Flip-Flop)**

While connected to first call:

- a. Press the TRANS button. The caller is put on Exclusive Hold.
- b. Dial the Personal Park code [438] on the dial pad,  
or  
Press a pre-programmed\* flex button. (call is placed in personal park). Dial tone will be heard.

**NOTE** *The user can alternately connect to the other call by pressing the TRANS button and dialing [438] as many times as necessary.*

**Retrieving a Parked Call:**

- a. Dial the Personal Call Park location code [438] on the dial pad,  
or  
Press the pre-programmed\* PERSONAL PARK button.  
Both the station and the call will receive a warning tone and then a talk path is established between the two parties.

**305.13 PROGRAMMING YOUR NAME INTO THE LCD DISPLAY**

The Basic Digital terminal has the capability for the user to program his name so that people using display telephones will see the name instead of the station number.

- a. Lift handset.
- b. Dial [690] on the dial pad.
- c. Enter your name (up to 7 letters) using the pattern shown below.

A =21	M =61	1 =1#	" =01
B =22	N =62	2 =2#	, =02
C =23	O =63	3 =3#	? =03
D =31	P =71	4 =4#	J =04
E =32	Q =74	5 =5#	! =*1
F =33	R =72	6 =6#	\$ =*2
G =41	S =73	7 =7#	& =*4
H =42	T =81	8 =8#	* =*#
I =43	U =82	9 =9#	( =#1
J =51	V =83	0 =0#	) =#2
K =52	W =91	Space =11	+ =#3
L =53	x =92	: =12	= =#4
	Y =93	- =13	# =##
	z =94	' =14	

- d. Press the SPEED button to complete the programming process.

**305.14 VOLUME CONTROL**

A "slide" switch is provided on the front of the Starplus Basic Digital Terminal to adjust the volume of the voice and tones presented to the terminal speaker.

- The "slide" switch controls the speaker volume which controls all voice signals sent to the speaker i.e. Speaker Phone conversations, BGM, and Page announcements,
- The same "slide" switch also controls the ringing volume which controls all tone signals presented to the speaker i.e. Ringing, splash tones, Camp-On etc... Muted ringing is also controlled by the slide switch. The

**BASIC KEYSSET FEATURE OPERATION**

---

muted ringing volume will be proportionately quieter than normal ringing based on the current switch setting.

## SECTION 310

# SLT FEATURE OPERATION

### 310.1 INTRODUCTION

This section of the manual contains the operating instructions for Single Line users. It is designed to provide step-by-step instructions for operating the Single line telephones in the system.

Literature similar to these operating instructions has been prepared for use by the customer in the form of a Single Line Telephone Users Guide.

### 310.2 ACCOUNT CODE

*This feature is available with optional software.*

SLT stations can enter an account code to identify the call or calling station.

Entering Account Code before a call:

- a. Lift the handset.
- b. Dial [627] on the dial pad.
- c. Dial the account code. If the account code contains fewer than 12-digits, dial [\*] to return to intercom dial tone. Dial tone is heard.
- d. Dial [9] or CO Access code and the desired number.

Entering Account Code during a call:

- a. Depress the hookswitch momentarily. Your call will be placed on hold while you enter your account code.
- b. Dial [627] on the dial pad.
- c. Dial the account code. If the account code contains fewer than 12-digits, dial [\*] to return automatically to the call.

### 310.3 AUTOMATIC CALL DISTRIBUTION (ACD)

*This feature available with optional software.*

When purchased, Uniform Call Distribution (UCD) is not used and is replaced by the ACD functions identified in the following. 16 Automatic Call Distribution (ACD) groups can be programmed, each containing up to 16 three-digit station numbers.

#### A. Agent Login/Logout Feature

The Agent Login/Logout feature provides a means for an agent to log into one of the ACD groups and receive calls. For an agent to be placed into an active ACD state, the agent must first login.

1. Dial the LOGIN CODE [572] on the dial pad, followed by the ACD group number (5xx) that the agent is going to log into.

2. The agent enters his unique AGENT ID code (0000-9999). Confirmation tone is heard and the agent is logged onto the ACD group. When the agent logs in, an ACD login event is sent to the SMDR port, if active.

#### NOTE

**If a member is assigned to a specific ACD group and uses the login-logout codes to enter and exit an ACD group other than his assigned group, the database is changed to reflect the different group.**

For an agent to remove himself from the ACD group as an active agent:

1. Dial the LOGOUT CODE [571] on the dial pad. When the agent logs out and removes himself from the ACD group, an ACD logout event is sent to the SMDR port, if active.

Conditions:

- If an agent logs into an ACD group from a station that is logged into another ACD group, the station will be automatically removed from the previous ACD group.
- An agent may log out while in wrap-up, or unavailable.
- An agent logging in will first be placed in wrap-up mode before receiving an ACD call.
- If an agent attempts to log into an ACD group that already has 16 members, that agent will receive error tone.
- The Starplus Digital System will not verify agent's ID codes, other than requiring four digits to be entered.

#### B. ACD Agent "HELP" button

The ACD Agent "HELP" feature provides a means for an ACD agent to signal his assigned supervisor for assistance.

While on a call in progress, the agent:

1. After hook-flashing, dial the "HELP" code on the dial pad. The agent must hook-flash again to return to his call after the code is dialed. If no supervisor is logged in, the agent will receive one-burst of error tone. The ACD supervisor station receives a "HELP" message if a member of one of the ACD groups he is assigned to initiates a "HELP" request. The "HELP" function also sends a Camp-On tone to the speaker of the supervisors keyset. The "HELP" message



2500 Type



2500 Type w/Msg Waiting Lamp on Top

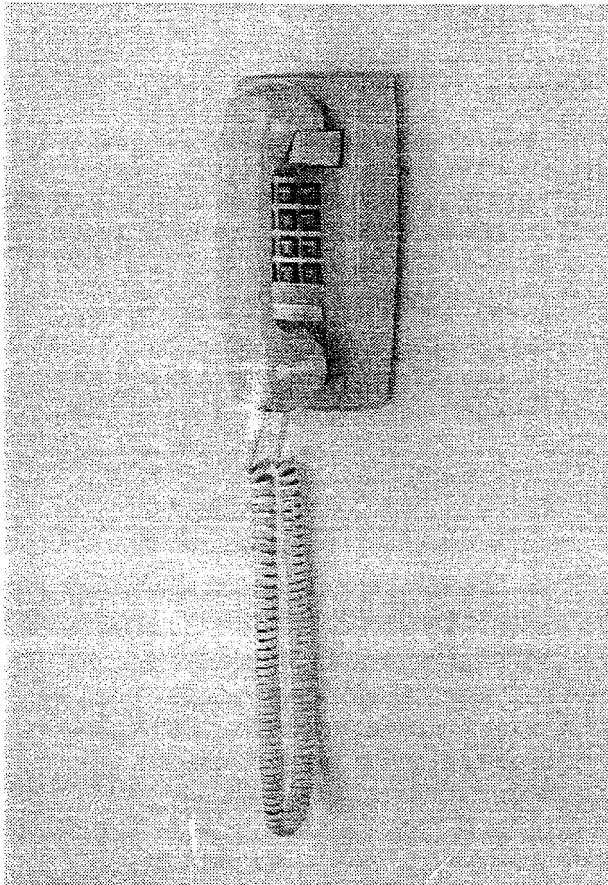

2500 Type Wall Phone



2500 Type w/Message Waiting Lamp



2500 Type w/Flash Key

Table 310-I SLT Numbering Plan

100-195	Station intercom Numbers	668 [YY]	SLT Speed Dial Access
420 [XXX]	Voice Mail* Enable MSG Wait	690	Name in Display Programming
421 [XXX]	Voice Mail' Cancel MSG Wait	70	All Call Page (Internal & External)
43 [C]	Call Park Location O-7 (system)	71	Internal Page Zone 1
438	Personal Park	72	internal Page Zone 2
44 [V]	Voice Mail* Group Pilot Numbers O-7	73	Internal Page Zone 3
45 [H]	Hunt Group Pilot Numbers O-7	74	Internal Page Zone 4
55 [U]	ACD* Group Pilot Numbers O-9	75	Internal All Call Page
55 [U]	UCD Group Pilot Numbers O-7	76 [O]	External Aii Call Page (All Zones)
56 [U]	ACD* Group Pilot Numbers 1 O-15	76 [P]	External Page Zones 1-7
566	ACD*/UCD Available/Unavailable	77	Meet-Me-Page Answer
571	ACD* Agent Logout	81	CO Line Group 1 (if LCR* is enabled)
57255 [U]	ACD' Agent Login		
6# [XXX]	Tone Mode Ring Option	82	CO Line Group 2
620	Camp-On	83	CO Line Group 3
621	Line Queue	84	CO Line Group 4
622	Call Back	85	CO Line Group 5
623	Message Wait	86	CO Line Group 6
624	Conference	87	CO Line Group 7
625	Executive Override	88	All CO line Groups (CO Line Off-Net Forward)
626	LCR* Queue Cancel		
627	Account Code* Enter	9	LCR* or CO Line Group 1 (if LCR* is disabled)
631	Do Not Disturb	0	Attendant
633 [ZZ]	Personalized Messages	#0	Group Call Pick Up (Key & SLT)
633 [00]	Clear Personalized Messages	#1 [XXX]	Directed Call Pick-up (SLT)
638+[0]	Handset Receiver Gain	#43 [C]	Call Park Pickup (Key and SLT)
638+[*]	Handset Receiver Gain Decrease	#5	Universal Night Answer
638+[#]	Handset Receiver Gain increase		
640	All Call Forward		
640 [7]	No Answer - Call Forward		XXX = Intercom Station Numbers
640 [8]	Busy - Call Forward		YY = Speed Dial Bin numbers
640 [9]	Busy/No Answer - Call Forward		ZZ = Personalized Messages
640 [*]	Off-Net - Call Forward		U = ACD* (O-15), UCD (O-7) Group Number
660	SLT Flash Command to CO Line		C = Call Park Location O-7
661 [YY]	SLT Station Speed Dial Programming		H = Hunt Group Number O-7
662	SLT Clear - Call Forward, DND, Personal Messages		V = Voice Mail' Group Number O-7
663	Message Wait return		P = External Page Zone Number 1-7
664	SLT Conference W/ Personal Park		*Features available with optional software.

takes precedence over any other message and can be cleared by the supervisor by pressing his "HELP" button.

At the time the supervisor receives a "HELP" request, he can press his "HELP" flex button followed by his override feature button to bridge onto the ACD group members call. The "HELP" button will place an intercom call to the station requesting "HELP". The "HELP" message will be cleared after the supervisor's "HELP" button is depressed. In addition, the "HELP" message will be cleared if the agent was on a call and went back on hook before the supervisor could respond. In this case, the "HELP" message will be converted to a message wait indication.

Conditions:

- Up to five messages can be left at any supervisor station.
- The supervisor can cancel the "HELP" request signal by depressing his flashing "HELP" button. In addition, a call will be placed to the agent requesting "HELP". If the agent is on a call, the supervisor can press his barge-in button to monitor the call or give assistance on the call.

### C. ACD Available/Unavailable Mode

If you are an ACD agent, you may place your station in the Available mode to receive ACD type of calls or you may place your station in the Unavailable mode to block ACD type calls from ringing your station.

To go Available:

1. Dial [566] on the dial pad. Confirmation tone will be heard through the handset. You may now receive ACD calls.

To go Unavailable:

1. Dial [566] on the dial pad. Confirmation tone will be heard through the handset. You are now blocked from receiving ACD calls.

### 310.4 CALL BACK

You call a busy station and receive busy:

- a. Briefly depress and release the hookswitch.
- b. Dial [622] on the dial pad.
- c. Replace handset.

#### NOTE

*Only one Call Back request can be left at a Station; the second request will convert to Message Waiting Request*

### 310.5 CALL FORWARDING

To call forward calls to another station:

- a. Lift handset.

b. Dial [640] on the dial pad.

c. Skip Step c. for immediate forwarding, otherwise dial the appropriate code:

- [7] = Call Forward No Answer
- [8] = Call Forward Busy
- [9] = Call Forward Busy/No Answer
- [\*] = Call Forward Off-Net (via speed dial)

d. Dial the three-digit extension number or speed bin number where calls are to be forwarded. Confirmation tone will be heard.

e. Replace handset.

To Remove Call Forwarding:

- a. Lift handset.
- b. Dial [640] on the dial pad or [662] on the dial pad. Confirmation tone will be heard.
- c. Replace the handset.

### 310.6 CALLING STATION TONE MODE OPTION

Allows a calling station to override a called key station's "H" or "P" intercom switch setting.

When placing a call to a key station and Tone ringing is desired:

- a. Dial [6#] on the dial pad.
- b. Dial three-digit station extension (call tone rings station).

### 310.7 CAMP-ON

After receiving intercom busy tone:

- a. Briefly depress and release the hookswitch.
- b. Dial [620] on the dial pad. When the called party answers, consult with them.

While on a CO line you receive a Camp-on warning tone through handset:

- a. Choose desired call (hang up on present call and take the new one, or ignore the Camp-on signal). (also see Personal Park)

### 310.8 CALL PARK (System)

To place an outside call on hold and consult with, page, or call an internal party before transferring the outside call.

While connected to an outside line:

- a. Depress and release the hookswitch. The caller is put on Exclusive hold.
- b. Dial parking location (430 to 437) on the dial pad. Confirmation tone is heard.
- c. If you hear busy tone, depress and release the hookswitch and dial another parking location.

Retrieving a Parked Call

- a. Lift handset.

- b. Dial a pound [#] on the dial pad.
- c. Dial parking location (430 to 437) where the call was parked.

**310.9 CALL TRANSFER:**

Making an Unscreened Transfer

- a. Briefly depress and release the hookswitch.
- b. Dial desired intercom number.
- c. Hang up to complete the transfer.

Making a Screened Transfer:

- a. Briefly depress and release the hookswitch.
- b. Dial desired telephone number. Announce the call.
- c. Hang up to complete the transfer.

**310.10 CLEAR CALL FORWARD, DND, PERSONALIZED MESSAGES**

SLTs can activate and cancel call forward by dialing [640] on the dial pad and DND by dialing [631] and enable and cancel personalized messages by dialing [633xx].

A convenient code [662] has been incorporated to cancel either Call forwarding, DND, or Personalized Messages when the SLT user has forgotten which code has been programmed on the phone

To cancel Call Forward, DND, Personalized Messages:

- a. Lift handset. Notification tone will be heard.
- b. Dial [662] on the dial pad. Confirmation tone will be heard.
- c. Replace the handset.

**310.11 CO LINE QUEUING**

- a. Dial outside line access code. Receive busy tone.
- b. Briefly depress and release the hookswitch.
- c. Dial [621] on the dial pad. Confirmation tone is heard.

**310.12 CONFERENCE**

You may set up a conference of 1 external and 1 other internal station.

- a. Lift handset.
- b. Make outside call.
- c. Briefly depress and release the hookswitch to put the call on hold.
- d. Dial number of internal station you wish to add.
- e. When that station answers, briefly depress and release the hookswitch again and all 3 parties will be connected.

**310.13 CONFERENCE WITH PERSONAL PARK**

While connected to an outside line:

- a. Depress the hookswitch momentarily. Intercom dial tone is heard.
- b. Dial [438] on the dial pad. (1st call is placed in personal park).
- c. Dial desired number for 2nd call.
- d. Depress the hookswitch momentarily. intercom dial tone is heard.
- e. Dial [664] on the dial pad. All three parties are **conferenced**.
- f. Hang up to terminate conference.

**310.14 DIRECT OUTSIDE LINE ACCESS**

- a. Lift handset.
- b. Dial access code (9, 81 - 87) on the dial pad.
- c. Dial desired telephone number.

**310.15 DIRECTED CALL PICK-UP**

Upon hearing an unattended telephone ring:

- a. Lift handset.
- b. Dial [#1] on the dial pad.
- c. Dial station number of ringing telephone. You will be connected to intercom, incoming, recalling or transferred outside line.

**310.16 DO NOT DISTURB**

Activating Do Not Disturb:

- a. Lift handset.
- b. Dial [631] on the dial pad.
- c. Replace handset.

To cancel Do Not Disturb:

- a. Lift handset.
- b. Dial [631] on the dial pad or [662] on the dial pad.
- c. Replace handset.

**310.17 PBX/CENTREX TRANSFER (Flash Command to CO Line)**

To initiate a PBX or Centrex Transfer command from an SLT.

While connected to a PBX or Centrex line:

- a. Briefly depress and release the hookswitch. Intercom dial tone will be heard.
- b. Dial [660] on the dial pad. A Flash command will be presented to the PBX or Centrex line.
- c. PBX or Centrex studder tone will be heard. Dial number of desired extension.
- d. Replace handset to complete transfer.

**SLT FEATURE OPERATION****310.18 GROUP CALL PICK-UP**

Upon hearing an unattended telephone ringing:

- a. Lift the handset.
- b. Dial [#0] on the dial pad. You will be connected to intercom or transferred or recalling outside line call.

**NOTE** You must be in the same pickup group.

**310.19 PLACING CALLS ON EXCLUSIVE HOLD**

While connected to an outside line:

- a. Briefly press and release the hookswitch. (Call is placed on Exclusive Hold).

To retrieve the call:

- a. Press and release the hookswitch again.

**310.20 HANDSET RECEIVER GAIN**

This feature allows an SLT user to increase/decrease the handset volume while on a CO or intercom call.

While on a CO or intercom call:

- a. Hookflash and dial the Handset Receiver Gain code [638] on the dial pad.
- b. Dial a one-digit entry [0] through [9] on the (0=lowest, 9=highest) on the dial pad, or  
Press the [#] to increase or [\*] to decrease the gain, one level at a time.
- c. Hookflash again to return to call.
- d. Repeat above procedures, if necessary.
- e. Replace the handset to end the call.

**310.21 INTERCOM CALLING**

- a. You will hear ringing if called station is in the "T" answering mode; or two bursts of tone if called station is in the "H" or "P" position.
- b. Lift the handset.
- c. Dial the three-digit intercom number:  
– 100-I 95 for Starplus SPD 4896 system
- d. Converse after the two tone bursts stop.
- e. Replace the handset to end the call.

Answering an Intercom Call

- a. Lift handset to converse.
- b. Replace handset to end call

**310.22 LEAST COST ROUTING**

**This feature is available with optional software.**

To place an outside call when LCR has been enabled in the system:

- a. Lift the handset.
- b. Dial [9] on the dial pad.

- c. Dial the desired seven-digit telephone number (i.e.: 1+ area code+7-digit number).

- d. Wait for an answer, then converse.

If all lines available to you are busy, remain off-hook for four seconds to automatically be queued onto LCR for an available line.

If an LCR Queue Callback has been activated:

- a. When telephone is signaled, answer the call.
- b. Desired telephone number will automatically be re-dialed.

**NOTE** Only one LCR Queue Call Back request may be initiated by a station when a second request is made, the first request is canceled

If an LCR Queue Callback has been activated and you wish to cancel that callback request:

- a. Dial the LCR Queue Cancel code, [626] on the dial pad.
- b. Replace the handset.

**310.23 MESSAGE WAITING**

Leaving a Message Waiting Indication

- a. Lift handset.
- b. Dial the desired intercom station. Receive no answer, or DND tone.
- c. Briefly depress and release the hookswitch.
- d. Dial [623] on the dial pad.
- e. Replace handset.

Answering a Message Waiting Indication.

Your message waiting lamp is flashing:

- a. Lift handset.
- b. Dial [663] on the dial pad. Station that left the message will ring.

**NOTE** Only SLT's equipped with message waiting lamp will have access to this feature. OPXstations do not have message waiting capability.

**310.24 OFF-HOOK PREFERENCE**

If your phone has been programmed for Off-Hook Preference, you will hear outside line dial tone when lifting the handset.

When this operation is enabled, you may not have access to all features contained in this User Guide. However, consult your Centrex or PBX User's Guide for additional features you may have.

**310.25 PERSONALIZED MESSAGES**

Each station can select a pre-assigned message to be displayed on the LCD of any Key Telephone calling that station. To select one of the ten available messages:

- a. Dial [633] on the dial pad.



- b. Dial the two-digit code for the message which will appear.
  - [00] = clears message
  - [01] = ON VACATION
  - [02] = RETURN AM
  - [03] = RETURN PM
  - [04] = RETURN TOMORROW
  - [05] = RETURN NEXT WEEK
  - [06] = ON TRIP
  - [07] = IN MEETING
  - [08] = AT HOME
  - [09] = ON BREAK
  - [10] = AT LUNCH

**NOTE** This feature is not available to the attendants.

- c. Replace the handset. (Activating DND or Call Forwarding cancels selected message.)

**310.26 PAGING**

- a. Lift handset.
- b. Dial the two-digit paging code. Wait for page warning tone
  - [70] = All Call - Internal & External
  - [71] = Internal Zone 1
  - [72] = Internal Zone 2
  - [73] = Internal Zone 3
  - [74] = Internal Zone 4
  - [75] = Internal All Call
  - [76](O) = External All Call (All Ext Zones)
  - [76](Z) = External Zones 1-7)
- c. Speak in normal tone of voice to deliver message.

Stations off-hook or in DND will not hear the internal page announcement.

**NOTE** When making a Zone Page or All Call Page and the zone is busy, the page initiator will receive ringback tone until the zone becomes available. You will then hear a warning tone and can make the page announcement.

- d. Deliver page in normal tone of voice.
- e. Replace handset to terminate page.

**310.27 MEET ME PAGE**

To request another party to meet you on a page:

- a. Dial the desired two-digit or three-digit paging code.
- b. Request that party meet you on the page.
- c. Do not hang up: wait for the requested party to answer. As soon as the paged party answers and is connected to you, the page circuit is released.

Answering a Meet Me Page

- a. Go to the nearest telephone and dial [77] on the dial pad. You will be connected to the party that paged you.

**310.28 PERSONAL PARK (Flip-Flop)**

While connected to first call:

- a. Depress the hookswitch momentarily. Intercom dial tone is heard.
- b. Dial [438] on the dial pad. (call is placed in personal park).
- c. Dial desired number for 2nd call.
- d. Depress the hookswitch momentarily. Intercom dial tone is heard.
- e. Dial [438] on the dial pad. (1st call is returned and 2nd call is placed in personal park).

**NOTE** The user can alternately connect to the other call by doing a hook-flash and dialing [438] as many times as necessary.

**310.29 PROGRAMMING YOUR NAME INTO THE LCD DISPLAY**

Every SLT extension has the capability to program the users name so that people using display telephones will see the name instead of the station number.

- a. Lift handset.
- b. Dial [690] on the dial pad.
- c. Enter your name (up to 7 letters) using the uattern shown below.

A=21	M =61	1 =1#	" =01
B =22	N =62	2 =2#	, =02
C =23	O =63	3 =3#	? =03
D =31	P =71	4 =4#	/ =04
E =32	Q =74	5 =5#	! =*1
F =33	R =72	6 =6#	\$ =*2
G =41	s =73	7 =7#	& =*4
H =42	T =81	8 =8#	* =*#
I =43	U =82	9 =9#	( =#1
J =51	V =83	0 =0#	) =#2
K =52	w =91	Space =11	+ =#3
L =53	x =92	: =12	= =#4
	Y =93	• =13	# =##
	Z =94	' =14	

- d. Press the hookswitch to complete the programming process.

**SLT FEATURE OPERATION****310.30 STATION SPEED DIAL**

- a. Lift handset.
- b. Dial [668] on the dial pad.
- c. Dial desired station speed bin number (00-1 9).

**310.31 STORING STATION SPEED NUMBERS**

- a. Lift handset.
- b. Dial [661] on the dial pad.
- c. Dial desired station speed bin number (00-1 9).
- d. Dial telephone number you wish to store.
- e. Briefly depress and release the hookswitch. (Confirmation tone is heard.)

**NOTE**

*Line Group 1 will be programmed along with SLT speed numbers and thus Line Group 1 will be used when activating station speed dial from an SLT.*

**310.32 SYSTEM SPEED DIAL**

- a. Lift handset.
- b. Dial [668] on the dial pad.
- c. Dial desired system speed bin number (20-99).

**310.33 UNIVERSAL NIGHT ANSWER (UNA)**

Upon hearing an incoming signal:

- a. Lift handset.
- b. Dial the UNA access code [#5] on the dial pad. You will be connected to ringing outside line.

**310.34 UCD AVAILABLE/UNAVAILABLE**

If you are a UCD Agent, you may place your station in the Available mode to receive UCD type of calls or you may place your station in the Unavailable mode to block UCD type of calls from ringing at your station.

To go Available:

- a. Dial [566] on the dial pad. You may now receive calls.

To go Unavailable:

- a. Dial [566] on the dial pad, You are now blocked from receiving UCD calls.

## SECTION 320

# ATTENDANT FEATURE OPERATION

### 320.1 INTRODUCTION

The Starplus Digital Key Telephone System has a wide variety of features and flexible programming, allowing each telephone user to program his/her telephone to meet his/her own individual needs.

This section of the manual contains the operating instructions for Attendant Key Telephone user(s) and includes an illustration of the 34-button digital key telephone used in the Starplus Digital Key Telephone System and description of the keys on the telephones and their functions. It is intended that this section be used in conjunction with the Station Operation section to provide step-by-step instructions for operating the Attendant(s) Digital Terminal(s) in the system. Visual and audible cues which accompany the various steps in the operation of the features are also included.

Literature similar to these operating instructions has been prepared for use by the customer in the form of an Attendant Users Guide.

### 320.2 ATTENDANT KEY TELEPHONE STATION FEATURES

Each Starplus Digital Key Telephone System provides the following keys, indicators and features:

**HANDSET AND SPEAKER** are located at the left side of the front panel. A handset is provided to allow confidential conversation when desired. Lifting the handset from its cradle (going off-hook) disengages the station's built-in speaker.

The speaker is located directly below the center portion of the handset. The station may be operated with the handset on-hook. When this occurs, audio is transmitted to the station user through the station's speaker.

**CAMP-ON** (flex) button enables you to alert a busy party that an outside line is on hold and waiting for them. A flex button must be assigned to use this feature.

**LINE QUEUE** (flex) button allows you to queue onto an outside line when all lines in a group are busy. Your station is placed in queue awaiting a line in the same group to become available. A flex button must be assigned to use this feature.

**CALL BACK** (flex) button allows you to initiate an automatic call back request to another busy station. As soon as that station becomes idle, the station that left the call back request is

signaled. A flex button must be assigned to use this feature.

**PICK UP** (flex) button allows you to pickup a tone ringing intercom call, transferred, incoming, or recalling outside line call to a specific unattended station either by group or directed call pick-up.

**MSG WAIT (MESSAGE WAIT)** (flex) button allows you to initiate a message waiting indication at stations that are busy, unattended, or in Do Not Disturb. Message Waiting Callback request left at your station will be indicated by a flashing Msg Wait LED.

**FWD (CALL FORWARD)** (flex) button allows you to forward your calls to another station.

**DND (DO NOT DISTURB)** (flex) button allows the user to place his/her telephone into a Do Not Disturb mode to eliminate incoming outside line ringing, intercom calls, transfers and paging announcements. The station in DND can use the telephone to make normal outgoing calls. On Attendant stations, this button becomes the system Night Mode button. A flex button must be assigned to use this feature.

**CONF (CONFERENCE)** (flex) button is used to establish and build conference calls.

#### FIXED FEATURE BUTTONS:

**HOLD** button enables you to place an outside caller on hold.

**TRANSFER (TRANS)** button is used to transfer an outside call from one station to another.

**FLASH** button is used to terminate an outside call and restore dial tone without having to hang up the handset. It is also used to transfer calls behind a PBX or Centrex within those systems.

**SPEED** button provides you with access to speed dialing, save number redial and last number redial. This button is also used to access speed dial and flex button programming.

**MUTE** button allows you to switch the built-in microphone on or off when using the speakerphone, or the handset microphone when using the handset. A flex button must be assigned to use this feature.

**ATTENDANT FEATURE OPERATION**

ON/OFF button enables you to make a telephone call without lifting the handset. it turns the telephone on and off when using the speakerphone.

**OUTSIDE CALLS** are announced by a tone signal repeated every 3.2 seconds. The corresponding outside line indicator will flash slowly.

**INTERCOM CALLS** can be tone ringing or voice announce. if it is voice announced, the receiving station will receive 2 bursts of tone prior to the announcement. if it is a tone ringing call, the receiving station will hear a tone ring every 2.4 seconds.

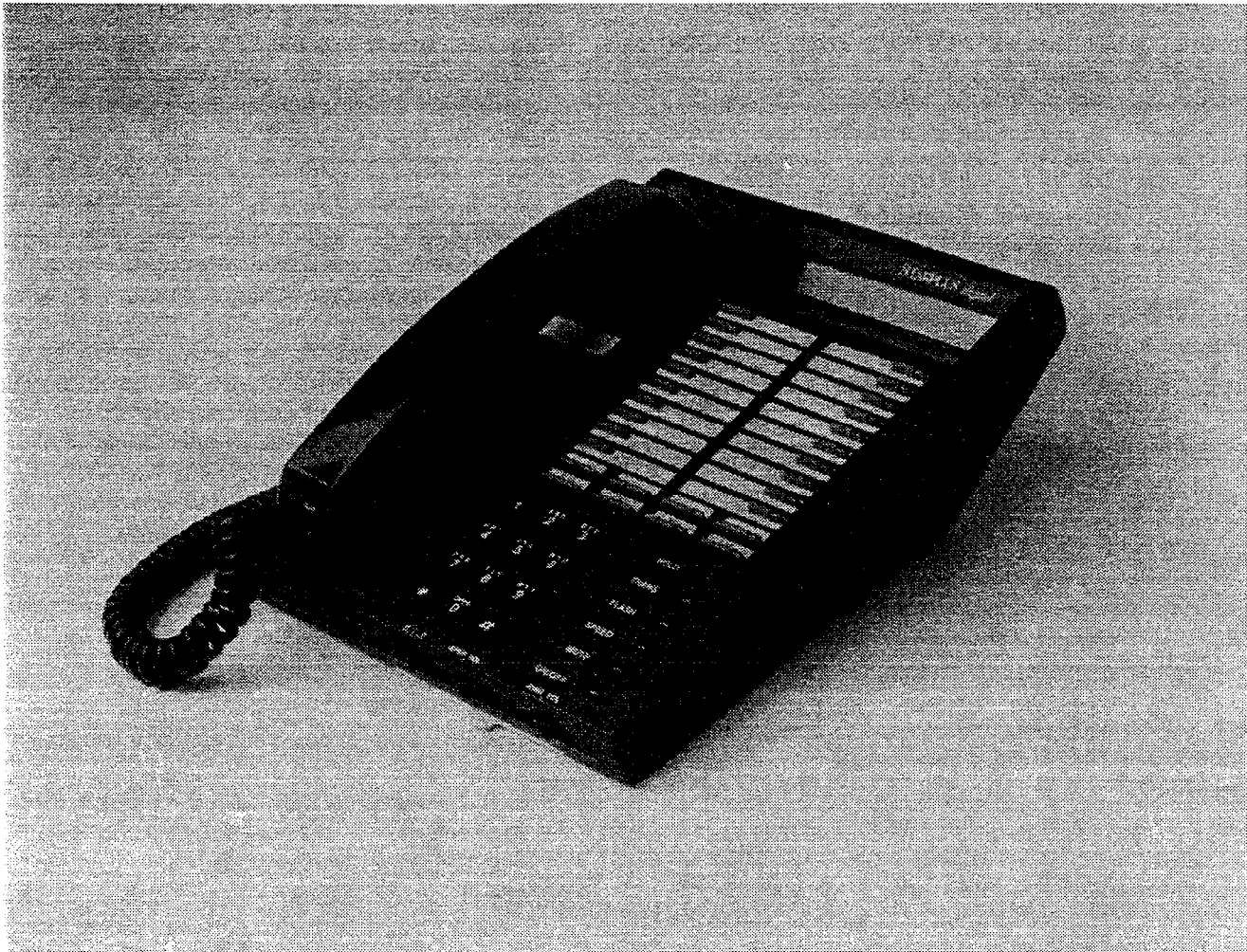

Figure 320-I Attendant Display Terminal

Table 320-I Attendant Numbering Plan

100-195	Station Intercom Numbers	680	Dial Speed Directory
43 [C]	Call Park Location O-7 (system)	6 9 0	Name in Display Programming
438	Personal Park	691 [BB]	Off-hook Preference Programming
44 [V]	Voice Mail* Group Pilot Numbers O-7	692	Time & Date Programming (1 st programmed Attendant)
45 [H]	Hunt Group Pilot Numbers O-7	693	Directory List program code
499	Modem via DISA access or transfer	694	Custom Message(s) program code
55 [U]	ACD* Group Pilot Numbers O-9	695	Distinctive Ringing
55 [U]	UCD Group Pilot Numbers O-7	70	All Call Page (Internal & External)
56 [U]	ACD* Group Pilot Numbers 10-15	71	Internal Page Zone 1
566	ACD*/UCD Available/Unavailable	72	Internal Page Zone 2
567 55 [U]	ACD*/UCD Calls in Queue Display	73	Internal Page Zone 3
570 [BB]	ACD* Call Qualifier	74	Internal Page Zone 4
571	ACD* Agent Logout	75	Internal All Call Page
572 55 [U]	ACD* Agent Login	76 [O]	External All Call Page (All Zones)
573	ACD* Group Member Status	76 [P]	External Page Zones I-7
574	ACD* Agent Help Request	77	Meet-Me-Page Answer
575	ACD* Supervisor Logout	81	CO Line Group 1 (if LCR* is enabled)
576	ACD* Supervisor Login	a2	CO Line Group 2
577	ACD* Supervisor Queue Status Display	a3	CO Line Group 3
578	ACD* Overflow Sta Available/Unavailable	a4	CO Line Group 4
6# [XXX]	Tone Mode Ring Option	a5	CO Line Group 5
6*	Dial By Name	86	CO Line Group 6
601	Attendant Override	a7	CO Line Group 7
602	Disable Outgoing CO Line Access	88 [YY]	All CO line Groups (CO Line Off-Net Forward)
603	CO Line Off-Net Forward	9	LCR* or CO Line Group 1 (if LCR* is disabled)
604	Night Service	0	Attendant
620	Camp-On	#0	Group Call Pick Up (Key & SLT)
621	Line Queue	#43[C]	Call Park Pickup (Key and SLT)
622	Call Back	#5	Universal Night Answer
623	Message Wait	[SPEED] YY	Speed Dial Access (00-I 9 Station) (20-99 System)
624	Conference	[SPEED]+[*]	Save Number Redial
625	Executive Override/Monitor Barge-in	[SPEED]+[#]	Last Number Redial
626	LCR* Queue Cancel		
627	Account Code* Enter		
628	OHVO Enable		
631	Do Not Disturb		
632	Background Music		
633+[ZZ]	Personalized Messages		
633+[00]	Clear Personalized Messages		
634	Headset Mode		
635	ICLID* Unanswered Calls Display		
636 [XXX]	Station Relocate		
638+[0]	Handset Receiver Gain w/display		
FWD	All Call Forward		
[FWD]+[7]	No Answer - Call Forward		
[FWD]+[8]	Busy - Call Forward		
[FWD]+[9]	Busy/No Answer - Call Forward		
[FWD]+[*]	Off-Net - Call Forward		
641	Release Button (Key and Attendants)		

XXX = Intercom Station Numbers  
YY = Speed Dial Bin numbers  
ZZ = Personalized Messages  
BB = Button Number  
U = ACD\* (O-15) or UCD (O-7) Group Number  
C = Call Park Location O-7  
H = Hunt Group Number O-7  
V = Voice Mail\* Group Number O-7  
P = External Page Zone Number I-7

\*Features available with optional software.

**ATTENDANT FEATURE OPERATION****320.3 ANSWERING AN OUTSIDE CALL**

- a. Lift handset.
- b. Press slow flashing outside line button. (If your telephone is programmed with Preferred Line Answer, you may answer an outside line by lifting the handset.)

**320.4 PLACING OUTSIDE LINE ON HOLD**

- a. if your system is programmed for Exclusive Hold Preference, press HOLD button once for Exclusive Hold and twice for System Hold.
- b. If your system is programmed for System Hold Preference, press HOLD button once for System Hold and twice for Exclusive Hold.

**320.5 ANSWERING A RECALLING OUTSIDE LINE**

When an outside line has remained on hold for an extended period of time, you will be reminded with a recalling ring.

- a. Press outside line button flashing at very fast rate.
- b. Lift handset to converse.

**320.6 ATTENDANT DISABLE OUTGOING ACCESS**

The attendant station can disable CO lines, preventing outgoing CO calls.

- a. Lift handset or press ON/OFF button.
- b. Dial [602] on the dial pad. Confirmation tone is heard.
- c. Depress the line button(s) of the CO line(s) to be disable. Confirmation tone is heard and the CO Line Button(s) LED is flashing.
- d. To re-activate the CO Line(s), repeat the steps followed to disable it.

**320.7 ATTENDANT OVERRIDE**

If Attendant Override is allowed, Attendant(s) stations may override or call stations that are either busy or in Do Not Disturb.

If the Attendant calls a station that is busy on a CO call and wishes to alert them of a waiting call:

- a. Press the pre-programmed\* ATTN OVERRIDE button. Three short tone bursts will be presented to the called party.
- b. After five (5) seconds, the station's CO line will automatically be placed on hold and the Attendant will be cut-thru.

If the Attendant calls a station that is in Do Not Disturb mode and wishes to alert them of a call;

- a. Press the pre-programmed\* ATTN OVERRIDE button. The station will be signaled with a Camp-on tone.

\*Refer to Sec. 300.37, Flexible Button Assignment.

**320.6 ATTENDANT RECALL**

When an outside line has remained on hold for an extended period of time, you will be reminded with a recalling ring.

- a. Press outside line button flashing at a very fast rate.
- b. Lift handset to converse.

**320.9 DATA FEATURE**

The Data Feature is a time division switched, point to point data transmission capability which permits simultaneous voice and data communications (within the same system but not the same port). The Data Feature offers the ability to transmit data information between personal computers, printers, plotters, modems, CRT terminals, and main frame computer ports.

To establish a Data call, a Digital Data Interface Unit (DDIU) is required to be connected to each data communications device. Data information can be switched through the system at speeds of 300, 1200, 2400, 4800, 9600, 19.2K and 38.4K baud asynchronous.

To establish a connection between two DDIU:

- a. The first attendant dials the extension number of one data unit. Dial tone is received and the display will show the BAUD RATE.
- b. The first attendant then dials the station number of the second data unit. Confirmation tone is heard. This connection will be maintained until the first attendant dials the station number of one DDIU followed by pressing the FLASH button.

To break down an established connection:

- a. The first attendant dials one of the DDIU extension numbers  
or  
Presses the DSS button for the DDIU.
- b. Press the "FLASH" button. The connection is removed.

The first attendant can configure any DDIU by:

1. Dial the DDIU access code [637] on the dial pad.
2. Enter the three-digit extension number of the DDIU. The display will show the BAUD rate setting, the data length (8 or 9), and the number of stop bits (1 or 2).

To change the baud rate:

1. Press the "HOLD" button. Then enter the one-digit baud rate desired.  
- [1] = 300

**ATTENDANT FEATURE OPERATION****320.3 ANSWERING AN OUTSIDE CALL**

- a. Lift handset.
- b. Press slow flashing outside line button. (if your telephone is programmed with Preferred Line Answer, you may answer an outside line by lifting the handset.)

**320.4 PLACING OUTSIDE LINE ON HOLD**

- a. If your system is programmed for Exclusive Hold Preference, press HOLD button once for Exclusive Hold and twice for System Hold.
- b. If your system is programmed for System Hold Preference, press HOLD button once for System Hold and twice for Exclusive Hold.

**320.5 ANSWERING A RECALLING OUTSIDE LINE**

When an outside line has remained on hold for an extended period of time, you will be reminded with a recalling ring.

- a. Press outside line button flashing at very fast rate.
- b. Lift handset to converse.

**320.6 ATTENDANT DISABLE OUTGOING ACCESS**

The attendant station can disable CO lines, preventing outgoing CO calls.

- a. Lift handset or press ON/OFF button.
- b. Dial [602] on the dial pad. Confirmation tone is heard.
- c. Depress the line button(s) of the CO line(s) to be disabled. Confirmation tone is heard and the CO Line Button(s) LED is flashing.
- d. To re-activate the CO Line(s), repeat the steps followed to disable it.

**320.7 ATTENDANT OVERRIDE**

If Attendant Override is allowed, Attendant(s) stations may override or call stations that are either busy or in Do Not Disturb,

If the Attendant calls a station that is busy on a CO call and wishes to alert them of a waiting call:

- a. Press the pre-programmed\* ATTN OVERRIDE button. Three short tone bursts will be presented to the called party.
- b. After five (5) seconds, the station's CO line will automatically be placed on hold and the Attendant will be cut-thru.

If the Attendant calls a station that is in Do Not Disturb mode and wishes to alert them of a call;

- a. Press the pre-programmed\* ATTN OVERRIDE button. The station will be signaled with a Camp-on tone.

\*Refer to Sec. 300.37, Flexible Button Assignment.

**320.8 ATTENDANT RECALL**

When an outside line has remained on hold for an extended period of time, you will be reminded with a recalling ring..

- a. Press outside line button flashing at a very fast rate;
- b. Lift handset to converse.

**320.9 DATA FEATURE**

The Data Feature is a time division switched, point to point data transmission capability which permits simultaneous voice and data communications (within the same system but not the same port). The Data Feature offers the ability to transmit data information between personal computers, printers, plotters, modems, CRT terminals, and main frame computer ports.

To establish a Data call, a Digital Data Interface Unit (DDIU) is required to be connected to each data communications device. Data information can be switched through the system at speeds of 300, 1200, 2400, 4800, 9600, 19.2K and 38.4K baud asynchronously.

To establish a connection between two DDIU:

- a. The first attendant dials the extension number of one data unit. Dial tone is received and the display will show the BAUD RATE.
- b. The first attendant then dials the station number of the second data unit. Confirmation tone is heard. This connection will be maintained until the first attendant dials the station number of one DDIU followed by pressing the FLASH button.

To break down an established connection:

- a. The first attendant dials one of the DDIU extension numbers  
or  
Presses the DSS button for the DDIU.
- b. Press the "FLASH" button. The connection is removed.

The first attendant can configure any DDIU by:

1. Dial the DDIU access code [637] on the dial pad.
2. Enter the three-digit extension number of the DDIU. The display will show the BAUD rate setting, the data length (8 or 9), and the number of stop bits (1 or 2).

To change the baud rate:

1. Press the "HOLD" button. Then enter the one-digit baud rate desired.  
- [1] = 300

- [2] = 1200
- [3] = 2400
- [4] = 4800
- [5] = 9600
- [6] = 19.2K
- [7] = 38.4K

2. Press the SPEED button to save any changes made.

To change the character length:

1. Press the TRANS button. Then enter the one-digit character length desired, either 8 or 9.
2. Press the SPEED button to save any changes made.

To change the number of stop bits:

1. Press the MUTE button. Then enter the one-digit stop bit desired.
2. Press the SPEED button save any changes made.

Refer to Station Attributes Programming, 630.2, Station identification for programming the Station ID of the Digital Data Interface Unit (DDIU). Also refer to Sec. 630.3, Digital Data Interface Unit (DDIU) for programming the parameters of the Digital Data Interface Unit (DDIU).

Conditions:

- The system is transparent to the devices being connected. Therefore each DDIU must be configured with a specific baud rate, number of data bits and number of stop bits. This configuration will be done by the first attendant or in the case of an associated data unit can be configured by the user.
- Data ports can be arranged in ACD or UCD Groups, or Hunt Groups.
- Data ports do not have to be associated with a keyset, however to connect two DDIU devices one of them must be associated with a keyset unless the connection is made by the first attendant.
- When the data connection has been completed, the baud rate used in the connection will be displayed on the keyset.
- Non associated DDIU connections can be broken down by the first attendant.
- A DDIU has a DCE interface. Therefore a straight through RS-232C cable can be used connect to a DTE device (printer, PC, etc.).
- Each DDIU requires a digital terminal port.

**320.10 DIAL BY NAME**

The system will allow station users to dial extension numbers or speed bin by entering a name of a person that has been programmed for that station. The system database will allow entry of a name (alphanumeric) up to 24 characters in length for each station. This programmed name can be used for dialing-by-name users and in some cases LCD displays.

To dial a station user by name:

- a. Dial the Dial-By-Name code [6\*] on the dial pad,  
**or**  
**press** the pre-programmed\* DIAL-BY-NAME flex button.
- b. Dial the desired person's name using the keys on the key pad. For example: if you wanted to call Linda Murphy, and last names were entering into the directory dialing list, you would press the digit 6 (M), then the digit 8 (U), then the digit 7 (R), the digit 7 again (P), the digit 4 (H) and finally the digit 9 (Y).

ALPHA NUMERIC CHARACTER	DIGIT
A,B,C	2
D,E,F	3
G,H,I	4
J,K,L	5
M,N,O	6
P,Q*,R,S	7
T,U,V	8
W,X,Y,Z*	9
*does not appear on dial pad.	

When the system finds a unique numeric match (MURPHY=687749) to the name being dialed, the call will be placed to the station matching the name. The intercom call will signal the station according to the H-T-P switch setting. If fewer than eight digits are dialed, the numeric match will be dialed after a 10 sec. interdigit time-out occurs, or if a "[#]" (pound), is pressed.

\*Refer to Sec. 300.37, Flexible Button Assignment.

Conditions:

- The system will dial the station that matches the dialed name when a unique match is found. If multiple names are located (found) after eight digits, the first one is dialed.
- The names will be entered as a part of the system attributes database. Numbers may be entered as part of a name. To avoid conflicts, all names must have a unique numerical sequence.



320.11 **DISTINCTIVE RINGING**

The tone ring signal used to notify stations of an incoming call can be changed by each station user to provide distinctive ringing among a group of stations. Each station user may select a distinctive ringing tone that will be used to ring their station. The system provides 81 different ring patterns that each station user may select from.

To select a distinctive ring tone for a station:

- Dial the Tone Ring program code [695] on the dial pad.
- Enter the two-digit tone number. The telephone speaker will sound a steady tone that correlates to the two digit entry.
- When the desired tone is selected, press the SPEED button to save this as the tone to be presented when the station is tone rung. Confirmation tone will be heard. This tone will be presented as a result of an incoming CO or intercom call, recalling CO line or Transferred CO line or at any other time the station is tone rung (refer to conditions below).

The 81 ringing choices are as follows:

TONE #	FREQ	DURATION
00	1 2 0 9 0 4 7 7	50ms/50ms
01	697/770	50ms/50ms
02	697/852	50ms/50ms
03	697/941	50ms/50ms
04	697/1209	50ms/50ms
05	697/1336	50ms/50ms
06	697/1477	50ms/50ms
07	697/1633	50ms/50ms
08	697/OFF	burst
10	770/697	50ms/50ms
11	770/770	50ms/50ms
12	770/852	50ms/50ms
13	770/941	50ms/50ms
14	770/1209	50ms/50ms
15	770/1336	50ms/50ms
16	770/1477	50ms/50ms
17	770/1633	50ms/50ms
18	770/OFF	burst
20	852/697	50ms/50ms
21	852/770	50ms/50ms
22	852/852	50ms/50ms
23	852/941	50ms/50ms
24	852/1209	50ms/50ms
25	852/1336	50ms/50ms
26	852/1477	50ms/50ms
27	852/1633	50ms/50ms
28	852/OFF	burst

30	941/697	50ms/50ms
31	941/770	50ms/50ms
32	941/852	50ms/50ms
33	941/941	50ms/50ms
34	941/1209	50ms/50ms
35	941/1336	50ms/50ms
36	941/1477	50ms/50ms
37	941/1633	50ms/50ms
38	941/OFF	burst
40	1209/697	50ms/50ms
41	1209/770	50ms/50ms
42	1209/852	50ms/50ms
43	1209/941	50ms/50ms
44	1209/1209	50ms/50ms
45	1209/1336	50ms/50ms
46	1209/1477	50ms/50ms
47	1209/1633	50ms/50ms
48	1209/OFF	burst
50	1336/697	50ms/50ms
51	1336/770	50ms/50ms
52	1336/852	50ms/50ms
53	1336/941	50ms/50ms
54	1336/1209	50ms/50ms
55	1336/1336	50ms/50ms
56	1336/1477	50ms/50ms
57	1336/1633	50ms/50ms
58	1336/OFF	burst
60	1477/697	50ms/50ms
61	1477/770	50ms/50ms
62	1477/852	50ms/50ms
63	1477/941	50ms/50ms
64	1477/1209	50ms/50ms
65	1477/1336	50ms/50ms
66	1477/1477	50ms/50ms
67	1477/1633	50ms/50ms
68	1477/OFF	burst
70	1633/697	50ms/50ms
71	1633/770	50ms/50ms
72	1633/852	50ms/50ms
73	1633/941	50ms/50ms
74	1633/1209	50ms/50ms
75	1633/1336	50ms/50ms
76	1633/1477	50ms/50ms
77	1633/1633	50ms/50ms
78	1633/OFF	burst
80	OFF/697	50ms/50ms
81	OFF/770	50ms/50ms
82	OFF/852	50ms/50ms
83	OFF/941	50ms/50ms

84	OFF/1209	50ms/50ms
85	OFF/1336	50ms/50ms
86	OFF/1477	50ms/50ms
87	OFF/1633	50ms/50ms
88	No ring	No ring

Conditions:

- Station users may listen to all tones by dialing the two-digit codes one after another. The tone that is sounding when the SPEED button is pressed will be saved as that station's tone ringing selection.
- A station's tone ringing selection will be maintained in a battery protected area of memory. Therefore if a system experiences a power failure, or a soft or hard restart, a station's tone ringing selection will be restored.
- The tone selected will be used to provide "TONE" ringing normal or muted to the station whenever the station is commanded to tone ring. (i.e. this does not apply to camp-on tone programming confirmation tone or other specific tones that are not considered "TONE" ringing.)
- The selected tone will be used to notify the station in the following cases:  
Incoming CO Call  
incoming Intercom Call  
Transferred CO Line
- Recalling CO Line  
Call Back Notification  
Message Wait Call Back  
All types of forwarded calls  
Executive/Secretary calls  
Line Queue Call Back  
LCR Queue Call Back

### 320.12 EXECUTIVE OVERRIDE

Allows stations designated as "Executive" the ability to override and "barge in" on other keysets engaged in conversation.

If you call a busy station:

- a. Press pre-programmed\* EXECUTIVE OVERRIDE button. Executive station will be bridged onto the CO conversation in progress at the called station. Optional warning tone is heard and presented to all parties prior to cut-thru.
- b. Replace handset at Executive station to terminate the override.

\*Refer to Sec. 300.37, Flexible Button Assignment.

#### CAUTION

**USE OF THIS FEATURE WHEN THE EXECUTIVE OVERRIDE WARNING TONE IS DISABLED MAY BE INTERPRETED AS A VIOLATION OF FEDERAL OR STATE LAWS, AND AN INVASION OF PRIVACY.. CONSULT COUNSEL WITH RESPECT TO APPLICABLE LAWS BEFORE INTRUDING ON CALLS USING THIS FEATURE.**

#### NOTE

*A change in volume may occur on the CO line or intercom call after the barge-in occurs.*

### 320.13 HANDSET RECEIVER GAIN

This feature provides the Attendant station with a flexible button that can be programmed on their keyset. When programmed, allows the user to increase/decrease the handset receiver gain while on a CO call or intercom call.

While on a CO call:

- a. Press pre-programmed\* Handset Receiver Gain flex button to enter the volume adjustment mode.
- b. Dial a one-digit entry [0] through [9] (0=lowest, 9=highest) on the dial pad,  
or  
Press the [#] to increase or [\*] to decrease one level at a time.
- c. Two volume settings are stored in the system. One level for CO calls, another level for intercom calls. The LCD will display the settings as they occur, if the flex button was programmed using the code [638]+[0].
- d. Press pre-programmed\* Handset Receiver Gain flex button again to exit the volume adjustment mode.

#### NOTE

*When the above procedure is used, your transmit path is momentarily interrupted when the dial pad button is depressed.*

- A flex button can be programmed to decrease the Handset Receiver Gain using the code [638]+[\*].
- Another flex button can be programmed to increase the Handset Receiver Gain using the code [638]+[#].
- A flex button can also be programmed to have a certain volume setting using the code [638]+[0 thru 9].

\*A Flex button must be programmed for this feature to operate. Refer to Sec. 300.37, Flexible Button Assignment.

### 320.14 ICLID UNANSWERED CALL MANAGEMENT TABLE

*This feature available with optional software.*

An Unanswered Call Management Table with 100 entry capacity for the Starplus SPD 4896 system is maintained in the system. The calling number/name information pertaining to any unanswered call will be

**ATTENDANT FEATURE OPERATION**

placed in this table at the time the system has determined that the call has been abandoned.

This table may be interrogated from any station user so that the unanswered calls may be reviewed and handled by the end user. Upon entry into the review process, the functions available to a phone are:

Function	Function Button
1. Go to beginning of table	Dial Code 635
2. Review next item in this table entry	MUTE
3. Step to next table entry.	HOLD
4. Delete this table entry.	FLASH <sup>1</sup>
<del>5. Exit table review function.</del>	<del>ON/OFF</del>
6. Step to previous table entry.	TRANS
7. Call Back	SPEED
<sup>1</sup> Only the 1st Attendant station can delete an entry from this table.	

To interrogate the ICLID Unanswered Call Management Table from any station in the system:

- Dial the access code [635] on the dial pad.
- When the desired table entry is displayed on the LCD, press the SPEED button to automatically dial the table entry.

To review the next item in this entry:

- Press the MUTE button to toggle to the next item.
- Press the ON/OFF button to exit the review function.

To review the next table entry:

- Press the HOLD button.

To review the previous table entry:

- Press the TRANS button.

The 1st Attendant is the only station that can delete an individual table entry.

At the first Attendant:

- Dial the access code [635] on the dial pad.
- When the desired table entry is displayed on the LCD, press the FLASH button to delete this entry.

To review the next table entry:

- Press the HOLD button,

To review the previous table entry:

- Press the TRANS button.

**320.15 INTERCOM CALLING**

Placing an Intercom Call

- Press station key of party to be called (if programmed at your phone); or dial station number (100 to 195).
- You will hear tinging if called station is in the "T" answering mode; or two bursts of tone if called station is in the "H" or "P" position.
- Lift handset or use speaker-phone, when tone bursts stop.
- Hang up to end call.

Answering an Intercom Call

With your intercom signal switch in the "T" mode, you will hear repeated bursts of intercom tone ringing and the HOLD button will slow flash.

- Lift handset or press ON/OFF button to answer.
- Hang up to end call.

In the "P" mode, you will hear two bursts of tone and one-way announcement. The HOLD button will slow flash and the calling party cannot hear conversations in progress.

in the "H" mode, you will hear two bursts of tone and an announcement. Reply handsfree or lift handset for privacy.

**320.16 INCOMING CO LINES OFF-NET (via speed dial)**

Allows the first attendant station to forward incoming CO calls to an off-net location.

In a speed dial bin, store the number of the off-net location where calls are to be forwarded. Follow instructions provided for storing station or system speed dial numbers.

- Dial [603] on the dial pad,  
or  
Press pre-programmed\* CO Off-Net Forward button.
- Dial the CO group access code of the group to be forwarded,  
or  
Press the CO Line button for an individual CO Line for Off-Net forward.
  - [81] = CO Group 1
  - [82] = CO Group 2
  - [83] = CO Group 3
  - [84] = CO Group 4
  - [85] = CO Group 5
  - [86] = CO Group 6
  - [87] = CO Group 7
  - [88] = All CO Line

- c. Dial the speed bin number that contains the number where calls are to be forwarded. Confirmation tone is heard.

\*Refer to Sec. 300.37, Flexible Button Assignment.

Canceling Off-Net Forwarding

- a. Dial [603] on the dial pad,  
or  
Press pre-programmed\* CO Off-Net Forward button.
- b. Dial the CO group access code,  
or  
Press the CO line button.
- c. Dial [#] on the dial pad. Confirmation tone is heard.

320.17 **KEYSET SELF TEST**

The Starplus Digital Key System contains a test mode feature that supports the off line testing of Digital keysets and DSS units. The term off line means that the unit under test is disconnected from the switch during the test operation. Keysets not under test continue to operate in the normal manner. Tests are provided to verify the keyset and DSS LED, LCD, and keyboard button operations.

- a. The test mode is entered by taking a keyset's handset off hook.
- b. Press the SPEED button and dial [7#] on the dial pad. This keystroke sequence disconnects the keyset from the system and brings up the Test Mode Menu on the keyset's LCD. The test mode is exited by putting the handset back on hook. This reconnects the keyset to the system.

**SELECT 1:LCDLED 2:KEYBTN  
3:DSSBTN**

Test Mode Menu: The menu allows the operator to select a test mode by pressing the mode number at the dial pad. The operator can always return to the main test menu by pressing [##].

**A. Keyset LCD/LED Test**

This test outputs a series of continuously repeated LCD string messages to LCD lines 1 and 2. The set of strings consists of the letters 'A' through 'X' and 'a' through 'x'. The next set of strings are:

: **"PICKUP TRUCK SPEED ZONE!"**  
**\*\*\* STANDING BACK \*\*\*"**

- The strings are alternately displayed on lines 1 and 2 of the LCD display.
- In addition, all the LEDs are flashed at the rate of 15 IPM.

**B. Keyset Button Test**

- a. Pressing a keyset button turns on the LED and displays an LCD message identifying the key number.

**PRESS KEYS      BUTTONS**  
**\*\*\*\*\*                      \*\*\*\*\***

In addition switching the HTP switch from one position to another will cause the letter "H\_POS", "T\_POS", or "P\_POS" to be displayed.

- b. Pressing dial pad keys displays an LCD message that indicates which digit was pressed.
- c. LEDs can be tested independently of the KEYS by pressing the flex LED number at the dial pad. For example, LED 10 is turned on by pressing dial pad digits "1" "0". As each set of new numbers is entered the previously lit LED is turned off and the new LED is turned on. Invalid flex values (ex. 00,99) turn off currently lit LED.

**C. DSS LED/Button Test**

When the DSS test is selected and a DSS test is invoked ALL DSSs associated with the keyset running the test are placed in test mode.

**PRESS DSS BUTTONS**  
**\*\*\*\*\*                      \*\*\*\*\***

If no DSS unit is associated with the keyset, the keyset display will indicate "NO DSS". The DSS LED test will cause all the LEDs to flash at a 15 IPM rate. Once started the DSS LED test will continue until a DSS flex button is depressed. Pressing a DSS flex button turns on the flex key LED and displays an LCD message on the associated keyset identifying the flex key number (01 to 48). In addition, it turns off the previously selected flex LED.

Conditions

- Test mode interrupts the normal operation of a keyset or DSS.

320.18 **MESSAGES - CUSTOM**

This feature allows the system administrator to enter up to ten custom messages for use by station users of the system. These messages may be specified and customized by the customer on a system wide basis.

A station wishing to select a message:

- a. Dial the Message Code [633] on the dial pad,  
or  
press the pre-programmed Message Access flexible button.
- b. Enter the two-digit Custom Message bin number and hang up.

**ATTENDANT FEATURE OPERATION**

Example: [633]+[21-30] means that a telephone calling the station will receive the custom message programmed at the attendant station by the system administrator.

\*Refer to Sec. 300.37, Flexible Button Assignment.

To cancel the message:

- a. Dials the Message Access Code [633] + [00] and hang up.

The system administrator (Station 100) programs the ten custom messages at the first attendant station as follows:

- a. Dial the Custom Message program code [694] on the dial pad.

The following message is shown on the display phone:

**ENTER MSG NO**  
**MM/DD/YY**                      **HH:MM am**

- b. Enter the two-digit message bin number [21-30].

Then the following display will be shown after the bin # has been selected.

**mmmmmmmmmm...**  
**ENTER MSG:**

- c. Enter the custom message using the dial pad keys to enter the letters as follows:

A =21	M =61	1 =1#	" =01
B =22	N =62	2 =2#	, =02
C =23	O =63	3 =3#	? =03
D =31	P =71	4 =4#	/ =04
E =32	Q =74	5 =5#	! =*1
F =33	R =72	6 =6#	\$ =*2
G =41	s =73	7 =7#	& =*4
H =42	T =81	8 =8#	. =*#
I =43	U =82	9 =9#	( =#1
J =51	V =83	0 =0#	) =#2
K =52	W =91	Space =11	+ =#3
L =53	X =92	: =12	= =#4
	Y =93	- =13	# =##
	Z =94	' =14	

Up to 24-characters may be entered as the custom message (this will represent 48 digits entered). The actual Alpha-Numeric characters will be displayed as the digits are being entered while programming the messages. The attendant must go idle after programming a message before another message may be programmed.

- d. The user then presses the HOLD button to enter the message and confirmation tone will be heard.

Conditions:

- The telephone receiving the message must be a display telephone.
- Both key telephones and SLT can leave the message. SLT's are notified that they have left a message with a warning tone when going off-hook.
- incoming and outgoing calls are not inhibited in any way with a message displayed.
- When a message is displayed by a key telephone, the DND button LED flashes at the 15 ipm rate.
- When DND is invoked on the telephone, the message is canceled.
- Message Access (with a desired message) may be assigned to a flex button.
- Message status is stored in battery protected area of memory for retention across a power failure or system reset (soft or hard).
- The function of Message Access is assigned to a station flexible button in database admin.
- A station user may store any of the available messages under a flexible button assigned as a Message Access button.
- The ten Custom Messages will be displayed in a similar fashion as the "Canned" messages. The idle station display will show the message that has been activated at the station and a calling station will receive the STA XXX or name-in-display followed by the programmed custom messages.

**320.19 DIRECTORY DIALING - Attendant**

Directory dialing allows station users to obtain a directory of station users and have the system dial the extension that is currently on the display. The Starplus SPD 4896 system provides locations for up to 200 names.

Directory dialing also allows users to program a "name" along with a speed dial bin for use in later locating a speed dial number. When prompted to do so, the system will display the name associated with a speed dial number on the LCD display so that when the desired name is shown, the user may then have the system dial the number.

Directory dialing also allows users to associate a "name" with an entry in the local number/name trans-

lation table. When prompted to do so, the system will display the name associated with the table on the LCD display so that when the desired name is shown, the user may then have the system dial the number. The Starplus SPD 4896 system provides locations for up to 200 names.

The Directory Dialing list may be programmed and maintained at the first assigned attendant station in one of two ways, however this admin routine provides a means for the directory list to be maintained by the system programmer either locally (at Station 100) or remotely via modem access.

Directory dialing may also be used to transfer a call from one station to another.

To view the directory list:

- a. Dial the Directory List dial code [680] on the dial pad,  
or  
press the pre-programmed\* flex button programmed as a directory dialing button.
- b. Press a button on the key pad, once, twice or three times, to represent the letter of the alphabet, to begin viewing the list of names. (i.e. the first depression of the digit 2 produces the names beginning with an "A". The second depression of the digit 2 produces the names beginning with a "B", while the third depression of the digit 2 produces the names beginning with a "C".) The letters of the alphabet are represented on the key pad as follows:

ALPHA NUMERIC CHARACTER	DIGIT
A,B,C	2
D,E,F	3
G,H,I	4
J,K,L	5
M,N,O	6
P,Q*,R,S	7
T,U,V	8
W,X,Y,Z*	9
"does not appear on dial pad."	

- c. Names beginning with the letter chosen will appear on the LCD display.

**NOTE** *If there are no names in the Directory List beginning with the desired letter, a name with the next higher letter will be shown ON the LCD display.*

- d. Dial an [\*] on the dial pad to scroll up (next entry) through the list,  
or  
Dial a [#] on the dial pad to scroll down (previous entry) through the list,  
or

Press another key to view the list for a different letter of the alphabet.

- e. When the desired **name** is shown in the LCD display, pressing the SPEED button will automatically dial the destination station or outside phone number (via speed dial).

Conditions :

- If the desired party is an intercom station, that station will be signaled according to that station's intercom selector switch (SLT stations will **tone** ring).
- If the desired party is associated to a speed dial bin, the system will select a CO line and dial the number programmed into the speed dial bin. Call progress tones will then be heard.

To Transfer a Call using Directory Dialing:

While on a call:

- a. Press the TRANS button.
- b. Dial the Directory Dial Code [680] on the dial pad,  
or  
press a pre-programmed\* flex button programmed for directory dialing.
- c. Press the SPEED button to automatically dial the destination station.
- d. Hang up to complete the transfer.

**NOTE**

*Calls may only be transferred to internal stations only. An attempt to transfer a call off-net (via a Speed dial bin) will result in the call recalling upon going on-hook*

**A. Programming - Attendant**

Directory dialing allows station users to obtain a directory of station users and have the system dial the extension that is currently on the display. The Starplus SPD 4896 system provides locations for up to 200 names.

Directory dialing also allows users to program a "name" along with a speed dial bin for use in later locating a speed dial number. When prompted to do so, the system will display the name associated with a speed dial number on the LCD display so that when the desired name is shown, the user may then have the system dial the number.

Directory dialing also allows users to associate a "name" with an entry in the local number/name translation table. When prompted to do so, the system will display the name associated with the table on the LCD display so that when the desired name is shown, the user may then have the system dial the number. The Starplus SPD 4896 system provides locations for up to 200 names.



F =33	R =72	6 =6#	\$ =*2
G =41	s =73	7 =7#	& =*4
H =42	T =81	8 =8#	* =*#
I =43	U =82	9 =9#	( =#1
J =51	V =83	0 =0#	) =#2
K =52	w =91	Space =11	+ =#3
L =53	x =92	: =12	= =#4
	Y =93	- =13	# =##
	Z =94	' =14	

3. Press the SPEED button when finished. Confirmation tone will be heard.

**NOTE** *The Local Number/Name Translation Table can be used to enter additional speed dial numbers which can be used for directory dial or dial by name. The name entered into the local number/name translation table is not relevant when used with directory dialing and dial by name. In addition, it should be noted that the numbers entered into this table are limited to 14 digits and will be covered by toll restriction rules.*

**Method Three:**

This method may be used to enter names that will be associated to a system speed dial bin only.

To enter a name along with a system speed dial number:

1. Press the SPEED button once.
2. Press a desired outside line key; or Press the SPEED button a second time to have an outside line selected automatically.
3. Dial the system speed dial bin location (20 to 99).
4. Dial the telephone number (including special characters TRANS, HOLD and FLASH).
5. Press the SPEED button to store the telephone number,

To enter a name:

1. Press the MUTE button.
2. Enter the name (up to 24 characters may be entered) by using keys on the dial pad as follows:

A =21	M =61	1 =1#	" =01
B =22	N =62	2 =2#	, =02
C =23	0 =63	3 =3#	? =03
D =31	P =71	4 =4#	/ =04
E =32	Q =74	5 =5#	! =*1
F =33	R =72	6 =6#	\$ =*2
G =41	s =73	7 =7#	& =*4
H =42	T =81	8 =8#	* =*#
I =43	U =82	9 =9#	( =#1
J =51	V =83	0 =0#	) =#2

K =52	W =91	Space =11	+ =#3
L =53	X =92	: =12	= =#4
	Y =93	- =13	# =##
	Z =94	' =14	

3. Press the SPEED button when finished. Confirmation tone will be heard and the display will update.
4. Either hang up to end programming or begin at step "2" to program another System Speed Dial bin/Name combination.

**320.20 NIGHT SERVICE**

- a. Any designated attendant can place the system into Night Service by pressing the pre-programmed Night Service button (DND).
- b. Pressing the pre-programmed Night Service button again removes the system from Night Service.

**320.21 OFF HOOK VOICE OVER (OHVO)**

This feature allows users, off-hook on a call (CO or Intercom), to receive a voice announcement through the handset receiver without interrupting the existing call. The Voice Over is muted so as not to "override" or "drown" out the existing conversation. The overridden party may then respond to the calling party using CAMP-ON procedures to talk to the calling party or may use Silent Text Messaging to respond to the calling party via LCD Displays.

Placing an Off-Hook Voice Over (OHVO) call:

- a. When an OHVO station calls a busy OHVO station, and busy tone is received, the calling OHVO station can dial the OHVO code [628] on the dial pad, or press a pre-programmed\* OHVO button to initiate an OHVO announcement. The HOLD button LED will flash at the called OHVO station.
- b. The OHVO receiving station will receive a one-beep warning tone. The station receiving the OHVO call must be off-hook and in the "H" mode, and then the calling OHVO party may begin the voice announcement to the called OHVO party. The called OHVO station's existing conversation will not be interrupted and the voice over announcement will not "drown" out the existing conversation. The calling OHVO station will not be connected to or otherwise be able to hear the called station's conversation (the connection will only allow the calling station to transmit to the called station).



## ATTENDANT FEATURE OPERATION

**NOTE**

*The calling station is placed in a one-time DND mode upon initiating the Voice Over. One-Time DND cannot be toggled during the OHVO call. The station receiving the OHVO call must be off-hook and in the "H" mode.*

Responding to an Off-Hook Voice Over (OHVO):

After receiving an OHVO announcement, two options are available to respond to the calling party;

1. The called OHVO station may respond to the calling OHVO station by using the Camp-On feature. The called OHVO station presses the flashing HOLD button to consult with the calling station. The existing call (CO line) goes on Exclusive Hold automatically. This method, then follows Camp-On procedures and operation.
2. The called station may respond to the calling station by using the Silent Text Messaging (this feature is only available to digital key terminals, and the called station must be a digital display terminal.) The called OHVO station may press pre-programmed Message button to respond to the voice over announcement without being released from the current call, (i.e. by pressing a flex button pre-programmed for the message "IN MEETING"), the calling station will receive this message on the calling station's LCD display.

**NOTE**

*If the call is an intercom call, the intercom call will be dropped and an intercom call will be established between the calling and called stations*

## Conditions

- The station receiving the OHVO call MUST be off-hook and in the "H" mode.
- The receiving station must have OHVO enabled.
- When the dialed station responds via Camp-On all conditions and options available to Camp-On apply (refer to the feature description for Camp-On).
- OHVO may be used to notify the called party of a transferred call (CO Line or Intercom) by announcing the call, then releasing to complete the transfer. When this occurs, the receiving station does not need to respond to the OHVO.
- When a call is transferred via OHVO, the receiving station will receive muted ringing after the transfer is complete.
- Any messages including "CANNED", "CUSTOM", or "SILENT RESPONSE" text messaging may be used to respond to an OHVO call. The message will appear on

the calling station and called station LCD displays.

- If the calling station is a non-LCD terminal, the called station will receive error tone when responding via text messaging.
- The called station may press a flex button programmed as a Text Message button, [633+XX]. This flex button can be pressed and two-digit message number dialed to respond to the calling station. DTMF digits will not be heard by either party.
- The receiving station must be programmed to allow OHVO calls.
- When silent messaging is used to respond to an OHVO call, the existing call on the called station will not be disconnected, while the messages are being sent to the calling station.
- The calling station of an OHVO call must remain off-hook to receive silent messages. The calling station's voice transmit will remain connected to the called station and may respond verbally to the text messages. The OHVO call ends when the calling station goes on-hook.
- If the receiving station is on-hook in speakerphone mode and a calling party initiates OHVO, the receiving station will receive a Camp-On warning tone and normal Camp-On procedures are followed.
- The called station may send (multiple messages) and even after sending a message, may press the Camp-On button to talk to the calling station. Each time a message is sent, the splash tone will be heard and both displays will be updated.
- LEDs will follow Camp-On LED lamping sequences.

Each station can be programmed to allow receiving OHVO calls as part of Station Programming. Each station may be programmed for OHVO in one of two ways, as follows:

- OHVO disallowed (may not receive OHVO calls).
- May receive OHVO calls.

320.22 **SETTING SYSTEM TIME AND DATE**

Must be set by the first programmed attendant.

- a. Dial [692] on the dial pad. Confirmation tone is heard.
- b. Enter date and time as follows:  
YYMMDDHHMM  
– [W] = year (00-99)

- [MM] = month (01-12)
- [DD] = day (01-31)
- [HH] = hour (00-23)
- [MM] = minute (00-59)

When the correct number of digits are entered, confirmation tone will be heard and the display will update.

### 320.23 STORING SYSTEM SPEED NUMBERS

System Speed numbers must be entered by the first programmed attendant. If no attendant is specified, enter at Station 100.

- a. Press SPEED once, then press a desired outside line key or select an outside line automatically by pressing the SPEED button a second time.
- b. Dial the System speed bin location (20 to 99).
- c. Dial telephone number.
- d. Press the SPEED button.
- e. Hang up.
  - Pressing the TRANS button during number entry initiates a Pulse-To-Tone switchover. Pressing the HOLD button during number entry inserts a Pause. Pressing the FLASH key inserts a Flash into the speed number.
  - Pressing the TRANS button as the first entry in the speed bin inserts a no-display character causing the numbers stored in the bin not to appear on the Digital Terminals display when the bin is accessed.

Speed Bin numbers 60-99 are NOT monitored by Toll Restriction.

### 320.24 TEXT MESSAGING (Silent Response)

This a feature allows a station user to use text messages to respond to a caller that has either Camped-On or has used the Off-Hook Voice Over feature to alert a busy station user of a waiting call or message. The "camped-on" station may respond to the caller via the canned, custom, and silent response text (LCD) messages. The text messages appear on the calling party LCD Display.

While receiving a Camp-On, or OHVO call:

- a. The called party may press a flexible button programmed for message access, then dial the two digit message code (or press a pre-programmed flex button for a particular message). Example : [633] + [38] means that a telephone calling the station will receive the message "WHO IS IT?".

The additional messages (with their codes) listed below can also be sent as a text response:

- [31] = I WILL TAKE CALL
- [32] = TAKE MESSAGE

- [33] =TRANSFER TO SECRETARY
- [34] = PUT CALL ON HOLD
- [35] = CALL BACK
- [36] = ONE MOMENT PLEASE
- [37] = I WILL CALL BACK
- [38] = WHO IS IT?
- [39] = IS IT LONG DISTANCE?
- [40] = IS IT PERSONAL?
- [41] = IS IT AN EMERGENCY?
- [42] = IS IT IMPORTANT?
- [43] = IS IT URGENT?
- [44] = SEND CALL TO VOICE MAIL
- [45] = PARK CALL
- [46] = OUT OF OFFICE
- [47] = PUT CALL THROUGH
- [48] = I AM BUSY
- [49] = O.K.
- [50] = NO
- [51] = YES

Conditions:

- If the station receiving the text message response was doing a camp-on he will first receive a short burst of tone on the speaker, then the display will show the message that has been activated by the called station.
- If the station receiving the text message response is on an OHVO call, no tone will be received.
- All canned and custom messages may be used to respond to a calling party.
- Text response messages will automatically clear when the calling station (station receiving the messages) goes on-hook.
- A station can receive only one message at a time.
- Text messages may be chained (i.e. multiple messages sent to one caller).
- Text message responses may only be activated by key stations and the receiving station must be a Digital Display telephone.
- The text message responses will appear on both the calling station and the called station (station activating) text responses) LCD displays.
- If the calling station is a non-LCD terminal, the called station will receive error tone when responding via text messaging.
- The called station may press a flex button programmed as a Text Message button, [633+XX]. This flex button can be pressed and two-digit message number dialed to

**ATTENDANT FEATURE OPERATION**

respond to the calling station. DTMF digits will not be heard by either party.

- When silent messaging is used to respond to a call, the existing call of the called station will not be disconnected while the messages are being sent to the calling station.
- The calling station must remain off-hook to receive silent messages.
- If the called station responds with a text message, the text message will appear on the LCD.
- LEDs will follow that of the CAMP-ON or OHVO.
- Each individual message may be programmed onto a flexible button including a flex button on a DSS/BLF console.

**NOTE**

*The calling station must be a digital display telephone and the called station must be a keyset.*

**ATTENDANT with DSS/DLS FEATURES**

The attendant console may be programmed in one of five different ways. Therefore, you may not have all of the features listed below on your console. Refer to Sec. 220.14 for a description of each map.

**320.25 ATTENDANT TRANSFER SEARCH**

When attempting to locate a party:

- a. Press a station button to signal that station. If the party is not located, press another station button to continue the search.

**320.26 PLACING AN OUTSIDE CALL (Automatic Line Selection)**

- a. Press outside line button. ON/OFF button LED will light and dial tone will be heard.
- b. Dial desired party.
- c. When called party answers, lift handset to converse or use speakerphone

**320.27 CALL PARK**

While connected to an outside line:

- a. Press programmed CALL PARK button. The caller is put on Exclusive hold.
- b. At this time, you can page or call another internal station.
- c. When the party you called responds, announce the call park location and replace handset.

**320.28 DO NOT DISTURB INDICATION**

The associated station button will flash at a medium rate to indicate that station is in Do Not Disturb.

**320.29 RETRIEVING A PARKED CALL**

- a. Lift handset or press ON/OFF button.
- b. Dial [#] on the dial pad.
- c. Dial the parking location (430 to 437) where the call was parked.

**320.30 CALL TRANSFER**

Outside lines can be transferred from one phone to another within the system. The transfer can be either screened (announced) or unscreened to either an idle or busy station.

Screened Transfer:

While connected to an outside line:

- a. Press station button where call is to be transferred (if programmed on your telephone), or press TRANS button and dial station number (100 to 195).
- b. The called extension signals according to the intercom signal switch position.
- c. When that extension answers, announce the transfer.
- d. Hang up to complete transfer.

Unscreened Transfer:

When the called extension begins to signal, hang up to transfer the call (Recall timer starts).

Transfer Search:

When attempting to locate a party:

- a. Press a station key to signal a station.
- b. If the party is not located, press another station key to continue the search.

If the party is not located:

- c. Press another station button to continue the search.
- d. When the called party answers, hang up to complete the transfer.

**320.31 CAMP-ON**

While connected to an outside line:

- a. Press desired station button.
- b. When busy tone is heard, press CAMP-ON button. Wait for response.
- c. Replace handset, access another CO Line or press RELEASE button (if you have one).

## 320.32 FLEXIBLE BUTTON PROGRAMMING

- a. Press SPEED button twice.
- b. Press FLEX button to be programmed (it must be programmed in database as a flexible button).
- c. Dial desired code (Refer to Table 300-2 Flex Button Programming Codes).

## 320.33 MEET ME PAGE

To request another party meet you on a page:

- a. Dial the desired two-digit paging code or press pre-programmed\* flex button.
- b. Request that party meet you on the page.
- c. Do not hang up; wait for the requested party to answer.

Answering a Meet Me Page

- a. Go to the nearest telephone and dial [77] on the dial pad.
- b. You will be connected to the party that paged you.

\*Refer to Sec. 300.37, Flexible Button Assignment.

## 320.34 PAGING

## A. External Paging

1. Dial the two-or three-digit External paging code. Wait for page warning tone.
  - [76]+[0] = External Ail Call (Zones 1-7)
  - [76]+[1] = External Zone 1
  - [76]+[2] = External Zone 2
  - [76]+[3] = External Zone 3
  - [76]+[4] = External Zone 4
  - [76]+[5] = External Zone 5
  - [76]+[6] = External Zone 6
  - [76]+[7] = External Zone 7
2. Speak in normal tone of voice to deliver message.

Stations off-hook or in DND will not hear the internal page announcement.

**NOTE**

*When making a zone page or All Call page and the zone is busy, the page initiator will receive ringback tone until the zone becomes available. You will then hear a warning tone and can make the page announcement.*

3. Deliver page in normal tone of voice.
4. Replace handset to terminate page announcement.

## B. Internal Paging

Stations off-hook or in DND will not receive the page announcement.

1. Press the pre-programmed\* PAGE button, or dial one of the following codes:
  - [70] = Ail Call • internal & External
  - [71] = internal Zone 1
  - [72] = internal Zone 2
  - [73] = internal Zone 3
  - [74] = internal Zone 4
  - [75] = internal All Call
2. Speak in normal tone of voice to deliver message.
3. Replace handset to terminate page announcement.

## C. All Call Paging (Internal/External)

1. Dial [70] on the dial pad, or press the pre-programmed\* PAGE button.
2. Speak in normal tone of voice to deliver message.
3. Replace handset to terminate page announcement.

\*Refer to Sec. 300.37, Flexible Button Assignment.

## 320.35 RELEASE BUTTON

The 34-button Attendant Digital Terminal contain a Release button that may be pressed to disconnect or terminate an intercom call, transfer sequence, page announcement or CO call.

**330.1 LCD DISPLAYS**

The display is arranged into an upper and lower field. The upper field displays the current activity of the telephone. The lower field is divided into two sections. The left section of the lower field displays the date, speed bin number, connected intercom station

or outside line number. The right section of the lower field displays the current time or elapsed time on an outside call. The following Table shows what will appear on the LCD displays based on the function performed..

**Table 330-I Liquid Crystal Displays (LCD)**

FUNCTION	CALLING STATION'S DISPLAY	CALLED STATION'S DISPLAY
Idle Station	<div style="border: 1px solid black; padding: 5px; text-align: center;"> <b>STATION XXX</b>  <b>MM/DD/YY      HH:MM am</b> </div>	
Manually Dialing Outgoing Calls	<div style="border: 1px solid black; padding: 5px; text-align: center;"> <b>18005551212</b>  <b>LINE XX      HH:MM :SS</b> </div>	
Recalling Line from Hold	<div style="border: 1px solid black; padding: 5px; text-align: center;"> <b>LINE XX RECALLING</b>  <b>MM/DD/YY      HH:MM am</b> </div>	
Recalling Line from Another Station	<div style="border: 1px solid black; padding: 5px; text-align: center;"> <b>RECALL FROM STA XXX</b>  <b>LINE XX      HH:MM:SS</b> </div>	
	<div style="border: 1px solid black; padding: 5px; text-align: center;"> <b>RECALL FROM ..(name)..</b>  <b>LINE XX      HH:MM:SS</b> </div>	
Connected to an Incoming CO Line		<div style="border: 1px solid black; padding: 5px; text-align: center;"> <b>STATION XXX</b>  <b>LINE XX      00:00:10</b> </div>
Intercom Call	<div style="border: 1px solid black; padding: 5px; text-align: center;"> <b>CALL TO STA XXX</b>  <b>MM/DD/YY      HH:MM am</b> </div>	<div style="border: 1px solid black; padding: 5px; text-align: center;"> <b>CALL FROM STA XXX</b>  <b>MM/DD/YY      HH:MM am</b> </div>
	<div style="border: 1px solid black; padding: 5px; text-align: center;"> <b>CALL TO ..(name)..</b>  <b>MM/DD/YY      HH:MM am</b> </div>	<div style="border: 1px solid black; padding: 5px; text-align: center;"> <b>CALL FROM ..(name)..</b>  <b>MM/DD/YY      HH:MM am</b> </div>

Table 330-I LCD Displays (Cont'd)

FUNCTION	CALLING STATION'S DISPLAY	CALLED STATION'S DISPLAY
Camp-on	<p style="text-align: center;"><b>CALL TO STA XXX</b> MM/DD/YY      HH:MM am</p>	<p style="text-align: center;"><b>CAMP-ON BY STA XXX</b> MM/DD/YY      HH:MM am</p>
	<p style="text-align: center;"><b>CALL TO ..(name)..</b> MM/DD/YY      HH:MM am</p>	<p style="text-align: center;"><b>CAMP-ON BY ..(name)..</b> MM/DD/YY      HH:MM am</p>
Conference	<p style="text-align: center;"><b>CONFERENCE</b> <del>MM/DD/YY</del>      HH:MM am</p>	<p style="text-align: center;"><b>CONFERENCE</b> MM/DD/YY      HH:MM am</p>
Internal Page	<p style="text-align: center;"><b>INTERNAL PAGE</b> ZONE X      HH:MM am</p>	<p style="text-align: center;"><b>PAGE FROM STA XXX</b> MM/DD/YY      HH:MM am</p>
		<p style="text-align: center;"><b>PAGE FROM ..(name)..</b> MM/DD/YY      HH:MM am</p>
External Zone Page and External All Call Page	<p style="text-align: center;"><b>EXTERNAL PAGE</b> ZONE X      HH:MM am</p>	
	<p style="text-align: center;"><b>EXTERNAL PAGE</b> MM/DD/YY      HH:MM am</p>	
All Call Page	<p style="text-align: center;"><b>ALL CALL PAGE</b> MM/DD/YY      HH:MM am</p>	<p style="text-align: center;"><b>PAGE FROM STA XXX</b> MM/DD/YY      HH:MM am</p>
Meet Me Page	<p style="text-align: center;"><b>ALL CALL PAGE</b> MM/DD/YY      HH:MM am</p>	<p style="text-align: center;"><b>PAGE FROM XXX</b> MM/DD/YY      HH:MM am</p>
	<p style="text-align: center;"><b>CALL FROM XXX</b> MM/DD/YY      HH:MM am</p>	<p style="text-align: center;"><b>CALL TO XXX</b> MM/DD/YY      HH:MM am</p>

Table 330-I LCD Displays (Cont'd)

FUNCTION	CALLING STATION'S DISPLAY	CALLED STATION'S DISPLAY
Station Call Forward (Originating Station) (Name in Display)	<b>FORWARDED TO STA XXX</b> <b>MM/DD/YY      HH:MM am</b>	
	<b>FORWARDED TO ..(name)..</b> <b>MM/DD/YY      HH:MM am</b>	
Station No-Answer Call Forward (Originating Station)	<b>NO ANS FWD TO STA XXX</b> <b>MM/DD/YY      HH:MM am</b>	
	<b>NO ANS FWD TO ..(name)..</b> <b>MM/DD/YY      HH:MM am</b>	
Station Busy/No-Answer Call Forward (Originating Station)	<b>BSY/NA FWD TO STA XXX</b> <b>MM/DD/YY      HH:MM am</b>	
	<b>BSY/NA FWD TO ..(name)..</b> <b>MM/DD/YY      HH:MM am</b>	
Station Busy Call Forward (Originating Station)	<b>BUSY FWD TO STA XXX</b> <b>MM/DD/YY      HH:MM am</b>	
	<b>BUSY FWD TO ..(name)..</b> <b>MM/DD/YY      H H : M M    a m</b>	
Forwarded Call (Name in Display)	<b>FORWARDED TO STA XXX</b> <b>VIA STA XXX      HH:MM am</b>	<b>CALL FROM STA XXX</b> <b>VIA STA XXX      HH:MM am</b>
	<b>FORWARDED TO ..(name)..</b> <b>VIA STA XXX      HH:MM am</b>	<b>CALL FROM ..(name)..</b> <b>VIA STA XXX      HH:MM am</b>

Table 330-I LCD Displays (Cont'd)

FUNCTION	CALLING STATION'S DISPLAY	CALLED STATION'S DISPLAY
Forwarded Intercom Call	<div style="border: 1px solid black; padding: 5px; text-align: center;"> <b>FORWARDED TO STA XXX</b>  <b>VIA STA XXX    HH:MM am</b> </div>	<div style="border: 1px solid black; padding: 5px; text-align: center;"> <b>CALL FROM STA XXX</b>  <b>VIA STA XXX    HH:MM am</b> </div>
Station Forwarding to a Voice Mail Group* (Station Idle)	<div style="border: 1px solid black; padding: 5px; text-align: center;"> <b>FORWARDED TO VOICE MAIL</b>  <b>MM/DD/YY        HH:MM am</b> </div>	
Station Forwarding to an ACD* or UCD Group (Station Idle)	<div style="border: 1px solid black; padding: 5px; text-align: center;"> <b>FORWARDED TO ACD 55X</b>  <b>MM/DD/YY        HH:MM am</b> </div>	
Preset Forward		<div style="border: 1px solid black; padding: 5px; text-align: center;"> <b>FORWARD RING</b>  <b>LINE XX         HH:MM am</b> </div>
Station calling a Station Forwarded to a Voice Mail' Group	<div style="border: 1px solid black; padding: 5px; text-align: center;"> <b>FORWARDED TO VOICE MAIL</b>  <b>VIA STA XXX    HH:MM am</b> </div>	<div style="border: 1px solid black; padding: 5px; text-align: center;"> <b>FORWARDED TO VOICE MAIL</b>  <b>MM/DD/YY        HH:MM am</b> </div>
Call Pickup	<div style="border: 1px solid black; padding: 5px; text-align: center;"> <b>CALL TO STA XXX PICKED UP</b>  <b>BY STA XXX    HH:MM am</b> </div>	<div style="border: 1px solid black; padding: 5px; text-align: center;"> <b>CALL TO STA XXX</b>  <b>FROM STA XXX HH:MM am</b> </div> <div style="border: 1px solid black; padding: 5px; text-align: center; margin-top: 10px;"> <b>TRANSFER FROM STA XXX</b>  <b>LINE XX         HH:MM am</b> </div>
Exclusive Hold	<div style="border: 1px solid black; padding: 5px; text-align: center;"> <b>LINE HOLDING</b>  <b>LINE XX         HH:MM am</b> </div>	

\*Features available with optional software.



Table 330-I LCD Displays (Cont'd)

FUNCTION	CALLING STATION'S DISPLAY	CALLED STATION'S DISPLAY
Do Not Disturb	<p><b>DO NOT DISTURB STA XXX</b>                      MM/DD/YY      HH:MM am</p>	<p><b>STA IN DO NOT DISTURB</b>                      MM/DD/YY      HH:MM am</p>
	<p><b>DO NOT DISTURB ..(name)..</b>                      MM/DD/YY      HH:MM am</p>	
Call Back	<p><b>CALL BACK FROM STA XXX</b>                      MM/DD/YY      HH:MM am</p>	<p><b>CALL FROM STA XXX</b>                      MM/DD/YY      HH:MM am</p>
	<p><b>CALL BACK FROM ..(name)..</b>                      MM/DD/YY      HH:MM am</p>	<p><b>CALL FROM ..(name)..</b>                      MM/DD/YY      HH:MM am</p>
Outside Line Transfer		<p><b>TRANSFER FROM STA XXX</b>                      LINE XX      HH:MM am</p>
		<p><b>TRANSFER FROM ..(name)..</b>                      LINE XX      HH:MM am</p>
Message Waiting		<p><b>MSG: XXX XXX XXX XXX XXX</b>                      MM/DD/YY      HH:MM am</p>
Reply to a Message Waiting	<p><b>CALL TO STA XXX</b>                      MM/DD/YY      HH:MM am</p>	<p><b>CALL BACK FROM STA XXX</b>                      MM/DD/YY      HH:MM am</p>
	<p><b>CALL TO ..(name)..</b>                      MM/DD/YY      HH:MM am</p>	

Table 330-I LCD Displays (Cont'd)

FUNCTION	CALLING STATION'S DISPLAY	CALLED STATION'S DISPLAY
Programmed Flash Command (F)	<div style="border: 1px solid black; padding: 5px; text-align: center;"> <b>F*12</b> </div>	
Programmed Pause Command (P)	<div style="border: 1px solid black; padding: 5px; text-align: center;"> <b>950777P1234567</b>  <b>SPEED XX</b> <span style="background-color: black; color: black;">XXXXXXXXXX</span> <b>MM am</b> </div>	
Programmed Pulse-To-Tone Switchover (S)	<div style="border: 1px solid black; padding: 5px; text-align: center;"> <b>950777S1234567</b>  <b>SPEED XX</b>      <b>HH:MM am</b> </div>	
CO Line Queuing	<div style="border: 1px solid black; padding: 5px; text-align: center;"> <b>PLACED IN QUEUE FOR</b>  <b>LINE XX</b>      <b>HH:MM am</b> </div>	
	<div style="border: 1px solid black; padding: 5px; text-align: center;"> <b>QUEUE CALL BACK</b>  <b>LINE XX</b>      <b>HH:MM am</b> </div>	
Hunt Groups	<div style="border: 1px solid black; padding: 5px; text-align: center;"> <b>CALL TO STA XXX</b>  <b>VIA HUNT</b>      <b>HH:MM am</b> </div>	
	<div style="border: 1px solid black; padding: 5px; text-align: center;"> <b>CALL TO ..(name)..</b>  <b>VIA HUNT</b>      <b>HH:MM am</b> </div>	
ACD* or UCD Groups	<div style="border: 1px solid black; padding: 5px; text-align: center;"> <b>CALL TO STA XXX</b>  <b>VIA ACD</b>      <b>HH:MM am</b> </div>	
	<div style="border: 1px solid black; padding: 5px; text-align: center;"> <b>CALL TO ..(name)..</b>  <b>VIA ACD</b>      <b>HH:MM am</b> </div>	

\*Features available with optional software.

Table 330-I LCD Displays (Cont'd)

FUNCTION	CALLING STATION'S DISPLAY	CALLED STATION'S DISPLAY
Ringing CO Lines		<div style="border: 1px solid black; padding: 5px; text-align: center;"> <b>LINE RINGING</b>  <b>LINE XX            HH:MM am</b> </div>
Display Security Feature	<div style="border: 1px solid black; padding: 5px; text-align: center;"> <b>DISPLAY SECURITY</b>  <b>LINE XX            HH:MM:SS</b> </div>	
Station Forwarding Off-Net	<div style="border: 1px solid black; padding: 5px; text-align: center;"> <b>FORWARDED TO SPEED XX</b>  <b>MM/DD/YY            HH:MM am</b> </div>	
Calling a Station Forwarded Off-Net (before and after call is answered)	<div style="border: 1px solid black; padding: 5px; text-align: center;"> <b>FORWARDED OFF NET</b>  <b>LINE XX            CALLED 102</b> </div> <div style="border: 1px solid black; padding: 5px; text-align: center; margin-top: 10px;">                 2331234  <b>LINE XX            HH:MM:SS</b> </div>	<div style="border: 1px solid black; padding: 5px; text-align: center;"> <b>FORWARDED TO SPEED XX</b>  <b>MM/DD/YY            HH:MM am</b> </div>
Calls in Queue (Supervisor)	<div style="border: 1px solid black; padding: 5px; text-align: center;"> <b>55X: CIQ: XX AL: XX OC: MMM</b>  <b>MM/DD/YY            HH:MM am</b> </div>	
Calls in Queue (using Dial Code) ACD* or UCD	<div style="border: 1px solid black; padding: 5px; text-align: center;"> <b>ACD 55X 02 CALLS IN QUEUE</b>  <b>MM/DD/YY            HH:MM am</b> </div>	
Unavailable Mode (Agent Station) ACD* or UCD	<div style="border: 1px solid black; padding: 5px; text-align: center;"> <b>UNAVAILABLE ACD * XXX *</b>  <b>MM/DD/YY            HH:MM am</b> </div>	
Station calling a Voice Mail* Group Pilot Number	<div style="border: 1px solid black; padding: 5px; text-align: center;"> <b>CALL TO VOICE MAIL</b>  <b>MM/DD/YY            HH:MM am</b> </div>	

\*Features available with optional software.

Table 330-I LCD Displays (Cont'd)

FUNCTION	CALLING STATION'S DISPLAY	CALLED STATION'S DISPLAY
Dial By Name	<div style="border: 1px solid black; padding: 5px;"> <p><b>DIAL NAME:</b> MM/DD/YY      HH:MM, pm</p> </div>	
Off-Hook Voice Over (OHVO)	<div style="border: 1px solid black; padding: 5px;"> <p><b>ANNOUNCE TO STA XXX</b> MM/DD/YY      HH:MM am</p> </div>	<div style="border: 1px solid black; padding: 5px;"> <p><b>ANNOUNCE FROM STA XXX</b> MM/DD/YY      HH:MM am</p> </div>
Executive Override	<div style="border: 1px solid black; padding: 5px;"> <p><b>MONITORING STA XXX</b> MM/DD/YY      HH:MM am</p> </div>	
Voice Mail* Transfer with ID Digits	<div style="border: 1px solid black; padding: 5px; margin-bottom: 5px;"> <p><b>CALL TO VOICE MAIL</b> VIA XXX      MM/DD/YY</p> </div> <div style="border: 1px solid black; padding: 5px;"> <p><b>ENTER VM ID:</b> MM/DD/YY      HH:MM am</p> </div>	

\*Features available with optional software.

## SECTION 400

### GENERAL DESCRIPTION

#### 400.1 SYSTEM TECHNOLOGY

The **Starplus** family of digital key telephone systems is comprised of four fully digital hybrid key telephone systems, the SPD 612, SPD 1428, SPD 2856, and SPD 4896. These systems are designed to meet the telecommunications needs of small to medium sized business offices. All systems incorporate state of the art digital technology for command processing and voice switching utilizing a Pulse Code Modulation/Time Division Multiplexing (**PCM/TDM**) voice control module. The family of **Starplus** Digital systems are also engineered to allow migration of the family of **Starplus** digital terminals and terminal accessories throughout the entire product line. In addition, standard **2500-type** telephone devices are supported by use of a 2x4 SLT Expansion Module on the **Starplus** SPD 612 and SPD 1428 systems, a 4x8 SLT Interface Board (CSB) on the **Starplus** SPD 2856 system, and a Single line Interface Board (SL12) on the SPD 4896 system, or SLA (OPX) adapters on all systems.

The SPD 612 is the smallest member of the **Starplus** Digital family and fully configured supports a maximum of six **CO/PBX/Centrex** lines and 12 digital terminal devices. The SPD 612 is a "flat pack", or single mother board system with plug-on modules expanding the system via expander modules configured with two **CO/PBX/Centrex** lines by four stations/single line telephones. A complete system capacity allows for use of up to 112 time slots for stations, CO Lines, and a DTMF Receiver. This extends non-blocking access to all system resources.

The SPD 612 Basic KSU comes fully configured with power supply, common control processor, **PCM/TDM** Voice switching matrix and interface circuits for four **CO/PBX/Centrex** lines and interface circuits for eight Digital terminal devices. The Basic system can be equipped with one DTMF receiver (on either the 2x4 Expander Module or 2x4 SLT Expander Module), a connector for one Music-On-Hold channel that also provides for background music.

The SPD 1428 is the second member of the **Starplus** Digital family and fully configured supports a maximum of 14 **CO/PBX/Centrex** lines and 28 digital station devices. The SPD 1428 is a "flat pack", or single mother board system with plug on modules expanding the system via expansion and expander modules configured with either two **CO/PBX/Centrex** lines by four stations or four **CO/PBX/Centrex** lines by eight stations. A complete system capacity

allows for use of up to 112 time slots for stations, CO Lines, DTMF Receivers, or data switching modules. This extends non-blocking access to all system resources.

The SPD 1428 Basic KSU comes fully configured with power supply, Common control processor, **PCM/TDM** Voice switching matrix and interface circuits for four **CO/PBX/Centrex** lines and interface circuits for eight Digital terminal stations. The Basic system is also equipped with one RS-232C I/O port, one DTMF receiver, a connector for one **Music-On-Hold** channel that also provides for background music, and an on-board 300 baud modem that provides access to the system for data base programming or remote maintenance and or diagnostics. Modules to provide additional I/O ports, and an optional 1200 baud modem module can also be added to the system.

The SPD 2856 system is the third system in a family of Digital Hybrid Key Telephone systems and supports a maximum configuration of 28 **CO/PBX/Centrex** lines and 56 digital station devices. The SPD 2856 is atypical KSU system with plug in PCB's. The system capacity is expanded by installing four circuit **CO/PBX/Centrex** lines by eight circuit station expansion PCB's. The complete system capacity allows for use of up to 112 time slots for stations, CO Lines, DTMF Receivers, or data switching Modules. This extends virtual non-blocking access to all system resources.

A Basic SPD 2856 KSU ships complete with an on-board power supply. The CPB which is the only common equipment required for operation provides the microprocessor for command processing and Voice **PCM/TDM** switching. The CPB is also equipped with one modular RS-232C I/O port, a connector for one Music On Hold channel that also provides for background music, and an on-board 300 baud modem that provides access to the system for data base programming or remote maintenance and or diagnostics. Modules to provide additional I/O ports, and an optional 1200 baud modem module can also be added to the CPB.

The SPD 4896 is the fourth and largest member of the **Starplus** family of Digital Systems and when fully configured supports a maximum of 48 **CO/PBX/Centrex** lines and 96 digital station devices. The SPD 4896 is card slot cabinet oriented with plug in modules (cards) expanding the system via station boards and CO boards. The boards are configured as 12 **CO/PBX/Centrex** lines, 12 digital stations, or 12

## GENERAL DESCRIPTION

single line stations. A complete system capacity allows for use of up to 144 ports for Stations, CO Lines, or Data switching Modules. This extends non-blocking access to all system resources. In its initial release the system is configured in a pre mapped arrangement, where peripheral boards are plugged into designated slots. In future releases, the peripheral boards will be universally assignable. The hardware architecture is built so that future expansion in both CO lines and Stations can be accomplished by upgrading software and adding plug in boards.

The system KSU is powered by modular power supplies that are mounted on the sides of the cabinet. The cabinet is divided so that one power supply will support a system configured with up to 48 CO lines and 60 stations (key or SLT). If the CO line or station requirements exceed the aforementioned configuration, the second power supply is needed. The second power supply will support the 48x96 configuration as well as possible future expansion requirements.

The digital systems are installed using industry standard blocks, jacks and skinny wire cabling. This combined with the ability to program the system using a key terminal (digital display terminal) reduces installation cost and maintenance requirements.

All CO interfaces are equipped with transformer barriers, for system classification as an FCC fully protected system. Each CO circuit supports rotary (out-pulse) dialing and loop supervision (disconnect detection) under software control. The DTMF tone signals and system supervisory tones can be generated in each **keyset** or on the main PCB. All **Starplus** Digital systems use a proprietary tone plan for providing internal progress tones with the exception of OPX stations which are provided with a "precise" tone plan.

The **Starplus** family of digital terminals include an Executive (display), Enhanced (non-display) Digital Terminals, and a Basic (non-display) Digital terminal. Optional station terminals include a Digital DSS Console, and a Single Line Adapter (Off-Premise Extension (OPX) adapter) which are all upward and downward compatible to the entire **Starplus** digital product line.

The system architecture allows system programming changes to be made without interrupting state event software control of normal communications. Call processing continues while the customer data base is updated. All programming changes to the customer data base programming are made either from a digital terminal (digital display terminal) connected to Port 01 or from a data terminal or PC connected (except in the SPD 612) to either a I/O port or remotely via the on-board modem.

The **Starplus** product line is tailored to meet immediate and long term customer needs. Most commonly used features are activated by direct button selection. However, **many functions** may be alternately accessed by dialing specific codes or as another option by assigning these dial codes to a flex button on a digital terminal. This permits flexible use of the **Starplus** Digital systems.

Future software enhancements and upgrades are easily retrofitted and installed in the systems. This will, in most cases provide backward compatibility with existing **Starplus** Digital hardware further reducing the cost to upgrade or add features to an installed system.

#### 400.2 COMMON EQUIPMENT FOR THE SPD 4986 SYSTEM

The following components are necessary to operate the **Starplus** Digital Key Telephone System. Refer to Appendix B for a complete **Starplus** Digital Key Telephone System component list with Part #'s.

- Equipment Cabinet w/Power Supply (KSU)
- Central Processor Unit (CPU)
- Voice Control Board (**VCB**)
- CO Line (Loop) Board (C012)
- Key Telephone Board (**KT12**)
- Single Line Board (SL12)

#### A. Equipment Cabinet With Power Supply (KSU)

The KSU is wall mounted. It is of metal construction with a backplane motherboard that has 23 card slots. The CPU card is inserted into the CPU slot. Slots 2, 3, and 4 are reserved for future common cards. The VCB card is inserted into the VCB slot. The remaining slots are designated Slots 1 thru 19 for peripheral cards. The system defaults to a configuration that designates peripheral slots 1, 2, 3 and 4 for Station boards, peripheral slots 5, 6, 7, and 8 for CO boards, and peripheral slots 9, 10, 11 and 12 for the remaining station boards. Refer to Figure 400-I Basic KSU Cabinet.

#### Grounding:

A No. 14 AWG copper wire should be used to connect a ground between the ground source and the KSU (25 feet maximum). Atwo-position terminal strip (J25) is located on the lower right corner of the backplane and is accessible through the right side of the KSU. One terminal position can be used to connect the ground wire from a ground source.

*See Teck TIPS about Grounds*

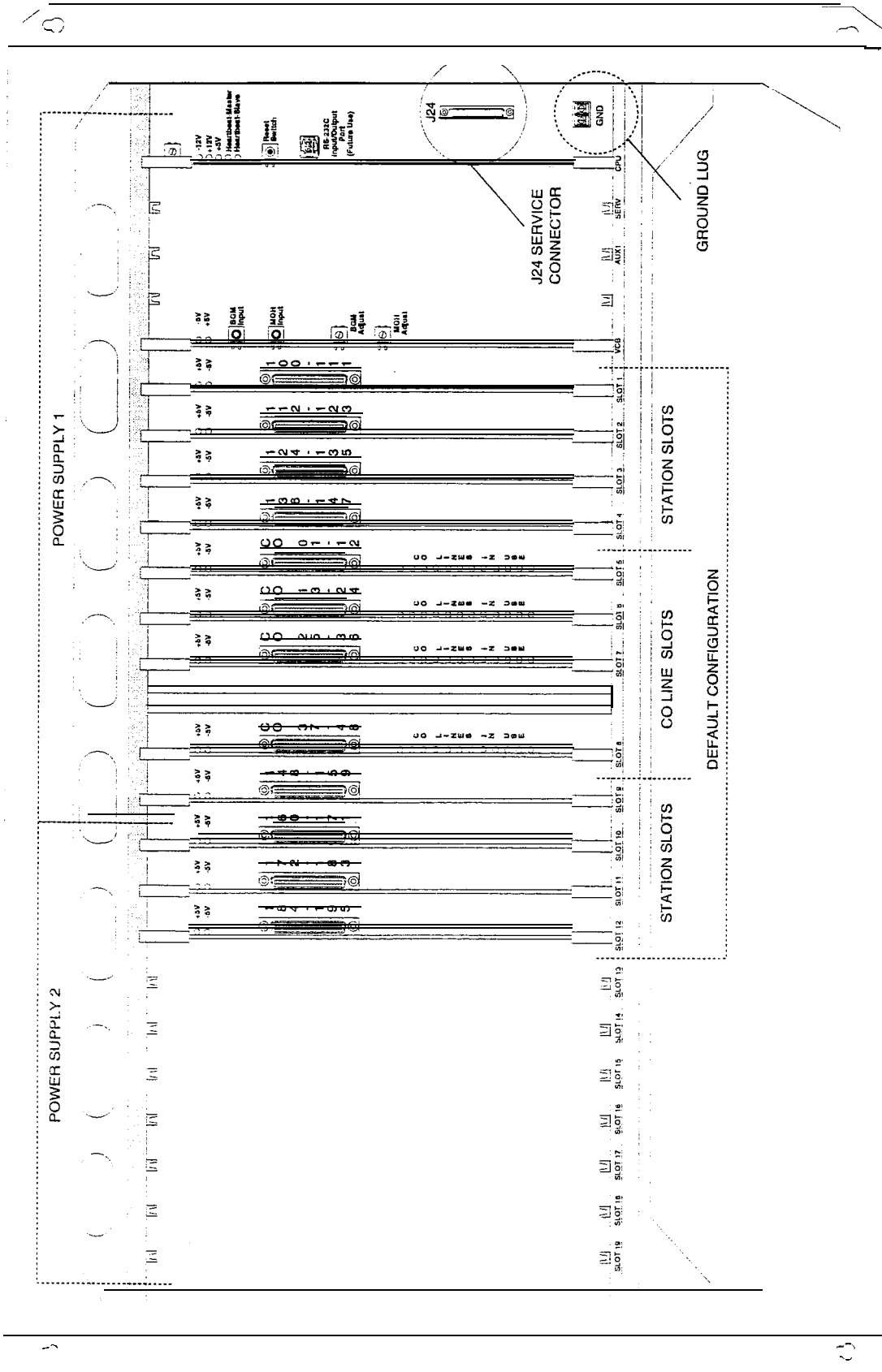

Figure 400-I Basic KSU Cabinet

## Power Supply

The system KSU is powered by modular power supplies that are mounted on the sides of the cabinet. The cabinet is divided so that one power supply will support a system configured with up to 48 CO lines and 60 stations (key or SLT). If the CO line or station requirements exceed the aforementioned configuration, the second power supply is needed. The power supplies provide the system with 24V power. They are plugged into a 120V ac circuit. The power supply and cabinet meet all safety requirements to comply with UL 1459 Second Edition and CSA C22.2 No. 225 standards.

## B. Central Processor Unit (CPU)

This plug-in card is one of two common equipment cards required to make the system operational. The CPU card controls all system activity. The CPU contains the main microprocessor a 16-bit (68302), the slave microprocessor (another 68302), and a real time clock. The master and slave CPU chips are connected via a serial communications link. The CPU is responsible for all control functions, execution of all logic operations, and control of system modules. The master CPU also provides software and hardware support to ensure the following:

- Watch dog timer and recovery.
- State/Event software design.
- Battery Backup of Customer Database RAM memory.

The slave CPU ensures the following signal processing functions are done:

- PCB status as to presence/absence of cards for automatic software configuration setup.
- Interpret an ID code from each PCB so that card type can be determined automatically.
- Process interrupts from peripheral cards and scan VCB.

In addition there is one RS-232 (modular connector) input/output port on the CPU and a connector to support the use of an optional Backplane I/O expansion module. The Backplane I/O Expansion Module adds two RS-232C I/O ports to the system for a system total of three I/O ports. A reset (halt) push button switch is located on the front of the PCB.

System software is provided in EPROM memory and is installed on the CPU. The CPU contains 512 kilobytes (expandable to 4MB) of EPROM memory storage and is equipped with 256K of battery-backed static RAM (expandable to 2MB). Provisions have been made on the card to address up to four megabytes of EPROM memory and up to two megabytes of static RAM.

- A Battery jumper strap is located on the CPU board. Jumpering from pins 1 & 2 disables the Battery Backup. Between pins 2 & 3 enables the Battery Backup option.
- The CPU allows the use of either 1 Megabit or 4 megabit static RAM chips to be used for RAM memory.

## LEDs & Indicators

Three green LEDs located along the front edge of the CPU provide an indication of the presence of -12V dc, +12V dc & -5V dc. Two red LEDs provide the system heartbeat indication.

## I/O Ports • Wiring/Pinouts/Connections

The Central Processor Unit contains one RS-232C, 8-pin modular jack type connector, I/O port (future) located near the front edge of the PCB. This I/O port will be capable of transmitting and receiving data at 300, 1200, 2400, 4800, and 9600 baud rates.

In the future, this I/O port can be used for SMDR output, Remote programming thru a data terminal or PC, ICLID output, or interfacing with a customer provided ACD Reporting package.



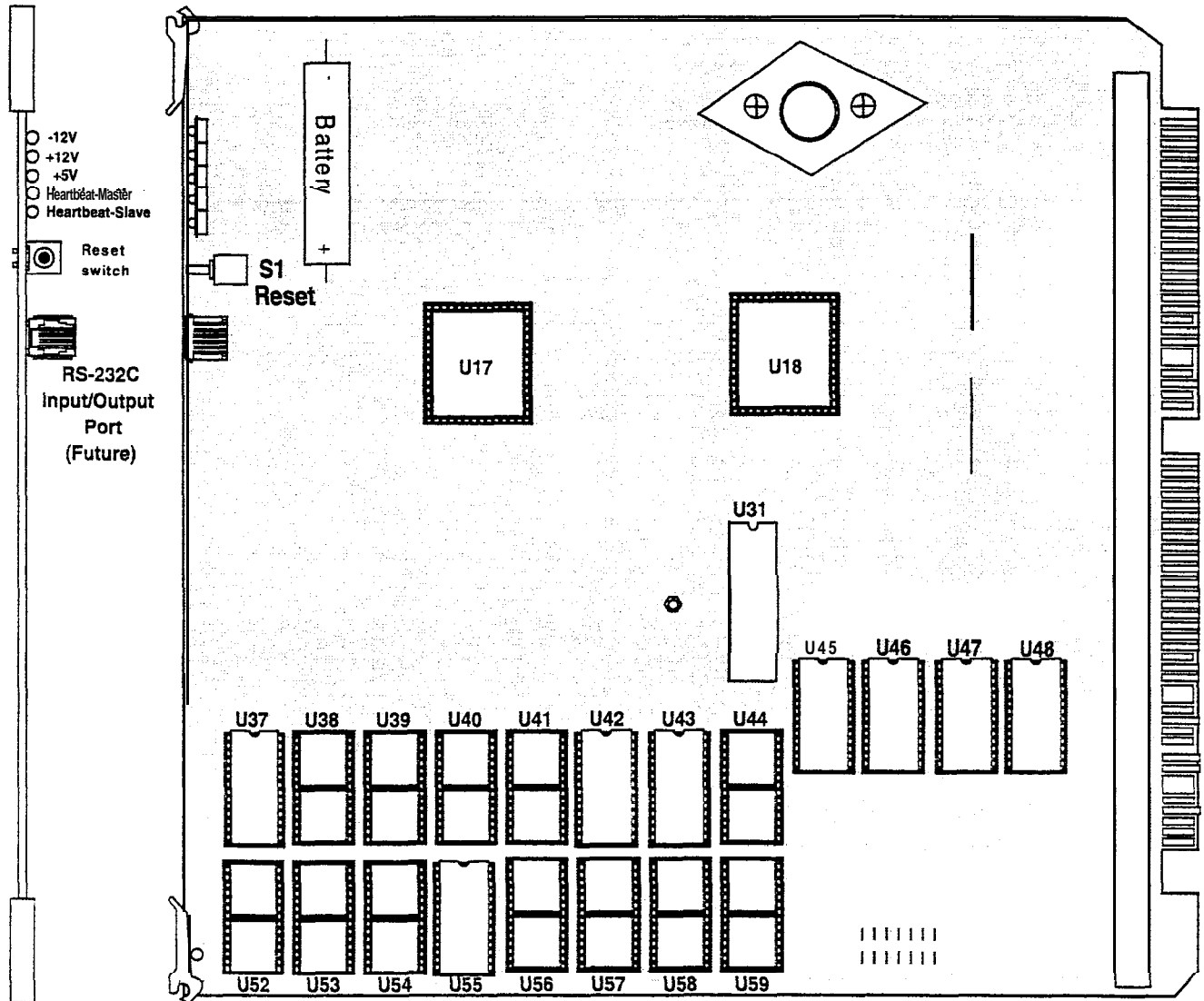

Figure 400-2 Central Processing Unit (CPU)

GENERAL DESCRIPTION

**C. Voice Control Board (VCB)**

The Voice Control Board (VCB) provides the time slot switch to control the digital switching information. The system tones are also generated on this board.

**LEDs & Indicators**

There are two LEDs on the board to indicate the +5V dc and -5V dc.

**Modem Interface**

The Voice Control Board (VCB) contains an "On-Board" modem that is capable of transmitting data at a rate of 1200 baud. The modem supports and is compatible with the Hayes command protocol.

The Bell System (Western Electric) standards 103 and 212A for modem design is incorporated into the design of this modem. The modem operates on-line in both Full and Half duplex modes.

**Wiring / Pinouts / Connections**

There are two phono input connectors on the board. One connector is for background music and the other is for music on hold. There are also two potentiometers to adjust each music source.

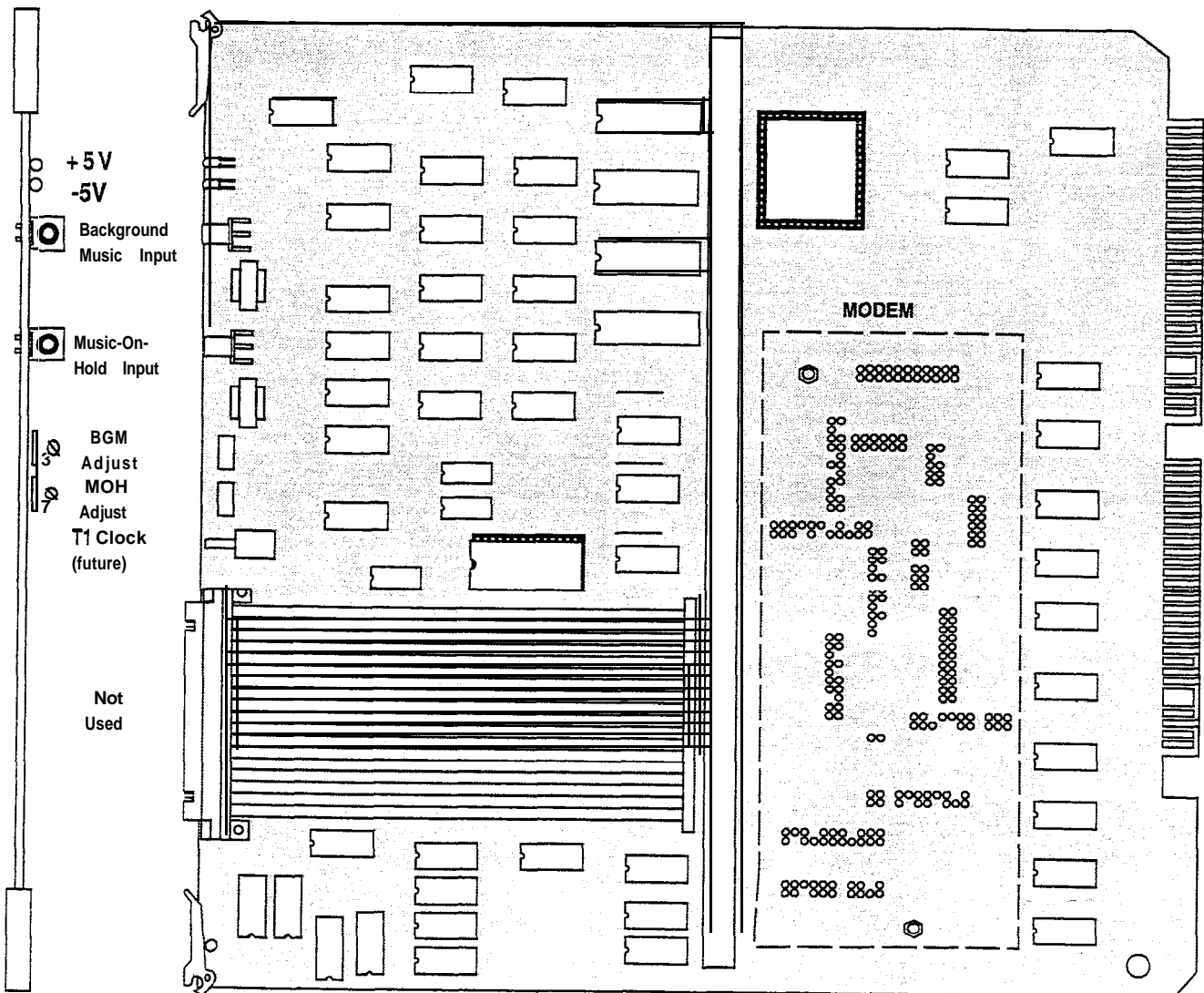

Figure 400-3 Voice Control Board (VC8)

**D. Key Telephone Board (KT12)**

The Key Telephone Board (KT12) provides the interface to twelve digital telephones. This board can be plugged into any designated station slot.

**LEDs & Indicators**

The Key Telephone Board (KT12) contains two LEDs to indicate the presence of +5V dc and -5V dc. The LEDs are located on the top portion of the board.

**Line/Station Interfaces**

The Key Telephone Board (KT12) has one male 50-pin amphenol connector on the front edge. This will interface the circuits on the board to the MDF.

The board also provides proper fusing or protection to comply with the requirements of UL 1459 Second Edition and CSA C22.2 No. 225 standards.

A Digital DSS Console, a Single Line Telephone Adapter (OPX), or other specifically designed adapter with a digital interface can be assigned to any one of the interface circuits. The Key Station interface circuits are protected from mis-wiring and over-current.

**NOTE**  
 External Paging Zones start from Card Slots 1 thru 4. for External Paging Zones 1 thru 4. Card Slots 9 thru 11 represent External Paging Zones 5 thru 7. If a Single Line Board (SL12) is inserted between two Key Station Boards (KT12), the External Paging Zone associated with that card slot becomes unusable.

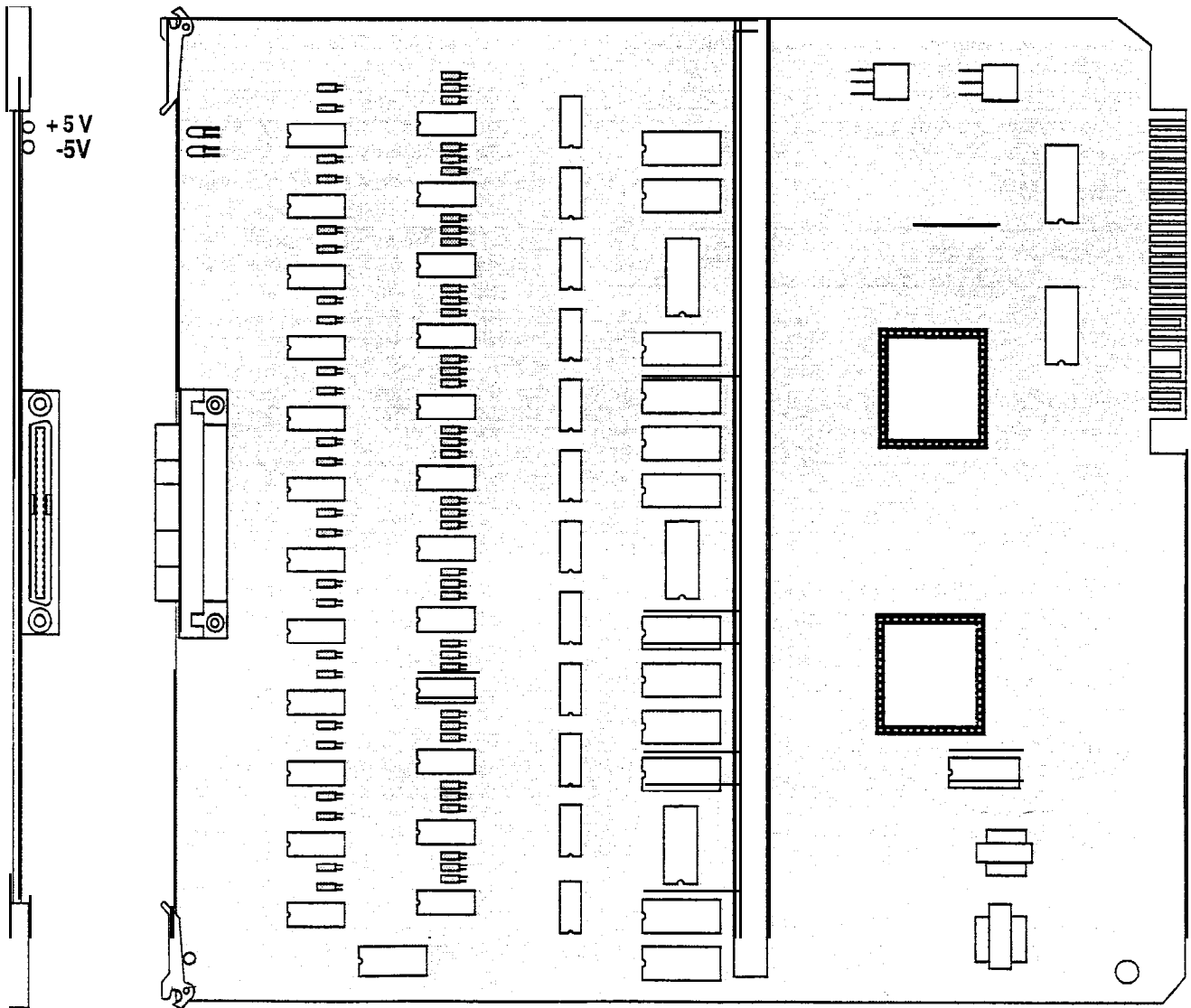

Figure 400-4 Key Telephone Board (KT12)

## GENERAL DESCRIPTION

## E. Single Line Board (SL12)

The Single Line Telephone board provides the interface for 12 **2500-type** single line telephones. This board can be plugged into any designated station slot. It is recommended that the Tri-Output Power Supply be used with this card to provide the 90V ac and -48V dc voltages.

**NOTE**

*Only one Ring Generator is required per system. One Tri-Output Power Supply will accommodate two SL12 boards. When an SL12 board is installed, it is recommended that the DTM4 DTMF Receiver Module be installed at the same time. If 3 or more SL12 boards are installed in the system, at least 1 DTM4 should be installed. However, no more than 3 SL12 boards with DTM4 receivers on them can be installed in the system.*

Message Waiting capability comes installed on the Single Line Telephone Board. This circuitry provides message waiting lamps to single line telephones equipped with message waiting lamps and supports up to 12 Single Line Telephone Message Waiting lamps at 90V dc typically across tip and ring.

**LEDs & Indicators**

The board contains three LEDs to indicate the presence of +5V dc, -5V dc and -48V dc. The LEDs are located on the top portion of the board.

**Line/Station Interfaces:**

The Single Line Telephone board has one female **50-pin amphenol** connector on the front edge. This interfaces the circuits on the board to the MDF. The board has one two-conductor molex connector to provide an input for **90V ac** ring. A second two-conductor molex connector interfaces -48V dc to the card. Each SL12 installed in the system must have both 90V ac and -48V dc applied to it via these connectors. The card also provides proper fusing or protection to comply with the requirements of UL 1459 Second Edition and CSA C22.2 No. 225 standards.

These single line telephones can be equipped with a standard Message Waiting Lamp (90V T & R) that operate on the "tip" and "ring" leads. Additionally each circuit provides a loop interrupt of 700ms duration. This is the duration of loop interrupt provided to a single line port if loop interrupt is detected on a CO line that the single line port was connected to. Also provided if a station calls an SLT port and hangs up. The card will support single line telephones up to 2000 feet from the Basic KSU cabinet. Refer to Table 400-4 Loop Limits for additional wiring information. On-premise single line telephones should present a load to the port totaling a maximum ringer equivalence of 2.5.

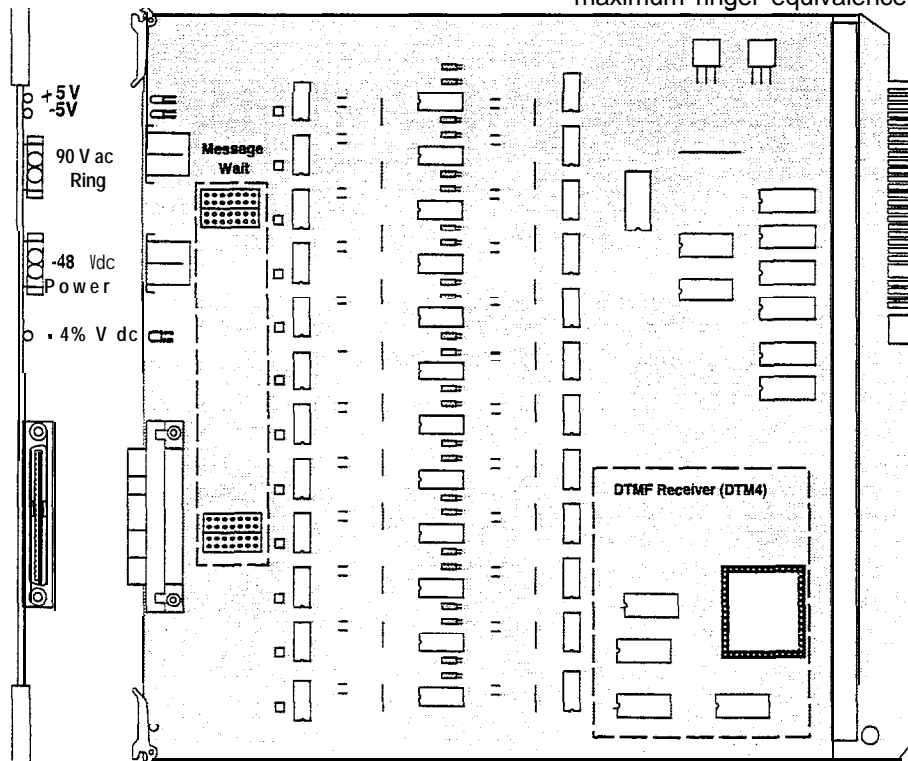

**Figure 400-5 Single Line Telephone Board (SL12)**

**F. CO Loop Interface Board (C012)**

This board interfaces 12 Loop Start CO lines to the system. This board can be plugged into any designated trunk slot.

**LEDs & Indicators**

The board contains two LEDs to indicate the presence of -5V dc and +5V dc. In addition, the board has 12 red LEDs to provide the status of each CO line on the board. A lighted LED will indicate an in-use condition, while an un-lit LED reflects an idle state.

**Line/Station Interfaces**

The board has one female 50-pin amphenol connector on the front edge. This will interface the circuits on the board to the MDF.

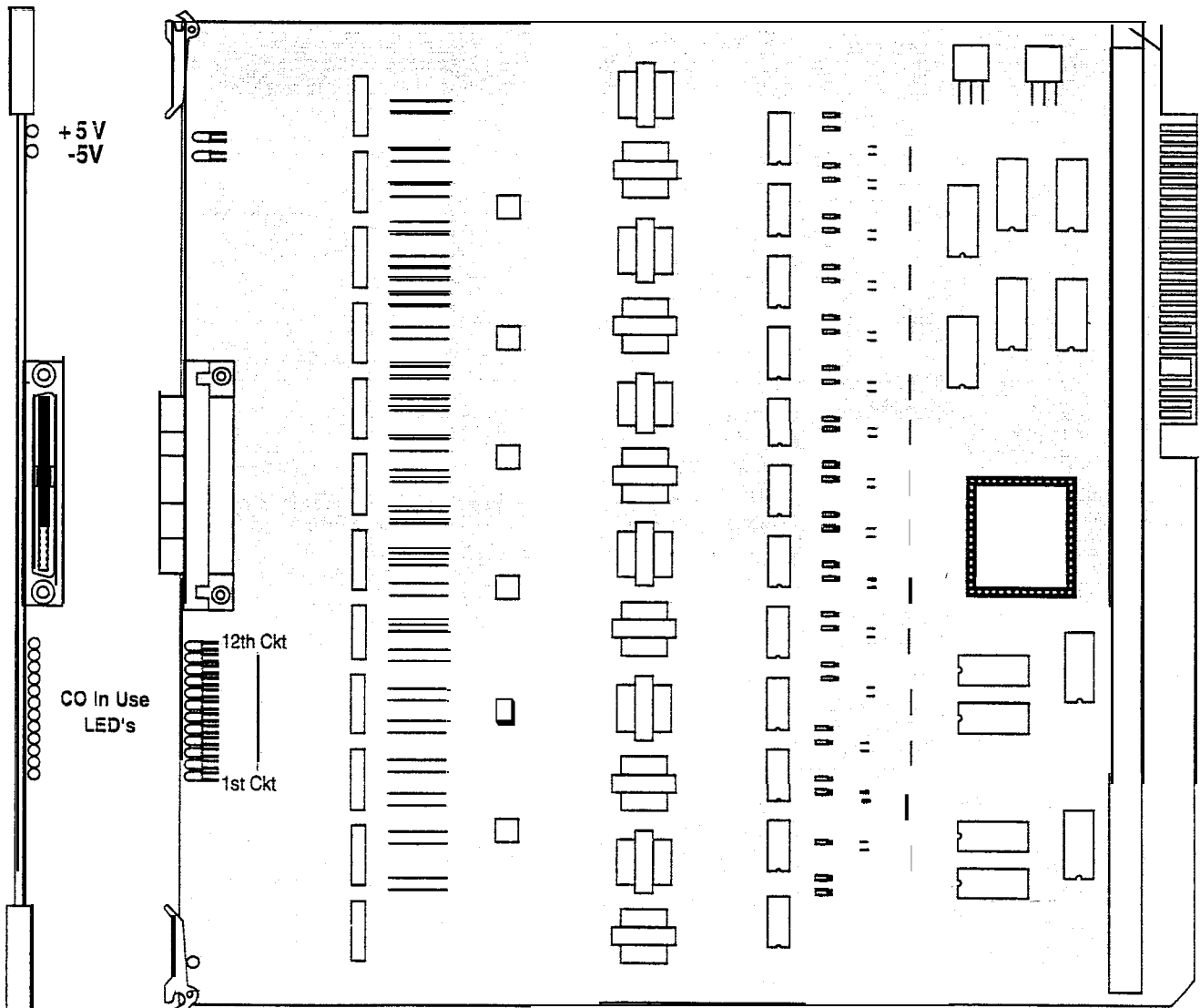
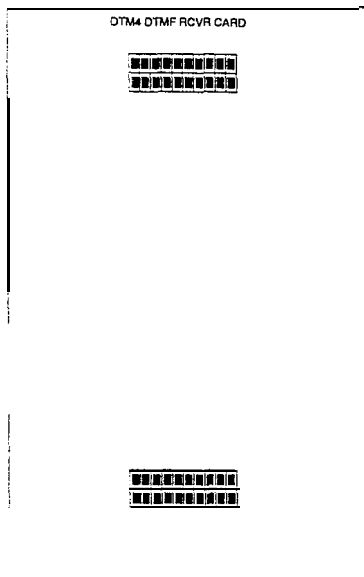

Figure 400-S 1 P-Circuit CO Line Board (CO1 2)

**GENERAL DESCRIPTION****400.3 APPLICATION MODULES****A. 4-Circuit DTMF Receiver Module (DTM4)**

This board provides four DTMF receivers for SL12 boards. This board is connected onto each SL12 board. Each SL12 board may contain 1 DTM4 board. No more than 3 SL12 boards with DTM4 Receiver Modules on them can be installed in the system.

**C. Backplane I/O Expansion Module**

The Backplane I/O Expansion Module is a wall mount unit with a 36-pin input connector and four RS-232C output connectors.

The Backplane I/O Expansion kit consists of one connecting cable and the I/O Expansion Module.

Locate the Backplane I/O Expansion Module in a location on the MDF backboard convenient to the KSU.

**Wiring / Pinouts / Connections**

The board has one molex connector at each end that plugs onto metal pins located on each SLT board.

Generally, one receiver will support DISA and/or eight SLT stations under light to moderate traffic. If SLT and or DISA traffic is heavy, additional DTMF receivers should be added. It is also recommended to add additional DTMF Receivers when a Voice Mail or Auto Attendant is connected to the system.

**B. Tri-Output Power Supply**

The Tri-Output power supply interfaces with the Single Line Board (SL12) and contains a -48V dc supply, 24V dc supply, and a Ring Generator. This is a wall mountable unit and contains screw type terminals for its connections. Each Tri-Output power supply can accommodate two SL12 boards for the -48V supply. The Ring Generator portion of the Tri-Output power supply can accommodate all SL12 boards installed in the system.

The Tri-Output power supply can provide a -48V dc source up to 1 amp of current. The 24V dc source will handle up to 1 amp of current. The Ring Generator can supply up to 5 watts of Ring voltage.

#### 400.4 DIGITAL TERMINALS

##### A. Executive (Display) Terminal

The **34-button** Digital Terminal is one in a line of Digital electronic telephone terminals. The line consists of an Executive (Display) telephone, an Enhanced (non-display) telephone and a Basic telephone. These telephones are designed to operate with the new line of Starplus Digital Key Systems and PBX Systems.

The digital terminals are connected to the KSU via a four wire (two twisted pair) connection from an appropriate electronic terminal interface board.

##### LCD Display:

The Executive Digital Display Terminal has a 48 character Liquid Crystal Display. The display provides information such as station extensions calling, Line ringing information, camp-on information, Message waiting information and so on. The LCD Display is a **48-character** display divided into 3 fields:

- Field 1 = Current Status (top line, 24- characters)
- Field 2 = Date (Left half of bottom line, 12-characters)
- Field 3 = Time of day (Right half of bottom line, 12-characters)

These fields are separately maintained by the KSU processing to show current and pending station activity. Each field is re-created upon any display change except additional digits which are added to the end of the existing display.

The **terminal** communicates to the KSU through two 64K digital channel arrangements. One channel is used as the primary voice channel, a second is used for terminal to KSU command transmission. Power is also provided to the terminal via the four wire connection.

##### Buttons and LEDs:

The Executive Digital Terminal printed circuit board provides long life "super bright" Light Emitting Diodes (LEDs) and button assemblies that protrude through the top housing. The buttons are small rectangular in shape with a clear end for proper LED visibility and diffusion. The Executive Digital Terminal has 34-buttons all containing LEDs plus a 12-key dial pad.

The Executive Digital Terminal scans the key board for dial pad and button debounces and depressions for command transmission to the KSU. The keyset has the following buttons defined as follows:

##### Display and Non-Display:

- 12 Dial Key Pad\*
- 28 Flexible Buttons, of which there is:
  - 1 Camp-On button (flexible)
  - 1 Line Que button (flexible)
  - 1 Call Back button (flexible)
  - 1 Pick-up button (flexible)
  - 1 MSG button (flexible)
  - 1 FWD button (flexible)
  - 1 DND button (flexible)
  - 1 **CONF** button (flexible)
- 6 Fixed Feature buttons:
  - 1 **HOLD** button (fixed)
  - 1 **TRANS** button (fixed)
  - 1 **FLASH** button (fixed)
  - 1 **SPEED** button (fixed)
  - 1 **MUTE** button (fixed)
  - 1 **ON/OFF** button (fixed)

\* All buttons except the 12-key dial pad have an LED associated with it. Refer to Figure 400-7 Starplus Executive Digital Terminal.

##### Speakerphone:

Each Executive Digital Terminal is equipped with a unit that enables the telephone to be used handsfree in two-way conversations. The user activates the speakerphone by pressing the ON/OFF button (LED lights steady). To terminate a speakerphone call, the ON/OFF button is toggled OFF (LED extinguished). The MUTE feature is used in conjunction with the speakerphone option. To mute the speakerphone microphone, the MUTE button is pressed (LED lights steady). To reactivate the microphone, the MUTE button is pushed again (LED extinguished).

Several programmable options control the speakerphone operation. Each digital terminal can be programmed for full speakerphone operation, or monitor/On-Hook dialing capabilities with no full speaker phone operation.

When Automatic Pre-selection is enabled at the station when any button is pressed (i.e. CO, DSS, Page etc...) the station- and speakerphone is automatically activated.

##### Volume Controls:

Separate "slide" switches are provided on the front of the Starplus Digital Terminal to adjust the volume of the voice and tones presented to the terminal speaker.

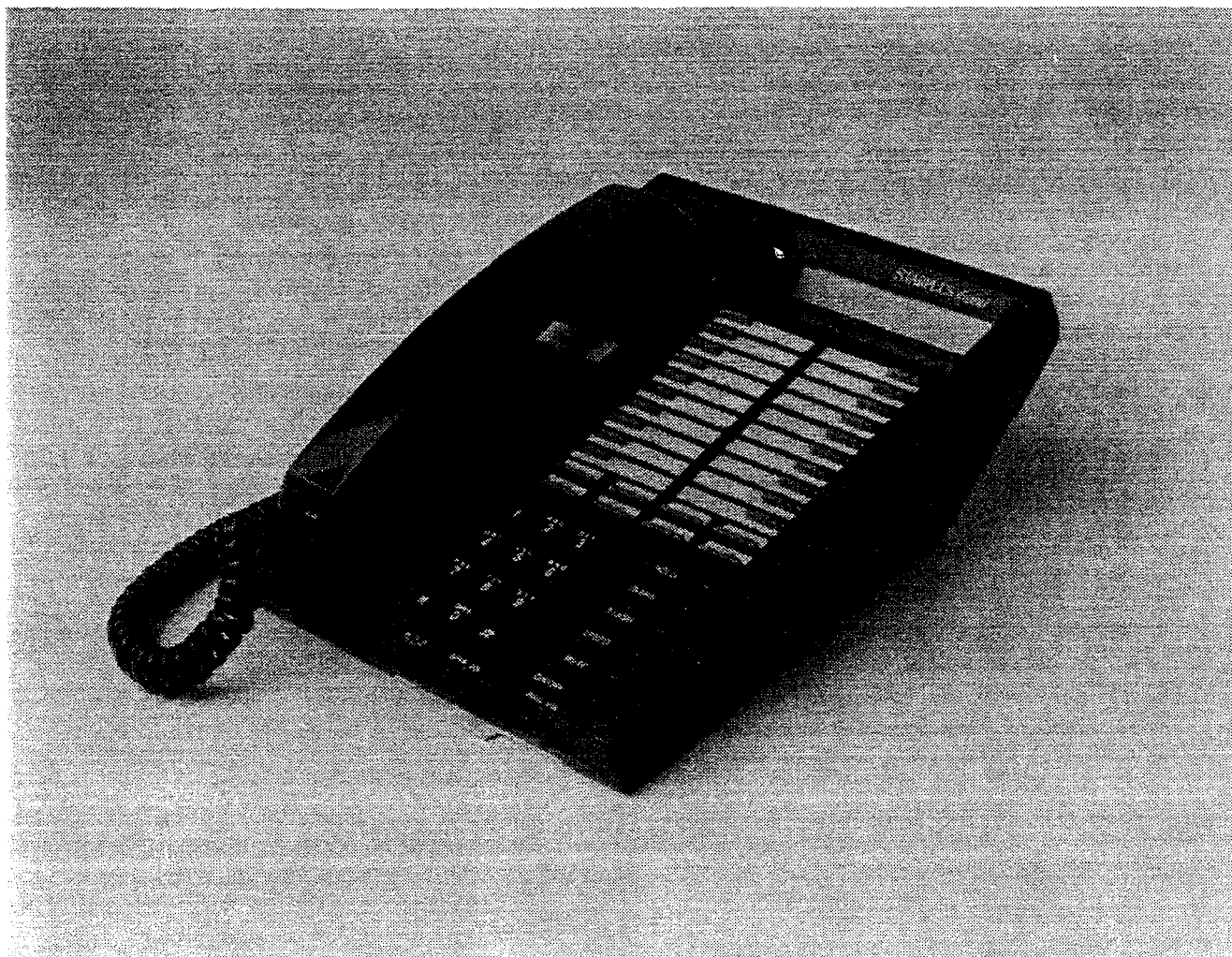

Figure 400-7 Executive Digital Terminal



- The "SPKR VOL" will control all voice signals sent to the speaker i.e. Speaker Phone conversations, BGM, and Page announcements.
- The "RING VOL" will control all tone signals presented to the speaker i.e. Ringing, splash tones, Camp-On etc... Muted ringing will also be controlled by the ringing volume slide switch. The muted ringing volume will be proportionately quieter than normal ringing based on the current switch setting.

**H-T-P Switch:**

A three position slide switch is located on the front of the Digital Display Terminal that controls the method of receiving intercom calls.

- The "H" position allows intercom call announce with hands free reply.
- The "T" position provides Tone only intercom ringing
- The "P" position allows Call Announce intercom calls only.

This switch allows users to set and control the method in which they receive their intercom calls. However, a dial code that users can dial before placing an intercom call can override a called station's switch setting of H or P to force the station to Tone ring.

**Directory Tray:**

Each Executive Digital Terminal is equipped with a slide-out Directory Tray accessed from the front of the digital terminal.

**Wall Mounting:**

The Executive Digital Terminal was designed with a reversible base that will allow the terminal to be wall mounted on industry on industry standard 630 type wall jacks. A 4-inch line cord is also provided as a standard item with each phone (the line cord is placed inside the reversible wall mount base).

**Handset/line Cords:**

The Executive Digital Terminal uses a color coordinated K-Style handset with a matching 12-foot handset cord. A 9-foot four conductor base line cord is included with every Terminal.

The Executive Digital Terminal uses an electret-type transmitter. Compatible headsets can be plugged into the Terminals handset jack for headset operation.

**8. Executive/PC interface Terminal (ICLID)**

The Executive/PC Interface Terminal is similar to the Executive Display model and all of the information listed above applies to the Executive/PC Interface model except this terminal is

used to deliver specific data messages identifying call states to a device attached to the phone via a serial channel following the data transmission requirements of RS-232C. The interface parameters to be used are 2400bps, no parity, 8 data bits, and 1 stop bit. This feature will deliver ICLID data to a Personal Computer attached to the phone for look-up of customer records and subsequent processing by the individual answering the telephone call. Calls can also originate from the Personal Computer through the digital terminal.

The Executive/PC Interface terminal provides transmit, receive, and ground data lines from the phone micro-processor which are used on command from the KSU to output information. The use of this capability would be to output the ICLID information to a PC attached to the phone. The VODAVI Call Tracker software program is available to support these Caller ID applications. Future use could be made of this capability for low speed data provided to equipment attached to the phone.

**C. Enhanced Digital Terminal**

The Enhanced Digital Terminal is similar to the Executive Digital Terminal and all of the information listed above applies except there is no LCD display.



Figure 400-8 Enhanced Digital Terminal

### D. Basic Digital Terminal

The Basic Digital Terminal is one in a line of digital electronic telephone terminals. This new telephone is designed to operate with the line of Starplus Digital Key Systems and PBX Systems.

#### Buttons and LEDs:

The Basic Digital terminal key board PCB provides long life "super bright" Light Emitting Diodes (LEDs) and button assemblies that protrude through the top housing. The buttons are small rectangular in shape with a clear end for proper LED visibility and diffusion. The 14-button Digital Terminal has eight buttons all containing LEDs plus a 12-key dial pad.

The Basic Digital Terminal scans the key board for dial pad and button debounces and depressions for command transmission to the KSU. The keyset has the following buttons defined as follows:

12 Dial Key Pad\*

14 buttons, 8 of which are flexible

- 1 CO line 1 button (flexible)
- 1 CO line 2 button (flexible)
- 1 LOOP button (flexible)
- 1 POOL button (flexible)
- 1 MSG button (flexible)
- 1 FWD button (flexible)
- 1 DND button (flexible)
- 1 CONF button (flexible)

6 Fixed Feature buttons:

- 1 HOLD button (fixed)
- 1 TRANS button (fixed)
- 1 FLASH button (fixed)
- 1 SPEED button (fixed)
- 1 MUTE button (fixed)
- 1 ON/OFF button (fixed)

\* All buttons except the 12 key dial pad, have an LED associated with it. Refer to Figure 400-9 Starplus Basic Digital Terminal.

#### Speakerphone:

Each Basic Digital Terminal is equipped with a unit that enables the telephone to be used handsfree in two-way intercom conversations only. The user activates the speakerphone by pressing the ON/OFF button (LED lights steady). To terminate a speakerphone call, the ON/OFF button is toggled OFF (LED extinguished). The MUTE feature is used in conjunction with the speakerphone option. To mute the speakerphone microphone, the pre-programmed MUTE flex button is pressed (LED

lights steady). To reactivate the microphone, the MUTE button is pushed again (LED extinguished).

#### Volume Control:

Separate "slide" switches are provided on the front of the Starplus Basic Digital Terminal to adjust the volume of the voice and tones presented to the terminal speaker.

- The "SPKR" slide switch controls the speaker volume which controls all voice signals sent to the speaker i.e. intercom conversations, BGM, and Page announcements.
- The "RING" slide switch controls the ringing volume which controls all tone signals presented to the speaker i.e. Ringing, splash tones, Camp-On etc... Muted ringing is also controlled by the slide switch. The muted ringing volume will be proportionately quieter than normal ringing based on the current switch setting.

#### H-T-P Switch:

A three position slide switch is located on the front of the Basic Digital Terminal that controls the method of receiving intercom calls,

- The "H" position allows intercom call announce with hands free reply.
- The "T" position provides Tone only intercom ringing
- The "P" position allows Call Announce intercom calls only.

This switch allows users to set and control the method in which they receive their intercom calls. However, a dial code that users can dial before placing an intercom call can override a called station's switch setting of H or P to force the station to Tone ring.

#### Directory Tray:

Each Basic Digital Terminal is equipped with a slide-out Directory Tray accessed from the front of the digital terminal.

#### Wall Mounting:

The Basic Digital Terminal was designed with a reversible base that allows the terminal to be wall mounted on industry standard 630 type wall jacks. A 4-inch line cord is also provided as a standard item with each bracket.

#### Handset/ line Cords:

The Basic Digital Terminal uses a color coordinated K-Style handset with a matching 12-foot handset cord. A 9-foot four conductor base line cord is included with every Terminal.



Figure 400-9 Basic Digital Terminal

The Basic Digital Terminal uses an electret-type transmitter. Compatible headsets can be plugged into the Terminals handset jack for headset operation.

**E. Digital DSS/DLS Console**

The Digital Direct Station Selector /Direct Line Selector (**DSS/DLS**) Consoles can be installed in place of any digital terminal circuit. The **DSS/DLS** Digital Console was designed in a housing similar in looks to the 34-button digital terminal.

The Direct Station Selector/Direct Line Selector (**DSS/DLS**) Console to be used with the family of **Starplus** digital systems is modular in nature. The **DSS/BLF** console provides 48 buttons (3 columns of 16 buttons) and requires a separate four-conductor line cord each connected to a digital terminal station port.

The **DSWDLS** Console unit can access Stations, Direct Appearing CO lines, or features that may be assigned to any of the flexible buttons.

A **DSS/DLS** unit may be assigned to one of the different MAP configurations available. Any one of the four MAP configurations may be assigned to the **DSS/DLS** and any number of maps may be assigned to one station. However, **MAPs** that have buttons assigned as CO lines cannot be changed, buttons assigned as Stations can be changed by the user. Up to three **DSS/DLS** units may be assigned to one station.

**DSS/DLS Console Button Mapping**

The buttons on the **DSS/DLS** console can be mapped with either a combination of fixed and flexible or completely flexible buttons where the station user may change the button programming to suit their needs.

There are four pre-defined **MAPs** for the **DSWDLS** Console with default Button Programming. Refer to Figure 400-11 DSS Console Map 1, Figure 400-12 DSS Console Map 2 and Map 3, and Figure 400-13 DSS Console Map 4 for a button layout of each DSS Console Map.

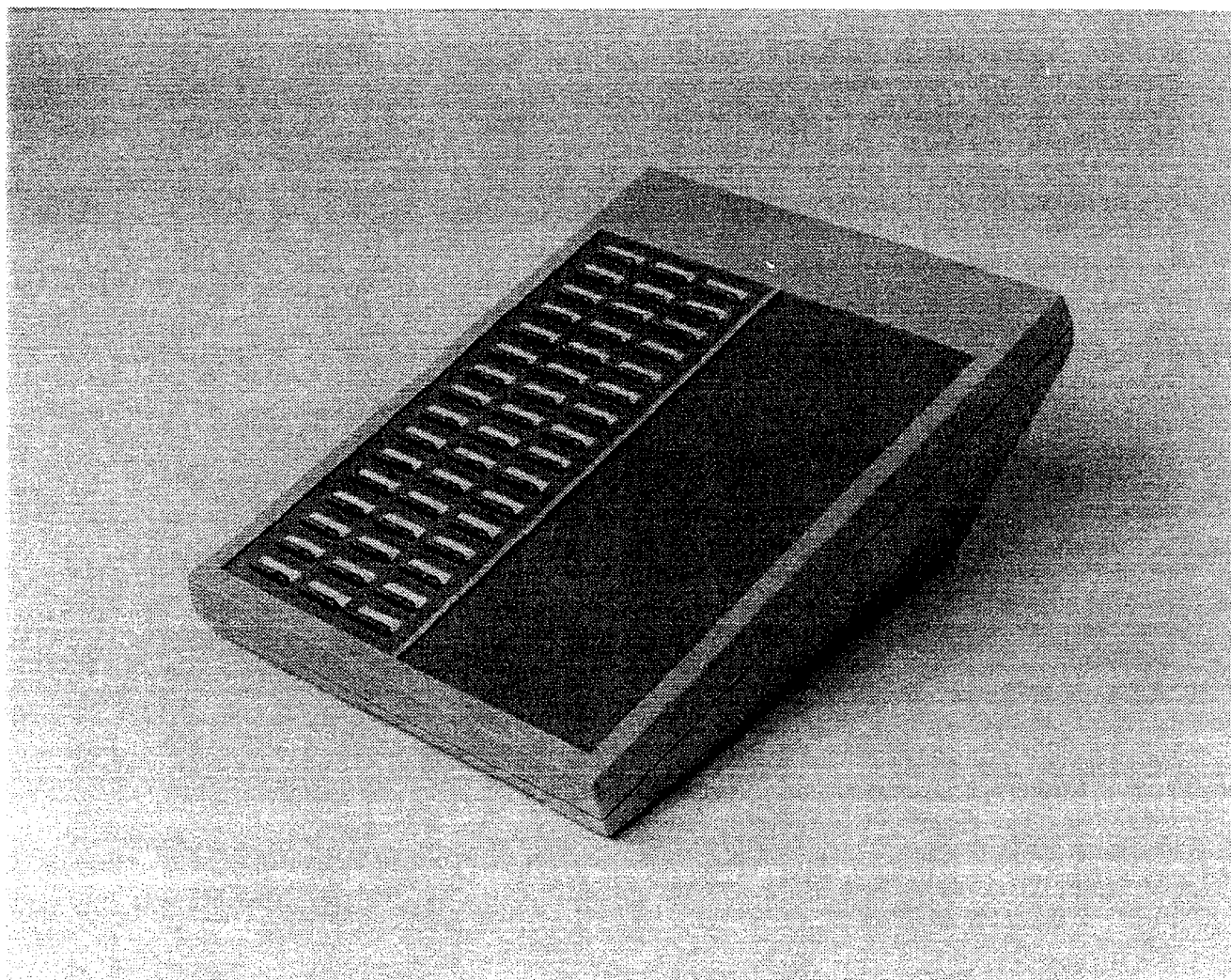

Figure 400-I 0 48-Button DSS/DLS Console

**MAP #1** has by default the first 12 CO lines and the first 36 Stations 100-135. This provides a default layout of a 12x36 configuration.

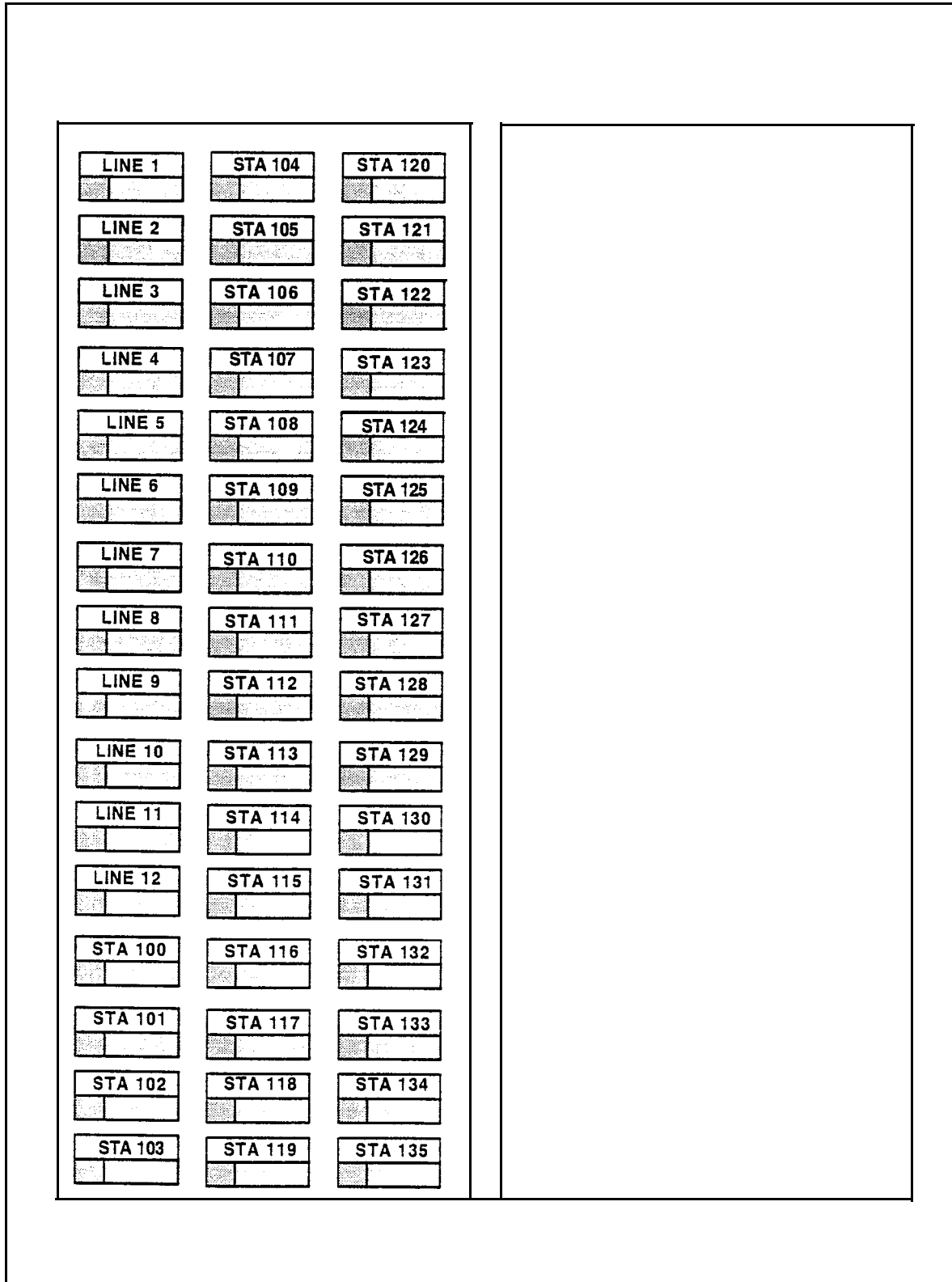

Figure 400-I 1 DSS Console Map 1



GENERAL DESCRIPTION

MAP #2 has by default the first 48 Stations, 100-147. All buttons on Map #2 are flexible and can be changed by the station user. This map can be duplicated on another DSS/DLS Console and assigned to the same station.

MAP #3 by default is intended to be used with Map #2 in that it has the remaining stations, 148-195 to provide a full Station mapping. All of the buttons on Map #3 are flexible and can be changed by the user. This map can be duplicated on another DSS/DLS Console and assigned to the same station.

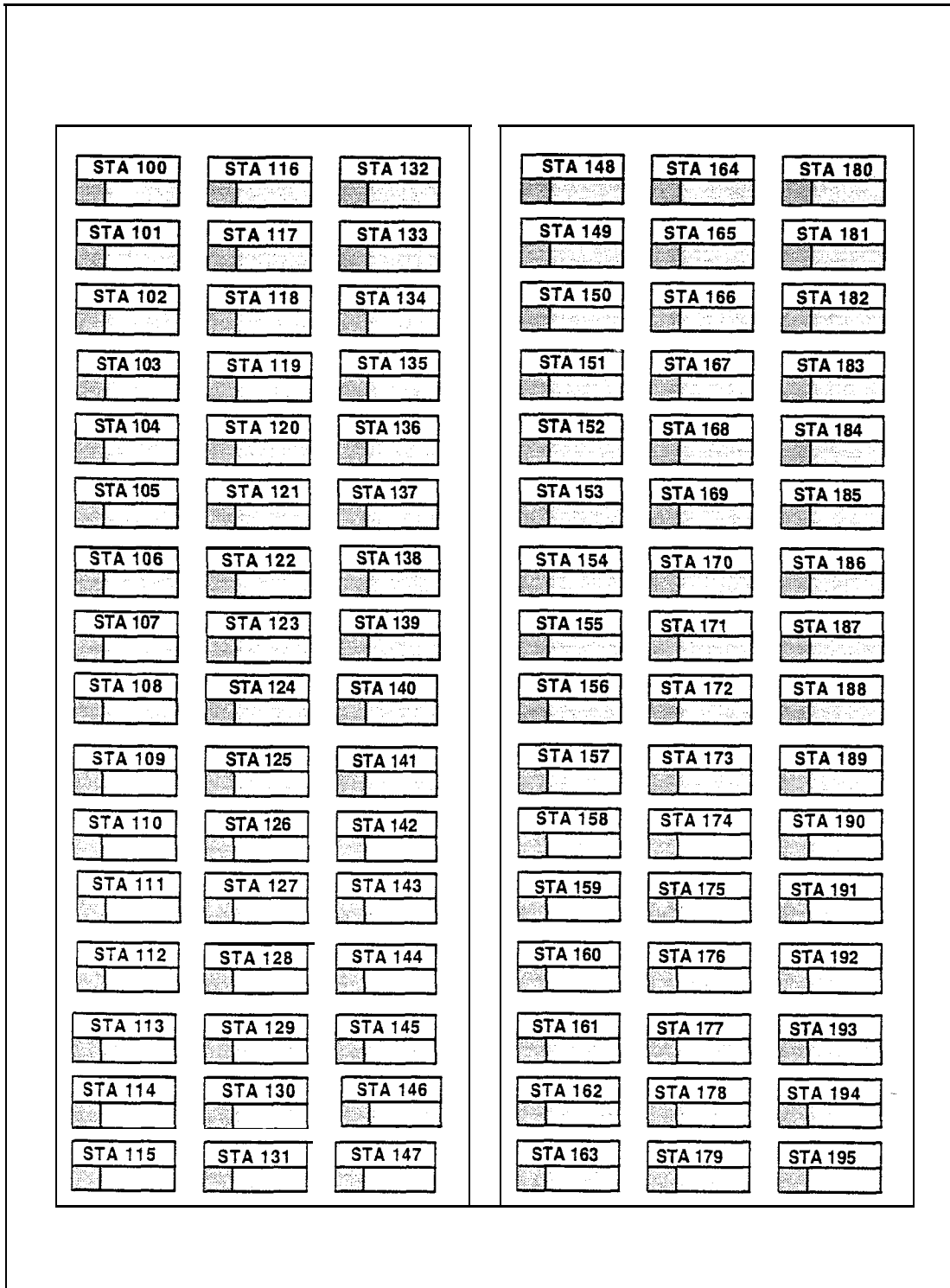

Figure 400-12 DSS Console Map 2 and Map 3



MAP #4 by default contains all 48 CO lines to provide a full CO Line mapping.

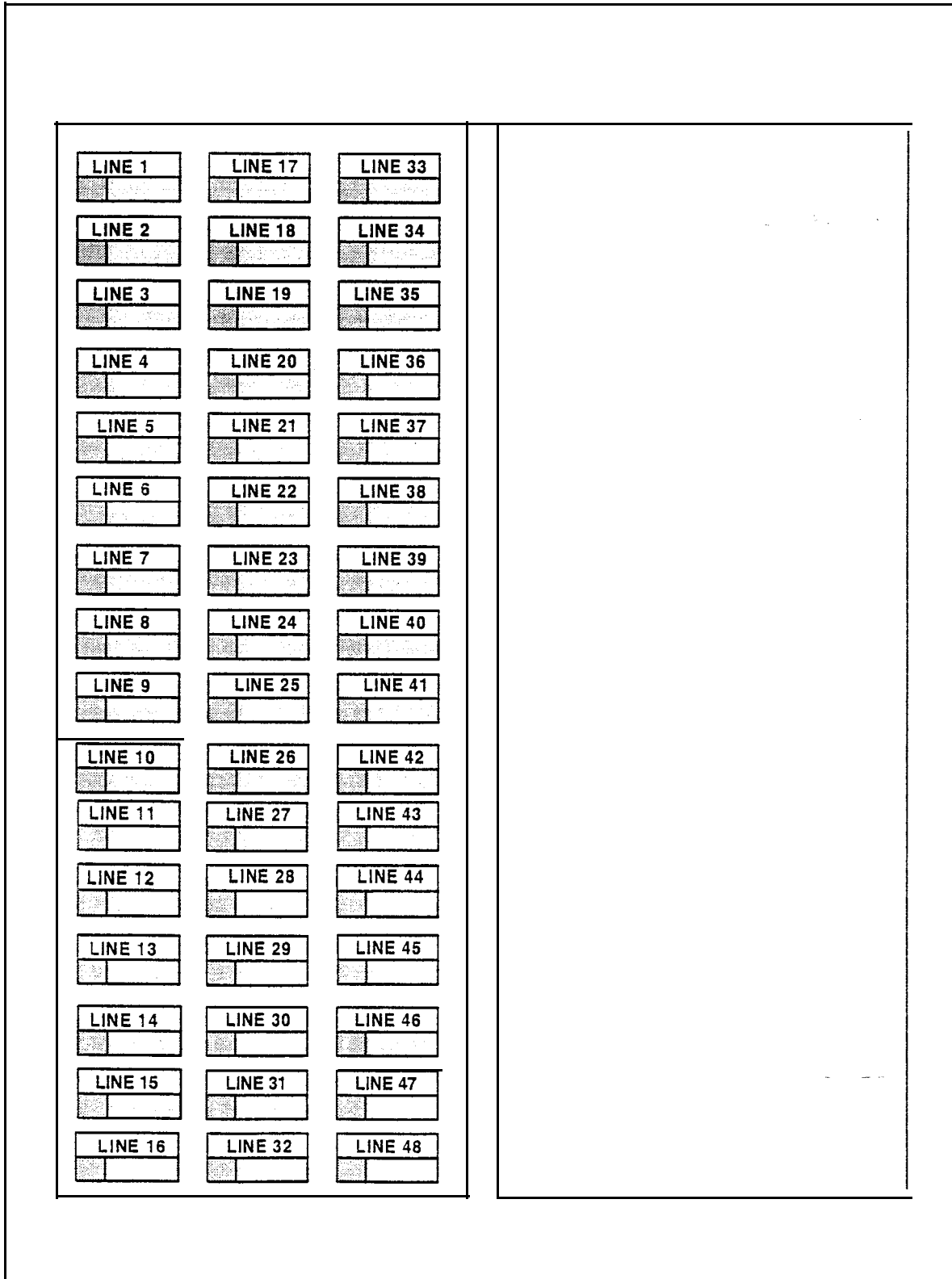

Figure 400-13 DSS Console Map 4

GENERAL DESCRIPTION

400.5 SLT ADAPTER / OFF-PREMISE EXTENSION MODULE

This external module provides the interface for one long loop (OPX) single line telephone (2500 type) extension. This module requires a separately provided -48V dc power supply to provide the necessary current for long loop applications and to support ring generation. This module is wired to and interfaces with a digital terminal (key station) port from the Starplus SPD 4896 System.

The OPX box meets the requirements of the FCC for connection to the telephone (Telco) network. Telephones connected to the OPX box must be DTMF only (2500 type).

This module also provides for one Power Fail circuit in the event of an AC power failure and contains its own DTMF receiver..

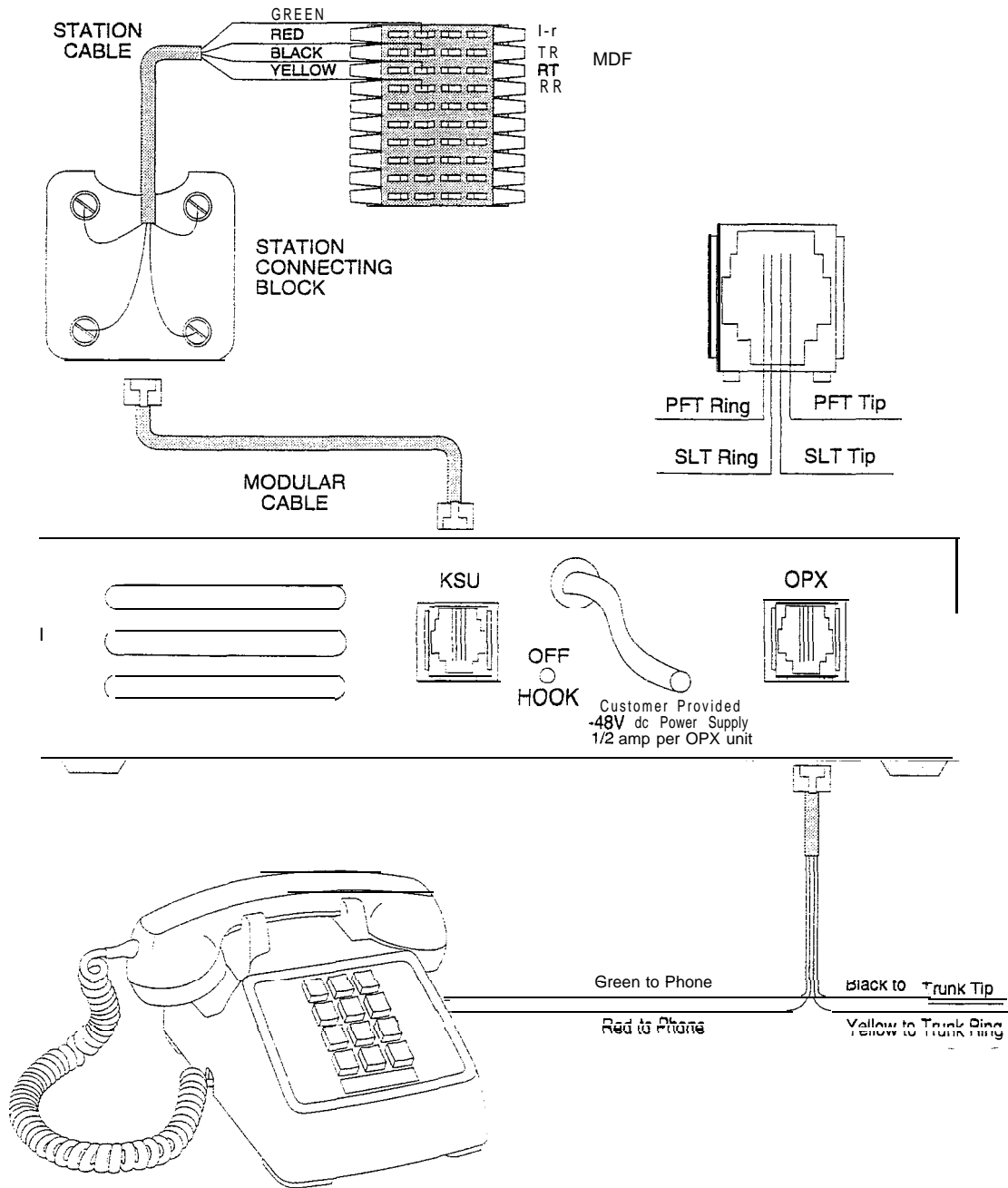

Figure 400-14 Off-Premise Extension (OPX) Module

400.6 RELAY / SENSOR INTERFACE MODULE

The Relay Sensor Interface Module connects to the Starplus SPD 4696 System using one digital station port and provides three relay activated contacts and three sensing circuits. The system will support up to 4 Relay/Sensor Modules. The relays provide for applications such as Loud Bell Control contacts, CO Line control contacts, RAN Start contacts, Page Relays, Power Fail contact

and additional applications as software will permit. The sensing circuits provide for such applications as RAN Stop (end of message) and other applications as developed and allowed by software.

An external power source is required to drive equipment connected to the relay contacts. The contacts are rated at 24V dc max. at 1 amp.

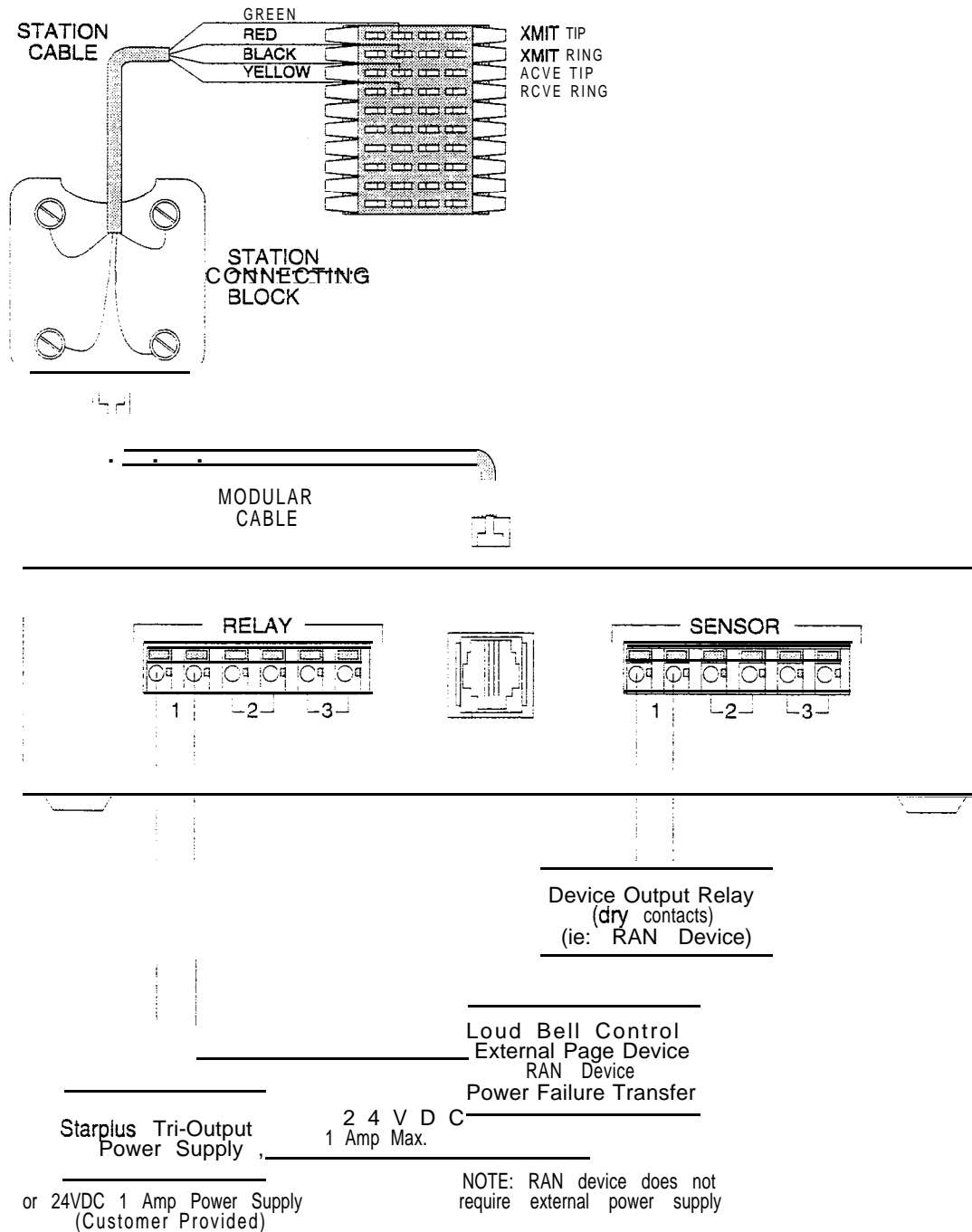

Figure 400-15 Relay / Sensor Interface Module

GENERAL DESCRIPTION

**400.7 POWER FAILURE TRANSFER UNIT (PFTU)**

This unit provides the relay transfer circuits for up to 12 CO lines in the event of a power or processor failure. The unit is housed in its own enclosure and mounts external to the KSU. Activation of the PFT relays is controlled by the Relay/Sensor Interface Module that is programmed for PFT. A customer provided 12V dc power supply is required to operate the unit. There is a manual switch that activates the PFTU for testing purposes.

With loss of power to the system or a failure of system processing, the PFTU will automatically connect up to twelve CO lines to prewired 500/2500 type telephones. When power is restored, the PFTU will automatically restore the CO trunks and stations to normal operation. These SLT stations do not have to be used for intercom, but can be if so desired.

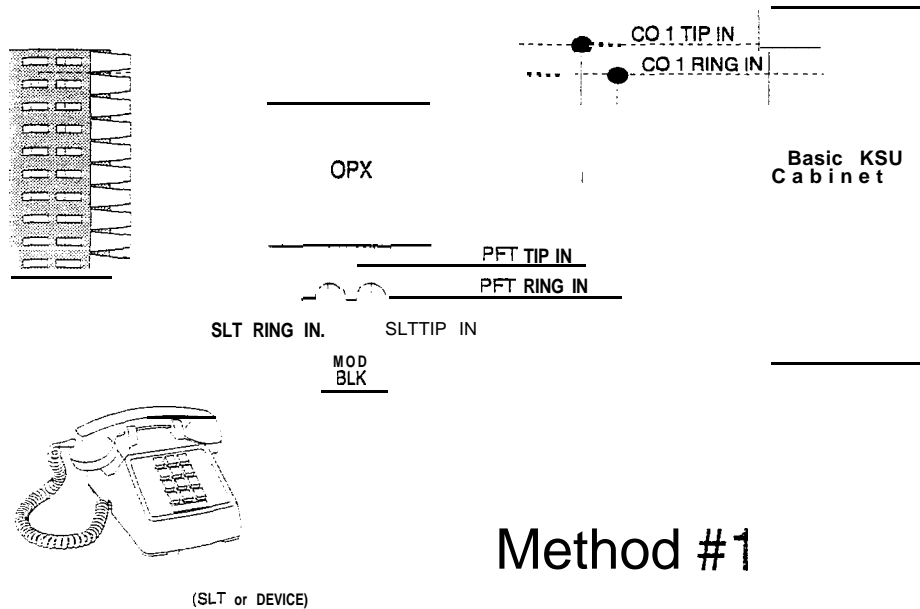

**Method #1**

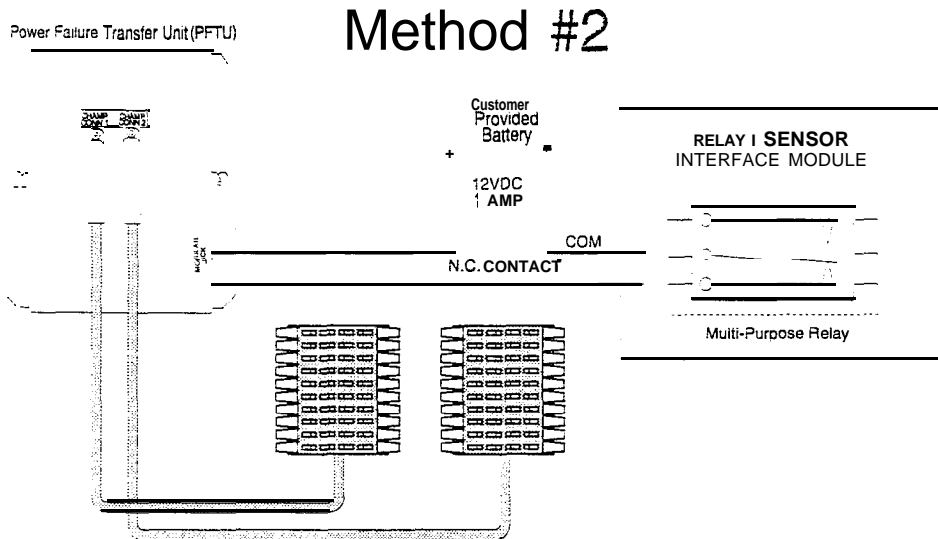

**Method #2**

Figure 400-16 Power Failure Transfer Wiring Options

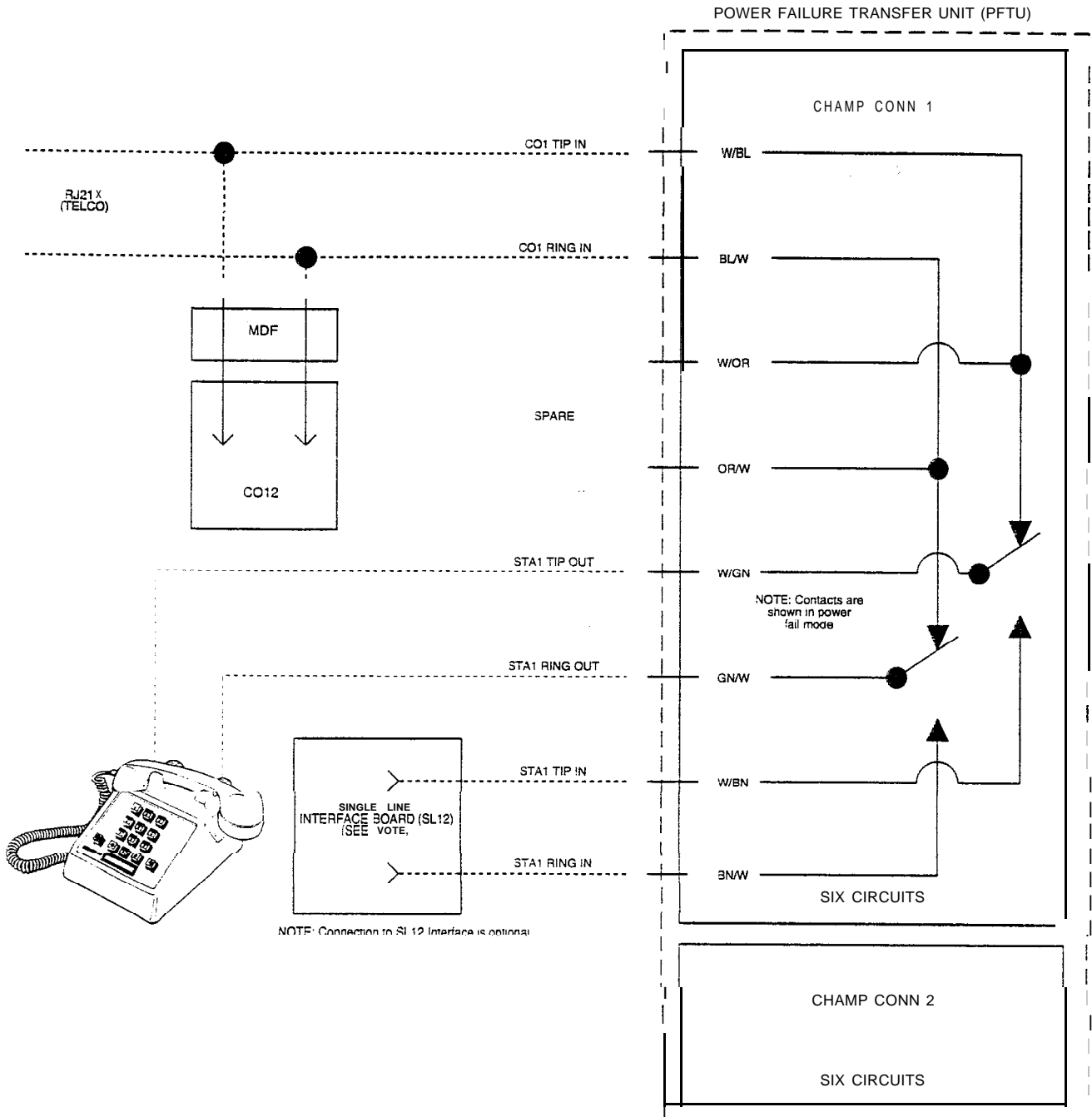

Figure 400-17 Power Failure Transfer Circuit

GENERAL DESCRIPTION

400.8 DATA FEATURE

The Data Feature is a time division switched, point to point data transmission capability which permits simultaneous (on the same system but not the same port) voice and data communications. The Data Feature offers the ability to transmit data information between personal computers, printers, plotters, modems, CRT terminals, and main frame computer ports.

To establish a Data call, a Digital Data Interface Unit (DDIU) is required to be connected to each data communications device. Data information can be switched through the system at speeds of 300, 1200, 2400, 4800, 9600, 19.2K and 38.4K baud asynchronous. Refer to Figure 400-18 Digital Data interface Unit (DDIU) wiring

The Digital Data interface Unit (DDIU) is wired to the infinite Digital Key Telephone Systems like a digital telephone, and requires one station port.

All connections to the DDIU are made on the back panel. The back panel has a modular jack and a DB-25 type connector. The modular jack, labeled KSU, is used to connect the DDIU to the station port of the system. The DB-25 connector supports an RS-232C connection and is used to connect the data device to the system.

A green LED lights to indicate the DDIU is properly wired to the system.

Connection of the individual data communication devices requires that the installer be familiar with data communications terms, and has access to the appropriate information for connecting the variety of data communications devices that may be encountered. This information consists of, but is not limited to:

1. Is the device configured as data terminal equipment (DTE), or data communications equipment (DCE).
2. What pin on the RS-232C type connector performs what function?
3. What signal leads are required to make the device operate?

When planning the installation of the data feature, use a digital display phone at any location that is to originate a data connection. A DDIU can only be called; it cannot originate a connection. A DDIU would typically be used in conjunction with the digital display phone. A DDIU would typically be connected to a printer, or a MODEM.

The station wiring for a digital display phone and a DDIU are identical.

The data connector of the Digital Data Interface Unit (DDIU) is a 25-pin, type D connector which is configured as Data Communications Equipment with the following pin configurations.

PIN #	USE	DIRECTION
2	Receive Data	DDIU
3	Transmit DATA	DDIU
4	Request To Send	DDIU
5	Clear To Send	DDIU
6	Data Set Ready	DDIU
7	Signal Ground	
8	Data carrier detect	DDIU
20	Data Terminal Ready	DDIU

The following diagram will aid in the design of cables to connect the many different configurations of data communications devices.

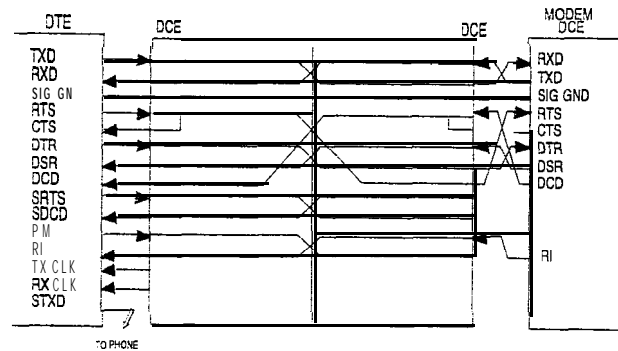

Digital Systems Data Switching

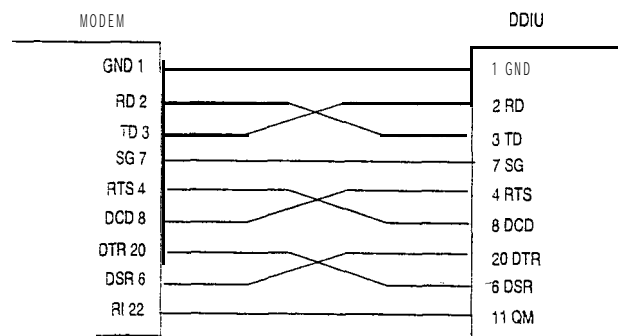

Modem to DDIU Cable

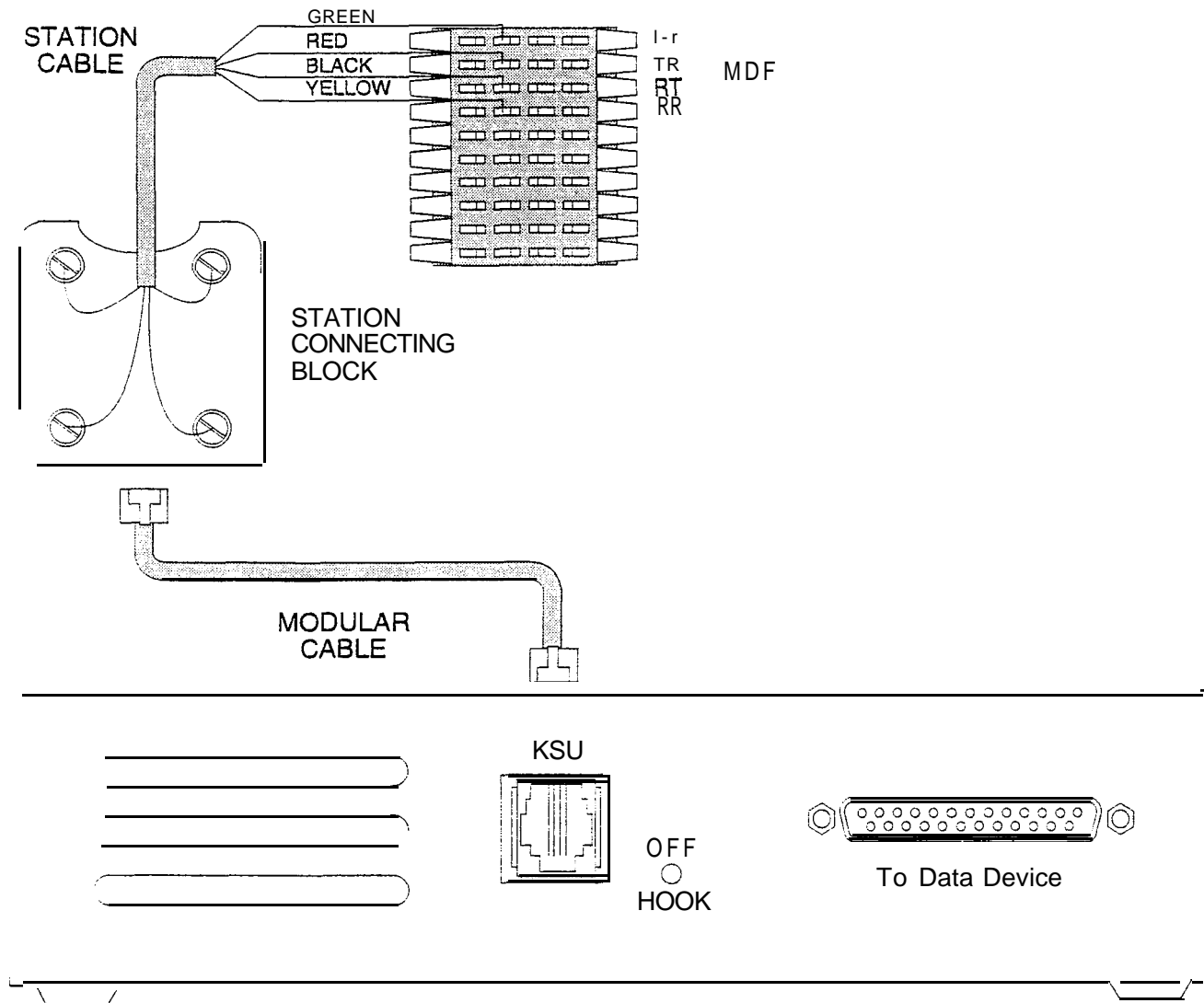
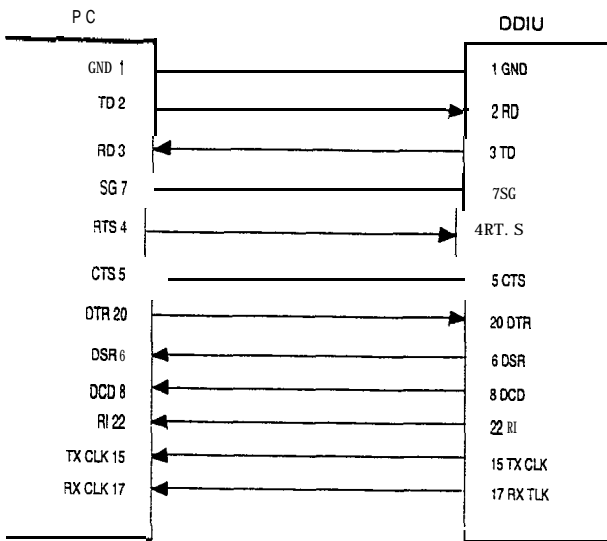

Figure 400-18 Digital Data Interface Unit (DDIU) wiring



Computer to DDIU Cable

To establish a connection to any idle data port:

1. A user with an associated DDIU dials the station number of the DDIU or the group access number of the group that the DDIU has been inserted into or presses a DSS button representing the DDIU. The digital key system will then determine the baud rate setting for the called DDIU and convert the users associated DDIU to the same baud rate. The system will then complete the connection.

A second method to establish a connection between two DDIUs is done by the first attendant.

1. The first attendant dials the extension number of one data unit. Dial tone is received and the display will show the BAUD RATE.
2. Then dials the station number of the second data unit, confirmation tone is heard.

To break down an established connection:

1. The station user dials his associated DDIU number or press the DSS button for the associated DDIU followed by pressing the FLASH button. The first attendant can also force a disconnect by dialing one of the DDIUs, followed by pressing the FLASH button,

Conditions:

- The System is transparent to the devices being connected. Therefore each DDIU must be configured with a specific baud rate, number of data bits and number of stop bits. This configuration will be done by the first attendant or in the case of an associated data unit can be configured by the user.
- Data switching is accomplished using the same wiring the telephone station uses for voice switching.
- Data ports can be arranged in UCD Groups or Hunt Groups.
- Data ports do not have to be associated with a **keyset**, however to connect two DDIU devices one of them must be associated with a **keyset** unless the connection is made by the first attendant.
- When the data connection has been completed, the baud rate used in the connection will be displayed on the **keyset**.
- Non associated DDIU connections can be broken down by the first attendant.
- A DDIU has a DCE interface. Therefore a straight through RS-232C cable can be used connect to a DTE device (printer, PC, etc.).
- Each DDIU requires a digital terminal port.

Refer to Station Attributes Programming, 630.2, Station Identification for programming the Station ID of the Digital Data Interface Unit (DDIU). Also refer to Sec. 630.3, Digital Data Interface Unit (DDIU) for programming the parameters of the Digital Data Interface Unit (DDIU).

#### 400.9 SYSTEM SPECIFICATIONS AND CAPACITY

The Starplus SPD 4896 system is card slot cabinet oriented with plug in modules (cards) expanding the system via station boards and CO boards. The boards are configured as 12 CO/PBX/Centrex lines, 12 digital stations, or 12 single line stations. A complete system capacity allows for use of up to 144 ports for Stations, CO Lines, or Data switching Modules.

DSS/DLS's can be installed in place of any Digital Key terminal. Standard single line telephones (2500 type) can be supported instead of key stations by installing single line boards (SL12) in place of the key station board (KT12). Twelve single line telephones can replace 12 Digital Display Terminals for each board exchanged. An ON/OFF switch is located on the front of the power supply.



- The system capacities are listed in Table 400-1 Digital System Capacities.
- Electrical specifications are listed in Table 400-2 Electrical Specifications.
- Environmental specifications are listed in Table 400-3 Environmental Specifications.
- Loop limits are listed in Table 400-4 Loop Limits.
- Dialing specifications are listed in Table 400-5 Dialing Specifications.
- FCC Registrations Numbers are listed in Table 400-6 FCC Registration Numbers.
- Trunk Ordering information for Public Network Lines are listed in Table 400-7 Trunk Ordering Info: Public Network Lines
- Miscellaneous Specifications are listed in Table 400-9 Miscellaneous Specifications.
- Key telephone, Single Line Telephone and OPX Audible Indications are listed in Table 400-10 Digital Terminal Audible Signals, Table 400-11 Single Line Telephone Audible Signals and Table 400-12 OPX Telephone Audible Signals.
- Key Telephone Visual Indications are listed in Table 400-13 DSS/BLF Button Visual Indicators, Table 400-14 CO Line Button Visual Indicators, and Table 400-15 Function Button Visual Indicators.

Table 400-I Digital System Capacities

Time Slots:	144 PCM/TDM time slots
Ports:	
CO/PBX/Centrex Lines	48 (max.) loop start (12 per CO1 2 board)
Digital Terminal Stations	96 (max.) Digital Terminals (12 per KT12 board)
Standard Single Line Telephones	84 (max.) Standard 2500 type SLTs (12 per SL12 board)
Off-Premise Extensions	96 (max.) OPX Stations (1 per single line adapter (OPX))
Paging: (one way paging)	
Internal Paging	4 (max.) internal Page Zones (software controlled)
External Paging	7 (max.) One zone per KT12 board.
DTMF Receivers:	12 (max.) per system (one 4-ckt card on each SL12 board) (up to a max of 3 SL12 boards w/DTM4's can be installed in the system)
DTMF Sender:	1 per system (time shared)
I/O Ports:	3 (max.) per system (one RS-232C included on CPU) and two RS-232C on optional Backplane I/O module
Contacts/Sensors (Relay Sensor Module)	4 Relay/Sensor Modules per system. Each Relay/Sensor Module has 3 relays and 3 sensing circuits.
Conference:	
Circuits	31 Conference "bridges" per system
Parties per "bridge"	5 parties per "bridge"
DISA Circuits:	An unlimited number of CO Lines may be programmed simultaneously.
Attendants:	Up to 3 stations can be designated as attendant(s).
Digital DSS/DLS Consoles:	72 (max.) Up to 3 DSS/DLS units can be programmed to function with each station. Each DSS/DLS unit reduced station capacity by 1. (96 Ports ÷ 4 = 24 ports. 24 ports x 3 = 72 ports used for DSS Consoles)
Hunt Groups:	
Groups:	Software supports up to 8 groups.
Members:	Software supports up to 8 stations in each group.
Types:	Station or Pilot Hunting
ACD Groups:	
Groups:	Software supports 16 Groups.
Members:	Software supports up to 16 stations per group.
RAN Announcements:	Eight RAN Announcements with any two per ACD Group.
Calls in Queue:	All CO Lines may be in queue for an ACD Group.
UCD Groups:	
Groups:	Software supports 8 Groups.
Members:	Software supports up to 8 stations per group.
RAN Announcements:	Eight RAN Announcements per UCD Group.
Calls in Queue:	All CO Lines may be in queue for an UCD Group.
Voice Mail Groups:	
Groups:	Software supports 8 Groups.
Members: (ports)	Software supports up to 8 stations per group.
Integration Method:	In-Band Signaling. (DTMF)
VM Message Wait:	[420] to turn message waiting on, [421] to turn message waiting off.
VM Disconnect Signal:	Programmable 12-digit (DTMF) string. If no digits are programmed, 15 seconds of silence followed by busy tone.
Loop Supervision Disconnect	700 msec duration.(CO or Internal call to SLT)

**Table 400-2 Electrical Specifications**

AC Input to Power Supply:	117V ac $\pm$ 10%, 60 Hz single phase
Power Consumption:	<b>120V ac @ 750VA max.</b> 430 watts maximum (per power supply)
Power Supply Fuse - AC input	1 OA, 250V ac
Longitudinal Balance:	Better than 60db from 200 Hz to 1,000 Hz Better than 40db from 1,000 Hz to 4,000 Hz
Idle Channel Noise:	Less than 15 dbrnc for all connections
Cross Talk Attenuation:	Greater than 75dbm Station to CO and Station to Station
Single Frequency Distortion: (300 Hz - 3400 Hz)	Station to CO Line and Station to Station: Better than 2.0% or 34db Output level -30 dbm to 0 dbm
Ringling Sensitivity:	16 Hz to 30 Hz at 40 VRMS minimum 30 Hz to 67 Hz at 50 VRMS minimum
Ringer Equivalence Number: (REN)	1.9B
CO Line Signaling - DTMF:	Frequency pair at -5 dbm to 0 dbm Frequency tolerance, better than $\pm$ 1.5%
Music Source (input)	0 dBm max. at 600 ohms input impedance
Contact Rating Multi Purpose Relay	1 .0A, 24V dc
External Page Port Output Impedance Output Power w/o compression	600 ohms @ 0 dBm 1 mW Maximum
Single Line Adapter (OPX)	Each OPX box requires .5 amps of current.
Battery Backup (UPS) Specifications*: Maximum Current Drain: (per system)	750VA min., Sine-wave output, on-line type 550 watts
UL File Number:	EI 09461

\* End user must determine battery size needed for desired backup time.

**Table 400-3 Environmental Specifications**

Operating Temperature	32 <sup>o</sup> to 104 <sup>o</sup> F
Recommended Operating Temperature	60 <sup>o</sup> to 80 <sup>o</sup> F
Storage Temperature	-40 <sup>o</sup> to 140 <sup>o</sup> F
Relative Humidity	5% to 95% non-condensing
Heat Dissipation (BTU's)	1200 BTU's per power supply (maximum)

## GENERAL DESCRIPTION

Table 400-4 Loop Limits

Electronic Telephone: (including <b>DSS/DLS</b> Console)	1000 feet of 26 <b>AWG</b> Cable 1000 feet of 24 <b>AWG</b> Cable 1000 feet of 22 <b>AWG</b> Cable
Standard Single Line Telephones	<b>2000</b> feet of 24 AWG Cable
Off-Premise Extensions (OPX) (Adapter to SLT)	1400 Ohms maximum loop, not including telephone.

Table 400-5 Dialing Specifications

DTMF Dialing	
Frequency Deviation	±1.5%
Rise Time	5 msec.
Duration of DTMF Signal	7.5 msec. minimum
Interdigit Time	75 msec. minimum
PULSE Dialing	
Pulse Dialing Rate	10 or 20 pps.
Pulse Break/Make Duration	60/40 or 66/33
CO Type	Loop Start, 600 ohm, current sensing

Table 400-6 FCC Registration Numbers

For Systems configured as a key system (button appearance) use:	DLPHKG-74722 KF-E
For Systems configured as a hybrid system (dial access codes) use:	DLPHKG-74723-MF-E

Table 400-7 Trunk Ordering Info: Public Network Lines

SYSTEM PORT IDENTIFICATION, FACILITY INTERFACE & SERVICE ORDER CODES			
INTERFACE CARD	R I N G E R EQUIVALENT NUMBER (REN)	FACILITY LINE INTERFACE	JACK TYPE
co Port:	1.9	02LS2	RJ21 X
Off-Premise Extension: (OPX)		OL13C	RJ21 X

**Table 400-8 Dimensions and Weight**

<b>KEY SERVICE UNIT</b>		<b>34-BUTTON ENHANCED TERMINAL</b>	
Height	16"	Height	3.5"
Width	26"	Width	7.625"
Depth	15"	Depth	9.625"
Weight	42 lbs. (unloaded)	Weight	3 lbs.
<b>POWER SUPPLY</b>		<b>34-BUTTON EXECUTIVE DISPLAY TERMINAL</b>	
Height	14.5"	Height	3.5"
Width	7.25"	Width	7.625"
Depth	6"	Depth	9.625"
Weight	19.5 lbs.	Weight	3 lbs.
<b>OFF-PREMISE EXTENSION MODULE (OPX)</b>		<b>14-BUTTON BASIC TERMINAL</b>	
Height	1.75"	Height	3.5"
Width	7.625"	Width	7.625"
Length	8.0"	Depth	9.625"
Weight	3.5 lbs.	Weight	2.0 lbs.
<b>RELAY/SENSOR MODULE/DDIU UNIT</b>		<b>DSS/DLS CONSOLE</b>	
Height	1.75"	Height	3.0"
Width	7.625"	Width	7.625"
Length	8.0"	Depth	9.625"
Weight	3.5 lbs.	Weight	2 lbs.
<b>TRI-OUTPUT SUPPLY</b>			
Height	9"		
Width	4"		
Length	8.25"		
Weight	10 lbs.		

**Table 400-9 Miscellaneous Specifications**

Memory:	
Programmable Read-Only Memory (EPROM)	512K expandable to 4 Megabytes
Random Access Memory (RAM):	256K expandable to 2 Megabytes
Telephone Transmitter:	Electret mic compatible.
Talk Paths:	
CO/PBX/Centrex paths:	48 CO/PBX Centrex talk paths (non-blocking)
Intercom Paths:	Non blocking
Music Channels:	2 channels provides for music-on-hold and background music
Account Codes:	
Number of digits per account code:	up to 12 unverified digits
Number of Account Codes:	unlimited (unverified)
Speed Dialing Memory:	
Station Speed Dial:	20 bins per station (24-digits)
System Speed Dial:	80 bins per system (24-digits)
Total speed dial bins:	1980 speed locations to be divided among all telephones.

Table 400-10 Digital Terminal Audible Signals

TYPE OF SIGNAL	FREQUENCY	SIGNAL DURATION
<u>Key Telephone Signals:</u>		
Incoming CO line	1215/1471	0.8s on/2.4s off; repeated
Intercom Tone Ringing	1215/1471	0.4s on/0.4s off/0.4s on/2.0s off
Intercom Call Announce (H-P)	935	0.2s on/0.2s off (2 bursts)
Transferred CO Line	1215/1471	0.8s on/2.4s off
CO Line Recall	1215/1471	0.2s on/.6s off, repeated
Message Wait Call Back	1215/1471	0.4s on/0.4s off/0.4s on/2.0s off
Message Wait Reminder Tone	771	0.6s on (timed)
CO Queue Call Back	1215/1471	0.2s on/0.6s off; repeated
Camp-on	1215/1471	0.2s on (1 burst)
Paging Alert Tone	935	1 sec. (1 burst)
<u>Key Telephone Confidence Tones:</u>		
Intercom Ringback	701	0.4s on/0.4s off/0.4s on/2.0s off
Call Announce	935	0.2s on/0.2s off (2 bursts)
Busy Tone	701	0.4s on/0.4s off, repeated
Error Tone	701	0.2s on/0.2s off, repeated
Intercom Dial Tone	421	Continuous
DND Tone	701	0.2s on/0.2s off, repeat 3x's, pause, 0.6s repeat
Paging Confirmation	935	1 sec burst
Programming Confirmation	1471	1.4 sec burst
Programming Error	1471	0.2s on/0.2s off, 6x's
Confirmation Tone	1471	1.4 sec burst. 1 time

Table 400-1 1 Single Line Telephone Audible Signals

TYPE OF SIGNAL	FREQUENCY	SIGNAL DURATION
<u>Single Line Signals:</u>		
incoming CO Line	30 Hz, 50-90V AC	2.0s on/4.0s off
Intercom Tone Ringing	30 Hz, 50-90V AC	1.0s on/0.2s off/0.8s on/4.0s off
Transferred CO Line	30 Hz, 50-90V AC	2.0s on/4.0s off
CO Line Recall	30 Hz, 50-90V AC	2.0s on/4.0s off
CO Queue Call Back	30 Hz, 50-90V AC	2.0s on/4.0s off
<u>Single Line Confidence Tones:</u>		
Intercom Ringback	440+480	1.0s on/3.0s off; repeated
Call Announce	420	0.2s on/0.2s off (3 bursts)
Busy Tone	480+620	0.5s on/0.5s off; repeated
Error Tone	480+620	0.25s on/0.25s off; repeated
intercom Dial Tone	420	Continuous
DND Tone	480+620	0.2s on/0.2s off, repeat 3x's, pause, 0.5s; repeated
Paging Time-out	480+620	0.5s on/0.5s off; repeated
Call FWD Warning Tone	420	0.2s on/0.2s off (six times)
Camp-on Tone	420	0.2s burst (1 time)
Conference Warning Tone	420	1 sec burst (1 time)
Confirmation Tone	420	1.4 sec burst (1 time)
DND Warning Tone	420	0.2s on/0.2s off (6 bursts)

Table 400-12 OPX Telephone Audible Signals

TYPE OF SIGNAL	F R E Q U E N C Y	SIGNAL DURATION
<u>OPX Signals:</u>		
incoming CO tine	30 Hz, 50-90V AC	2.0s on/4.0s off
Intercom Ringing	30 Hz, 50-90V AC	2.0s on/4s off
Transferred CO Line	30 Hz, 50-90V AC	2.0s on/4.0s off
CO Line Recall	30 Hz, 50-90V AC	2.0s on/4.0s off
CO Queue Call Back	30 Hz, 50-90V AC	2.0s on/4.0s off
<u>OPX Confidence Tones:*</u>		
Intercom Ringback	440+480	1 s on/3s off
Busy Tone	480+620	0.5s on/0.5s off; repeated
Error Tone	480+620	0.25s on/0.25s off, repeated
intercom Dial Tone	350+440	Continuous
DND Tone	480+620	0.2s on/0.2s off, repeat 3x's, pause, 0.5s; repeated
Paging Time-out	420	0.5s on/0.5s off
Call FWD Warning Tone	420	0.2s on/0.2s off (six times)
Camp-on Tone	420	0.2s burst (1 time)
Conference Warning Tone	420	1 sec burst (1 time)
Confirmation Tone	420	1.4 sec burst (1 time)
DND Warning Tone	420	0.2s on/0.2s off (6 bursts)
*Precise Tone Plan		

## GENERAL DESCRIPTION

Table 400-13 DSS/BLF Button Visual Indicators

TYPE OF SIGNAL	INDICATOR FLASH RATES
Off-Hook/Busy (All Stations)	Steady
Incoming Intercom Ring (Destination)	120 ipm flutter (Default)
Call Announce (Destination)	steady
Message Waiting Call Back (Destination)	120 ipm flutter
Do Not Disturb (All Stations)	480 ipm triple wink
Automatic Call Back (Destination)	120 ipm flash
ACD/UCD Available/Unavailable	60 ipm flash
ACD Overflow Station Available/Unavailable	60 imp flash

Table 400-I 4 CO Line Button Visual Indicators

TYPE OF SIGNAL	INDICATOR FLASH RATES
Incoming CO Ring	30 ipm flash (Default)
Transferred CO Ring	120 ipm flash
Recall	480 ipm flutter
Queued Line	480 ipm flutter
Exclusive Hold	120 ipm flash
System Hold	60 ipm double wink
I-Hold (only when hold preference is system)	60 ipm wink
In Use	Steady

Table 400-I 5 Function Button Visual Indicators

TYPE OF SIGNAL	INDICATOR FLASH RATES
Call Forward (active)	30 imp flash (Default)
Message Waiting (active)	15 ipm flash (Default)
Camp-on (active)	120 ipm flash
Call Back (active-initiator)	120 ipm flash
CO Line Queue (active)	480 flutter
Do Not Disturb (DND active)	60 ipm flash
Mute (microphone off, handset xmit off)	Steady
ON/OFF (speakerphone on/on-hook dialing)	Steady
Conference (active)	Steady
Speed (momentarily ON until bin address dialed)	Steady
Personalized Messages	15 ipm flash
Intercom Call (Hold Button)	15 ipm flash
Loop	Same as CO Line buttons
Pool	Same as CO Line buttons
Transfer	Steady until transfer complete



## SECTION 500 INSTALLATION

### 500.1 SITE PLANNING

Selection of a suitable location is the most basic, yet most critical consideration in the installation of a telephone system. The following should be considered when choosing an appropriate location for equipment installation:

- Ample space must be allowed to remove the KSU cover, to access assemblies and cards within the cabinet and allow space for the MDF (Main Distribution Frame).
- Location of CO/PBX line terminations must be considered when selecting a location for the KSU. In the case of telephone company line, FCC approved connectors supplied by the telephone company, should be within 5 feet (1.5 meters) of the cabinet/main distribution frame.
- To minimize the length of cable runs between the stations and the system KSU, the location of the majority of the telephone sets (stations) should be taken into consideration when selecting a location for the cabinet.
- A well ventilated, and well lighted area having an optimum temperature range of 60 degrees to 80 degrees F and a relative humidity range of 5 to 90% (non-condensing) must be provided.
- Area lighting should be adequate for installation and maintenance of the system. Hazardous or flammable materials should be removed from the vicinity. The immediate area must not be subject to flooding or excess moisture. The KSU should be isolated from areas of moving machinery or equipment. It is also recommended that static electricity-producing carpets not be installed in this area.
- A separately fused, dedicated 117V ac,  $\pm 10\%$ , 15 Amp., 60 Hz, single phase, 3-wire (parallel blade with ground) power outlet should be located within 5 feet (1.5 meters) of the system power supply.
- The KSU and main distribution frame should be placed in an electrically noise free environment, isolated and shielded from equipment that causes electro-magnetic interference (EMI) or radio frequency interference (RFI). Examples of electrical

noise are rotating electrical machinery and arc welding equipment, refrigerators, copy machines, etc. Floor coverings that generate static electricity should also be avoided.

- The system KSU should not be installed close to any equipment which may produce RFI (Radio Frequency Interference) such as a radio frequency transmitter, or microwave oven.
- If the system is to be installed in a location prone to lightning strikes, provide lightning protection on the power line, any station cable runs outside the building, and CO lines.

#### A. System Grounding

To ensure that the system will operate properly, a good earth ground is required. Use of the Telco ground (source not demark) or a metallic COLD water pipe usually provides a reliable ground path. Carefully check that the pipe does not contain insulated joints that could isolate the ground. In the absence of the COLD water pipe, a ground rod or other source may be used. A No.14 AWG copper wire should be used between the ground source and the KSU (25 feet maximum). The farther from the ground source, the larger the ground wire used should be. The wire should be kept as short as possible and can be connected to the ground lug provided on the lower left side of the backplane on the KSU with the cover off.

#### B. Lightning Protection

The Starplus Digital Key Telephone System should have Central Office lines, Single Line Telephones and Off-Premise Extension stations protected with proper lightning surge arrestors. This will provide protection from damaging surges on sensitive cabling by non-direct lightning strikes.

The protection should contain a compliment of three-element gas-discharge tubes to ground high potential surges, and associated circuits to absorb and filter lower level surges. This type of lightning protection is available through telephone equipment supply houses. Care should be taken to ensure that such protection devices are installed in accordance with the manufacturers instructions and to ensure that no more than one set of protectors be installed on central office lines at the installation premises. Im-

## INSTALLATION

proper installation can be a serious safety hazard.

Failure to provide the proper lightning protection will increase maintenance expense and require more available spare parts.

### 500.2 INSTALLATION PLANNING FOR THE SPD 4696 SYSTEM

Prior planning of the installation will aid in a smooth cut-over and a satisfied customer. Select a suitable location for the system. Determine the number of telephones of each type, and the number of Key Telephone Boards (KT12), Single line Telephone Boards (SL12) from the sales contract and discussions with the customer. Refer to Figure 500-I Basic KSU Cabinet Mounting Arrangement for additional information.

#### NOTE

*Only one station set is allowed per digital extension number. It is not possible to bridge digital station ports so that an extension number may appear in more than one location.*

- Programming information should also be gathered from the customer at this time so that the system may be programmed either before, or while the system is being installed.
- Determine the location and type of each telephone, and mark floor plans accordingly.
- Determine the location for the operator stations, and mark the floor plans.
- Arrange for power cabling (if necessary) and station cabling of the site.
- If the system is to be installed in an area subject to frequent lightning storms, consideration should be given to providing additional lightning protection on the CO lines beyond what is provided by the local telephone operating company.

#### NOTE

*Installers should be trained and thoroughly familiar with the basic components of the system before attempting installation of this product*

### 500.3 SYSTEM COMPONENTS FOR THE SPD 4696 SYSTEM

#### A. Equipment Cabinet With Power Supply (KSU)

The KSU is wall mounted. It is of metal construction with a backplane motherboard that has 23 card slots. The CPU card is inserted into the CPU card slot. Slots 2, 3, and 4 are reserved for future common cards. The VCB card is inserted into the VCB slot. The remaining slots are designated Slots 1 thru 19 for peripheral cards. The system defaults to a configuration

that designates peripheral slots 1, 2, 3 and 4 for Station boards, peripheral slots 5, 6, 7 and 8 are for CO boards, and peripheral slots 9, 10, 11 and 12 for the remaining station boards. Refer to figure 500-2 Basic KSU Equipment Cabinet for circuit board layout and location of connectors.

#### Grounding:

A No. 14 AWG copper wire should be used to connect a ground between the ground source and the KSU (25 feet maximum). A two position terminal strip (J25) is located on the lower left corner of the mother board and is accessible through the right side of the KSU. One terminal position can be used to connect the ground wire from a ground source.

#### Power Supply:

The system KSU is powered by modular power supplies that are mounted on the sides of the cabinet. The cabinet is divided so that one power supply will support a system configured with up to 48 CO lines and 60 stations (key or SLT). If the CO line or station requirements exceed the aforementioned configuration, the second power supply is needed. The power supplies provide the system with 24V power. They are plugged into a 120V ac circuit. The power supply and cabinet meet all safety requirements to comply with UL 1459 Second Edition and CSA C22.2 No. 225 standards.

The power supply is recognized under the Component Program of Underwriters Laboratories Inc.

#### B. Cabinet Installation

Once the area for the telephone equipment has been selected, mount a plywood back board to the wall. The back board size will vary depending upon the size of the MDF. The entire system and frame can be mounted on a 4' x 6' x 3/4" plywood. A fully loaded cabinet can weigh approximately 130 lbs. Make certain proper mounting procedures are followed.

#### NOTE

*Check local building and electrical codes before mounting the system. For example, certain areas may require a flame retardant plywood back board.*

1. Mount the cabinet to the plywood using 3/4" #12 pan-head sheet metal screws such that the top of the cabinet is approximately three feet (1 meter) from the ceiling, and bottom is at least six feet (1.8 meters) from the floor. Make certain before mounting the cabinet that circuit cards slide easily in and out of their respective card slots.
2. Use the mounting template supplied with the

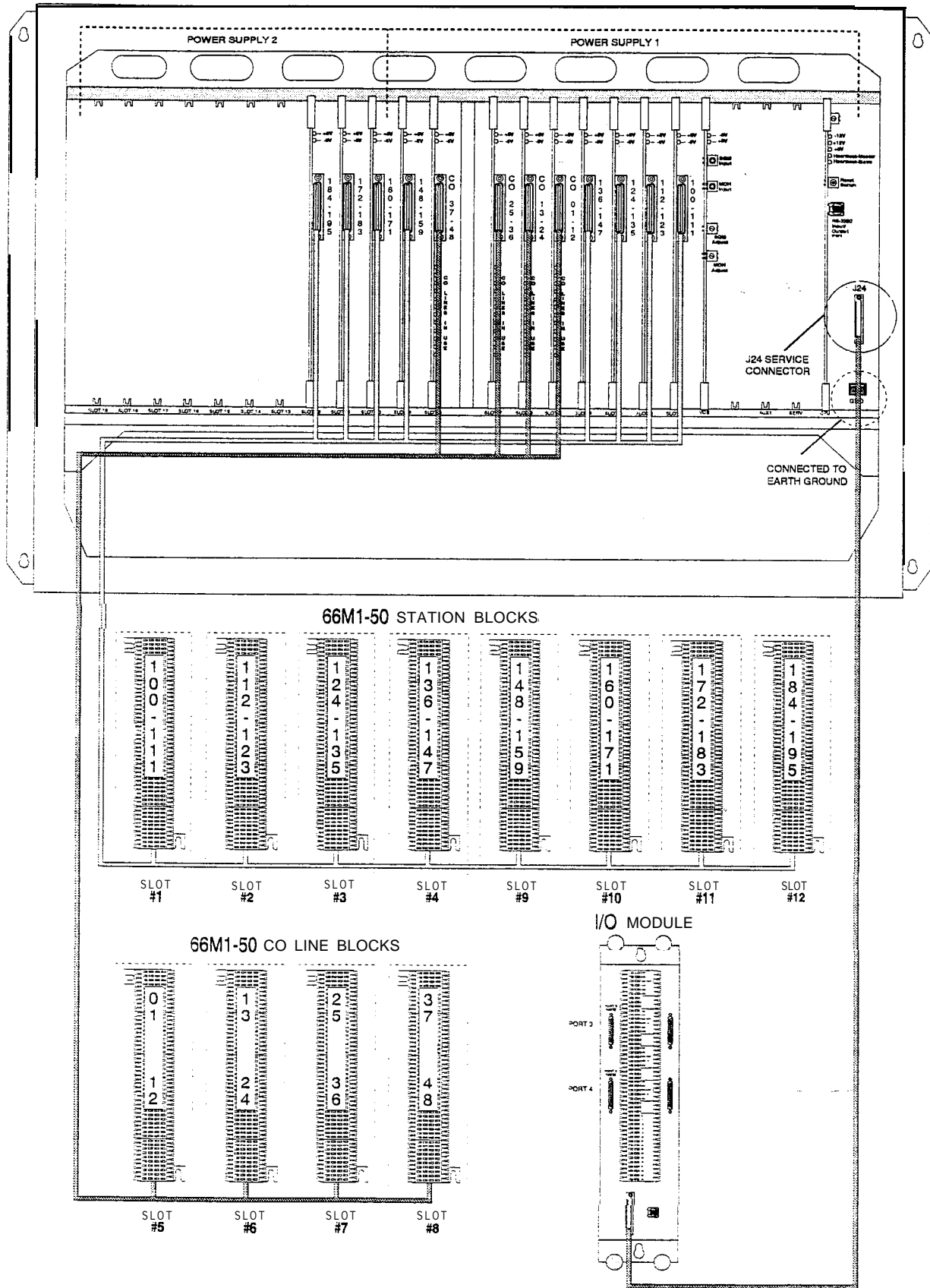

Figure 500-I Basic KSU Cabinet Mounting Arrangement

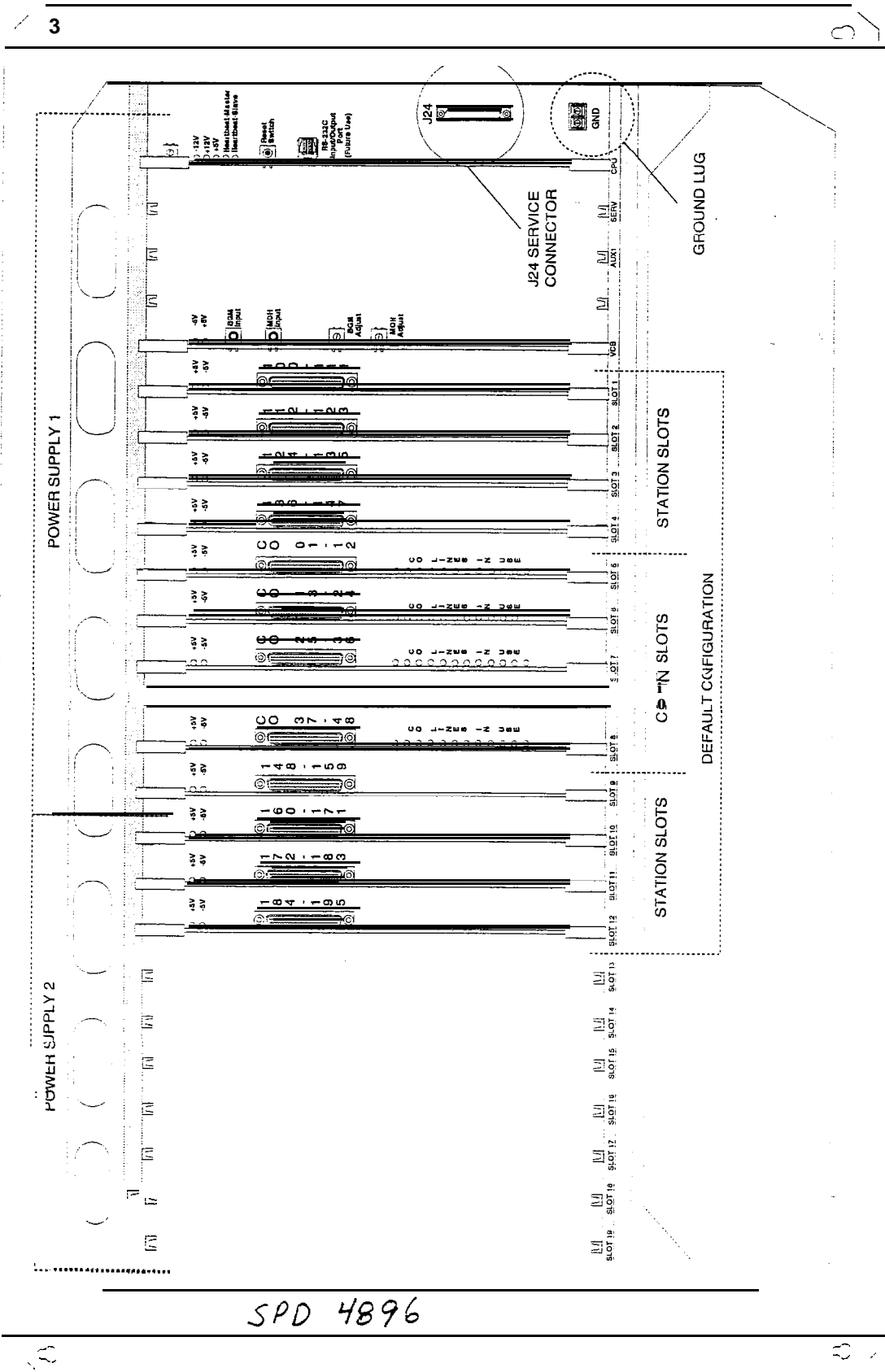

Figure 500-2 Basic KSU Equipment Cabinet

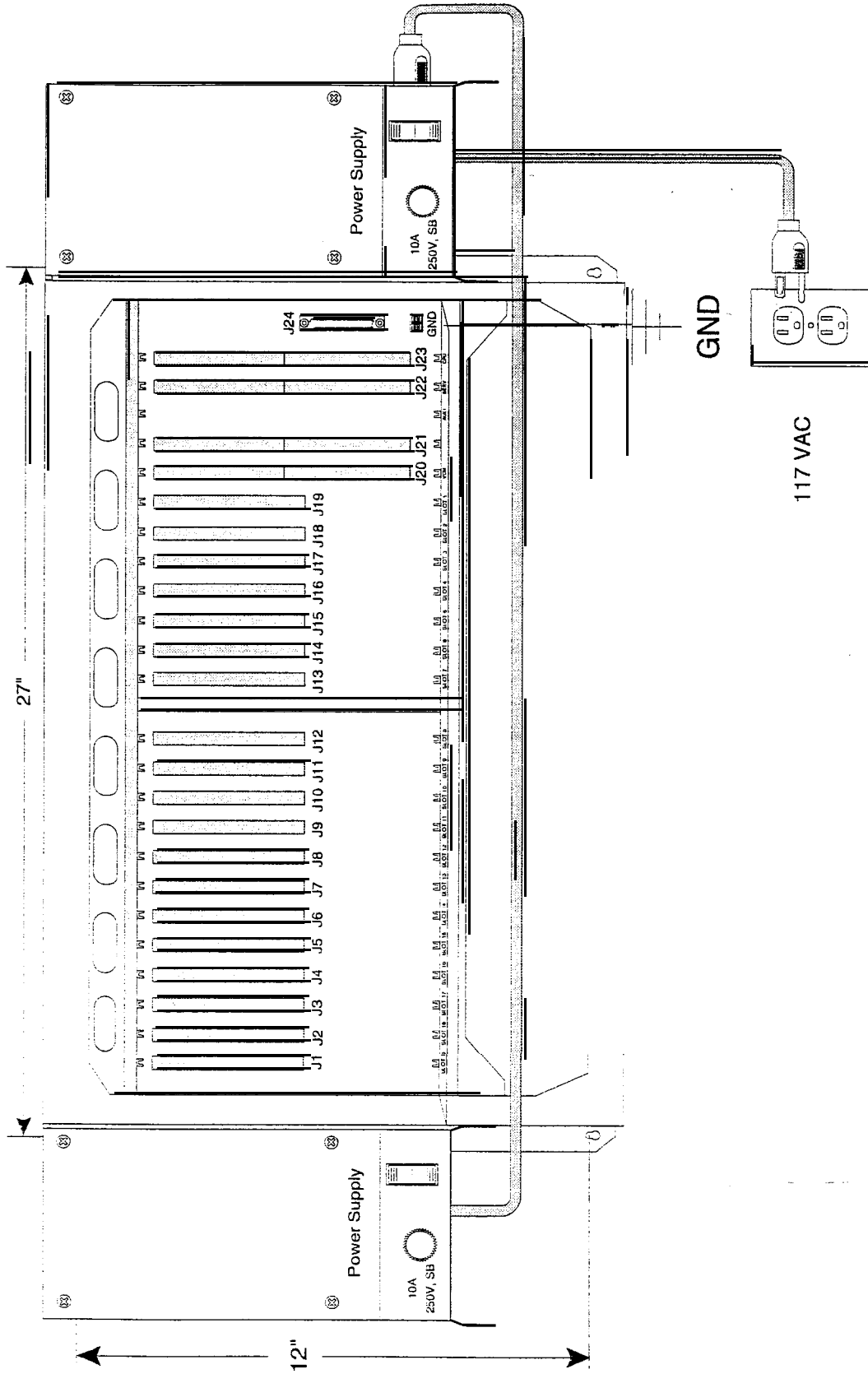

Figure 500-3 Basic KSU Cabinet Mounting Dimensions

## INSTALLATION

cabinet to locate the mounting holes. Also refer to Figure 500-3 Basic KSU Cabinet Mounting Dimensions.

**NOTE** This is a construction technique for mounting to concrete, plasterboard, or wooden surfaces. Proper mounting is the responsibility of the installer.

3. Drill the holes and mount the cabinet.

### C. Central Processor Unit (CPU)

This plug-in card is one of two common equipment cards required to make the system operational. The CPU card controls all system activity. The CPU contains the main micro-processor a 16-bit (68302), the slave micro-processor (another 68302), and a real time clock. The master and slave CPU chips are connected via a serial communications link. The CPU is responsible for all control functions, execution of all logic operations, and control of system modules. Refer to Figure 500-4 Central Processor Unit (CPU). The master CPU also provides software and hardware support to ensure the following:

- Watch dog timer and recovery.
- State/Event software design.
- Battery Backup of Customer Database RAM memory.

The slave CPU ensures the following signal processing functions are done:

- PCB status as to presence/absence of cards for automatic software configuration setup.
- Interpret an ID code from each PCB so that card type can be determined automatically.
- Process interrupts from peripheral cards and scan VCB.

In addition, there is one RS-232C (modular connector) input/output port on the CPU and a connector to support the use of an optional Backplane I/O Expansion Module. The Backplane I/O Expansion Module adds two RS-232C I/O ports to the system for a system total of three I/O ports. A reset (halt) push button switch is located on the front of the PCB.

System software is provided in EPROM memory and is installed on the CPU. The CPU contains 512 kilobytes (expandable to 4MB) of EPROM memory storage and is equipped with 256K of battery-backed static RAM (expandable to 2MB). Provisions have been made on the card to address up to four megabytes of EPROM memory and up to two megabytes of

static RAM.

- A Battery jumper strap is located on the CPU board. Jumpering from pins 1 & 2 disables the Battery Backup. Between pins 2 & 3 enables the Battery Backup option.
- The CPU allows the use of either 1 Megabit or 4 megabit static RAM chips to be used for RAM memory.

**NOTE** When two power supplies are installed on the same system and you want to remove the Central Processor Unit from service, **BOTH** power supplies **MUST** be turned off!

### LEDs & Indicators:

Three green LEDs located along the front edge of the CPU provide an indication of the presence of -12V dc, +12V dc & +5V dc. Two red LEDs provide the system heartbeat indications.

### I/O Ports - Wiring/Pinouts/Connections:

The Central Processor Unit contains one RS-232C, 8 pin modular jack type connector, I/O port (future) located near the front edge of the PCB. This I/O port will be capable of transmitting and receiving data at 300, 1200, 2400, 4800, and 9600 baud rates.

In the future, this I/O port can be used for SMDR output, Remote programming thru a data terminal or PC, ICLID output, or interfacing with a customer developed ACD Reporting software package. Refer to Figures 500-5 and 500-6 for additional information.

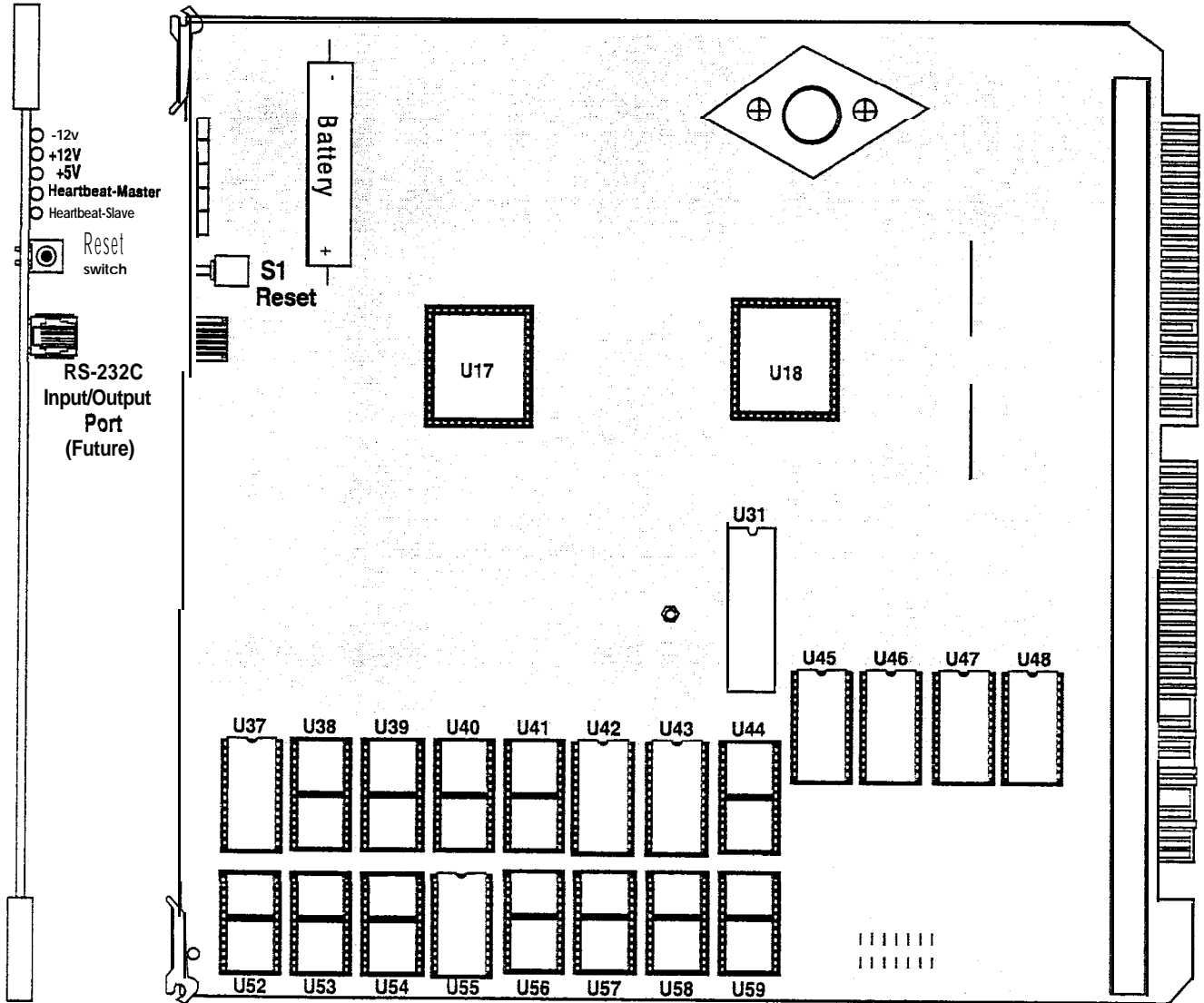
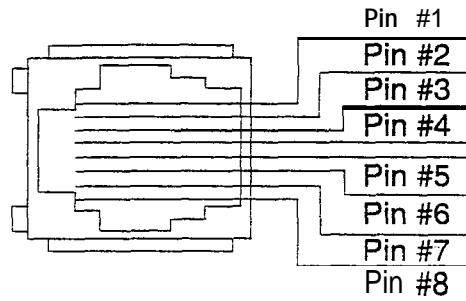
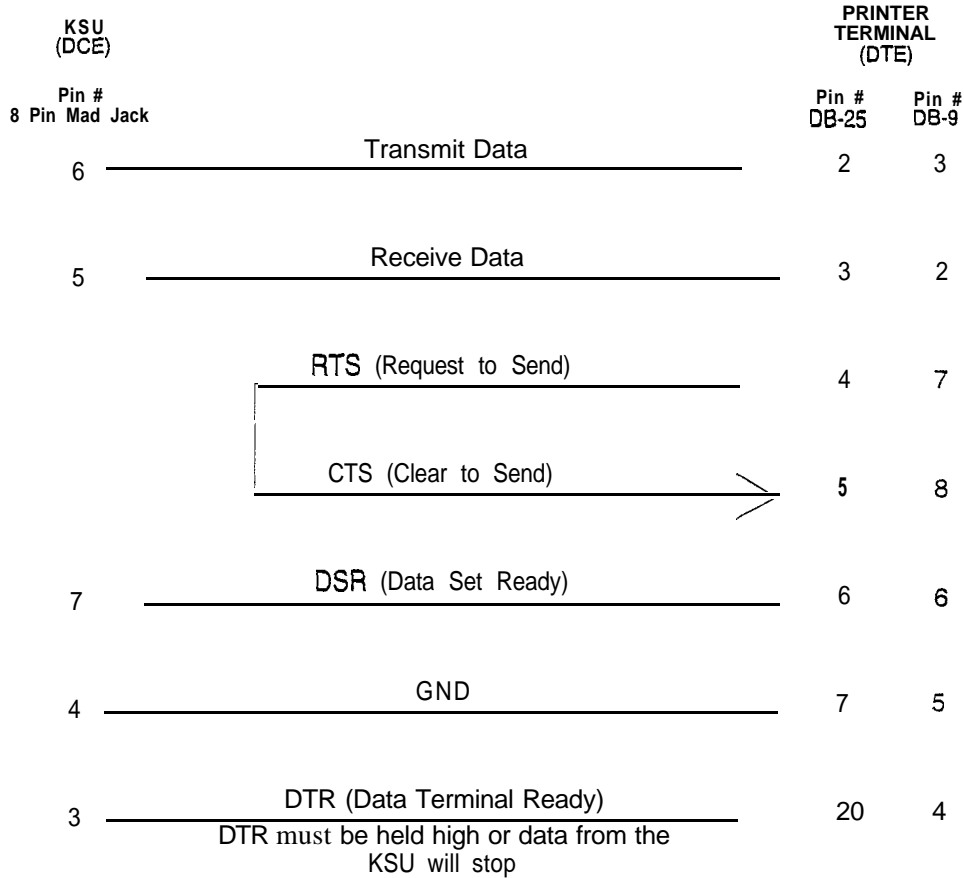

Figure 500-4 Central Processor Unit (CPU)



CPU I/O 8 Pin Modular Jack Pinout



RS-232C PINOUT

Data Communication Requirements are:

- A) Serial Port Compatible
- B) ASCII Code Compatible
- C) 8 Data Bits and 1 Stop Bit
- D) No Parity
- E) Flow Control Method: Xon/Xoff

NOTE: Arrows show flow control direction.

Figure 500-5 RS-232C Printer Connections on CPU Board



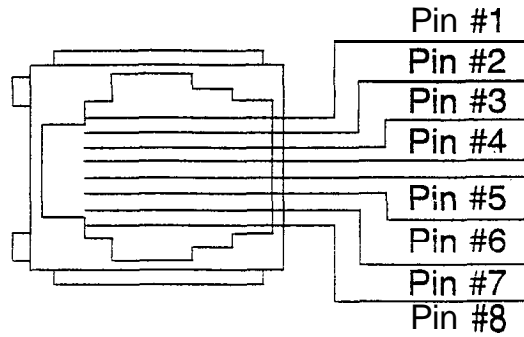

CPU I/O 8 Pin Modular Jack Pinout

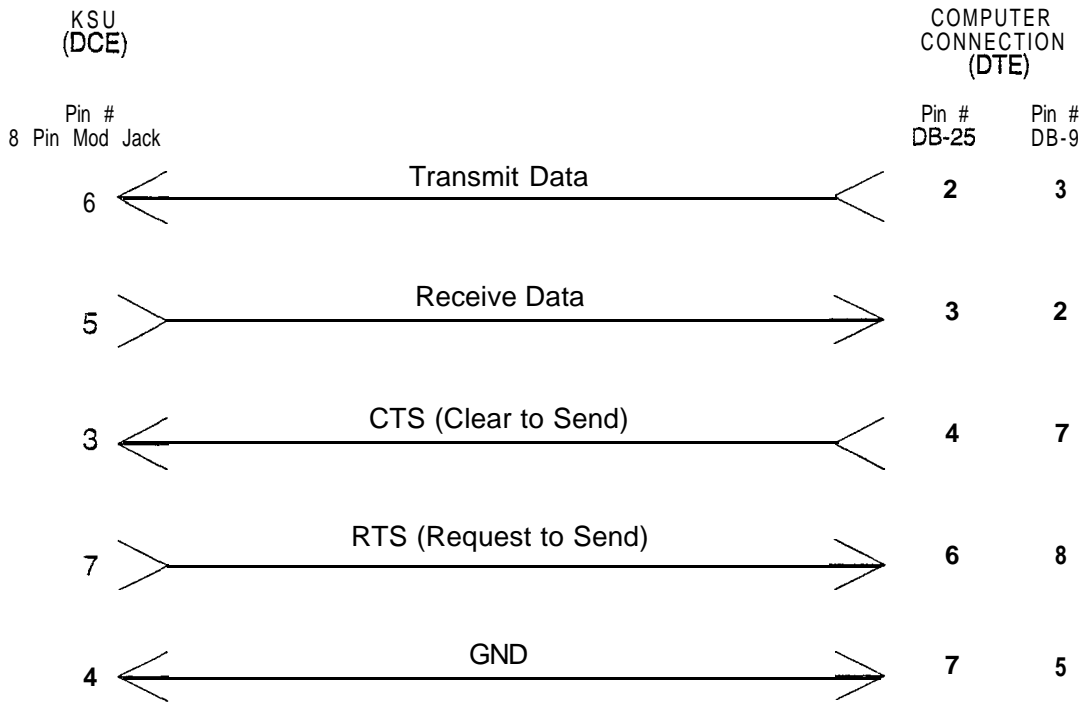

RS-232C PINOUT

Data Communication Requirements are:

- A) Serial Port Compatible
- B) ASCII Code Compatible
- C) 8 Data Bits and 1 Stop Bit
- D) No Parity
- E) Flow Control Method: Xon/Xoff

NOTE: Arrows show flow control direction.

Figure 500-6 RS-232C Computer Connections on CPU Board

INSTALLATION

D. Voice Control Board (VCB)

The Voice Control Board (VCB) provides the time slot switch to control the digital switching information. The system tones are also generated on this board.

LEDs & Indicators:

There are two LEDs on the board to indicate the +5V dc and -5V dc.

Modem Interface:

The Voice Control Board (VCB) contains an "On-Board" modem that is capable of transmitting data at a rate of 1200 baud. The modem supports and is compatible with the Hayes command protocol.

The Bell System (Western Electric) standards 103 and 212A for design is incorporated into the design of this . The operates on-line in both Full and Half duplex modes.

Wiring / Pinouts / Connections:

There are two phono input connectors on the board. One connector is for background music and the other is for music on hold. There are also two potentiometers to adjust each music source.

**NOTE** When *two power supplies are installed on the same system and you want to remove the Central Processor* Unit from service, *BOTH power supplies* MUST be *turned off!*

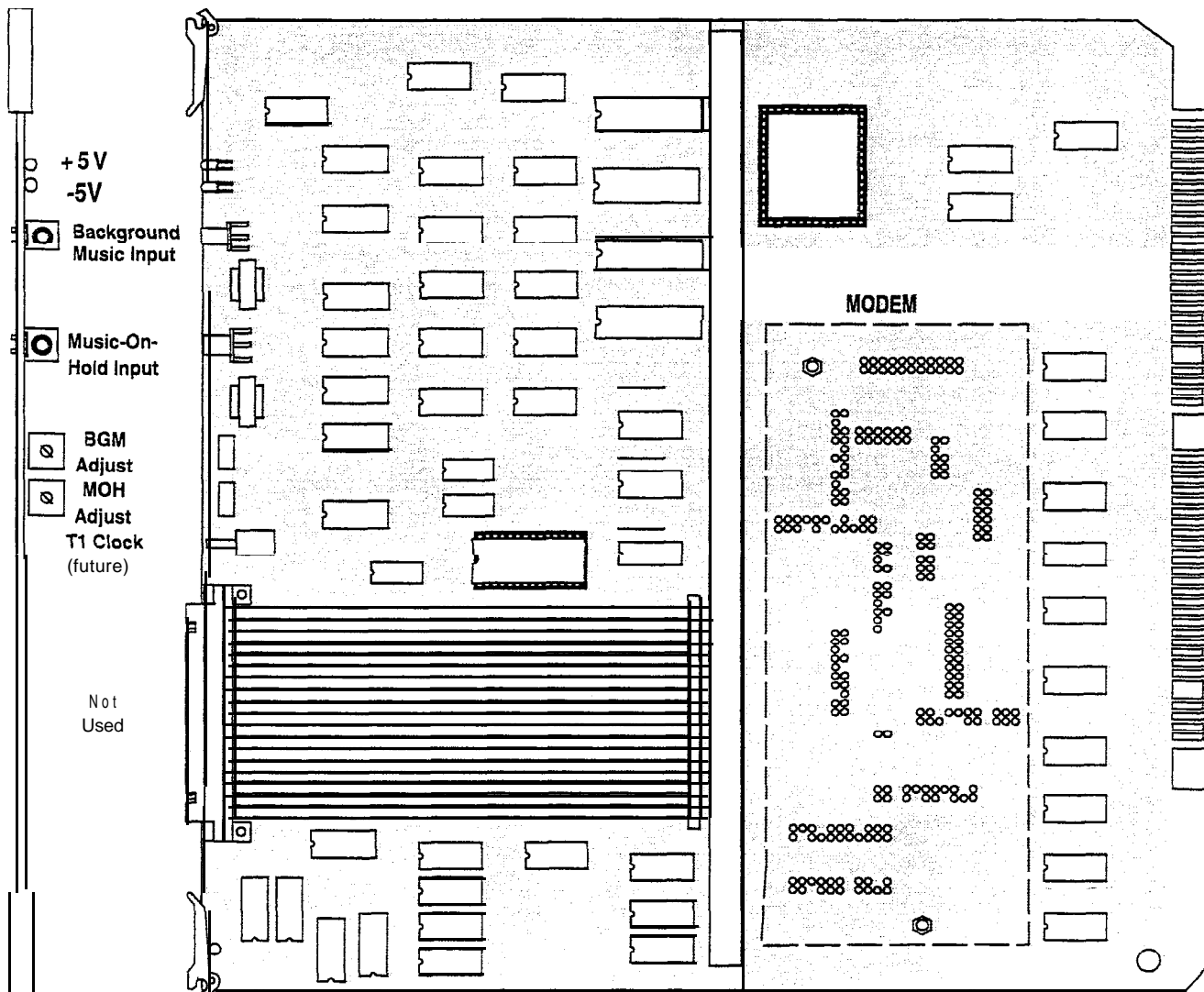

Figure 500-7 Voice Control Board (VCB)

**E. Key Telephone Board (KT12)**

This board provides the interface to twelve digital telephones. This board can be plugged into any designated station slot. Refer to Figure 500-8 Key Telephone Board (KT12) for location of connectors.

**LEDs & Indicators:**

The board contains two LEDs to indicate the presence of +5V dc and -5V dc. The LEDs are located on the top portion of the board.

**Line/Station Interfaces:**

The board has one mate **50-pin amphenol** connector on the front edge. This will interface the circuits on the board to the MDF.

The card also provides proper fusing or protection to comply with the requirements of UL 1459 Second Edition and CSA C22.2 No. 225 standards.

A Digital DSS Console, a Single Line Telephone Adapter (OPX), or other specifically designed adapter with a digital interface can be assigned to any one of the interface circuits. The Key Station interface circuits are protected from mis-wiring and over-current.

<b>NOTE</b>	<i>External Paging Zones start from Card Slots 1 thru 4 for External Paging Zones 1 thru 4. Card Slots 9 thru 11 represent External Paging Zones 5 thru 7. If a Single Line Board (SL12) is inserted between two Key Station Boards (KT12), the External Paging Zone associated with that card slot becomes unusable.</i>
-------------	---

**Table 500-I Key Telephone Board (KT12)**

PAIR	PIN	COLOR	DESIG
1	26	WH/BL	Port 001 Xmt Tip
	1	BL/WH	
2	27	WH/OR	Rcve Tip
	2	OR/WH	
3	28	WH/GN	Port 002 Xmt Tip
	3	GN/WH	
4	29	WH/BN	Rcve Tip
	4	BN/WH	
5	30	WH/SL	Port 003 Xmt Tip
	5	SL/WH	
6	31	RD/BL	Rcve Tip
	6	BL/RD	
7	32	RD/OR	Port 004 Xmt Tip
	7	OWRD	
8	33	RD/GN	Rcve Tip
	8	GN/RD	
9	34	RD/BN	Port 005 Xmt Tip
	9	BN/RD	
10	35	RD/SL	Rcve Tip
	10	SL/RD	
11	36	BWBL	Port 006 Xmt Tip
	11	BL/BK	
12	37	BK/OR	Rcve Tip
	12	OR/BK	
13	38	BK/GN	Port 007 Xmt Tip
	13	GN/BK	
14	39	BWBN	Rcve Tip
	14	BN/BK	
15	40	BK/SL	Port 008 Xmt Tip
	15	SL/BK	
16	41	YL/BL	Rcve Tip
	16	BL/YL	
17	42	YL/OR	Port 009 Xmt Tip
	17	OR/YL	
18	43	YL/GN	Rcve Tip
	18	GN/YL	
19	44	YUBN	Port 010 Xmt Tip
	19	BNNL	
20	45	YL/SL	Rcve Tip
	20	SL/YL	
21	46	VI/BL	Port 011 Xmt Tip
	21	BL/VI	
22	47	VI/OR	Rcve Tip
	22	OR/VI	
23	48	VI/GN	Port 012 Xmt Tip
	23	GN/VI	
24	49	VI/BN	Rcve Tip
	24	BN/VI	
25	50	VI/SL	External Page Tip
	25	SL/VI	External Page Ring

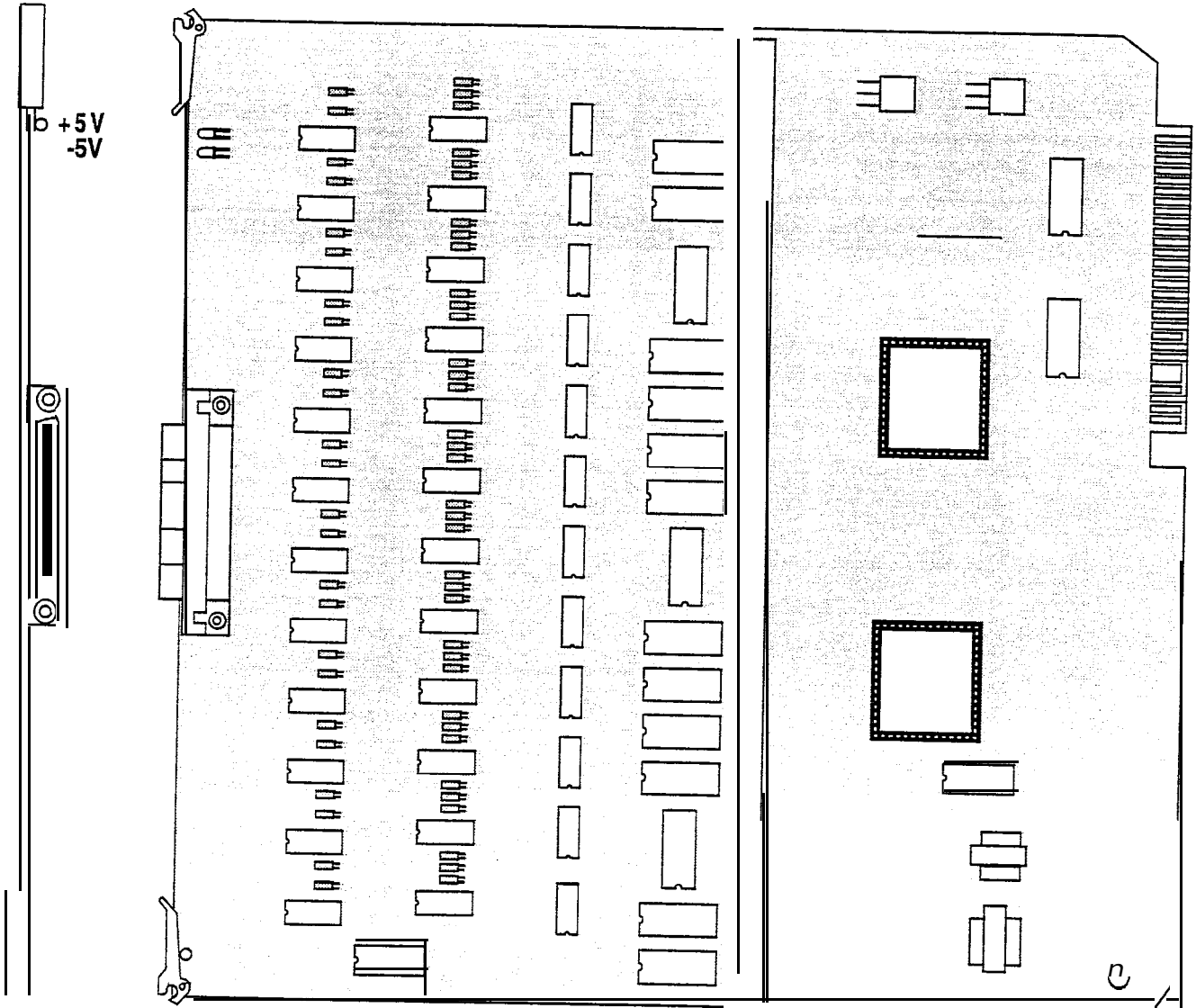

Figure 500-8 Key Telephone Board (KT12)

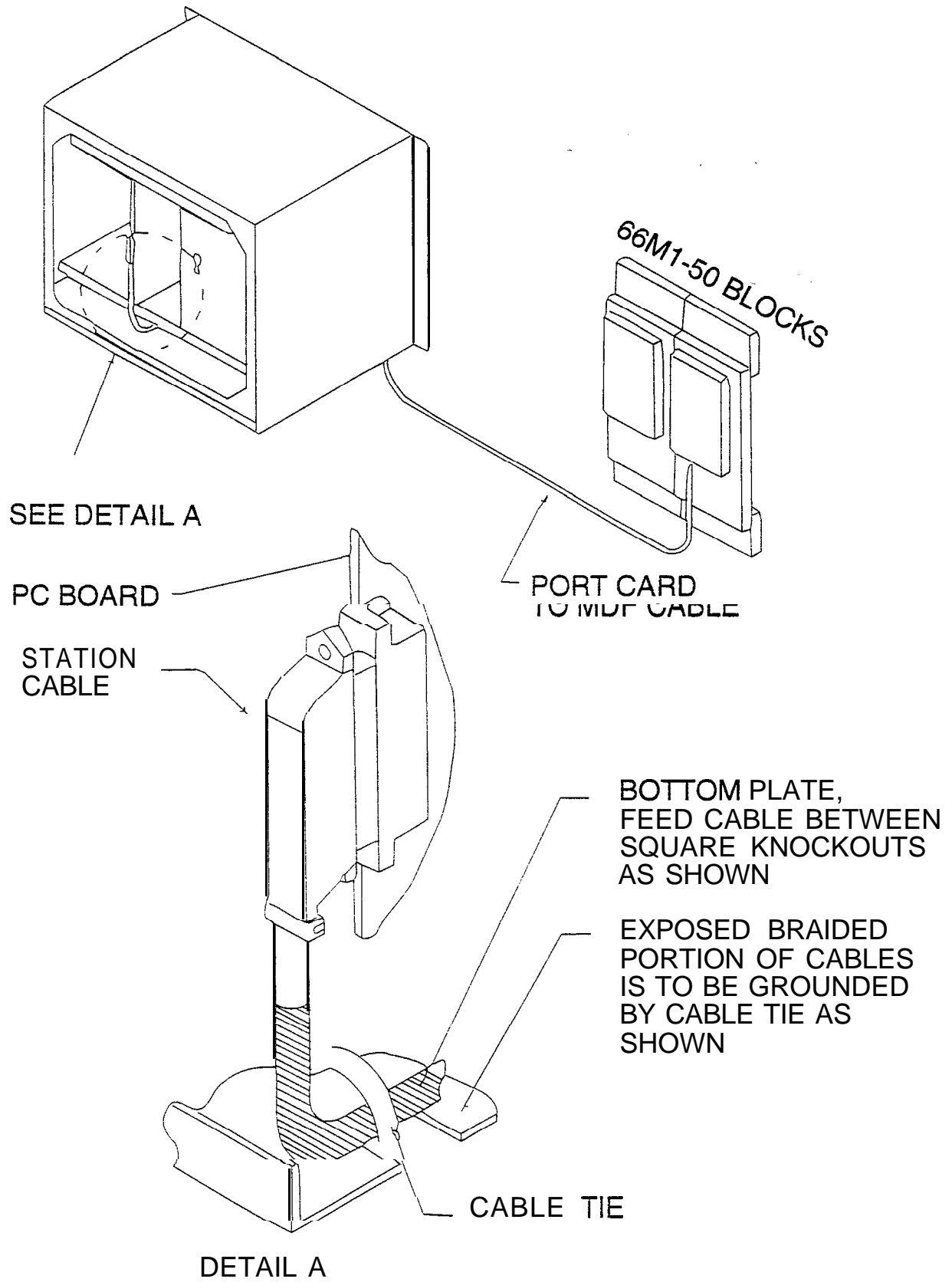

Figure 500-9 Shielded Cable Terminations

## INSTALLATION

## F. Single Line Board (SL12)

The Single Line Telephone board (SL12) provides the interface for 12 2500-type single line telephones. This board can be plugged into any designated station slot. It is recommended that the Tri-Output Power Supply be used with this card to provide the 90V ac and -48V dc voltages.

**NOTE**

*Only one Ring Generator is required per system. One Tri-Output Power Supply will accommodate two SL12 boards. When an SL12 board is installed, it is recommended that the DTM4 DTMF Receiver Module be installed at the same time. If 3 or more SL12 boards are installed in the system, at least 1 DTM4 should be installed. However, no more than 3 SL12 boards with DTM4 receivers on them can be installed in the system;*

Message Waiting capability comes installed on the Single Line Telephone Board (SL12). This circuitry provides message waiting lamps to single line telephones equipped with message waiting lamps and supports up to 12 Single Line Telephone Message Waiting lamps at 90V dc typically across tip and ring.

**LEDs & indicators:**

The board contains three LEDs to indicate the presence of +5V dc, -5V dc and -48V dc. The LEDs are located on the top portion of the board.

**Line/Station Interfaces:**

The board has one female 50-pin amphenol connector on the front edge. This interfaces the circuits on the board to the MDF. The board has one two-conductor molex connector to provide an input for 90V ac ring. A second two-conductor molex connector interfaces -48V dc to the card. Each SL12 installed in the system must have both 90V ac and -48V dc applied to it via these connectors. The card also provides proper fusing or protection to comply with the requirements of UL 1459 Second Edition and CSA C22.2 No. 225 standards.

These single line telephones can be equipped with a standard Message Waiting Lamp (90V T & R) that operate on the "tip" and "ring" leads. Additionally each circuit provides a loop interrupt of 700ms duration. This is the duration of loop interrupt provided to a single line port if loop interrupt is detected on a CO line that the single line port was connected to. Also provided if a station calls an SLT port and hangs up. The card will support single line telephones up to 2000 feet from the Basic KSU cabinet. Refer to Table 400-4 Loop Limits for additional wiring information. On-premise single line telephones should present a load to the port totaling a maximum ringer equivalence of 2.5.

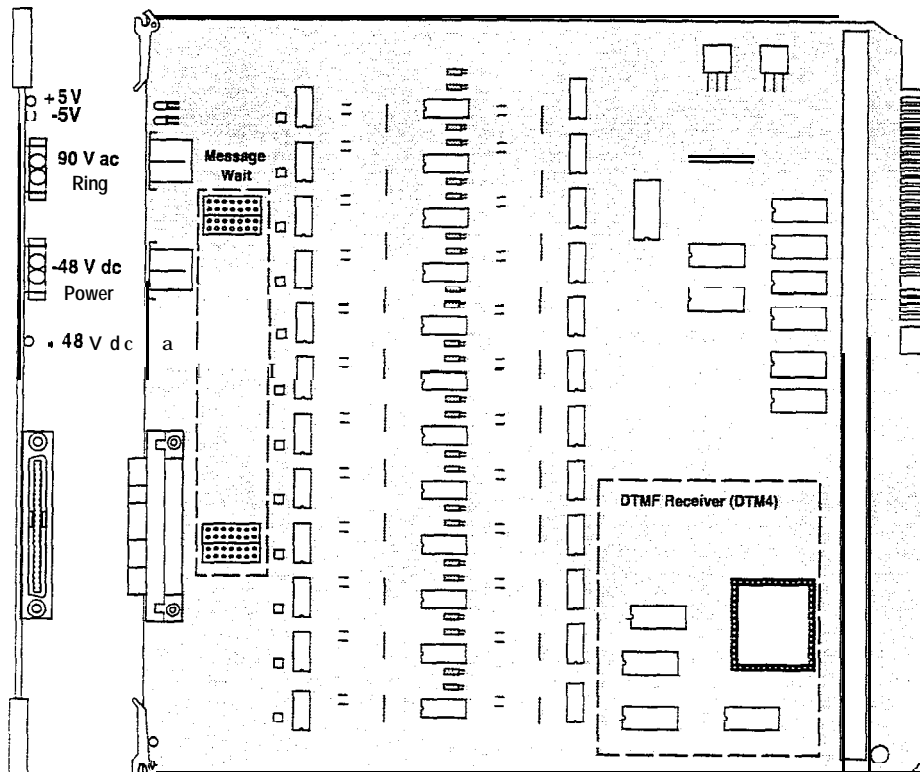

Figure 500-I 0 Single Line Telephone Board (SL12)

**Table 500-2 Single Line Telephone Board  
 (SL12)**

PAIR	PIN	COLOR	DESIG
1	26	WH/BL	Port 001 SLT Tip SLT Ring
	1	BL/WH	
2	27	WH/OR	
	2	OR/WH	
3	28	WH/GN	Port 002 SLT Tip SLT Ring
	3	GN/WH	
4	29	WH/BN	
	4	BN/WH	
5	30	WH/SL	Port 003 SLT Tip SLT Ring
	5	SL/WH	
6	31	RD/BL	
	6	BURD	
7	32	RD/OR	Port 004 SLT Tip SLT Ring
	7	OWRD	
8	33	RD/GN	
	8	GN/RD	
9	34	RD/BN	Port 005 SLT Tip SLT Ring
	9	BN/RD	
10	35	RD/SL	
	10	SL/RD	
11	36	BK/BL	Port 006 SLT Tip SLT Ring
	11	BUBK	
12	37	BK/OR	
	12	OR/BK	
13	38	BK/GN	Port 007 SLT Tip SLT Ring
	13	GN/BK	
14	39	BWBN	
	14	BN/BK	
15	40	BWBL	Port 008 SLT Tip SLT Ring
	15	SL/BK	
16	41	YUBL	
	16	BL/YL	
17	42	YL/OR	Port 009 SLT Tip SLT Ring
	17	OR/YL	
18	43	YUGN	
	18	GNNL	
19	44	YUBN	Port 010 SLT Tip SLT Ring
	19	BNNL	
20	45	YL/SL	
	20	SL/YL	
21	46	VI/BL	Port 011 SLT Tip SLT Ring
	21	BL/VI	
22	47	VI/OR	
	22	OR/VI	
23	48	VI/GN	Port 012 SLT Tip SLT Ring
	23	GN/VI	
24	49	VI/BN	
	24	BN/VI	
25	50	VI/SL	
	25	SL/VI	

**G. CO Loop interface Board (C012)**

This board interfaces 12 Loop start CO lines to the system. This board can be plugged into any designated trunk slot. Refer to Figure 500-I 1 CO Line Board (C012) for location of connectors.

**LEDs & Indicators:**

The board contains two LEDs to indicate the presence of -5V dc and +5V dc. In addition, the board has 12 red LEDs to provide the status of each CO line on the board. The status shall be lit is in use and unlit is idle.

**Line/Station Interfaces:**

The board has one female 50-pin amphenol connector on the front edge. This will interface the circuits on the board to the MDF.

**Table 500-3 CO Line Board (C012) Connections**

PAIR	PIN	COLOR	DESIG
1	26	WH/BL	Port 001 Tip Ring
	1	BL/WH	
2	27	WH/OR	Port 002 Tip Ring
	-2	OR/WH	
3	28	WH/GN	Port 003 Tip Ring
	3	GN/WH	
4	29	WH/BN	Port004 Tip Ring
	4	BN/WH	
5	30	WH/SL	Port 005 Tip Ring
	5	SUWH	
6	31	RD/BL	Port 006 Tip Ring
	6	BL/RD	
7	32	RD/OR	Port 007 Tip Ring
	7	OWRD	
8	33	RD/GN	Port 008 Tip Ring
	8	GN/RD	
9	34	RD/BN	Port009 Tip Ring
	9	BN/RD	
10	35	RD/SL	Port 010 Tip Ring
	10	SL/RD	
11	36	BWBL	Port 011 Tip R i n g
	11	BL/BK	
12	37	BK/OR	Port 012 Tip Ring
	12	OR/BK	
13	38	BK/GN	
	13	GN/BK	
14	39	BWBN	
	14	BN/BK	
15	40	BK/SL	
	15	SL/BK	
16	41	YUBL	
	16	BL/YL	
17	42	YL/OR	
	17	OR/YL	
18	43	YUGN	
	18	GNNL	
19	44	YUBN	
	19	BNNL	
20	45	YL/SL	
	20	SL/YL	
21	46	VI/BL	
	21	BL/VI	
22	47	VI/OR	
	22	OR/VI	
23	48	VI/GN	
	23	GN/VI	
24	49	VI/BN	
	24	BN/VI	
25	50	VI/SL	
	25	S WI	



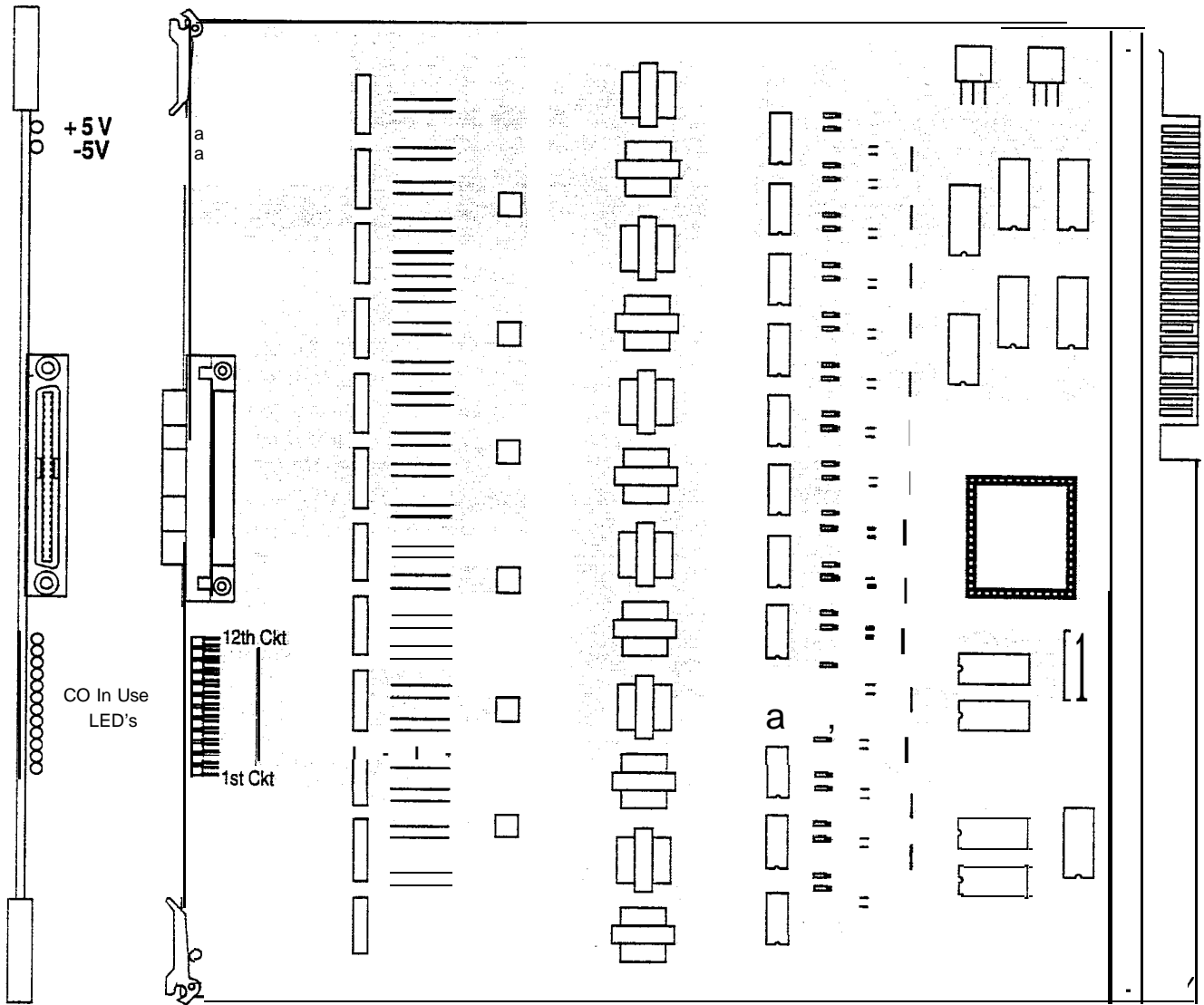
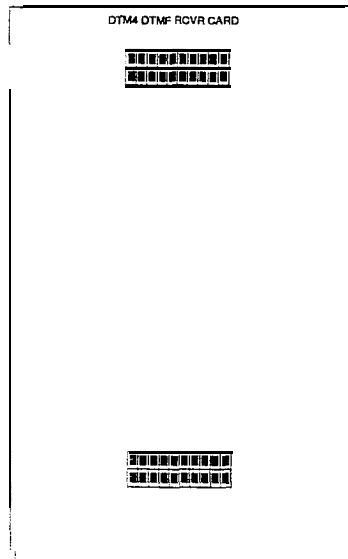

Figure 500-I 1 CO Line Board (CO1 2)

**INSTALLATION****500.4 APPLICATION MODULES****A. 4-Circuit DTMF Receiver Module (DTM4)**

This board provides four DTMF receivers for SL12 boards. This board is connected onto each SL12 board. Each SL12 board may contain 1 DTM4 board.

**Wiring / Pinouts / Connections:**

The board has a female molex connector at each end that plugs onto metal pins located on each SLT board.

Generally, one receiver will support DISA and/or eight SLT stations under light to moderate traffic. If SLT and/or DISA traffic is heavy, additional DTMF receivers should be added. It is also recommended to add additional DTMF Receivers when a Voice Mail or Auto Attendant is connected to the system.

**500.5 Tri-Output Power Supply Installation**

The Tri-Output power supply interfaces with the Single Line Board (SL12) and contains a -48V dc supply, 24V dc supply, and a Ring Generator. This is a wall mountable unit and contains screw type terminals for its connections. Each Tri-Output power supply can accommodate two SL12 boards for the -48V supply. The Ring Generator portion of the Tri-Output power supply can accommodate all SL12 boards installed in the system.

The Tri-Output power supply can provide a -48V dc source up to 1 amp of current. The 24V dc source will handle up to 1 amp of current. The Ring Generator can supply up to 5 watts of Ring voltage.

The Tri-Output Power Supply must be mounted within 3 feet of the telephone system. It also must be within 5 feet of a 120V ac, 60Hz, Parallel blade, grounding type outlet. The Power Supply must be provided free air movement at top and bottom.

The Tri-Output Power Supply is designed for fixed wall mounting.

1. Position the Tri-Output Power Supply on wall where it is to be mounted and mark four centers for screw locations.
2. **Attach Power Supply** to wall using four, hex, pan or round head fasteners listed below:
  - Plaster/Wallboard: #8 Toggle bolts
  - Wood: #8 by 1 in. wood screws
  - Block: #8 Toggle bolts
  - Concrete: #8 by 1 in. lag shields with #8 by 1 in. lag screws

**Field Wiring Output Connections:**

The unit **MUST** be unplugged from the line before proceeding.

Output connections must be installed in conformance with all state and local electrical codes by a licensed electrician.

Output connections are made by means of a barrier strip inside the Power Supply.

1. Loosen (do not remove) the two screws on top and two screws at bottom to remove cover.
2. Locate the output barrier strip and wire feed-thru hole at lower right side respectively.
3. Feed approved wiring through bushing and connect to proper terminals using ring or locking spade type terminals. Terminal legend is near barrier strip and on cover.
4. After properly securing field wiring, replace cover and tighten four cover screws.

**AC Input Connection:**

All output connections must be made before plugging in the Power Supply. The Power Supply may now be plugged into a 120V ac, 60Hz, 15a outlet. If an outlet is not available, a UL listed receptacle of proper type and configuration must be installed in conformance with all state and local electrical codes.

**500.6 Backplane I/O Expansion Module Installation**

The Backplane I/O Expansion Module is a wall mount unit with a 36-pin input connector and four RS-232C output connectors.

The Backplane I/O Expansion kit consists of one connecting cable and the I/O Expansion Module.

1. Locate the Backplane I/O Expansion Module in a location on the MDF backboard convenient to the KSU.
2. Locate the J24 connector on the backplane of the KSU cabinet.

3. Locate the connecting cable that comes with the Backplane I/O Expansion Module. This cable has a male and female 50-pin amphenol connector on it.
4. Connect one end of the cable to the J24 connector on the backplane of the KSU cabinet.
5. Connect one end of that cable into the connector marked "SVC J1" on the Backplane I/O Expansion Module.

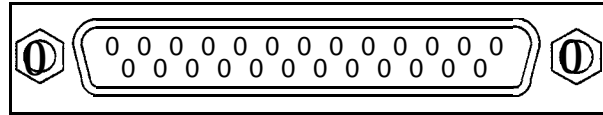

Backplane I/O Expansion Module Wiring Pinouts

KSU (DCE) Pin # DB-25		COMPUTER or PRINTER (DTE)	
		Pin # DB-25	Pin # DB-9
2	Transmit Data	2	3
3	Receive Data	3	2
20*	DTR (Data Terminal Ready)	20	4
6*	RTS (Request to Send)	6	8
7	GND	7	5
5	DSR (Data Set Ready)	5	8

**RS-232C PINOUT**

Data Communication Requirements are:

- A) Serial Port Compatible
- B) ASCII Code Compatible
- C) 8 Data Bits and 1 Stop Bit
- D) No Parity
- E) Flow Control Method: Xon/Xoff

NOTE: Arrows show flow control direction.

\* If your Personal Computer does not provide DTR, you MUST jumper pins 6 & 20 together on the KSU side.

**Figure 500-12 Backplane I/O Expansion Module Connections**

## INSTALLATION

## 500.7 DIGITAL TERMINALS

## A. Digital Terminals Installation:

The Digital Terminals are interfaced with the Starplus SPD 4896 Key Station Board (KT12) which has 12 circuits per board. Each 12-circuit Key Station Board interface is extended from the Basic KSU to the MDF through the front edge connector on the key Station Board.

At the MDF are the terminated distribution cables that are run from each key telephone location. Each Key Telephone requires two-pair twisted cable wiring to connect the digital terminals to the system on a "home run" basis. The telephone end of the cable is terminated on a modular jack and the MDF end of the cable should terminate on a punchdown block making up the MDF. Refer to Figure 500-2 Basic KSU Equipment Cabinet.

Telephones are connected to the station interfaces via industry-standard twisted, e-pair, 22 or 24 gauge wire. The station cable run from the main distribution frame to the station wall jack should not exceed 1000 feet. Refer to Figure 500-1 3 Digital Terminal Modular Block Wiring.

Station cable is connected to the MDF at one end, and a modular connecting block at the other end. The modular line cord of the telephone is then plugged into the connecting block.

**NOTE**

*Only one station may be connected to a port. It is NOT possible to bridge station ports.*

The system communicates with each phone using 4 wires. Two of the wires are used to send digital information (voice and control signals) from the system to the telephone, and two wires are used by the telephone to send digital information to the system. All 4 wires are necessary for the telephone to function. Each telephone connected to a station port has two digital channels. The primary channel is used for voice communications only. The secondary channel is used to provide a secondary path for data switching applications (future).

The installer should exercise caution when connecting a digital terminal while system power is on. Each digital terminal station circuit is overload protected by internal circuitry on the 12-circuit Key Station Board (KT12) or 12-circuit Single Line Telephone Board (SL12), however the proper polarity of the wired connections must be maintained for proper operation.

The standard Single Line Telephone, Single Line Telephone Adapter (OPX), and Digital DSS Console are all considered to be telephones by the system. These interfaces are all

wired to digital key station ports the same as a digital telephone.

## B. Digital DSS Console Installation:

The Digital DSS/DLS Console is assigned to operate with a digital terminal. Up to three DSS/DLS Console units can be assigned to any one station. There are a maximum of 72 DSS/DLS Consoles that can be installed on the Starplus SPD 4896 System. Each unit uses a digital terminal interface circuit and reduces station capacity on a one-per-one basis.

A two-pair twisted cable is required for connecting the DSS/DLS Console unit to the MDF. The cable should be run from the DSS/DLS Console to the MDF in a "home run" manner. The DSS/DLS Console end of the cable is terminated on a three-pair modular jack and the MDF is "punched down" on a terminal block for cross connection to the appropriate station cable. Refer to Figure 500-13 Digital Terminal Modular Block Wiring.

Since the system supplies power to the DSS/DLS Console, no transformer or external power device is required.

## Installing an Expanded DSS/DLS Module:

- a. Unplug the line cord from the DSS/DLS Console.
- b. Using a screw driver, remove the solid plastic overlay from the right side of the DSS/DLS Console and discard.
- c. Using a phillips screwdriver, remove the four screws from the filler panel. Discard the filler panel. The screws will be used to secure the expansion module.
- d. Tilt the expansion module down and insert into the top of the opening in the console.
- e. Work the expansion module into place, and secure with the four screws from step c.
- f. Place the blank label overlay over the buttons on the expansion module.
- g. Place the new button overlay over the buttons and secure into the two indents at the top of the opening, two indents on each side and two indents on the bottom.
- h. Turn the DSS/DLS Console over and connect the provided line cord into the bottom of the Expansion Module. Also re-connect the line cord to the other module in the DSS/DLS Console.

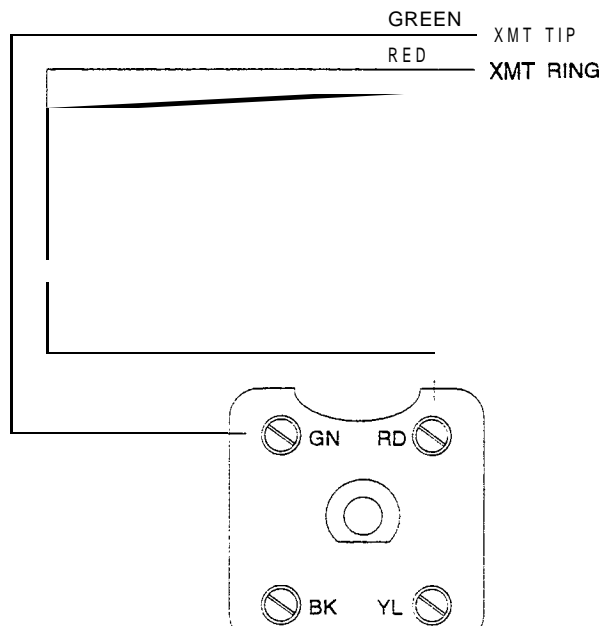
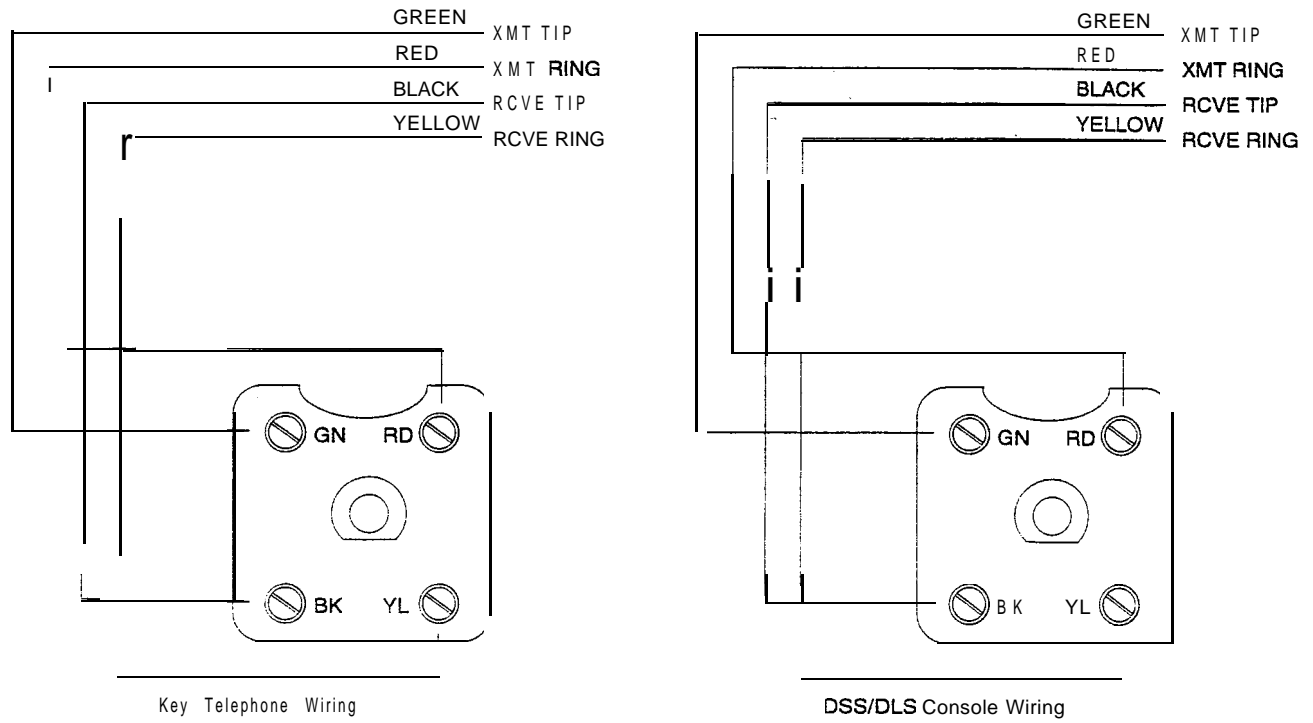

Figure 500-13 Digital Terminal Modular Block Wiring

## INSTALLATION

### C. Wall Mounting the Executive Telephone

All connections to the Digital Terminal are fully modular. To wall mount the Digital Terminal, it is necessary to use the Wall Mount bracket that comes with each Digital Terminal and one standard-type jack assembly designed for normal wall hanging applications.

- a. Unplug the line cord from the phone. This line cord will be re-used and should be retained.
- b. Using a screw driver, remove the plastic number retainer by inserting the screw driver underneath the middle of the retainer and prying upwards. Remove the screw and the handset tab. Be careful to position the tab so that the protrusion faces the hookswitch. This will allow the handset to remain secure when the telephone is on the wall. Replace the screw and snap the number retainer back into place.
- c. Reverse the back plate on the telephone for wall mounting.
- d. Line up the hooks at the bottom of the bracket so that they engage with the slots cut in the bottom of the telephone base. Tilt the telephone back and lock the telephone into the hooks at the top of the bracket. The bracket will snap in place.
- e. Route the line cord from the wall jack and plug into the connector on the back of the telephone. Now match the two key hole slots on the base plate with the lugs on the 630-A type jack. Align the modular connector and slide telephone into place. Refer to Figure 500-1 4 Digital Terminal Wall Mounting.

### D. Single Line Telephone Installation

Single Line Telephones (SLT's) can be exchanged for digital terminals on a one-for-one basis with an OPX box.

The Single Line Telephone Board (SL12) can be plugged into any designated card slot. Each Single Line Telephone board supports 12 standard single line telephones (standard DTMF Single Line Telephones and message waiting DTMF SLTs). It is recommended that the Tri-Output Power Supply be used with this card to provide the 90V ac and -48V dc voltages.

#### NOTE

**Only one Ring Generator is required per system. One Tri-Output Power Supply will accommodate two SL12 boards. When an SL12 board is installed, it is recommended that the DTM4 DTMF Receiver Module be installed at the same time. If 3 or more SL12 boards are installed in the system, at least 1 DTM4 should be installed. No more than 3 SL12 boards with DTM4 receivers on them can be installed in the system.**

The DTMF Receiver Module (DTM4) may be installed on each Single Line Telephone Board installed. The DTMF Receiver Module (DTM4) installs onto a Single Line Telephone Board (SL12) and provides 4 DTMF receivers. DTMF receivers can be added to the system to support Single Line Telephones. If SLT traffic is heavy or a Voice Mail system is being installed, it is recommended that additional DTMF Receiver Modules be installed in the system.

Each SLT requires one-pair cable. The cable should be placed from the telephone location to the MDF in a "home run" manner. The telephone end of the cable run should be terminated in a modular jack. Refer to Figure 500-2 Basic KSU Equipment Cabinet. The MDF end should be "punched down" on a terminal block for cross connection to the appropriate station cable. Refer to Figure 500-13 Digital Terminal Modular Block Wiring for SLT wiring connections.

### E. SLT Adapter / Off-Premise Extension Module (OPX)

This external module provides the interface for one long loop (OPX) single line telephone (2500 type) extension. This module requires a separately provided -48V dc power supply to provide the necessary current for long loop applications and to support ring generation. This module is wired to and interfaces with a digital key terminal port on the Starplus SPD 4896 system. The OPX box meets the requirements of the FCC for connection to the telephone (Telco) network. Telephones must be DTMF only (2500 type). Refer to Figure 500-1 5 Off-Premise Extension (OPX) Module

The OPX module also provides for one Power Fail circuit in the event of an AC power failure and contains its own DTMF receiver.

#### Buttons and LEDs:

An LED located on the back of the unit indicates correct connection and will light when the SLT station is taken off-hook.

#### Connections:

All connections to the SLA (OPX) adapter are made on the back of the unit. Two modular jacks and a two-wire cable are located on the back of the unit for connection to the KSU and power supply. The two wire cable connects to a 48V dc power supply. The modular jack marked KSU is connected to a KSU Digital terminal station port. This connection requires all four wires and wires the same as a key station. The modular jack marked OPX is wired to the SLT station (2500 type), OPX circuit or

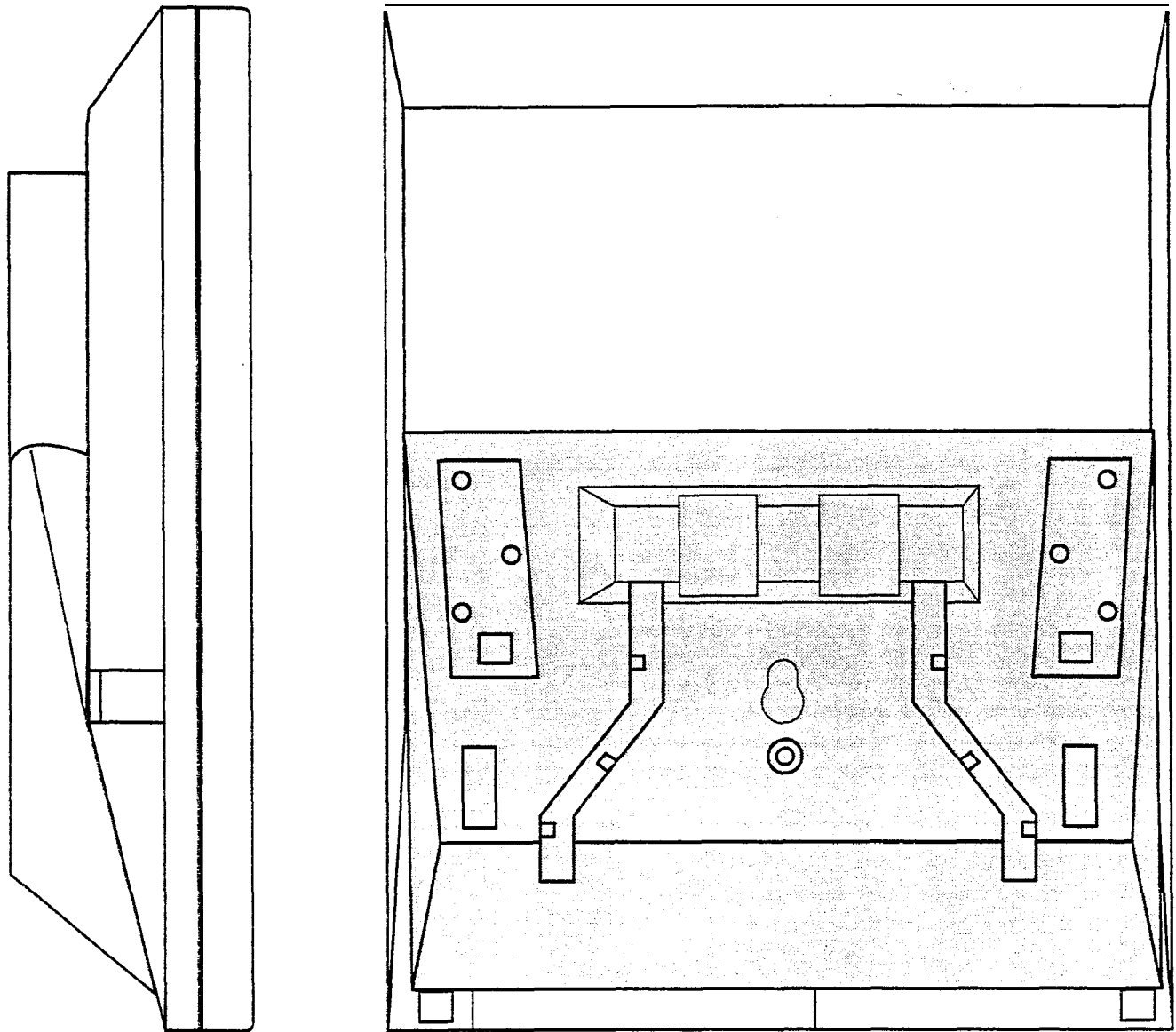

Figure 500-14 Digital Terminal Wall Mounting

**INSTALLATION**

SLT device. Additionally, a CO line may be wired to the second pair of the SLT modular connector for Power fail operation.

**Cable Loop Limits:**

The maximum loop limit from the KSU to the SLA (OPX) adapter is 1000 feet.

The maximum loop limit from the SLA (OPX) adapter to the connected SLT or device is 1400 ohms not including the telephone or device.

**500.6 POWER FAILURE TRANSFER****A. Relay / Sensor Interface Module**

The Relay Sensor Interface Module connects to the system using one digital station port and provides three relay activated contacts and three sensing circuits. The relays provide for applications such as Loud Bell Control contacts, CO Line control contacts, RAN Start contacts, Page Relays, Power Fail contact and additional applications as software will permit. The sensing circuits will provide for such applications as RAN Stop (end of message).

**Connections:**

All connections to the Relay Sensor Module are made on the back of the unit. Two terminal strips with screw terminals each provide connection to the ancillary devices for relay control or sensing monitoring. The Modular jack marked KSU is connected to a KSU Digital terminal station port. This connection requires all four wires and wires the same as a key station. Refer to Figure 500-I 6 Relay / Sensor Interface Module for wiring information.

An external power source may be required to drive equipment connected to the relay contacts. The contacts are rated at 24Vdc max. at 1 amp.

**Cable Loop Limits:**

The maximum loop limit from the KSU to the relay Sensor Module is 1000 feet.

**B. Power Failure Transfer Unit (PFTU)**

This unit provides the relay transfer circuits for up to 12 CO lines in the event of a power or processor failure. The unit is housed in its own enclosure and mounts external to the KSU. Activation of the PFT relays is controlled by the Relay/Sensor Interface Module that is programmed for PFT. A customer provided 12V dc power supply is required to operate the unit. There is a manual switch that activates the PFTM for testing purposes.

With loss of power to the system or a failure of system processing, the PFTU will automatically connect up to twelve CO lines to prewired

500/2500 type telephones. When power is restored, the PFTU will automatically restore the CO trunks and stations to normal operation. These SLT stations do not have to be used for intercom, but can be if so desired. Refer to Figure 500-17 Power Failure Transfer Wiring Options.

**Wiring / Pinouts / Connections:**

The PFTU has two 50-pin male amphenol connectors labeled CONN1 and CONN2 located on the front of the unit. Each connector wires six CO lines for power fail transfer. Refer to Table 500-4 PFTU Conn A Connecting Block and Table 500-5 PFTU Conn B Connecting Block for pin-outs of each of the connectors.

The PFTU is connected to the KSU via the modular connector on the side of the unit. This is connected in series to a customer provided 12V dc supply. and to a multi use relay programmed as a power failure relay.



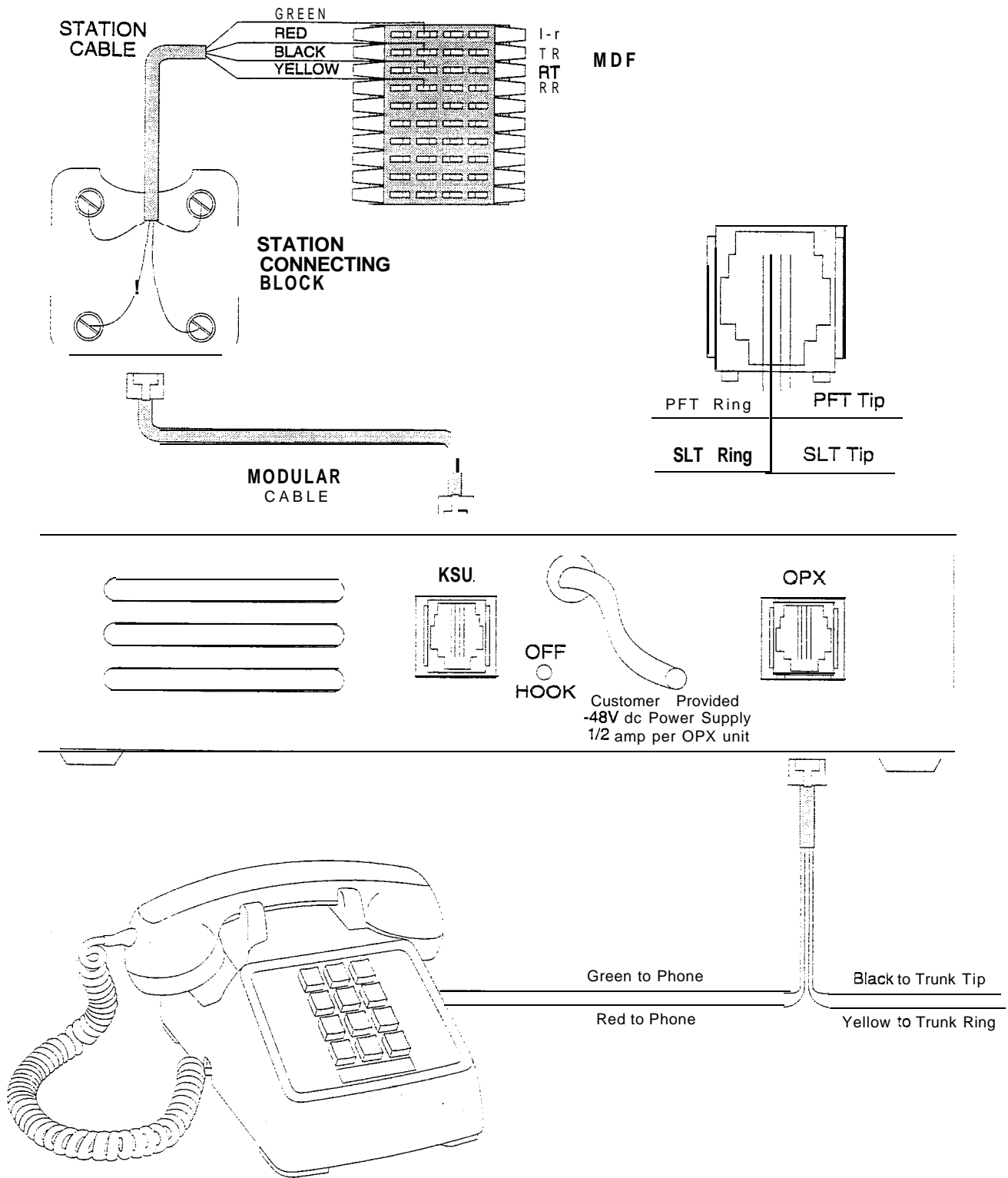

**Figure 500-15 Off-Premise Extension (OPX) Module**

INSTALLATION

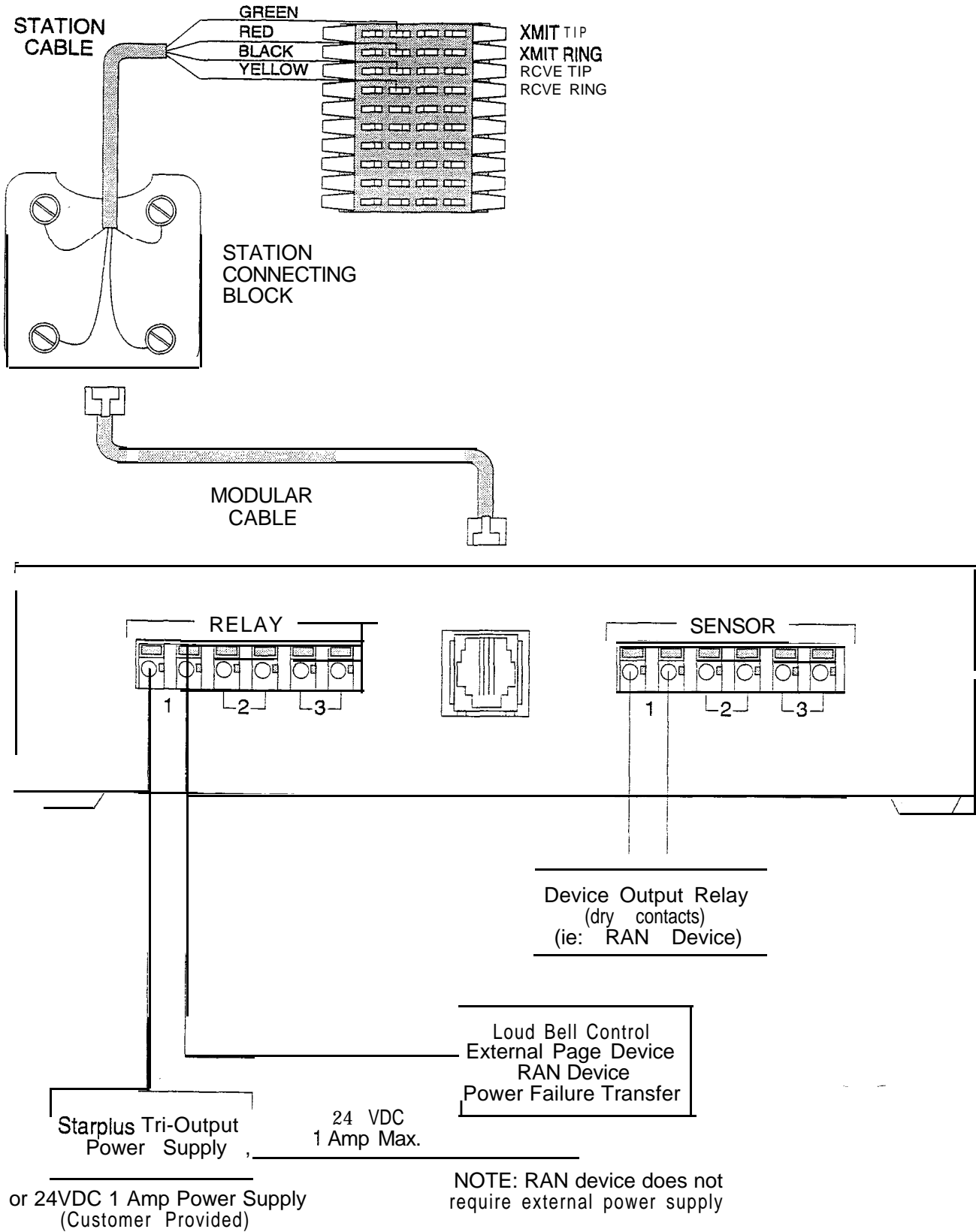
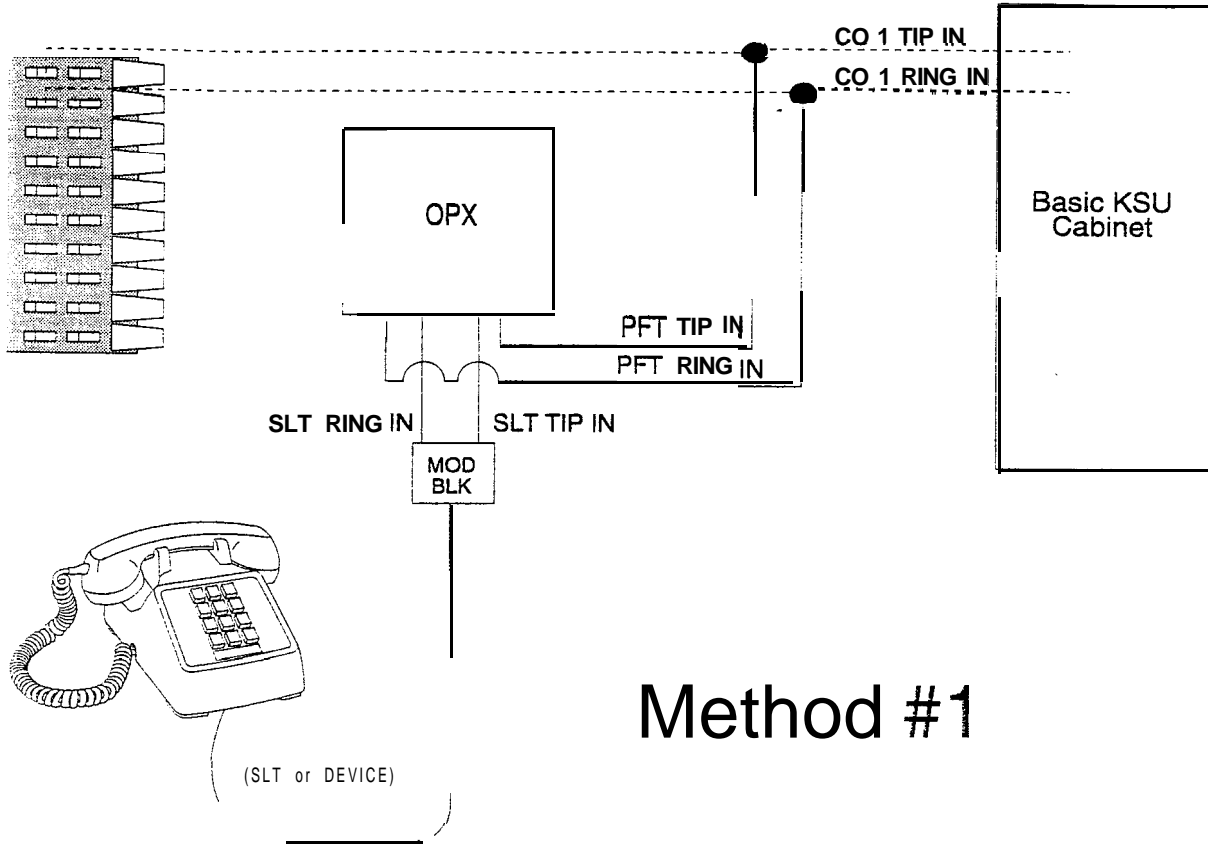

Figure 500-16 Relay / Sensor Interface Module



## Method #1

Power Failure Transfer Unit (PFTU)

## Method #2

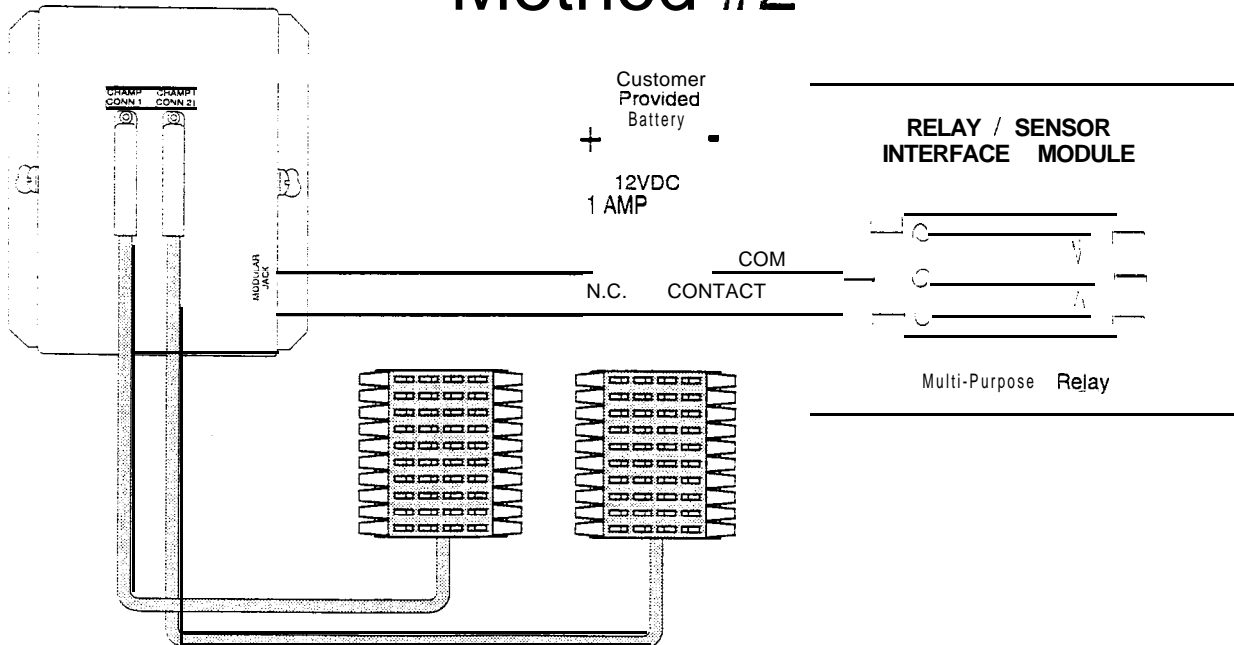

Figure 500-17 Power Failure Transfer Wiring Options

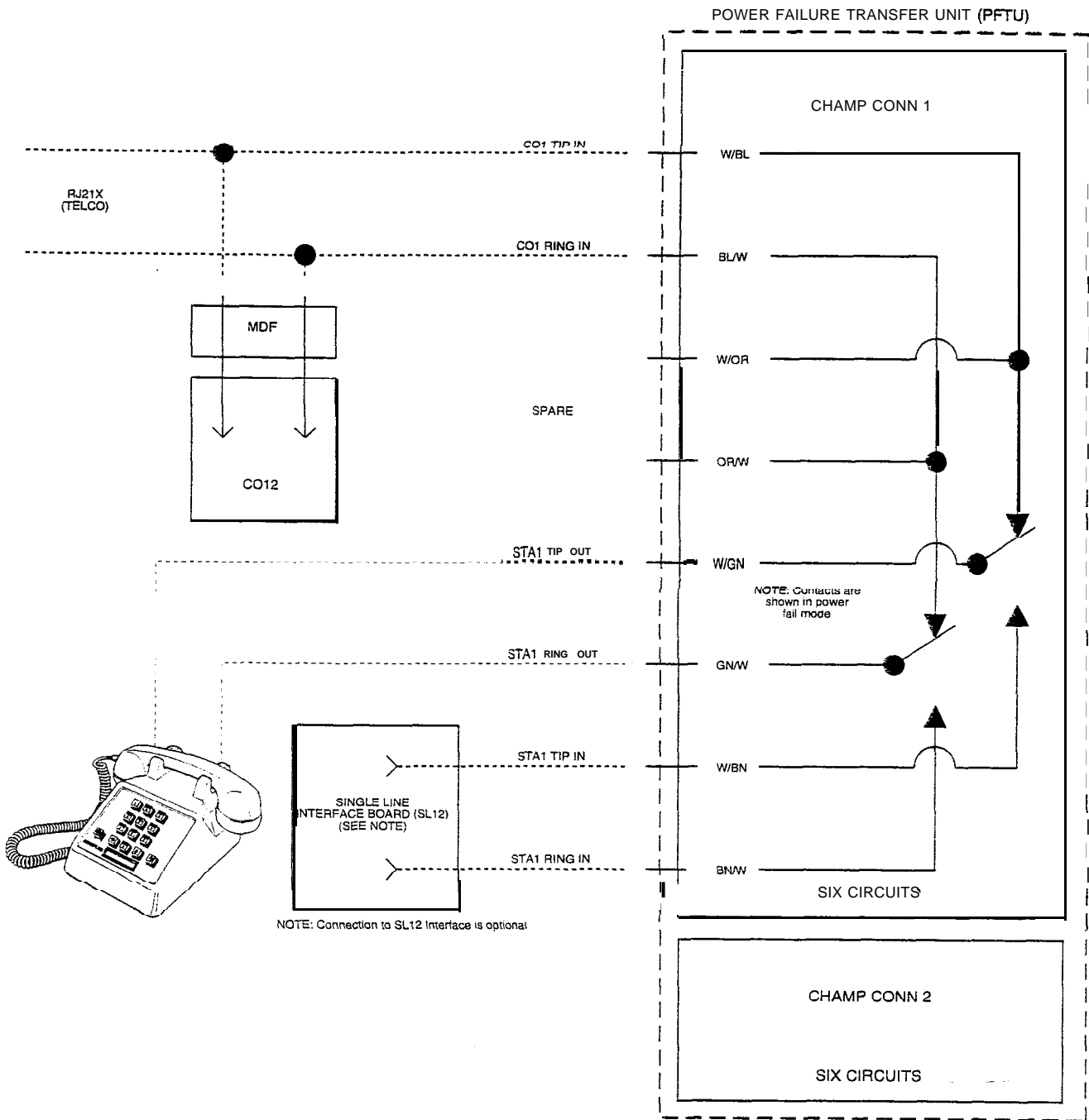

Figure 500-18 Power Failure Transfer Circuit

Table 500-4 PFTU Conn A Connecting Block

PAIR	PIN	COLOR	DESIG
1	26	WH/BL	1 TIT
	1	BUWH	1 TIR
2	27	WH/OR	1 STAIN TIP
	2	OR/WH	1 STA IN RING
3	28	WH/GN	1 TRK OUT TIP
	3	GN/WH	1 TRK OUT RING
4	29	WH/BN	1 STOT
	4	BN/WH	1 STOR
5	30	WH/SL	2 TIT
	5	SL/WH	2 TIR
6	31	RD/BL	2 STAIN TIP
	6	BL/RD	2 STA IN RING
7	32	RD/OR	2 TRK OUT TIP
	7	OR/RD	2 TRK OUT RING
8	33	RD/GN	2 STOT
	8	GN/RD	2 STOR
9	34	RD/BN	3 TIT
	9	BN/RD	3 TIR
10	35	RD/SL	3 STAIN TIP
	10	SL/RD	3 STAIN RING
11	36	BK/BL	3 TRK OUT TIP
	11	BUBK	3 TRK OUT RING
12	37	BK/OR	3 STOT
	12	OR/BK	3 STOR
13	38	BK/GN	4 TIT
	13	GN/BK	4 TIR
14	39	BK/BN	4 STA IN TIP
	14	BN/BK	4 STA IN RING
15	40	BWSL	4 TRK OUT TIP
	15	SUBK	4 TRK OUT RING
16	41	YUBL	4 STOT
	16	BL/YL	4 STOR
17	42	YUOR	5 TIT
	17	OR/YL	5 TIR
18	43	YUGN	5 STA IN TIP
	18	GNNL	5 STAIN RING
19	44	YUBN	5 TRK OUT TIP
	19	BNNL	5 TRK OUT RING
20	45	YL/SL	5 STOT
	20	SL/YL	5 STOR
21	46	VI/BL	6 TIT
	21	BWI	6 TIR
22	47	VI/OR	6 STA IN TIP
	22	OR/VI	6 STA IN RING
2 3	48	VI/GN	6 TRK OUT TIP
	23	GN/VI	6 TRK OUT RING
2 4	49	VI/BN	6 STOT
	24	BNNI	6 STOR
25	50	VI/SL	
	25	SL/VI	

Table 500-5 PFTU Conn B Connecting Block

PAIR	PIN	COLOR	DESIG
1	26	WH/BL	7 TIT
	1	BL/WH	7 TIR
2	27	WH/OR	7 STA IN TIP
	2	OR/WH	7 STA IN RING
3	28	WH/GN	7 TRK OUT TIP
	3	GN/WH	7 TRK OUT RING
4	29	WH/BN	7 STOT
	4	BN/WH	7 STOR
5	30	WH/SL	8 TIT
	5	SUWH	8 TIR
6	31	RD/BL	8 STAIN TIP
	6	BL/RD	8 STA IN RING
7	32	RD/OR	8 TRK OUT TIP
	7	OR/RD	8 TRK OUT RING
8	33	RD/GN	8 STOT
	8	GN/RD	8 STOR
9	34	RD/BN	9 TIT
	9	BN/RD	9 TIR
10	35	RD/SL	9 STA IN TIP
	10	SL/RD	9 STAIN RING
11	36	BWBL	9 TRK OUT TIP
	11	BUBK	9 TRK OUT RING
12	37	BK/OR	9 STOT
	12	OWBK	9 STOR
13	38	BWGN	10 TIT
	13	GN/BK	10 TIR
14	39	BK/BN	10 STA IN TIP
	14	BN/BK	10 STA IN RING
15	40	BWSL	10 TRK OUT TIP
	15	SUBK	10 TRK OUT RING
16	41	YL/BL	10 STOT
	16	BL/YL	10 STOR
17	42	YUOR	11 TIT
	17	OR/YL	11 TIR
18	43	YL/GN	11 STA IN TIP
	18	GNNL	11 STA IN RING
19	44	YUBN	11 TRK OUT TIP
	19	BNNL	11 TRK OUT RING
20	45	YL/SL	11 STOT
	20	SL/YL	11 STOR
21	46	VI/BL	12 TIT
	21	BL/VI	12 TIR
22	47	VI/OR	12 STA IN TIP
	22	OR/VI	12 STA IN RING
23	48	VI/GN	12 TRK OUT TIP
		GN/VI	12 TRK OUT RING
24		VI/BN	12 STOT
	24	BNNI	12 STOR
25	50	VI/SL	
	25	SL/VI	

INSTALLATION

500.9 **INSTALLING RECORDED ANNOUNCEMENT DEVICE (RAN)**

The Recorded Announcement feature (RAN) is used with either the Automatic Call Distribution (ACD) or Uniform Call Distribution (UCD) features to provide unanswered incoming CO calls or calls in queue with a Recorded Announcement while waiting for an available ACD or UCD station. The system may be programmed to provide this announcement on specified RAN output ports on the system (unused SLT and CO ports). The system can be programmed to connect the waiting caller to a different RAN port for the second, and subsequent RAN messages.

When a CO line port is used for a ground start application, a 24V dc power source must be connected to the CO line port for talk battery. A Page/Relay contact assigned to an announcement table in programming would provide contact closure to start the Recorded Announcement device.

When an SLT port is used, the RAN device must be configured for ring trip operation (loop start). The 90V ac voltage sent to the SLT port will be recognized by the RAN device which will then answer the call.

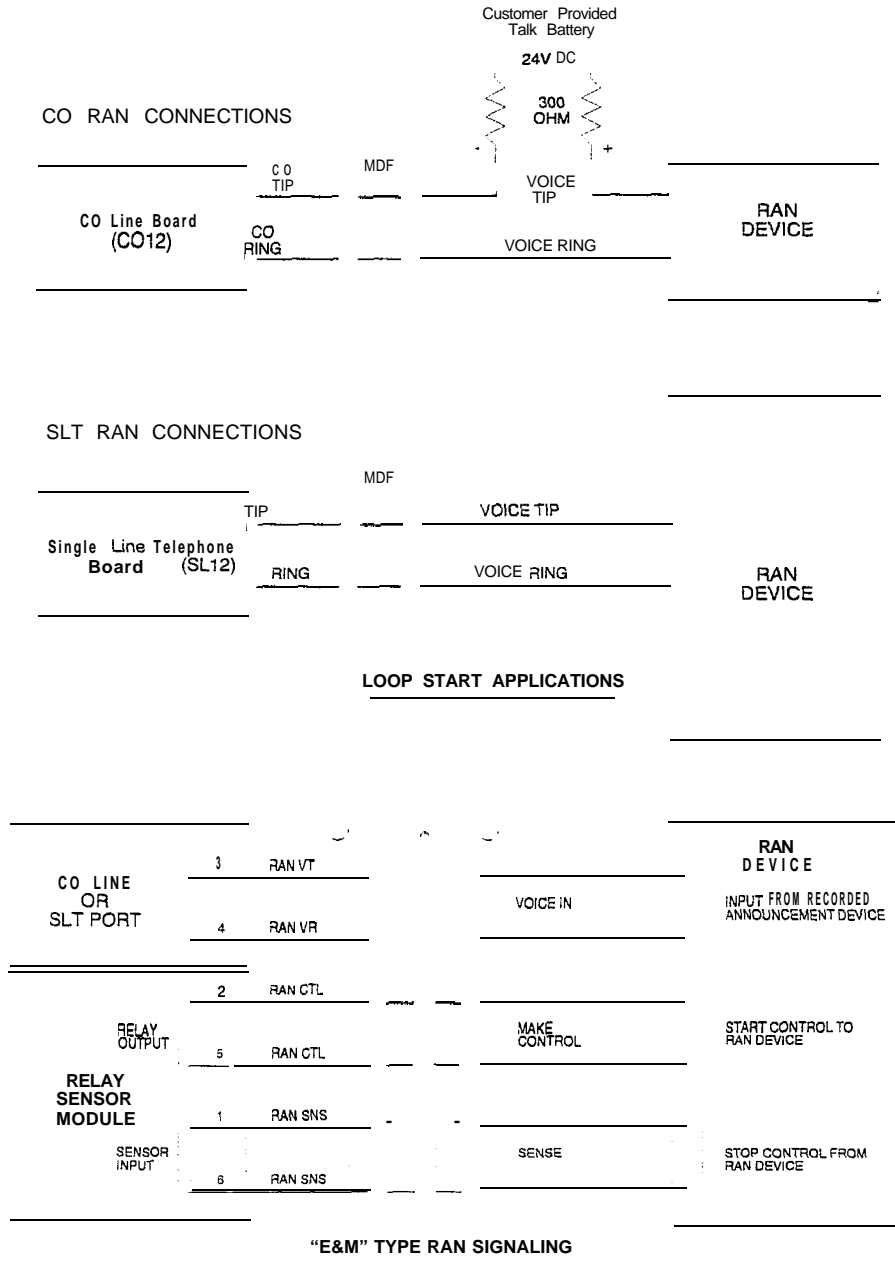

"E&M" TYPE RAN SIGNALING

Figure 500-I 9 CO and SLT RAN Connections

**500.10 DATAFEATURE**

The Data Feature is a time division switched, point to point data transmission capability which permits simultaneous (on the same system but not the same port) voice and data communications. The Data Feature offers the ability to transmit data information between personal computers, printers, plotters, CRT terminals, and main frame computer ports.

To establish a Data call, a Digital Data interface Unit (DDIU) is required to be connected to each data communications device. Data information can be switched through the system at speeds of **300, 1200, 2400, 4800, 9600, 19.2K and 38.4K** baud asynchronous.

The Digital Data Interface Unit (DDIU) is wired to the **Starplus** Digital Key Telephone System like a digital telephone, and requires one station port.

All connections to the **DDIU** are made on the back panel. The back panel has a modular jack and a DB-25 type connector. The modular jack, labeled **KSU**, is used to connect the **DDIU** to the station port of the system. The DB-25 connector supports an RS-232C connection and is used to connect the data device to the system.

A green LED lights to indicate the **DDIU** is properly wired to the system.

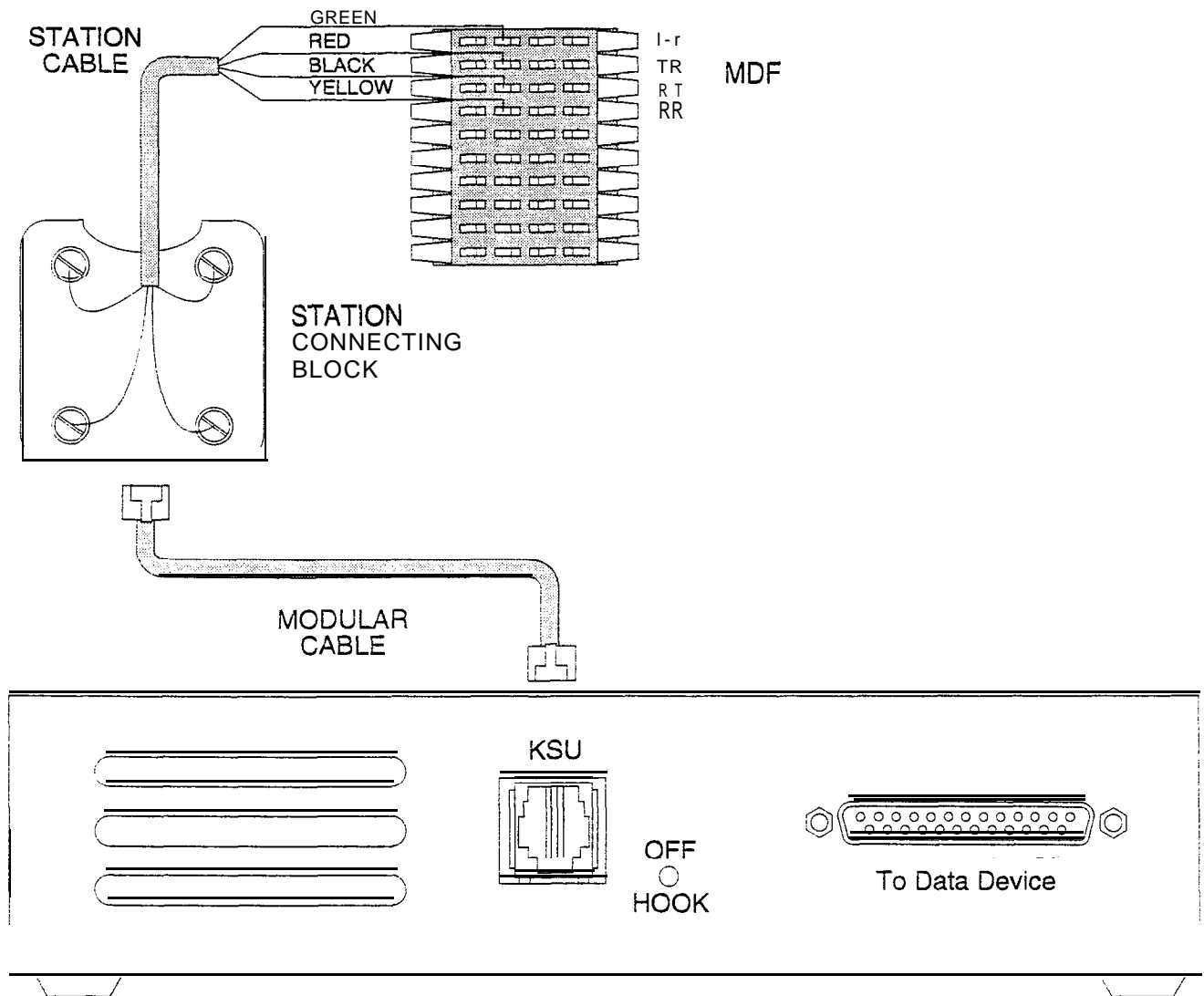

**Figure 500-20 Digital Data interface Unit (DDIU) wiring**

**INSTALLATION**

Connection of the individual data communication devices requires that the installer be familiar with data communications terms, and has access to the appropriate information for connecting the variety of data communications devices that may be encountered. This information consists of, but is not limited to:

1. Is the device configured as data terminal equipment (DTE), or data communications equipment (DCE).
2. What pin on the RS-232C type connector performs what function?
3. What signal leads are required to make the device operate?

When planning the installation of the data feature, use a digital display phone at any location that is to originate a data connection. A DDIU can only be called; it cannot originate a connection. A DDIU would typically be used in conjunction with the digital display phone. A DDIU would typically be connected to a printer, or a MODEM.

The station wiring for a digital display phone and a DDIU are identical.

The data connector of the Digital Data Interface Unit (DDIU) is a 25-pin, type D connector which is configured as Data Communications Equipment with the following pin configurations.

PIN #	USE	DIRECTION
2	Receive Data	DDIU
3	Transmit DATA	DDIU
4	Request To Send	DDIU
5	Clear To Send	DDIU
6	Data Set Ready	DDIU
7	Signal Ground	
8	Data carrier detect	DDIU
20	Data Terminal Ready	DDIU
22	Ring Indicator	DDIU

The following diagram will aid in the design of cables to connect the many different configurations of data communications devices.

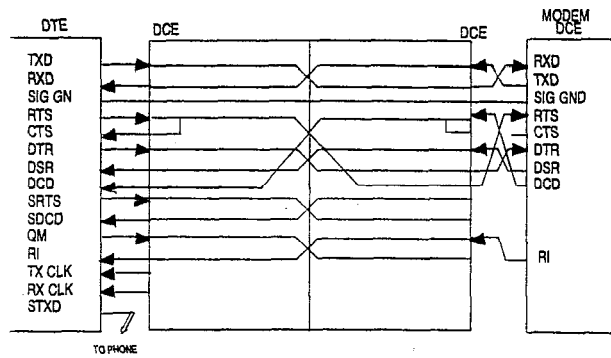

**Digital Systems Data Switching**

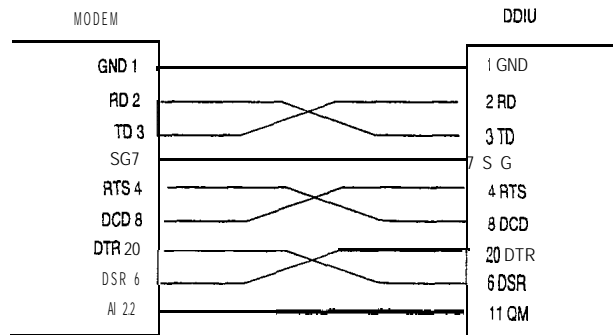

Modem to DDIU Cable



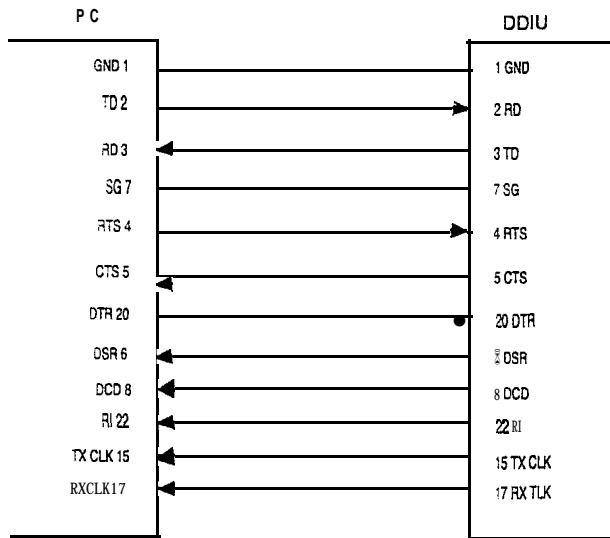

Computer to Phone Cable

To establish a connection to any idle data port:

1. A user with an associated DDIU dials the station number of the DDIU or the group access number of the group that the DDIU has been inserted into or presses a DSS button representing the DDIU. The digital key system will then determine the baud rate setting for the called DDIU and convert the user's associated DDIU to the same baud rate. The system will then complete the connection.

A second method to establish a connection between two DDIUs is done by the first attendant.

1. The first attendant dials the extension number of one data unit. Dial tone is received and the display will show the BAUD RATE.
2. Then dials the station number of the second data unit, confirmation tone is heard.

To break down an established connection:

1. The station user dials his associated DDIU number or press the DSS button for the associated DDIU followed by pressing the FLASH button. The first attendant can dial one of the DDIUs, followed by pressing the FLASH button.

Conditions:

- The System is transparent to the devices **being** connected. Therefore each DDIU must be configured with a specific baud rate, number of data bits and number of stop bits. This configuration will be done by the first attendant or in the case of an associated data unit can be configured by the user.
- Data switching is accomplished using the same wiring the telephone station uses for voice switching.
- Data ports can be arranged in UCD Groups or Hunt Groups.
- Data ports do not have to be associated with a **keyset**, however to connect two DDIU devices one of them must be associated with a **keyset** unless the connection is made by the first attendant.
- When the data connection has been completed, the baud rate used in the connection will be displayed on the **keyset**.
- Non associated DDIU connections can be broken down by the first attendant.
- A DDIU has a DCE interface. Therefore a straight through RS-232C cable can be used connect to a DTE device (printer, PC, etc.).
- Each DDIU requires a digital terminal port.

Refer to Station Attributes Programming, 630.2, Station Identification for programming the Station ID of the Digital Data Interface Unit (DDIU). Also refer to Sec. 630.3, Digital Data Interface Unit (DDIU) for programming the parameters of the Digital Data Interface Unit (DDIU).

Table 500-6 SMDR Printout

The SMDR feature provides detailed records of all outgoing and/or incoming, long distance only or all calls. The SMDR Qualification Timer determines the length of time that is needed to determine a valid SMDR call for reporting purposes. By default, this timer is set to 30 seconds and is variable from 00 to 60 seconds in 1 sec. increments. This feature is enabled or disabled in system programming. By default, SMDR is not enabled and is set to record long distance calls only. A printout format of 80 characters maximum or 29 character maximum may be selected in system programming. The standard format is 80 characters on a single line. A 29 character format will generate 3 lines per message. If the SMDR feature is enabled, the system starts collecting information about the call as soon as it starts and terminates when the call ends. If the call was longer then 30 seconds, the following information is printed:

**29 character format selected:**

```

      1           2           3
123456789012345678901234567890
AAA BB HH:MM:SS HH:MM MM/DD/YY (CR) (LF)
HCCCCCCCCCCCCCCCCCCCCCCCCCCCC
GGGGGGGGGGGG

STA CO TOTAL   START   DATE
116 08 00:02:00 14:13 05/11/90 (CR) (LF)
0123456789012345678901234 (CR) (LF)
123456789012 (CR) (LF)
    
```

**80 character format selected:**

```

      1           2           3           4           5           6           7           8
12345678901234567890123456789012345678901234567890123456789012345678901234567890
AAA BB HH:MM:SS HH:MM MM/DD/YY HCCCCCCCCC CCCCCCCCCCCCCC GGGGGGGGGGGG (CR) (LF)

STA CO TOTAL   START   DATE   DIALED   ACCOUNT CODE   COST
116 08 00:02:00 14:13 05/11/90 0123456789012345678901234 123456789012 (CR) (LF)
    
```

**80 character format with Call Cost Display feature enabled:**

```

      1           2           3           4           5           6           7           8
12345678901234567890123456789012345678901234567890123456789012345678901234567890
AAA BB HH:MM:SS HH:MM MM/DD/YY HCCCCCCCCC CCCCCCCCCCCCCC GGGGGGGGGGGG (CR) (LF)

STA co TOTAL   sTART   DATE   DIALED   ACCOUNT CODE   COST
116 08 00:02:00 14:13 05/11/90 0123456789012345678901234 123456789012 000.00 (CR) (LF)
    
```

**80 character format for DISA Calls:**

```

      2           3           4           5           6           7           8
12345678901234567890123456789012345678901234567890123456789012345678901234567890
AA BB HH:MM:SS HH:MM MM/DD/YY HCCCCCCCCC CCCCCCCCCCCCCC GGGGGGGGGGGG (CR) (LF)

STA co TOTAL   START   DATE   DIALED   ACCOUNT CODE   COST
04 01 00:02:00 14:13 05/11/90 I 123456789012 000.00 (CR) (LF)
01 04 00:04:54 14:15 05/11/90 00123456789012345678901234
    
```

- continue on next page -

Table 500-6 SMDR Printout (Cont'd)

ICLID 60 character format selected:

1 2 3 4 5 6 7 8  
~234567890123456789012345678901234567890~234567890~23456789012345678901234567890

STA	co	TOTAL	START	DATE	DIALED	ACCOUNT CODE	COST
100	01	00:00:36	04:37	06/19/92	I1-602-443-6000**		(CR) (LF)
		**VODAVI			(CR) (LF)		
	01	00:00:00	04:38	06/19/92	U1-602-443-6000**		
		**VODAVI					

AAA = Station originator or Trunk on DISA and Off-Net (CO Line) calls.

BB = Outside line number

HH:MM:SS = Duration of call in Hours, Minutes and Seconds

HH:MM = Time of day (start time) in Hours and Minutes

MM/DD/YY = Date of Call

H = Indicates call type:

"I" = Incoming\*

"O" = Outgoing

"T" = Transferred\*

"U" = Unanswered calls for ICLID SMDR call records

CC....CC = Number dialed

GG....GG = Last Account code entered (optional)

(CR) = Carriage return

(LF) = Line Feed

\*When ACD features are present in the system, the "I", and "T" are replaced with the letter "A".

## SECTION 600

# CUSTOMER DATA BASE PROGRAMMING

### 600.1 INTRODUCTION

The Starplus Digital Key Telephone system can be programmed to meet each customer's individual needs. All programming is done either at Station 100 using the 34-button display digital terminal as the programming instrument or an ASCII terminal or PC. The digital display model is suggested since the display is designed to assist in programming.

When the program mode is entered, the Digital Terminal being used no longer operates as a terminal but as a programming instrument with all of the buttons redefined. The keys of the dial pad are used to enter data fields (Program Codes) associated with system, station, and CO line features as well as enter specific data that requires a numeric entry. Flexible buttons are used to toggle on or off features or allow entry into specific data fields. LED's and the LCD display provide visual indication of entered data and their value.

Programming can also be performed by using an ASCII terminal, or a computer capable of emulating an ASCII terminal. This form of programming can be done either locally (on-site) by connecting the terminal directly to the RS-232C connector on the Central Processor Unit (CPU) or can be performed remotely (off-site) through the use of the on-board 1200 Baud modem (future) located on the CPU. The method and steps to program the system via a terminal are identical to that used when programming from a digital keyset. A button to keyboard mapping has been incorporated (see Figure 600-I) to help minimize familiarization and training time.

At the time the system is installed it must be initialized to load default data into memory. If this pre-programming suits the customer, initialization is all that is needed. Refer to Table 600-I for a listing of all the default values.

Any time data is to be changed, the program mode must be entered and then the individual data field (program code). A data field can be entered to determine current programming or to change a specific feature within that field.

During programming, the other Digital Terminals in the System operate normally. If a data field is entered but nothing is changed, or changed but not entered, the previous data will remain intact upon leaving that data field. Data fields can be entered at random.

In many of the data fields, programming is performed by toggling LED's on or off, or entering digits on the

keypad. If no changes are to be made to the line or station, exit the data field by either leaving the program mode (pressing the ON/OFF button to OFF) or entering another data field (pressing the FLASH button and entering that program code).

When features are being programmed, tones are provided to help the programmer determine if a correct or incorrect entry has been made. A solid one second tone indicates the data was accepted. An interrupted tone means an error was made.

When this occurs, re-enter the data field and re-enter the information. Until new data is entered and accepted, the system will continue to operate under default or previously entered values.

The system database is updated on a real-time basis as new data is entered, by pressing the Hold button. The system continues to operate with the current database and is updated with any newly entered or changed data without interruption to telephone operation or call processing in progress. However, if for example a station's attributes are changed while that station is off-hook on an active call, the newly entered data will not take effect until the station goes on-hook or becomes idle.

#### NOTE

Some features must have **more than one data field programmed for that feature to work** Where this is the case, it will be stated in the instructions.

### 600.2 PROGRAM MODE ENTRY (Key Station)

Programming a digital terminal is performed at Port 01 (Station 100) using a 34-button Digital Display Terminal. Programming is always done at this port regardless of the class of service or which station has been assigned the attendant(s).

Before entering the program mode, the programmer must first verify that the Digital Terminal is properly connected to Port 01 (Station 100).

To enter the program mode:

- a. Press ON/OFF button. (optional) LED lights and intercom dial tone is heard.
- b. On the dial pad, press the asterisk (\*) twice.
- c. On the dial pad, enter the digits [3][2][2][6] (DBAM)\*. Confirmation tone is heard.

\* This is a default setting. However, it may be changed after entering programming.

- d. The ON/OFF button LED is lit. The system is ready to program.

When using a data terminal (I/O device) to program the system, the following chart presents the data terminal characters that are equivalent to the **keyset** buttons.

```

adm>?
REMOTE ADMIN KEY DEFINITIONS

  Keypad Term   Keypad Term Keypad Term
  -----
  0          0   FLEX 1   Q   FLEX 11  A
  1          1   FLEX 2   W   FLEX 12  S
  2          2   FLEX 3   E   FLEX 13  D
  3          3   FLEX 4   R   FLEX 14  F
  4          4   FLEX 5   T   FLEX 15  G
  5          5   FLEX 6   Y   FLEX 16  H
  6          6   FLEX 7   U   FLEX 17  J
  7          7   FLEX 8   O   FLEX 18  K
  8          8   FLEX 9   P   FLEX 19  L
  9          9   FLEX 10  '   FLEX 20  ;
  *          *   FLASH    ,   ON-OFF   M
  #          #   HOLD     CR  SPEED    Z
  TRANS     X   DND      C   MUTE     U

adm>

```

In place of **keyset** button toggling to enable/disable a feature, the associated data terminal key can be toggled (pressed again) to **enable/disable** a feature, or the plus (+) character can be used to turn on or enable a feature and the minus (-) character can be used to turn off or disable a feature.

Figure 600-I Data Terminal Program Codes *Cross Reference*

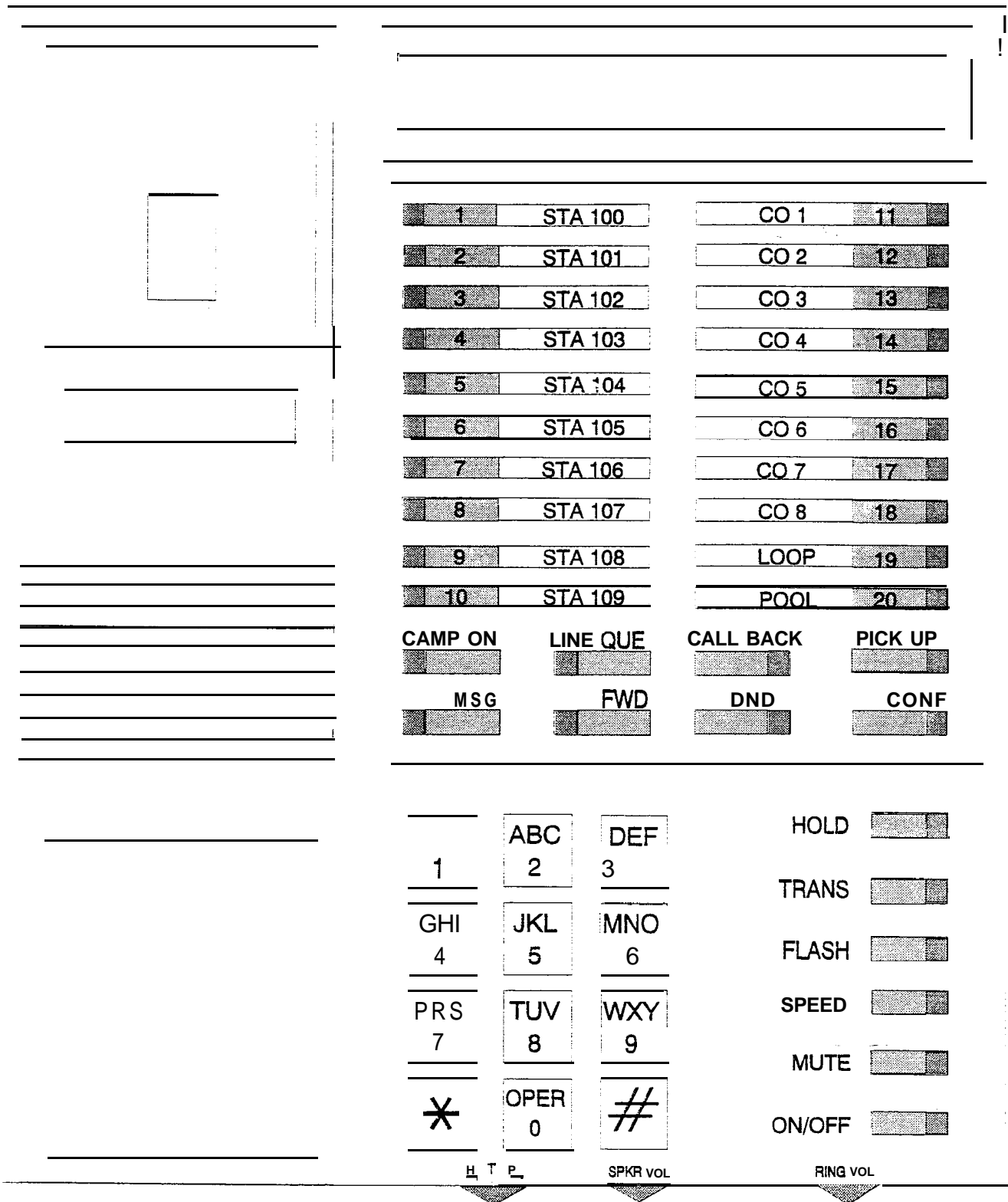

Figure 600-2 Programming Button Mapping

Table 600-I Default Values

FEATURE	PROGRAM CODE	FLEX BUTTON	DEFAULT VALUE
<b>SYSTEM TIMERS:</b>	Flash 01		
System Hold Recall Timer		Button 1	060 sec.
Exclusive Hold Recall Timer		Button 2	180 sec.
Attendant Recall Timer		Button 3	01 min.
Transfer Recall Timer		Button 4	045 sec.
Preset Forward Timer		Button 5	10 sec.
Call Forward No/Answer Timer		Button 6	15 sec.
Pause Timer		Button 7	2 sec.
Call Park Timer		Button 8	180 sec.
Conference/DISA Timer		Button 9	10 min.
Paging Timeout Timer		Button 10	15 sec.
CC Ring Detect Timer		Button 11	3 (100 msec.)
SLT DTMF Receiver Timer		Button 12	020
MSG Waiting Reminder Tone		Button 13	000 min.
Hookflash Timer		Button 14	10 (1 sec.)
Hookflash <b>Debounce</b> Timer		Button 15	010 msec.
SMDR Call Qualification Timer*		Button 16	30 sec.
Auto Call Back Timer		Button 17	00 sec.
Reminder Ring Timer		Button 18	00 sec.
Release Guard Timer		Button 19	3 (300 msec.)
<b>SYSTEM FEATURES:</b>	Flash 05		
Attendant Override		Button 1	Disabled
Hold Preference		Button 2	System
External Night Ring		Button 3	Disabled
Executive Override Warning Tone		Button 4	Enabled
Page Warning Tone		Button 5	Enabled
Background Music		Button 6	Enabled
<i>LCR Enable *</i>		<i>Button 7</i>	<i>Disabled</i>
<i>Forced Account Codes *</i>		<i>Button 8</i>	<i>Disabled</i>
Group Listening		Button 9	Disabled
Idle Speaker Mode		Button 10	Disabled
<i>Call Cost Display Feature *</i>		<i>Button 11</i>	<i>Disabled</i>
Music-On-Hold		Button 12	Enabled
Handset Receiver Gain		Button 13	Disabled
Call Qualifier Tone Option		Button 14	Disabled
Privacy Release Tone Option	Flash 06	Button 1	Enabled
<b>SYSTEM FLASH RATES:</b>	Flash 07		
incoming CO Ringing		Button 1	30 ipm flash
Incoming Intercom Ringing		Button 2	120 ipm flutter

\*Features available with optional software.

**Table 600-I Default Values (Cont'd)**

FEATURE	PROGRAM CODE	FLEX BUTTON	DEFAULT VALUE
Call Forward		Button 3	30 ipm flash
Message Waiting		Button 4	15 ipm flash
Attendant Station Assignment (3 Stations)	Flash 10		100
Set Date and Time	Flash 11	Button 1-4	MM/DD/YY, 12 Hr
PBX Dialing Codes	Flash 12	Buttons 1-5	None
Executive/Secretary Assignments	Flash 13	Buttons 1-4	None
Relay/Sensor Programming	Flash 14	Buttons 1-7	None
Baud Rate Assignments	Flash 15		
Port #1 (CPU "On-Board" RS-232C)(Future)		Button 1	2400 Baud
Port #2 ("On-Board" 1200 Baud Modem)		Button 2	1200 Baud
Port #3 (Backplane RS-232C)		Button 3	2400 Baud
Port #4 (Backplane RS-232C)		Button 4	2400 Baud
ACCESS CODES	Flash 20		
DISA Access Code		Button 1	100
Admin Password for Digital Key Terminal		Button 2	3226
<b>SMDR* PROGRAMMING</b>	<i>Flash 2 1</i>		
<i>SMDR</i>		<i>Button 1</i>	<i>Disabled</i>
<i>Call Type</i>		<i>Button 2</i>	<i>LD</i>
<i>Print Format</i>		<i>Button 3</i>	<i>80</i>
<i>Baud Rate</i>		<i>Button 4</i>	<i>2400</i>
<i>Port #</i>		<i>Button 5</i>	<i>Port #1</i>
NIGHT MODE PROGRAMMING:	Flash 22		
Auto/Manual		Button 1	Manual
Days of the Week Schedule		Buttons 2-8	0-4 08:00-1 7:00 5-6 #####-#####
DIRECTORY DIALING TABLE	Flash 23		
Bin/ICM		Button 1	
Name		Button 2	
Clear Entry		Button 3	
Back space		Button 4	
Next Entry		Button 18	
Previous Entry		Button 19	
New Entry		Button 20	
FLEXIBLE CARD ASSIGNMENTS	Flash 24	Buttons 1-1 2	4 Sta/4 CO/4 Sta
HUNT GROUP PROGRAMMING:	Flash 30		
Groups 1-8		Buttons 1-8	
Pilot/Circular		Button 9	
<b>CO LINE GROUP PROGRAMMING:</b>	Flash 40		
DTMF/Dial Pulse Signaling		Button 1	DTMF

\*Features available with optional software.



Table 600-I Default Values (Cont'd)

FEATURE	PROGRAM CODE	FLEX BUTTON	DEFAULT VALUE
CO/PBX Flag		Button 2	CO
Universal Night Answer (UNA)		Button 3	Enabled
Conference		Button 4'	Enabled
Privacy		Button 5	Enabled
Loop Supervision		Button 6	Disabled
DISA		Button 7	Disabled
Flash Timer		Button 8	10
CO Line Group		Button 9	1
Line COS		Button 10	1
Ringing Assignment		Button 11	None
CO Line Identification Display		Button 12	
Trunk Direction		Button 13	Incoming-Outgoing
Ring Delay Timer		Button 14	00 sec.
Display Ring Assignment(s)		Button 17	Ring at Sta 100
Next (forward) CO		Button 18	
Next (backward) CO		Button 19	
New Range		Button 20	
Dial Pulse, Speed/Ratio Programming	Flash 41		
Break/Make		Button 1	60/40
Dial Speed		Button 2	10 pps
Flexible Port Assignment Feature - CO Lines	Flash 42	Buttons 1-7	Cards 1-7
<i>ICLID* Ringing Assignment Feature</i>	<i>Flash 43</i>	<i>Button 1</i>	
<b>STATION PROGRAMMING:</b>	Flash 50		
Page Access	Page A	Button 1	Enabled
DND Access		Button 2	Enabled
Conference		Button 3	Enabled
Executive Override		Button 4	Disabled
Privacy		Button 5	Enabled
System Speed		Button 6	Enabled
Queuing		Button 7	Enabled
Preferred Line Answer		Button 8	Disabled
OHVO		Button 9	Disabled
Call Forward		Button 10	Enabled
<i>Forced LCR*</i>		<i>Button 11</i>	<i>Disabled</i>
<i>Supervisor Barge-in for ACD*</i>		<i>Button 12</i>	<i>Disabled</i>
Executive Override Blocking		Button 13	Enabled
CO Ringing Options		Button 14	Disabled
Select Page A		Button 18	
Select Page B		Button 19	

\*Features available with optional software.

Table 600-I Default Values (Cont'd)

FEATURE	PROGRAM CODE	FLEX BUTTON	DEFAULT VALUE
New Station Range (#ls)		Button 20	
Station Programming (Cont'd)	Flash 50		
Station ID	Page B	Button 1	0 (Keyset) 5(SLT w/o MWt)
Class of Service		Button 2	1
Speakerphone/Headset		Button 3	0
Group Pickup		Button 4	1
Paging Zones		Button 5	1
Preset Forward		Button 6	None
CO Line Group Access		Button 7	1
LCR Class of Service*		Button 8	0
Off-Hook Preference		Button 9	0 (keyset)
Flexible Button Assignments		Button 10	
Display Button Assignments		Button 17	
Select Page A		Button 18	
Select Page B		Button 19	
New Station Range (#'s)		Button 20	
DIGITAL DATE INTERFACE UNIT (DDIU)	Flash 51		
Baud Rate		Button 1	<b>9600</b>
Character Length		Button 2	8 characters
Stop Bit		Button 3	1 stop bit
Flexible Port Assignment Feature - Stations	Flash 52	Buttons 1-7	Cards 1-7
Local Number/Name Translation Table	Flash 55	Buttons 1-4	
<i>ICLID FEATURES*</i>	<i>Flash 56</i>		
<i>Enable/Disable</i>		<i>Button 1</i>	<i>Disabled</i>
<i>Name in Display</i>		<i>Button 2</i>	
<i>Baud Rate</i>		<i>Button 3</i>	2400
<i>Port #</i>		<i>Button 4</i>	<i>Port #1</i>
<i>ACD* GROUP PROGRAMMING:</i>	<i>Flash 60</i>		
<i>ACD Groups 550-557</i>	<i>Page A</i>	<i>Buttons 1-8</i>	None
<i>Alternate ACD Group</i>		<i>Button 11</i>	None
<i>Overflow Assignment</i>		<i>Button 12</i>	None
<i>Announcement Table(s) Entries</i>		<i>Button 13</i>	None
<i>ACD Supervisor Programming</i>		<i>Button 14</i>	
<i>Select Page A</i>		<i>Button 18</i>	
<i>Select Page B</i>		<i>Button 19</i>	
<i>ACD Groups (550-557)</i>	<i>Page B</i>	<i>Buttons 1-8</i>	None
<i>Select Page A</i>		<i>Button 18</i>	
<i>Select Page B</i>		<i>Button 19</i>	

\*Features available with optional software.

Table 600-I Default Values (Cont'd)

FEATURE	PROGRAM CODE	FLEX BUTTON	DEFAULT VALUE
<i>ACD* TIMERS:</i>	<i>Flash 61</i>		
<i>Ring Timer</i>		<i>Button 1</i>	60 sec.
<i>MIT Timer</i>		<i>Button 2</i>	60 sec.
<i>Over Flow Timer</i>		<i>Button 3</i>	60 sec.
<i>Wrap-Up Timer</i>		<i>Button 4</i>	04 sec.
<i>No-Answer Recall Timer</i>		<i>Button 5</i>	000 sec.
<i>No-Answer Retry Timer</i>		<i>Button 6</i>	30 sec.
<i>Guaranteed Message Timer</i>		<i>Button 7</i>	<b>10 sec.</b>
<b>UCD GROUP PROGRAMMING:</b>	<i>Flash 60</i>		
<i>UCD Groups 550-557</i>	<i>Page A</i>	<i>Buttons 1-8</i>	None
<i>Alternate UCD Group</i>		<i>Button 11</i>	None
<i>Overflow Assignment</i>		<i>Button 12</i>	None
<i>Announcement Table(s) Entries</i>		<i>Button 13</i>	None
<i>Select Page A</i>		<i>Button 18</i>	
<i>Select Page B</i>		<i>Button 19</i>	
<i>UCD Groups (1-8)</i>	<i>Page B</i>	<i>Buttons 1-8</i>	None
<i>Select Page A</i>		<i>Button 18</i>	
<i>Select Page B</i>		<i>Button 19</i>	
<i>UCD TIMERS:</i>	<i>Flash 61</i>		
<i>Ring Timer</i>		<i>Button 1</i>	60 sec.
<i>MIT Timer</i>		<i>Button 2</i>	60 sec.
<i>Over Flow Timer</i>		<i>Button 3</i>	60 sec.
<i>Wrap-Up Timer</i>		<i>Button 4</i>	04 sec.
<i>No-Answer Recall Timer</i>		<i>Button 5</i>	000 sec.
<i>No-Answer Retry Timer</i>		<i>Button 6</i>	300 sec.
<i>UCD RAN Announcement Tables</i>	<i>Flash 62</i>		None
<i>ACD* Event Trace</i>	<i>Flash 63</i>		
<i>Event Record</i>		<i>Button 1</i>	<i>Disabled</i>
<i>Port #</i>		<i>Button 2</i>	<i>Port #1</i>
<i>ACD* GROUP PROGRAMMING:</i>	<i>Flash 64</i>		
<i>ACD Groups 558-565</i>	<i>Page A</i>	<i>Buttons 1-8</i>	None
<i>Alternate ACD Group</i>		<i>Button 11</i>	None
<i>Overflow Assignment</i>		<i>Button 12</i>	None
<i>Announcement Table(s) Entries</i>		<i>Button 13</i>	None
<i>ACD Supervisor Programming</i>		<i>Button 74</i>	
<i>Select Page A</i>		<i>Button 18</i>	
<i>Select Page B</i>		<i>Button 19</i>	
<i>ACD Groups (558-565)</i>	<i>Page B</i>	<i>Buttons 1-8</i>	None
<i>Select Page A</i>		<i>Button 18</i>	
<i>Select Page B</i>		<i>Button 19</i>	

\*Features available with optional software.

Table 600-I Default Values (Cont'd)

FEATURE	PROGRAM CODE	FLEX BUTTON	DEFAULT VALUE
<b>VOICE MAIL* GROUP PROGRAMMING:</b>	<i>Flash 65</i>	<i>Buttons 1-8</i>	<i>None</i>
<i>VM Groups (1-8)</i>		<i>Buttons 9</i>	<i>None</i>
<i>Alternate VM Group</i>		<i>Button 10</i>	<i>None</i>
<i>Leave Mail Table entry</i>		<i>Button 11</i>	<i>None</i>
<i>Retrieve Mail Table entry</i>		<i>Button 12</i>	<i>None</i>
<i>Station Assignments</i>			
<i>VM Leave/Retrieve Disconnect Tables</i>	<i>Flash 66</i>	<i>Buttons 1-9</i>	
<b>VM* In-Band Digits</b>	<i>Flash 67</i>		
<i>VM* ID on Incoming CO Calls</i>		<i>Button 1</i>	<i>Enabled</i>
<i>Allow Call Forward to Voice Mail*</i>		<i>Button 2</i>	<i>Disabled</i>
<b>ALLOW/DENY &amp; SPECIAL TABLES:</b>	<i>Flash 70</i>		
<i>Allow Table A</i>		<i>Button 1</i>	<i>None</i>
<i>Deny Table A</i>		<i>Button 2</i>	<i>None</i>
<i>Allow Table B</i>		<i>Button 3</i>	<i>None</i>
<i>Deny Table B</i>		<i>Button 4</i>	<i>None</i>
<i>Special Table 1</i>		<i>Button 5</i>	<i>All Codes Allowed</i>
<i>Special Table 2</i>		<i>Button 6</i>	<i>All Codes Allowed</i>
<i>Special Table 3</i>		<i>Button 7</i>	<i>All Codes Allowed</i>
<i>Special Table 4</i>		<i>Button 8</i>	<i>All Codes Allowed</i>
<i>Area Code for Special Table 1</i>		<i>Button 9</i>	
<i>Area Code for Special Table 2</i>		<i>Button 10</i>	
<i>Area Code for Special Table 3</i>		<i>Button 11</i>	
<i>Display Tables</i>		<i>Button 12</i>	
<b>LCR* PROGRAMMING:</b>		<i>Flash 75</i>	
<i>3-Digit Routing Table</i>	<i>Button 1</i>		<i>Default</i>
<i>&amp;Digit Routing Table</i>	<i>Button 2</i>		<i>None</i>
<i>Exception Code Tab/e</i>	<i>Button 3</i>		
<i>Route List Table</i>	<i>Button 4</i>		
<i>Insert/Delete Table</i>	<i>Button 5</i>		
<i>Daily Start time Table</i>	<i>Button 6</i>		
<i>Weekly Schedule Table</i>	<i>Button 7</i>		
<i>Route for 555-1212</i>	<i>Button 8</i>		
<b>INITIALIZE DATA BASE PARAMETERS:</b>	<i>Flash 80</i>		
<i>Init System Parameters</i>		<i>Button 1</i>	
<i>Init CO Line Attributes</i>		<i>Button 2</i>	
<i>Init Station Attributes</i>		<i>Button 3</i>	
<i>Init CO/Station Port Parameters</i>		<i>Button 4</i>	
<i>Init Exception Tables</i>		<i>Button 5</i>	
<i>Init System Speed</i>	<i>Button 6</i>		

\*Features available with optional software.

Table 600-I Default Values (Cont'd)

FEATURE	PROGRAM CODE	FLEX BUTTON	DEFAULT VALUE
<i>hit LCR* Tables</i>		<i>Button 7</i>	
<i>Init Entire System Database and Reset</i>		Button 8	
<i>Init ICLID* Parameters</i>		<i>Button 9'</i>	
<i>Init Directory Dialing Table</i>		Button 10	
<i>Init Hunt Group Parameters</i>		Button 11	
<i>Init ACD* or UCD Group Parameters</i>		<i>Button 12</i>	
<i>Init VM* Group Parameters</i>		<i>Button 73</i>	
System Reset		Button 20	
<b>PRINT DATA BASE PARAMETERS:</b>	Flash 85		
Print System Parameters		Button 1	
Print CO Line Attributes		Button 2	
Print Station Attributes		Button 3	
Print CO/Station Port Parameters		Button 4	
Print Exception Tables		Button 5	
Print System Speed		Button 6	
<i>Print LCR* Tables</i>		<i>Button 7</i>	
Print Entire System Database		Button 8	
<i>Print ICLID* Parameters</i>		<i>Button 9</i>	
Print Directory Dialing Table		Button 10	
Print Hunt Group Parameters		Button 11	
<i>Print ACD* or UCD Group Parameters</i>		<i>Button 12</i>	
<i>Print VM* Group Parameters</i>		<i>Button 13</i>	
Abort Printing		Button 20	

\*Features available with optional software.

Other telephones connected to the system continue to function normally.

**600.3 PROGRAM MODE ENTRY (Data Terminal or PC)**

A data terminal connected to the RS-232C port on the CPU or remotely through the on-board 1200 Baud Modem (future) can be used for database programming.

When using a data terminal (ASCII or PC capable of emulating an ASCII terminal) on-site or locally, to program the System:

- a. Press the **Enter** key on the terminal.
- b. Enter the password **[VODAVI]**, and press return again. Proper entry of the password will result in the **ADM>** prompt. Proceed with programming referring to Figure 600-I for terminal characters that represent the **keyset** buttons. By entering a **[?]** from the terminal, a HELP screen will appear.

When entering the system remotely via a data terminal, access to the on-board 1200 Baud Modem (future) is accomplished by accessing Port 499 either through a direct ringing assignment or through DISA or by being transferred to Port 499 by any internal station.

Proper entry of the password will result in the **ADM>** prompt. Proceed with programming referring to Figure 600-I for terminal characters that represent the **keyset** buttons. By entering a **[?]** from the terminal, a HELP screen will appear, similar to that shown in Figure 600-I.

Using the Remote Admin Key Definitions follow the same steps and procedures to program the Starplus Digital Key Telephone System when using a terminal (as outlined in the following sections).

**600.4 BEGINNING TO PROGRAM**

Once the program mode has been entered via a digital terminal or via an ASCII terminal, you may proceed with programming by:

**NOTE** *Initialize here if necessary. Refer to the following section for initialization instructions.*

- a. Press the FLASH button.
- b. Dial the two-digit program code for the desired data field.
- c. Enter customer data.
- d. To permanently store the entered data, press the HOLD button. A burst of one second confirmation tone should be heard. If an interrupted (error) tone is heard, re-enter the data starting with step a.
- e. Repeat from step a. until all data has been entered into memory.

**600.5 INITIALIZATION**

The system has been pre-programmed with certain features which are called default data (Refer to Table 600-I). These features are loaded into memory when the system is initialized.

**NOTE** *The system should be initialized when installed if at any time the database has been corrupted.*

Use the procedures below to return the system database to default values:

- a. Enter the programming mode.
- b. Press FLASH button and dial **[80]**.
- c. Press the System & Reset flexible button (Button **#8**).
- d. Press HOLD button to initialize the system database to default values. Confirmation tone will be heard upon completion of the initialization process.
- e. Repeat from step c. to return only parts of the database to default values using the following flexible buttons:

1	Q	SYSTEM PARAMETERS	HUNT GROUPS	A	11
2	W	CO LINE ATTRIBUTES	ACD* or UCD GROUPS	S	12
3	E	STATION ATTRIBUTES	VOICE MAIL* GROUPS	D	13
4	R	PORT - STA CO		F	14
5	T	EXCEPTION TABLES		G	15
6	Y	SYSTEM SPEED NUMBERS		H	16
7	U	LCR* TABLES		J	17
8	I	SYSTEM & RESET		K	18
9	8	ICLD* TABLES		L	19
10	P	DIRECTORY DIAL TABLES			20

\*Features available with optional software.

**NOTE** *Buttons 1-7 DO NOT Initialize the database.*

**600.6 CUSTOMER DATA WORKSHEETS**

Before any attempt at programming is made, it is strongly recommended that customer data worksheets be prepared (Refer to Appendix A). These worksheets should become part of the permanent record of customer programming. Refer to the following sections when preparing the worksheets.

**600.7 DATA BASE FIELDS**

The data fields are used to set system timers, determine central office line features and Key Telephone features. When entering CO line data and station data, be sure to enter the exact number of digits specified. The data fields and features are further described in the following sections.

**600.6 DATABASE UPLOAD/DOWNLOAD ROUTINE**

The Database Upload/Download database feature provides a maintenance facility which permits the user to download the database to a PC, when a software change is made or when the system needs to be initialized and re-programmed. In addition, the routine will facilitate the programming of a database on an in-house system which can be downloaded to a PC and then uploaded to a system in the field. After the system maintenance is completed, the file saved in the PC can then be uploaded to the system.

**NOTE** All trace modes (SMDR, ICLID Event, Maintenance Event Traces, etc.) MUST be turned off before any download is performed!

**A. Using the PC to Upload/Download thru Remote Administration**

A Personal Computer must be connected to the RS-232C port on the Central Processor Unit (CPU) on the Starplus SPD 4896 system that can be used for database programming.

When entering the system remotely via a Personal Computer, access to the on-board 1200 Baud Modem (future) is accomplished by using Port 499 either through a direct ringing assignment, DISA or by being transferred to Port 499 by any internal station.

1. Connect one end of an RS-232C Serial cable from the RS-232C connector on the Central Processor Unit (CPU) of the SPD 4896 system to the desired Comm Port on the Personal Computer.

**NOTE** Pins 2 & 3 on the Personal Computer end of the RS-232C serial cable MUST be reversed. Pins 6 & 7 MUST be jumpered together for proper operating of the upload/download routing.

2. Load a communication software package (i.e. Procomm) into the Personal Computer. Make the necessary changes to the following areas of the communications package. Save these permanent settings.

ITEMS TO CHANGE	CHANGE
Parameters: [Alt] + [P]	
Baud Rate	2400 Baud, N for Parity, 8 Bits, 1 Stop Bit
SETUP OPTIONS: [Alt] + [S]	
Terminal Options:	
Item C: Soft flow ctrl (XON/XOFF)	ON
Protocol Options:	
Item A: Echo Locally	OFF
Item D: Character Pacing	0

Item E: Line Pacing	0
Item F: Pace Character	0
Item I: CR Translation (upload)	None
Item J: LF Translation (upload)	None
Item K: CR Translation (download)	None
Item L: LF Translation (download)	None

PROTOCOL OPTIONS	
General Protocol Options:	
Item C: Abort xfer if CD lost	NO

NOTE: Item C appears in Procomm Plus Version 2.01 or higher

**NOTE** There should NOT be a problem downloading from an Starplus SPD 2856 system and uploading that data file to a Starplus SPD 4696 system.

3. Press the [Enter] key on the PC. The following display will be seen on the Personal Computer monitor.

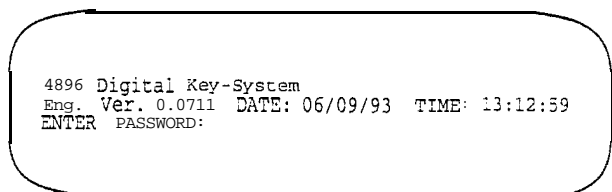

4. Enter the password [VODAVI], and press the [Enter] key again. Proper entry of the password will result in the ADM> prompt. Proceed with programming referring to Figure 600-I for terminal characters that represent the keyset buttons. By entering a [?] from the terminal, a HELP screen will appear.
5. Enter the information on the following screen capture.

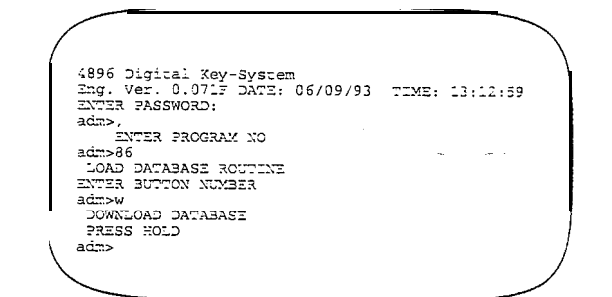

6. Press the [Alt] + [F1] keys. This will bring up the log screen on the PC monitor. Enter a path for the database file to be sent to or press [Enter] and the database file will be sent to the desti-

nation shown in the communications package default settings area.

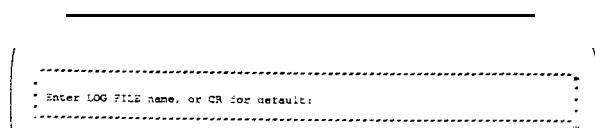

**NOTE** *The downloaded database can not be changed in the P6. The Upload/download routine is only a method to save an existing database. Any database changes can be made using the remote admin capabilities.*

7. On the PC, press the [Enter] key to begin the downloading routine. Confirmation tone will be heard when the database is completely downloaded.
8. After the file is downloaded from the system and no more data is seen on the screen, press the [Alt] + [F1] keys again to turn the log file off.
9. Enter an "M" or a "," and press the [Enter] key.
10. On the PC, press the [Alt] + [X] keys. Press the [Enter] key to exit Procomm and return to the DOS prompt.

The download file will contain a series of ASCII strings which will contain a checksum at the end of the string. The checksum will be verified when the system receives the string back. An error in the checksum will result in rejection of the string. In addition an error message will be sent to the PC when a string is received with an error. The user must watch for no more data on the screen to determine when the transmission of the download file is complete.

The following is a list of strings and the order that they will received in:

1.	DB_VERSION
2.	SYS_TIMERS
3.	DB_VERSION
14.	RELAY-BOX (1 thru 4)
5.	NIGHT-MODE
6.	HUNT-GROUP (450 thru 457)
7.	CO-LINE (1 thru 48)
8.	STATION (100 thru 195)
9.	KEYSET_BUTTONS (100 thru 195) where equipped
10.	DSS_BUTTONS (100 thru 195) where equipped
11.	UCD_GRP (550 thru 557)

12.	ACD_GRP (558 thru 565)
13.	UCD_TIMERS
14.	VOICE_MAIL_GRP (440 thru 448)
15.	VOICE-MAIL-OUTPULSE
16.	ALLOW-TABLE-A
17.	ALLOW-TABLE-B
18.	DENY-TABLE-A
19.	DENY-TABLE-B
20.	OFFICE-CODE TABLE
21.	AREA-CODE-TABLE
22.	3_DIGIT_ROUTE_TABLE
23.	G-DIGIT-ROUTE-TABLE (table entry)
24.	EXCEPTION-CODE-TABLE
25.	ROUTE-LIST-TABLE (table entry)
26.	INS/DEL-TABLE (table entry)
27.	DAILY-START-TABLE
28.	WEEKLY-START TABLE
29.	ROUTE-FOR-555-1 212
30.	SYSTEM-SPEED-BIN
31.	STA_SPEED_BIN (station 100 thru 195)
32.	SPEED-DIR (directory entry)
33.	ICLID_TRANS_TABLE (trans table entry)
34.	ICLID_UAC_TABLE uac table entry
35.	SPECIAL-TABLE
36.	PORT_TO-STATION
37.	PORT-TO-CO-LINE
38.	STATUS-REQUEST
39.	END-OF-FILE

Forward and backward compatibility is maintained. If the file being uploaded from the PC contains less information in a string than is required by the system database, the system will maintain default information in the area not covered by the string. If the file being uploaded from the PC contains more information in a string than is required by the system database, the system will ignore the additional information.



## CUSTOMER DATA BASE PROGRAMMING

To upload a database file:

1. On the PC, enter the following information after the first **ADM>** Prompt. Then press the **Enter** key.

```
4896 Digital Key-System
Erg. Ver. 0.071F DATE: 06/09/93 TIME: 13:33:19
ENTER PASSWORD:
adm>
adm> ENTER PROGRAM NO
adm>86
LOAD DATABASE ROUTINE
ENTER BUTTON NUMBER
adm>q
UPLOAD DATABASE
PRESS HOLD
adm>
```

2. On the PC, press the **Alt** + **C** keys to clear the screen. Press the **PgUp** key to bring up the upload screen. Enter an "A" to set the upload as an ASCII upload file.
3. This will bring up the ASCII upload file screen on the PC monitor.

```
-----
Upload Protocols
-----
X) XMODEM          A) ASCII
Z) ZMODEM          R) RAW ASCII
Y) YMODEM (Batch)  T) TELINK
G) YMODEM-G (Batch) M) MODEM7
O) IX-XMODEM       W) WMODEM
I) IX-XMODEM-G     F) FMODEM
C) COMUSERVE B-    L) TEXT 1
K) KERMIT           J) TEXT 2
S) SEALINK         B) TEXT 3
-----
* Your Selection: (press ENTER for ZMODEM)
```

4. Enter the path for the file to be uploaded to the system and press the **Enter** key. The file will now be uploaded to the system. Confirmation tone will be heard at the completion of the upload routine. If the **Enter** key was pressed during the download routine without a filename entered, the default filename will be: PCPLUS.LOG.

**NOTE**

*If the PCPLUS.LOG file is not renamed or deleted before the next download routine is performed, the downloaded information will append the existing .LOG file instead of over-writing it*

5. After the file is uploaded to the system, the **ADM>** prompt will be returned to the PC monitor. Enter an "M" at the prompt and press the **Enter** key.

```
adm>,
ENTER PROGRAM NO
adm>m
exiting admix...

DATE: 06/09/93 TIME: 13:25:11
exiting maintenance utility...
```

6. On the PC, press the **Alt** + **X** keys. Press the **Enter** key to exit Procomm and return to the DOS prompt.
7. After the upload procedure is completed, the system MUST be reset for full activation of the database programming to take effect.

**TABLE OF CONTENTS FOR SECTION 610**

<b>SECTION 610</b>	<b>SYSTEM PARAMETERS PROGRAMMING</b> .....	61 O-1
610.1	SYSTEM TIMERS .....	610-1
	A. System Hold Recall Timer .....	61 O-2
	B. Exclusive Hold Recall Timer .....	61 o-2
	C. Attendant Recall Timer.. .....	61 O-3
	D. Transfer Recall Timer .....	61 O-3
	E. Preset Forward Timer.. .....	61 O-4
	F. Call Forward No/Answer Timer.. .....	61 O-4
	G. Pause Timer .....	61 O-5
	H. Call Park Recall Timer.. .....	610-5
	I. <b>Conference/DISA</b> Timer.. .....	61 O-6
	J. Paging Timeout Timer .....	61 O-6
	K. CO Ring Detect Timer .....	610-7
	L. SLT DTMF Receiver Timer.. .....	61 O-7
	M. Message Wait Reminder Tone .....	61 O-8
	N. SLT Hook Flash Timer .....	61 O-8
	O. SLT Hook Flash <b>Debounce</b> Timer .....	61 O-9
	P. SMDR Call Qualification Timer.. .....	61 O-10
	Q. Automatic Call Back Timer .....	61 O-10
	R. Reminder Ring Timer.. .....	61 O-11
	S. Release Guard Timer .....	61 O-11
610.2	SYSTEM FEATURES PROGRAMMING .....	610-12
	A. Attendant Override.. .....	61 O-13
	B. Hold Preference.. .....	61 O-13
	C. External Night Ring.. .....	61 O-14
	D. Executive Override Warning Tone.. .....	61 O-14
	E. Page Warning Tone.. .....	61 O-15
	F. Background Music Channel.. .....	61 O-15
	G. LCR Enable .....	61 O-16
	H. Account Codes • Forced.. .....	61 O-16
	I. Group Listening .....	61 O-17
	J. Idle Speaker Mode.. .....	61 O-17
	K. Call Cost Display Feature.. .....	61 O-18
	L. Music On Hold .....	61 O-18
	M. Handset Receiver Gain.. .....	61 O-19
	N. Call Qualifier Tone Option .....	61 O-20
610.3	ADDITIONAL SYSTEM FEATURES PROGRAMMING.. .....	610-21
	A. Privacy Release Tone Option .....	61 O-21
610.4	FLASH RATES (Programmable) .....	61 O-22
	A. Incoming CO Line Ringing.. .....	61 O-22
	B. Incoming Intercom Ringing.. .....	61 O-23
	C. Call Forward .....	610-23

	D.    Message Waiting .....	61 O-23
610.5	ATTENDANT STATION ASSIGNMENT .....	.61 O-24
610.6	SYSTEM TIME AND DATE .....	.61 O-24
610.7	PBX DIALING CODES.. .....	61 O-25
610.8	EXECUTIVE/SECRETARY PAIRS .....	61 O-25
610.9	RELAY/SENSOR PROGRAMMING .....	61 O-26
	A.    Programming relay for External Paging: .....	61 O-27
	B.    Programming relay for RAN Starting.....	61 O-27
	C.    Programming relay for Power Failure Transfer: .....	61 O-28
	D.    Programming relay for Loud Bell Control*.....	61 O-29
	E.    Programming relay for CO Line Control.....	61 O-30
	F.    Assign Relay/Sensor Interface Module to a station.....	.61 O-30
	G.    Program sensing circuit as a RAN Sensing (RAN END) circuit:..	.61 O-3-1
610.10	BAUD RATE ASSIGNMENTS .....	.61 O-32
610.11	ACCESS CODES.. .....	61 O-33
	A.    DISA Access Code .....	61 O-33
	B.    Database Admin. Password .....	61 o-34
610.12	STATION MESSAGE DETAIL RECORDING (SMDR) .....	.61 o-35
	A.    SMDR Enable/Disable .....	61 o-35
	B.    Long Distance/Local Assignment .....	61 o-35
	C.    Character Print Assignment .....	61 O-36
	D.    Baud Rate Display .....	61 O-36
	E.    SMDR Port Assignments .....	.61 O-36
610.13	WEEKLY NIGHT MODE SCHEDULE .....	.61 o-37
	A.    Automatic/Manual Operation .....	61 o-37
	B.    Day of Week programming .....	61 O-37
610.14	DIRECTORY DIALING .....	61 O-38
610.15	FLEXIBLE CARD ASSIGNMENTS .....	61 o-41
610.16	HUNT GROUPS .....	61 O-42
	A.    Hunt Group Programming .....	61 O-42
	B.    Station/Pilot Hunting Assignment.. .....	61 O-42
610.17	LOCAL NUMBER/NAME TRANSLATION TABLE.. .....	.61 O-43

# SECTION 610

## SYSTEM PARAMETERS PROGRAMMING

### 610.1 SYSTEM TIMERS

Programming Steps

If the system is in the programming mode, continue using the program codes. If starting to program here, enter the programming mode. Refer to Sec. 600.2 , Program Mode Entry (Key Station).

If any System Timers are to be changed:

1. Press FLASH and dial [01]. The following message is shown on the display phone:

**SYSTEM TIMERS  
 ENTER BUTTON NUMBER**

Description

This section describes the procedures and steps necessary to program system timers.

The buttons on the digital terminal are defined as shown below when entering the System Timers programming.

1	Q	SYSTEM HOLD RECALL	CO RING DETECT	11	A
2	W	EXCL HOLD RECALL	DIS/SLT RCVR	12	S
3	E	ATTENDANT RECALL	MSG WAIT REMINDER	13	D
4	R	TRANSFER RECALL	HOOKFLASH	14	F
5	T	PRESET FORWARD	HKFLASH DEBOUNCE	15	G
6	Y	CALL FWD NO/ANS	SMDR CALL QUALIFICATION	16	H
7	U	PAUSE TIMER	AUTO CALLBACK TIMER	17	J
8	I	CALL PARK TIMER	REMINDER RING TIMER	18	K
9	O	CONF/DISA TIMER	RELEASE GUARD TIMER	19	L
10	P	PAGING TIMEOUT		20	:

PROGRAM CODE	FLEX BUTTON	FEATURE	DEFAULT VALUE (after initializing)
<b>SYSTEM TIMERS:</b>			
FLASH 01	1	System Hold Recall	060seconds
	2	Exclusive Hold Recall	180 seconds
	3	Attendant Recall Timer	01 minutes
	4	Transfer Recall Timer	045seconds
	5	Preset Forward Timer	10 seconds
	6	Call Forward No Answer	015seconds
	7	Pause Timer	2 seconds
	8	Call Park Timer	180 seconds
	9	Conference/D&A Timer	10 minutes
	10	Paging Timeout Timer	15 seconds
	11	CO Ring Detect Timer	300 milliseconds
	12	SLT DTMF Receiver Timer	020seconds
	13	MSG Wait Reminder Tone	000 minutes
	14	SLT Hook-flash Timer	10 (1 seconds)
	15	SLT Hook-flash Debounce	010 (.1 second)
	16	SMDR Call Qualification Timer	30 seconds
	17	Auto Call Back Timer	00 seconds (disabled)
	18	Reminder Ring Timer	00 seconds (disabled)
	19	Release Guard Timer	300 milliseconds

## SYSTEM PARAMETERS PROGRAMMING

## SYSTEM TIMERS (Cont'd)

## A. System Hold Recall Timer

Programming StepsDescription

If this timer is to be changed:

1. Press the SYSTEM HOLD RECALL TIMER flexible button (Button #1). The following message is shown on the display phone:

<b>SYS HOLD RECALL</b>	<b>000-300</b>
<b>060</b>	

2. Enter a three-digit timer value on the dial pad which corresponds to 001-300 seconds.
3. Press the HOLD button to save the entry. Confirmation tone is heard and the display will now update.

This timer determines the amount of time before a call placed on System Hold will recall the station placing the hold. If unanswered by that station, the call will recall the attendant.

**Default:** By default, the System Hold Recall Timer is set for 60 seconds and is variable from 001 to 300 seconds.

An entry of 000 will disable the timer and there will be no recall.

**Related Programming:** Refer to Sec. 610.2, Hold Preference for selecting System Hold Preference; Refer to Sec. 610.5, Attendant Station Assignment for assigning the Attendant(s) to receive recalls.

## B. Exclusive Hold Recall Timer

Programming StepsDescription

If this timer is to be changed:

1. Press the EXCLUSIVE HOLD RECALL TIMER flexible button (Button #2). The following message is shown on the display phone:

<b>EXC HOLD RECALL</b>	<b>000-300</b>
<b>180</b>	

2. Enter a three-digit timer value on the dial pad which corresponds to 001-300 seconds.
3. Press the HOLD button to save the entry. Confirmation tone is heard and the display will now update.

This timer determines the amount of time before a call placed on Exclusive Hold recalls the station placing the Hold. If unanswered by that station, the call recalls the attendant.

**Default:** By default, the Exclusive Hold Recall Timer is set for 180 seconds and is variable from 001 to 300 seconds.

An entry of 000 will disable the timer and there will be no recall.

**Related Programming:** Refer to Sec. 610.2, Hold Preference for selecting Exclusive Hold Preference; Refer to Sec. 610.5, Attendant Station Assignment for assigning the Attendant(s) to receive recalls.

EM TIMERS (Cont'd)

Attendant Recall Timer

Programming Steps

timer is to be changed:

Press the ATTENDANT RECALLTIMER flexible button (Button #3). The following message is shown on the display phone:

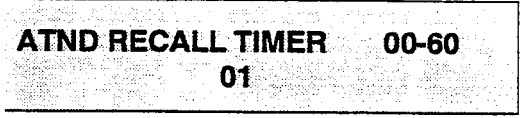

Enter a two-digit timer value on the dial pad which corresponds to 00-60 minutes.

Press the HOLD button to save the entry. Confirmation tone is heard and the display will now update.

Description

This timer determines the amount of time a recalling call will ring at the attendant station(s) before the system will release the line.

When a CO Line recalls to the Attendant station and is still unanswered, the system will release the line at the expiration of this timer and automatically place the line back to an idle condition.

**Default:** By default, the Attendant Recall Timer is set for 1 minute and is variable from 00 to 60 minutes.

An entry of 00 will cause the Attendant(s) to ring until answered.

**Related Programming:** Refer to Sec. 610.5, Attendant Station Assignment; Refer to Sec. 610.1, System Timers for the System Hold Recall Timer, Exclusive Hold Recall Timer, Call Park Recall Timer, and Transfer Recall Timer. Refer to Sec. 620 , CO Line Programming for Loop Supervision programming.

Transfer Recall Timer

Programming Steps

timer is to be changed:

Press the TRANSFER RECALL TIMER flexible button (Button 64). The following message is shown on the display phone:

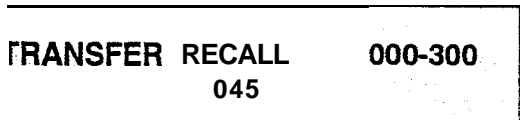

Enter a three-digit timer value on the dial pad which corresponds to 001-300 seconds.

Press the HOLD button to save the entry. Confirmation tone is heard and the display will now update.

Description

This timer determines the amount of time a transferred call rings at the station receiving the transfer before it recalls the station making the transfer. If unanswered by that station, the call recalls the attendant.

**Default:** By default, the Transfer Recall Timer is set for 45 seconds and is variable from 001 to 300 seconds.

A 000 entry disables the timer and there will be no recall.

**Related Programming:** Refer to Sec. 610.5, Attendant Station Assignment for assigning the Attendant(s) to receive recalls.

## SYSTEM PARAMETERS PROGRAMMING

## SYSTEM TIMERS (Cont'd)

## E. Preset Forward Timer

Programming Steps

If this timer is to be changed:

1. Press the PRESET FORWARD TIMER flexible button (Button #5). The following message is shown on the display phone:

<p><b>PRESET FWD TIMER</b>      <b>00-99</b> <b>10</b></p>
--

2. Enter a two-digit timer value on the dial pad which corresponds to 01-99 seconds.
3. Press the HOLD button to save the entry. Confirmation tone is heard and the display will now update.

Description

This timer determines the amount of time an outside line will ring before being forwarded to a predetermined station. This entry works with Preset Forward station assignments in Station Programming. More than one station can be forwarded to the same party.

This timer also governs the time the DISA call will ring at a station before being returned to intercom dial tone, if not answered.

**Default:** By default, the Preset Forward Timer is set at 10 seconds and is variable from 01 to 99 seconds.

A 00 entry disables the timer and there will be no forward.

**Related Programming:** Refer to Sec. 630.1, Station Attributes Programming, Preset Call Forward Programming for instruction on assigning a preset forward destination to a station.

## F. Call Forward No/Answer Timer

Programming Steps

If this timer is to be changed:

1. Press the CALL FORWARD NO/ANSWER TIMER flexible button (Button #6). The following message is shown on the display phone:

<p><b>CALL FWD NO ANS</b>      <b>000-600</b> <b>015</b></p>
--

2. Enter a three-digit timer value on the dial pad which corresponds to 000-600 seconds.
3. Press the HOLD button to save the entry. Confirmation tone is heard and the display will now update.

Description

This timer is used when a station in the system specifies that "no answer" calls be forwarded to another station. The timer determines how long an intercom or transferred call will ring before it is considered a "no-answer" call. The call will then forward to the designated station for handling.

**NOTE**

*Initial incoming CO lines will follow the Preset Call Forward Timer when encountering a station in the Forward/No answer mode. Refer to Section 610.1 for instructions on setting the Preset/Forward Timer*

**Default:** By default, the Call Forward No/Answer Timer is set for 15 seconds and is variable from 000-600 seconds.

**Related Programming:** Refer to Sec. 610.1, System Timers, Preset Forward Timer; Refer to 630.1, Station Attributes Programming, Call Forwarding option.

SYSTEM TIMERS (Cont'd)

G. Pause Timer

Programming Steps

If this timer is to be changed:

1. Press the PAUSE TIMER flexible button (Button #7). The following message is shown on the display phone:

<b>PAUSE TIMER</b>	<b>1-9</b>
<b>2</b>	

2. Enter a one-digit timer value on the dial pad which corresponds to 1-9 seconds.
3. Press the HOLD button to save the entry. Confirmation tone is heard and the display will now update.

Description

This timer determines the length of the pause when programmed for use with speed dialing and LCR Insert Tables.

**Default:** By default, the Pause Timer is set at 2 seconds and is variable from 1 to 9 seconds. There is no 0 entry.

H. Call Park Recall Timer

Programming Steps

If this timer is to be changed:

1. Press the CALL PARK RECALL TIMER flexible button (Button #8). The following message is shown on the display phone:

<b>CALL PARK TIMER</b>	<b>000-600</b>
<b>180</b>	

2. Enter a three-digit timer value on the dial pad which corresponds to 001-600 seconds.
3. Press the HOLD button to save the entry. Confirmation tone is heard and the display will now update.

Description

This timer determines the amount of time before a call placed in the call park location will recall the station placing the call park. If unanswered by that station, the call will recall the attendant.

**Default:** By default, the Call Park Recall Timer is set at 180 seconds and is variable from 001 to 600 seconds.

A 000 entry disables the timer and there will be no recall.

**Related Programming:** Refer to Sec. 610.5, Attendant Station Assignment for assigning the Attendant(s) to receive recalls.



SYSTEM TIMERS (Cont'd)

I. Conference/DISA Timer

Programming Steps

Description

If this timer is to be changed:

1. Press the CONFERENCE/DISA TIMER flexible button (Button #9). The following message is shown on the display phone:



2. Enter a two-digit timer value on the dial pad which corresponds to 01-99 minutes.
3. Press the HOLD button to save the entry. Confirmation tone is heard and the display will now update.

This timer determines the amount of time an unsupervised conference can continue after the initiator of the conference has exited the conference.

**Default:** By default, the Conference/DISA Timer is set at 10 minutes and is variable from 01 to 99 minutes.

A 00 entry disables the timer and means no automatic disconnect occurs.

**NOTE** The **Conference Timer** also **allows the system administrator to control the length of time a DISA caller is allowed after establishing a "Trunk-to-Trunk" call. At the expiration of the Conference Timer, a tone will be presented to both DISA pattles, then one minute later the system will automatically release both trunks. The Conference Timer does not affect or control a DISA-to-Station call.**

**Related Programming:** Refer to Sec. 620, CO Line Programming for DISA Trunk-to-Trunk (Per CO Line) programming; Loop Supervision Programming; and DISA Programming. Also refer to Sec. 630.1, Station Attributes Programming, Conference Enable/Disable (Per Station) option.

J. Paging Timeout Timer

Programming Steps

Description

If this timer is to be changed:

1. Press the PAGING TIMEOUTTIMER flexible button (Button #10). The following message is shown on the display phone:

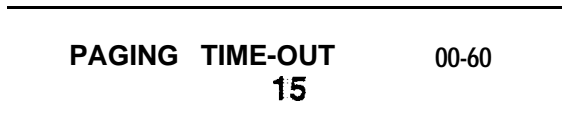

2. Enter a two-digit timer value on the dial pad which corresponds to 01-60 seconds.
3. Press the HOLD button to save the entry. Confirmation tone is heard and the display will now update.

This timer determines the maximum length of a page announcement (internal, external or all call). The system will automatically disconnect the page at the end of this time unless the person making the page has already hung up.

**Default:** By default, the Paging Timeout Timer is set at 15 seconds and is variable from 01 to 60 seconds. A 00 entry disables the timer and pages will not be limited in length.

**Related Programming:** Refer to Sec. 630.1, Station Attributes Programming for allowing stations access to the system paging resources.

SYSTEM TIMERS (Cont'd)

K. CO Ring Detect Timer

Programming Steps

Description

If this timer is to be changed:

This timer controls the time necessary to detect an outside line as ringing into the system.

1. Press the CO RING DETECT TIMER flexible button (Button #1 1). The following message is shown on the display phone:

**Default:** By default, the CO Ring Detect Timer is set at 3 (300 msec), and is variable from 2 to 9 (200msec. to 900msec). There is no 0 or 1 entry.

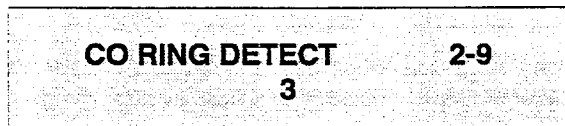

2. Enter a one-digit timer value on the dial pad which corresponds to 2-9 (200 msec. to 900 msec) .
3. Press the HOLD button to save the entry. Confirmation tone is heard and the display will now update.

L. SLT DTMF Receiver Timer

Programming Steps

Description

If this timer is to be changed:

Single line telephones require the use of a DTMF receiver when going off-hook and dialing. When SMDR or toll restriction, (via COS assignments) is enabled in the system a DTMF receiver will monitor and screen an SLT's digits for the duration of this timer. By adjusting this timer the system administrator may either free up system DTMF receivers sooner if system SLT traffic is heavy or provide for a longer monitoring period if toll restriction becomes a problem. It should be understood that when LCR is enabled the DTMF receivers are released when the expected number of digits are dialed as entered in the LCR database.

1. Press the SLT DTMF RECEIVER TIMER flexible button (Button #12). The following message will be shown on the display.



**Default:** By default, the SLT DTMF Receiver Timer is set at 20 seconds and is variable from 005 to 100 seconds.

2. Enter a three-digit timer value on the dial pad which corresponds to 005-1 00 seconds.
3. Press the HOLD button to save the entry. Confirmation tone is heard and the display will now update.

**Related Programming:** Refer to Sec. 610.12, SMDR Programming; Sec. 620.1, CO Line Programming, Class of Service (COS) Programming; Sec. 630.1, Station Attributes Programming, Station Class of Service (COS) options. Also refer to Sec. 665.2, LCR Tables Programming.

## SYSTEM TIMERS (Cont'd)

## M. Message Wait Reminder Tone

Programming Steps

If this feature is to be changed:

1. Press the MESSAGE WAIT REMINDER TONE flexible button (Button #13). The following message is shown on the display phone:

<b>M/W TONE TIMER</b>	<b>000-104</b>
<b>000</b>	

2. Enter a three-digit timer value on the dial pad which corresponds to 000 to 104 minutes.
3. Press the HOLD button to save the entry. Confirmation tone is heard and the display will now update.

Description

This timer determines the amount of time between repeated reminder tones to a key telephone with a message waiting.

Digital key station users may be reminded of a message waiting on their telephone with an audible signal presented at a timed interval.

**Default:** By default, the Message Wait Reminder Tone is set at 000 (disabled) and is variable from 000 to 104 minutes.

## N. SLT Hook Flash Timer

Programming Steps

If this timer is to be changed:

1. Press the SLT HOOK FLASH TIMER flexible button (Button #14). The following message is shown on the display phone:

<b>HOOK SWITCH TIME</b>	<b>05-20</b>
<b>10</b>	

2. Enter a two-digit timer value on the dial pad which corresponds to 0.520 seconds in 1/10 sec. increments.
3. Press the HOLD button to save the entry. Confirmation tone is heard and the display will now update.

Description

This timer determines how long an SLT user should press the hook switch in order for it to be considered a valid on hook (disconnect) request. An on-hook shorter in duration (but longer than the Hook Switch Bounce Timer) will be considered a Hook Flash (transfer) request. Refer to Figure 610-1 Hook Switch Activity.

**Default:** By default, the SLT Hook Flash Timer is set at 10 (one second) and is variable from 0.5 to 20 seconds.

**NOTE** Some single line telephones have a fixed or programmable Flash Timer (Flash or Tap button). This Hook Switch Timer must be set longer than the SLT Flash timer to allow Hook Flash transfer.

SYSTEM TIMERS (Cont'd)

O. SLT Hook Flash Debounce Timer

Programming Steps

Description

If this timer is to be changed:

1. Press the SLT HOOK FLASH DEBOUNCE TIMER flexible button (Button #15). The following message is shown on the display phone:

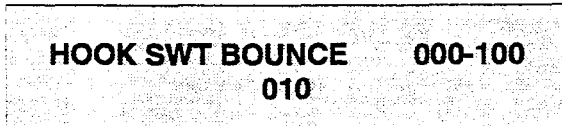

2. Enter a three-digit timer value on the dial pad which corresponds to O-I second in 10 msec increments.
3. Press the HOLD button to save the entry. Confirmation tone is heard and the display will now update.

This timer determines the length of time that is needed to determine a valid on-hook or off-hook condition for single line' telephones. On-Hook or Off-Hook signals that are shorter in duration than this timer will be ignored by the system. Refer to Figure 61 O-I Hook Switch Activity.

**Default:** By default, the SLT Hook Flash Debounce Timer is set to 0.10 sec. and is variable from 0 to 1 second in 10 msec increments. This entry is a three-digit entry where 010 equals .1 second.

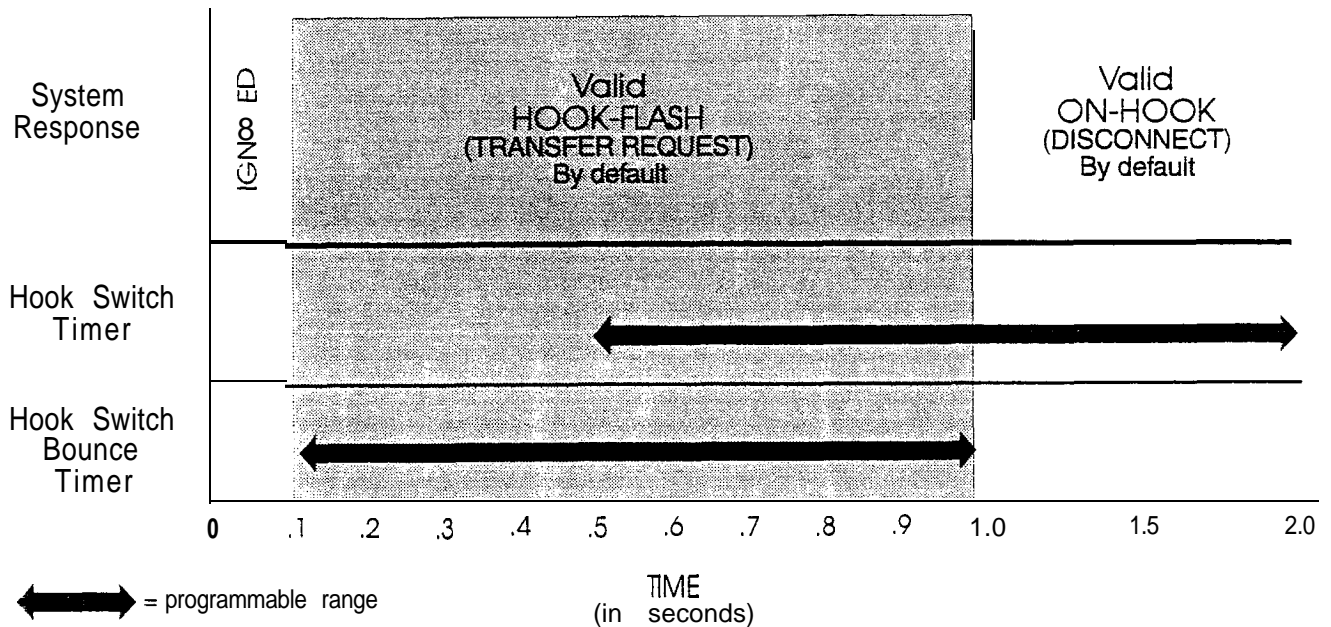

Figure 61 O-1 Hook Switch Activity

## SYSTEM TIMERS (Cont'd)

## P. SMDR Call Qualification Timer

Programming StepsDescription

If this timer is to be changed:

1. Press the SMDR CALL QUAL TIMER flexible button (Button #16). The following message is shown on the display phone:

<b>SMDR CALL QUAL</b>	<b>00-60</b>
<b>30</b>	

2. Enter a two-digit timer value on the dial pad which corresponds to 00-60 seconds in 1 sec. increments.
3. Press the HOLD button to save the entry. Confirmation tone is heard and the display will now update.

***This feature is available with optional software.***

This timer determines the length of time that is needed to determine a valid SMDR call for SMDR reporting purposes.

**Default:** By default, the SMDR Call Qualification Timer is set to 30 sec. and is variable from 00 to 60 seconds in 1 sec. increments.

## Q. Automatic Call Back Timer

Programming StepsDescription

If this timer is to be changed:

1. Press the AUTO CALL BACK TIMER flexible button (Button #17). The following message is shown on the display phone:

<b>00-99 AUTO CALL BACK</b>
<b>00</b>

2. Enter a two-digit timer value on the dial pad which corresponds to 00-99 seconds in 1 sec. increments.
3. Press the HOLD button to save the entry. Confirmation tone is heard and the display will now update.

To accommodate the reduced number of buttons on the Starplus Basic Keypad, a Call Back Feature has been added to system. This feature will invoke a call back anytime a user listens to busy tone for a preset period of time.

**Default:** By default, the Automatic Call Back Timer is set for 00 seconds (disabled), and is variable from 00 to 99 seconds.

An Automatic Call Back will not occur when this timer is disabled.

SYSTEM TIMERS (Cont'd)

R. Reminder Ring Timer

Programming Steps

If this timer is to be changed:

1. Press the REMINDER RING flexible button (Button #18). The following message is shown on the display phone:

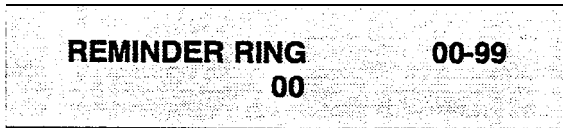

2. Enter a two-digit timer value on the dial pad which corresponds to 00-99 seconds in 1 sec. increments. A value of 00 disables the timer, therefore the user will only receive one burst of ring at the beginning of the call.
3. Press the HOLD button to save the entry. Confirmation tone is heard and the display will now update.

Description

When a Cd line rings at a busy station, the call rings at the-station using muted ringing. The CO Ringing Option feature allows a user to receive reminder ring at his station instead of muted ring. This timer provides a reminder ring every time the timer expires, as long as the incoming CO line remains connected.

If the user continues his present conversation and the CO party does not hang up, the Reminder Ring timer will expire and the user will receive another burst of ring. When the **keyset** user hangs up on his existing call, the ringing for the CO call will revert to normal ringing.

When the reminder ring option is used, the type of reminder ring tone is determined by the Tone Ring Option code [695] programmed on that **keyset**. It is also possible that this tone or a portion of this tone could be heard in the handset, depending on the **keyset** ring volume setting.

**Default:** By default, the Reminder Ring Timer is set to 00 sec. and is variable from 00 to 99 seconds in 1 sec. increments.

**Related Programming:** Refer to Sec. 630.1 , CO Line Ringing Options.

S. Release Guard Timer

Programming Steps

If this timer is to be changed:

1. Press the RELEASE GUARD TIMER flexible button (Button #19). The following message is shown on the display phone:

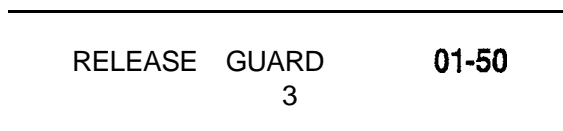

2. Enter a two-digit timer value on the dial pad which corresponds to 01-50 (0.1 sec. to 5.0 sec.)
3. Press the HOLD button to save the entry. Confirmation tone is heard and the display will now update.

Description

The Release Guard Timer is designed for the CO Line loop interface to accommodate the variations found from one Central Office to another. The timer is started whenever a CO line is released. If a user attempts to access a CO line before the Release Guard timer expires, his LED will illuminate indicating the CO line has been seized, however the CO line will not be seized until the timer expires. The user WILL NOT receive busy tone, but may get delayed CO dial tone if the timer is set to a large value.

**Default:** By default, the Release Guard timer is set for 3 for 300 milliseconds, and is variable from 100 milliseconds to 5 seconds.

SYSTEM PARAMETERS PROGRAMMING

610.2 SYSTEM FEATURES PROGRAMMING

Programming Steps

If the system is in the programming mode, continue using the program codes. If starting to program here, enter the programming mode. Refer to Sec. 600.2, Program Mode Entry (Key Station)

If any System Features are to be changed:

1. Press FLASH and dial [05]. The following message is shown on the display phone:

**SYS\_FEAT AO SY ENR EO PW  
BGM LCR AC G S CC MH V Q**

Description

This section describes the procedures and steps necessary to program System Features.

The buttons on the digital terminal are defined as shown below when entering the System Features programming area.

1	Q	ATTN OVERRIDE	CALL COST DISPLAY	11	A
2	W	HOLD PREF	MUSIC ON HOLD	12	S
3	E	EXT NIGHT RING	HANDSET RECEIVER	13	D
4	R	EXEC OVER WARN TONE	CALL QUALIFIER TONE OPTION	14	F
5	T	PAGE WARN TONE		15	G
6	Y	BACKGROUND MUSIC		16	H
7	U	LCR ENABLE		17	J
8	I	ACCOUNT CODES		18	K
9	Q	GROUP LISTENING		19	L
10	P	IDLE SPEAKER MODE		20	:

PROG CODE	FLEX BTN	FUNCTION	DEFAULT	CUSTOMER DATA
FLASH05	1	Attendant Override	Disabled	
	2	Hold Preference	System	
	3	External Night Ring	Disabled	
I	4	Executive Warning Tone	Enabled	
	5	Page Warning Tone	Enabled	
	6	Background Music	Enabled	
	7	LCR Enable	Disabled	
	8	Account Codes	Disabled	
	9	Group Listening	Disabled	
	10	Idle Speaker Mode	Yes	
	11	Call Cost Display Feature	Disabled	
	12	Music On Hold	Enabled	
	13	Handset Receiver Gain	Disabled	
	14	Call Qualifier Tone Option	Disabled	

SYSTEM FEATURES (Cont'd)

A. Attendant Override

Programming Steps

If this feature is to be changed:

1. Press the ATTN OVERRIDE flexible button (Button #1). This feature will toggle on and off with each depression, and the display will update with each depression.
  - LED off = Attendant Override is disabled
  - LED on = Attendant Override is enabled
2. Press the HOLD button to save the entry. Confirmation tone is heard.

```

SYS_FEAT AO SY ENR EO PW
BGM LCR AC G S CC MH V Q
```

Description

When this feature is enabled, it allows the attendant to override a busy station or a station in DND.

**Default:** By default, Attendant Override is disabled.

**Related Programming:** Refer to Sec. 610.5, Attendant Station Assignment for designating a station as an Attendant.

**NOTE** Attendant **override will** function ONLY **when** the Attendant station is **assigned a flex button assigned as Attendant Override.**

B. Hold Preference

Programming Steps

If this feature is to be changed:

1. Press the HOLD PEF flexible button (Button #2). This feature will toggle on and off with each depression, and the display will update with each depression.
  - LED off = Exclusive Hold is preferred
  - LED on = System Hold is preferred
2. Press the HOLD button to save the entry. Confirmation tone is heard.

```

SYS_FEAT AO SY ENR EO PW
BGM LCR AC G S CC MH V Q
```

Description

The system may be programmed to have either Exclusive or System Hold preferred. If Exclusive Hold is preferred, the user will press the HOLD button once for Exclusive Hold and twice for System Hold. If System Hold is preferred, the user will press the HOLD button once for System Hold and twice for Exclusive Hold.

Refer to System Timer programming for recall times for both System and Exclusive Hold.

**Default:** By default, Hold Preference is System Hold.

**Related Programming:** Refer to- Sec. 610.1, System Timers for the System Hold Recall Timer and Exclusive Hold Recall Timer.



## SYSTEM FEATURES (Cont'd)

## C. External Night Ring

Programming StepsDescription

If this feature is to be changed:

1. Press the EXT NIGHT RING flexible button (Button #3). This feature will toggle on and off with each depression, and the display will update with each depression.
  - LED off = Ext. Night Ring is disabled
  - LED on = Ext. Night Ring is enabled
2. Press the HOLD button to save the entry. Confirmation tone is heard.

When this feature is set to yes, it activates external night ring which produces a tone that is sent over all external page groups. When outside lines are marked UNA, ringing will activate a tone over external paging when an incoming call occurs on those lines during night service.

**Default:** By default, External Night Ring is disabled.

**Related Programming:** Refer to Sec. 610.9, Relay/Sensor Programming; Refer to Sec. 620.1, CO Line Programming for assigning UNA status to a CO Line(s).

```
SYS_FEAT AO SY ENR EO PW
BGM LCR AC G S CC MH V Q
```

## D. Executive Override Warning Tone

Programming StepsDescription

If this feature is to be changed:

1. Press the EXEC OVER WARN TONE flexible button (Button #4). This feature will toggle on and off with each depression, and the display will update with each depression.
  - LED off = Executive Override Tone disabled
  - LED on = Executive Override Tone enabled
2. Press the HOLD button to save the entry. Confirmation tone is heard.

A Station programmable option allows stations to be designated as "Executive" stations with the ability to override and "barge-in" on other keysets engaged in conversation on a CO line. Prior to actual cut through of the third party, a warning tone is presented to all parties notifying them of the "barge-in".

This warning tone however is a programmable option, on a system wide basis, that either enables or disables the tone. When the tone is disabled no audible signal is presented to the parties to signal the "barge-in".

```
SYS_FEAT AO SY ENR EO PW
BGM LCR AC G S CC MH V Q
```

**CAUTION:**

**USE OF THIS FEATURE WHEN THE EXECUTIVE OVERRIDE WARNING TONE IS DISABLED MAY BE INTERPRETED AS A VIOLATION OF FEDERAL, STATE OR LOCAL LAWS, AND AN INVASION OF PRIVACY. CHECK APPLICABLE LAWS IN YOUR AREA BEFORE. INTRUDING ON CALLS USING THIS FEATURE.**

**Default:** By default, Executive Override Warning Tone is enabled.

**Related Programming:** Refer to Sec. 630.1, Executive Override.

SYSTEM FEATURES (Cont'd)

E. Page Warning Tone

Programming Steps

Description

If this feature is to be changed:

1. Press the PAGE WARN TONE flexible button (Button #5). This feature will toggle on and off with each depression, and the display will update with each depression.
  - LED on = Page Warning Tone is enabled
  - LED off = Page Warning Tone is disabled
2. Press the HOLD button to **save** the entry. Confirmation tone is heard.

Determines whether a page warning tone will be sounded over the Key Telephone speakers or external paging speakers, **prior** to a page announcement.  
**Default:** By default, Page Warning Tone is enabled.  
**Related Programming:** Refer to Sec. 630.1, Station Attributes Programming for Paging Access and Page Group Assignments.

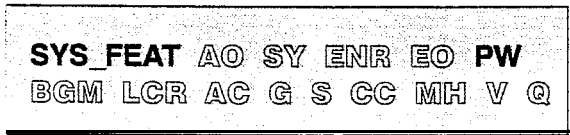

F. Background Music Channel

Programming Steps

Description

If Background Music is to be enabled/disabled:

1. Press the BACKGROUND MUSIC flexible button (Button #6). This feature will toggle on and off with each depression, and the display will update with each depression.
  - LED on = Background Music is enabled
  - LED off = Background Music is disabled
2. Press the HOLD button to save the entry. Confirmation tone is heard.

The system can be programmed to allow stations to activate Background Music at their stations, in addition to Music-On-Hold. A music source must be connected to the BGM/MOH connector on the CPU.  
**Default:** By default, the Background Music channel is enabled.  
**Related Programming:** Refer to Sec. 610.2, System Features Programming, Music On Hold for the Music-On-Hold assignment.

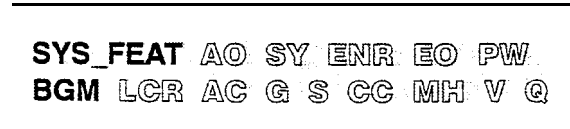

## SYSTEM PARAMETERS PROGRAMMING

## SYSTEM FEATURES (Cont'd)

## G. LCR Enable

Programming Steps

If this feature is to be assigned:

1. Press the LCR ENABLE flexible button (Button #7). This feature will toggle on and off with each depression, and the display will update with each depression.
  - LED on = LCR is enabled
  - LED off = LCR is disabled
2. Press the HOLD button to save the entry. Confirmation tone is heard.

```
SYS_FEAT AO SY ENR EO PW
BGM LCR AC G S CC MH V Q
```

Description

***This feature is available with optional software.***

If Least Cost Routing is to be used, it must be enabled here. Before enabling LCR, refer to the Least Cost Routing section and programming tables (Appendix A). When the tables have all been programmed, you may then enable LCR for the system. After system initialization, a default LCR database is loaded into the LCR section of memory. Refer to Figure 675-8 DB Printout of LCR Default.

**Default:** By default, LCR is disabled.

**Related Programming:** Refer to Sec. 665.1, LCR Tables Programming.

## H. Account Codes - Forced

Programming Steps

1. Press ACCOUNT CODES flexible button (Button #8) to determine whether the use of Account Codes will be forced or optional. This feature will toggle on and off with each depression, and the display will update with each depression.
  - LED ON = Account Codes are forced
  - LED OFF = Account Codes are optional
2. Press the HOLD button to save the entry. Confirmation tone is heard.

```
SYS_FEAT AO SY ENR EO PW
BGM LCR AC G S CC MH V Q
```

Description

***This feature is available with optional software.***

The system can force the use of account codes on all restricted calls.

If forced account code option is enabled, then a stations Class of Service is upgraded to day COS1, night COS1, when the account code is entered.

If forced account code option is disabled, then a stations Class of Service is not upgraded but the account code continues to be part of the SMDR record.

**Default:** By default, the use of account codes is not forced but optional.

**Related Programming:** Refer to Sec. 610.12, SMDR Programming

**SYSTEM FEATURES (Cont'd)**

**I. Group Listening**

Programming Steps

Description

If Group Listening is to be assigned:

All digital key terminals have built-in speakerphones. Station users may use the speaker to monitor a call while using the handset to converse with the outside party. This enables other people in the room to listen to both parties in the conversation. Group listening is not available when the station is in the headset mode.

1. Press the GROUP LISTENING flexible button (Button #9). This feature will toggle on and off with each depression, and the display will update with each depression.
  - LED on = Group Listening is enabled
  - LED off = Group Listening is disabled
2. Press the HOLD button to save the entry. Confirmation tone is heard.

**Default:** By default, Group Listening is disabled.

```
SYS_FEAT AO SY ENR EO PW  
BGM LCR AC G S CC MH V Q
```

**J. Idle Speaker Mode**

Programming Steps

Description

If the speaker mode needs to be assigned.

This feature allows the system to determine whether the first digit dialed is heard over the digital key terminal speaker. This feature can be allowed or denied on a system-wide basis in programming.

1. Press the IDLE SPEAKER MODE flexible button (Button #10). This feature will toggle on and off with each depression, and the display will update with each depression.
  - LED on = 1st digit dialed is heard.
  - LED off = 1st digit dialed is muted.
2. Press the HOLD button to save the entry. Confirmation tone is heard.

**Default:** By default, idle speaker mode is disabled.

```
SYS_FEAT AO SY ENR EO PW  
BGM LCR AC G S CC MH V Q
```

## SYSTEM PARAMETERS PROGRAMMING

## SYSTEM FEATURES (Cont'd)

## K. Call Cost Display Feature

Programming Steps

If Call Cost Display Feature is to be enabled:

1. Press the CALL COST DISPLAY flexible button (Button #11). This feature will toggle on and off with each depression, and the display will update with each depression.
  - LED on = Call Cost Display is enabled
  - LED off = Call Cost Display is disabled
2. Press the HOLD button to save the entry. Confirmation tone is heard.

```
SYS_FEAT AO SY ENR EO PW
BGM LCR AC G S CC MH V Q
```

Description

***This feature available with optional software.***

The Call Cost Display Feature provides a means for a user to view the approximate cost of each call made. This **approximate cost** Will also be printed as part of the SMDR record.

The Call Cost Display will replace the call duration display when a call is made using LCR. This display is enabled in programming.

The cost information is programmable by selecting one of the 16 route list tables and one of the four time periods. This allows the user to program four separate costs based on the time of day for each of 16 routes. The costs entered in the tables will be a cost for one minute, however, costs are calculated using a 1/10th of a minute value. These costs are rounded down and are based on the start time of the call, even if the call extends into a different time period. The SMDR printout will contain a cost calculated using a 1/10th of a minute increment, however the station display will update approximately every 30 seconds. The user must use LCR to get the call cost display.

**Default:** By default, the Call Cost Display Feature is disabled.

**Related Programming:** Refer to Sec. 610.2, System Features Programming, LCR Enable.

## L. Music On Hold

Programming Steps

If Music On Hold is to be disabled:

1. Press the MUSIC ON HOLD flexible button (Button #12). This feature will toggle on and off with each depression, and the display will update with each depression.
  - LED on = Music On Hold is enabled
  - LED off = Music On Hold is disabled
2. Press the HOLD button to save the entry. Confirmation tone is heard.

```
SYS_FEAT AO SY ENR EO PW
BGM LCR AC G S CC MH V Q
```

Description

A music source, when connected to the system, provides music to all lines on Hold, parked calls, transferred calls and calls waiting to be answered by Automatic Call Distribution (ACD) or Uniform Call Distribution (UCD). This feature can be allowed or denied on a system-wide basis in programming.

**Default:** By default, Music On Hold is enabled.

SYSTEM FEATURES (Cont'd)

M. Handset Receiver Gain

Programming Steps

If Handset Receiver Gain feature is to be enabled:

1. Press the HANDSET RECEIVER GAIN flexible button (Button #13). This feature will toggle on and off with each depression, and the display will update with each depression.
  - LED on = Handset Receiver Gain is enabled
  - LED off = Handset Receiver Gain is disabled
2. Press the HOLD button to save the entry. Confirmation tone is heard.

```
SYS_FEAT AO SY ENR EO PW
BGM LCR AC G S CC MH V Q
```

Description

The Handset Receiver Gain adjustment feature provides the user with a flexible button that allows the user to increase/decrease the receiver volume on his handset while on a CO call or intercom call.

While on a CO or intercom call, the user can depress the Handset Receiver Gain button. This flex button LED will illuminate. The user can then dial a number from 0-9, where 0 is the minimum setting and 9 is the maximum setting. If the user wishes, he can depress his [#] digit to increment his volume, one setting at a time, or his [\*] digit to decrease his volume, one setting at a time. The top line of the LCD display will display his present volume setting while the flex button is active. The user then depresses his flex button a second time when he has completed setting his volume and the LCD display will return to the normal CO or intercom display and the flex button LED will extinguish.

- A flex button can be programmed to decrease the Handset Receiver Gain using the code [638]+[\*].
- Another flex button can be programmed to increase the Handset Receiver Gain using the code [638]+[#].
- A flex button can also be programmed to have a certain volume setting using the code [638]+[1 thru 9].

**Default:** By default, the Handset Receiver Gain feature is disabled.

SYSTEM FEATURES (Cont'd)

N. Call Qualifier Tone Option

<u>Programming Steps</u>	<u>Description</u>
<p>If the Call Qualifier Confirmation Tone is to be enabled:</p> <ol style="list-style-type: none"> <li>1. Press the CALL QUALIFIER TONE OPTION flexible button (Button #14). This feature will toggle on and off with each depression, and the display will update with each depression.                             <ul style="list-style-type: none"> <li>• LED on = Confirmation tone is enabled</li> <li>• LED off = Confirmation tone is disabled</li> </ul> </li> <li>2. Press the HOLD button to save the entry. Confirmation tone is heard.</li> </ol>	<p>This feature is associated with the ACD Call Qualifier code and determines if a confirmation tone will be heard after the ACD Call Qualifier code is dialed. The ACD Call Qualifier code will permit up to 12-digits to be entered, however only the first four digits are provided for in the SMDR record.</p> <p><b>Default:</b> By default, the Call Qualification Confirmation tone is disabled.</p>

```

SYS_FEAT AO SY ENR EO PW
BGM LCR AC G S CC MH V Q
    
```

610.3 ADDITIONAL SYSTEM FEATURES PROGRAMMING

Programming Steps

If the system is in the programming mode, continue using the program codes. If stating to program here, enter the programming mode. Refer to Sec. 600.2, Program Mode Entry (Key Station)

If any System Features are to be changed:

1. Press FLASH and dial [06]. The following message is shown on the display phone:

**SYSTEM FEATURES  
ENTER BUTTON NUMBER**

**A. Privacy Release Tone Option**

Programming Steps

If the Privacy Release Tone is to be changed:

1. Press the PRIVACY RELEASE TONE OPTION flexible button (Button #1). The following message is shown on the display phone:

**BARGE IN WARN TONE 0-1  
ENABLED**

2. Enter a one-digit value on the dial pad to enable or disable the conference tone.
  - [0] = Disabling of conference tone
  - [1] = Enabling of conference tone
3. Press the HOLD button to save the entry. Confirmation tone is heard.

**NOTE** *Display stations will continue to receive the "CONFERENCE" display regardless of the warning tone setting.*

Description

This section describes the procedures and steps necessary to program System Features.

The buttons on the, digital terminal are defined as shown below when entering the System Features programming area:

Q 1	PRIVACY RELEASE TONE OPTION		11 A
W 2			12 S
E 3			13 D
R 4			14 F

Description

Privacy is insured on all communications in the system. If desired, the customer may elect to disable the Automatic Privacy feature, thus allowing up to three other stations to join in on an existing CO Line conversations.

**NOTE** *Disabling of the privacy feature may be limited by federal, state or local law, so check the relevant laws in your area before disabling privacy.*

- Per CO Line Option: This feature allows each CO line to be individually programmed for privacy. This feature is useful for maintaining security on such lines as Data lines, Private lines, or special circuits requiring privacy. If privacy is disabled on a CO line then, while in use, another station may enter the conversation simply by pressing the CO line button. A programmable warning tone is presented to all parties prior to actual cut-thru. The station attempting to enter the conversation must also have privacy disabled.
- Per Station Option: Each station may be programmed to give the station the capability to join an existing conversation simply by pressing the CO line button that is in use. A programmable warning tone is presented to all parties when the station enters the conversation. The CO line must also have privacy disabled to allow the cut-thru.

**Default:** By default, the Privacy Release tone is enabled.



SYSTEM PARAMETERS PROGRAMMING

MISC. SYSTEM PARAMETERS

610.4 FLASH RATES (Programmable)

Programming Steps

If the system is in the programming mode, continue using the program codes. If starting to program here, enter the programming mode. Refer to Sec. 600.2, Program Mode Entry (Key Station)

If Flash Rate(s) are to be changed:

- a. Press FLASH and dial [07]. The following message is shown on the display phone:

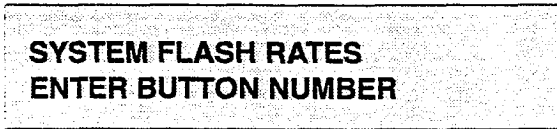

Description

This section describes the procedures and steps necessary to program the Flash Rates.

The buttons on the digital terminal are defined as shown below when entering the Flash Rates programming area:

Q 1	INCOMING CO RINGING	11	A
W 2	INCOMING INTERCOM RINGING	12	S
E 3	CALL FORWARD	13	D
R 4	MESSAGE WAITING	14	F

The available flash rates are as follows:

00 = Off
01 = Steady On
02 = 30 ipm flash
03 = 60 ipm flash
04 = 240 ipm double wink
05 = 240 ipm flash
06 = 240 ipm flutter
07 = 480 ipm flash
08 = 480 ipm flutter
09 = 480 ipm flash
10 = 120 ipm flash
11 = 120 ipm flutter
12 = 480 ipm wink
13 = 240 ipm wink
14 = 240 ipm quad wink
15 = 480 ipm triple wink

A. incoming CO Line Ringing

Programming Steps

If Incoming CO Line Ringing flash Rate is to be changed:

- a. Press the INCOMING CO RINGING flexible button (Button #1). The following message is shown on the display phone:



Description

The Incoming CO Line Ringing flash rate can be programmed to 16 different options identified in the flash rate table. This allows the user to customize the key system configuration to desired flash rates.

**Default:** By default, the Incoming CO Ringing is set for a 30 ipm flash rate.

- b. Enter a two-digit value on the dial pad to correspond to one of the 16 available options. Refer to flash rate table.
- c. Press the HOLD button to save the entry. Confirmation tone is heard and the display will now update.

FLASH RATES (Cont'd)

B. Incoming Intercom Ringing

Programming Steps

- a. Press the INCOMING INTERCOM RINGING flexible button (Button #2). The following message is shown on the display phone:

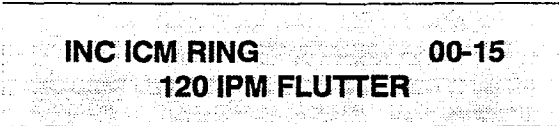

- b. Enter a two-digit value on the dial pad to correspond to one of the 16 available options. Refer to flash rate table.
- c. Press the HOLD button to save the entry. Confirmation tone is heard and the display will now update.

c. **Call Forward**

Programming Steps

- a. Press the CALL FORWARD flexible button (Button #3). The following message is shown on the display phone:

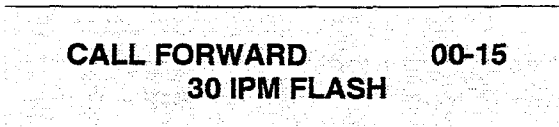

- b. Enter a two-digit value on the dial pad to correspond to one of the 16 available options. Refer to flash rate table.
- c. Press the HOLD button to save the entry. Confirmation tone is heard and the display will now update.

D. **Message Waiting**

Programming Steps

- a. Press the MESSAGE WAITING flexible button (Button #4). The following message is shown on the display phone:

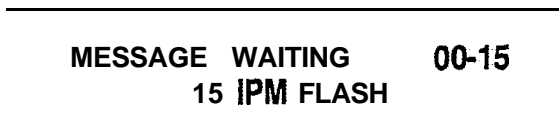

- b. Enter a two-digit value on the dial pad to correspond to one of the 16 available options. Refer to flash rate table.
- c. Press the HOLD button to save the entry. Confirmation tone is heard and the display will now update.

Description

The Incoming Intercom Ringing flash rate can be programmed to 16 different options identified in the flash rate table. This allows the user to customize the key system configuration to desired flash rates.

**Default:** By default, the Incoming Intercom Ringing is set for a 120 ipm flutter rate.

Description

The Call Forward flash rate can be programmed to 16 different options identified in the flash rate table. This allows the user to customize the key system configuration to desired flash rates.

**Default:** By default, Call Forward is set for a 30 ipm flash rate.

Description

The Message Wait flash rate can be programmed to 16 different options identified in the flash rate table. This allows the user to customize the key system configuration to desired flash rates.

**Default:** By default, Message Waiting is set for a 15 ipm flash rate.

MISC. SYSTEM PARAMETERS

610.5 ATTENDANT STATION ASSIGNMENT

Programming Steps

If Attendant Station(s) are to be changed:

- a. Press FLASH and dial [10]. The following message is shown on the display phone:

**ATND STA ASSIGNMENT**  
**100, ###, ###**

- b. Enter up to three three-digit station number(s) on the dial pad.
- c. Press the HOLD button to save the entry. Confirmation tone is heard and the display will now update.

Description

The system will identify an attendant station for the purpose of receiving recalls and activating night service. The system can have up to three attendant(s) programmed.

Entering three pounds [###] will remove that attendant assignment or different station numbers can be programmed.

**Default:** By default, Station 100 is assigned as the first attendant.

**Related Programming:** Refer to Sec. 610.1, System Timers for the System Hold Recall Timer, Exclusive Hold Recall Timer, Call Park Recall Timer, and Attendant Recall Timer; Sec. 610.2, System Features Programming, Attendant Override; Sec. 610.13, Weekly Night Mode Schedule programming.

610.6 SYSTEM TIME AND DATE

Programming Steps

To set the time and date which appears on display Digital Terminals:

- a. Press FLASH and dial [11]. The following message is shown on the display phone.

**DATE & TIME**  
**MM/DD/YY    HH:MM am**

- b. Choose display format by pressing the appropriate button in the flexible button field.
- c. Press the HOLD button or dial in the time and date as follows (twelve digits):  
 YYMMDDHHMMSS
- d. Press the HOLD button to save the entry. Confirmation tone is heard and the display will now update.

Description

The date can be displayed in either the US (month/day) format or the European (day/month) format on Executive Display stations. In addition, the time can be displayed in either the standard 12 hour format or the 24 hour format.

The buttons on the digital terminal are defined as shown below when entering the System Time and Date programming area:

Q	1	MONTH/DAY; 12 HR	11	A
W	2	DAY/MONTH; 12 HR	12	S
E	3	MONTH/DAY; 24 HR	13	D
R	4	DAY/MONTH; 24 HR	14	F

When entering the time and date, use the following data:

- YY (year) = 00 to 99
- MM (month) = 01 to 12
- DD (day) = 01 to 31
- HH (hour) = 00 to 23
- MM (minute) = 00 to 59
- SS (second) = 00 to 59 (optional)

Default: By default, the date is set for month/day format and the time is in the 12 hour format.

**Related Programming:** Sec. 320.22, Setting System Time and Date from the first programmed attendant

**NOTE** *The Time and Date can be changed or set by the First Attendant station using dial code [692]*

MISC. SYSTEM PARAMETERS (Cont'd)

610.7 PBX DIALING CODES

Programming Steps

If PBX Dialing Codes are to be assigned:

- a. Press FLASH and dial [12]. The following message is shown on the display phone:

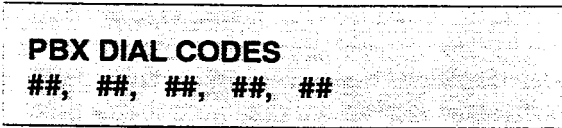

- b. Enter five two-digit code numbers, one right after the other, on the dial pad up to a maximum of ten digits.
- c. Press the HOLD button to save the entry. Confirmation tone is heard and the display will now update.

Description

Five one or two-digit PBX access codes can be programmed into memory. When dialed, these codes signal the system so that toll restriction is applied at the next dialed digit. When a single digit code [9] is entered, it must be followed by the pound [#] as the second digit.

To delete an entry, enter two pounds [##] and press the HOLD button.

Lines must be programmed as PBX lines before these codes will apply.

**Default:** By default, no PBX dialing codes are assigned.

**Related Programming:** Refer to Sec. 620, CO Line Programming for assigning a CO Line(s) as PBX Line(s).

610.8 EXECUTIVE/SECRETARY PAIRS

Programming Steps

If Executive/Secretary pairs are to be assigned:

- a. Press FLASH and dial [1 3]. The following message is shown on the display phone:



- b. The top left button in the flexible button field will be lit indicating the first pair may be programmed.
- c. Enter the three-digit Executive station number.
- d. Enter the three-digit Secretary station number.
- e. Press the HOLD button to save the data. Confirmation tone is heard and the display will now update.
- f. To program a second pair, press the second flexible button in the flexible button field and enter station numbers as in steps c., d., and e.
- g. To program a third pair, press the third button in the flexible button field and enter station numbers as in steps c., d., and e.
- h. To program a fourth pair, press the fourth button in the flexible button field and enter station numbers as in steps c., d., and e.

Description

There are four Executive/Secretary pairs available. When an Executive station is busy or in DND, intercom calls and transfers will be automatically routed to the designated Secretary.

The buttons on the key telephone are defined as shown below when entering the Executive/Secretary programming area:

Q	1	EXEC/SECY PAIR 1	11	A
W	2	EXEC/SECY PAIR 2	12	S
E	3	EXEC/SECY PAIR 3	13	D
R	4	EXEC/SECY PAIR 4	14	F

The assigned secretary may, however, Camp-On to the Executive Station when the station is busy or in Do-Not-Disturb.

There can be only one pairing of stations, with no duplicates. You cannot pair Executive 100 to Secretary 101 and then pair Secretary 101 to Executive 100. You can have the same Secretary station for more than one Executive station (101 to 105 and 102 to 105).

An entry of six pounds [#####] will remove the assignments. Individual pairs may be changed by pressing the associated flexible button.

**Default:** By default, no Exec/Sec'y pairs are assigned.

SYSTEM PARAMETERS PROGRAMMING

MISC. SYSTEM PARAMETERS (Cont'd)

610.9 RELAY/SENSOR PROGRAMMING

Programming Steps

Description

**NOTE** *It is necessary to assign a Station ID to the station port used for a Relay/Sensor Interface Module. Refer to Sec. 630.2, Item A. Station Identification before proceeding.*

If Relays are to be assigned:

- a. Press FLASH and dial [14]. Relay #1 (Flex Button #1) and Relay/Sensor #1 (Flex Button #12) LEDs will be lit indicating the system is in the programming mode. The following message is shown on the display phone:

RELAY/SENSOR YYY  
RELAY 1 = NONE

**NOTE** *It is necessary to assign a station number to the Relay/Sensor Interface Module. Refer to "E" in this section.*

The Starplus SPD 4896 system offers relays that may be individually programmed for: External Page, Loud Bell Control, CO Line Control, Power Failure Transfer, and Recorded Announcement uses. Up to four Relay/Sensor interface modules may be installed on the system. Each Relay/Sensor Interface module contains three independent relays and three sensing input circuits.

The buttons on the digital terminal are defined as shown below when entering the Relay/Sensor programming area:

Q	1	RELAY 1		11	A
W	2	RELAY 2	RELAY/SENSOR #1	12	S
E	3	RELAY 3	RELAY/SENSOR #2	13	D
R	4	RELAY 4/SENSOR 1	RELAY/SENSOR #3	14	F
T	5	RELAY 5/SENSOR 2	RELAY/SENSOR #4	15	G
Y	6	RELAY 6/SENSOR 2			
U	7			17	J
I	8	STATIONS		18	K

Where:

- Button #12 = Relay/Sensor Interface Module #1 programming
- Button #13 = Relay/Sensor Interface Module #2 programming
- Button #14 = Relay/Sensor Interface Module #3 programming
- Button #15 = Relay/Sensor Interface Module #4 programming

**Default:** By default, there is no relay programming.

**Related Programming:** Refer to Sec. 645.1, Automatic Call Distribution (ACD), ACD Recorded Announcement Assignment(s); or Sec. 650.1, Uniform Call Distribution (UCD), UCD Recorded Announcement Assignment(s) for RAN Table programming.

**RELAY/SENSOR PROGRAMMING (Cont'd)****A. Programming relay for External Paging:**

- | <u>Programming Steps</u>   | <u>Description</u>  |
|--|---|
| 1. Press the appropriate flex button 12 thru 15 to indicate which Relay/Sensor interface Module is to be programmed. | <b>EXTERNAL PAGE RELAY:</b> When assigning a relay as an External Page relay, the relay will activate when the external page zone the relay is assigned to is accessed. The relay will remain activated during the page announcement until the station hangs up or the page timer expires and releases the page zone.<br><br>To disable a relay or sensor circuit:<br>a. Press the desired flex button that corresponds to the relay or sensor circuit to be disabled.<br>b. Dial [0] on the dial pad.<br>c. Press the HOLD button to save the entry. Confirmation tone is heard and the display will now update. |
| 2. Press flex buttons (1-3) to indicate the desired relay to be programmed.  |   |
| 3. Dial [1] on the dial pad.   |   |
| 4. Enter a one-digit page zone number (1-7)  |   |
| 5. Press the HOLD button to save the entry. Confirmation tone is heard and the display will now update.              |   |

**RELAY SENSOR   YYY**  
**RELAY 1 = EXT PAGE 76X**

Where:

- X= Page Zones 1 thru 7

**B. Programming relay for RAN Starting:**

- | <u>Programming Steps</u>   | <u>Description</u>  |
|--|---|
| 1. Press the appropriate flex button 12 thru 15 to indicate which Relay/Sensor interface Module is to be programmed. | <b>RAN START RELAY:</b> When a CO line port is used for a ground start application, a 24V dc power source must be connected to the CO line port for talk battery. When an SLT port is used, the RAN device must be configured for ring trip operation (loop start). The 90V ac voltage sent to the SLT port will be recognized by the RAN device which will then answer the call.<br><br>To disable a relay or sensor circuit:<br>a. Press the desired flex button that corresponds to the relay or sensor circuit to be disabled.<br>b. Dial [0] on the dial pad.<br>c. Press the HOLD button to save the entry. Confirmation tone is heard and the display will now update. |
| 2. Press flex buttons (1-3) to indicate desired relay to be programmed.  |   |
| 3. Dial [2] on the dial pad.   |   |
| 4. Enter a one-digit RAN Table number (1 thru 8) the relay should be associated to.                                  |   |
| 5. Press the HOLD button to save the entry. Confirmation tone is heard and the display will now update.              |   |

**RELAY/SENSOR   YYY**  
**RELAY 1 = RAN START X**

Where:

- X= RAN Table number

**Related Programming:** Refer to Sec. 645.1, Automatic Call Distribution (ACD), ACD Recorded Announcement Assignment(s); or Sec. 650.1, Uniform Call Distribution (UCD), UCD Recorded Announcement Assignment(s) for RAN Table programming.

## RELAY/SENSOR PROGRAMMING (Cont'd)

## C. Programming relay for Power Failure Transfer:

Programming Steps

1. Press the appropriate flex button 12 thru 15 to indicate which Relay/Sensor interface Module is to be programmed.
2. Press flex buttons (1-3) to indicate desired relay to be programmed.
3. Dial [3] on the dial pad.
4. Press the HOLD button to save the entry. Confirmation tone is heard and the display will now update.

**RELAY/SENSOR   YYY**  
**RELAY 1 = POWER FAIL**

Description

**POWER FAILURE TRANSFER:** When the Starplus Power Failure Transfer Unit is used for Power Failure, it provides the relay transfer circuits for up to 12 CO lines in the event of a power or processor failure. Activation of the PFT relays is controlled by the Relay/Sensor Module. A customer provided 12 volt DC power supply is required to operate the unit.

With loss of power to the system or a failure of system processing, the PFTU will automatically connect up to 12 CO lines to pre-wired 500/2500 type telephones. When power is restored, the PFTU will automatically restore the CO trunks and stations to normal operation. These SLT stations do not have to be used for intercom, but can be if so desired.

To disable a relay or sensor circuit:

- a. Press the desired flex button that corresponds to the relay or sensor circuit to be disabled.
- b. Dial [0] on the dial pad.
- c. Press the HOLD button to save the entry. Confirmation tone is heard and the display will now update.

RELAY/SENSOR PROGRAMMING (Cont'd)

D. Programming relay for Loud Bell Control:

Programming Steps

1. Press the appropriate flex button 12 thru 15 to indicate which Relay/Sensor Interface Module is to be programmed.
2. Press flex buttons (1-3) to indicate desired relay to be programmed.
3. Dial [4] on the dial pad.
4. Enter the three-digit station number (100-1 95)
5. Press the HOLD button to save the entry. Confirmation tone is heard and the display will now update.

RELAY/SENSOR   YYY  
RELAY 1 = LOUD BELL XXX

Where:

- XXX= Station number

Description

**LOUD BELL CONTROL:** There are three control contacts on the Relay/Sensor Module, which can be individually programmed as Loud Bell Control to control a customer provided ringing device to external areas.

Loud Bell Control contacts can be assigned to any station and will follow the ringing assignments of that station including tone tinging intercom, and transferred CO lines.

Remember to assign ringing to any station programmed for Loud Bell Control.

To disable a relay circuit:

- a. Press the desired flex button that corresponds to the relay or sensor circuit to be disabled.
- b. Dial [0] on the dial pad.
- c. Press the HOLD button to save the entry. Confirmation tone is heard and the display will now update.



## SYSTEM PARAMETERS PROGRAMMING

## RELAY/SENSOR PROGRAMMING (Cont'd)

## E. Programming relay for CO Line Control:

- | <u>Programming Steps</u>   | <u>Description</u>  |
|--|---|
| 1. Press the appropriate flex button 12 thru 15 to indicate which Relay/Sensor Interface Module is to be programmed. | <p><b>CO LINE CONTROL:</b> There are three control contacts on the Relay/Sensor Module, which can be individually programmed as CO Line Control to control customer provided ancillary equipment. When programmed as CO Line Control and assigned to a CO line, the corresponding contact will close whenever that CO line is accessed.</p> <p>To disable a relay or sensor circuit:</p> <ol style="list-style-type: none"> <li>Press the desired flex button that corresponds to the relay or sensor circuit to be disabled.</li> <li>Dial [0] on the dial pad.</li> <li>Press the HOLD button to save the entry. Confirmation tone is heard and the display will now update.</li> </ol> |
| 2. Press flex buttons (1-3) to indicate desired relay to be programmed.  |   |
| 3. Dial [5] on the dial pad.   |   |
| 4. Enter a two-digit CO Line number (0-i-48)   |   |
| 5. Press the HOLD button to save the entry. Confirmation tone is heard and the display will now update.              |   |

```
RELAY/SENSOR  YYY
RELAY 1 = CO LINE XX
```

Where:

- XX= CO Line number

## F. Assign Relay/Sensor Interface Module to a station:

- | <u>Programming Steps</u>  | <u>Description</u>   |
|---|--|
| 1. Press the STA flex button (Button #8).   | <p><b>STATION ASSIGNMENTS:</b> The programming of this station represents the station port that the Relay/Sensor Module is connected to.</p> <p>To delete a station assignment:</p> <ol style="list-style-type: none"> <li>Press the STA flex button (Button #8).</li> <li>Dial three pounds [###] on the dial pad.</li> <li>Press the HOLD button to save the entry. Confirmation tone is heard and the display will now update.</li> </ol> <p><b>Related Programming:</b> It is necessary to assign a station ID to the station port used for a Relay/Sensor Interface module first in Sec. 630.1, Station Attributes Programming.</p> |
| 2. Enter the three-digit station assignment of the relay sensor.  |  |
| 3. Press the HOLD button to save the entry. Confirmation tone is heard and the display will now update. |  |

```
RELAY/SENSOR  YYY
SENSOR 1 = NONE
```

Where:

- YYY= Station Assignment

RELAY/SENSOR PROGRAMMING (Cont'd)

G. Program sensing circuit as a RAN Sensing (RAN END) circuit:

- | <u>Programming Steps</u>   | <u>Description</u>   |
|--|--|
| 1. Press the appropriate flex button 12 thru 15 to indicate which Relay/Sensor interface Module is to be programmed. | <b>RAN SENSING (RAN END):</b> The Recorded Announcement feature (RAN) is used with the Automatic Call Distribution (ACD) feature or the Uniform Call Distribution (UCD) feature to provide unanswered incoming CO calls or calls in queue with a Recorded Announcement while waiting for an available ACD or UCD station. The system may be programmed to provide this announcement on specified RAN output ports on the system (unused SLT and CO ports). The system can be programmed to connect the waiting caller to a different RAN port for the second, and subsequent RAN messages.<br><br>When a CO line port is used for a ground start application, a 24V dc power source must be connected to the CO line port for talk battery. A relay contact on the Relay/Sensor Module assigned to an announcement table in programming would provide the contact closure to start the Recorded Announcement device.<br><br>To disable a sensor circuit: <ol style="list-style-type: none"><li>Press the desired flex button that corresponds to the relay or sensor circuit to be disabled.</li><li>Dial [0] on the dial pad.</li><li>Press the HOLD button to save the entry. Confirmation tone is heard and the display will now update.</li></ol><br><b>Related Programming:</b> Refer to Sec. 645.1, Automatic Call Distribution (ACD), ACD Recorded Announcement Assignment(s); or Sec. 650.1, Uniform Call Distribution (UCD), UCD Recorded Announcement Assignment(s) for RAN Table programming. |
| 2. Press flex buttons (4-6) to select the sensing circuit to be programmed.  |  |
| 3. Dial [6] on the dial pad.   |  |
| 4. Enter a one-digit RAN Table number (1-8) the sensing circuit should be associated to.                             |  |
| 5. Press the HOLD button to save the entry. Confirmation tone is heard and the display will now update.              |  |

RELAY/SENSOR YYY  
SENSOR 1 = RAN END X

Where:

→ X= RAN Table number

MISC. SYSTEM PARAMETERS (Cont'd)

610.10 BAUD RATE ASSIGNMENTS

Programming Steps

If Baud Rate(s) are to be assigned:

1. Press FLASH and dial [15]. The first button will be lit and ready for programming Port #1. The following message is shown on the display phone:

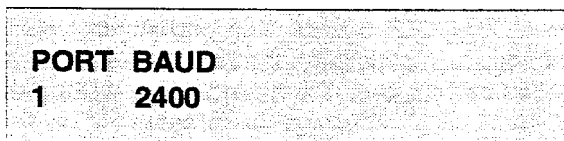

Description

The Starplus Digital Key Telephone System provides outputs such as SMDR or ICLID to the standard RS-232C "On-Board" connector (future) on the Central Processor Unit (CPU) or to the optional Backplane RS-232C I/O Expander Module connector(s). When features such as SMDR or ICLID are desired, the Baud Rate(s) need to be programmed to determine how the information will be distributed.

The buttons on the digital terminal are defined as shown below when entering the Baud Rate assignments programming area.

Q	1	PORT #1-CPB RS-232C		If A	
W	2	PORT #2-MODEM		12	S
E	3	PORT #3-IO RS-232C		13	
R	4	PORT #4-IO RS-232C		14	F

To program the Baud Rate(s) for Ports #1, #3, #4:

Programming Steps

1. Press the desired PORT # flexible button (Buttons #1, #3, or #4) to determine the port to be programmed.
2. Enter a one-digit number for the Baud Rate:
  - [1] = 300 Baud
  - [2] = 1200 Baud
  - [3] = 2400 Baud
  - [4] = 4800 Baud
  - [5] = 9600 Baud
3. Press the HOLD button to save the entry. Confirmation tone is heard and the display will now update.

Description

**PORT #1:** Port #1 is the "On-Board" RS-232C port on the SPD 4896 system.(Future use)

**PORT #3:** Port #3 is the RS-232C connector on the Backplane I/O Expander Module used in the Starplus Digital Key Telephone system.

**PORT #4:** Port #4 is the RS-232C connector on the Backplane I/O Expander Module used in the Starplus Digital Key Telephone system.

**Default:** By default, Port #1 (CPU RS-232C), Port #3 (RS-232C) and Port #4 (RS-232C) Baud Rates are 2400 Baud.

**Related Programming:** Refer to Sec. 610.12, SMDR Programming features; Refer to Sec. 640.1, ICLID Programming.

To verify Port #2 Baud Rate:

Programming Steps

1. Press the PORT #2 flexible button (Button #2). to verify the baud rate of the "On-Board" modem (future). The following message is shown on the display phone:



Description

**PORT #2:** Port #2 is the "On-Board" 1200 Baud modem which is included in the SPD 4896 Digital system.

**Default:** By default, the "On-Board" modem Baud Rate is 1200 Baud.

**MISC. SYSTEM PARAMETERS (Cont'd)**

**610.11 ACCESS CODES**

Programming Steps

If the system is in the programming mode, continue using program codes. If starting to program here, enter the programming mode. Refer to Sec. 600.2, Program Mode Entry (Key Station).

If Access Codes are to be changed:

1. Press FLASH and dial [20]. The following message is shown on the display phone:

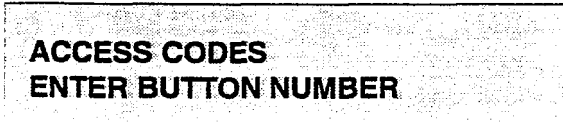

Description

This section describes the procedures and steps necessary to program **Access** codes.

The buttons on the digital terminal are defined as shown below when entering the **Access** Codes programming area:

Q 1	DISA ACCESS CODE		11 A
W 2	ADMIN PASSWORD		12 9

**A. DISA Access Code**

Programming Steps

If this feature is to be assigned:

1. Press the DISA ACCESS CODE flexible button (Button #1). The following message is shown on the display phone:



2. Enter a three-digit value on the dial pad for the DISA access code.
3. Press the HOLD button to save the entry. Confirmation tone is heard and the display will now update.

Description

This allows a three-digit access code to be assigned to the system. Anyone calling in on a DISA line must use the access code in order to gain access to system features.

To disable the DISA access code, enter three pounds (###).

**Default:** By default, 100 is assigned as the access code.

**Related Programming:** Refer to Sec. 610.1, System Timers for the Preset Forward Timer, and Conference/DISA Timer; Sec. 620.1, CO Line Programming, for DISA Trunk-to-Trunk (Per CO Line). A CO Line(s) must be assigned for DISA operation. Also refer to Sec. 620.1, CO Line Programming for CO Line Privacy and Conference options.

## ACCESS CODE PROGRAMMING (Cont'd)

## B. Database Admin. Password

Programming Steps

If this feature is to be assigned:

1. Press the **ADMIN PASSWORD** flexible button (Button #2). The following message is shown on the display phone:

<p><b>ADMIN PASSWORD</b> <b>3226</b></p>
--

2. Enter a four-digit value on the dial pad which corresponds with 0000-9999.
3. Press the HOLD button to save the entry. Confirmation tone is heard and the display will now update.

Description

The password used to enter customer database programming can be individualized by each customer. This allows the system administrator to block unauthorized personnel from entering database admin.

## CAUTION

<p>Cars should <b>be</b> taken when changing the programming password so <b>not</b> to "lockout" <b>authorized personnel</b> that <b>may</b> prevent or: delay them from making necessary programming changes.</p>
--

**Default:** By default, the Admin password [3226] (DBAM) is assigned.

MISC. SYSTEM PARAMETERS (Cont'd)

610.12 STATION MESSAGE DETAIL RE-  
 CORDING (SMDR)

Programming Steps

If Station Message Detail Recording is to be used:

1. Press FLASH and dial [21]. The following message is shown on the display phone:

**SDR TPE PNT BAUD PORT**  
**NO LD 80 2400 1**

2. To program SMDR features, use the flexible button(s) as defined in the following procedures.
3. The SMDR, TYPE, and PRINT features will toggle on and off with each depression, and the display will update with each depression.
4. After all entries are made, press the HOLD button to save the entry. Confirmation tone is heard.

A. SMDR Enable/Disable

Programming Steps

1. Press the SMDR flexible button (Button #1). This feature will toggle on and off with each depression, and the display will update with each depression.
  - LED ON = SMDR is enabled
  - LED OFF = SMDR is disabled
2. Press the HOLD button to save the entry. Confirmation tone is heard

B. Long Distance/Local Assignment

Programming Steps

1. Press the CALL TYPE flexible button (Button #2) to determine the type of calls to be recorded. This feature will toggle on and off with each depression, and the display will update with each depression.
  - LED ON = Long Distance is enabled
  - LED OFF = All Calls is enabled
2. Press the HOLD button to save the entry. Confirmation tone is heard.

Description

***This' features is available with optional software.***

The Starplus Digital Key Telephone System can provide SMDR output to the standard RS-232C "On-Board" connector (future) on the Central Processor Unit (CPU) or to the optional Backplane RS-232C I/O Expander Module connector(s). When SMDR is desired, the following system-wide parameters will determine how the SMDR information will be reported.

The buttons on the digital terminal are defined as shown below when entering the SMDR programming area.

Q 1	SMDR	11	A
W 2	CALL TYPE	12	S
E 3	PRINTFORMAT	13	D
R 4	BAUD RATE	14	F
T 5	PORT	15	G

**Related Programming:** Refer to Sec. 610.7, PBX Dialing Codes; Sec. 610.1, SLT DTMF Receiver timer; Sec. 630.1, Station Class of Service (COS); and Sec. 660.1, Exception Tables Programming.

Description

A call accounting device can be installed allowing the system to track calls by outside line number, number dialed, time of day, date, station that placed or received the call, and duration of the call.

Refer to Sec. 610.1 for further instruction regarding the relationship between SLT Receivers and SMDR.

**Default:** By default, SMDR is disabled.

Description

The system can be set to record either all outgoing calls or only outgoing long distance calls. Long Distance calls are defined as either beginning with a '1' or '0' or containing 8 or more digits. Incoming calls are only recorded if TYPE is set for all calls.

**Default:** By default, the system is set to record long distance (LD) calls only.

## SYSTEM PARAMETERS PROGRAMMING

STATION MESSAGE DETAIL RECORDING  
(Cont'd)

## C. Character Print Assignment

<u>Programming Steps</u>	<u>Description</u>
<ol style="list-style-type: none"> <li>1. Press PRINT FORMAT flexible button (Button #3) to determine the print format of SMDR records. This feature will toggle on and off with each depression, and the display will update with each depression.           <ul style="list-style-type: none"> <li>• LED ON = 80-Character is enabled</li> <li>• LED OFF = 29-Character is enabled</li> </ul> </li> <li>2. Press the HOLD button to save the entry. Confirmation tone is heard.</li> </ol>	<p>The system can be programmed to print individual SMDR records in either a 1 -line 80-character format or a 3-line 29 character format.</p> <p><b>Default:</b> By default, the 1 -line 80-character format is selected.</p>

## D. Baud Rate Display

<u>Programming Steps</u>	<u>Description</u>
<p>The SMDR Baud Rate is programmed using Flash 15, Baud Rate Assignments. Button #4 will return error tone when pressed. The LCD displays the current baud rate based on which Port number is assigned to the SMDR Port number.</p>	<p>The Starplus Digital Key Telephone System provide <b>SMDR</b> output to the standard RS-232C "On-Board" connector (future) Central Processor Unit (CPU) or to the optional Backplane RS-232C I/O Expander Module connector(s). The Baud Rate will be displayed as either 300 baud, 1200 baud, 2400 baud, 4800 baud, or 9600 baud.</p> <p><b>Related Programming:</b> Refer to 610.10, Baud Rate Assignments for programming SMDR Baud Rate Assignment.</p>

## E. SMDR Port Assignments

<u>Programming Steps</u>	<u>Description</u>
<ol style="list-style-type: none"> <li>1. Press the PORT flexible button (Button #5) to determine which port is to be used for SMDR information.</li> <li>2. Enter a one-digit number for the SMDR Port number:           <ul style="list-style-type: none"> <li>- [1] = Port #1 (CPU "On-Board" RS-232C) (Future Use)</li> <li>- [2] = Port #2 ("On-Board" Modem)</li> <li>- [3] = Port #3 (Backplane RS-232C)</li> <li>- [4] = Port #4 (Backplane RS-232C)</li> </ul> </li> <li>3. The LCD displays the current baud rate based on which Port number is assigned to the SMDR Port number.</li> <li>4. Press the HOLD button to save the entry. Confirmation tone is heard and the display will now update.</li> </ol>	<p>Port #1 refers to the standard RS-232C "On-Board" connector on the Central Processor Unit (CPU). (Future use)</p> <p>Port #2 refers to the "On-Board" 1200 Baud modem provided with the system.</p> <p>Port #3 refers to the RS-232C connector on the Backplane I/O Expander Module.</p> <p>Port #4 refers to the RS-232 connector on the same Backplane I/O Expander Module used in the Starplus Digital system.</p> <p><b>Default:</b> By default, Port #1 is used for SMDR.</p>

MISC. SYSTEM PARAMETERS (Cont'd)

610.13 WEEKLY NIGHT MODE SCHEDULE

Programming Steps

If entries or changes need to be made to this schedule:

- a. Press FLASH and dial [22]. The following message will then be shown on the display:

```

DAY END START' AUTO
MON 0800 1700 YES
    
```

Description

The Starplus Digital Key Telephone System can be programmed so that the system is automatically placed into and out of night mode. A programmable weekly time schedule allows the system administrator to preset the time the system is put into night mode and the time to remove night mode on a daily basis including weekend operation.

The buttons on the digital terminal are defined as shown below when entering the Weekly Night Mode Schedule programming area.

Q 1	A U - L	11 A
W 2	MONDAY	12 S
E 3	TUESDAY	13 D
R 4	WEDNESDAY	14 F
T 5	THURSDAY	15 G
Y 6	FRIDAY	16 H
U 7	SATURDAY	17 J
I 8	SUNDAY	18 K

A. Automatic/Manual Operation

Programming Steps

1. Press the AUTO/MANUAL flexible button (Button #1). This feature will toggle on and off with each depression, and the display will update with each depression.
  - LED on= Automatic Night Mode
  - LED off= Manual operation.
2. If no other changes are to be made, press the HOLD button to save the entry. Confirmation tone is heard.

Description

If the system is operated in the automatic night mode the attendant(s) can override the automatic mode by pressing the night key on the attendant(s) phone. The schedule will not go back into effect until the attendant(s) press the night key again.

When the system is placed into night mode CO line ringing will follow the Night ringing assignments and stations will be governed by their respective night COS.

**Default:** The default times for automatic night mode is as follows:

Monday thru Friday 08:00 17:00  
 (day time operation 8:00am to 5:00pm)  
 Saturday and Sunday ##:## #:##  
 (24 hour night mode operation)

B. Day of Week programming

Programming Steps

1. The MONDAY flexible button (Button #2) LED is lit.
2. To change days of the week, press the appropriate flexible button (buttons 3-8) and perform the following procedures.
3. Enter the four-digit entry to indicate the hour and minutes to end night mode.
4. Enter the four-digit entry to indicate the hour and minutes for the system to go into the night mode for that particular day.
5. Press the HOLD button to save the entry. Confirmation tone is heard and the display will now update.

An entry of "00:00 23:59" would indicate 24 hours of day mode

**Related Programming:** Refer to Sec. 620.1, CO Line Programming, CO Line Ringing Assignments; Sec. 630.1, Station Attributes Programming, Station Class of Service (COS) assignments. Also refer to Sec. 610.5, Attendant Station Assignment for Attendant station assignments.



**SYSTEM PARAMETERS PROGRAMMING**

**MISC. SYSTEM PARAMETERS (Cont'd)**

**610.14 DIRECTORY DIALING**

Programming Steps

Description

Enter, Change, Erase or to just View entries in the Directory Dialing list:

1. Press FLASH and dial [23]. The following message will then be shown on the display:

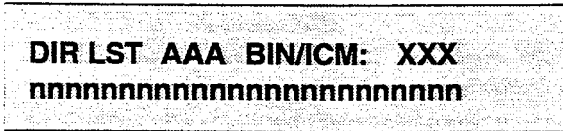

Where:

- AAA= Directory List Entry Number (000-1 99)
- XXX= Either a Station Number, a System Speed dial bin Number, or Local Number/Name Translation Table number.
- nnn= Programmed Name (blank if none).

To select a particular list entry:

1. Press Flexible Button #20 for a directory list entry.
2. Dial the three-digit directory list entry number (000-1 99)
3. Press the HOLD button to save the entry. Confirmation tone is heard and the display will now update.

To scroll through the list:

1. Press the NEXT flexible button (Button #18) to scroll up (next entry);  
or  
Press the PREV flexible button (Button #19) to scroll backwards (previous entry).

Directory dialing allows station users to obtain a directory of station users and have the system dial the extension that is currently on the display. The Starplus SPD 4896 system provides locations for up to 200 names.

Directory dialing also allows users to program a "name" along with a speed dial bin for use in later locating a speed dial number. When prompted to do so, the system will display the name associated with a speed dial number on the LCD display so that when the desired name is shown, the user may then have the system dial the number.

Directory dialing also allows users to associate a "name" with an entry in the local number/name translation table. When prompted to do so, the system will display the name associated with the table on the LCD display so that when the desired name is shown, the user may then have the system dial the number. The Starplus SPD 4896 system provides locations for up to 200 names.

The Directory Dialing list may be programmed and maintained at the first assigned attendant station in one of two ways, however this admin routine provides a means for the directory list to be maintained by the system programmer either locally (at Station 100) or remotely via modem access.

The buttons on the digital terminal are defined as shown below when entering the Directory Dialing programming area.

Q	1	BIN/ICM	11	A
W	2	NAME	12	S
E	3	CLEAR	13	D
R	4	BACK SPACE	14	F
T	5		15	a
			16	H
U	7		17	J
I	8	NEXT ENTRY	18	K
O	9	PREV ENTRY	19	L
P	10	NEW ENTRY	20	:

MISC. SYSTEM PARAMETERS (Cont'd)

DIRECTORY DIALING (Cont'd)

To enter the intercom number or system speed dial bin to be associated to the name:

Programming Steps

1. Press the BIN/ICM flexible button (Button #1).
2. Enter a three-digit station intercom number (100-195), a three-digit System speed dial number (020-099), or a three-digit Local Number/Name Translation Table number (300-499).
3. Press the HOLD button to save the entry. Confirmation tone is heard and the display will now update.

Description

**BIN/ICM** - Each entry in the directory dialing list must be associated to either a system speed dial bin (for calling a destination outside of the system) or to an intercom station (for calling internal station including CO line transfers).

Programming Steps

To Enter or Change the current name shown on the display:

1. Press the NAME flexible button (Button #2).
2. Enter the name (up to 24-characters may be entered) by using keys on the dial pad as follows:

A =21	M =61	1 =1#	" =01
B =22	N =62	2 =2#	, =02
C =23	O =63	3 =3#	? =03
D =31	P =71	4 =4#	/ =04
E =32	Q =74	5 =5#	! =*1
F =33	R =72	6 =6#	\$ =*2
G =41	s =73	7 =7#	& =*4
H =42	T =81	8 =8#	* =*#
I =43	U =82	9 =9#	( =#1
J =51	V =83	0 =0#	) =#2
K =52	W =91	Space =11	+ =#3
L =53	X =92	: =12	= =#4
	Y =93	- =13	# =##
	z =94	' =14	

3. If an error is made while entering the name, press the BACK SPACE flexible button (Button #4). This button may be pressed to back-space one character at a time.
4. Press the HOLD button to save the entry. Confirmation tone is heard and the display will now update.

Description

**NAME** - A name of up to 24-characters may be entered into each directory dial list entry. The names will appear alphabetically when accessed by a station user. It is possible to have multiple entries that are associated to the same station number or system speed dial bin. This allows the same name to be entered into the list several times, for example by last name and by first name, pointed to a station number and a speed dial bin (home, or mobile phone number) or to have several different names all associated to the same speed dial bin.

**SYSTEM PARAMETERS PROGRAMMING**

---

**MISC. SYSTEM PARAMETERS (Cont'd)****DIRECTORY DIALING (Cont'd)**

To clear an entry:

<u>Programming Steps</u>	<u>Description</u>
1. Press the CLEAR flexible button (Button #3).	<b>CLEAR</b> --Entries in the table may be erased and cleared from the table allowing another entry to be placed into the list. When a system speed dial bin has been deleted or changed the name associated to the bin must also be erased. As multiple table listing may be associated to one system speed dial bin it may be necessary to clear more than one entry.
2. Press the HOLD button to save the entry. Confirmation tone is heard and the display will now update. The entry will be erased (both the <b>BIN/ICM</b> assignment and the programmed name).	

MISC. SYSTEM PARAMETERS (Cont'd)

610.15 FLEXIBLE CARD ASSIGNMENTS

Programming Steps

1. Press FLASH and dial [24]. The following message will be shown on the display:

```

SLOT - S S S S C C C C
S S S # # # # # # #
```

Where:

- S= Station Board (KT12)
  - C= CO Line Board (CO12)
  - #= Blank (unused card slot)
2. The buttons 1 through 12 indicate peripheral card slots 1 through 12. When the Flexible Card Assignments program is initially entered, Flex Button #1 LED will be lit indicating that the user is programming the card in peripheral card slot 1. Press the appropriate flex button for a different peripheral card slot.
  3. Enter a one-digit to indicate the type of card is plugged into the current peripheral card slot.
    - 0= Key Telephone Board (KT12) or Single Line Board (SLI 2)
    - 1= CO Loop Interface Board (CO12)
    - #= Delete slot
  4. Press the HOLD button to complete the entry. Confirmation tone will be heard and the display will now update.

**NOTE** After the card slots have been re-arranged, the system MUST be reset for full activation of the database programming to take effect.

Description

The Flexible Card Assignments feature will provide a means to assign the peripheral cards to alternative peripheral card slots. This provides complete flexibility in determining station numbers and CO line numbers as long as they stay within the system numbering plan. A station can be assigned any number between 100 and 195, while a CO line can be assigned any number between 1 and 48. Station numbering is determined by this programming, not physical cards installed in the system.

The buttons on the key telephone are defined as shown below when entering the Flexible Card Assignments feature programming area:

All Flexible Card Assignment(s) entered are stored in a temporary database area which is uploaded to the main database when the system is reset.

CARD SLOT #	STATION #	PORT #
1	100-111	1-12
2	112-123	13-24
3	124-135	25-36
4	136-147	37-48
5	1 CO Lines 1-12	1-12
6	CO Lines 13-24	13-24
7	CO Lines 25-36	25-36
8	CO Lines 37-48	37-48
9	148-159	49-60
10	160-171	61-72
11	172-183	73-84
12	184-195	85-96

**Default:** The system defaults to a configuration that designates peripheral slots 1,2,3 and 4 for Station boards, peripheral slots 5,6,7 and 8 for CO boards, and peripheral slots 9, 10, 11 and 12 for the remaining station boards.

MISC. SYSTEM PARAMETERS (Cont'd)

610.16 HUNT GROUPS

A. Hunt Group Programming

Programming Steps

If Hunt Groups are to be assigned:

1. Press FLASH and dial [30]. The following message will be shown on the display:

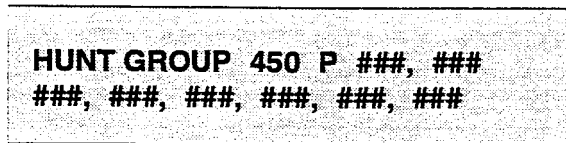

2. The top left button in the flexible button field will be lit for programming Hunt Group 1 (450). To change Hunt Groups or enter a different Hunt Group, press the appropriate flexible button 1-8 (450-457) and perform the following procedures.
3. Enter the three-digit station numbers up to a maximum of 24-digits (8 stations). Hunt groups are joined together by entering another Hunt Group Pilot Number as the last entry of the group.
4. Press the HOLD button to save the entry. Confirmation tone is heard and the display will now update.

To remove stations from a hunt group:

1. Enter three [###] (pounds) on the dial pad.
2. Press the HOLD button. Confirmation tone is heard and the display will now update. This will remove all stations previously programmed in that group.

B. Station/Pilot Hunting Assignment

Programming Steps

1. Press the STATION/PILOT flexible button (Button #9) to indicate Station Hunting or Pilot Hunting.
  - LED on= Station Hunting enabled
  - LED off= Pilot Hunting enabled

Description

The system can be arranged for up to eight hunt groups. Each hunt group can contain up to eight stations each. Each hunt groups can be independently arranged to utilize either a pilot hunting technique or station hunting technique. Hunt groups may also be chained together when larger Hunt groups are desired.

Hunt groups can be joined together by programming another hunt group number as the last member of a hunt group.

If a station is in DND or is forwarded to another station, it is considered busy.

The buttons on the digital terminal are defined as shown below when entering the Hunt Group programming area.

Q	1	HUNT GROUP 450		11	A
W	2	HUNT GROUP 451		12	S
E	3	HUNT GROUP 452		13	D
R	4	HUNT GROUP 453		14	F
T	5	HUNT GROUP 454		15	G
Y	6	HUNT GROUP 455		16	H
U	7	HUNT GROUP 456		17	J
I	8	HUNT GROUP 457		18	K
O	9	STATION/PILOT		19	L

Description

**PILOT HUNTING:** Incoming CO, transferred CO, and intercom calls can be directed to a pilot number of a hunt group. The system will search sequentially (in the order the extensions were entered in the database programming) for an idle station in the group and will ring that station. Calls directly to stations (by calling the extension number) within the hunt group will not hunt but receive call progress tones from the extension.

**STATION HUNTING:** Incoming CO, transferred CO, and intercom calls that are presented to a busy, or DND station, that is a member of a Station Hunt group, will search sequentially (in the order the extensions were entered in database programming) for an idle station in the group and will ring that station. Calls will still be allowed to be directed to the groups pilot number for pilot type hunting.

MISC. SYSTEM PARAMETERS (Cont'd)

610.17 LOCAL NUMBER/NAME TRANSLATION TABLE

Programming Steps

If changes need to be made to Local Number/Name Translation Table:

1. Press FLASH and dial [55]. The following message is shown on the display phone:



Where:

- XXX= Table Number 300-499
- ###= Route Number 000-99

2. The ROUTE NUMBER LED is lit. Enter the three-digit Route Number (000-99) from what was entered in program code, FLASH 43.

To erase a current phone number and name entry:

1. Press the CLEAR ENTRY flexible button (Button #4) to clear an entire phone number and name from the current index.
2. Press the NEXT TABLE flexible button (Button #18) to advance to the next index and continue entering information into the translation table, or
3. Press the PREV TABLE flexible button (Button #19) to go back to a previous index that is already programmed.

To locate an existing index for editing:

1. Press the TABLE NUMBER flexible button (Button #20). The following message is shown on the display phone:

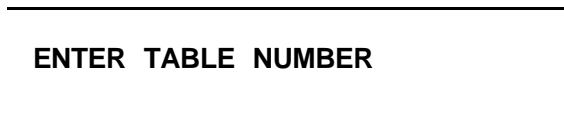

2. Enter a three-digit number which corresponds to the table numbers 300-499.
3. Press the HOLD button to complete the entry.

Description

An administrable table in the KSU provides a local translation from a received calling number to a name. This is administrable by the customer from the attendant console position. This table is also shared by the ICLID features. In cases of conflict between the name delivered from the CO and that in the local translation table, the local translation table shall rule. 200 entries are provided in this table for the Starplus SPD 4696 system.

The buttons on the digital terminal are defined as shown below when entering the Local Number/Name Translation programming area:

Q 1	ROUTE NUMBER		11 A
W 2	PHONE NUMBER		12 S
E 3	NAME		13 D
R 4	CLEAR ENTRY		14 F
T 5			15 G
Y 6			16 H
U 7			17 J
I 8		NEXT TABLE	18 K
O 9		PREV TABLE	19 L
P 10		NEW TABLE	20 ;

**NOTE** If a match is found between a number in the translation table and an incoming call record, the translated name is displayed and/or stored in the unanswered call table.

**NOTE** Entry of phone numbers and names from a terminal require keystrokes corresponding to a keyset keystroke. Example: to enter a "1" from the terminal, an entry of "1#" is required or to enter an "A", the terminal programmer must enter "21".

**Related Programming:** Refer to Sec. 640.1, ICLID Programming for additional information about ICLID features.

## SYSTEM PARAMETERS PROGRAMMING

## MISC. SYSTEM PARAMETERS (Cont'd)

## LOCAL NAME TRANSLATION (Cont'd)

Programming Steps

To program a phone number into the Local Number/Name Translation table:

1. Press the PHONE NUMBER flexible button (Button #2) to enter the desired phone number into the translation table. Maximum length of phone number is **14-digits**, including hyphens. Numbers entered must be in the format: 1-602-XXX-XXXX.

A =21	M =61	1 =1#	" =01
B =22	N =62	2 =2#	, =02
C =23	O =63	3 =3#	? =03
D =31	P =71	4 =4#	/ =04
E =32	Q =74	5 =5#	! =*1
F =33	R =72	6 =6#	\$ =*2
G =41	s =73	7 =7#	& =*4
H =42	T =81	8 =8#	* =*#
I =43	U =82	9 =9#	( =#1
J =51	V =83	0 =0#	) =#2
K =52	w =91	Space =11	+ =#3
L =53	x =92	: =12	= =#4
	Y =93	- =13	# =##
	z =94	' =14	

2. Press the HOLD button to update the database. The BACK SPACE flexible button (Button #5) can be used to erase the current number to correct for errors.

Example:

- If 602-443 is entered in the translation table with a route number, any call received from ICLID will be routed per this partial entry. It is important to note that if a partial entry is inserted in the table, entries that begin with the partial entry, such as 602-443-6000 will cause confusion, Call in this scenario can be routed per either entry depending on the search. This is considered a duplicate entry and should be avoided. It should also be noted that calls will still require exact entries therefore a caller entered number of 602443 needs a separate route entry from 602-443 since there is no dash.

Description

An option has been added to the Local Number/Name translation table to route an ICLID or Caller Entered ID Digits based on a partial compare with the number entered in the translation table.

The Guaranteed Message announcement provides a means to force incoming callers to an announcement before being placed into an ACD Queue or routed to an agent. The outside callers are presented with a message before being routed to the ACD Group. Agents in an ACD Group with a Guaranteed Message enabled will receive incoming callers only after the caller has heard the designated recorded announcement in its entirety, or after the incoming caller dials up to 14 digits followed by a pound (#). These digits will be inserted as ICLID incoming number identification.

If the Guaranteed Message announcement is programmed in Admin, incoming ACD calls will be routed to the Guaranteed Message RAN before going to the ACD Group. If the ICLID option is selected, digits received before the announcement time-out will be captured and inserted as incoming ICLID number information.

When the ICLID option is selected, a [#] will be recognized as a termination of the announcement and a [\*] will be recognized as an entry error. An entry error will cause the ICLID number to be removed and the incoming caller can re-enter his phone number.

MISC. SYSTEM PARAMETERS (Cont'd)

LOCAL NAME TRANSLATION (Cont'd)

Programming Steps

Description

To program a name into the translation table:

1. Press the NAME flexible button (Button #3) to enter the desired name into the translation table. Maximum length is 24-characters.

A =21	M =61	1 =1#	" =01
B =22	N =62	2 =2#	, =02
C =23	O =63	3 =3#	? =03
D =31	P =71	4 =4#	/ =04
E =32	Q =74	5 =5#	! =*1
F =33	R =72	6 =6#	\$ =*2
G =41	s =73	7 =7#	& =*4
H =42	T =81	8 =8#	* =*#
I =43	U =82	9 =9#	( =#1
J =51	V =83	0 =0#	) =#2
K =52	w =91	Space =11	+ =#3
L =53	x =92	: =12	= =#4
	Y =93	- =13	# =##
	z =94	' =14	

2. Press the HOLD button to update the database. The BACK SPACE flexible button (Button #5) can be used to erase the current letter to correct for errors.

The Guaranteed Message announcement provides a means to force incoming callers to an announcement before being placed into an ACD Queue or routed to an agent. The outside callers are presented with a message before being routed to the ACD Group. Agents in an ACD Group with a Guaranteed Message enabled will receive incoming callers only after the caller has heard the designated recorded announcement in its entirety or after the incoming caller dials up to 14 digits followed by a pound (#). These digits will be inserted as ICLID incoming number identification.

If the Guaranteed Message announcement is programmed in Admin, incoming ACD calls will be routed to the Guaranteed Message RAN before going to the ACD Group. If the ICLID option is selected, digits received before the announcement time-out will be captured and inserted as incoming ICLID number information.

When the ICLID option is selected, a [#] will be recognized as a termination of the announcement and a [\*] will be recognized as an entry error. An entry error will cause the ICLID number to be removed and the incoming caller can re-enter his phone number.



**TABLE OF CONTENTS FOR SECTION 620**

<b>SECTION 620</b>	<b>CO LINE ATTRIBUTES PROGRAMMING .....</b>	<b>620-1</b>
620.1	INTRODUCTION .....	620-1
	A. DTMF/Dial Pulse Programming .....	620-2
	B. CO/PBX Programming .....	<b>620-2</b>
	c. UNA Programming .....	620-3
	D. DISA Trunk-to-Trunk (Per CO Line) .....	620-3
	E. Privacy .....	620-4
	F. Loop Supervision Programming .....	<b>620-5</b>
	G. DISA Programming .....	620-6
	H. Flash Timer Programming .....	620-7
	I. Line Group Programming .....	620-7
	J. Class of Service (COS) Programming .....	620-8
	K. CO Line Ringing Assignments .....	<b>620-9</b>
	L. CO Line Identification Display .....	620-10
	M. Trunk Direction .....	<b>620-11</b>
	N. Ring Delay Timer .....	620-11
620.2	DIAL PULSE PARAMETERS .....	<b>620-12</b>
620.3	FLEXIBLE PORT ASSIGNMENT FEATURE .....	520-13

# SECTION 620

## CO LINE ATTRIBUTES PROGRAMMING

### 620.1 INTRODUCTION

#### Programming Steps

If the system is in the programming mode, continue using the program codes. If starting to program here, enter the programming mode. Refer to Sec. 600.2, Program Mode Entry (Key Station).

If any CO line features are to be changed:

- a. Press FLASH and dial [40]. The following message is shown on the display phone:

**CO LINE ATTRIBUTES  
SELECT A CO LINE RANGE**

- b. Enter a four-digit number for the range of lines being programmed. If only one line is being programmed, enter that number twice (0101).
- c. Press the HOLD button to save the entry. Confirmation tone is heard and the display will now update. Flexible button #20 (New Range) will be lit. The following message is shown on the display phone to indicate current programming of that line or group of lines.

**CO XX-XX DT CO UNA C P  
LS0 DSX FL10 GRPX COSX**

Where:

- XX-XX = CO Line Range (01-48)
- DT = DTMF or Dial Pulse
- CO = Line Type, CO or PBX
- UNA = Universal Night Answer enabled
- C = DISA/Trk-to-Trk enabled
- P = Privacy feature enabled
- LSX = Loop Supervision
- DSX = Type of DISA options
- FLXX = Flash Timer
- GRPX = CO Line Group
- COSX = CO Line Class of Service

#### Description

This section describes the procedures and steps necessary to program CO Line attributes. When entering the CO line attributes portion of the database, the programmer may decide to enter information for either a range of CO lines or one specific CO Line.

Range programming allows the programmer to change a specific parameter or a few parameters for an entire range of CO Lines leaving intact the remaining data fields that do not require change. Those data fields will continue to operate with the previously programmed data. For example if CO lines are programmed into several CO line groups with different Class of service etc... but it is desired to enable Loop Supervision (SUPV) on all CO Lines the programmer may enter as the range ALL CO lines (01-48) and enable loop supervision, then exit programming. This will enable loop supervision for all CO lines leaving intact the various CO line group programming and COS data for the range.

The buttons on the digital terminal are defined as shown below when entering the CO Line Attribute programming area.

1	Q	DTMFDIAL PULSE	RING ASSIGNMENTS	11	A
2	W	CO/PBX	CO LINE IDENTIFICATION	12	S
3	E	UNA	TRUNK DIRECTION	13	D
4	R	DISA TRK-TO-TRK	RING DELAY TIMER	14	F
5	T	PRIVACY		15	G
6	Y	LOOP SUPV		16	H
7	U	DISA	DISPLAY RING ASSIGN	17	J
8	I	FLASH TIMER	NEXT (FORWARD)	18	K
9	9	CO LINE GROUP	NEXT (BACKWARD)	19	L
10	P	LINE COS	NEW RANGE	20	;

- Button #17 [Ring Display] will display the ringing assignments for the CO line.
- Button #18 [Next Entry] will take you to the next higher CO line.
- Button #19 [Previous Entry] will take you to the next lower CO line.
- Button #20 [Select Range] will prompt for a new CO Line range.

## CO LINE ATTRIBUTES PROGRAMMING

## CO LINE ATTRIBUTES (Cont'd)

## A. DTMF/Dial Pulse Programming

Programming Steps

1. Press the DTMF/DIAL PULSE flexible button (Button #1). This feature will toggle on and off with each depression, and the display will update with each depression.
  - LED on = DTMF enabled
  - LED off= Dial Pulse enabled
2. Press the HOLD button to save the entry. Confirmation tone is heard.

Description

**DTMF/DIAL PULSE.** Each individual outside line can be programmed to be either DTMF (tone) or dial pulse. When a line is assigned as dial pulse, you can program the break/ make ratio and dial speed.

**Default:** By default, all lines are set for DTMF.

**Related Programming:** Refer to Sec. 620.2, Dial Pulse Parameters; and Sec. 610.1, System Timers, CO Ring Detect Timer.

```
CO XX-XX DT CO UNA C P
LSO DSX FL10 GRPX COSX
```

## B. CO/PBX Programming

Programming Steps

1. Press the CO/PBX flexible button (Button #2). This feature will toggle on and off with each depression, and the display will update with each depression.
  - LED on = CO type is enabled
  - LED off= PBX is enabled
2. Press the HOLD button to save the entry. Confirmation tone is heard.

Description

**CO/PBX.** Each individual outside line connected to the system may be programmed as either a CO or PBX line. Also use the PBX mark when identifying **Centrex** lines.

**Default:** By default, all lines are assigned as CO lines.

**Related Programming:** Refer to Sec. 610.7, PBX Dialing Codes; Sec. 610.1, System Timers, CO Ring Detect Timer; Also refer to Sec. 620.1, CO Line Programming, Flash Timer Programming later in this section.

```
CO XX-XX DT CO UNA C P
LSO DSX FL10 GRPX COSX
```

CO LINE ATTRIBUTES (Cont'd)

C. UNA Programming

Programming Steps

1. Press the UNA flexible button (Button #3). This feature will toggle on and off with each depression, and the display will update with each depression.
  - LED on = UNA is enabled
  - LED off = UNA is disabled
2. Press the HOLD button to save the entry. Confirmation tone is heard.

Description

**UNA.** If a line is marked UNA, and if the system is in night service mode and if UNA is enabled in system parameters, then when a CO line rings into the system, a ring tone is generated over all external page zones.

**Default:** By default, UNA is enabled

**Related Programming:** Refer to Sec. 610.2, System Features Programming, External Night Ring; and Sec. 610.9, Relay/Sensor Programming.

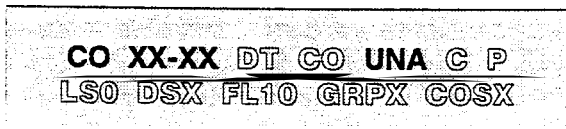

D. DISA Trunk-to-Trunk (Per CO Line)

Programming Steps

If the CO line DISA Trunk-to-Trunk (Conference) attributes is to be changed:

1. Press the DISA TRK-TO-TRK flexible button (Button #4). This feature will toggle on and off with each depression, and the display will update with each depression.
  - LED on = DISA Trunk-to-Trunk is enabled (a "C" is displayed)
  - LED off = DISA Trunk-to-Trunk is disabled
2. Press the HOLD button to save the entry. Confirmation tone is heard.

Description

**DISA TRK-TO-TRK.** The DISA Trunk-to-Trunk (or Conference) mark on the CO line governs a DISA callers ability to access other outside lines. CO lines must have DISA Trunk-to-Trunk enabled to allow a DISA caller to establish an outgoing trunk-to-trunk connection. This allows for specific CO line access restriction on DISA calls.

A station with conference enable will be allowed to initiate a Conference on CO lines regardless of the CO line DISA Trunk-to-Trunk marking.

**Default:** By default, DISA Trunk-to-Trunk is enabled for all CO lines.

**Related Programming:** Refer to Sec. 630.1, Station Attributes Programming, Conference Enable/Disable (Per Station).

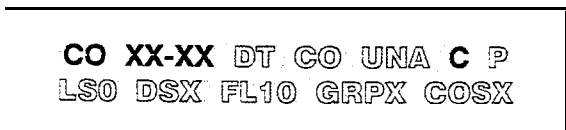

The CO line DISA Trunk-to-Trunk flag affects a DISA callers ability to access outgoing CO lines as shown in the following table:

Incoming DISA Trunk	Trunk DISA caller attempts to access			
	T-t-T Enabled		T-t-T Disabled	
T-t-T Enabled	Call	Allowed	Call	Denied
T-t-T Disabled	Call Denied		Call Denied	

CO LINE ATTRIBUTES PROGRAMMING

CO LINE ATTRIBUTES (Cont'd)

E. Privacy

Programming Steps

Description

If CO Line privacy is to be changed:

1. Press the PRIVACY flexible button. (Button #5. This feature will toggle on and off with each depression, and the display will update with each depression.
  - LED on = Privacy is enabled
  - LED off = Privacy is disabled
2. Press the HOLD button to save the entry. Confirmation tone is heard.

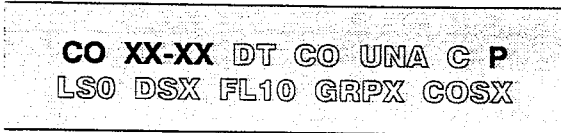

**NOTE** *Disabling of the privacy feature may be limited by federal, state or local law, so check the relevant laws in your area before disabling privacy*

**PRIVACY.** If desired, the system can be programmed to eliminate CO Line privacy, allowing another station to join in on existing outside line conversations.

- Stations must have a direct CO line appearance to join CO line conversations in progress.
- A station must also have Privacy disabled before the system will allow that station to enter into an existing conversation.
- If privacy is disabled and a station joins an existing call, a programmed warning tone will be presented to both parties prior to actual cut-thru.
- When privacy is disabled, up to three other stations may join in on an existing conversation.

**Default:** By default, Privacy is enabled for all CO Lines.

**Related Programming:** Refer to Sec. 610.3, Additional System Features, Privacy Release Tone Option for disabling of the conference tone. Also refer to Sec. 630.1, Station Attributes Programming, Privacy (Per Station) option and Sec. 630.2, Page "B" Programming, Flexible Button Programming for button assignments.

The CO line Privacy flag affects a station users ability to access CO lines already engaged in conversation by another station in the system as shown in the following table:

Station Attempting to Access CO Line	CO Line In use by another Station	
	Privacy Enabled	Privacy Disabled
Privacy Enabled	Private (No Cut-through)	Private (No Cut-through)
Privacy Disabled	Private (No Cut-through)	Privacy Released (Cut-through Allowed)

CO LINE ATTRIBUTES (Cont'd)

F. Loop Supervision Programming

Programming Steps

1. Press the LOOP SUPV flexible button (Button #6).
2. Enter a one-digit timer value on the dial pad between 1 and 9 which corresponds to 100-900 msec.
3. Press the HOLD button to save the entry. Confirmation tone is heard and the display will now update.

```
CO XX-XX DT CO UNA C P
LS0 DSX FL10 GRPX COSX
```

Description

**LOOP SUPV.** Loop supervision is used primarily with DISA, Voice Mail/Auto Attendant and with unsupervised conference applications. It provides the system with the ability to detect when loop current has been broken and an outside line is no longer being used. To determine timer value for loop supervision, consult your **local serving** central office for type and duration of loop supervision signal.

It is recommended that Loop Supervision be enabled, especially when connecting a Voice Mail or Auto Attendant to the **Starplus** Digital Key Telephone Systems.

**Default:** By default, Loop Supervision is disabled for all CO Lines.

**Related Programming:** Refer to Sec. 610.1, System Timers, CO Ring Detect Timer; Sec. 620.1, CO Line Programming, DISA Programming; Sec. 655.1, Voice Mail Groups (VM), and Sec. 655.2, Voice Mail Outpulsing Table.

## CO LINE ATTRIBUTES PROGRAMMING

## CO LINE ATTRIBUTES (Cont'd)

## G. DISA Programming

Programming Steps

1. Press the **DISA** flexible button (Button #7).
2. Enter a one-digit value on the dial pad to indicate type of **DISA** desired.
  - 0= No DISA (disable DISA)
  - 1= 24-Hour DISA
  - 2= Night DISA only
  - 3= 24-Hour DISA with forwarding
  - 4= Night DISA only with forwarding
3. Press the HOLD button to save the entry. Confirmation tone is heard and the display will now update.

```
CO XX-XX DT CO UNA C P
LSO DSX FL10 GRPX COSX
```

Where:

- X= 0 through 4

**NOTE**

*When a Single Line Board (SL12) is installed in the system, it is recommended that the DTM4 DTMF Receiver be installed. If 3 or more SL12 boards are installed in the system, additional DTM4 DTMF Receiver modules should be installed. However, no more than 3 SL12 boards with DTM4 receivers on them can be installed in the system.*

Description

**DISA.** A line can be assigned as a **DISA** line during night service only or on a 24- hour basis. Additionally, a **DISA** line is allowed to follow station forwarding during night service only or on a 24-hour basis.

An unlimited number of **DISA** lines can be programmed into the system. A **DISA** access code can also be programmed. Incoming **DISA** callers may dial any valid internal station or access outside line groups. When a CO line ringing at a station will follow preset forward or no-answer call forward using the preset forward timer the same as an initially ringing CO call does. It will follow direct forward and busy forward the same as an initially ringing CO call. If the preset forward timer is set to 00, the first forward of the **DISA** ringing call at a station will take 15 seconds. **DISA** callers will be subjected to the Class of Service placed on the line accessed for outdialing. It is recommended that Loop Supervision be enabled when setting up **DISA** line(s). Sec. 610.1, System Timers , **Conference/DISA** Timer allows the system administrator to control the length of time a **DISA** caller is allowed after establishing a "Trunk-to-Trunk" call. After expiration of the Conference Timer, a tone will be presented to both **DISA** parties, then one minute later the system will automatically release both trunks. The Conference Timer does not affect or control a **DISA**-to-Station call.

**Default:** By default, there are no outside lines assigned as **DISA** lines.

**Related Programming:** Refer to Sec. 620.1, CO Line Programming, **Conference/DISA** Timer; Sec. 610.11, Access Codes; Sec. 620.1, CO Line Programming, Loop Supervision Programming, **DISA** Trunk-to-Trunk (Per CO Line), and Class of Service (COS) Programming. Also refer to Sec. 660.1, Exception Tables Programming.

CO LINE ATTRIBUTES (Cont'd)

H. Flash Timer Programming

Programming Steps

1. Press the FLASH TIMER flexible button (Button #8).
2. Enter a two-digit timer value on the dial pad between 01-20 which corresponds to 100 msec-2 seconds.
3. Press the HOLD button to save the entry. Confirmation tone is heard and the display will now update.

```
CO XX-XX DT CO UNA C P  
LSO DSX FL10 GRPX COSX
```

Description

**FLASH TIMER.** Flash is a programmable opening on a line for signaling. When using an outside line, flash allows a user to obtain new dial tone without losing the line. This is particularly useful behind a PBX or Centrex. Each individual CO line can be programmed for a flash time.

**Default:** By default, the Flash Timer is set for 10 (1 .0 seconds) and is variable from 01 to 20 (100 msec. to 2 seconds).

**Related Programming:** Refer to Sec. 620.1, CO Line Programming, CO/PBX Programming.

I. Line Group Programming

Programming Steps

1. Press the CO LINE GROUP flexible button (Button #9).
2. Enter a one-digit value on the dial pad between 0-7 which corresponds to Groups 0-7.
3. Press the HOLD button to save the entry. Confirmation tone is heard and the display will now update.

```
CO XX-XX DT CO UNA C P  
LSO DSX FL10 GRPX COSX
```

Description

**CO LINE GROUP.** Eight line groups are available for CO line assignment. Groups should be assigned according to type (local, FX, WATS, etc.)

All unassigned CO lines should be programmed into a different group so they won't be accessed by Line Queuing, Pooled Group access (Pool Buttons), Speed Dial, or LCR features.

Line group 0 is used for programming a line(s) as a private line.

**Default:** By default, All lines are placed in Line Group 1.

**Related Programming:** Refer to Sec. 630.1, Station Attributes Programming, Flexible Button Programming - Pool Buttons. Also refer to Sec. 665.2, LCR Route List Table.



CO LINE ATTRIBUTES PROGRAMMING

CO LINE ATTRIBUTES (Cont'd)

J. Class of Service (COS) Programming

Programming Steps

Description

1. Press the LINE COS flexible button (Button #10).
2. Enter a one-digit value on the dial pad between 1-5 which corresponds to five possible class of service to which a line may be assigned:
  - COS1= No restrictions.
  - COS2= Table A governs, Station COS 2 and 4 are monitored.
  - COS3= Table B governs, Station COS 3 and 4 are monitored.
  - COS4= Restricts 0,1,\*,# dialed as first digit and places a seven digit dialing limitation. In addition, 1-800, 1911, and 1611 are allowed and 411, 976, and 555 numbers are denied.
  - COS5= Overrides station COS 2,3,4, and 5 and allows unrestricted dialing.
3. Press the HOLD button to save the entry. Confirmation tone is heard and the display will now update.

**LINE COS.** Through assignments of a CO Class of Service the assigned CO line will either interact with a station Class of Service, provide a "canned" restriction or provide unrestricted dialing capabilities. (When a CO line is marked PBX, COS restrictions apply to the station only if one of five PBX codes are dialed first.)

Refer to Table 620-I Class of Service (COS) for CO to Station Class Of Service relationship.

**Default:** By default, all CO lines are assigned Class of Service 1.

**Related Programming:** Refer to Sec. 610.7, PBX Dialing Codes, Sec. 630.1, Station Attributes Programming, Station Class of Service (COS) options. Also refer to Sec. 660.1, Exception Tables Programming.

CO XX-XX DT CO UNA C P  
LSO DSX FL10 GRPX COSX

Table 620-I **Class of Service (COS)**

	CO LINE CLASS OF SERVICE					
	1	2	3	4	5	
S T A T I O N  C O S	1	Unrestricted	Unrestricted	Unrestricted	Canned Restriction*	Unrestricted
	2	Table A	Table A	Unrestricted	Canned Restriction*	Unrestricted
	3	Table B	Unrestricted	Table B	Canned Restriction*	Unrestricted
	4	Tables A&B	Table A	Table B	Canned Restriction*	Unrestricted
	5	Canned Restriction*	Canned Restriction*	Canned Restriction*	Canned Restriction*	Unrestricted
	6	Intercom only	Intercom only	Intercom only	Intercom only	Intercom only

\* Canned Restriction= No '0', 1, #, '\*' as a first dialed digit, and 7 digits maximum plus 1-800, 1911, 1611 are allowed and 411,976, and 555 numbers are denied.

CO LINE ATTRIBUTES (Cont'd)

K. CO Line Ringing Assignments

Programming Steps

Each CO line in the system may be assigned initial incoming ringing to one of the following destinations:

- one or more stations (**keyset** or **SLT**)
  - to an ACD, UCD, Voice Mail or Hunt Group
  - Off-Net (via speed dial)
1. Press the RING ASSIGNMENT flexible button (Button #1 1) to toggle to the Ringing Assignment display. The display will show the following information:

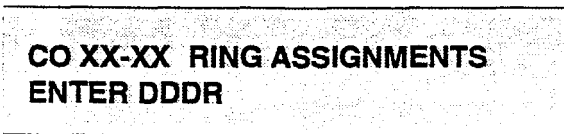

2. Enter the three-digit destination (DDD) and the one-digit ring type (R) followed by the HOLD button. Confirmation tone is heard and the display will now update.
3. Press Button #1 7 to display ring assignments. Assignments will be displayed in sets of 8 up to the number programmed. Press Button #1 7 additional times to cycle to the next group of 8 ring assignments.

The following format is used to display the assignments:

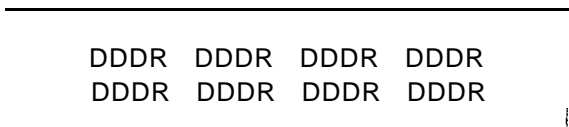

Where:

- DDD= Destination
- R= D for Day
- N= Night
- B= Both Day & Night.

Deleting a station (entering a 0 for ring type) only removes that station from the ring assignment.

Ring assignments will be continuous and will be displayed in order of the destination number from **001** to **557**.

Description

**RING ASSIGNMENT.** When ringing is assigned as a part of the CO line parameters, ringing of a station is independent of that stations button configuration. However, Stations that are assigned for initial ring-in **MUST HAVE** a LOOP button(s) to answer the call(s) if a direct CO appearance is not available.

Multiple station assignments are allowed for a particular CO line in a mixture of Day, Night, or Day & Night ring types. **An** incoming CO line may be programmed to any number of stations but it cannot be programmed to ring a mixture of stations and groups (i.e.. a Hunt Group and four stations, or more than one Hunt Group).

Incoming calls directed Off-Net will be connected to an outgoing system speed bin.

CO lines assigned to ring multiple stations will not follow any stations' forward to a UCD, ACD, Voice Mail, Hunt Group or Off-Net Forwarding to another station will be allowed.

Valid three-digit destinations are:

- 020-099 = System Speed Bins 20-99, for off-net ringing.
- 100-1 95 = Station extension Numbers
- 440-447 = Voice Mail Groups 1-8
- 450-457 = Hunt Groups 1-8
- 499 = Direct Ringing to Modem
- 550-565 = ACD Groups 1-1 6
- 550-557 = UCD Groups 1-8

Valid Ring types are:

- 0 = unassigned (to delete a station)
- 1 = Day Ringing
- 2 = Night Ringing
- 3 = Day & Night Ringing

Multiple station assignments are accomplished by assigning another destination with ring status, DDDR, and pressing the HOLD button. This can be done for up to the maximum number of stations on the system.

**Default:** By default, all CO lines are assigned to ring at the first programmed attendant, Station 100.

**Related Programming:** Refer to Sec. 640.2, ICLID Ringing Assignment.

CO LINE ATTRIBUTES PROGRAMMING

CO LINE ATTRIBUTES (Cont'd)

L. CO Line Identification Display

Programming Steps

Description

Each CO line in the system can be programmed to have a name associated to it in database programming.

This feature allows a name to be entered into the database programming for each individual line (trunk) connected to the system.

1. Press the CO LINE IDENTIFICATION flexible button (Button #12). The following message is shown on the display phone:

Once entered into the database, LCD phones including the attendant stations will receive the programmed line "name" in place of the default "LINE XX" message. This applies to all line call processing conditions where the current "LINE XX" message appears.

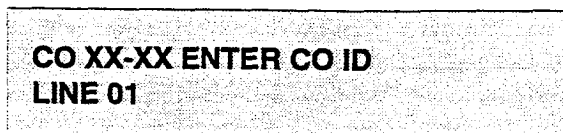

SMDR will continue to print out the line number in place of the programmed name.

2. Enter the name by using keys on the dial pad as follows. Valid alpha-numeric characters are: A-Z, 0-9, \*, #, • [spaces] and other ASCII characters as listed below. The name may be entered in any combination up to 12-characters in length (this represents 24-digits entered).

If the line name has not been programmed, then the current "LINE XX" display will be used as the default.

A programmable data field is available for each line in the system. Line names may be programmed using the range programming.

A message similar to the following will be used for all CO line displays when a name has been programmed for a CO line.

A =21	M =61	1 =1#	" =01
B =22	N =62	2 =2#	, =02
C =23	O =63	3 =3#	? =03
D =31	P =71	4 =4#	/ =04
E =32	Q =74	5 =5#	! =*1
F =33	R =72	6 =6#	\$ =*2
G =41	s =73	7 =7#	& =*4
H =42	T =81	a =8#	* =*#
I =43	u =82	9 =9#	( =#1
J =51	V =83	0 =0#	) =#2
K =52	w =91	Space =11	+ =#3
L =53	x =92	: =12	= =#4
	Y =93	• =13	# =##
	z =94	' =14	



**NOTE** Entries can be made using a keyboard by following the same outlined procedures using the above chart.

3. Press the HOLD button to save the entry. Confirmation tone is heard and the display will now update.

CO LINE ATTRIBUTES (Cont'd)

M. Trunk Direction

Programming Steps

1. Press the TRUNK DIRECTION flexible button. (Button #13). The following message is shown on the display phone:



2. Enter a one-digit value on the dial pad which corresponds to the desired trunk type:
  - [0] = Out-of-Service (OOS)
  - [1] = Incoming only
  - [2] = Outgoing only
  - [3] = Both Incoming and Outgoing
3. Press the HOLD button to save the entry. Confirmation tone is heard and the display will now update.

Description

CO Lines can be programmed on a per CO Line basis for the type of CO Line desired: Incoming, Outgoing, or Both incoming and outgoing.

- Incoming: Restricts the CO Line for incoming calls only.
  - Users can press a CO line button or dial CO line access code. to access a CO line.
  - Users can answer a CO call and then transfer the call.
  - Users can place call on hold, park the call, and other stations can pick-up the call.
- Outgoing restricts the CO Line to outgoing calls only.
  - Users cannot press a CO line button or dial CO line **access** code to access a CO line.
  - Users can place call on hold, park the call, and other stations can pick-up the call.
  - Incoming calls to this CO type are ignored. Callers receive ringback, no answer.
- Both incoming and outgoing type allows calls to be received or dialed out.

**Default:** By default, all CO lines default to both incoming & outgoing type.

N. Ring Delay Timer

Programming Steps

1. Press the RING DELAY TIMER flexible button (Button #14). The following message is shown on the display phone:

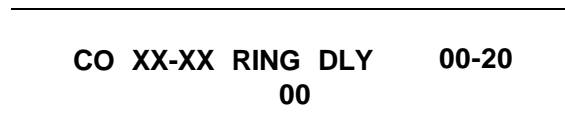

2. Enter a two-digit timer value on the dial pad between 00-20 which corresponds to 00 seconds to 20 seconds.
3. Press the HOLD button to save the entry. Confirmation tone is heard and the display will now update.

Description

The Ring Delay timer has been added to the Starplus Digital Systems to accommodate ICLID interface requirements.

The Ring Delay timer is started whenever a CO Line detects incoming ringing. When the timer expires, CO line ringing will be detected by digital terminals and Single Line telephones. The purpose of this timer is to wait until after the first ring cycle to be detected by the digital system in order for ICLID information to be passed down the CO line prior to being answered.

**Default:** By default, the Ring Delay timer is set at 00 (disabled) and is variable from 00 to 20 seconds.

## CO LINE ATTRIBUTES (Cont'd)

## 620.2 DIAL PULSE PARAMETERS

Programming Steps

If this feature is to be assigned:

- a. Press FLASH and dial [41]. The following message is shown on the display phone:

**DIAL PULSE RATIO SPEED**  
**6040 10PPS**

- b. The Dial Pulse features will toggle on and off with each depression, and the display will update with each depression.
- LED on = 60/40 (RATIO), 10pps (SPEED)
  - LED off = 66/33 (RATIO), 20pps (SPEED)
- c. Press the HOLD button to save the entry. Confirmation tone is heard and the display will now update.

Description

By default all lines are DTMF (tone) signaling. If outpulsing is required, the individual outside line must be programmed for pulse. The break/make ratio and the dial speed can be programmed at this time.

The buttons on the digital terminal are defined as shown below when entering the Dial Pulse Parameter programming area:

Q 1	BREAK/MAKE RATIO		11 A
W 2	SPEED		12 S

**Default:** By default, the break/make ratio (RATIO) is set at 60/40 but can be changed to 66/33. By default, the dialing speed (SPEED) is 10pps but can be changed to 20pps.

**Related Programming:** Refer to Sec. 620.1, CO Line Programming for DTMF/Dial Pulse Programming.

**NOTE**

*This program code is only used when an outside (CO,J) line has **been** programmed for dial pulse.*

CO LINE ATTRIBUTES (Cont'd)

620.3 FLEXIBLE PORT ASSIGNMENT FEATURE

Programming Steps

If the CO Line numbers need to be relocated to different ports:

- a. Press FLASH and dial [42]. The following message is shown on the display phone:

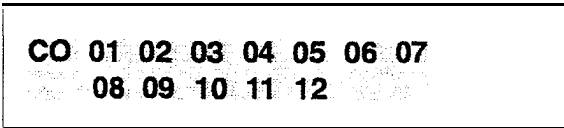

- b. The buttons 1 through 4 indicate cards 1 through 4. When the relocation program is initially entered, Button #1 will be lit indicating that the user is programming the CO Line numbers on the first card (CO Ports 1 through 12). The LCD will display the CO line numbers presently assigned to the first 12 ports.

To change the CO Line number assigned to any port:

- a. Dial the position number on the display (01 through 12), followed by the CO Line number desired.

Example:

- if 0103 were dialed, the CO line number of the first entry on the display would be changed to 03. In addition, since 03 was shown as the third entry on the display, that entry would be blank (##).

To select another card in the system:

- a. Press the button associated with that card. For example, if Button #3 were pressed (CO ports 25 through 36), the CO Line numbers assigned to the third card would be displayed. CO Line numbers on the third card are changed in the same manner by entering the position number (01 through 12), followed by the CO Line number desired.

**NOTE** When all the CO Line numbers desired have been programmed, the system will have to be reset to update the data. This is done so that the programming of CO lines can be done while the system is in use.

Description

The Flexible Port Assignment feature will provide a means to assign CO line numbers to any CO line port in the system. This provides complete flexibility in determining CO line numbers within the system as long as they stay within the system numbering plan. A CO line can be assigned any number between 01 and 48 on the Starplus SPD 4896 system. This restriction is required to minimize memory requirements on the smaller systems.

The buttons on the digital terminal are defined as shown below when entering the Flexible Port Assignment feature programming area:

1	Q	CARD #1		11	A
2	W	CARD #2		12	S
3	E	CARD #3		13	D
4	R	CARD #4		14	F
5	T	CARD #5		15	G
6	Y	CARD #6		16	H
7	U	CARD #7		17	J

All CO line numbers entered are stored in a temporary database area which is uploaded to the main database when the system is reset.

CARD #	CO LINE #	PORT #
1	i-12	1-12
2	13-24	13-24
3	25-36	25-36
4	37-48	37-48

**NOTE** If a CO Loop Interface Board (CO12) is not in Card Slot #1, and Button #1 is pressed, pound (#'s) will appear on the display instead of CO Line numbers.

**TABLE OF CONTENTS FOR SECTION 630**

<b>SECTION 630</b>	<b>STATION ATTRIBUTES PROGRAMMING</b> .....	630-1
630.1	INTRODUCTION .....	630-1
	A. Paging Access.. .....	630-2
	B. Do Not Disturb .....	630-2
	C. Conference Enable/Disable (Per Station). .....	630-3
	D. Executive Override .....	630-3
	E. Privacy (Per Station). .....	630-4
	F. System Speed Dial Access .....	630-5
	G. Line Queuing .....	630-5
	H. Preferred time Answer.. .....	630-6
	I. Off-Hook Voice Over.. .....	630-6
	J. Call Forwarding.. .....	630-7
	K. Forced Least Cost Routing (LCR) .....	630-7
	L. ACD Supervisor Monitor w/Barge-In.. .....	630-8
	M. Executive Override Blocking.. .....	630-8
	N. CO Line Ringing Options.. .....	630-9
630.2	PAGE "8" INTRODUCTION .....	630-i 0
	A. Station Identification .....	630-l 1
	B. Station Class of Service (COS) .....	630-l 4
	C. Speakerphone/Headset Programming .....	630-l 5
	D. Pick-Up Group(s) Programming .....	630-l 5
	E. Paging Zone(s) Programming.. .....	630-l 6
	F. Preset Call Forward Programming .....	630-l 7
	G. CO Line Group Access.. .....	630-l 8
	H. LCR Class of Service (COS) .....	630-l 8
	I. Off-Hook Preference Programming .....	630-l 9
	J. Flexible Button Programming .....	630-20
	K. Display Flexible Buttons .....	630-22
630.3	DIGITAL DATA INTERFACE UNIT (DDIU) .....	630-23
	A. Baud Rate Options .....	630-23
	B. Character Length Option .....	630-24
	C. Stop Bit(s) Option .....	630-24
630.4	FLEXIBLE PORT ASSIGNMENT FEATURE .....	630-25

# SECTION 630

## STATION ATTRIBUTES PROGRAMMING

### 630.1 INTRODUCTION

#### Programming Steps

If the system is in the programming mode, continue using the program codes. If starting to program here, enter the programming mode. Refer to 600.2, Program Mode Entry (**Key Station**).

If station features are to be changed:

- a. Press FLASH and dial [50]. The following message is shown on the display phone:

**STATION ATTRIBUTES  
 SELECT A STATION RANGE**

- b. Enter a six-digit number (100-195) for station range being programmed. If only one station is being programmed, enter that numbertwice i.e. (100100).
- c. Press the HOLD button to save the entry. Confirmation tone is heard and the display will now update. Flexible button #20 (New Range) will be lit. The display updates to current programming for Page A:

**XXX-XXX A PA DD CF \_A PR  
 SP QU PL OH FW LC SB M**

Where:

- XXX = Station Range (100-195)
- A= Page "A" Features
- PA = Paging Access is allowed
- DD = Do Not Disturb is allowed
- CF = Conference is allowed
- \_A = Executive Override is disabled  
 Exec Override Blocking is allowed
- PR = Privacy is enabled
- SP = System Speed Dial is allowed
- QU = Queuing is allowed
- PL = Preferred Line Answer is enabled
- OH= Off-Hook Voice Over is allowed
- FW=Call Forward is allowed
- LC = Forced LCR Enabled
- SB = ACD\* Supervisor Barge-in\*
- M= CO Ringing option is muted

#### Description

This section describes the steps and procedures necessary to program station attributes for stations connected to the Starplus Digital Key Telephone system. When entering the Station attributes portion of the database, the programmer may decide to enter information for either a range of stations or one specific station.

Range programming allows the programmer to change a specific parameter or a few parameters for an entire range of stations leaving intact the remaining data fields that do not require change. Those data fields will continue to operate with the previously programmed data.

Station Attributes are divided between those features that require either a simple allow/deny or Enable/Disable (toggle) operation and those that require a numeric entry. The allow/deny (toggle) type features are programmed on page "A".

When programming the Page "A" features, the flexible buttons are mapped as follows:

1	Q	PAGE ACCESS	FORCED LCR	11	A
2	W	DO NOT DISTURB	ACD SUPV BARGE-IN	12	S
3	E	CONFERENCE	EXEC OVERRIDE BLOCKING	13	D
4	R	EXECUTIVE OVERRIDE	CO LINE RING OPTIONS	14	F
5	T	PRIVACY		15	G
6	Y	SYSTEM SPEED		16	H
7	U	LINE QUEUING		17	J
8	I	PREF LINE ANSWER	SELECT PAGE A	18	K
9	O	OHYO	SELECT PAGE B	19	L
10	P	CALL FORWARD	NEW STATION RANGE	20	;

- Button #18 [PAGE "A"] selects Page "A" and displays Page "A" parameters..
- Button #19 [PAGE "B"] selects Page "B" and displays Page "B" parameters..
- Button #20 [Select Range] will prompt for a new Station range.

\* Features available with optional software.



## STATION ATTRIBUTES PROGRAMMING

## PAGE "A" STATION ATTRIBUTES (Cont'd)

## A. Paging Access

Programming Steps

1. Press the PAGE ACCESS flexible button (Page A, Button #1). This feature will toggle on and off with each depression, and the display will update with each depression.
  - LED on = Paging is allowed
  - LED off= Paging is denied
2. Press the HOLD button to save the entry. Confirmation tone is heard.

Description

**PAGE ACCESS.** Stations can individually be allowed or denied the ability to make pages. This applies to all internal and external zone paging. A station denied access to paging may still answer a meet-me page announcement. (Station COS 6 will not deny a station the ability to make a page.)

**Default:** By default, Paging is allowed at all stations.

```

XXX-XXX A PA DD CF _A PR
SP QU PL OH FW LC SB M
  
```

## B. Do Not Disturb

Programming Steps

1. Press the DO NOT DISTURB flexible button (Page A, Button #2). This feature will toggle on and off with each depression, and the display will update with each depression.
  - LED on = Do Not Disturb is allowed
  - LED off= Do Not Disturb is denied
2. Press the HOLD button to save the entry. Confirmation tone is heard.

Description

**DO NOT DISTURB.** Stations can be individually allowed or denied the ability to place their telephone in Do Not Disturb.

**Default:** By default, Do Not Disturb is allowed at all stations.

```

XXX-XXX A PA DD CF _A PR
SP QU PL OH FW LC SB M
  
```

PAGE "A" STATION ATTRIBUTES (Cont'd)

C. Conference Enable/Disable (Per Station)

Programming Steps

1. Press the CONFERENCE flexible button (Page A, Button #3). This feature will toggle on and off with each depression, and the display will update with each depression.
  - LED on = Conference is enabled
  - LED off = Conference is disabled
2. Press the HOLD button to save the entry. Confirmation tone is heard.

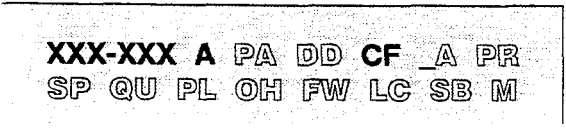

Description

**CONFERENCE.** This feature allows the system to be programmed on a per Station basis for the ability to initiate a conference.

Only stations that have Conference enabled will be able to initiate a conference.

A station that is denied conferencing capabilities in programming can be a party to another stations conference provided that station does have conferencing privileges.

**Default:** By default, Conference is enabled for all stations.

D. Executive Override

Programming Steps

1. Press the EXECUTIVE OVERRIDE flexible button (Page A, Button #4). This feature will toggle on and off with each depression, and the display will update with each depression.
  - LED on = Executive Override is allowed
  - LED off = Executive Override is denied
2. Press the HOLD button to save the entry. Confirmation tone is heard.

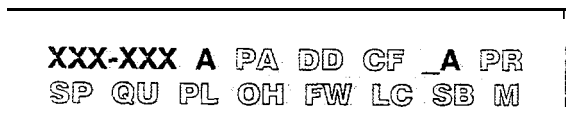

Description

**EXECUTIVE OVERRIDE.** This feature allows certain stations to be designated as "Executive" stations with the ability to override and "barge-in" on other keysets engaged in a CO line or intercom conversation.

An optional warning tone is programmed on a system wide basis to either enable or disable the tone. This tone will be presented to all parties prior to actual cut thru of the third party.

**NOTE** A separate condition has been added to this feature which will allow or disallow an Executive to override an extension. This prevents an extension with override capability from overriding an Executive's station. Refer to Item M. Executive Override Blocking later in this section.

**CAUTION**

USE OF THIS FEATURE WHEN THE EXECUTIVE OVERRIDE WARNING TONE IS DISABLED MAY BE INTERPRETED AS A VIOLATION OF FEDERAL, STATE OR LOCAL LAWS, AND AN INVASION OF PRIVACY. CHECK APPLICABLE LAWS IN YOUR AREA BEFORE INTRUDING ON CALLS USING THIS FEATURE.

**Default:** By default, Executive Override is disabled for all stations.

**Related Programming:** Refer to Sec. 610.2, System Features Programming, Exec Override Warning Tone. Also refer to Sec. 630.1, ACD Supervisor Monitor w/Barge-in.

**STATION ATTRIBUTES PROGRAMMING**

**PAGE "A" STATION ATTRIBUTES (Cont'd)**

**E. Privacy (Per Station)**

Programming Steps

Description

To program station(s) for Automatic Privacy:

1. Press the PRIVACY flexible button (Page A, Button #5). This feature will toggle on and off with each depression, and the display will update with each depression.
  - LED on = Privacy is enabled on Stations(s)
  - LED off = Privacy is disabled on Station(s)
2. Press the HOLD button to save the entry. Confirmation tone is heard.

**PRIVACY.** The system provides privacy on all communications in the system which prevents other stations from accidentally entering an existing conversation. However, if desired,, the system will allow on a per station basis the ability for a station to join an existing outside CO line conversation. Each station can be granted the privilege to join an existing CO line conversation by simply pressing the CO line button of a CO line in use.

- Both the station and the CO line must have privacy disabled before the system will allow cut-thru.
- If privacy is disabled and a station joins an existing call, a programmable warning tone is presented to both parties prior to actual cut-thru.
- If privacy is disabled, up to three other stations may join in on an existing conversation.

**Default:** Privacy is enabled for all stations in default.

**Related Programming:** Refer to Sec. 610.3, Additional System Features, Privacy Release Tone Option for disabling of the conference tone. Also refer to Sec. 620.1, CO Line Programming, Privacy in CO Line Attributes programming.

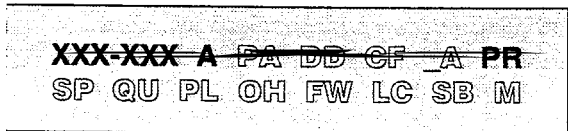

**NOTE** Disabling of the privacy feature may be limited by federal, state or local law, so check the relevant laws in your area before disabling privacy.

The Station Privacy flag affects a station users ability to access CO lines already engaged in conversation by another station in the system as shown in the following table:

Station Attempting to Access CO Line	CO Line in Use by Another Station	
	Privacy Enabled	Privacy Disabled
Privacy Enabled	Private (No Cut-through)	Private (No Cut-through)
Privacy Disabled	Private (No Cut-through)	Privacy Released (Cut-through Allowed)

PAGE "A" STATION ATTRIBUTES (Cont'd)

F. System Speed Dial Access

Programming Steps

1. Press the SPEED flexible button (Page A, Button #6). This feature will toggle on and off with each depression, and the display will update with each depression.
  - LED on = System Speed Dialing access is allowed
  - LED off= System Speed Dialing access is denied
2. Press the HOLD button to save the entry. Confirmation tone is heard.

```
XXX-XXX A PA DD CF _A PR  
SP QU PL OH FW LC SB M
```

Description

**SYSTEM SPEED DIALING ACCESS.** Stations can be individually allowed or denied the ability to use system speed dial '(20-99) numbers. The last 40 system speed numbers are not monitored by toll restriction. Stations can not be prevented from using station speed dial.

**Default:** By default, System Speed Dialing is allowed at all stations.

**Related Programming:** Refer to Sec. 660.1, Exception Tables Programming.

G. Line Queuing

Programming Steps

1. Press the QUEUING flexible button (Page A, Button #7). This feature will toggle on and off with each depression, and the display will update with each depression.
  - LED on = Queuing is allowed
  - LED off= Queuing is denied
2. Press the HOLD button to save the entry. Confirmation tone is heard.

```
XXX-XXX A PA DD CF _A PR  
SP QU PL OH FW LC SB M
```

Description

**LINE QUEUING.** Stations can be allowed or denied the ability to manually queue for a busy group of CO lines. Even when disabled, stations will have automatic LCR queuing privileges.

**Default:** By default, CO Line Queuing is allowed at all stations.

## STATION ATTRIBUTES PROGRAMMING

## PAGE "A" STATION ATTRIBUTES (Cont'd)

## H. Preferred Line Answer

Programming Steps

1. Press the PREF LINE ANSWER flexible button (Page A, Button #8). This feature will toggle on and off with each depression, and the display will update with each depression.
  - LED on = Preferred Line Answer is allowed
  - LED off= Preferred Line Answer is denied
2. Press the HOLD button to save the entry. Confirmation tone is heard.

Description

**PREF LINE ANSWER.** Stations can be given the ability to answer incoming outside line calls, transferred and recalling lines and line queues by simply going off-hook. (Preferred Line Answer)

**Default:** By default, Preferred Line Answer is disabled on all stations.

```

XXX-XXX A PA DD CF _A PR
SP QU PL OH FW LC SB M
  
```

## I. Off-Hook Voice Over

Programming Steps

1. Press the OHVO flexible button (Page A, Button #9). This feature will toggle on and off with each depression, and the display will update with each depression.
  - LED on = Off-Hook Voice Over is allowed
  - LED off= Off-Hook Voice Over is denied
2. Press the HOLD button to save the entry. Confirmation tone is heard.

Description

**OHVO.** This feature allows a station to receive OHVO calls. Only OHVO Digital Terminals may receive an OHVO call. A station can be denied the ability to receive OHVO calls by disabling the OHVO option.

**Default:** By default, Off-Hook Voice Over is disabled for all stations.

```

XXX-XXX A PA DD CF _A PR
SP QU PL OH FW LC SB M
  
```

PAGE "A" STATION ATTRIBUTES (Cont'd)

J. Call Forwarding

Programming Steps

1. Press the CALL FORWARD flexible button (Page A, Button #10). This feature will toggle on and off with each depression, and the display will update with each depression.
  - LED on = Call Forwarding is allowed
  - LED off= Call Forwarding is denied
2. Press the HOLD button to save the entry. Confirmation tone is heard.

```
XXX-XXX A PA DD CF A PR  
SP QU PL OH FW LC SB M
```

Description

**CALL FORWARD.** Stations can be allowed or denied the ability to have incoming CO calls, intercom, transferred outside lines forwarded to another station, ACD, UCD, Hunt or Voice Mail group or Off-Net Forward via speed dial.

**Default:** By default, Call Forwarding is allowed at all stations.

K. Forced Least Cost Routing (LCR)

Programming Steps

1. Press the FORCED LCR flexible button (Page A, Button #11). This feature will toggle on and off with each depression, and the display will update with each depression.
  - LED on = Least Cost Routing is forced
  - LED off= Least Cost Routing is optional
2. Press the HOLD button to save the entry. Confirmation tone is heard.

```
XXX-XXX A PA DD CF A PR  
SP QU PL OH FW LC SB M
```

Description

*This feature is available with optional software.*

**FORCED LCR.** Stations may be forced to place outgoing CO calls by use of LCR (dial [9]) to access an outside line). This allows the system administrator to control dialing patterns and the lines used for outgoing CO calls more effectively. This can be enabled/disabled on a per station basis for additional flexibility and control.

**Default:** Forced LCR is optional for all stations.

**Related Programming:** Refer to Sec. 630.1, LCR Class of service (COS); Sec. 610.2, LCR Enable; 665.1, Least Cost Routing (LCR) Programming.

## STATION ATTRIBUTES PROGRAMMING

## PAGE "A" STATION ATTRIBUTES (Cont'd)

## L. ACD Supervisor Monitor w/Barge-in

Programming Steps

1. Press the **SUPV BARGE-IN** flexible button (Page A, Button #12). This feature will toggle on and off with each depression, and the display will update with each depression.
  - LED on = ACD Supv Barge-in is allowed
  - LED off= ACD Supv Barge-in is denied
2. Press the HOLD button to save the entry. Confirmation tone is heard.

```

XXX-XXX A PA DD CF _A PR
SP QU PL OH FW LC SB M
  
```

**NOTE**

The use of silent monitor and **barge-in** is limited by federal law and may also be limited or prohibited by state or **local** law, so check the relevant laws in your area before employing these features.

Description

**This feature is available with optional software.**  
The ACD Supervisor Monitor with Barge-In feature provides a means for an ACD Supervisor to monitor an agents call in progress in' order to coach sales techniques or customer relations skills. When used, a supervisor may intrude onto an agents call in a listen only mode or in a true conference mode. This feature is available with or without .a warning tone.

**NOTE**

**Executive Override is a System feature and therefore takes precedence over this feature. If Supervisor Monitor with Barge-In is to be used properly, Executive Override MUST be disabled otherwise the Barge-In is performed with the MUTE button OFF!**

**Default:** By default, the Supervisor Monitor w/Barge-In feature is not allowed.

**Related Programming:** Refer to Sec. 630.1, Executive Override.

## M. Executive Override Blocking

Programming Steps

1. Press the EXECUTIVE OVERRIDE BLOCKING flexible button (Page A, Button #13). This feature will toggle on and off with each depression, and the display will update with each depression.
  - LED on = Blocking is denied.
  - LED off= Blocking is allowed.
2. Press the HOLD button to save the entry. Confirmation tone is heard.

```

XXX-XXX A PA DD CF _A PR
SP QU PL OH FW LC SB M
  
```

Description

The Executive Override Feature has a separate condition added to it which will allow or disallow an Executive to override an extension. This prevents an extension with override capability from overriding an Executive's station.

**NOTE**

**The Executive Override Blocking feature will also block an ACD Supervisor Monitor w/Barge-in.**

**Default:** By default, Executive Override is allowed at all stations.

**Related Programming:** Refer to Sec. 610.2, System Features Programming,- Executive Override.

PAGE "A" STATION ATTRIBUTES (Cont'd)

N. CO Line Ringing Options

Programming Steps

1. Press the **RINGING** OPTIONS flexible button (Page A, Button #14). This feature will toggle on and off with each depression, and the display will update with each depression.
  - LED on = Reminder Ring is allowed
  - LED off= Muted Ringing is allowed
2. Press the HOLD button to save the entry. Confirmation tone is heard.

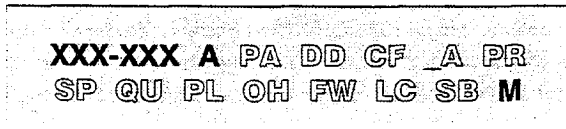

Description

When a CO call rings at a busy station, the call rings at the station using a muted ring signal. This option allows a user to receive a reminder ring at his station, instead of muted ring. In addition, a reminder ring timer has also been added to the system to provide the reminder ring every time the timer expires, for as long as the incoming CO line has not been disconnected.

When the reminder ring option is used, the type of reminder ring tone is determined by the Tone Ring Option code [695] programmed on the keyset. It is also possible that this tone or a portion of this tone could be heard in the handset, depending on the keyset ring volume setting.

**Default:** By default, Muted Ringing is allowed at all stations.

**Related Programming:** Refer to Sec. 610.1, Reminder Ring Timer



PAGE "B" STATION ATTRIBUTES (Cont'd)

630.2 PAGE "B" INTRODUCTION

Programming Steps

If the system is in the programming mode, continue using the program codes. If starting to program here, enter the programming mode. Refer to 600.2, Program Mode Entry (Key Station).

If station features are to be changed:

- a. Press FLASH and dial [50]. The following message is shown on the display phone:

**STATION ATTRIBUTES  
SELECT A STATION RANGE**

- b. Enter a six-digit number (100-1 95) for station range being programmed. If only one station is being programmed, enter that numbertwice i.e. (100100).
- c. Press the HOLD button to save the entry. Confirmation tone is heard and the display will now update. Flexible button #20 (New Range) will be lit.
- d. Press [PG B] button. The display of current programming for those features will appear as follows:

**XXX-XXX B ID0 COS1 1 SPO  
AAAA BBBB CCC DDDDDDD L0**

- XXX = Station Range (100-1 95)
- B = Page "B" Features
- ID = Station Identification (0-7)
- COS = Class of Service (1-6)
- SPK = Spkrphone/Headset Option (0-2)
- AAAA = Pickup Group (1-4)
- BBBB = Paging Zone (1-4)
- CCC = Preset Forward Destination
- DD...DD = CO Line Group access(0-7)
- L0 = LCR Class of Service (0-6)

Description

This section describes the steps and procedures necessary to program the Page "B" station attributes for stations connected to the Star-plus Digital Key Telephone System. When entering the Station attributes portion of the database, the programmer may decide to enter information for either a range of stations or one specific station.

Range programming allows the programmer to change a specific parameter or a few parameters for an entire range of stations leaving intact the remaining data fields that do not require change. Those data fields will continue to operate with the previously programmed data.

**NOTE** Features programmed in Page "B" require a numeric entry after pressing the flexible button.

When programming the Page "B" features, the flexible buttons are mapped as follows:

1	Q	STATION ID		11	A
2	W	CLASS OF SERVICE		12	S
3	E	SPEAKERPHONE		13	D
4	R	GROUP PREFIX		14	F
5	T	PAGING ZONES		15	G
6	Y	PRESET FORWARD		16	H
7	U	CO LINE GP ACCESS	DISPLAY BUTTONS	17	J
8	I	LCR COS	SELECT PAGE A	18	K
9	O	OFF-HOOK PREF	SELECT PAGE B	19	L
10	P	BUTTON ASSIGN	NEW STATION RANGE	20	:

- Button #18 [PAGE "A"] selects Page "A" and displays Page "A" parameters.
- Button #19 [PAGE "B"] selects Page "B" and displays Page "B" parameters.
- Button #20 [Select Range] will prompt for a new Station range.

PAGE "B" STATION ATTRIBUTES (Cont'd)

A. Station Identification

Programming Steps

1. Press the STATION ID flexible button (Page B, Button #1).

To program the Station ID for a Digital Terminal:

1. Dial a [0] on the dial pad.
2. Press the HOLD button to save the entry. Confirmation tone is heard and the display will now update.

```
XXX-XXX B ID0 COS1 1 SPO
AAAA BBBB CCC DDDDDDD LO
```

Description

**STATION ID.** Each system port must be programmed to identify the type of station that will operate on that port. Each station type must be identified.

**Default:** By default, all Key Telephone Boards (KT12) default to ID 0 (Digital Terminal), all Single Line Boards (SL12) default to ID 5 (SLT or OPX).

**NOTE** When identifying a station as a DSS/DLS Console, you must also enter the station number of the Key Telephone the DSS/DLS Console is associated with.

To program the Station ID for a DSS/DLS Console with Map 1, Map 2, Map 3, or Map 4:

Programming Steps

1. Dial either a [1],[2][3], or [4] on the dial pad.
2. Enter the three-digit station number (100-195) which the DSS/DLS Console is associated with.
3. Press the HOLD button to save the entry. Confirmation tone is heard and the display will now update.

```
XXX-XXX B ID1 COS1 1 SPO
AAAA BBBB CCC DDDDDDD LO
```

Description

**MAP #1.** By default, the first 12 CO Lines and the first 36 Stations, 100-135. This provides a default layout for a 12x36 configuration. Only Station buttons are flexible and can be changed by the station user. CO Line buttons are NOT changeable.

**MAP #2.** By default, the first 48 Stations, 100-147. All buttons are flexible and can be changed by the station user.

**MAP #3.** By default, is intended to be used with Map #2 in that it has the remaining stations, 148-195 to provide a full Station mapping. All of the buttons on Map #3 are flexible and can be changed by the user.

**MAP #4.** By default, contains all 48 CO Lines to provide a full CO mapping.

**Related Programming:** Refer to Sec. 620.1, CO Line Programming, CO Line Programming for CO Line ringing assignments on Maps 1 and 4.

**STATION ATTRIBUTES PROGRAMMING****PAGE "B" STATION ATTRIBUTES (Cont'd)****Station Identification (Cont'd)**

To program the Station ID for a SLT or OPX Station:

Programming Steps

1. Dial a [5] on the dial pad.
2. Press the HOLD button to save the entry. Confirmation tone is heard and the display will now update.

```
XXX-XXX B ID5 COS1 1 SPO
AAAA BBBB CCC DDDDDDD LO
```

Description

**SLT/OFF PREMISE EXTENSION (OPX):** This external module provides the interface for one long loop (OPX) single line telephone (2500 type) extension. This module requires a separately provided -48V dc power supply to provide the necessary current for long loop applications and to support ring generation. This module is wired to and interfaces with a digital key station port on the Starplus SPD 4896 system. The OPX card meets the requirements of the FCC for connection to the telephone (Telco) network. Telephones must be DTMF only (2500 type).

**Related Programming:** Refer to Figure 500-15 Off-Premise Extension (OPX) Module.

This module also provides for one Power Fail circuit in the event of an AC power failure.

To program the Station ID for a SLT w/Message Waiting Lamp:

Programming Steps

1. Dial a [6] on the dial pad.
2. Press the HOLD button to save the entry. Confirmation tone is heard and the display will now update.

```
XXX-XXX B ID6 COS1 1 SPO
AAAA BBBB CCC DDDDDDD LO
```

Description

**SINGLE LINE TELEPHONE (SLT):** The Starplus Digital Key Telephone System supports industry standard 2500 Type (DTMF) single line instruments. When the Single Line Board (SL12) is installed in the system, a maximum of 12 single line telephones may be supported. The Starplus SPD 4896 system will support up to 84 single line telephones through the user of single line boards and/or SLA/OPX boxes,

PAGE "B" STATION ATTRIBUTES (Cont'd)

Station Identification (Cont'd)

To program the Station ID for a Relay/Sensor Module:

Programming Steps

1. Dial a [7] on the dial pad.
2. Press the HOLD button to save the entry. Confirmation tone is heard and the display will now update.

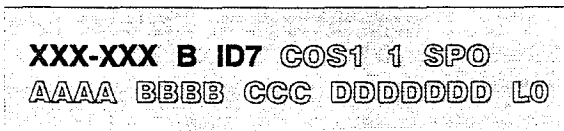

Description

**RELAY/SENSOR MODULE:** The Relay Sensor Interface Module connects to the system using one digital station port and provides three relay activated contacts and three sensing circuits. The relays provide for applications such as Loud Bell Control contacts, CO Line control contacts, RAN Start contacts, Page Relays, Power Fail contact and additional applications as software will permit. The sensing circuits will provide for such applications as RAN Stop (end of message).

To program the Station ID for a Digital Data Interface box (DDIU):

Programming Steps

1. Dial a [8] on the dial pad.
2. Enter the three-digit associated station number. (100-1 95) or Enter ### in the case of a DDIU without an associated station.
3. Press the HOLD button to save the entry. Confirmation tone is heard and the display will now update.

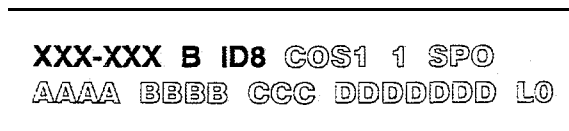

Description

**DIGITAL DATA INTERFACE BOX:** The Data Feature is a time division, point to point data transmission capability which permits simultaneous voice and data communications (within the same system but not the same port). The Data Feature offers the ability to transmit data information between personal computers, printers, plotters, modems, CRT terminals, and main frame computer ports.

To establish a data call, a Digital Data Interface box (DDI) is required to be connected to each data communications device. The DDIU allows any serial data communications device (which conforms to RS-232C) to be connected to the Starplus Digital system. Data information can be switched through the system at speeds of 300, 1200, 2400, 4800, 9600, 19.2K and 38.4K baud asynchronous.

PAGE "B" STATION ATTRIBUTES (Cont'd)

B. Station Class of Service (COS)

Programming Steps

1. Press the CLASS OF SERVICE flexible button (Page B, Button #2).
2. Enter a two-digit Class of Service entry as follows:
  - 1st digit is day COS
  - 2nd digit is night COS

The six classes of service are:

- [1] = unrestricted
- [2] = governed by Table A
- [3] = governed by Table B
- [4] = governed by Tables A and B
- [5] = no 0,1,\*,# as first digit, 7 digits max.
- [6] = intercom only (no CO Line access)

3. Press the HOLD button to save the entry. Confirmation tone is heard and the display will now update.

Description

**CLASS OF SERVICE.** Each stations must be assigned a certain COS for day mode operation, and also be assigned a COS for night mode operation. The night COS goes into affect when the system is placed into the night mode, manually or automatically. This prevents the misuse of phones after hours.

**Class of service (COS)** determines the stations dialing privileges. Refer to Table 630-I Class of Service (COS).

**Default:** By default, all stations are assigned a COS 1 for day mode and COS 1 for night mode.

**Related Programming:** Refer to Sec. 620.1, CO Line Programming, Class of Service (COS) Programming; and Sec. 660.1, Exception Tables Programming.

```

XXX-XXX B IDO COS1 1 SPO
AAAA BBBB CCC DDDDDDD L0
    
```

Table 630-I Class of Service (COS)

	CO LINE CLASS OF SERVICE					
	1	2	3	4	5	
S T A T I O N  C O S	1	Unrestricted	Unrestricted	Unrestricted	Canned Restriction*	Unrestricted
	2	Table A	Table A	Unrestricted	Canned Restriction*	Unrestricted
	3	Table B	Unrestricted	Table B	Canned Restriction*	Unrestricted
	4	Tables A&B	Table A	Table B	Canned Restriction*	Unrestricted
	5	Canned Restriction*	Canned Restriction*	Canned Restriction*	Canned Restriction*	Unrestricted
	6	Intercom only	Intercom only	Intercom only	Intercom only	Intercom only

\* Canned Restriction= No '0', 1, #, '\*' as a first dialed digit, and 7 digits maximum plus 1-800, 1911, 1611 are allowed and 411,976, and 555 numbers are denied.

PAGE "B" STATION ATTRIBUTES (Cont'd)

C. Speakerphone/Headset Programming

- | <u>Programming Steps</u>   | <u>Description</u>  |
|--|---|
| 1. Press the SPEAKERPHONE flexible button (Page B, Button #3).<br>2. Enter a one-digit number on the dial pad between 0 and 2 to identify the speakerphone operation.<br>- [0] = works as normal speakerphone. Full speakerphone capabilities on both CO lines and Intercom.<br>- [1] = Speakerphone enabled for intercom calls only. Speakerphone capabilities disabled for outgoing CO line calls (monitoring and on-hook dialing are still allowed).<br>- [2] = Speakerphone is disabled completely. Allows for headset operation.<br>3. Press the HOLD button to save the entry. Confirmation tone is heard and the display will now update. | <p><b>SPEAKERPHONE.</b> Each telephone's speakerphone ability is programmable in one of three ways. A speakerphone Id of 2 will allow the station user to enable headset mode by dialing a code. The station user may then return to full speakerphone operation by dialing the same code again.</p> <p><b>Default:</b> By default, all stations are assigned an ID of 0.</p> <p>This feature is NOT available on the Starplus 14-Button Basic telephone. The Basic telephone has handsfree answer-back on intercom only!</p> |

```

XXX-XXX B ID0 COS1 1 SPO
AAAA BBBB CCC DDDDDDD LO
```

D. Pick-Up Group(s) Programming

- | <u>Programming Steps</u>   | <u>Description</u>   |
|--|--|
| 1. Press the GROUP PICKUP flexible button (Page B, Button #4).<br>2. Enter a one-to-four digit number to program pickup groups.<br>- [0] = no group<br>- [1] = Group 1<br>- [2] = Group 2<br>- [3] = Group 3<br>- [4] = Group 4<br>3. Press the HOLD button to save the entry. Confirmation tone is heard and the display will now update. | <p><b>GROUP PICKUP.</b> Each station is assigned into pick up groups. Stations can be in any combination of the four groups or in no group at all.</p> <p><b>Default:</b> By default, all stations are in group 1.</p> |

```

XXX-XXX B ID0 COS1 1 SPO
AAAA BBBB CCC DDDDDDD LO
```

**STATION ATTRIBUTES PROGRAMMING****PAGE "B" STATION ATTRIBUTES (Cont'd)****E. Paging Zone(s) Programming**

- | <u>Programming Steps</u>  | <u>Description</u>   |
|---|--|
| 1. Press the PAGING ZONES flexible button (Page B, Button #5).  | <b>PAGING ZONES.</b> Each station is assigned to internal paging zones. A station can be in any or all zones or in no zone at all.<br>All Call is all page zones combined. If a station is not in any internal zone, it will not receive any all call pages. |
| 2. Enter a one-to-four digit number to program paging zone(s).<br>- [0] = no zone (no pages received)<br>- [1] = Zone 1<br>- [2] = Zone 2<br>- [3] = Zone 3<br>- [4] = Zone 4 |  |
| 3. Press the HOLD button to save the entry. Confirmation tone is heard and the display will now update.   |  |

**Default:** By default, all stations are in Page Zone 1.

XXX-XXX B ID0 COS1 1 SPO  
AAAA BBBB CCG DDDDDDD L0

PAGE "B" STATION ATTRIBUTES (Cont'd)

F. Preset Call Forward Programming

Programming Steps

1. Press the PRESET FORWARD flexible button (Page B, Button #6).
2. Enter a three-digit number to determine the destination where calls are to be routed when the preset forward timer expires.

Valid 3 digit destinations are:

[020-099] = System Speed Bins 20-99 for off-net forwarding

[100-195] = Station Numbers

[440-447] = Voice Mail Groups 1-8

[450-457] = Hunt Groups 1-8

[550-557] = UCD Groups 1-8

[550-565] = ACD Groups 1-6

3. Press the HOLD button to save the entry. Confirmation tone is heard and the display will now update.

```
XXX-XXX B ID0 COS1 1 SPO  
AAAA BBBB CCC DDDDDDD LO
```

Description

**PRESET FORWARD.** This feature allows the system database to be configured so that incoming CO Lines, which are programmed to ring at a particular station, can be forwarded elsewhere in the system predetermined by programming. This feature is active if the station ringing is not answered in a specified time. This is particularly useful in "overflow applications where a Voice Mail or **Auto** Attendant may be in use.

A station may have one designated preset forward location defined in the database.

Preset Call Forward is chainable only to other predetermined preset forward stations specified in the database up to a chain of 5 stations. If a CO Line forwarded by Preset Call Forward encounters a manually forwarded station (Call Forward - Station), or a station in DND, then the incoming CO Line will bypass that station and forward to the next in the chain. If that station is the last in the chain, then the call will not forward any further and will continue to ring at that station until answered or terminated.

Chainable Preset Call Forwarding will force the incoming CO Line to ring at each station preassigned in the database for the Preset Forward Ring Timer, specified in the database, before forwarding.

CO Lines can be preset forwarded to ring into an ACD, UCD, Voice Mail, Hunt Group or Off-Net via speed dial from any station. A CO line will not preset forward to a busy hunt, voice mail, ACD, or UCD group, however each time the preset forward timer expires (for a total of five attempts) the group will be checked for an idle station. If a member of the group is idle the call will then be presented to that member.

**Default:** By default, no preset forward destinations are programmed.

**Related Programming:** Refer to Sec. 610.1, System Timers, Preset Forward Timer.



**STATION ATTRIBUTES PROGRAMMING****PAGE "B" STATION ATTRIBUTES (Cont'd)****G. CO Line Group Access**

- | <u>Programming Steps</u>  | <u>Description</u>  |
|---|---|
| <ol style="list-style-type: none"> <li>1. Press the CO LINE GROUP ACCESS flexible button (Page B, Button #7).</li> <li>2. Enter up to seven digits (0, or 1-7) for the outside line groups the station will have access to. <ul style="list-style-type: none"> <li>- [0] = no access</li> <li>- [1] = access to Group 1, Code 9 or 81</li> <li>- [2] = access to Group 2, Code 82</li> <li>- [3] = access to Group 3, Code 83</li> <li>- [4] = access to Group 4, Code 84</li> <li>- [5] = access to Group 5, Code 85</li> <li>- [6] = access to Group 6, Code 86</li> <li>- [7] = access to Group 7, Code 87</li> </ul> </li> <li>3. Press the HOLD button to save the entry. Confirmation tone is heard and the display will now update.</li> </ol> | <p><b>CO LINE GROUP ACCESS.</b> A station is allowed access to any combination of outside line groups. Or a station may not be allowed any access to outside lines. The following are the line group numbers and their access codes.</p> <p>CO line groups are used primarily by single line telephones or for flexible buttons assigned as pooled group buttons on a Key Telephone.</p> <p><b>Default:</b> By default, all stations are allowed access to Group 1.</p> <p><b>Related Programming:</b> Refer to Sec. 620.1, CO Line Programming, CO Line Group Programming.</p> |

```

XXX-XXX B IDO COS1 1 SPO
AAAA BBBB CCC DDDDDDD LO

```

**H. LCR Class of Service (COS)**

- | <u>Programming Steps</u>   | <u>Description</u>  |
|--|---|
| <ol style="list-style-type: none"> <li>1. Press the LCR COS flexible button (Page B, Button #8).</li> <li>2. Enter a one-digit number between 0 and 6 to correspond to the LCR Class of Service desired.</li> <li>3. Press the HOLD button to save the entry. Confirmation tone is heard and the display will now update.</li> </ol> | <p><b><i>This feature is available with optional software.</i></b></p> <p><b>LCR COS.</b> Stations can be given a class of service assignment for Least Cost Routing. The range is between 0 and 6 with 0 being unrestricted and 6 being the most restricted. A station will be allowed use of LCR routes with a priority number equal to or higher than the stations LCR COS assignment.</p> <p><b>Default:</b> By default, all stations are given unrestricted access (0).</p> <p><b>Related Programming:</b> Refer to Sec. 865.2, LCR Tables Programming .</p> |

```

XXX-XXX B IDO COS1 1 SPO
AAAA BBBB CCC DDDDDDD LO

```

PAGE "B" STATION ATTRIBUTES (Cont'd)

I. Off-Hook Preference Programming

Programming Steps

Description

To program a station for Off-Hook Preference;

1. Press the OFF-HOOK PREF flexible button (Page B, Button #9). The following message is shown on the display phone:

**PRIME FLEX BUTTON  
00 YES**

2. Enter the two-digit button number (01-48) or (00) to indicate no specific button is preferred. SLT's use 01 to enable or 00 to disable.
3. Then, enter either 0 or 1 where:
  - [0] = Disable user programmable preference so that users may not change the off-hook preference as set in programming. Also use for SLT stations.
  - [1] = Enable user programmable preference to key station users so that they may change the off-hook preference through a user dial code.
4. Press the HOLD button to save the entry. Confirmation tone is heard and the display will now update.

**OFF HOOK PREF.** This allows a key station user to automatically have a flex button selected when going off-hook or when pressing the ON/OFF button. SLT user may have a particular CO line or a CO line group selected automatically when going off-hook.

This may be established in programming so that key station users may select and/or change their off-hook preference through the use of a dial code. This user programmable preference may be allowed or denied in programming.

When establishing an off-hook preference for SLT stations, it is necessary to program the **SLTs** CO line, or line group, to be accessed when going off-hook, first using a flex button programming procedure.

**Default:** By default, all digital terminals are allowed to change their preference but no button is assigned (00). SLT stations are not allowed this feature.

**Related Programming:** Refer to Sec. 630.1, Station Attributes Programming, Flexible Button Programming later in this section.

**STATION ATTRIBUTES PROGRAMMING****PAGE "B" STATION ATTRIBUTES (Cont'd)****J. Flexible Button Programming**Programming StepsDescription

1. Press the **BUTTON ASSIGN** flexible button (Page B, Button #10). The following message is shown on the display phone:

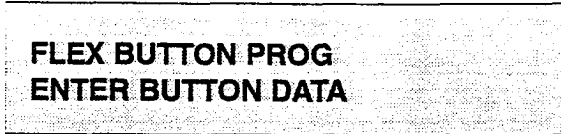

**FLEX BUTTON PROG**  
**ENTER BUTTON DATA**

2. Enter the two-digit button number [BB] to be programmed followed by the desired button function as follows:  
where: **BB**= Button number (01-28)

**MULTI:** To assign a button as a multi-function button (user programmable) enter:

BB [0] HOLD

**CO LINE:** To assign a button as a CO Line button, enter:

BB [1] LL HOLD (LL= CO Line 01-48)

**LOOP:** To assign a button as a Loop button, enter:

BB [2] HOLD

**POOL:** To assign a button as a pooled group button, enter:

BB [3] G HOLD (G= Line Group # 1-7)

**BUTTON ASSIGN.** Each **34-button** Digital terminal has 28-flexible buttons which can be individually programmed. Each **14-button** Digital terminal has 8-flexible buttons which can be individually programmed. One of the following five operations can be selected in programming for each button.

**MULTI.** When a button is assigned as a multi-function button [0], the user then has the ability to program any features or functions on the buttons that the user has access to. For a complete list of user programmable code (functions and features), refer to Table 630-2 Flexible Button Display Designations.

**CO.** Buttons assigned as specific CO lines will provide direct access and appearance of the CO line at the station. The station will receive all call status indications such as LED flash rates for incoming ringing, when the line has been placed on HOLD, etc... CO Line ringing is programmed in CO line Attribute Programming.

**LOOP.** Used for a station without a direct CO Line appearance to answer the line ringing in or transferred to the station. It is recommended that all stations be given a loop button so they can receive a transferred call on a line for which they have no button access.

**POOL.** Some or all outside CO Lines may be grouped together and accessed via a POOL button for the purpose of placing an outgoing CO call. Pressing this button accesses the highest numbered unused CO line in that CO Line group. When programming a button as a pooled group button, refer to CO Line group programming. Pooled group numbers match CO Line group numbers.

PAGE "B" STATION ATTRIBUTES (Cont'd)

Flexible Button Programming (Cont'd)

<u>Programming Steps</u>	<u>Description</u>
<p><b>UNASSIGN:</b> To unassign a button, enter: BB [#] HOLD</p> <p>If SLT stations are to be programmed for Off-Hook Preference, it is necessary to program the desired CO line, or CO line group, the SLT is to access when going off-hook.</p> <p>To assign a CO Line for a SLT with Off-Hook Preference, enter: 00 [1] LL HOLD (LL= CO Line 01-48)</p> <p>To assign a CO line group for an SLT with Off-Hook Preference, enter: 00 [3] G HOLD (G= Line Group # 1-7)</p>	<p><b>UNASSIGN (locked out).</b> Specific buttons may be designated as unused or locked out. When a button is programmed as unused, the button may not be programmed by the station user using flex button programming procedures.</p> <p><b>Default:</b> By default, Station 100 will ring on a line. However, if Station 100 is not given button access to a line, another station must be programmed to ring on that line.</p> <p><b>Related Programming:</b> When programming a button as a CO Line button, refer to Sec. 620.1, CO Line Programming, CO Line Ringing Assignments; and Sec. 630.1, Station Attributes Programming ,Off-Hook Preference Programming.</p>

STATION ATTRIBUTES PROGRAMMING

PAGE "B" STATION ATTRIBUTES (Cont'd)

K. Display Flexible Buttons

Programming Steps

Description

If the flexible buttons are to be viewed:

1. Press the DISPLAY BUTTONS flexible button (Page B, Button #17). The programming assignment on four buttons will be displayed starting with the lowest button number. With each sub-subsequent depression of the DISPLAY BUTTONS button, the next four buttons will be displayed. The following message is shown on the display:

```

BUTTONS XXX-XXX BBWY
BBYYY BBYYY BBYYY
    
```

Where:

- XXX= Station number
- BB= Button Number
- YYY= Button function (see table below)

**DISPLAY BUTTONS.** Any time a display of button programming (default or changed) is needed, press the DISPLAY BUTTONS button (button 17) on Page B and it will display four buttons' programming assignments (starting with the lowest button number). With each subsequent depression of the DISPLAY BUTTONS button, the next four buttons will be displayed.

When a button is assigned as a multi-function button [0], the user then has the ability to program any features or functions on the buttons that the user has access to. When the buttons are programmed with user programmed functions, the display will show the function that has been assigned to the button.

For a complete list of user programmable code (functions and features), refer to Sec. 300.37, Flexible Button Assignment.

**Table 630-2 Flexible Button Display Designations**

<b>M U L</b>	= Multi Function button.	<b>MUS</b>	= BackGround Music button
<b>CO[LL]</b>	= CO Line button (for CO line [LL])	<b>HST</b>	= Headset mode button
<b>LP</b>	= LOOP Button	<b>PPK</b>	= Personal Park button
<b>PL[G]</b>	= POOL Button with CO Line group number	<b>AVL</b>	= ACD or UCD Available/Unavailable button
<b>D[XXX]</b>	= Station DSS/BLF button	<b>OFD</b>	= ACD Overflow Station Avail/Unavailable button
<b>H[HHH]</b>	= Hunt Group with pilot number	<b>CIQ</b>	= ACD or UCD Calls in queue button
<b>P[CCC]</b>	= Call Park with park location	<b>EOR</b>	= Executive Override button
<b>A[AAA]</b>	= ACD Group with pilot numbers	<b>LCR</b>	= LC R Access
<b>U[UUU]</b>	= UCD Group with pilot number	<b>ALO</b>	=Agent Logout
<b>V[VVV]</b>	= VM Group with pilot number	<b>ALI</b>	=Agent Login
<b>M[ZZ]</b>	= Personalized Message with message number	<b>AMD</b>	=Agent Member Display
<b>S[YY]</b>	= Speed Dial button with bin number	<b>HLP</b>	=Agent Help
<b>LNR</b>	= Last Number Redial button	<b>SLO</b>	=Supervisor Logout
<b>SNR</b>	= Save Number Redial button	<b>SLI</b>	=Supervisor Login
<b>IP[N]</b>	= Internal Page with Zone	<b>STS</b>	=Supervisor Status Display
<b>IAC</b>	= Internal All Call Page button	<b>DUA</b>	=Display unanswered calls
<b>EP[N]</b>	= External Page with Zone	<b>DRG</b>	=Distinctive Ringing
<b>E A C</b>	= External All Call button	<b>OHV</b>	=Off_Hook Voice Over
<b>ACP</b>	= All Call Page button	<b>MUT</b>	=MUTE button
<b>M M P</b>	= Meet Me Page button	<b>FLA</b>	=FLASH button
<b>AOR</b>	= Attendant Override button (attn)	<b>REL</b>	=Release button
<b>CPO</b>	= Camp-On button	<b>VOL</b>	=Handset Receiver Gain
<b>LQU</b>	= Line Gueue button		
<b>LQC</b>	= LCR Queue Cancel		
<b>CBK</b>	= Call Back Button		
<b>P K U</b>	= Pick Up button		
<b>M S G</b>	= Message Wait button		
<b>FWD</b>	= Call Forward button		
<b>DND</b>	= Do Not Disturb button		
<b>CNF</b>	= Conference button		
<b>U N A</b>	= Universal Night Answer		
<b>A C C</b>	= Account Code enter button		

<b>Key</b>	
<i>LL</i>	= CO Line number
<i>G</i>	= Pool or CO Line Group number
<i>xxx</i>	= Station Number
<i>HHH</i>	= Hunt Group number
<i>CCC</i>	= Call Park location
<i>AAA</i>	= ACD Group pilot numbers
<i>UUU</i>	= UCD Group pilot number
<i>v v v</i>	= Voice Mail Group number
<i>ZZ</i>	= Personalized Message number
<i>YY</i>	= Speed Dial Bin
<i>N</i>	= Page Zone number

PAGE "B" STATION ATTRIBUTES (Cont'd)

630.3 DIGITAL DATA INTERFACE UNIT (DDIU)

Programming Steps

To program a Digital Data interface (DDIU) unit:

- a. Press FLASH and dial [51]. The following message is shown on the display phone:

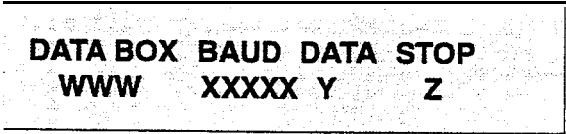

Where:

- WWW = Station Number (100-1 95)
  - XXXXX= Baud Rate
  - Y= Data Parity
  - Z= Data Stop Bits
- b. Enter the three-digit station number of the DDIU unit.
  - c. Press the HOLD button to save the entry. The display will now update.

Description

The Data Feature offers the ability to transmit data information between personal computers, printers, plotters, modems, CRT terminals, and main frame computer ports. To establish a data call, a Digital Data Interface Unit (DDIU) is required to be connected to each data communications device. The DDIU allows any serial data communications device (which conforms to RS-232C) to be connected to the Starplus Digital system.

The buttons on the digital terminal are defined as shown below when entering the Digital Data Interface Unit (DDIU) programming area:

1	Q	BAUD RATE		11	A
2	w	CHARACTER LENGTH		12	S
3	E	STOP BITS		13	D
4	R			14	F
				15	G
5	Y			16	H
7	U			17	J
8	I			18	K
9	O			19	L
10	P		NEW DDIU UNIT	20	:

A. Baud Rate Options

Programming Steps

1. Press the BAUD RATE flexible button (Button #1).
2. Enter a one-digit number for the desired baud rate:
  - [1] = 300 Baud
  - [2] = 1200 Baud
  - [3] = 2400 Baud
  - [4] = 4800 Baud
  - [5] = 9600 Baud
  - [6] = 19.2K Baud
  - [7] = 38.4K Baud
3. Press the HOLD button to save the entry. Confirmation tone is heard and the display will now update.

Description

**BAUD RATE:** Data information can be switched through the system at speeds of 300, 1200, 2400, 4800, 9600, 19.2K and 38.4K baud asynchronous.

**Default:** By default, the DDIU Baud Rate is 9600 Baud.

**Related Programming:** Refer to Sec. 630.2, Page "B" Programming, Station identification for associating a DDIU to a station.

## Digital Data Interface Unit (DDIU) (Cont'd)

## B. Character Length Option

Programming Steps

1. Press the CHARACTER LENGTH flexible button (Button #2).
2. Enter a one-digit number for the character length of the digit string.
  - [8] = 8 character length
  - [9] = 9 character length
3. Press the HOLD button to save the entry. Confirmation tone is heard and the display will now update.

Description

**CHARACTER LENGTH:** Eight bit characters are typically used; without the need for parity. The important point is that the character length settings match those of the attached computer or terminal. If the computer is set up for 8-bit data characters with parity, set the printer the same way. Otherwise, the data may be garbled due to incompatible formats. Default: By default, **8-character** length is selected.

## C. Stop Bit(s) Option

Programming Steps

1. Press the STOP BITS flexible button (Button #3).
2. Enter a one-digit number for the number of stop bits desired.
  - [1] = 1 Stop Bit
  - [2] = 2 Stop Bits
3. Press the HOLD button to save the entry. Confirmation tone is heard and the display will now update.

Description

**STOP BIT(S):** The stop bit indicates that all the data bits have been sent and the transmission of the character is complete.

**Default:** By default, 1 stop bit is selected.

PAGE "B" STATION ATTRIBUTES (Cont'd)

630.4 FLEXIBLE PORT ASSIGNMENT FEATURE

Programming Steps

If the Station numbers need to be relocated to different ports:

- a. Press FLASH and dial [52]. The following message is shown on the display phone:

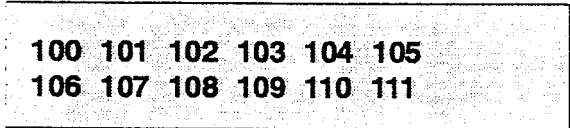

- b. The buttons 1 through 8 indicate cards 1 through 8. When the relocation program is initially entered, Button #1 will be lit indicating that the user is programming the Station numbers on the first card (Station Ports 1 through 12). The LCD will display the Station numbers presently assigned to the first eight ports.

To change the Station number assigned to any port:

- a. Dial the position number on the display (01 through 12), followed by the Station number desired. For example: if 01105 were dialed, the station number of the first entry on the display would be changed to 105. In addition, since 105 was shown as the sixth entry on the display, that entry would be blank (###).

To select another card in the system:

- a. Press the button associated with that card. For example, if Button #3 were pressed (Station ports 25 through 36), the station numbers assigned to the third card would be displayed. Station numbers on the third card are changed in the same manner by entering the position number (01 through 12), followed by the station number desired.

**NOTE** When all the station numbers desired have been programmed, the system will have to be reset to update the data. This is done so that the programming of stations can be done while the system is in use.

Description

The Flexible Port Assignment feature will provide a means to assign Station numbers to any Station port in the system. This provides complete flexibility in determining station numbers within the system as long as they stay within the system numbering plan. A Station can be assigned any number between 100 and 195 on the Starplus SPD 4896 system. This restriction is required to minimize memory requirements on the smaller systems.

The buttons on the key telephone are defined as shown below when entering the Flexible Port Assignment feature programming area:

1	Q	CARD #1		11	A
2	W	CARD #2		12	S
3	E	CARD #3		13	D
4	R	CARD #4		14	F
5	T	CARD #5		15	G
6	Y	CARD #6		16	H
7	U	CARD #7		17	J
8	I	CARD #8		18	K
9	O			19	L
10	P			20	:

All Station numbers entered are stored in a temporary database area which is uploaded to the main database when the system is reset.

CARD #	STATION #	PORT #
1	100-111	1-12
2	112-123	13-24
3	124-135	25-36
4	136-147	37-48
5	148-159	49-60
6	160-171	61-72
7	172-183	73-84
8	184-195	85-96

**NOTE** If a Key Telephone Board (KT12) or Single Line Board (SL 12) is not in card slot #1, and Button #1 is pressed, pound (#'s) will appear in the display instead of Station numbers.

**CAUTION**

If Station 100 is moved or removed, make certain that a physical port is assigned to that station.



## TABLE OF CONTENTS FOR SECTION 640

<b>SECTION 640</b>	<b>ICLID PROGRAMMING .....</b>	<b>640-1</b>
640.1	INTRODUCTION .....	640-1
	A. Calling Number/Name Display.. .....	640-1
	6. Incoming Number/Name for SMDR .....	640-1
	C. Unanswered Call Management .....	640-1
640.2	ICLID RINGING ASSIGNMENT.. .....	640-2
640.3	ICLID FEATURES .....	640-4
	A. Enable/Disable.. .....	640-4
	B. Name in Display.. .....	640-4
	C. Baud Rate Display.. .....	640-5
	D. Port Assignment .....	640-5

## SECTION 640

### ICLID PROGRAMMING

#### 640.1 INTRODUCTION

***This feature is available with optional software.***

The ICLID (Incoming Calling Line IDentification) feature has been added to the Starplus Digital Key Telephone System. However, these features are not available unless the Basic ICLID Software package has been purchased separately. The operation of this feature is dependent on the feature first being activated from the central office so that the numbers or name, if available, of the calling party will be delivered over the individual tip and ring of the CO lines during the first silent interval between ringing. The features implemented are:

##### A. Calling Number/Name Display

This feature is intended as the basic offering of the ICLID service when associated with the Starplus Digital Key Telephone system. Essentially, whenever an incoming call is received at the system, the number received along with the ringing signal will be stored in the line control tables and used at various points in the processing of the call.

The primary function will be that the calling number is displayed (if available) at any point at which the "LINE RINGING" message is displayed in the system.

In addition, with the availability of the *calling name* feature, if the calling name is provided, the system will deliver that to the display instead of the calling number.

Note that although the Central Office delivery of the calling name is 15 characters, the internal table used to store the name for translation of a received number is 24-characters in length. If the Central Office delivers a name, it will be positioned left justified in the 24-character field on the display. If a number is received which matches a number/name translation, the translated name will be used and the name delivered from the Central Office will be effectively discarded.

If no name is available, either supplied from the Central Office or internally from the translation table, the delivered number will be positioned centered in the display as shown above for the 14 N's.

##### B. Incoming Number/Name for SMDR

When this feature is implemented, the system will operate normally in the absence of ICLID

information or the failure of the ICLID equipment. If the information is present at the time that an SMDR record is generated for a call, it will alter the content and format of the SMDR output record.

- If the calling number is available, the number will be output in the SMDR record in the same location as the dialed number is located in the outgoing call record.
- If the calling name is present, an additional line will be output in the SMDR identifying the name. This record will immediately follow the normal SMDR record. The normal SMDR record will include an indicator which identifies that a following record with name identification is present.

Unanswered calls will be recorded in the SMDR record for incoming calls with a "U" indicator to allow the identification of callers for statistical and call-back purposes.

##### C. Unanswered Call Management

An Unanswered Call Management Table with 100 entry capacity for the Starplus SPD 4896 system is maintained in the system. The calling number/name information pertaining to any unanswered call will be placed in this table at the time the system has determined that the call has been abandoned.

This table may be interrogated from any station user so that the unanswered calls may be reviewed and handled by the customer. Only the 1st Attendant station can delete an entry from this table, one entry at a time. Upon entering into the review process, the functions available to a phone are:

Function	Function Button
1. Go to beginning of table.	Dial Code 635
2. Review next item in this table entry	MUTE
3. Step to next table entry.	HOLD
4. Delete this table entry.	FLASH <sup>1</sup>
6. Exit table review function.	ON/OFF
7. Step to previous table entry.	TRANS
8. Call Back.	SPEED

<sup>1</sup> Only the 1 st Attendant station can delete an entry from this table.

ICLID PROGRAMMING

ICLID PROGRAMMING (Cont'd)

640.2 ICLID RINGING ASSIGNMENT

Programming Steps

If the system is in the programming mode, continue using the program codes. If starting to program here, enter the programming mode. Refer to 600.2, Program Mode Entry (Key Station).

If ICLID Ringing Assignments need to be assigned or changed:

1. Press FLASH and dial [43]. The following message is shown on the display phone:

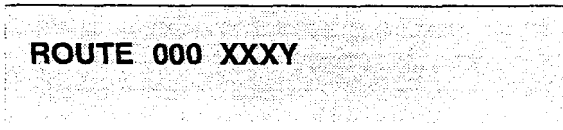

Where:

- 000= ICLID Route Number 000-I 99
  - XXX= ICLID Ringing Destination
  - Y= Ringing Type
2. Press the RING ASSIGNMENT flexible button (Button #1). LED #1 is lit indicating Route 000 is ready for programming.
  3. Enter the three-digit destination (XXX) and the one-digit ring type (Y) followed by the HOLD button. Confirmation tone is heard and the display will now update.
  4. Press Button #17 to display ring assignments. Assignments will be displayed in sets of 8 up to the number programmed. Press Button #1 7 additional times to cycle to the next group of 8 ring assignments.

The following format is used to display the assignments:

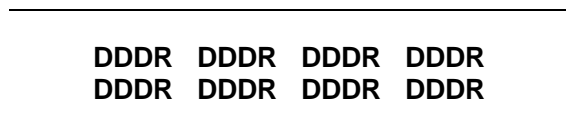

Where:

- DDD= Destination
- R= D for Day  
N = Night  
B = Both Day & Night.

Deleting a station (entering a 0 for ring type) only removes that station from the ring assignment.

Multiple station assignments are accomplished by assigning another destination with ring status, DDDR, and pressing the HOLD button. This can be done for up to the maximum number of stations on the system.

Description

***This feature is available with optional software.***

ICLID Ringing Assignments will provide a means to change the ring assignment based on the incoming number received. This feature permits the user to select one of 200 ringing routes for each entry in the name to number translation table. For example, this feature could be used to re-route selected customers to a specific ACD or UCD group and bypass the general attendant.

The buttons on the digital terminal are defined as shown below when entering the ICLID Ringing Assignment programming area:

1	Q	RINGING ASSIGNMENTS	11	A
2	W		12	S
3	E		13	D
4	R		14	F
5	T		15	G
6	Y		16	H
7	U	DISPLAY RINGING ASSIGNMENTS	17	J
8	I	NEXT ROUTE NUMBER	18	K
9	O	PREVIOUS ROUTE NUMBER	19	L
10	P	SELECT ROUTE NUMBER	20	;

Valid three-digit destinations are:

- 020-099 = System Speed Bins 20-99, for off-net ringing.
- 100-I 95 = Station extension Numbers
- 440-447 = Voice Mail Groups 1-8
- 450-457 = Hunt Groups 1-8
- 499 = Direct Ringing to Modem
- 550-565 = ACD Groups 1-16
- 550-557 = UCD Groups 1-8

Valid Ring types are:

- 0 = unassigned (to delete a station)
- 1 = Day Ringing
- 2 = Night Ringing
- 3 = Day & Night Ringing

Keysets designated to ring on an incoming CO line but not designated to ring on the ICLID ring, may receive a ring cycle before the call is moved. The same ringing restrictions applied to CO line ringing will be applied to ICLID ringing.

**Default:** By default, no destinations or ringing assignments exist.

**ICLID PROGRAMMING (Cont'd)**

**ICLID Ringing Assignment(s) (Cont'd)**

<u>Programming Steps</u>	<u>Description</u>
Ring assignments will be continuous and will be displayed in order of the destination number from 001 to 557.	
5. Repeat Step 3 to program additional stations and ringing assignments. A maximum of eight stations will display on the LCD display. Additional stations and ringing assignments can be displayed using Button #17.	
To advance to the next Route:	
1. Press the NEXT flexible button (Button #18) to advance to the next ICLID Route number,	
To go to a previous Route:	
1. Press the PREVIOUS flexible button (Button #19) to go to the previous ICLID Route number.	
To select a different Route:	
1. Press the SELECT ROUTE NUMBER to select the desired route number.	
2. Enter the three-digit ICLID route number. – 000-199 for SPD 4896 System.	
3. Press the HOLD button to change to the different route entered. Confirmation tone will be heard.	

## ICLID PROGRAMMING

## ICLID PROGRAMMING (Cont'd)

## 640.3 ICLID FEATURES

Programming Steps

If ICLID is to be used:

1. Press FLASH and dial [56]. The following message is shown on the display phone:

ICLID	NAME	BAUD	PORT
NO	YES	2400	1

2. To program ICLID features, use the flexible button(s) as defined in the following procedures. The ICLID, NAME buttons toggle on and off.
3. After all entries are made, press the HOLD button to accept the data.

Description

***This feature is available with optional software.***

The Starplus Digital Key Telephone Systems can receive ICLID input on the standard RS-232C connector (future) on the Central Processor Unit (CPU) or to the optional RS-232C Backplane Expander connector(s). When ICLID is desired, the following system-wide parameters will determine how the ICLID information will be distributed.

The buttons on the digital terminal are defined as shown below when entering the ICLID Features programming area:

Q 1	ICLID		11 A
W 2	FORMAT		12 S
E 3	BAUD RATE		13 D
R 4	PORT		14 F

**Related Programming:** Refer to Sec. 610.15, Local Number/Name Translation Table.

## A. Enable/Disable

Programming Steps

1. Press the ICLID ENABLE flexible button (Button #1). This feature will toggle on and off with each depression, and the display will update with each depression.
  - LED ON = ICLID is enabled
  - LED OFF = ICLID is disabled
2. Press the HOLD button to save the entry. Confirmation tone is heard.

Description

The ICLID (Incoming Calling Line IDentification) feature has been added to the Starplus Digital Key Telephone Systems. However, these features are not available unless the Basic ICLID Software package has been purchased separately. In order for this feature to operate properly, it must be activated from the central office so that the numbers of the calling party will be delivered over the individual tip and ring of the CO lines during the first silent interval between ringing.

**Default:** By default, ICLID is disabled.

## B. Name in Display

Programming Steps

1. Press the NAME flexible button (Button #2) to determine whether the name will appear in the LCD display instead of the incoming telephone number. This feature will toggle on and off with each depression and the display will update with each depression.
  - LED ON = Name will appear in display
  - LED OFF = Telephone number will appear in display
2. Press the HOLD button to save the entry. Confirmation tone is heard.

Description

The system can be set to display either the incoming telephone number or the person's name on the LCD display.

**Default:** By default, the system will show the telephone number on the LCD display.

ICLID PROGRAMMING (Cont'd)

ICLID Features (Cont'd)

<u>Programming Steps</u>	<u>Description</u>
<p>C. <b>Baud Rate Display</b> The ICLID Baud Rate is programmed using Flash 15 Baud Rate Assignments. Button X3 will return error tone when pressed. The LCD displays the current baud rate based on which Port number is assigned to the ICLID Port number.</p>	<p>The <b>Starplus</b> Digital Key Telephone Systems can receive ICLID input on the standard RS-232C "On-Board" connector (future) on the Central processor Unit (CPU) or to the optional RS-232C Backplane Expander Module connector(s). The Baud Rate will be displayed as either 300 baud, 1200 baud, 2400 baud, 4800 baud, or 9600 <b>baud</b>.</p> <p><b>Related Programming:</b> Refer to Sec. 610.8, Baud Rate Assignments.</p>

D. **Port Assignment**

<u>Programming Steps</u>	<u>Description</u>
<p>1. Press the PORT flexible button (Button #4) to determine which port is to be used for ICLID information.</p> <p>2. Enter a one-digit number for the ICLID Port number:</p> <ul style="list-style-type: none"><li>- [1] = Port #1 (CPU "On-Board" RS-232C)(Future use)</li><li>- [2] = Port #2 ("On-Board" 1200 Baud Modem)</li><li>- [3] = Port #3 (Back Plane RS-232C)</li><li>- [4] = Port #4 (Back Plane RS-232C)</li></ul> <p>The LCD displays the current baud rate based on which Port number is assigned to the ICLID Port number.</p>	<p><b>Port #1</b> refers to the standard RS-232C "On-Board" connector on the Central Processor Unit (CPU). (Future use)</p> <p>Port <b>#2</b> refers to the "On-Board" 1200 Baud modem provided with the system.</p> <p>Port <b>#3</b> refers to the RS-232C connector on the Backplane I/O Expander Module.</p> <p>Port <b>#4</b> refers to the RS-232C connector on the same Backplane I/O Expander Module.</p> <p><b>Default:</b> By default, Port #1 is used for ICLID operation.</p>
<p>3. Press the HOLD button to accept the data. The display will now update.</p>	

## TABLE OF CONTENTS FOR SECTION 645

<b>SECTION 645</b>	<b>AUTOMATIC CALL DISTRIBUTION (ACD)</b> .....	645-1
645.1	ACD GROUP PROGRAMMING.. .....	645-1
	A. Alternate ACD Group Assignment.. .....	645-2
	B. ACD Overflow Station Assignment.. .....	645-2
	C. ACD Recorded Announcement Assignment(s) (RAN) .....	645-3
	D. ACD Supervisor Programming .....	645-4
	E. ACD Station Assignment(s) .....	645-5
645.2	ACD TIMERS .....	645-6
	A. ACD Ring Timer.. .....	645-6
	B. ACD Message interval Timer.. .....	645-7
	C. ACD Overflow Timer.. .....	645-7
	D. ACD Auto Wrap-Up Timer.. .....	645-8
	E. ACD No-Answer Recall Timer .....	645-8
	F. ACD No-Answer Retry Timer.. .....	645-9
	G. Guaranteed Message Timer.. .....	645-9
645.3	ACD RAN ANNOUNCEMENT TABLES.. .....	645-10
645.4	ACD EVENT TRACE.. .....	645-11
	A. ACD Event Trace Enable/Disable .....	645-11
	B. Trace Port Assignment.. .....	645-12
	C. Baud Rate Display .....	645-12
645.5	ACD GROUP PROGRAMMING.. .....	645-13
	A. Alternate ACD Group Assignment.. .....	645-14
	B. ACD Overflow Station Assignment.. .....	645-14
	C. ACD Recorded Announcement Assignment(s) (RAN) .....	645-15
	D. ACD Supervisor Programming .....	645-16
	E. ACD Station Assignment(s) .....	645-17

## SECTION 645

# AUTOMATIC CALL DISTRIBUTION (ACD)

### 645.1 ACD GROUP PROGRAMMING

#### Programming Steps

If the system is in the programming mode, continue using the program codes. If starting to program here, enter the programming mode. Refer to Sec. 600.2, Program Mode Entry (Key Station).

If ACD Groups are to be assigned:

1. Press FLASH and dial [60]. The following message is shown on the display phone:

**ACD 5XX A ALT OVR AN SUPV  
 AAA BBB CC DDD**

Where:

- 5XX = ACD Group Number (550-557)
  - A = Page A Parameters
  - AAA = Alternate ACD Group Assignment
  - BBB = ACD Overflow Assignment
  - CCC = ACD Announcement Tables
  - DDD = ACD Supervisor Programming
2. The top left button in the flexible button field will be lit for programming ACD group 1 (550). To change ACD groups or enter further ACD groups (550 to 557), press the appropriate flexible button and perform the following procedures.

#### Description

***This feature is available with optional software.***

There can be 16 ACD groups of no more than 16 stations each. The ACD groups use a pilot hunting technique. If the pilot number is dialed, the assigned stations in that ACD group are searched for the station which has been in an idle condition for the longest period of time.

Each ACD Group may have an assigned Alternate ACD Group, an Overflow station and up to 16 stations as ACD members. The eight system RAN ports (tables) may also be referenced on a per ACD group basis.

The buttons on the digital terminal are defined as shown below when entering the ACD Group(s) programming area:

1	Q	ACD GROUP 550	ANNOUNCEMENT TABLS	11	A
2	W	Alt GROUP 551		12	S
7	E	ACD GROUP 552		13	D
4	R	ACD GROUP 553		14	F
5	T	ACD GROUP 554		15	G
6	Y	ACD GROUP 555		16	H
7	U	ACD GROUP 556		17	J
8	I	ACD GROUP 557	SELECT PAGE A	18	K
9	O	ALTERNATE ACD GROUP	SELECT PAGE B	19	L
10	P	OVERFLOW ASSIGNMENTS		20	:

**Default:** By default, ACD Group Tables are empty.

**Related Programming:** Refer to Sec. 645.2, ACD Timers for setting the ACD Ring Timer, ACD Message Interval Timer, ACD Overflow Timer, ACD No-Answer Recall Timer, ACD No-Answer Retry Timer, and Guaranteed Message Timer: Also refer to Sec. 645.3, ACD RAN Announcement Tables for assigning RAN device ports and message times.



**AUTOMATE CALL DISTRIBUTION (ACD)****AUTOMATIC CALL DISTRIBUTION (Cont'd)****A. Alternate ACD Group Assignment**Programming Steps

To program an alternate group:

1. Press the ALTERNATE ACD GROUP flexible button (Button #9).
2. Enter the three-digit pilot number (550 to 557) of the desired alternate ACD group.
3. Press the HOLD button to save the entry. Confirmation tone is heard and the display will now update.

```

ACD 5XX A ALT OVR AN SUPV
      AAA BBB CC DDD
  
```

Description

**ALTERNATE ACD GROUP.** An alternate ACD group can be programmed so that if no station in one group is available, the alternate group will be checked for an available station. This provides a means to chain or link ACD groups together.

To delete an Alternate ACD Group, press the pound key three times [###] and press the HOLD button.

**B. ACD Overflow Station Assignment**Programming Steps

To program ACD Overflow station:

1. Press the OVERFLOW ASSIGN flexible button (Button #10).
2. Enter the three-digit station number (100 to 195) to designate the ACD Groups overflow station.
3. Press the HOLD button to save the entry. Confirmation tone is heard and the display will now update.

```

ACD 5XX A ALT OVR AN SUPV
      AAA BBB CC DDD
  
```

Description

**ACD OVERFLOW ASSIGN.** When an overflow station is assigned, callers that have remained in queue for a specified amount of time will be routed to the assigned overflow station. The overflow station may not be one of the ACD group stations. Only CO calls transferred to a ACD group will overflow to the overflow station when RAN tables have not been assigned.

To delete an Overflow Station, press the pound key three times [###] and press the HOLD button.

**AUTOMATIC CALL DISTRIBUTION (Cont'd)**

**C. ACD Recorded Announcement  
Assignment(s) (RAN)**

Programming Steps

Description

To program a Recorded Announcement:

1. Press the ANNOUNCEMENT TBLS flexible button (Button #11).
2. Enter a three-digit sequence:
  - 1st Digit = Guaranteed Message.
  - 2nd Digit = RAN port specified for primary message.
  - 3rd Digit = RAN port specified for secondary message.
3. Press the pound [#] key once as the 1st digit if no Guaranteed Message is desired.

Example:

- an entry of #,2,3 = No Guaranteed Message will be heard. Port 2 will provide a primary message and Port 3 will provide a secondary message.
  - an entry of 1,2,3 = Port 1 will provide the Guaranteed Message upon initial answering of the call, Port 2 will provide a primary message and Port 3 will provide a secondary message.
  - an entry of 8,1,2 = Port 8 will provide the Guaranteed Message upon initial answering of the call, Port 1 will provide a primary message and Port 2 will provide a secondary message.
4. Press the HOLD button to save the entry. Confirmation tone is heard and the display will now update.

To erase Recorded Announcement(s), press the pound key three times [###] and press HOLD.

**ACD ANNOUNCEMENT TABLES.** Optional Recorded Announcement device(s) may be connected to the system to provide an announcement if all stations in a ACD group are busy. Up to eight ports in the system may be assigned to provide a path to Recorded Announcement devices.

Incoming CO Callers **will** only be answered and routed to the Overflow assignment if a RAN Table is assigned.

The Guaranteed Message announcement provides a means to force incoming callers to an announcement before being placed into an ACD Queue or routed to an agent. The outside callers are presented with a message before being routed to the ACD Group. Agents in an ACD Group with a Guaranteed Message enabled will receive incoming callers only after the caller has heard the designated recorded announcement in its entirety, or **after** the incoming caller has dialed up to 14 digits followed by a pound (#). These digits will be inserted as ICLID incoming number identification.

If the Guaranteed Message announcement is programmed in Admin, incoming ACD calls will be routed to the Guaranteed Message RAN before going to the ACD Group.

**Related Programming:** Refer to Sec. 645.3, ACD RAN Announcement Tables programming for further information regarding each RAN Table. Also refer to Sec. 610.15, Local Number/Name Translation Table.

<b>ACD 5XX A ALT OVR AN SUPV</b>
<b>AAA BBB CC DDD</b>

**AUTOMATIC CALL DISTRIBUTION (ACD)****AUTOMATIC CALL DISTRIBUTION (Cont'd)****D. ACD Supervisor Programming**Programming StepsDescription

To program an ACD Supervisor:

1. Press the ACD SUPV flexible button (Button #12).
2. Enter the three-digit station number of the desired ACD Supervisor station.
3. Press the HOLD button to save the entry. Confirmation tone is heard and the display will now update.

<p><b>ACD 5XX A ALT OVR AN SUPV</b>  <b>AAA BBB CC DDD</b></p>
--

**ACD SUPERVISOR.** The ACD Supervisor Station assignment feature provides a means to assign each ACD group a supervisor. This Supervisor Station can receive the calls in queue display in real time, receives No Answer/Out of Service conditions, "HELP" displays from the groups that the supervisor is assigned to and can barge-in on active calls in his ACD Group or groups.

A supervisor can be assigned in **ADMIN** to a group or groups to receive the help request and out of service (**OOS**) messages. If a supervisor station is assigned in **ADMIN**, it is considered logged in. In addition, a supervisor can dial a supervisor login code followed by the ACD group that the supervisor is logging into and his four-digit ID number.

**AUTOMATIC CALL DISTRIBUTION (Cont'd)**

**E. ACD Station Assignment(s)**

Programming Steps

To program stations into a ACD group:

1. Press the Page "B" flexible button (Button #19). The following message is shown on the display phone.

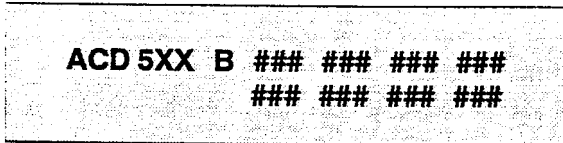

Where:

- 5XX = ACD Group Number (550-557)
  - B = Page "B" parameters
  - ### = ACD Station assignments
2. The top left button in the flexible button field will be lit for programming ACD group 1 (550).  
  
To change ACD groups or enter further ACD groups (550 to 557), press the appropriate flexible button and perform the following procedures.
  3. Enter the three-digit station numbers of the stations in the ACD group in the order in which they will be checked. The order is only relevant for the first call. After that, the rule is oldest idle. A maximum of 16 stations may be entered.
  4. Press the HOLD button to save the entry. Confirmation tone is heard and the display will now update.

If ACD Station assignments in the 2nd Group of eight (Stations 9 thru 16) are to be viewed:

1. Press the DISPLAY STATIONS flexible button (Page B, Button #17). The 2nd group of station assignments will be displayed. If no additional stations are assigned, beyond the 1st eight stations, the display will show pound signs (#) instead of station assignments. Press the Page "B" flexible button (Button #19) again to return and view the 1st group of eight stations in the same ACD group.

Description

**ACD STATION ASSIGNMENTS.** Any type of station (excluding DSS/DLS Consoles) may be entered as valid ACD stations. Calls will be routed to station in the order they are entered for the first round of calls only. After that the calls are routed to stations based on On-Hook time. The station with the longest On-Hook time will receive the next call.

If a specific station number is dialed, only that station is rung; no distribution will be done if that station is busy.

The buttons on the digital terminal are defined as shown below when entering the ACD Station Assignments programming area:

1	Q	ACD GROUP 550		11	A
2	W	ACD GROUP 551		12	S
3	E	ACD GROUP 552		13	D
4	R	ACD GROUP 553		14	F
5	T	ACD GROUP 554		15	G
6	Y	ACD GROUP 555		16	H
7	U	ACD GROUP 556		17	J
8	I	ACD GROUP 557	SELECT PAGE A	18	K
9	O		SELECT PAGE B	19	L
10	P			20	:

To erase all stations, press the pound key three times [###] and press HOLD.

**NOTE** *If an ACD member is assigned to a specific ACD group and uses the login-logout codes to enter and exit an ACD group other than his own assigned group, the database programming for ACD stations will be automatically changed to reflect the different group.*

**DISPLAY STATIONS.** Any time a display of the 2nd group of ACD Station assignments (default or changed) is needed, press the DISPLAY STATIONS button (Button #17). It will display the 2nd group of station assignments up to eight stations at a time. Button #19 will always show the 1st eight stations programmed in the ACD Group. Button #17 will always display the 2nd group of eight stations programmed in the same ACD group.



**AUTOMATIC CALL DISTRIBUTION (Cont'd)**

**ACD TIMERS (Cont'd)**

**B. ACD Message interval Timer**

Programming Steps

To make a change to the ACD Message Interval Timer:

1. Press the MIT TIMER flexible button (Button #2). The following message is shown on the display phone:

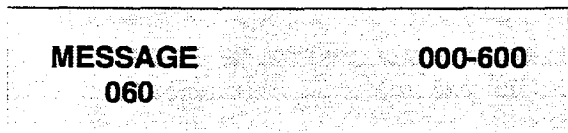

2. Enter the three-digit timer value on the dial pad which corresponds to 000-600 seconds.
3. Press the HOLD button to save the entry. Confirmation tone is heard and the display will now update.

**NOTE** The **ACD Ring and Message Interval Timers** only apply when RAN ports have been specified. If RAN ports are not specified, incoming callers will continue to receive ringbacktone.

Description

**ACD MIT TIMER.** The ACD Message Interval Timer (MIT) determines the length of time a caller remains in queue (listening to MOH, if provided) between recorded announcements.

**Default:** By default, the- ACD Message Interval Timer is set for 60 seconds and is variable from 000 to 600 seconds.

**C. ACD Overflow Timer**

Programming Steps

To make a change to the ACD Overflow Timer:

1. Press the OVERFLOW TIMER flexible button (Button #3). The following message is shown on the display phone:



2. Enter the three-digit value on the dial pad which corresponds to 000-600 seconds.
3. Press the HOLD button to save the entry. Confirmation tone is heard and the display will now update.

Description

**ACD OVERFLOW TIMER.** The ACD Overflow Timer determines the total length of time a caller will remain in queue for a particular ACD group. When the timer expires, the caller will be routed to the designated overflow station. The timer starts when an incoming call is answered and presented to the first recorded announcement. Transferred CO callers will overflow at the expiration of the Overflow Timer.

**Default:** By default, the ACD Overflow Timer is set for 60 seconds and is variable from 000 to 600 seconds.

**AUTOMATIC CALL DISTRIBUTION (ACD)****AUTOMATIC CALL DISTRIBUTION (Cont'd)****ACD TIMERS (Cont'd)****D. ACD Auto Wrap-Up Timer**Programming Steps

To make a change to the ACD Auto Wrap-up Timer:

1. Press the AUTO-WRAP TIMER flexible button (Button #4). The following message is shown on the display phone:

<b>WRAP-UP</b>	<b>000-999</b>
<b>004</b>	

2. Enter the three-digit value on the dial pad which corresponds to 000-999 seconds.
3. Press the HOLD button to save the entry. Confirmation tone is heard and the display will now update.

Description

**ACD AUTO-WRAP TIMER.** After completion of a ACD call (on-hook) the agent will not be subjected to another ACD call for the duration of the Auto Wrap-Up timer allowing the agent to finish call related work or access other facilities. This will allow agents to remove themselves from the group (i.e., DND, Call Forward) or originate another call.

**Default:** By default, the ACD Auto Wrap-up Timer is set for 04 seconds and is variable from 000 to 999 seconds.

**E. ACD No-Answer Recall Timer**Programming Steps

To make a change to the ACD No-Answer Recall Timer:

1. Press the NO-ANSWER RECALL TIMER flexible button (Button #5). The following message is shown on the display phone:

<b>NO-ANS RECALL</b>	<b>000-300</b>
<b>000</b>	

2. Enter the three-digit value on the dial pad which corresponds to 000-300 seconds.
3. Press the HOLD button to save the entry. Confirmation tone is heard and the display will now update.

Description

**ACD NO-ANSWER RECALL TIMER.** If a call routed to a station via ACD is not answered by the ACD Agent/Station before the No-Answer Recall timer expires, the call will be returned to ACD Queue with the highest priority. In addition, the station that failed to answer the ringing ACD call will be placed into an out of service (OOS) state.

**Default:** By default, the ACD No-Answer Timer is at 000 (disabled) and is variable from 000 to 300 seconds.

**AUTOMATIC CALL DISTRIBUTION (Cont'd)**

**ACD TIMERS (Cont'd)**

**F. ACD No-Answer Retry Timer**

Programming Steps

To make a change to the ACD No-Answer Retry Timer:

1. Press the NO-ANSWER RETRY TIMER flexible button (Button #6). The following message is shown on the display phone:

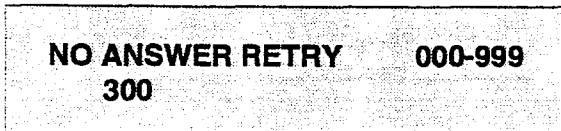

2. Enter the three-digit value on the dial pad which corresponds to 000-999 seconds.
3. Press the HOLD button to save the entry. Confirmation tone is heard and the display will now update.

Description

**ACD NO-ANSWER RETRY TIMER.** When the No-Answer Recall timer expires, a station that failed to answer the ringing ACD call is placed into an out-of-service (OOS) state. The station that was taken out-of-service (OOS) will be placed back in service if the agent hits his available flex button or dials the available flex code. In addition, the agent will be placed back in service if the No-Answer Retry timer expires. If the agent does not answer his next ACD call, he will again be taken out-of-service. This cycle will continue until the station answers calls, logs out, or goes unavailable.

**Default:** By default, the ACD No-Answer Retry Timer is set for 300 seconds and is variable from 000 to 999 seconds.

**G. Guaranteed Message Timer**

Programming Steps

To make a change to the ACD Guaranteed Message Timer:

1. Press the GUARANTEED MESSAGE TIMER flexible button (Button #7). The following message is shown on the display phone.

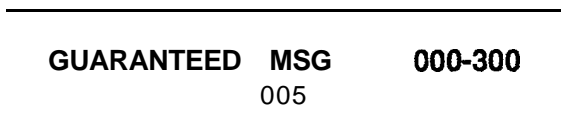

2. Enter the three-digit value on the dial pad which corresponds to 000-300 seconds.
3. Press the HOLD button to save the entry. Confirmation tone is heard and the display will now update.

Description

**GUARANTEED MESSAGE TIMER.** This timer determines how long a call rings before being answered by Guaranteed Message RAN when the Guaranteed Message RAN feature is added to an ACD Group.

**Default:** By default, the Guaranteed Message Timer is set for 5 sec. and is variable from 000 to 300 seconds.



## AUTOMATIC CALL DISTRIBUTION (Cont'd)

## 646.3 ACD RAN ANNOUNCEMENT TABLES

Programming Steps

If Recorded Announcement devices are installed to operate with ACD, these tables must be programmed:

- a. Press FLASH and dial [62]. The following message is shown on the display phone:

**ANNOUNCEMENT TABLE 1**  
**TYPE # INDX ## TIME ###**

- b. The top left button in the flexible button field will be lit for programming ACD RAN Announcement Table 1. To change to ACD RAN Announcement Table 2, press flexible button #2. Repeat above for Tables 3 through 8.

- c. Enter a string of six, or seven digits on the dial pad. The order of data entry will be:

Type Number:

- [1] = CO Port interface
- [2] = SLT Port interface

Index (port) Number:

- [01-48] = CO Line Port
- [100-195] = SLT Station Port

Message Time:

- **000-300** seconds

- d. Press the HOLD button to save the entry. Confirmation tone is heard and the display will now update.

**NOTE**

*When a CO port is designated as a RAN port, a relay and/or sensor should be programmed as a RAN start for Announcement Table 1 through 8.*

To clear entries in a Table:

- a. Press the pound key once [#] followed by the HOLD button.

Description

Determines the type, index (port) number and message length for the eight available Recorded Announcements (RAN). There are eight RAN tables that can be programmed. Table 1 can be the answer port for unanswered incoming calls to a ACD group. Table 8 can provide the secondary message or vice versa.

The buttons on the digital terminal are defined as shown below when entering the ACD RAN Announcement Tables programming area:

1	Q	ANNOUNCEMENT TABLE #1		11	A	I
2	W	ANNOUNCEMENT TABLE #2		12	S	*
3	E	ANNOUNCEMENT TABLE #3		13	D	
4	R	ANNOUNCEMENT TABLE #4		14	F	
5	T	ANNOUNCEMENT TABLE #5		15	G	
6	Y	ANNOUNCEMENT TABLE #6		16	H	
7	U	ANNOUNCEMENT TABLE #7		17	J	
8	I	ANNOUNCEMENT TABLE #8		18	K	

The type can be either a CO line port, or a SLT port. The index number specifies which circuit for the type of interface.

The message length is used to match the maximum length of the message to the device that is used.

Example:

To program a table for CO line port:

- a. Press the TABLE X flexible button (Buttons I-8).
- b. Dial [1] for CO port interface.
- c. Dial [01 to 48] for CO line used.
- d. Enter message duration (000-300 sec.)

Example:

To program a table for an SLT port:

- a. Press the TABLE X flexible button (Buttons I-8).
- b. Dial [2] for SLT port interface.
- c. Dial [100 to 195] for SLT station used.
- d. Enter Message duration (000-300 sec.)

**Related Programming:** Refer to Sec. 645.1, ACD Group Programming; 645.2, ACD Timers; Also refer to Sec. 500.9, Installing Recorded Announcement Device (RAN).

AUTOMATIC CALL DISTRIBUTION (Cont'd)

646.4 ACD EVENT TRACE

Programming Steps

To enable ACD Event Trace options:

1. Press FLASH and dial [63]. The following message will be shown on the display phone:



Where:

- X= Port for ACD Event Trace
- YYYY= Baud Rate of desired port.

A. ACD Event Trace Enable/Disable

Programming Steps

1. Press the ACD EVENT TRACE flexible button (Button #1). It will toggle on and off with each depression.
  - LED on = Event trace is enabled
  - LED off = Event trace is disabled
2. Press the HOLD button to save the entry. Confirmation tone is heard and the display will now update.

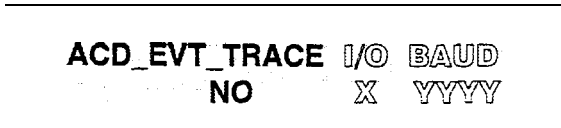

Description

***This feature is available with optional software.***

The ACD Event Trace feature provides an event trace output which interfaces with a customer-developed ACD Reporting package

The buttons on the digital terminal are defined as shown below when entering the ACD Event Trace feature programming area:

1	Q	ACD EVENT TRACE	11	A
2	W	ACD PRINT PORT	12	S

Description

The ACD Event Trace provides a series of events trace output which interfaces with a customer-developed ACD Reporting package.

**Default:** By default, the ACD Event Trace is disabled.

AUTOMATIC CALL DISTRIBUTION (ACD)**AUTOMATIC CALL DISTRIBUTION (Cont'd)****ACD EVENT TRACE (Cont'd)****B. Trace Port Assignment**Programming Steps

1. Press the ACD PRINT PORT flexible button (Button #2) to determine which port is to be used for the ACD Event Trace.
2. Enter a one-digit number for the ACD Event Trace Port number:
  - [1] = Port #1 (CPU "On-Board" RS-232C) (Future Use)
  - [2] = Port #2 ("On-Board" Modem)
  - [3] = Port #3 (Backplane RS-232C)
  - [4] = Port #4 (Backplane RS-232C)

The LCD displays the current baud rate based on which Port number is assigned to the ACD SMDR Port number.

3. Press the HOLD button to save the entry. Confirmation tone is heard and the display will now update.

```

ACD_EVT_TRACE I/O BAUD
                NO   X  YYYY
  
```

Description

**Port #1** refers to the standard RS-232C "On-Board" connector on the Central Processor Unit (CPU). (Future use)

**Port #2** refers to the "On-Board" 1200 Baud modem provided with the system.

**Port #3** refers to the RS-232C connector on the Backplane I/O Expander Module.

**Port #4** refers to the RS-232C connector on the same Backplane I/O Expander Module.

**Default:** By default, Port #1 is used for Basic ACD SMDR purposes.

**C. Baud Rate Display**Programming Steps

The ACD Port Baud Rate is programmed using Flash 15 Baud Rate Assignments. The LCD displays the current baud rate based on which Port number is assigned to the ACD SMDR Port number. The following message will be shown on the display phone:

```

ACD_EVT_TRACE I/O BAUD
                NO   X  YYYY
  
```

Description

The Starplus Digital Key Telephone Systems can provide ACD Reporting output to the standard RS-2326 "On-Board" connector (future) on the Central Processor Unit (CPU) or to the optional Backplane I/O Expander Module connector(s). The Baud Rate will be displayed as either 300 baud, 1200 baud, 2400 baud, 4800 baud, or 9600 baud.

**Related Programming:** Refer to Sec. 610.8, Baud Rate Assignments.

AUTOMATIC CALL DISTRIBUTION (Cont'd)

645.5 ACD GROUP PROGRAMMING

Programming Steps

If the system is in the programming mode, continue using the program codes. If starting to program here, enter the programming mode. Refer to Sec. 600.2, Program Mode Entry (Key Station).

If ACD Groups are to be assigned:

1. Press FLASH and dial [64]. The following message is shown on the display phone:

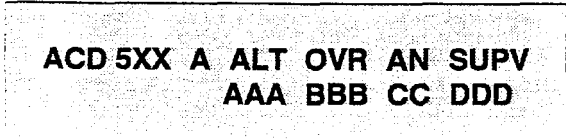

Where:

- 5XX = ACD Group Number (558-565)
  - A = Page A Parameters
  - AAA = Alternate ACD Group Assignment
  - BBB = ACD Overflow Assignment
  - CCC = ACD Announcement Tables
  - DDD = ACD Supervisor Programming
2. The top left button in the flexible button field will be lit for programming ACD group 9 (558). To change ACD groups or enter further ACD groups (558 to 565), press the appropriate flexible button and perform the following procedures.

Description

**This feature is available with optional software.**

There can be 16 ACD groups of no more than 16 stations each. The ACD groups use a pilot hunting technique. If the pilot number is dialed, the assigned stations in that ACD group are searched for the station which has been in an idle condition for the longest period of time.

Each ACD Group may have an assigned Alternate ACD Group, an Overflow station and up to 16 stations as ACD members. The eight system RAN ports (tables) may also be referenced on a per ACD group basis.

The buttons on the digital terminal are defined as shown below when entering the ACD Group(s) programming area:

1	Q	ACD GROUP 558	ANNOUNCEMENT TBLS	11	A
2	W	ACD GROUP 559		12	S
3	E	ACD GROUP 560		13	D
4	R	ACD GROUP 561		14	F
5	T	ACD GROUP 562		15	G
6	Y	ACD GROUP 563		16	H
7	U	ACD GROUP 564		17	J
8	I	ACD GROUP 565	SELECT PAGE A	18	K
9	O	ALTERNATE ACD GROUP	SELECT PAGE B	19	L
10	P	OVERFLOW ASSIGNMENTS		20	:

**Default:** By default, ACD Group Tables are empty.

**Related Programming:** Refer to Sec. 645.2, ACD Timers for setting the ACD Ring Timer, ACD Message Interval Timer, ACD Overflow Timer, ACD No-Answer Recall Timer, ACD No-Answer Retry Timer, and Guaranteed Message Timer; Also refer to Sec. 645.3, ACD RAN Announcement Tables for assigning RAN device ports and message times.

**AUTOMATIC CALL DISTRIBUTION (ACD)****AUTOMATIC CALL DISTRIBUTION (Cont'd)****A. Alternate ACD Group Assignment**Programming Steps

To program an alternate group:

1. Press the ALTERNATE ACD GROUP flexible button (Button #9).
2. Enter the three-digit pilot number (558 to 565) of the desired alternate ACD group.
3. Press the HOLD button to save the entry. Confirmation tone is heard and the display will now update.

```

ACD 5XX A ALT OVR AN SUPV
AAA BBB CC DDD

```

Description

**ALTERNATE ACD GROUP.** An alternate ACD group can be programmed so that if no station in one group is available, the alternate group will be checked for an available station. This provides a means to chain or link ACD groups together.

To delete an Alternate ACD Group, press the pound key three times [###] and press the HOLD button.

**B. ACD Overflow Station Assignment**Programming Steps

To program ACD Overflow station:

1. Press the OVERFLOW ASSIGN flexible button (Button #10).
2. Enter the three-digit station number (100 to 195) to designate the ACD Groups overflow station.
3. Press the HOLD button to save the entry. Confirmation tone is heard and the display will now update.

```

ACD 5XX A ALT OVR AN SUPV
AAA BBB CC DDD

```

Description

**ACD OVERFLOW ASSIGN.** When an overflow station is assigned, callers that have remained in queue for a specified amount of time will be routed to the assigned overflow station. The overflow station may not be one of the ACD group stations. Only CO calls transferred to a ACD group will overflow to the overflow station when RAN tables have not been assigned.

To delete an Overflow Station, press the pound key three times [###] and press the HOLD button,

**AUTOMATIC CALL DISTRIBUTION (Cont'd)**

**C. ACD Recorded Announcement Assignment(s) (RAN)**

- | <u>Programming Steps</u>  | <u>Description</u>   |
|---|--|
| To program a Recorded Announcement:   |  |
| 1. Press the ANNOUNCEMENT TBLS flexible button (Button #11).  | <b>ACD ANNOUNCEMENT TABLES.</b> An optional Recorded Announcement device(s) may be connected to the system to provide an announcement if all stations in a ACD group are busy. Up to eight ports in the system may be assigned to provide a path to Recorded Announcement devices. |
| 2. Enter a three-digit sequence: <ul style="list-style-type: none"> <li>- 1st Digit = Guaranteed Message</li> <li>- 2nd Digit = RAN port specified for primary message.</li> <li>- 3rd Digit = RAN port specified for secondary message.</li> </ul> |  |
| 3. Press the pound [#] key as the 1st digit if no guaranteed message is desired.  |  |

Example:

- an entry of #,2,3 = No Guaranteed Message will be heard. Port 2 will provide a primary message and Port 3 will provide a secondary message.
  - an entry of 1,2,3 = Port 1 will provide the Guaranteed Message upon initial answering of the call, Port 2 will provide a primary message and Port 3 will provide a secondary message.
  - an entry of 8,1,2 = Port 8 will provide the Guaranteed Message upon initial answering of the call, Port 1 will provide a primary message and Port 2 will provide a secondary message.
4. Press the HOLD button to save the entry. Confirmation tone is heard and the display will now update.

To erase Recorded Announcement(s), press the pound key three times [##] and press HOLD.

**ACD 5XX A ALT OVR AN SUPV**  
**AAA BBB CC DDD**

Incoming CO Callers **will** only be answered and routed to the Overflow assignment if a RAN Table is assigned.

The Guaranteed Message announcement provides a means to force incoming callers to an announcement before being placed into an ACD Queue or routed to an agent. The outside callers are presented with a message before being routed to the ACD Group. Agents in an ACD Group with a Guaranteed Message enabled will receive incoming callers only after the caller has heard the designated recorded announcement in its entirety, or after the incoming caller has dialed up to 14 digits followed by a pound (#). These digits will be inserted as ICLID incoming number identification.

If the Guaranteed Message announcement is programmed in Admin, incoming ACD calls will be routed to the Guaranteed Message RAN before going to the ACD Group.

**Related Programming:** Refer to Sec. 645.3, ACD RAN Announcement Tables programming for further information regarding each RAN Table. Also refer to Sec. 610.15, Local Number/Name Translation Table.

**AUTOMATIC CALL DISTRIBUTION (ACD)****AUTOMATIC CALL DISTRIBUTION (Cont'd)****D. ACD Supervisor Programming**Programming Steps

To program an ACD Supervisor:

1. Press the ACD SUPV flexible button (Button #12).
2. Enter the three-digit station number of the desired ACD Supervisor station.
3. Press the HOLD button to save the entry. Confirmation tone is heard and the display will now update.



**ACD 5XX A ALT OVR AN SUPV**  
**AAA BBB CC DDD**

Description

**ACD SUPERVISOR.** The ACD Supervisor Station assignment feature provides a means to assign each ACD group a supervisor. This Supervisor Station can receive the calls in queue display in real time, receives No Answer/Out of Service conditions, "HELP" displays from the groups that the supervisor is assigned to and can barge-in on active calls in his ACD Group or groups.

A supervisor can be assigned in **ADMIN** to a group or groups to receive the help request and out of service (**OOS**) messages. If a supervisor station is assigned in **ADMIN**, it is considered logged in. In addition, a supervisor can dial a supervisor login code followed by the ACD group that the supervisor is logging into and his four-digit ID number.

**AUTOMATIC CALL DISTRIBUTION (Cont'd)**

**E. ACD Station Assignment(s)**

Programming Steps

To program stations into a ACD group:

1. Press the Page "B" flexible button (Button #19). The following message is shown on the display phone.

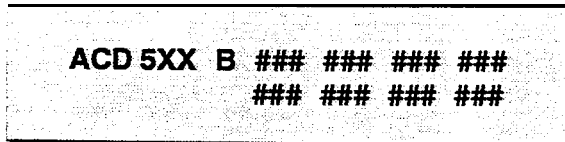

Where:

- 5XX = ACD Group Number (558-565)
  - B = Page "B" parameters
  - ### = ACD Station assignments
2. The top left button in the flexible button field will be lit for programming ACD group 9 (558). To change ACD groups or enter further ACD groups (558 to 565), press the appropriate flexible button and perform the following procedures.
  3. Enter the three-digit station numbers of the stations in the ACD group in the order in which they will be checked. The order is only relevant for the first call. After that, the rule is oldest idle. A maximum of 16 stations may be entered.
  4. Press the HOLD button to save the entry. Confirmation tone is heard and the display will now update.

If ACD Station assignments in the 2nd Group of eight (Stations 9 thru 16) are to be viewed:

1. Press the DISPLAY STATIONS flexible button (Page B, Button #17). The 2nd group of station assignments will be displayed. If no additional stations are assigned, beyond the 1st eight stations, the display will show pound signs (#) instead of station assignments. Press the Page "B" flexible button (Button #19) again to return and view the 1st group of eight stations in the same ACD group.

Description

**ACD STATION ASSIGNMENTS.** Any type of station (excluding DSS/DLS Consoles) may be entered as valid ACD stations. Calls will be routed to station in the order they are entered for the first round of calls only. After that the calls are routed to stations based on On-Hook time. The station with the longest On-Hook time will receive the next call.

If a specific station number is dialed, only that station is rung; no distribution will be done if that station is busy.

The buttons on the digital terminal are defined as shown below when entering the ACD Station Assignments programming area:

1	Q	ACD GROUP 558		11	A
2	W	ACD GROUP 559		12	S
3	E	ACD GROUP 560		13	D
4	R	ACD GROUP 561		14	F
5	T	ACD GROUP 562		15	G
6	Y	ACD GROUP 563		16	H
7	U	ACD GROUP 564		17	J
8	I	ACD GROUP 565	SZLECTPAGE 4	18	K
9	O		SELECTPAGE B	19	L
10	P			20	:

To erase all stations, press the pound key three times [###] and press HOLD.

**NOTE** *If an ACD member is assigned to a specific ACD group and uses the login-logout codes to enter and exit an ACD group other than his own assigned group, the database programming for ACD stations will be automatically changed to reflect the different group.*

**DISPLAY STATIONS.** Any time a display of the 2nd group of ACD Station assignments (default or changed) is needed, press the DISPLAY STATIONS button (Button #17). It will display the 2nd group of station assignments up to eight stations at a time. Button #19 will always show the 1st eight stations programmed in the ACD Group. Button #17 will always display the 2nd group of eight stations programmed in the same ACD group.



**TABLE OF CONTENTS FOR SECTION 650**

<b>SECTION 650</b>	<b>UNIFORM CALL DISTRIBUTION (UCD) .....</b>	<b>650-1</b>
650.1	UCD GROUP PROGRAMMING .....	650-1
	A. Alternate UCD Group Assignment.. .....	650-2
	B. UCD Overflow Station Assignment.. .....	650-2
	C. UCD Recorded Announcement Assignment(s) (RAN) .....	650-3
	D. UCD Station Assignment(s). .....	650-4
650.2	UCD TIMERS .....	650-5
	A. UCD Ring Timer .....	650-5
	B. UCD Message Interval Timer .....	650-6
	C. UCD Overflow Timer.. .....	650-6
	D. UCD Auto Wrap-Up Timer.. .....	650-7
	E. UCD No-Answer Recall Timer.. .....	650-7
	F. UCD No-Answer Retry Timer .....	650-B
650.3	UCD RAN ANNOUNCEMENT TABLES.. .....	650-9

## SECTION 650

# UNIFORM CALL DISTRIBUTION (UCD)

### 650.1 UCD GROUP PROGRAMMING

#### Programming Steps

If the system is in the programming mode, continue using the program codes. If starting to program here, enter the programming mode. Refer to Sec. 600.2, Program Mode Entry (Key Station).

If UCD Groups are to be assigned:

1. Press FLASH and dial [60]. The following message is shown on the display phone:

**UCD 5XX A ALT OVR AN  
 AAA BBB CC**

Where:

- XX = UCD Group Number (550-557)
  - AAA = Alternate UCD Group Assignment
  - BBB = UCD Overflow Assignment
  - CC = UCD Announcement Tables
2. The top left button in the flexible button field will be lit for programming UCD group 1 (550). To change UCD groups or enter further UCD groups (550 to 557), press the appropriate flexible button and perform the following procedures.

#### Description

There can be eight UCD groups of no more than eight stations each. The UCD groups use a pilot hunting technique. If the pilot number is dialed, the assigned stations in that UCD group are searched for the station which has been in an idle condition for the longest period of time.

Each UCD Group may have an assigned Alternate UCD Group, an Overflow station and up to eight stations as UCD members. The two system RAN ports (tables) may also be referenced on a per UCD group basis.

The buttons on the digital terminal are defined as shown below when entering the UCD Group(s) programming area:

1	Q	UCD GROUP 550	ANNOUNCEMENT TABLES	11	A
2	W	UCD GROUP 551		12	S
3	E	UCD GROUP 552		13	D
4	R	UCD GROUP 553		14	F
	ST	UCD GROUP 554		15	G
5	Y	UCD GROUP 555		16	H
7	U	UCD GROUP 556		17	J
8	I	UCD GROUP 557	SELECT PAGE A	18	K
9	O	ALTERNATE UCD GROUP	SELECT PAGE B	19	L
10	P	OVERFLOW ASSIGNMENTS		20	:

**Default:** By default, UCD Group Tables are empty.

**Related Programming:** Refer to Sec. 650.2, UCD Timers for setting the UCD Ring Timer, UCD Message Interval Timer, UCD Overflow Timer, UCD Answer Recall Timer, and UCD No-Answer Retry Timer; Also refer to Sec. 650.3, UCD RAN Announcement Tables for assigning RAN device ports and message times.

**UNIFORM CALL DISTRIBUTION (UCD)****UNIFORM CALL DISTRIBUTION (Cont'd)****A. Alternate UCD Group Assignment**Programming Steps

To program an alternate group:

1. Press the ALTERNATE UCD GP flexible button (Button #9).
2. Enter the three-digit pilot number (550 to 557) of the desired alternate UCD group.
3. Press the HOLD button to save the entry. Confirmation tone is heard and the display will now update.

```
UCD 5XX A ALT OVR AN
      AAA BBB CC
```

Description

**ALTERNATE UCD GROUP.** An alternate UCD group can be programmed so that if no station in one group is available, the alternate group will be checked for an available station. This provides a means to chain or link UCD groups together.

To delete an Alternate UCD Group, press the pound key three times [###] and press the HOLD button.

**B. UCD Overflow Station Assignment**Programming Steps

To program UCD Overflow station:

1. Press the OVERFLOW ASSIGN flexible button (Button #10).
2. Enter the three-digit station number (100 to 195) to designate the UCD Groups overflow station.
3. Press the HOLD button to save the entry. Confirmation tone is heard and the display will now update.

```
UCD 5XX A ALT OVR AN
      AAA BBB CC
```

Description

**UCD OVERFLOW ASSIGN.** When an overflow station is assigned, callers that have remained in queue for a specified amount of time will be routed to the assigned overflow station. The overflow station may not be one of the UCD group stations. Only CO calls transferred to a UCD group will overflow to the overflow station when RAN tables have not been assigned.

To delete an Overflow Station, press the pound key three times [###] and press the HOLD button.

UNIFORM CALL DISTRIBUTION (Cont'd)

C. UCD Recorded Announcement  
Assignment(s) (RAN)

Programming Steps

To program a Recorded Announcement:

1. Press the ANNOUNCEMENT TBLS flexible button (Button #11).
2. Enter a two-digit sequence:
  - 1st Digit = RAN port specified for primary message.
  - 2nd Digit = RAN port specified for secondary message.

Example:

- an entry of 1,2 = Port 1 will answer the call, Port 2 will provide a secondary message.
  - an entry of 8,1 = Port 8 will answer the call, Port 1 will provide a secondary message.
3. Press the HOLD button to save the entry. Confirmation tone is heard and the display will now update.



Description

**UCD ANNOUNCEMENT TABLES.** An optional Recorded Announcement device may be connected to the system to provide an announcement if all stations in a UCD group are busy. Up to eight ports in the system may be assigned to provide a path to Recorded Announcement devices.

Incoming CO Callers **will** only be answered and routed to the Overflow assignment if a RAN Table is assigned.

To erase Recorded Announcement(s), press the pound key two times [##] and press HOLD.

**Related Programming:** Refer to Sec. 650.3, UCD RAN Announcement Tables programming for further information regarding each RAN Table.

**UNIFORM CALL DISTRIBUTION (UCD)**

**UNIFORM CALL DISTRIBUTION (Cont'd)**

**D. UCD Station Assignment(s)**

Programming Steps

To program stations into a UCD group:

1. Press the Page "B" flexible button (Page A, Button #19). The following message is shown on the display phone.

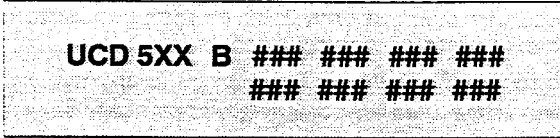

Where:

- 5XX = UCD Group Number (550-557)
  - B = Page "B" parameters
  - ### = UCD Station assignments
2. The top left button in the flexible button field will be lit for programming UCD group 1 (550). To change UCD groups or enter further UCD groups (550 to 557), press the appropriate flexible button and perform the following procedures.
  3. Enter the three-digit station numbers of the stations in the UCD group in the order in which they will be checked. The order is only relevant for the first call. After that, the rule is oldest idle. A maximum of eight stations may be entered.
  4. Press the HOLD button to save the entry. Confirmation tone is heard and the display will now update.

Description

**UCD STATION ASSIGNMENTS.** Any type of station (excluding DSS/DLS Consoles) may be entered as valid UCD stations. Calls will be routed to station in the order they are entered for the first round of calls only. After that the calls are routed to stations based on On-Hook time. The station with the longest On-Hook time will receive the next call.

If a specific station number is dialed, only that station is rung; no distribution will be done if that station is busy.

The buttons on the digital terminal are defined as shown below when entering the UCD Station Assignment(s) programming area.

1	Q	UCD GROUP 550		11	A
2	W	UCD GROUP 551		12	S
3	E	UCD GROUP 552		13	D
4	R	UCD GROUP 553		14	F
5	T	UCD GROUP 554		15	G
6	Y	UCD GROUP 555		16	H
7	U	UCD GROUP 556		17	J
8	I	UCD GROUP 557	SELECT PAGE A	18	K
9	0		SELECT PAGE B	19	L
10	P			20	:

To erase all stations, press the pound key three times [###] and press HOLD.

UNIFORM CALL DISTRIBUTION (Cont'd)

660.2 UCD TIMERS

Programming Steps

If UCD timers are to be changed:

- a. Press FLASH and dial [61]. The following message is shown on the display phone:

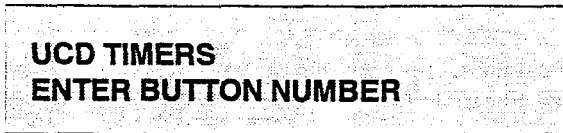

Description

Six timers for UCD operation are programmable on a system-wide basis. The UCD timers include: A Ring Timer, Message Interval Timer, an Overflow Timer, a Auto Wrap-Up Timer, a No/Answer Recall Timer, and a No/Answer Retry Timer. Each timer is described below:

**Related Programming:** Refer to Sec. 650.1, UCD Group Programming; and UCD Recorded Announcement Assignment(s); Also refer to Sec. 500.3, System Components, Voice Control Board (VCB) for Background Music/Music-On-Hold Connections, and Installing Recorded Announcement Device (RAN).

The buttons on the digital terminal are defined as shown below when entering the UCD Timers programming area.

1	Q	RING TIMER	11	A
2	W	MIT TIMER	12	S
3	E	OVERFLOW TIMER	13	D
4	R	WRAP-UP TIMER	14	F
5	T	WRAP-UP TIMER	15	G
6	Y	NO-ANSWER RETRY	16	H

A. UCD Ring Timer

Programming Steps

To make a change to the UCD Ring Timer:

1. Press the RING TIMER flexible button (Button #1). The following message is shown on the display phone:



Description

**UCD RING TIMER.** The UCD Ring Timer determines how long a call will ring into a busy UCD group before being presented to the first recorded announcement.

Default: By default, the UCD Ring Timer is set for 60 seconds, and is variable from 000 to 300 seconds.

**NOTE** A RAN Table must be specified in UCD programming. Refer to Sec. 650.3, UCD RAN Announcement Tables for the ring timer to be in effect. If a RAN Table is NOT specified, incoming CO callers will **not be** answered but will continue to receive **ringback**.

2. Enter the three-digit timer value on the dial pad which corresponds to 000-300 seconds.
3. Press the HOLD button to save the entry. Confirmation tone is heard and the display will now update.

## UNIFORM CALL DISTRIBUTION (Cont'd)

## UCD TIMERS (Cont'd)

## B. UCD Message Interval Timer

Programming Steps

To make a change to the UCD Message Interval Timer:

1. Press the MIT TIMER flexible button (Button #2). The following message is shown on the display phone:

<b>MESSAGE</b>	<b>000-600</b>
<b>060</b>	

2. Enter the three-digit timer value on the dial pad which corresponds to 000-600 seconds.
3. Press the HOLD button to save the entry. Confirmation tone is heard and the display will now update.

**NOTE**

*The UCD Ring and Message Interval Timers only apply when RAN ports have been specified. If RAN ports are not specified, incoming callers will continue to receive ringback tone.*

Description

**UCD MIT TIMER.** The UCD Message Interval Timer (MIT) determines the length of time a caller remains in queue (listening to MOH, if provided) between recorded announcements.

**Default:** By default, the UCD Message Interval Timer is set for 60 seconds and is variable from 000 to 600 seconds.

## C. UCD Overflow Timer

Programming Steps

To make a change to the UCD Overflow Timer:

1. Press the OVERFLOW TIMER flexible button (Button #3). The following message is shown on the display phone:

<b>0</b>	<b>OVERFLOW</b>	-	<b>6</b>	<b>0</b>	<b>0</b>
	<b>060</b>				

2. Enter the three-digit value on the dial pad which corresponds to 000-600 seconds.
3. Press the HOLD button to save the entry. Confirmation tone is heard and the display will now update.

Description

**UCD OVERFLOW TIMER.** The UCD Overflow Timer determines the total length of time a caller will remain in queue for a particular UCD group. When the timer expires, the caller will be routed to the designated overflow station. The timer starts when an incoming call is answered and presented to the first recorded announcement. Transferred CO callers will overflow at the expiration of the Overflow Timer.

**Default:** By default, the UCD Overflow Timer is set for 60 seconds and is variable from 000 to 600 seconds.

UNIFORM CALL DISTRIBUTION (Cont'd)

UCD TIMERS (Cont'd)

D. UCD Auto Wrap-Up Timer

Programming Steps

To make a change to the UCD Auto Wrap-up Timer:

1. Press the AUTO-WRAP TIMER flexible button (Button #4). The following message is shown on the display phone:

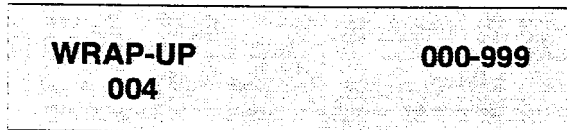

2. Enter the three-digit value on the dial pad which corresponds to 000-999 seconds.
3. Press the HOLD button to save the entry. Confirmation tone is heard and the display will now update.

Description

**UCD AUTO-WRAP TIMER.** After completion of a UCD call (on-hook) the agent will not be subjected to another UCD call for the duration of the Auto Wrap-Up timer allowing the agent to finish call related work or access other facilities. This will allow agents to remove themselves from the group (i.e. DND, Call Forward) or originate another call.

**Default:** By default, the UCD Auto Wrap-up Timer is set for 04 seconds and is variable from 000 to 999 seconds.

E. UCD No-Answer Recall Timer

Programming Steps

To make a change to the UCD No-Answer Recall Timer:

1. Press the NO-ANSWER RECALL TIMER flexible button (Button #5). The following message is shown on the display phone:

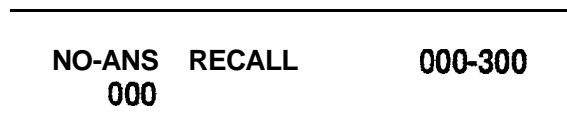

2. Enter the three-digit value on the dial pad which corresponds to 000-300 seconds.
3. Press the HOLD button to save the entry. Confirmation tone is heard and the display will now update.

Description

**UCD NO-ANSWER RECALL TIMER.** If a call routed to a station via ACD is not answered by the ACD Agent/Station before the No-Answer Recall timer expires, the call will be returned to ACD Queue with the highest priority. In addition, the station that failed to answer the ringing ACD call will be placed into an out of service (OOS) state.

**Default:** By default, the UCD No-Answer Timer is set at 000 (disabled) and is variable from 000 to 300 seconds.



## UNIFORM CALL DISTRIBUTION (UCD)

## UNIFORM CALL DISTRIBUTION (Cont'd)

## UCD TIMERS (Cont'd)

## F. UCD No-Answer Retry Timer

Programming Steps

To make a change to the UCD No-Answer Retry Timer:

1. Press the NO-ANSWER RETRY TIMER flexible button (Button #6). The following message is shown on the display phone:

<b>NO ANSWER RETRY</b>	<b>000-999</b>
<b>300</b>	

2. Enter the three-digit value on the dial pad which corresponds to 000-999 seconds.
3. Press the HOLD button to save the entry. Confirmation tone is heard and the display will now update.

Description

**UCD NO-ANSWER RETRY TIMER.** When the No-Answer Recall timer **expires**, a station that failed to answer the ringing ACD call is placed into an **out-of-service (OOS)** state. The station that was taken out-of-service (**OOS**) will be placed back in service if the agent hits his available flex button or dials the available flex code. In addition, the agent will be placed back in service if the No-Answer Retry timer expires. If the agent does not answer his next ACD call, he will again be taken out-of-service. This cycle will continue until the station answers calls, logs out, or goes unavailable.

**Default:** By default, the UCD No-Answer Retry Timer is set for 300 seconds and is variable from 000 to 999 seconds.

UNIFORM CALL DISTRIBUTION (Cont'd)

650.3 UCD RAN ANNOUNCEMENT TABLES

Programming Steps

If Recorded Announcement devices are installed to operate with UCD, these tables must be programmed:

- a. Press FLASH and dial [62]. The following message is shown on the display phone:

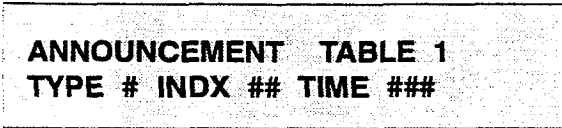

- b. The top left button in the flexible button field will be lit for programming UCD RAN Announcement Table 1. To change to UCD RAN Announcement Table 2, press flexible button #2. Repeat above for Tables 3 through Tables 8.
- c. Enter a string of six, or seven digits on the dial pad. The order of data entry will be:  
 Type Number:
  - [1] = CO Port interface
  - [2] = SLT Port interface
 Index (port) Number:
  - [01-48] = CO Line Port
  - [100-195] = SLT Station Port
 Message Time:
  - 000-300 seconds
- d. Press the HOLD button to save the entry. Confirmation tone is heard and the display will now update.

**NOTE** When a CO port is designated as a RAN port, a relay and/or sensor should be programmed as a RAN start for Announcement Table 1 through 8.

To clear entries in a Table:

- a. Press the pound key once [#] followed by the HOLD button.

Description

Determines the type, index (port) number and message length for the eight available Recorded Announcements (RAN). There are eight RAN tables that can be programmed. A table can be the answer port for unanswered incoming calls to a UCD group, while another table can provide the secondary message.

The buttons on the digital terminal are defined as shown below when entering the UCD RAN Announcement Tables programming area.

1	Q	ANNOUNCEMENT TABLE #1	11	A
2	W	ANNOUNCEMENT TABLE #2	12	S
3	E	ANNOUNCEMENT TABLE #3	13	D
4	R	ANNOUNCEMENT TABLE #4	14	F
5	T	ANNOUNCEMENT TABLE #5		
6	Y	ANNOUNCEMENT TABLE #6	16	H
7	U	ANNOUNCEMENT TABLE #7	17	J
8	I	ANNOUNCEMENT TABLE #8	18	K

The type can be either a CO line port, or a SLT port. The index number specifies which circuit for the type of interface.

The message length is used to match the maximum length of the message to the device that is used.

Example:

To program a table for a CO line port:

- a. Press the TABLE "X" flexible button (Buttons I-8).
- b. Dial [1] for CO port interface.
- c. Dial [01 to 48] for CO line used.
- d. Enter message duration (000-300 sec.)

Example:

To program a table for an SLT port:

- a. Press the TABLE "X" flexible button (Buttons I-8).
- b. Dial [2] for SLT port interface.
- c. Dial [100 to 195] for SLT station used.
- d. Enter Message duration (000-300 sec.)

**Related Programming:** Refer to Sec. 650.1, UCD Group Programming; 650.2, UCD Timers; Also refer to Sec. 500.9, Installing Recorded Announcement Device (RAN).

## TABLE OF CONTENTS FOR SECTION 655

<b>SECTION 655</b>	<b>VOICE MAIL GROUPS (VM) .....</b>	<b>655-1</b>
655.1	VOICE MAIL PROGRAMMING.. .....	655-1
	A. Alternate Voice Mail Group.. .....	655-2
	B. "Leave" Mail Index Entry: .....	655-2
	C. "Retrieve" Mail index Entry .....	655-3
	D. Station Assignment(s). .....	655-3
655.2	VOICE MAIL OUTPUTSING TABLE.....	655-4
	A. Voice Mail In-Band Signaling.. .....	655-4
	B. Voice Mail Disconnect Table .....	655-5
655.3	VOICE MAIL IN-BAND FEATURES.. .....	655-6
	A. Voice Mail In-Band Digits.. .....	655-6
	B. Voice Mail Transfer/Forward.. .....	655-7

## SECTION 655

### VOICE MAIL GROUPS (VM)

655.1 VOICE MAIL PROGRAMMING

Programming Steps

If the system is in the programming mode, continue using the program codes. If starting to program here, enter the programming mode. Refer to Sec. 600.2, Program Mode Entry (Key Station).

If Voice Mail Groups are to be programmed:

1. Press FLASH and dial [65]. The following message is shown on the display phone.

**VM 44G AAA LLL R XXX, XXX,  
 XXX, XXX, XXX, XXX, XXX, XXX**

Where:

- G = Voice Mail group number (0-7)
  - AAA = Alternate group (440447)
  - LLL = "Leave" mail index.
  - R = "Retrieve" mail index from outpulsing table for retrieving messages (0-7)
  - XXX = Voice Mail station numbers (ports).(up to 8 max.)
2. The top left button in the flexible button field will be lit for programming voice mail group 440. To change Voice Mail groups or enter further Voice Mail groups, press the appropriate flexible button 1-8 (440447) and perform the following procedures.

**NOTE** *Certain programming will be required in the Voice Mail system connected to the Starplus Digital Key Telephone System for proper operation.*

1. Mail Box numbers mustmatch Starplus Digital Key Telephone System station extension numbers. (100-195)
2. Tone Mode Calling option (6#) must be programmed as leading digits in transfer sequence(s) to force tone ringing to key telephones in the handsfree mode.

Description

***This feature is available with optional software.***  
 Up to eight Voice Mail groups can be configured in the Starplus Digital Key Telephone System. Each group can contain up to eight Voice Mail designated ports, each of which interfaces with a port on an SLT or OPX card.

An externally provided Voice Mail system or Auto Attendant must be connected to the Starplus Digital Key Telephone System for Voice Mail or Auto Attendant operation. Voice Mail automatically handles unanswered calls. Station user can then retrieve messages left at their stations. Auto Attendants can handle incoming calls and route callers to station users without intervention from the systems attendant.

Direct incoming ring to Voice Mail/Auto Attendant groups can be done directly through CO Line Ringing Assignments.

The buttons on the digital terminal are defined as shown below when entering the Voice Mail programming area:

1	G	VOICE MAIL GROUP 440	R (RETRIEVE)	11	A
2	W	VOICE MAIL GROUP 441	STATION ASSIGNMENTS	12	S
3	E	VOICE MAIL GROUP 442		13	D
4	R	VOICE MAIL GROUP 443		14	F
5	T	VOICE MAIL GROUP 444		15	G
6	Y	VOICE MAIL GROUP 445		16	H
7	U	VOICE MAIL GROUP 446		17	d
8	I	VOICE MAIL GROUP 447		18	K
9	O	ALTERNATE VOICE MAIL GROUP		19	L
10	P	L (LEAVE)		20	;

**Default:** By default, all Voice Mail stations are assigned to Pickup Group 1.

**Related Programming:** Refer fo Sec. 655.2, Voice Mail Outpulsing Table, Voice Mail In-Band Signaling for incoming CO calls; 620.1, CO Line Programming, CO Line Ringing Assignments.

**VOICE MAIL GROUPS (VM)****VOICE MAIL GROUPS (Gont'd)****A. Alternate Voice Mail Group**Programming Steps

To program an alternate group:

1. Press the ALTERNATE VM GP flexible button (Button #9).
2. Enter the three-digit pilot number (440 to 447) of the desired group.
3. Press the HOLD button to save the entry. Confirmation tone is heard and the display will now update.

```
VM 44G AAA LLL R XXX, XXX,
XXX, XXX, XXX, XXX, XXX, XXX
```

Description

**ALTERNATE VM GP.** An Alternate Voice Mail Group may be programmed so that if all Voice Mail ports are in use, the call can be routed to an alternate group. This is useful when more than eight ports are required for Voice Mail traffic.

To delete an Alternate Voice Mail Group assignment, enter three pounds [###] on the keypad and press the HOLD button.

**B. "Leave" Mail Index Entry**Programming Steps

To specify the "Leave" mail index (outpulsing table) to be accessed by a Voice Mail group:

1. Press the LEAVE flexible button (Button #1 0).
2. Enter the three-digit "Leave" mail index on the dial pad.
  - 1st Digit = Standard Leave Table number (0-7).
  - 2nd Digit = Leave Table to utilize when station is forwarded to VM in a "No-Answer" condition.
  - 3rd Digit = Leave Table to utilize when station is forwarded to VM in a "Busy" condition.
3. Press the HOLD button to save the entry. Confirmation tone is heard and the display will now update.

```
VM 44G AAA LLL R XXX, XXX,
XXX, XXX, XXX, XXX, XXX, XXX
```

Description

**LEAVE.** The "Leave" mail index specifies the Outpulsing Table where the "in-band" digits required to connect a caller, forwarded into Voice Mail, to the called stations mail box are stored. Refer to Sec. 655.2 for programming entries into an outpulsing table.

To delete a "Leave" mail index entry, enter one pound [#] in the desired location on the keypad and press the HOLD button. (i.e.: Tables 1,2,3 entered. To delete only Table 2, enter 1,#,3 and press HOLD).

## VOICE MAIL GROUPS (Cont'd)

### C. "Retrieve" Mail Index Entry

#### Programming Steps

To program the "Retrieve" mail index (outpulsing table) to be accessed by the Voice Mail group:

1. Press the RETRIEVE flexible button (Button #11).
2. Enter the one-digit outpulsing table number (0-7) on the dial pad.
3. Press the HOLD button to save the entry. Confirmation tone is heard and the display will now update.

```
VM 44G AAA LLL R XXX, XXX,  
XXX, XXX, XXX, XXX, XXX, XXX
```

#### Description

**RETRIEVE.** The "Retrieve" mail Index specifies the outpulsing table where the "In-band" digits required to connect a station user to their own mail box are stored. Refer to Sec. 655.2 for programming entries into an outpulsing table.

**NOTE**

*In order for the Starplus Digital Key Telephone System to send the Station Identification digits (station three-digit extension number), a "Leave" and a "Retrieve" table must be referenced when assigning Voice Mail groups. However, the "Leave" and "Retrieve" outpulsing Tables Sec. 655.2 can be empty (no entries in the referenced table)*

To delete a "Retrieve" mail index entry, enter one pound [#] on the keypad and press the HOLD button.

### D. Station Assignment(s)

#### Programming Steps

To program the stations in the Voice Mail group:

1. Press the STATION ASSIGN flexible button (Button #12).
2. Enter the three-digit station numbers (100-195). A maximum of eight SLT stations may be entered.
3. Press the HOLD button to save the entry. Confirmation tone is heard and the display will now update.

```
VM 44G AAA LLL R XXX, XXX,  
XXX, XXX, XXX, XXX, XXX, XXX
```

#### Description

Up to eight SLT or OPX port extension numbers may be programmed into a Voice Mail group.

The ports will be designated as two-way ports by directing calls to any one of the ports and allowing any one of the ports (or all ports) to be used as VM out dial and/or VM notify ports.

A flexible button may be programmed with a Voice Mail group pilot number. This button will then act as a DSS for that Voice Mail group when pressed and also serves as the message waiting indication for that VM group.

VOICE MAIL GROUPS (Cont'd)

655.2 VOICE MAIL OUTPUTSING TABLE

A. Voice Mail In-Band Signaling

Programming Steps

if Voice Mail In-Band signaling is to be used:

1. Press FLASH and dial [66]. The following message is shown on the display phone.

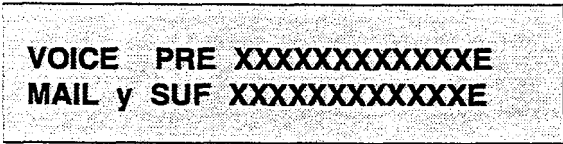

Where:

- y = Table index (0-7)
  - x = Entered digits (0-9, #, \*, Pauses)
2. The TABLE 00 flexible button (Button #1) led is lit. To change tables, press the appropriate flexible button (Buttons 2-8) and perform the following procedures.
  3. Dial one of the following, if required:
    - [0] = if a prefix is required
    - [1] = if a suffix is required
    - [#] = if entry is to be deleted
  4. Enter up to 12 digits required including '\*' and '#'. TRANS button = pause.
  5. Press the HOLD button to save the entry. Confirmation tone is heard and the display will now update.

Description

Entries into one of the eight Voice Mail Outpulsing Tables determine the In-Band signaling required for "Retrieving" messages (allows for stations to pick up mail) and "Leaving" messages (allows stations to leave messages in voice mail).

The buttons on the digital terminal are defined as shown below when entering the Voice Mail Outpulsing Table programming area.

1	Q	TABLE 0	11	A
2	W	TABLE 1	12	S
3	E	TABLE 2	13	O
4	R	TABLE 3	14	F
5	T	TABLE 4	15	G
6	Y	TABLE 5	16	H
7	U	TABLE 6	17	J
8	I	TABLE 7	18	K
9	0	DISCONNECT TABLE 8	19	L

Build a table ("0" for example) for any additional digits other than the Station Extension Number (Voice Mail Box Number) needed for a caller to leave a message in a station's mailbox. ("Leave")

Build another table ("1" for example) for any additional digits needed for a mailbox holder to retrieve a message ("Retrieve").

To clear entries in a Table, press the pound key once [#], followed by the HOLD button.

**NOTE** Entries are not required in the Outpulsing Table, however a table must be referenced when setting up the Voice Mail groups, Sec. 655.1 for both Leave and Retrieve data fields, if In-Band signaling is desired.

**Related Programming:** Refer to Sec. 655.1, Voice Mail Groups (VM); Sec. 655.2, Voice Mail in-Band Signaling on incoming CO Calls.

VOICE MAIL GROUPS (Cont'd)

VOICE MAIL OUTPUTSING TABLE (Cont'd)

B. Voice Mail Disconnect Table

Programming Steps

1. Press the DISCONNECT TABLE 8 flexible button (Button #9). This is the table number used for the Voice Mail disconnect signal.
2. Enter up to 12-digits which will be used for the disconnect signal, including '\*' and '#'. TRANS button = pause.
3. Press the HOLD button to save the entry. Confirmation tone is heard and the display will now update.

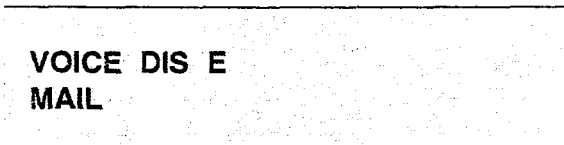

Description

To avoid Voice Mail ports from being tied up as a result of CO line callers abandoning the call or not exiting the VM system properly, a disconnect signal can be programmed into the Starplus Digital Key Telephone System to notify the VM system that a call has been abandoned. This is accomplished through "in-band" signaling. If a CO disconnect signal is detected, the Starplus Digital Key Telephone System will send a series of DTMF digits programmed in the Voice Mail disconnect table (outputting table #8) to the Voice Mail port. This can be any digit stream up to 12-digits including "\*" and "#". This table will serve all eight voice mail groups. Silence is provided to the Voice Mail port followed by "busy tone" to aid the Voice Mail system to recognize that an intercom caller has abandoned the call.

The Starplus Digital Key Telephone System will provide Loop Supervision monitoring while a CO call is connected to a port designated as Voice Mail.

**NOTE:** Loop supervision must be enabled on the CO lines (in CO line programming) in order for VM disconnect feature to operate.

**Default:** By default programming there are no entries in the disconnect table (Table #8).



## VOICE MAIL GROUPS (VM)

## VOICE MAIL GROUPS (Cont'd)

## 655.3 VOICE MAIL IN-BAND FEATURES

Programming StepsDescription

1. Press FLASH and dial [67]. The following message will be shown on the display:

VMFEATURES ICID AFWD

## A. Voice Mail In-Band Digits

Programming StepsDescription

If Voice Mail In-Band Digits are to be enabled or disabled for Incoming CO callers:

1. Press the INCOMING ID DIGITS flexible button (Button #1). It will toggle on and off with each depression.
  - LED on = ID digits are enabled
  - LED off = ID digits are disabled
2. Press the HOLD button to save the entry. Confirmation tone is heard and the display will now update.

VM FEATURES ICID AFWD

The Starplus Digital Key Telephone System allows the system to be programmed so that if a station programmed to receive incoming CO line ringing is forwarded to Voice Mail they may have direct incoming callers routed directly into their stations voice mail box through the use of "In-Band" signaling. Alternately, when disabled, callers will be answered by the Voice Mail or Auto Attendant Main greeting.

Incoming CO callers can be Station Call Forwarded into voice mail only when the ringing CO line is programmed to ring at one station. Additionally CO lines programmed to ring at an attendant station will station call forward into the Voice Mail system (if programmed to ring only at one attendant station) and be presented to the main greeting (not the attendant stations mail box) even when ID digits are enabled.

**Default:** By default, ID digits for incoming CO calls is enabled.

**Related Programming:** Refer to Sec. 655.1, Voice Mail Programming; and Sec. 655.2, Voice Mail Outpulsingfable

VOICE MAIL GROUPS (Cont'd)

VOICE MAIL IN-BAND FEATURES (Cont'd)

B. Voice Mail Transfer/Forward

Programming Steps

If Voice Mail Call Forward is to be enabled or disabled for Incoming CO callers:

1. Press the CALL FWD flexible button (Button #2). It will toggle on and off with each depression.
  - LED on = Call Forward is enabled
  - LED off = Call Forward is disabled

<b>VM FEATURES ICID AFWD</b>
------------------------------

Description

This feature allows Voice Mail calls, upon reaching a forwarded to VM station, to forward back into the Voice Mail unit. The forwarded station can be forwarded to the same or a different Voice Mail group than the calling VM group. This is useful when VM ports are being used as both Auto Attendant and VM ports. This feature can be enabled/disabled for all VM groups.

**Default:** By default, the VM Transfer/Forward feature is disabled.

**Related Programming:** Refer to Sec. 655.1, Voice Mail Programming; and Sec. 655.2, Voice Mail Outpulsing Table.

## TABLE OF CONTENTS FOR SECTION 660

<b>SECTION 660</b>	<b>EXCEPTION TABLES PROGRAMMING.....</b>	<b>660-3</b>
660.1	EXCEPTION TABLES PROGRAMMING .....	660-3
660.2	RELATED ITEMS TO TOLL RESTRICTION.. .....	660-4
	A. CO/PBX Lines.. .....	660-4
	B. Forced Account Codes .....	660-4
	C. SLT DTMF Receivers .....	660-4
	D. LCR vs. Toll Restriction .....	660-5
660.3	TOLL RESTRICTION PROGRAMMING .....	660-6
	A. Entering Toll Table Programming.. .....	660-6
	B. Allow Table Programming.. .....	660-7
	C. Deny Table Programming.. .....	660-9
	D. Special Table Programming .....	660-I 0
	E. Displaying Toll Table Entries .....	660-I 1

## SECTION 660

# EXCEPTION TABLES PROGRAMMING

### 660.1 EXCEPTION TABLES PROGRAMMING

#### Programming Steps

The Starplus Digital Key Telephone System offers a flexible means of applying toll restriction to stations or individuals. Dialing privileges (or toll restriction) is determined through assignment of station and CO line Class Of Service (COS). Several types of restriction can be derived simply by programming COS assignments and CO line **access** to stations. This may, in some cases, be all that is necessary. However, when a more complex or specific type of restriction is desired the system offers two allow and two deny tables along with four special tables. These tables can be programmed in a variety of ways to handle applications that are straight forward or applications that require a more complex arrangement.

The allow and deny tables are assigned to stations based on their station Class of Service (COS) assignment. The Station (COS) interacts with CO Line COS assignments to provide several different types of dialing privileges (Refer to CO/Station COS matrix below).

The Allow and Deny tables allow entries of either general or specific allow and deny codes such as allowing all [1-800] type calls, and/or denying all [I]+ or [O]+ calls. The allow and deny tables allow a

maximum of eight digits to be entered as allow or deny digits. This **allows** for entry of certain area codes or office codes or a combination of area code plus office code that can specifically be allowed or denied. For example the code [1 555-1 212] may be entered in the deny table to deny local toll information calls. Each allow table contains 20 bins for entry of allow codes. Each deny table contains 10 bins for entry of deny codes.

The following rules should be remembered when setting up the Allow/Deny tables. Refer to Table 660-1 Class of Service (COS).

1. if both tables (allow and deny) have no entries, no restriction is applied.
2. If entries are made in the allow table and only there, then only those numbers are allowed. All other dialing is denied.
3. If entries are made in the deny table and only there, then only those numbers are denied. All other dialing is allowed.
4. If there are entries in both allow and deny tables, the allow table is searched first and if a match is found, it is allowed. if a match is not found, the deny table is searched and if a match is found there, the call is denied. If the number does not match an entry in either table, it is allowed.

**Table 660-1 Class of Service (COS)**

	CO LINE CLASS OF SERVICE					
	1	2	3	4	5	
S T A T I O N	1	Unrestricted	Unrestricted	Unrestricted	Canned Restriction*	Unrestricted
	2	Table A	Table A	Unrestricted	Canned Restriction*	Unrestricted
	3	Table B	Unrestricted	Table B	Canned Restriction*	Unrestricted
	4	Tables A&B	Table A	Table B	Canned Restriction*	Unrestricted
C O S	5	Canned Restriction*	Canned Restriction*	Canned Restriction*	Canned Restriction*	Unrestricted
	6	Intercom only	Intercom only	Intercom only	Intercom only	Intercom only

\*Canned Restriction= No 'O', 1, #, '\*' as a first dialed digit, and 7 digits maximum plus 1-800, 1911, 1611 are allowed and 411, 976, and 555 numbers are denied.

Table 660-2 Allow/Deny Toll Table

	ALLOW TABLE	DENY TABLE	CONDITIONS AND RESULTS			
			DIALED NO.	A/D	DIALED NO.	A/D
RULE 1	NO ENTRIES	NO ENTRIES	ALLOW			
RULE 2	ENTRIES	NO ENTRIES	FOUND	A		
			NOT FOUND	D		
RULE 3	NO ENTRIES	ENTRIES			FOUND	D
					NOT FOUND	A
RULE 4	ENTRIES	ENTRIES	FOUND	A		
			NOT FOUND	D	FOUND	D
			NOT FOUND	A	NOT FOUND	A

A special "Don't Care" ("D") character may be entered as a digit to either allow or deny any digit dialed in that digit sequence. For example a code [1"D"0] and [1"D"1] may be entered in the deny table which would allow local long distance calls (numbers dialed with a 1 followed by a seven-digit local number), but would deny long distance calls (numbers dialed with a 1 followed by an area code).

The Stat-plus Digital Key Telephone System also offers four special tables that can be referenced from within the two allow tables. Three of the special tables can be assigned to specific area codes that require further toll restriction definition. The fourth special table is reserved for use as a home area code table (numbers within the same area code as the site where the system is installed). This provides expanded ability to apply toll restriction on numbers that are dialed within an area code. Each special table will allow up to 800 entries (200-999). This offers the ability to allow every office code on an individual basis

660.2 RELATED ITEMS TO TOLL RESTRICTION

A. CO/PBX Lines

When CO lines are marked as PBX lines (refer to Sec. 620.1, CO Line Programming) the system will first check the PBX code table (refer to Sec. 610.5, PBX Dialing Codes) for a valid

match. If the first digits dialed do not match the entries in the PBX code table the call is considered an attempt to call another PBX extension and no toll restriction is applied. If the first digits dialed are found in the PBX code table then toll restriction will start with the next dialed digit.

B. Forced Account Codes

The system can optionally force the use of account codes on all restricted calls. When forced account codes are enabled (see Sec. 610.2, Account Codes-Forced), an account code must be entered to place a call that is otherwise restricted through toll restriction. By entering an account code the stations effective class of service becomes that equal to class of service 1 (unrestricted).

When account codes are forced on a system wide basis selected users may be instructed on how to enter account codes from any station and be allowed to dial unrestricted from a station that may otherwise be restricted. Use of account codes in this manner, as a traveling class-of-service, is however not controlled by the system. Any station user with knowledge of how to enter account codes to override a stations toll restriction will be allowed to do so.

C. SLT DTMF Receivers

When single line telephones are connected to the Starplus Digital Key Telephone System and toll restriction is enabled, the DTMF receivers located on the station board(s) will monitor the call for a programmed period of time (refer to Sec. 610.1, SLT DTMF Receiver timer). While the DTMF receiver is monitoring the digits being dialed by a single line telephone, it is considered busy and not available for monitoring another SLT attempting to dial. When all DTMF receivers are busy, an SLT attempting to go off-hook will not receive dial tone until a receiver is available. The Starplus SPD 4896 system allows up to up to 28 DTMF receivers for monitoring SLT dialing. If a system has heavy SLT usage, then toll restriction may inhibit dialing by SLT stations. Two options are available to help alleviate this problem; 1) shorten the SLT receiver timer (refer to Sec. 610.1, SLT DTMF Receiver timer). This will free up DTMF receivers faster, however, may not provide the desired toll restriction for SLT stations; or 2) Enable LCR and force LCR on SLT stations. When the LCR database is set up the 3-digit table allows for entry of the number of digits to be expected. When a SLT dials the appropriate number of digits, LCR will release the DTMF receiver and then be available for another SLT call.

**1. LCR vs. Toll Restriction**

LCR is not intended to be an alternative to toll restriction nor is toll restriction intended to be an alternate to LCR. In fact they both work best when programmed together. Toll restriction provides the dialing privileges that stations are allowed and LCR provides the routing of calls onto the proper type of lines. LCR can enhance toll restriction in that LCR provides a "Store and Forward" operation that allows the system to analyze the digits being dialed before a trunk is seized. This prevents users from by-passing toll restriction by taking advantage of the time it takes for a **central** office line to provide dial tone. Because of this it is recommended that LCR be considered when toll restriction is desired.

**EXCEPTION TABLES PROGRAMMING**

**660.3 TOLL RESTRICTION PROGRAMMING**

**A. Entering Toll Table Programming**

Programming Steps

If the system is in the programming mode, continue using the program codes. If starting to program here, enter the programming mode. Refer to Sec. 600.2, Program Mode Entry (Key Station).

**NOTE** *It is recommended that the Exception Tables be initialized prior to entering data into the tables. Do this by following the instructions in Sec. 600.5, Initialization for initializing the Exception Tables. This procedure may also be repeated if it is determined that data in the exception tables has become corrupt. However, after initializing the exception tables, for this purpose, all data must be re-entered into the tables.*

1. Press FLASH and dial [70]. The following message is shown on the display phone:

**EX TABLES  
ENTER BUTTON NUMBER**

2. To program allow/deny tables, press the appropriate Table button and enter information as outlined in the following procedures.
3. To program Special Tables 1-3, it is necessary to associate an area code to the table. This is done by pressing the appropriate "AREA-CODE TBL" button and assign the area code.

**NOTE** *Special Table 4 is reserved for the home area code and does not require an area code entry.*

4. To display entries in any of the tables, press the DISPLAY TABLES button (button #12). Entries in the allow/deny tables will display two at a time. Entries in the special tables will be displayed six at a time in ascending order.

Description

All toll tables have been conveniently placed under one program code to allow entry of all toll restriction data.

The buttons on the digital terminal are defined as shown below when entering the Toll Restriction programming area.

1	Q	ALLOW TABLE A	AREA CODE TBL3	11	A
2	W	DENY TABLE A	DISPLAY TABLES	12	S
3	E	ALLOW TABLE B		13	D
4	R	DENY TABLE B		14	F
5	T	SPECIAL TABLE 1		15	G
6	V	SPECIAL TABLE 2		16	I
7	U	SPECIAL TABLE 3		17	J
8	I	SPECIAL TABLE 4		18	K
9	O	AREA CODE TBL1		19	L
10	P	AREA CODE TBL2		20	;

When the system searches the allow and deny tables, the entries are checked starting with Bin 01 and proceeding sequentially through the table to the last bin. In addition The allow table is always searched before looking at the deny table. Therefore the order of entry is important. Entries that are specific (i.e. [1 716]) should be placed ahead of entries that are more general (usually include "Don't Care" digits i.e. [1 "D" 1]).

Once a match is found, in the allow table, that references a special table the number dialed will be checked for an allowed code in the special table. If a match is not found in the special table the system will continue to check for a match in the next allow or deny table that is to be checked. The system will not return to the table that sent the call to the special table.

EXCEPTION TABLES PROGRAMMING (Cont'd)

B. Allow Table Programming

Programming Steps

1. Press the ALLOW TABLE A or ALLOW TABLE B flexible button (Button #1 or #3). The following message is shown on the display telephone:

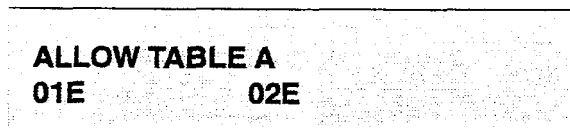

The first two bins locations are displayed.

2. Enter the two-digit bin number (01-20) of the bin to be programmed.

<b>NOTE</b>	<p><i>It is recommended that: Bin 17 be reserved for an entry that will reference special table number 1; Bin 18 be reserved for an entry that will reference special table number 2; Bin 19 be reserved for referencing special table number 3; Bin 20 be reserved for referencing the Home area cook table, special table number 4.</i></p>
-------------	---

3. Enter the allow code:

where:

- 0 to 9, \*, # = corresponding allow digits (numbers)
  - MUTE = Don't Care digit ("D")
  - TRANS = search special table ("S")
4. Press the HOLD button to save the entry. Confirmation tone is heard and the display will now update.
  5. When all entries for one table are complete, press the flexible button for the next table.

The following rules should be applied when making entries that will reference the special tables:

1. For entries referencing the first three special tables a specific area code must be identified (one for each table needed). Then make note as to how the numbers will be dialed when dialing numbers to this area code (i.e. with a leading digit [1] or no leading digit [1]). The entry into the allow table would be entered as follows:

Leading digit [1]: enter BB 1 XXX DDD {S} or

Non Leading [1]: enter BB XXX DDD {S}

Where:

- BB = Bin number (recommended 17-19)
- XXX = Area code (must match AREA-X entry)
- DDD = "Don't Care" digit (three entries, DND button)

Description

**Allow Table** - Each Allow table contains 20 bin numbers. Each bin number may be up to eight-digits in length including {Don't Care} digits and {Search Special Table} commands. Entries into the allow table represent exceptions to numbers or codes that are to be allowed only if they would otherwise be restricted by an entry in the deny table. For example if [1 555 1212] is to be allowed but [1+] numbers are denied, by an entry into the deny table, then [1 555 1212] should be entered into the allow table as an allowed number.

- Allow table A is referenced and searched first (before the deny table A) when Station COS is 2 and CO line COS is either 1 or 2.
- Allow table B is referenced and looked at first (before the deny table B) when Station COS is 3 and CO line COS is either 1 or 3.
- When station COS is 4 and CO line COS is 1 both allow tables are looked at first (allow table A first then allow table B) then both deny tables (deny table A first then deny table B).

**Don't Care** digits specify that the system should consider any digit dialed in that position as a match. Don't Care digits should not be entered as the last digit in an entry, as this would be an unnecessary or meaningless command.

**Search Special Table** commands must be entered in a specific manner and should always be placed as the last entries in the Allow table. It is recommended that the last four bins (17-20) in the allow table be reserved for referencing the four special tables with the reference to the home area code (special table 4) always being located in bin number 20. Search Special table commands can only be entered into the allow tables.

To erase a bin, enter the two-digit bin number following by pressing the HOLD button.



**EXCEPTION TABLES PROGRAMMING****EXCEPTION TABLES PROGRAMMING (Cont'd)****Allow Table Programming (Cont'd)**Programming StepsDescription

- {S}= Search Special Table Command (TRANS button)
- 2. For an entry that is to reference the Home Area Code table (special table 4) the entry may also be entered to expect or not expect a leading digit [1]. In fact in some cases it may be desirable to enter both of the following entries;
  - Leading digit [1]: enter BB 1 DDD {S} and/or
  - Non Leading [1]: enter BB DDD {S}

Where:

- BB = Bin number (recommended bin 20)
- DDD = "Don't Care" digit (three entries, MUTE button)
- {S} = Search Special Table Command (TRANS button)

**NOTE**

*If both leading digit [1] and non-leading digit [1] entries are made to reference the same table it is necessary to place the leading digit [1] entry ahead of the non-leading digit [1] entry in the allow table.*

EXCEPTION TABLES PROGRAMMING (Cont'd)

C. Deny Table Programming

Programming Steps

1. Press the DENY TABLE A or DENY TABLE B flexible button (Button #2 or #4). The following message is shown on the display phone:

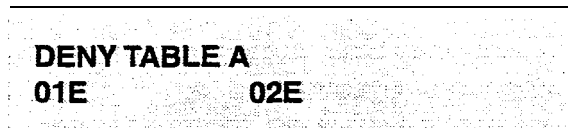

The first two bin locations are displayed.

2. Enter the two-digit bin number (01-10) of the bin to be programmed.
3. Enter the deny code:

where:

- [ ] [ ] [ ] [ ] # = corresponding deny digits (numbers)
- MUTE = Don't Care digit

4. Press the HOLD button to save the entry. Confirmation tone is heard and the display will now update.
5. When all entries for one table are complete, press the flexible button for the next table.

Description

**Deny Table** - Each Deny table contains ten bin numbers. Each bin number may be up to eight -digits in length including {Don't Care} digits. Entries in the deny table represent numbers or codes that are to be denied or restricted. Common entries would be [1] for restricting all [1+] type of calls. Exceptions to this restriction would be entered into the allow table.

- Deny table A is referenced and searched only after the allow table A is checked when Station COS is 2 and CO line COS is either 1 or 2.
- Deny table B is referenced and searched only after the allow table B is checked when Station COS is 3 and CO line COS is either 1 or 3.
- When station COS is 4 and CO line COS is 1 both allow tables are looked at first (allow table A first then allow table B) then both deny tables (deny table A first then deny table B).

**Don't Care** digits specify that the system should consider any digit dialed in that position as a match. Don't Care digits should not be entered as the last digit in an entry.

Search Special table commands can not be entered into the Deny tables.

To erase a bin, enter the two-digit bin number followed by pressing the HOLD button.

**EXCEPTION TABLES PROGRAMMING**

**EXCEPTION TABLES PROGRAMMING (Cont'd)**

**D. Special Table Programming**

Programming Steps

Description

To program a special table, it is first necessary to assign an area code to the table (except for the home area code).

The special tables provide greater flexibility in designing a toll plan for a particular site. Each special table allows entry of up to 800 three-digit office codes (200 - 999). Three of these tables must be assigned an area code by which they are referenced. The fourth table is reserved for the home area code and requires no area code entry.

To assign an area code to a special table:

The special tables are referenced through entries in the allow tables. Four area codes, including the home area code, can be referenced to these special tables for further definition. When a special table is referenced, entries must be made in the special table specifying what office codes will be allowed. By default no codes are on the allow list.

1. Press the appropriate AREA CODE TABLE (1-4) flexible button (button #9-1 1). The following message is shown on the display phone:

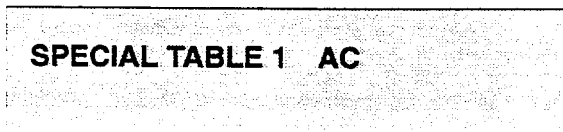

Codes can be added to the allow list or removed from the list. When a special table is checked for a match, to a three digit code, but not found the system will then continue to search the next allow deny table that is to be checked. The system does not return to the allow table which routed the call to the special table.

2. Enter the three-digit area code.
3. Press the HOLD button to save the entry. Confirmation tone is heard and the display will now update.

To enter office codes into the special table:

The buttons on the digital terminal are defined as shown below when entering the Special Table programming area.

4. Press the SPECIAL TABLE (1-4) flexible button (button #5 - #8) that corresponds to the area code programmed above. The following message is shown on the display phone:

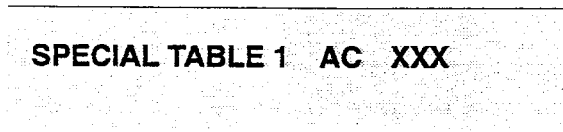

1	Q	ALLOW TABLE A	AREA CODE TBL3	11	A
2	W	DENY TABLE A	DISPLAY TABLES	12	S
3	E	ALLOW TABLE B		13	D
4	R	DENY TABLE B		14	F
5	T	SPECIAL TABLE 1		15	G
6	Y	SPECIAL TABLE 2		16	H
7		SPECIAL TABLE 3		17	J
8	I	SPECIAL TABLE 4		18	K
9	O	AREA CODE TBL1		19	L
10	P	AREA CODE TBL2		20	:

Where:

- XXX = Area Code

5. Enter the three-digit office codes that are to be allowed followed by a [I] which means to allow this code. To remove a code from the allow list enter the three-digit office code followed by a [0] which will remove the code from the allow list.

- XXX [I] = Allow code

- XXX [0] = Remove code from the list

Where XXX = an office code from 200 to 999.

6. Press HOLD after every code entered. Confirmation tone is heard and the display will now update. Multiple codes may be entered in a row. The display will update showing the first six codes in ascending order.

## EXCEPTION TABLES PROGRAMMING (Cont'd)

### E. Displaying Toll Table Entries

#### Programming Steps

#### Description

To display entries in either the Allow/Deny tables or the special tables:

1. Press the DISPLAY TABLES flexible button (button #12) while entering information into a table.
2. While viewing entries made into an allow or deny table, two entries at a time will be displayed on the bottom line of the display. By pressing the DISPLAY TABLES button again, the next higher bins will be displayed. When the last entries are displayed pressing the DISPLAY TABLES button again will show the first two entries.

It is possible to view entries in the toll tables using the display on the Executive telephone. To view all entries, the DISPLAY TABLES flexible button (Button #12) is pressed multiple times to scroll through the entries.

**NOTE** *It is recommended to view all entries in the Allow and Deny table before leaving programming. Entries are **be entered** near the bottom of the list either for searching the special tables or entries that may have been made in error. Viewing the entire allow table will ensure proper entry and operation.*

```
ALLOW TABLE A
01 XXXXXXXE 02 XXXXXXXX
```

Where:

- X = Allow or Deny Code
- E = End of Entry

While viewing entries in a special table, six three-digit codes, that have been allowed, will be displayed in ascending order starting with the lowest entry. By pressing the DISPLAY TABLES button again, the next six entries will be displayed. This will continue until all codes have been displayed.

```
SPECIAL TABLE 1 AC XXX
YYY YYY W Y W Y YYY YYY
```

Where:

- XXX= Area Code
- YYY= Allowed Office Code

**TABLE OF CONTENTS FOR SECTION 665**

<b>SECTION 666</b>	<b>LEAST COST ROUTING (LCR) PROGRAMMING .....</b>	<b>665-1</b>
665.1	INTRODUCTION .....	665-1
	A. LCR Operation .....	665-1
665.2	LCR TABLES PROGRAMMING .....	<b>665-4</b>
	A. 3-Digit Area/Office Code Table .....	<b>665-5</b>
	B. 6-Digit Office Code Table .....	665-6
	C. Exception Code Table .....	665-7
	D. Route List Table.. .....	<b>665-8</b>
	E. Insert/Delete Table .....	<b>665-10</b>
	F. Daily Start Time Table .....	665-1 1
	G. Weekly Schedule Table .....	665-12
	H. LCR Routing for Toll Information .....	665-1 3
	I. Default LCR Database .....	665-14

## SECTION 665

# LEAST COST ROUTING (LCR) PROGRAMMING

### 665.1 INTRODUCTION

*This feature is available with optional software.*

Least Cost Routing (LCR) selects the most economical programmed route for an outgoing call. When a station user dials an outside number, the LCR feature analyzes the number and then automatically chooses an outside line from the group that has been programmed as most economical. The LCR feature puts the responsibility of choosing the least expensive route for each area code and exchange code on the system administrator, not on the station user. In order to make a routing decision, the LCR feature is programmed in the system database. The successful operation of this feature is completely dependent on the accuracy of the programming. Refer to Figure 665-I LCR Flowchart for assistance.

There are eight different tables which are set up to monitor the dialing of digits and to select the best route for the call depending on time of day and day of week.

These tables are:

- 3-Digit Area/Office Code Routing Table
- 6-Digit Office Code Routing Table
- Exception Table
- Route List Table
- Insert/Delete Table
- Daily Start Time Table
- Weekday (Weekly) Schedule
- Toll Information Table

### A. LCR Operation

The system first checks to see if the number dialed is more than two digits. If it is two digits or less, the call is processed according to instructions in the Exception Table. If the number is not found in the Exception Table, the call is denied.

If the number is more than two digits, it goes to the 3-Digit Table. If the first digit dialed is a "1" the leading 1 table will be checked with the following three digits. If the first digit dialed is not a "1", then the first three digits are checked against the **Non-Leading 1 3-Digit** table. The first three digits (either office code or area code) are then checked to see if they are in the 3-Digit Table. If they are not found there, the call is not routed. If the digits are found in the **3-Digit** Table, the system then checks for an entry to see if the **6-Digit** Table must be referenced.

If the **6-Digit** column is marked [yes] in the three digit table entry, the number is then checked in the 6-Digit Table.

There are 20 **6-Digit** tables. Each **6-Digit** table is programmed and becomes associated to a specific area code with a selected route. Office codes are entered into the **6-Digit** table that will be routed to a specific route list table. This allows the system administrator to split area codes for routing to different lines connected to the system. This helps when Foreign Exchange lines (FX Lines), Banded WATS lines, or "Dedicated" Lines (OPX's from another system) are in use.

If the office code is not found in the 6-Digit Table, the call is referred back to the 3-Digit Table for selecting a route list table. And then goes through the same procedures as described below.

Before actually selecting a route list table, the number is checked against the toll restriction tables (station COS). When LCR is enabled, only station Class of Service is referenced. CO line Class of Service is no longer applicable. All CO lines are considered Class of Service 1.

If the call is not allowed through the toll restriction tables, the call is denied. If it is allowed, the call then goes to the Route List Table as specified by either the 3-Digit or S-Digit table.

The Time of day and Day of week is determined and the call is presented to the corresponding time period route within the specified route table. Each of the 16 Route Tables contain four time sensitive routes.

**LEAST COST ROUTING (LCR) PROGRAMMING**

---

Routes are determined by the time of day and day of week as specified in the Daily Start Time table and the Weekly Schedule table.

After the appropriate route is selected, LCR Class of Service becomes applicable. A station can use only those line groups programmed with a priority number equal to or higher than the station's LCR Class of Service.

If a line is not available in the first choice line group, the system advances to the next choice line group and searches for a free line. This process continues until an available line is found, or the last available line group is searched, or until a line group is reached with a priority assignment lower than the station's LCR Class of Service assignment.

When a line is available the system will seize that line and wait for dial tone. Then before dialing, the system checks the Insert/Delete table for digits that should be deleted from the front of the number or digits that should be inserted either before or after the number dialed. Finally the system begins to dial the number out over the selected line. All of this analyzing and manipulation of the number takes only a fraction of a second from the time the station user begins to dial until the number is dialed out over the public network lines.

If no lines are available in any of the CO line groups programmed for that route and allowed to that station, the call can be automatically queued on to the first choice (least costly) line group. If the user waits three seconds after dialing the number, they will hear confirmation tone which indicates that an automatic LCR Queue Callback has been activated on the first choice line group. When a CO line becomes available in the first choice line group the system will ring the calling station. When answered by the station the system will automatically seize the line and redial the number.

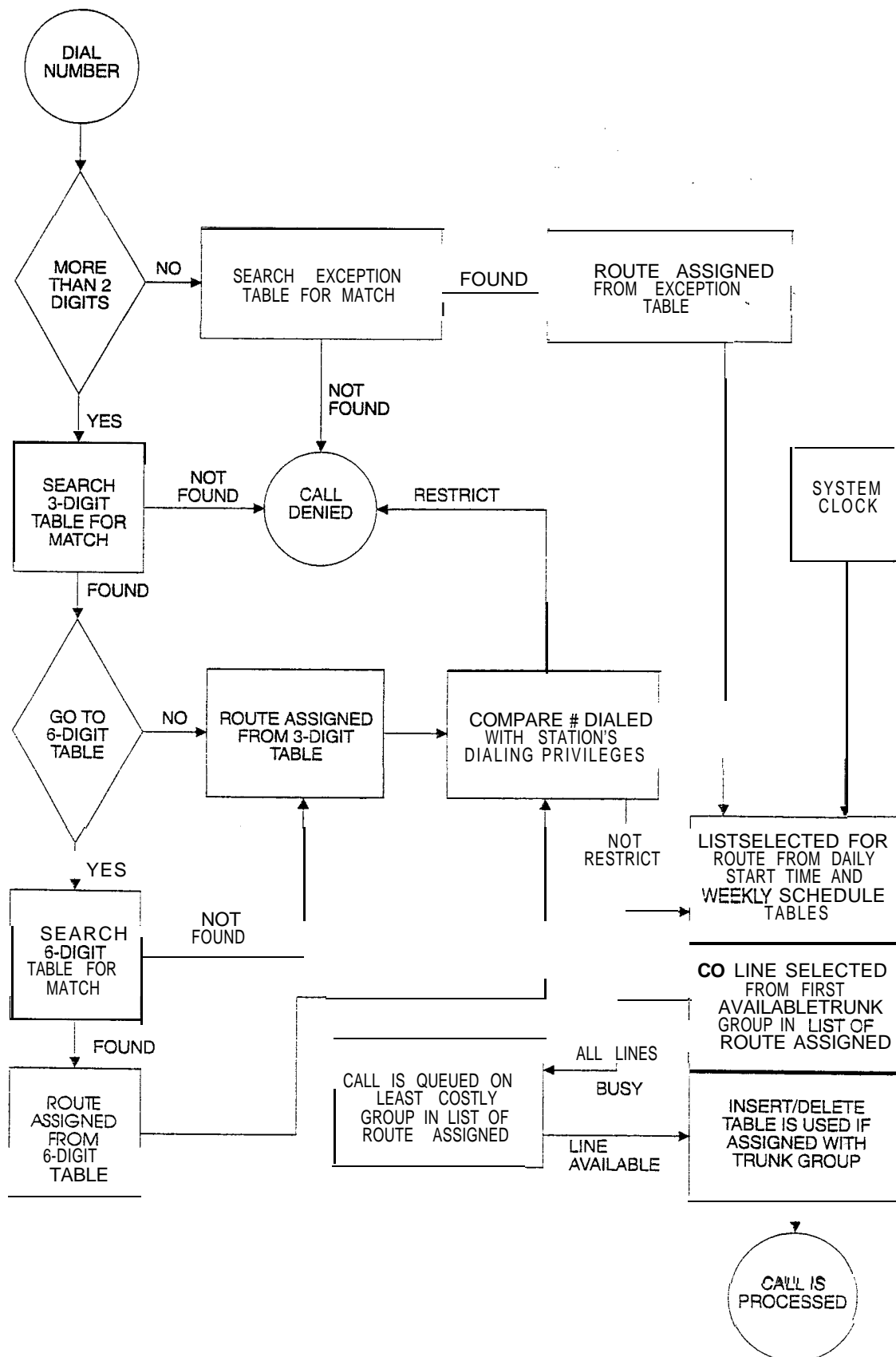

Figure 665-I LCR Flowchart



LCR PROGRAMMING (Cont'd)

665.2 LCR TABLES PROGRAMMING

Programming Steps

Description

If the system is in the programming mode, continue using the program codes. If starting to program here, enter the programming mode. Refer to Sec. 600.2, Program Mode Entry (Key Station).

To program the system for Least Cost Routing:

1. Press FLASH and dial [75]. The following message is shown on the display phone:

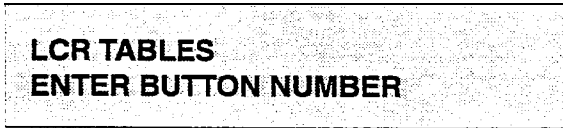

2. There are eight tables which can be programmed here for LCR (you must also program LCR Class of Service in Station Programming). Use the procedures listed below to program these LCR tables.

**NOTE** *It is extremely important that the worksheets be completed before programming the LCR tables.*

***This feature is available with optional software.***

The Least Cost Routing (LCR) feature allows for the automatic selection of the most economical trunk according to the number dialed and the time of day and day of the week. There are eight different tables which are set up to monitor the dialing of digits of a station and to select the best route programmed for the call. These tables are:

- 3-Digit Area/Office Code Routing Table
- 6-Digit Office Code Routing Table
- Exception Table
- Route List Table
- Insert/Delete Table
- Daily Start Time Table
- Weekday (Weekly) Schedule
- Toll Information Table

The buttons on the digital terminal are defined as shown below when entering the LCR Tables programming area:

1	Q	3-DIGIT TABLE		11	A
2	W	6-DIGIT TABLE	1	12	S
3	E	EXCEPTION TABLES		13	D
4	R	ROUTE LIST TABLE		14	F
5	T	INSERT/DELETE TABLE		15	G
6	Y	DAILY TIME TABLE		16	H
7	U	WEEKLY TIME TABLE		17	J
8	I	TOLL INFORMATION		18	K

Default: Refer to Figure 675-8 DB Printout of LCR Default for a complete listing of the LCR default data.

**Related Programming:** Refer to Sec. 610.2, System Features Programming, LCR Enable ; 630. 1, Station Attributes Programming, Station Class of Service (COS); and Sec. 630.1, LCR Class of service (COS).

LCR PROGRAMMING (Cont'd)

A. 3-Digit Area/Office Code Table

Programming Steps

1. Press 3-DIGIT TABLE flexible button (Button # 1). The following message will be shown on the display phone:



Where:

- L = [0] for non leading 1 ("1" not dialed)  
[1] for leading 1 ("1" is dialed)
  - NNN = area/office code
  - RR = route list number 00-1 5
  - Y = [0] do not go to 6-Digit table  
[1] go to 6-Digit table
  - PP = number of digits expected to be dialed.
2. Press the HOLD button to save the entry. Confirmation tone is heard and the display will now update.

Description

**3-Digit Area/Office Code Table.** This table is divided into two sections • Leading 1 (a [1] is dialed before the number) and Non Leading 1 (no [1] is dialed before the number). This gives the system the ability to handle call routing in areas that require a [1] before a long distance number, **as** well as in areas that do not require the [1].

Both of these tables include all area codes (NPA's), and office codes (NXX's), from 000 to 999, including such numbers **as** 911,411, etc. A complete entry into these tables include a route list table to be used, if the 6-Digit Table is to be checked and the number of digits likely to be dialed (example 7 digits or 10 digits).

All local office codes must be entered in this table even if they do not require long distance calling.

The number of digits to expect entry will aid the system in identifying when the last digit is dialed and to begin routing the call. This also helps to free SLT DTMF receivers if SLT traffic in the system is heavy.

For international calls, use "00" **as** number of digits to expect. This causes the system to wait five seconds after user dials last digit before the system accesses a CO line and dials out.

Appendix A-13 3-Digit Area/Office Code Route List Table

NON-LEADING (0) LEADING (1)	CODE (NNN)	RTE (RR)	6 DIG(6) (Y/N)	# DIG	NON-LEADING (0) LEADING (1)	CODE (NNN)	RTE (RR)	6 DIG(6) (Y/N)	# DIG
0					0				
1					1				
0					0				
1					1				
					0				
					1				
0					0				
1					1				
0					0				
1					1				
0					0				
1					1				
0					0				
1					1				
0					0				
1					1				
0					0				
1					1				
0					0				
1					1				
0					0				
1					1				

Figure 665-2 Ex: 3-Digit Area/Office Code Table Pgm Form



LCR PROGRAMMING (Cont'd)

C. Exception Code Table

Programming Steps

Description

1. Press EXCEPTION TABLES flexible button (Button #3). The following message will be shown on the display phone:

**Exception Table.** This table is used for operator calls and any other calls which would use a one-digit or two-digit entry, rather than a three-digit area code.

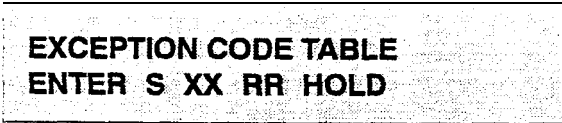

Where:

- S = [0] to remove code from table, [1] to add code to table
  - XX= exception codes for single digit codes, press MUTE button as 2nd digit).  
The digits [\*] and [#] may be entered as valid digits.
  - RR= route table number, 00-15
2. Press the HOLD button to save the entry. Confirmation tone is heard and the display will now update.
  3. Press Button #3 again for further entries. Up to 20 Exception codes may be programmed in this table.

Appendix A-15 LCR Exception Code Table

CODE #	EXCEPTION CODES (XX)	ROUTE (00-15) (RR)	CODE #	EXCEPTION CODES (XX)	ROUTE (00-15) (RR)
1			11		
2			12		
3			13		
4			14		
8			18		
9			19		
10			20		

Figure 665-4 Ex: Exception Code Table Pgm Form

## LCR PROGRAMMING (Cont'd)

## D. Route List Table

Programming Steps

1. Press the ROUTE LISTTABLE flexible button (Button #4). The following message will be shown on the display phone:

```
ROUTE LIST TABLE
ENTER RR T G DD L HOLD
```

Where:

- RR = Route List Table number 00-15
  - T = Time Period Route list 1-4
  - G = CO Line Group 1-7
  - DD = Insert/Delete Table reference 00-19 (## for none)
  - L = LCR Class of Service (LCOS)
2. Press the HOLD button to save the entry. Confirmation tone is heard and the display will now update.
  3. To enter additional CO line groups in the same time period route list number: Dial G DD L HOLD

To enter data for a different time period route list:

1. Press program button 4 and enter all data (RR T G DD L).
2. Repeat above to program a new Route Number 00 to 15 or press a flexible button to program other LCR information.

The following message will be shown on the display when the Call Cost feature has been enabled in Flash 05, Button #11.

```
ROUTE LIST TABLE
ENTER RR T CCC G DD L HOLD
```

Where:

- RR = Route List Table number 00-15
- T = Time Period Route list 1-4
- CCC = Cost for one minute \$0.00-\$9.99
- G = CO Line Group 1-7
- DD = Insert/Delete Table reference 00-19 (## for none)
- L = LCR Class of Service (LCOS)

Description

**Route List Table.** Up to 16 different Route list tables can be programmed. Each route list table contains four time period routing lists, one for each of the available (four) daily start time periods. Within each time period route list up to seven CO (outside) line groups and their corresponding Insert/Delete Table if any and LCR class of service priority are programmed on a per line group basis.

When routing a CO call through LCR, CO Line groups are accessed in sequence so that the first line group entered represents the least costly (and first selected) and the last line group entered represents the most costly (and last selected).

The Route List Table references many other tables when processing a call for routing. First of all, the Daily start time table is referenced to determine what start time entry should be checked in the weekly schedule table. The corresponding entry in the weekly schedule table depending on the day of the week then determines which Time Period Route list should be used within the Route List Table.

The system then begins to check for idle lines in the first entered CO line group and will proceed until an idle line is found. While it is searching for an idle CO line the Station LCR COS is checked against the entries for LCR COS Priority of the specific CO line groups (see LCR COS Priority explanation below). Once an idle CO line is found with a LCR priority equal to or higher than the stations LCR COS then a final check is made to determine if an Insert/Delete table should be referenced. Once all of the tables and entries are checked the system then processes the call on the outside CO line.

**NOTE**

*Make sure you have made entries into all Time Period Route List that are referenced in the weekly schedule table.*

**Related Programming:** Refer to Sec. 610.2, System Features Programming, Call Cost Display Feature programming.

LCR PROGRAMMING (Cont'd)

Route List Table (Cont'd)

Programming Steps

Description

**LCR COS Priority.** A station should be assigned a class of service for LCR. Refer to Sec. 630.1, Station Attributes Programming, LCR Class of service (COS). The LCR COS can be between 0 and 6, with 0 being unrestricted and 6 being the most restrictive. Within the time period route List Table, line groups are given an LCR COS Priority assignment between 0 and 6. A station using LCR will be able to use only those CO (outside) line groups with a priority assignment of equal or higher value than the station's LCR Class of Service (i.e. a station with LCOS 3 can use line groups with a priority of 3-6).

Table 665-I LCR Class of Service Table

Allowed Access to Route	LCR CO Line Group Priority							
	0	1	2	3	4	5	6	
S T A  L C R  C O S	0	Y	Y	Y	Y	Y	Y	
	1	N	Y	Y	Y	Y	Y	
	2	N	N	Y	Y	Y	Y	
	3	N	N	N	Y	Y	Y	
	4	N	N	N	N		Y	Y
	5	N	N	N	N	N	Y	Y
	6	N	N	N	N	N	N	Y

N= Cannot use Line Group  
 Y= Has access to Line Group

LEAST COST ROUTING (LCR) PROGRAMMING

LCR PROGRAMMING (Cont'd)

E. Insert/Delete Table

Programming Steps

1. Press INSERT/DELETE TABLE flexible button (button #5). The following message will be shown on the display phone:

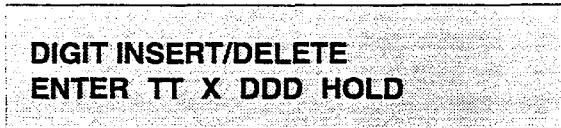

Enter the table information as follows;

Where:

- TT = Insert/Delete Table Number 00-19
- X = [0] Pre-Delete numbers (first digits dialed in the number),  
[1] Pre-Insert numbers (insert digits in front of number dialed),  
[2] Post-Insert numbers (insert digits behind number dialed)
- DDD = digits (up to 16-digits may be deleted from the beginning of the number dialed and up to 40 digits can be inserted (20 pre and 20 post)).

2. Press the HOLD button to save the entry. Confirmation tone is heard and the display will now update.

To add and delete numbers in the same table, enter the different insertion/deletion tables in step 1 and enter as separate entries using the same table number.

In the Insert Tables for LCR programming:

1. Press the TRANS button for a pause.
  - The [\*] and [#] digits are allowed as valid digits for inserting digits dialed over the network.
  - The [\*] and [#] are valid entries for adding digits in both the pre (in front of) or post (behind the number) tables.
  - The [\*] and [#] can not be used as delete characters in the Delete Tables.

To delete a Table, enter the Table number followed by the HOLD button.

Description

**insert/Delete Table.** Digits can be either added or deleted when dialing a number. For instance, if a user dials a long distance call that should be placed on a foreign exchange (FX) line, the digit [I] and the three-digit area code (NPA) dialed by the user must be deleted before the call can be placed on that FX line. An Insert/Delete Table can be programmed to do this. Digits can also be added to a number that has been dialed by the user. For instance, Other Common Carrier (OCC) access codes and authorization (ID) codes can be automatically inserted by the system either in front of and/or behind the number dialed.

There are 20 Insert/Delete Tables and each table allows for entries into a delete table and a pre and post insert table. Up to 40-digits (including pauses) can be inserted 20-pre and 20-post) and up to 16-digits can be deleted. Digits can be inserted before or after the number dialed but can be deleted only from the start of the number dialed.

Appendix A-12 Insert/Delete Tables

TABLE	DIGITS DIALED
00	INSERT PRE
	POST
	DELETE (PRE)
01	INSERT PRE
	POST
	DELETE (PRE)
02	INSERT PRE
	POST
	DELETE (PRE)
03	INSERT PRE
	POST
	DELETE (PRE)
04	INSERT PRE
	POST
	DELETE (PRE)
05	INSERT PRE
	POST
	DELETE (PRE)
06	INSERT PRE
	POST
	DELETE (PRE)
07	INSERT PRE
	POST
	DELETE (PRE)
08	INSERT PRE
	POST
	DELETE (PRE)
09	INSERT PRE
	POST
	DELETE (PRE)
10	INSERT PRE
	POST
	DELETE (PRE)
11	INSERT PRE
	POST
	DELETE (PRE)
12	INSERT PRE
	POST
	DELETE (PRE)

Figure 665-5 Ex: insert/Delete Pgm form

PROGRAMMING (Cont'd)

Daily Start Time Table

Programming Steps

1. Press the DAILY START flexible button (button #6). The following message will be shown on the display phone:

**DAILY START TIME TABLE**  
**HHMM HHMM HHMM HHMM HOLD**

2. Enter times in military form (2400 Hours) in succession.
3. Press the HOLD button to save the entry. Confirmation tone is heard and the display will now update. Default times are 0800, 1700, 2300 (8 AM, 5 PM, and 11 PM), and the fourth time is disabled (####). To change a start time all times must be re-entered. Four pounds [####] will be displayed if nothing is entered for a specific time.

Description

**Daily Start Time Table.** The daily start time table is used to correlate the LCR routing table to the time sensitive discount structure offered by the customer carrier. For example in the most common situation the most expensive rate period is between 8:00 am and 5:00 pm, often called the day rate. The first discount period usually starts at 5:00 pm and runs until 11:00 pm, often called Evening Rates. The remaining time (from 11:00 pm until 8:00 am) in this example is referred to as night time rates which usually has the biggest discount. With the wide selection of Common Carriers the least costly route for a particular area code may be different at different times of the day. To accommodate this situation, this table and the Weekly Schedule Table work together, dividing the day into four possible time periods. By default these tables are set at the standard divisions of 8AM, 5PM, and 11 PM. However, these times can be changed.

The entries in the Daily Start Time table are used to select the time period to reference in the weekly schedule. Based on the time a call is placed the daily start time table selects the time period to choose in the weekly schedule. The weekly schedule is then used to determine the time period route list in the Route List Table to use for routing the call for a particular day of the week.

The times are entered in the 24 hour format.

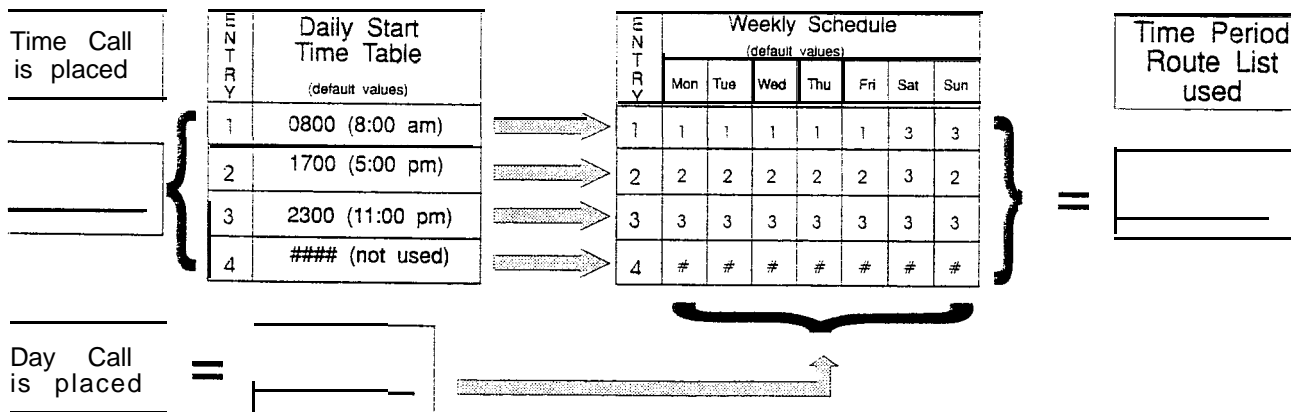

Figure 665-6 Daily Start Time & Weekly Schedule Tables



**LEAST COST ROUTING (LCR) PROGRAMMING**

**LCR PROGRAMMING (Cont'd)**

**G. Weekly Schedule Table**

Programming Steps

1. Press the WEEKLY SCHED flexible button (button #7). The following message will be shown on the display phone:

**WEEKLY SCHEDULE TABLE  
ENTER D TTTT HOLD**

Description

**Weekly Schedule Table.** The weekly schedule table determines what Time Period Route list to use within the Route List Table. When a call is placed and ultimately sent to a route list (call is not denied) based on the time of day the call is placed the Daily Start Time Table selects the time period to reference in the weekly schedule table. The time period route entered for the specified time period, as determined in the daily start time table and based on the day of week, is then selected and the call will be routed according to the specified time period route list.

Example:

- If a call is placed at 5:45 pm on a Monday then according to the daily start time table (using default values) the entry for time period two of the weekly schedule is checked. Because it is Monday the entry for time period two on Monday is used and the result is that the Time Period Route List number two (again using default values) will be used for all routes. Thus the call is routed according to the entries in Time Period Two route list no matter what route (00-15) is selected. Refer to Figure 665-7 Ex: Daily & Weekly Start Time Tables.

Where: D= Day of the Week

- [0] = Monday
- [1] = Tuesday
- [2] = Wednesday
- [3] = Thursday
- [4] = Friday
- [5] = Saturday
- [6] = Sunday

T = Time Period Route List (1-4) to use for the time of day (based on the daily start time table). Enter values for all time periods specified in the daily start time table for that day.

- 1 st T = Time Period Route list for the FIRST Daily Start Time.(applies to all Route List Tables)
  - 2nd T = Time Period Route List for the SECOND Daily Start Time.(applies to all Route List Tables)
  - 3rd T = Time Period Route List for the THIRD Daily Start Time.(applies to all Route List Tables)
  - 4th T = Time Period Route List for the FOURTH Daily Start Time.(applies to all Route List Tables)
2. Press HOLD button after each complete daily entry. Confirmation tone is heard and the display will now update.

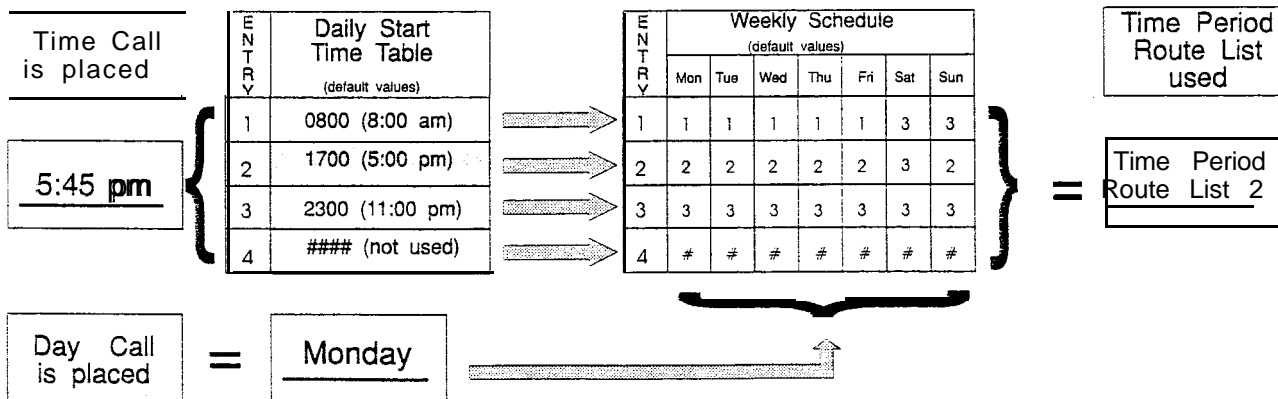

**Figure 665-7 Ex: Daily & Weekly Start Time Tables**

I PROGRAMMING (Cont'd)

H. LCR Routing for Toll Information

Programming Steps

1. Press TOLL INFO flexible button (button #8)  
 The following message will be shown on the display phone:

**LCR ROUTE FOR 555-1212  
 ENTER ROUTE**

2. Enter the two-digit Route List number (00-1 5) for the Route to be referenced in the Route List Table.
3. Press the HOLD button after programming the Route number. Confirmation tone is heard and the display will now update.
4. Enable LCR at this point. Refer to Sec. 610.2, System Features Programming, LCR Enable.

Description

This feature adds provisions to the LCR call processing which will allow common call routing for all toll information calls. 1 -(XXX)555-1 212, (XxX)555-1212, 1-555-1212 and 555-1212 calls will all be intercepted and sent to a selected route in the Route List Table. Numbers dialed will be integrated and if it is determined to be a toll information call, either preceded with an area code or without or with a leading digit 1 or not, the call will be sent to the route designated in programming.

**Default:** By default, Toll Information Calls will be to Route List Table zero (0) which will allow toll information calls to be placed on the system at default.

A Toll Information route will be chosen over a 3-Digit or 6-Digit route assignment if both are **assigned**.

Entering the pound key twice [##] will deny all Toll Information calls.

**NOTE** *Local information calls (555-1212 or 1-555-1212) must be programmed separately within the 3-Digit Area/Office Code Table.*

TOLL INFORMATION ROUTE LIST TABLE	DEFAULT 00	
-----------------------------------	---------------	--

Figure 665-8 Ex: LCR Toll Information Routing Pgm Form

LEAST COST ROUTING (LCR) PROGRAMMING

## LCR PROGRAMMING (Cont'd)

## I. Default LCR Database

Programming StepsDescription

In an effort to decrease installation and set up time, usually associated with LCR, a default LCR database has been incorporated. The default LCR database will provide basic routing for local and long distance dialing. Default entries have been made in the 3-Digit Table for local office codes (NNX's) and all area codes (NPA's). Six routes have been established with the default database for routing of all calls under default. The entire default database is shown in Figure 675-8 DB Printout of LCR Default.

## TABLE OF CONTENTS FOR SECTION 670

<b>SECTION 670</b>	<b>INITIALIZEDATABASEPARAMETERS .....</b>	<b>670-I</b>
670.1	INTRODUCTION .....	670-I
	A. Initialize System Parameters .....	670-2
	B. Initialize CO tine Attributes .....	670-5
	c. Initialize Station Attributes .....	<b>670-6</b>
	D. initialize Station and CO Port Parameters .....	<b>670-9</b>
	E. Initialize Exception Tables .....	670-I 0
	F. Initialize System Speed Numbers.. .....	670-I 1
	G. Initialize LCR Tables.. .....	670-t 2
	H. Initialize System Database and Reset (all parameters). .....	670-13
	I. Initialize ICLID Parameters .....	670-I 4
	J. Initialize Directory Dialing Table Parameters.. .....	670-I 5
	K. Initialize Hunt Group Parameters.. .....	670-I 6
	L. Initialize ACD or UCD Group Parameters.. .....	<b>670-17</b>
	M. Initialize VM Group Parameters.. .....	670-I 8
	N. System Reset .....	670-I 9

# SECTION 670

## INITIALIZE DATABASE PARAMETERS

### 670.1 INTRODUCTION

#### Programming Steps

If the system is in the programming mode, continue using the program codes. If starting to program here, enter the programming mode. Refer to Sec. 600.2, Program Mode Entry (Key Station).

If Database Parameters need to be initialized:

1. Press FLASH and dial [80]. The following message will be shown on the display of a display phone:

**INITIALIZE DATA-BASE  
 ENTER BUTTON NUMBER**

#### Description

This section describes the procedures and steps necessary to initialize the system database returning any programmed data to its original or default value. The entire system **database** may be initialized or various portions of the database may be individually initialized. In addition to initialization of the entire database, a system reset (Button #20) command is also included in this section for clearing meantime errors without initializing the database.

The buttons on the key telephone are defined as shown below when entering the Initializing Data-Base Parameters programming area:

1	a	SYSTEM PARAMETERS	HUNT GROUPS	11 A
2	W	CO LINE ATTRIBUTES	ACD* or UCD GROUPS	12 S
3	E	STATION ATTRIBUTES	VOICE MAIL* GROUPS	13 D
4	R	PORT - ST/CCO		14 F
5	T	EXCEPTION TABLES		15 G
6	Y	SYSTEM SPEED		16 H
7	U	LCR* TABLES		17 J
8	I	ENTIRE SYSTEM		18 K
	SO	ICLD* TABLES		19 L
10	P	DIRECTORY DIAL TABLES	RESET	20 ;

\*Features available with optional software.

**INITIALIZE DATABASE PARAMETERS****INIT DATABASE PARAMETERS (Cont'd)****A. Initialize System Parameters**Programming StepsDescription

If System Parameters need to be initialized:

1. Press the System Parameters flexible button (Button #1). The following message will be shown on the display phone:

**INITIALIZE SYS PARAM  
PRESS HOLD**

The system parameters may be initialized setting all data fields to their original, default values. The following data fields are returned to their default values upon initializing the System parameters.

2. To initialize the system parameters, press the HOLD button. Confirmation tone is heard.

PROGRAM CODE	FLEX BUTTON	FEATURE	DEFAULT VALUE (after initializing)
FLASH01	1	System Hold Recall	060seconds
	2	Exclusive Hold Recall	180 seconds
	3	Attendant Recall Timer	01 minutes
	4	Transfer Recall Timer	045 seconds
	5	Preset Forward Timer	10 seconds
	6	Call Forward No Answer	015 seconds
	7	Pause Timer	2 seconds
	8	Call Park Timer	180 seconds
	9	Conference/DISA Timer	10 minutes
	10	Paging Timeout Timer	15 seconds
	11	CO Ring Detect Timer	300 milliseconds
	12	DISA/SLT Receiver Timer	020seconds
	13	MSG Wait Reminder Tone	000 minutes
	14	SLT Hook-flash Timer	10 (1 seconds)
	15	SLT Hook-flash Debounce	010 (.1 second)
	16	SMDR Call Qualification Timer	30 sec.
	17	Auto Call Back Timer	00 sec. (disabled)
	18	Reminder Ring Timer	00 sec. (one burst)
	19	Release Guard Timer	300 milliseconds
FLASH 05	1	Attendant Override	Disabled
	2	Hold Preference	System HOLD
	3	External Night Ringing	Disabled
	4	Executive Warning Tone	Enabled
	5	Page Warning Tone	Enabled..
	6	Background Music	Enabled
	7	LCR Enable	Disabled
	8	Forced Account Codes	Disabled
	9	Group Listening	Disabled
	10	Idle Speaker Mode	Disabled
	11	Call Cost Display Feature	Disabled
	12	Music On Hold	Enabled
	13	Handset Receiver Gain	Disabled

## INIT. DATABASE PARAMETERS (Cont'd)

## Initialize System Parameters (Cont'd)

<u>Program</u>	<u>Program</u>	<u>Description</u>	
PROGRAM CODE	FLEX BUTTON	FEATURE	DEFAULT VALUE (after initializing)
FLASH 05	14	Call Qualifier Tone Option	Disabled
ADDITIONAL SYSTEM FEATURES:			
FLASH 06	1	Barge-in Warning Tone	Enabled
SYSTEM FLASH RATES:			
FLASH 07	1	Incoming CO Line Ringing	30 ipm flash
	2	incoming Intercom Ringing	120 ipm flutter
	3	Call Forward	30 ipm flash
	4	Message Waiting	15 ipm flash
FLASH 10		Attendant Assignment	STA 100
FLASH 11	1-4	Time and Date Format	12 HR. M/D/Y
FLASH 12		PBX Dialing Codes	None
FLASH 13	1	Exec/Secy Pair #1	None
	2	Exec/Secy Pair #2	None
	3	Exec/Secy Pair #3	None
	4	Exec/Secy Pair #4	None
FLASH 14	1	Relay #1	None
	2	Relay #2	None
	3	Relay #3	None
	4	Sensor #1	None
	5	Sensor #2	None
	6	Sensor #3	None
	7		
	a	Stations	None
	11		
	12	Relay/Sensor #1	None
	13	Relay/Sensor #2	None
	14	Relay/Sensor #3	None
	15	Relay/Sensor #4	None
FLASH 15	1	Port #1 ("On-Board" RS-232C)	2400
	2	Port #2 ("On-Board" Modem)	1200
	3	Port #3 (Backplane RS-232C)	2400
	4	Port #4 (Backplane RS-232C)	2400
FLASH 20	1	DISA Access Code	000
	2	Data Base Admin. Access	[DBAM] 3226
FLASH 21	1	SMDR	NO (disabled)
	2	Reported Call Type	LD only
	3	Print Format	80 column
	4	SMDR Baud Rate	2400
	5	SMDR Reporting Port	Port #1

**INITIALIZE DATABASE PARAMETERS****INIT. DATABASE PARAMETERS (Cont'd)****Initialize System Parameters (Cont'd)**

<u>Programming Steps</u>		<u>Description</u>	
PROGRAM CODE	FLEX BUTTON	FEATURE	DEFAULT VALUE (after initializing)
FLASH22	1	Night Mode Operation	Manual
	2	ANM Schedule - Mon.	08:00/1 7:00
	3	ANM Schedule - Tues.	08:00/1 7:00
	4	ANM Schedule - Wed.	08:00/1 7:00
	5	ANM Schedule - Thur.	08:00/1 7:00
	6	ANM Schedule - Fri.	08:00/1 7:00
	7	ANM Schedule - Sat.	##:##/##:###
	8	ANM Schedule - Sun.	##:##/##:###
FLASH 23	1-4	Directory Dialing Table	None
FLASH 24	1-12	Flexible Card Assignments	4 Station, 4 CO Line, 4 Station



INIT. DATABASE PARAMETERS (Cont'd)

B. Initialize CO Line Attributes

Programming Steps

Description

If CO Line Attributes need to be initialized:

1. Press the CO Line Attributes flexible button (Button #2). The following message will be shown on the display phone:

The CO Line parameters may be initialized setting all data fields to their original, default values. The following data fields are returned to their default value upon initializing the CO Line parameters.

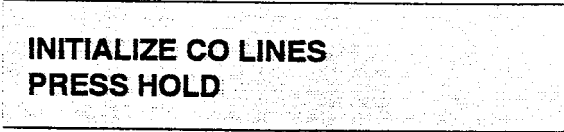

2. To initialize the CO Line Attributes, press the HOLD button. Confirmation tone will be heard.

PROGRAM CODE	FLEX BUTTON	FEATURE	DEFAULT VALUE (after initializing)
FLASH 40	1	DTMF/Pulse Signaling	ALL Lines set for DTMF
	2	CO/PBX Marking	ALL Lines set for CO
	3	Universal Night Answer	Enabled on all Lines
	4	DISA TRK-to-TRK (Conf)	Enabled on all Lines
	5	Automatic Privacy	Enabled on all lines
	6	Loop Supervision	NO (disabled on all lines)
	7	DISA Operation	NO (disabled on all lines)
	8	Flash Time	10 (1 second)
	9	Line Group Assignment	All Lines are in Group 1
	10	Line Class of Service	All Lines assigned COS1
	11	! CO Line Ring Assignment	All Lines Ring at STA 100
	12	CO Line Identification	None
	13	Trunk Direction	Incoming-Outgoing
	14	Ring Delay Timer	00 (disabled)
FLASH 41	1	Dial Pulse Break/Make Ratio	60/40

**INITIALIZE DATABASE PARAMETERS**

**INIT. DATABASE PARAMETERS (Cont'd)**

**C. Initialize Station Attributes**

Programming Steps

Description

If Station Attributes need to be initialized:

The Station parameters may be initialized setting all data fields to their original, default values. The following data fields are returned to their default value upon initializing the Station parameters.

1. Press the Station Attributes flexible button (Button #3). The following message will be shown on the display phone:

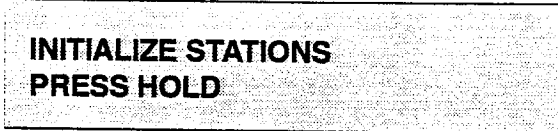

2. To initialize the Station Attributes, press the HOLD button. Confirmation tone will be heard.

PROGRAM CODE	FLEX BUTTON	FEATURE	DEFAULT VALUE (after initializing)
FLASH 50, Page "A"	A/1	Page Access	Allowed
	A/2	Do Not Disturb	Allowed
	A/3	Conference	Allowed
	A/4	Executive Override	Not Allowed
	A/5	Privacy Release	Not Allowed
	A/6	System Speed Dial	Allowed
	A/7	Line Queuing	Allowed
	A/8	Preferred Line Answer	Not Allowed
	A/9	Off-Hook Voice-Over	Not Allowed
	A/10	Call Forward	Allowed
	All 1	Forced LCR	Not Allowed
	A/12	ACD* Supervisor Barge-In	Not Allowed
	All 3	Executive Override Blocking	Allowed at all stations
	A/14	CO Line Ringing Options	Muted Ringing allowed
FLASH 50, Page "B"	B/1	Station ID	All Key Stations default to Station ID 0 (keyset), All Single Line Telephones and OPX's default to ID 5 (SLT w/o MSG Wait)
	B/2	Station Class of Service	All Stations assigned COS 1
	B/3	Speakerphone Option	All Stations assigned option 1
	B/4	Pick-Up Group(s)	All Stas assigned into Group 1
	B/5	Paging Zone(s)	All Stas assigned into Zone 1
	B/6	Preset Forward Destination	None assigned
	B/7	CO Line Group Access	All Sta assigned access to Group 1
	B/8	LCR Class of Service	All Stations given an LCR COS of 0
	B/9	Off-Hook Preference	Is allowed to all stations with the ability to change the assignment
	B/10	Flex Button Assignment	See default button assignment

Features available with optional software.

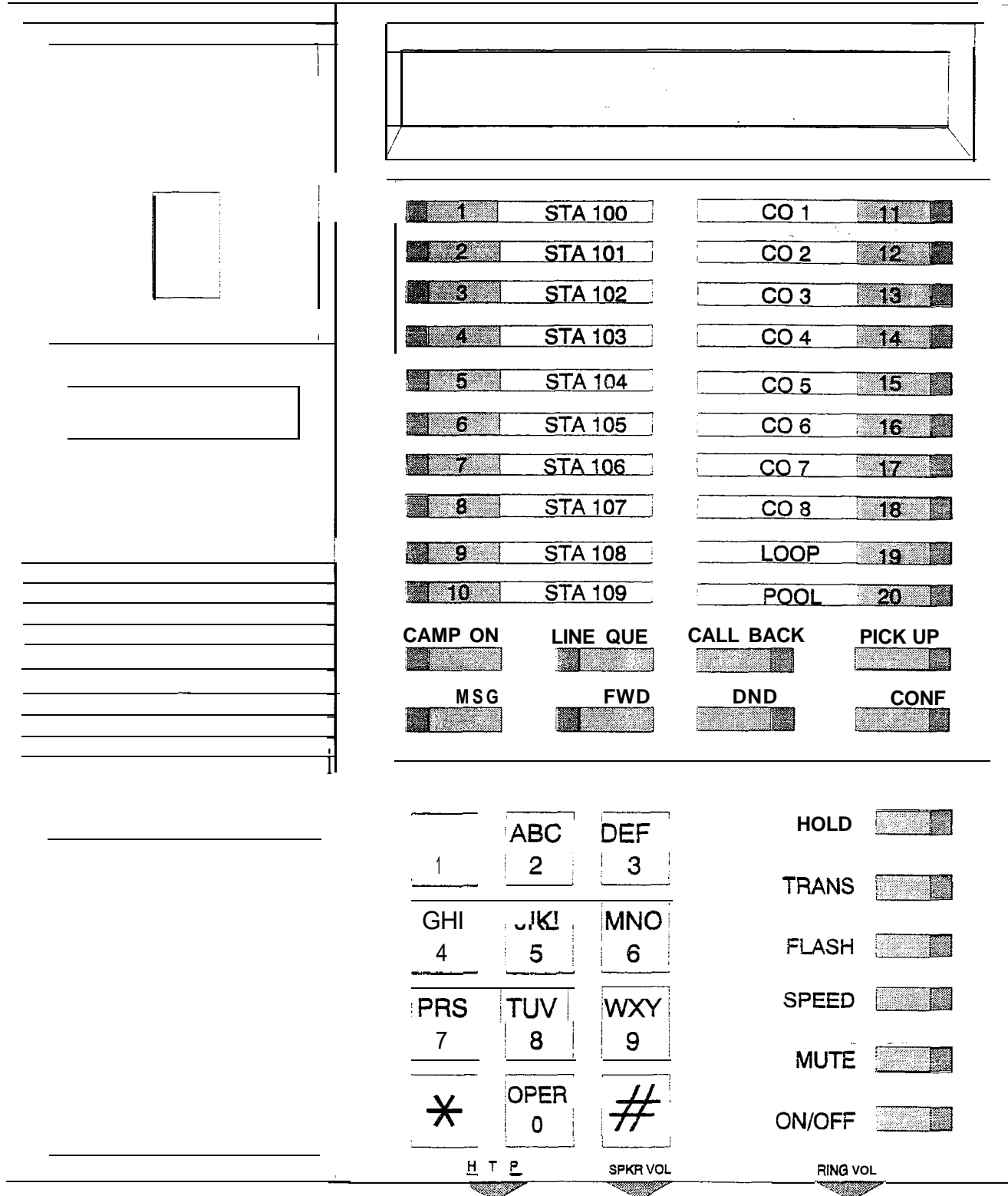

Figure 670-I 34-Button Default Button Mapping

INITIALIZE DATABASE PARAMETERS

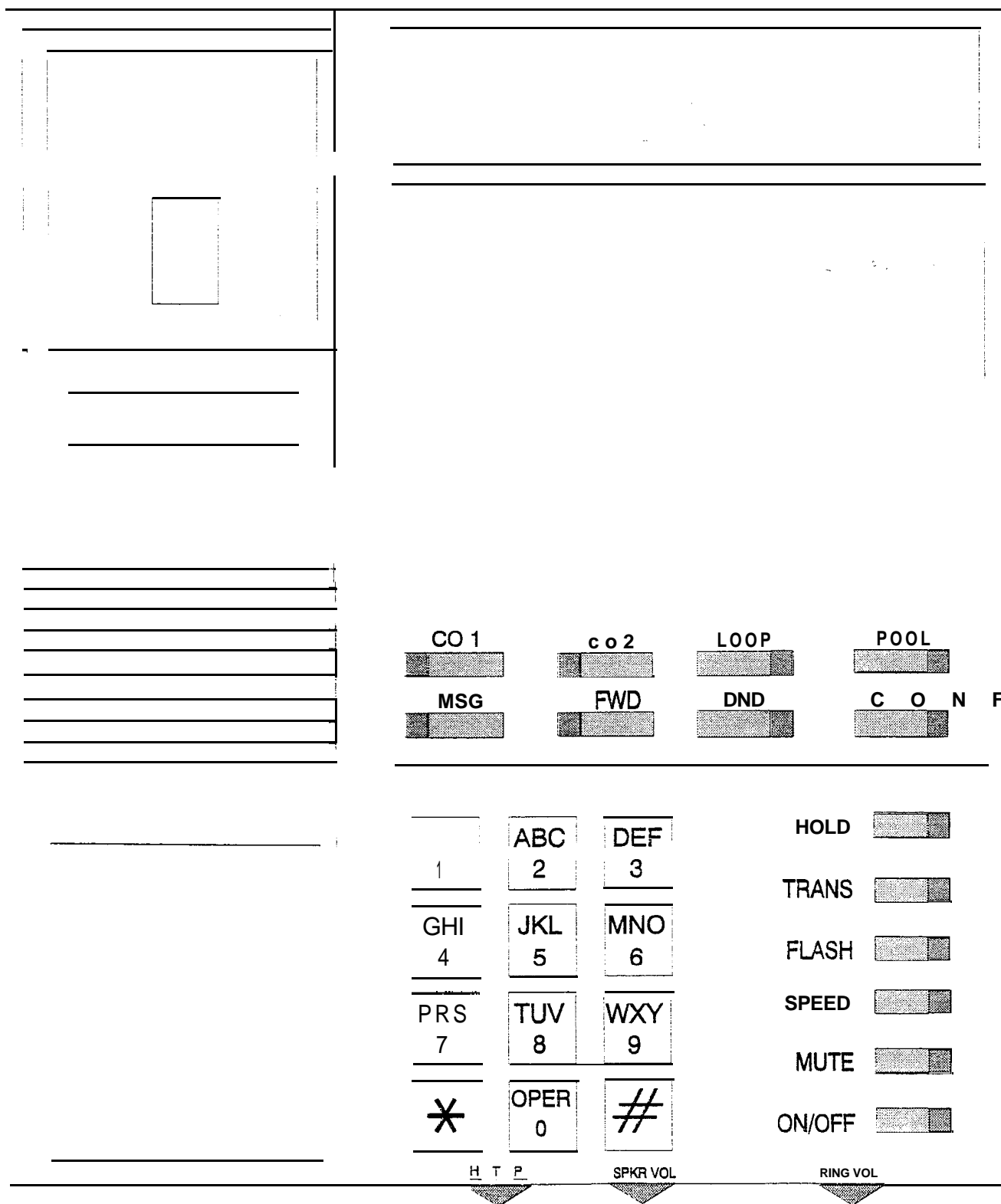

Figure 670-2 14-Button Default Button Mapping

INIT. DATABASE PARAMETERS (Cont'd)

D. Initialize Station and CO Port Parameters

Programming Steps

Description

If Group Parameters need to be initialized:

1. Press the Station/CO Port Parameters flexible button (Button #4). The following message will be shown on the display phone:

Station and CO Port parameters may be initialized setting all stations and all CO Lines back to their original, default values. The following data fields are returned to their default values upon initializing the CO/Station Port parameters.

**INITIALIZE PORT - STA/CO  
 PRESS HOLD**

2. To initialize the Station/CO Port parameters, press the HOLD button. Confirmation tone will be heard.

PROGRAM CODE	FLEX BUTTON	FEATURE	DEFAULT VALUE (after initializing)
FLASH 42	1	Card Slot #1 - Ports 1-12	CO Lines 1-12
	2	Card Slot #2 - Ports 13-24	CO Lines 13-24
	3	Card Slot #3 - Ports 25-36	CO Lines 25-36
	4	Card Slot #4 - Ports 37-48	CO Lines 37-48
FLASH 52	1	Card Slot #1 - Ports 1-12	Stations 100-111
	2	Card Slot #2 - Ports 13-24	Stations 112-123
	3	<del>Card Slot #3 - Ports 25-36</del>	<del>Stations 124-135</del>
	4	Card Slot #4 - Ports 37-48	Stations 136-1 47
	5	Card Slot #5 - Ports 49-60	Stations 148-1 59
	6	Card Slot #6 - Ports 61-72	Stations 160-1 71
	7	Card Slot #7 - Ports 73-84	Stations 172-1 83
	8	Card Slot #8 - Ports 85-96	Stations 184-1 95

**INITIALIZE DATABASE PARAMETERS****INIT. DATABASE PARAMETERS (Cont'd)****E. Initialize Exception Tables**Programming StepsDescription

If Exception Tables need to be initialized:

1. Press the Exception Tables flexible button (Button #5). The following message will be shown on the display phone:

**INITIALIZE EX TABLES  
PRESS HOLD**

The Exception Table parameters including the Allow/Deny Tables and the Special Tables may be initialized setting all tables to their original, default values. The following Tables are cleared returning to their default value upon initializing the Exception Tables parameters:

2. To initialize the Exception Tables, press the HOLD button. Confirmation tone will be heard.

PROGRAM CODE	FLEX BUTTON	FEATURE	DEFAULT VALUE (after initializing)
FLASH 70	1	Allow Table - A	Table Cleared (no entries)
	2	Deny Table - A	Table Cleared (no entries)
	3	Allow Table - B	Table Cleared (no entries)
	4	Deny Table - B	Table Cleared (no entries)
	5	Special Table 1	Table Cleared (no entries allowed, no area code specified)
	6	Special Table 2	Table Cleared (no entries allowed, no area code specified)
	7	Special Table 3	Table Cleared (no entries allowed, no area code specified)
	8	Special Table 4 (home Area Code)	Table Cleared (no entries allowed)
	9	Area Code Table 1	
	10	Area Code Table 2	
	11	Area Code Table 3	
		Display Tables	

INIT. DATABASE PARAMETERS (Cont'd)

F. Initialize System Speed Numbers

Programming Steps

Description

If System Speed bins need to be initialized:

1. Press the System Speed flexible button (**Button #6**). The following message will be shown on the display phone:

**INITIALIZE SYS SPEED NO  
PRESS HOLD**

Numbers entered into the System Speed dial Table may be initialized clearing all bins to their original, default value (empty). All bins 20 through 99 are cleared returning to their default value (empty) upon initializing the Speed Dial Table.

2. To initialize the System Speed bins, press the HOLD button. Confirmation tone will be heard.

**INITIALIZE DATABASE PARAMETERS****INIT. DATABASE PARAMETERS (Cont'd)****G. Initialize LCR Tables**Programming StepsDescription

If LCR Tables need to be initialized:

1. Press the LCR\* Tables flexible button (Button #7). The following message will be shown on the display phone:

**INITIALIZE LCR TABLES**  
PRESS HOLD

2. To initialize the LCR\* Tables, press the HOLD button. Confirmation tone will be heard.

***This feature is available with optional software.***

The LCR\* Tables may be initialized setting all tables to their original, default values. The following tables will be reset to their original default value after initialization of the LCR tables:

- 3-Digit Table
- 6-Digit Table
- Exception Table
- Route List Table
- Insert/Delete Table
- Daily Start Time Table
- Weekly Schedule
- Toll Information Route

PROGRAM CODE	FLEX BUTTON	FEATURE	DEFAULT VALUE (after initializing)
FLASH 75	1	3-Digit Routing Table	Table Cleared (no entries)
	2	6-Digit Routing Table	Table Cleared (no entries)
	3	Exception Table	Table Cleared (no entries)
	4	Route List Table	Table Cleared (no entries)
	5	Insert/Delete Table	Table Cleared (no entries)
	6	Daily Start Time Table	Table Cleared (no entries)
	7	Weekday (Weekly) Schedule	Table Cleared (no entries)
	8	Toll Information Table	Table Cleared (no entries)

\*Features available with optional software.



**INITIALIZE DATABASE PARAMETERS (Cont'd)**

**I-I. Initialize System Database and Reset (all parameters)**

Programming Steps

Description

If System needs to be initialized:

1. Press the System and Reset flexible button (Button #8). The following message will be shown on the display phone:

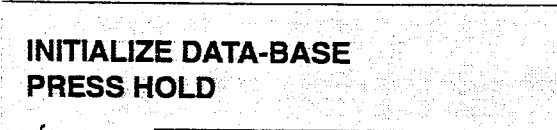

To completely initialize the database area including all non-programmable parameters held in Static RAM (SRAM) and reset the system also clearing any meantime errors that may exist this command may be used. The system will require reprogramming of any customer specific data after using this command. This provides an easy way to re-initialize the system and clearing any meantime errors that may have accumulated inhibiting system operation or

performance.

2. To initialize the entire system database, press the HOLD button. The system will perform a hard reset.

**INITIALIZE DATABASE PARAMETERS****INIT. DATABASE PARAMETERS (Cont'd)****1. initialize ICLID Parameters**Programming StepsDescription

If the ICLID\* Table(s) need to be initialized:

1. Press the ICLID\* TABLE flexible button (Button #9). The following message will be shown on the display phone:

**INITIALIZE ICLID  
PRESS HOLD**

***This feature is available with optional software.***

The ICLID\* Tables parameters may be initialized setting all data fields to their original, default values.

2. To initialize the ICLID\* Table(s), press the HOLD button. Confirmation tone will be heard.

PROGRAM CODE	FLEX BUTTON	FEATURE	DEFAULT VALUE (after initializing)
FLASH 43	1	ICLID* Ringing Assignments	No stations are assigned
FLASH 56	1	ICLID* Enable/Disable	Disabled
	2	ICLID* Name Entry	Number is shown on LCD
	3	ICLID* Baud Rate Display	2400 Baud
	4	ICLID* Port Assignment	Port #1

\*Features available with optional software.

INIT. DATABASE PARAMETERS (Cont'd)

J. Initialize Directory Dialing Table Parameters

Programming Steps

Description

If Directory Dialing Table Parameters need to be initialized:

The Directory Dialing Table parameters may be initialized setting all data fields to their original, default values.

1. Press the Directory Dialing Table Parameters flexible button (Button #10). The following message will be shown on the display phone:

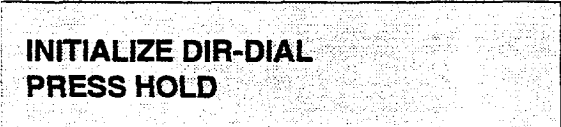

2. To initialize the Directory Dialing Table parameters, press the HOLD button. Confirmation tone will be heard.

PROGRAM CODE	FLEX BUTTON	FEATURE	DEFAULT VALUE (after initializing)
FLASH 23		Directory Dialing List	
	1	Bin/ICM	
	2	Name Entry	
	3	Clear Entry	
	4	Back Space	
FLASH 55		Local Number/Name Translation Table	
	1	Route Number	
	2	Phone Number	
	3	Name	
	4	Clear Entry	
		Back Space	

**INITIALIZE DATABASE PARAMETERS**

**INIT. DATABASE PARAMETERS (Cont'd)**

**K. Initialize Hunt Group Parameters**

Programming Steps

Description

If Group Parameters need to be initialized:

Hunt Group parameters may be initialized setting all data fields to their original, default values.

1. Press the Hunt Group Parameters flexible button (Button #1 1). The following message will be shown on the display phone:



2. To initialize the Hunt Group parameters, press the HOLD button. Confirmation tone will be heard.

PROGRAM CODE	FLEX BUTTON	FEATURE	DEFAULT VALUE (after initializing)
FLASH 30	1-8	Hunt Groups 450-457	No Hunt Groups established
	9	Station or Pilot Hunting	All Hunt Groups default using Pilot Hunting

INIT. DATABASE PARAMETERS (Cont'd)

L. Initialize ACD or UCD Group Parameters

Programming Steps

Description

If ACD\* or UCD Group Parameters need to be initialized:

*This feature is available with optional software.*  
ACD\* or UCD Group parameters may be initialized setting all data fields to their original, default values.

1. Press the ACD\* or UCD Group Parameters flexible button (Button #12). The following message will be shown on the display phone:

**INITIALIZE ACD GROUP  
PRESS HOLD**

2. To initialize the ACD\* or UCD Group parameters, press the HOLD button. Confirmation tone will be heard.

PROGRAM CODE	FLEX BUTTON	FEATURE	DEFAULT VALUE (after initializing)
FLASH 60	A/1-8	ACD*/UCD Groups 550-557	No Groups established
	A/9	Alternate ACD*/UCD Group Assignments	No Alternates group assignments is made
	A/10	ACD*/UCD Overflow Assignment	No Overflow assignment is made
	A/11	ACD*/UCD RAN Announcement Table Assignments	No RAN tables are specified
	A/12	ACD* Supervisor Programming	No Supervisor assigned
	B/1-8	ACD*/UCD Station Assignments	No stations are assigned
FLASH 61	1	ACD*/UCD Ring Timer	060seconds
	2	ACD*/UCD Message Interval Timer	060seconds
	3	ACD*/UCD Overflow Timer	060seconds
	4	ACD*/UCD Wrap-Up Timer	004seconds
	5	ACD*/UCD No Answer Recall	000 seconds (disabled)
	6	ACD*/UCD No Answer Retry	300seconds
	7	ACD* Guaranteed Msg Timer	10 seconds
FLASH 62	1-8	RAN Tables 1 through 8	No RAN parameters set
FLASH 64	A/1 -8	ACD* Groups 558-565	No ACD groups established
	A/9	Alternate ACD* Group Assignments	No ACD Alternates group assignments is made
	A/10	ACD* Overflow Assignment	No Overflow assignment is made
	A/11	ACD* RAN Announcement Table Assignments	No RAN tables are specified
	A   1 2	ACD* Supervisor Programming	No Supervisor assigned
	B/1-8	ACD* Station Assignments	No stations are assigned

\*Features available with optional software

**INITIALIZE DATABASE PARAMETERS****INIT. DATABASE PARAMETERS (Cont'd)****M. Initialize VM Group Parameters**Programming StepsDescription

If VM\* Group Parameters need to be initialized:

1. Press the VM\* Group Parameters flexible button (Button #13). The following message will be shown on the display phone:

**INITIALIZE VM GROUP  
PRESSHOLD**

***This feature is available with optional software.***

VM\* Group parameters may be initialized setting all data fields to their original, default values.

2. To initialize the VM\* Group parameters, press the HOLD button. Confirmation tone will be heard.

PROGRAM CODE	FLEX BUT-TON	FEATURE	DEFAULT VALUE (after initializing)
FLASH 65	1-8	Voice Mail* Groups 440-447	No Voice Mail groups are established
	9	Alternate Voice Mail* Group Assignments	No Alternate VM group assignment is made
	10	Leave Table	No outpulsing table is referenced
	11	Retrieve Table	No outpulsing table is referenced
	12	Voice Mail * Station Assignments	NO stations are assigned
FLASH 66	1-7	Voice Mail* Out-Pulsing Tables , for in-band signaling	Out-pulse tables are empty by default
	8	Voice Mail* Disconnect Table	Disconnect table is empty
FLASH67	1	In-Band Digits for Incoming CO Calls	Disabled by default
	2	Voice Mail* Transfer/Forward	Disabled by default

\*Features available with optional software.

INIT. DATABASE PARAMETERS (Cont'd)

N. System Reset

Programming Steps

Description

If the system needs to be reset but not initialized:

1. Press the **RESET flexible** button (Button #20).  
The following message will be shown on the display phone:

This feature provides a hard system reset from the **keyset** instead of the KSU. This is useful in cases where miscellaneous data errors have occurred and the system needs to be reset without initializing the entire database.



2. To reset the system without initializing the database, press the HOLD button. No Confirmation tone will be heard and the system will now reset.

## TABLE OF CONTENTS FOR SECTION 675

<b>SECTION 675</b>	<b>PRINTING SYSTEM DATABASE PARAMETERS .....</b>	<b>675-I</b>
<b>675.1</b>	INTRODUCTION .....	675-I
	A. Printing System Parameters .....	675-2
	B. Printing CO Line Attributes .....	675-4
	C. Printing Station Attributes .....	675-6
	D. Printing CO and Station Port Parameters.. ..	675-8
	E. Printing Exception Tables .....	675-I 0
	F. Printing System Speed Bins .....	675-I 2
	G. Printing LCR Tables.. ..	675-I 4
	H. Printing Entire System Data Base .....	675-23
	I. Printing ICLID Tables.. ..	675-24
	J. Printing Directory Dialing Table Parameters.. ..	675-27
	K. Printing Hunt Group Parameters .....	675-29
	L. Printing ACD or UCD Group Parameters .....	675-31
	M. Printing Voice Mail Group Parameters .....	675-33
	N. Abort Printing .....	675-35



# SECTION 675

## PRINTING SYSTEM DATABASE PARAMETERS

### 675.1 INTRODUCTION

#### Programming Steps

If the system is in the programming mode, continue using the program codes. If starting to program here, enter the programming mode. Refer to Sec. 600.2, Program Mode Entry (Key Station).

If **DataBase** Parameters need to be printed:

1. Press FLASH and dial [85]. The following will be shown on the display phone:

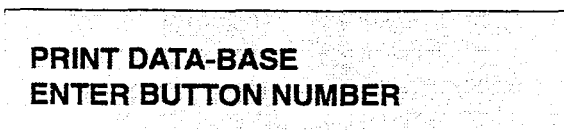

2. Choose the portion of the database to be printed by pressing the appropriate button in the flexible button field.

#### Description

This section describes the procedures and steps necessary to print Data Base Parameters and various portions of the **system**.

The buttons on the key telephone are defined as shown below when entering the Print Data Base Parameters programming area.

1	Q	SYSTEM PARAMETERS	HUNT GROUPS	11	A
2	W	CO LINE ATTRIBUTES	ACD* or UCD GROUPS	12	S
3	E	STATION ATTRIBUTES	VOICE MAIL* GROUPS	13	D
4	R	PORT - STACO		14	F
	ST	EXCEPTION TABLES		18	Q
6	Y	SYSTEM SPEED		18	H
7	U	LCR TABLES		17	J
8	I	ENTIRE SYSTEM		18	K
9	O	ICLD* TABLES		19	L
10	P	DIRECTORY DIAL TABLES	ABORT PRINTING	20	;

\*Features available with optional software.

With a printer connected to the RS-232C port (future) of the Central Processor Unit (CPU) or to either Port #3 or Port #4 on the I/O Expansion Module, the currently stored customer database can be printed or "uploaded" into a file. This command allows the entire database to be "dumped" as a permanent record which can serve as a hard copy of the database.

The system Baud rate must match that of the printer or receiving device.

Refer to the following Figures for examples of the database printouts. Also refer to the following paragraphs for instructions on printing only portions of the database.

**Default:** None

**Related Programming:** Refer to Sec. 610.8, Baud Rate Assignments, for setting the baud rate of the RS-232C port (future) on the Central Processor Unit (CPU), Port #3 or Port #4 on the I/O Expansion Module.

## System DataBase Printouts (Cont'd)

## A. Printing System Parameters

Programming StepsDescription

If a printout of all System Parameters is desired:

1. Press the SYSTEM PARAMETERS flexible button (Button #1). The following message will be shown on the display phone:

**PRINT SYS PARAM  
PRESS HOLD**

2. To print the system parameter database, press the HOLD button. The following message will be shown on the display phone:

**PRINTING SYS PARAM**

When the system has finished sending the information to the printer, confirmation tone will be heard.

**System Timers:**

SHR= System Hold Recall Timer  
 EHR= Exclusive Hold Recall Timer  
 ART= Attendant Recall Timer  
 XFR= Transfer Recall Timer  
 PFT= Preset Forward Timer  
 CFN= Call Forward No-Answer Timer  
 PT= Pause Timer  
 CPT= Call Park Timer  
 CFT= Conference Timer  
 PTO= Page Timeout Timer  
 COT= CO Ring Detect Timer  
 SRT= Single Line Receiver Timer  
 MWT= Message Wait Reminder Tone  
 HFT= Hook Flash Timer  
 HFD= Hookswitch Bounce Timer  
 CQT= SMDR Call Qualification Timer  
 ACB= Auto Call Back Timer  
 RR= Reminder Ring Timer  
 RG= Release Guard Timer

With a printer connected to the RS-232C port (future) on the Central Processor Unit (CPU) or to either Port #3 or Port #4 on the I/O Expansion Module, the currently stored customer database can be printed or "uploaded" into a file. This command allows the System Parameters database to be "dumped" as a permanent record which can serve as a hard copy. The system Baud rate must match that of the printer or receiving device.

When printing the System Parameters the following data is printed;

- All System Timers
- All System wide options (i.e. external night ringing, Hold preference etc...)
- Attendant programming
- Other system assignments (i.e. Page/Relay Assignments, Executive/Secretary, SMDR etc...)
- Weekly Night Mode schedule

Refer to the following Figure for an example of the system parameters database printout.

**Default:** None

**Related Programming:** Refer to Sec. 610.8, Baud Rate Assignments, for setting the baud rate of the RS-232C port on the Central Processor Unit (CPU), Port #3 or Port #4 on the I/O Expansion Module.

**System Features:**

AO=Attendant Override  
 SY= Hold Preference  
 ENR= External Night Ringing  
 EO=Exec Override Warn Tone  
 PW= Page Warning Tone  
 BGM= Background Music  
 LCR= LCR Enable/Disable  
 AC=Forced Account Codes  
 GL=Group Listening  
 S=Idle Speaker Mode  
 CC= Call Cost Display Feature  
 MH= Music On Hold  
 V= Handset Receiver Gain  
 Q= Call Qualifier Tone Option

SYSTEM PARAMETERS		RELAY/SENSOR ###
Eng. Ver. 2.3D-0FFF		1 NONE
SYSTEM TIMERS		2 NONE
SHR EHR ART XFR PFT CFN PT		3 NONE
60 180 1 45 10 15 2		4 NONE
		5 NONE
		6 NONE
CDT CFT PTO COT SRT MWT HFT		RELAY/SENSOR ###
180 10 15 3 20 0 10		1 NONE
		2 NONE
		3 NONE
HFD CQT AC3 RR RG		4 NONE
10 30 0 0 3		5 NONE
		6 NONE
SYSTEM FEATURES		RELAY/SENSOR ###
AO SY ENR EO PW BGM LCR		1 NONE
N Y N Y Y Y N		2 NONE
		3 NONE
		4 NONE
AC GL S CC MH V Q		5 NONE
N N N N Y N N		6 NONE
BARGE IN WARN TONE ENABLED		I/O BAUD RATE
		- -
SYSTEM LED FLASH RATES		Port 1 / On Board = 2400
INC CO RING 30 IPM FLASH		Port 2 / Modem = 1200
INC ICM RING 120 IPM FLUTTER		Port 3 / RS232 = 2400
CALL FORWARD 30 IPM FLASH		Port 4 / RS422 = 2400
MESSAGE WAITING 15 IPM FLASH		
ATTENDANT STATIONS		ACCESS CODE
100 ### ###		1 DISA ACCESS 100
		2 ADMIN PASSWORD 3226
DATE & TIME FORMAT		SDR TPE PNT BAUD PORT
MM/DD/YY, 12 HOURS		N LD 80 2400 1
PBX DIALING CODES		AUTO NIGHT MODE N
## ## ## ## ##		
EXECUTIVE/SECRETARY PAIRINGS		WEEKLY NIGHT MODE SCHEDULE
1 = ### ##		DAY END START
2 = ### ##		TIME TIME
3 = ### ##		M 0 0800 1700
4 = ### ##		T 1 0800 1700
		W 2 0800 1700
		T 3 0800 1700
		F 4 0800 1700
		S 5 #### ####
		S 6 #### ####
RELAY ASSIGNMENTS		DIAL PULSE
ON BOARD RELAY		RATIO SPEED
1 NONE		6040 10PPS
2 NONE		
3 NONE		SYSTEM SLOT TYPE
4 NONE		
5 NONE		S S S S C C C C S S S S
6 NONE		
RELAY/SENSOR ###		
1 NONE		
2 NONE		
3 NONE		
4 NONE		
5 NONE		
6 NONE		

Figure 675-I DB Printout of System Parameters

**System DataBase Printouts (Cont'd)**

**B. Printing CO Line Attributes**

Programming Steps

Description

If a printout of the CO Line Attributes is desired:

1. Press the CO LINE ATTRIBUTES flexible button (Button #2). The following message will be shown on the display phone:

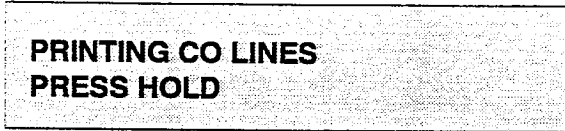

2. To print the data for ALL CO Lines, press the HOLD button. To print CO Line data for a specified CO Line Range enter four digits to specify the CO Line range (two digits for the first line within the range and two digits for the last line in the range i.e. [0115]). If a printout of only one line is desired enter that line twice (i.e. [0101]). Then press the HOLD button.
3. The following message will be shown on the display phone and the CO Line data will be printed:

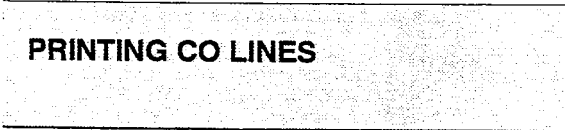

When the system has finished sending the requested information to the printer, confirmation tone will be heard.

With a printer connected to the RS-232C port (future) on the Central Processor Unit (CPU) or to either Port #3 or Port #4 on the I/O Expansion Module, the currently stored customer database can be printed or "uploaded" into a file. This command allows either a range of CO Lines or the entire CO Line database to be "dumped" as a permanent record which can serve as a hard copy of the CO Line attribute database .

The system Baud rate must match that of the printer or receiving device.

When printing the CO Line attributes the following data is printed:

- All CO Line parameters within the specified range.
- CO Line ringing assignments within the specified range.
- Dial Pulse Ratio and Speed settings

Refer to the following Figure for an example of the CO Line attribute database printout.

Default: None

**Related Programming:** Refer to Sec. 610.8, Baud Rate Assignments, for setting the baud rate of the RS-232C port on the Central Processor Unit (CPU), Port #3 or Port #4 on the I/O Expansion Module.

**Definition of Terms for CO Lines Printout**

SIGNAL= DTMF/Dial Pulse  
TYPE= CO/PBX  
UNA= Universal Night Answer  
PRI= CO Line Privacy  
SUPV= Loop Supervision  
DISA= Direct Inward System Access

FLTM= Flash Timer  
GRP= CO Line Group  
COS= CO Line Class of Service  
DIR= Trunk Direction  
RD= Ring Delay Timer

CO LINE ATTRIBUTES	
co 01	co 05
LINE 01	LINE 05
SIGNAL TYPE UNA CONF PRI	SIGNAL TYPE UNA CONF PRI
DTMF co Y Y Y	DTMF CO Y Y Y
SUPV DISA FLTM GRP COS DIR RD	SUPV DISA FLTM GRP COS DIR RD
N N 10 1 1 2 00	N N 10 1 1 2 J0
RING ASSIGNMENTS	RING ASSIGNMENTS
1009	100B
co 02	co 06
LINE 02	LINE 06
SIGNAL TYPE UNA CONF PRI	SIGNAL TYPE UNA CONF PRI
DTMF co Y Y Y	DTMF CO Y Y Y
SUPV DISA FLTM GRP COS DIR RD	SUPV DISA FLTM GRP COS DIR RD
N N 10 1 1 2 00	N N 10 1 1 2 00
RING ASSIGNMENTS	RING ASSIGNMENTS
100B	100B
co 03	co 07
j LINE 03	LINE 07
SIGNAL TYPE UNA CONF PRI	SIGNAL TYPE UNA CONF PRI
DTMF CO Y Y Y	DTMF CO Y Y Y
SUPV DISA FLTM GRP COS DIR RD	SUPV DISA FLTM GRP COS DIR RD
N N 10 1 1 2 00	N N 10 1 1 2 00
RING ASSIGNMENTS	RING ASSIGNMENTS
1003	100B
co 04	co 08
LINE 04	LINE 08
SIGNAL TYPE UNA CONF PRI	SIGNAL TYPE UNA CONF PRI
DTMF CO Y Y Y	DTMF CO Y Y Y
SUPV DISA FLTM GRP COS DIR RD	SUPV DISA FLTM GRP COS DIR RD
N N 10 1 1 2 00	N N 10 1 1 2 00
RING ASSIGNMENTS	RING ASSIGNMENTS
100B	100B
	... and so on thru CO Lines 48

Figure 675-2 DB Printout of CO line Attributes

**System DataBase Printouts (Cont'd)**

**C. Printing Station Attributes**

Programming Steps

Description

If a printout of the Station Attributes is desired:

1. Press the STATION ATTRIBUTES flexible button (Button #3). The following message will be shown on the display phone:

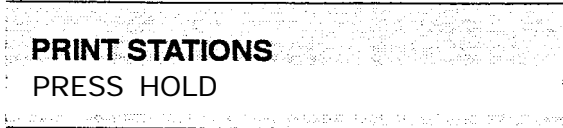

2. To print data for all stations, press the HOLD button. To print Station data for a specified Station Range enter six digits to specify the Station range (three digits for the first station within the range and three digits for the last station in the range i.e. [100109]). If a printout of only one station is desired enter that station twice (i.e. [101101]). Then press the HOLD button.
3. The following message will be shown on the display phone and the requested information will be printed:

---

PRINTING STATIONS

---

When the system has finished sending the requested information to the printer, confirmation tone will be heard.

**Page "A" Features:**

- PAGE= Paging Access
- DND= Do Not Disturb
- CONF= Conference
- EOR=Executive Override
- PRI= Privacy
- SPD= System Speed Dial Access
- QUE= Line Queue Access
- PLA= Preferred Line Answer
- OHVO=Off-Hook Voice Over
- FWD= Station Call Forward Access
- LCR= LCR Class of Service
- SUB= ACD Supervisor Monitor Barge-in
- REM= CO Line Ringing Options

With a printer connected to the RS-232C port (future) on the Central Processor Unit (CPU) or to either Port #3 or Port #4 on the I/O Expansion Module, the currently stored customer database can be printed or "uploaded" into a file. This command allows either a range of station data or all stations data information to be "dumped" as a permanent record which can serve as a hard copy of the station attribute database.

The system Baud rate must match that of the printer or receiving device.

When printing the Station attributes the following data is printed;

- All current station parameters

Refer to the following Figure for an example of a Station attribute database printout.

**Default:** None

**Related Programming:** Refer to Sec. 610.8, Baud Rate Assignments, for setting the baud rate of the RS-232C port on the Central Processor Unit (CPU), Port #3 or Port #4 on the I/O Expansion Module.

**Page "5" Features:**

- SID= Station ID
- AID= Associated ID (DSS/DLS Console)
- DCOS= Day Class of Service
- NCOS= Night Class of Service
- SPK= Speakerphone Option
- PICKUP= Pickup Groups
- PAGE= Paging Groups
- PREFWD= Preset Forward Assignment
- LCOS=LCR Class of Service
- BUTTONS= Refer to Table 630-2 Flexible Button Display Designations, Page 630-22.

<p>STATION ATTRIBUTES</p> <p><u>STA 100</u></p> <p>PAGE DND CONF EOR PRI SPD QUE              Y Y Y N/A Y Y Y              PLA OHVO FWD LCR SUB REM              N N Y N N N              SID AID DCOS NCOS SPK              0 1 1 0              PICKUP PAGE PREFWD LCOS              1 1 0              CO ACCESS 1</p> <p>BUTTONS</p> <p>01D100 02D101 03D102              04D103 05D104 06D105              07D106 08D107 09D108              10D109 11D110 12D111              13CO01 14CO02 15CO03              16CO04 17CO05 18CO06              19LP 20PL1 21CBK              22FWD 23DND 24CNF</p> <p>PRIME KEY 0 Y</p> <p><u>STA 101</u></p> <p>PAGE DND CONF EOR PRI SPD QUE              Y Y Y N/A Y Y Y              PLA OHVO FWD LCR SUB REM              N N Y N N N              SID AID DCOS NCOS SPK              0 1 1 0              PICKUP PAGE PREFWD LCOS              1 1 0              CO ACCESS 1</p> <p>BUTTONS</p> <p>01D100 02D101 03D102              04D103 05D104 06D105              07D106 08D107 09D108              10D109 11CO01 12CO02              13CO03 14CO04 15CO05              16CO06 17CO07 18CO08              19LP 20PL1 21CPO              22LQU 23CBK 24PKU              25MSG 26FWD 27DND              28CNF</p> <p>PRIME KEY 0 Y</p>	<p><u>STA 102</u></p> <p>PAGE DND CONF EOR PRI SPD QUE              Y Y Y N/A Y Y Y              PLA OHVO FWD LCR SUB REM              N N Y N N N              SID AID DCOS NCOS SPK              0 1 1 0              PICKUP PAGE PREFWD LCOS              1 0              CO ACCESS 1</p> <p>BUTTONS</p> <p>01D100 02D101 03D102              04D103 05D104 06D105              07D106 08D107 09D108              10D109 11CO01 12CO02              13CO03 14CO04 15CO05              16CO06 17CO07 18CO08              19LP 20PL1 21CPO              22LQU 23CBK 24PKU              25MSG 26FWD 27DND              28CNF</p> <p>PRIME KEY 0 Y</p> <p><u>STA 103</u></p> <p>PAGE DND CONF EOR PRI SPD QUE              Y Y Y N/A Y Y Y              PLA OHVO FWD LCR SUB REM              N N Y N N N              SID AID DCOS NCOS SPK              0 1 0              PICKUP PAGE PREFWD LCOS              1 1 0              CO ACCESS 1</p> <p>BUTTONS</p> <p>03100 02D101 03D102              043103 05D104 06D105              07D106 08D107 09D108              10D109 11CO01 12CO02              13CO03 14CO04 15CO05              16CO06 17CO07 18CO08              19LP 20PL1 21CPO              22LQU 23CBK 24PKU              25MSG 26FWD 27DND              28CNF</p> <p>PRIME KEY 0 Y</p> <p>...and so on thru stations 195</p>
---	--

Figure 675-3 DB Printout of Station Attributes

## System DataBase Parameters (Cont'd)

## D. Printing CO and Station Port Parameters

Programming StepsDescription

If CO/Station parameters need to be printed:

1. Press the CO/Station Port Parameters flexible button (Button #4). The following message will be shown on the display phone:



**PRINT PORT-STA/CO**  
**PRESS HOLD.D**

2. To print the CO/Station Port parameters, press the HOLD button. The following message will be shown on the display phone:



**PRINTING PORT-STA/CO**

When the system has finished sending the requested information to the printer, confirmation tone will be heard.

With a printer connected to the RS-232C port (future) on the Central Processor Unit (CPU) or to either Port #3 or Port #4 on the I/O Expansion Module, the currently stored customer database can be printed or "uploaded" into a file. This command allows either a range of station data or all stations data information to be "dumped" as a permanent record which can serve as a hard copy of the station attribute database.

The system Baud rate must match that of the printer or receiving device.

Refer to the following Figure for an example of a Station attribute database printout.

**Default:** None

**Related Programming:** Refer to Sec. 610.8, Baud Rate Assignments, for setting the baud rate of the RS-232C port on the Central Processor Unit (CPU), Port #3 or Port #4 on the I/O Expansion Module.



---

CARD	co												
01	-	01	02	03	04	05	06	07	08	09	10	11	12
02	-	13	14	15	16	17	18	19	20	21	22	23	24
03	-	25	26	27	28	29	30	31	32	33	34	35	36
04	-	37	38	39	40	41	42	43	44	45	46	47	48

CARD	STA														
01	-	100	101	102	103	104	105	106	107	108	109	110	111		
02	-	112	113	114	115	116	117	118	119	120	121	122	123		
03	-	124	125	126	127	128	129	130	131	132	133	134	135		
04	-	136	137	138	139	140	141	142	143	144	145	146	147		
05	-	148	149	150	151	152	153	154	155	156	157	158	159		
06	-	160	161	162	163	164	165	166	167	168	169	170	171		
07	-	172	173	174	175	176	177	178	179	180	181	182	183		
08	-	184	185	186	187	188	189	190	191	192	193	194	195		

Figure 675-4 DB Printout of CO/Station Parameters

## System DataBase Printouts (Cont'd)

## E. Printing Exception Tables

Programming Steps

If a printout of the Exception tables are desired:

1. Press the EXCEPT TABLES flexible button (Button #5). The following message will be shown on the display phone:

```

PRINT EX TABLES
PRESS HOLD
  
```

2. To print the Except Tables, press the HOLD button. The following message will be shown on the display phone:

```

PRINTING EX TABLES
  
```

When the system has finished sending the requested information to the printer, confirmation tone will be heard.

Description

With a printer connected to the RS-232C port (future) on the Central Processor Unit (CPU) or to either Port #3 or Port #4 on the I/O Expansion Module, the currently stored customer database can be printed or "uploaded" into a file. This command allows each exception table to be printed individually to serve as a permanent record which can be saved as a hard copy of the exception table database .

The system Baud rate must match that of the printer or receiving device.

When printing information from the Exception tables, the following data is printed:

- Allow Table A
- Deny Table A
- Allow Table B
- Deny Table B
- Special Table 1
- Special Table 2
- Special Table 3
- Special Table 4

Refer to the following Figure for an example of the Exception Tables database printout.

**Default:** None

**Related Programming:** Refer to Sec. 610.8, Baud Rate Assignments, for setting the baud rate of the RS-232C port on the Central Processor Unit (CPU), Port #3 or Port #4 on the I/O Expansion Module.

<u>Allow Table A</u>		<u>SPECIAL TABLE 1 AREA CODE</u>
01	11	ALLOWED OFFICE CODES
02	12	
03	13	
04	14	
05	15	<u>SPECIAL TABLE 2 AREA CODE</u>
06	16	ALLOWED OFFICE CODES
07	17	
08	18	
09	19	
10	20	
<u>Deny Table A</u>		<u>SPECIAL TABLE 3 AREA CODE</u>
01	06	ALLOWED OFFICE CODES
02	07	
03	08	
04	09	<u>SPECIAL TABLE 4 HOME AREA CODE</u>
05	10	ALLOWED OFFICE CODES
<u>Allow Table B</u>		
01	11	
02	12	
03	13	
04	14	
05	15	
06	16	
07	17	
08	18	
09	19	
10	20	
<u>Deny Table 3</u>		
01	06	
02	07	
03	08	
04	09	
05	10	

Figure 675-5 DB Printout of Exception Tables

## System DataBase Printouts (Cont'd)

## F. Printing System Speed Bins

Programming Steps

If a printout of the System speed dial entries are desired:

1. Press the SYSTEM SPEED flexible button (Button #6). The following message will be shown on the display phone:

**PRINT SYS SPEED NO  
PRESS HOLD**

2. To print the System Speed bins, press the HOLD button. The following will be shown on the display phone:

**PRINTING SYS SPEED NO**

When the system has finished sending the requested information to the printer, confirmation tone will be heard.

Description

With a printer connected to the RS-232C port (future) on the Central Processor Unit (CPU) or to either Port #3 or Port #4 on the I/O Expansion Module, the currently stored customer database can be printed or "uploaded" into a file. This command allows either a range of system speed dial bins or all bins can be "dumped" as a permanent record which can serve as a hard copy of the system speed dial database. The system Baud rate must match that of the printer or receiving device.

Refer to the following Figure for an example of a System Speed Dial database printout.

**Default:** None

**Related Programming:** Refer to Sec. 610.8, Baud Rate Assignments, for setting the baud rate of the RS-232C port on the Central Processor Unit (CPU), Port #3 or Port #4 on the I/O Expansion Module.

SYSTEM	SPEED	-NUMBERS
20		50
21		51
22		52
23		53
24		54
25		55
26		56
27		57
28		58
29		59
30		60
31		61
32		62
33		63
34		64
35		65
36		66
37		67
38		68
39		69
40		70
41		71
42		. . .and so on thru Speed Numbers 99
43		
44		
45		
46		
47		
48		
49		

Figure 6756 DB Printout of System Speed Numbers

## System DataBase Printouts (Cont'd)

## G. Printing LCR Tables

Programming StepsDescription

If a printout of the LCR\* tables are desired:

1. Press the LCR\* TABLES flexible button (Button #7). The following message will be shown on the display phone:

```

PRINT LCR TABLES
PRESS HOLD
  
```

2. To print the LCR\* Tables, press the HOLD button. The following will be shown on the display phone.

```

PRINTING LCR TABLES
  
```

When the system has finished sending the requested information to the printer, confirmation tone will be heard.

***This feature is available with optional software.***

With a printer connected to the RS-232C port (future) on the Central Processor Unit (CPU) or to either Port #3 or Port #4 on the I/O Expansion Module, the currently stored customer database can be printed or "uploaded" into a file. This command allows each exception table to be printed individually to serve as a permanent record which can be saved as a hard copy of the exception table database .

The system Baud rate must match that of the printer or receiving device.

When printing information from the LCR Tables, the following data is printed:

- Exception Table
- Route List Table
- Insert/Delete Table
- Daily Time Table
- Weekly Time Table
- Toll Tables
- 6-Digit Table
- 3-Digit Table

Refer to the following Figures for examples of the LCR Tables database printout.

**Default:** None

**Related Programming:** Refer to Sec. 610.8, Baud Rate Assignments, for setting the baud rate of the RS-232C port on the Central Processor Unit (CPU), Port #3 or Port #4 on the I/O Expansion Module.

EXCEPTION CODE TABLE						
CODE	ROUTE NO					
				3	277	1 ## 1
				4	277	1 ## 1

ROUTE LIST TABLE						
RT	TIME	COST	CO	GRD	INS/DEL	GRP PR
0	1	026	1		##	1
	2	026	1		##	1
	3	026	1		##	1
	4	026	1		##	1
1	1	000	1		##	1
	2	000	1		##	
	3	000	1		##	
	4	000	1		##	1
2	1	010	1		##	1
	2	010	1		##	1
	3	010	1		##	
	4	010	1		##	
3	1	072	1		##	
	2	072	1		##	1
	3	072	1		##	1
	4	072	1		##	1
4		171	1		##	1
	2	171	1		##	1
	3	171	1		##	
	4	171	1		##	
5	1	106	1		##	1
	2	106	1		##	1
	3	106	1		##	
	4	106	1		##	1
6		277	1		##	
	2	277	1		##	

DIGIT INS/DEL TABLE	
TABLE	DIGITS

DAILY START TIME TABLE	
TABLE	TIME
1	800
2	1700
3	2300
4	####

WEEKLY SCHEDULE TABLE							
START TIME	M	T	W	T	F	S	S
800	1	1	1	1	1	3	3
1700	2	2	2	2	2	3	2
2300	3	3	3	3	3	3	3
####	3	3	3	3	3	3	3

LCR ROUTE FOR 555-1212

6 DIGIT TABLE	
AREA ROUTE CODE	OFFICE CODES NO

Figure 675-7 DB Printout of LCR Tables

PRINTING SYSTEM DATABASE PARAMETERS

Digital Key Telephone System

3 DIGIT TABLE							256	2	8	N	1	7	N
CODE	LEADING	1	NON-LEADING	1									
	RR	PP	6	RR	PP	6							
11	##	##	N	6	##	N	261	2	8	N	1	7	N
200	0	11	N	##	##	N	262	2	8	N	1	7	N
201	0	11	N	##	##	N	263	2	8	N	1	7	N
202	0	11	N	##	##	N	264	2	-8	N	1	7	N
203	0	11	N	##	##	N	265	2	8	N	1	7	N
204	3	11	N	##	##	N	266	2	8	N	1	7	N
205	0	11	N	##	##	N	267	2	a	N	1	7	N
206	0	11	N	##	##	N	268	2	8	N	1	7	N
207	0	11	N	##	##	N	269	2	8	N	1	7	N
208	0	11	N	##	##	N	270	2	8	N	1	7	-N
209	0	11	N	##	##	N	271	2	8	N	1	7	N
210	0	11	N	##	##	N	272	2	8	N	1	7	N
212	0	11	N	##	##	N	273	2	8	N	1	7	N
213	0	11	N	##	##	N	274	2	8	N	1	7	N
214	0	11	N	##	##	N	275	2	8	N	1	7	N
225	0	A	N	##	##	N	276	2	a	N	1	7	N
	0	11	N	##	##	N	277	2	a	N	1	7	N
217	0	11	N	##	##	N	278	2	8	N	1	7	N
218	0	11	N	##	##	N	279	2	a	N	1	7	N
219	0	11	N	##	##	N	280	2	8	N	1	7	N
220	2	-a	N	1	7	N	281	2	8	N	1	7	N
221	2	a	N	1	7	A	282	2	a	N	1	7	N
222	2	8	N	1	7	N	283	2	a	N	1	7	N
223	2	3	N	1	7	N	284	2	8	N	1	7	N
224	2	a	N	1	7	N	285	2	a	N	1	7	N
225	2	a	N	1	7	N	236	2	8	N	1	7	N
226	2	a	N	1	7	N	257	2	a	N	1	7	N
227	2	a	N	1	7	N	288	2	a	N	1	7	N
228	2	8	N	1	7	N	289	2	8	N	1	7	N
229	2	a	N	1	7	N	290	2	a	N	1	7	N
230	2	3	N	1	7	N	291	2	a	N	1	7	N
231	2	a	N	1	7	N	292	2	8	N	1	7	N
232	2	a	N	1	7	N	293	2	8	N	1	7	N
233	2	a	N	1	7	N	294	2	8	N	1	7	N
234	2	a	N	1	7	N	293	2	a	N	1	7	N
235	2	a	N	1	7	N	296	2	8	N	1	7	N
236	2	8	N	1	7	N	297	2	a	N	1	7	N
237	2	3	N	1	7	N	298	2	a	N	1	7	N
238	2	3	N	1	7	N	299	2	a	N	1	7	N
239	2	a	N	1	7	N	300	0	1	N	##	##	N
240	2	8	N	1	7	N	301	0	1	N	##	##	N
241	2	a	N	1	7	N	302	0	1	s	##	##	N
242	2	a	N	1	7	N	303	0	1	N	##	##	N
2 4 3	2	a	N	1	7	N	304	0	1	N	##	##	N
244	2	a	N	1	7	N	305	0	1	N	##	##	N
245	2	8	N	1	7	N	306	3	1	N	##	##	N
246	2	a	N	1	7	N	307	0	1	N	##	##	N
247	2	3	N	1	7	N	308	0	1	N	##	##	N
2 4 8	2	a	N	1	7	N	309	0	1	N	##	##	N
249	2	a	N	1	7	N	310	0	1	N	##	##	N
2 5 0	2	a	N	1	7	N	312	0	1	N	##	##	N
251	2	a	N	1	7	N	313	0	1	N	##	##	N
252	2	a	N	1	7	N	314	0	1	N	##	##	N
2 5 3	2	a	N	1	7	N	315	0	1	N	##	##	N
254	2	a	N	1	7	N	315	0	1	N	##	##	N
255	2	a	N	1	7	N	317	0	1	N	##	##	N

Figure 675-8 DB Printout of LCR Default



318	0	11	N	##	##	N	379	2	8	N	1	7	N
319	0	11	N	##	##	N	380	2	8	N	1	7	N
320	2	8	N	1	7	N	381	2	8	N	1	7	N
321	2	8	N	1	7	N	382	2	8	N	1	7	N
322	2	8	N	1	7	N	383	2	8	N	1	7	N
323	2	8	N	1	7	N	384	2	8	N	1	7	N
324	2	8	N	1	7	N	385	2	8	N	1	7	N
325	2	8	N	1	7	N	386	2	8	N	1	7	N
326	2	8	N	1	7	N	387	2	a	N	1	7	N
327	2	3	N	1	7	N	388	2	8	N	1	7	N
328	2	8	N	1	7	N	389	2	8	N	1	7	N
329	2	3	N	1	7	N	390	2	8	N	1	7	N
330	2	8	N	1	7	N	391	2	8	N	1	7	N
331	2	8	N	1	7	N	392	2	8	N	1	7	N
332	2	8	N	1	7	N	393	2	8	N	1	7	N
333	2	8	N	1	7	N	394	2	8	N	1	7	N
334	2	8	N	1	7	N	395	2	8	N	1	7	N
335	2	8	N	1	7	N	396	2	8	N	1	7	N
336	2	8	N	1	7	N	397	2	8	N	1	7	N
337	2	8	N	1	7	N	398	2	8	N	1	7	N
338	2	8	N	1	7	N	399	2	8	N	1	7	N
339	2	8	N	1	7	N	400	0	11	N	##	##	N
340	2	8	N	1	7	N	401	0	11	N	##	##	N
341	2	a	N	1	7	N	402	0	11	N	##	##	N
342	2	8	N	1	7	N	403	3	11	N	##	##	N
343	2	8	N	1	7	N	404	0	11	N	##	##	N
344	2	8	N	1	7	N	405	0	11	N	##	##	N
345	2	8	N	1	7	N	406	0	11	N	##	##	N
346	2	8	N	1	7	N	407	0	11	N	##	##	N
347	2	8	N	1	7	N	408	3	11	N	##	##	N
348	2	8	N	1	7	N	409	0	11	N	##	##	N
349	2	8	N	1	7	N	410	0	11	N	##	##	N
350	2	8	N	1	7	N	411	1	4	N	1	3	N
351	2	8	N	1	7	N	412	0	11	N	##	##	N
352	2	8	N	1	7	N	413	0	11	s	##	##	N
353	2	8	N	1	7	N	414	0	11	N	##	##	N
354	2	8	N	1	7	N	415	0	11	N	##	##	N
355	2	8	N	1	7	N	416	3	11	N	##	##	N
356	2	8	N	1	7	N	417	0	11	N	##	##	N
357	2	8	N	1	7	N	418	3	11	N	##	##	N
358	2	8	N	1	7	N	419	0	11	N	##	##	N
359	2	8	N	1	7	N	420	2	8	N	1	J	N
360	2	8	N	1	7	N	421	2	3	N	1	7	N
361	2	8	N	1	7	N	422	2	a	N	1	7	N
362	2	8	N	1	7	N	423	2	8	N	1	7	N
363	2	8	N	1	7	N	424	2	8	N	1	7	N
364	2	8	N	1	7	N	425	2	8	N	1	7	N
365	2	8	N	1	7	N	426	2	a	N	1	J	N
366	2	8	N	1	7	N	427	2	a	N	1	7	N
367	2	8	N	1	7	N	428	2	8	N	1	7	N
368	2	8	N	1	7	N	429	2	8	N	1	7	N
369	2	8	N	1	7	N	430	2	8	N	1	7	N
370	2	8	N	1	7	N	431	2	8	N	1	7	N
371	2	8	N	1	7	N	432	2	8	N	1	7	N
372	2	8	N	1	7	N	433	2	8	N	1	7	N
373	2	8	N	1	7	N	434	2	8	N	1	7	N
374	2	8	N	1	7	N	435	2	8	N	1	7	N
375	2	8	N	1	7	N	436	2	8	N	1	7	N
376	2	8	N	1	7	N	437	2	8	N	1	7	N
377	2	8	N	1	7	N	438	2	8	N	1	7	N
378	2	8	N	1	7	N	439	2	3	N	1	7	N

Figure 675-6 DB Printout of LCR Default (Cont'd)

440	2	8	N	1	7	N	501	0	11	N	##	##	N
441	2	8	N	1	7	N	502	0	11	N	##	##	N
442	2	8	N	1	7	N	503	0	11	N	##	##	N
443	2	8	N	1	7	N	504	0	11	N	##	##	N
444	2	8	N	1	7	N	505	0	11	N	##	##	N
445	2	8	N	1	7	N	506	3	11	N	##	##	N
446	2	8	N	1	7	N	507	0	11	N	##	##	N
447	2	8	N	1	7	N	508	0	11	N	##	##	N
448	2	8	N	1	7	N	509	-0	11	N	##	##	N
449	2	8	N	1	7	N	510	0	11	N	##	##	N
450	2	8	N	1	7	N	512	0	11	N	##	##	N
451	2	8	N	1	7	N	513	0	11	N	##	##	N
452	2	8	N	1	7	N	514	3	11	N	##	##	N
453	2	8	N	1	7	N	515	0	11	N	##	##	N
454	2	a	N	1	7	N	516	0	11	N	##	##	N
455	2	a	N	1	7	N	517	0	11	N	##	##	N
456	2	8	N	1	7	N	518	0	11	N	##	##	N
457	2	8	N	1	7	N	519	3	11	N	##	##	N
458	2	a	N	1	7	N	520	2	8	N	1	7	N
459	2	8	N	1	7	N	521	2	8	N	1	7	N
460	2	8	N	1	7	N	522	2	8	N	1	7	N
461	2	8	N	1	7	N	523	2	a	N	1	7	N
462	2	a	N	1	7	N	524	2	a	N	1	7	N
463	2	8	N	1	7	N	525	2	8	N	1	7	N
464	2	8	N	1	7	N	526	2	8	N	1	7	N
465	2	8	N	1	7	N	527	2	8	N	1	7	N
466	2	a	N	1	7	N	528	2	8	N	1	7	N
467	2	a	N	1	7	N	529	2	a	N	1	7	N
468	2	8	N	1	7	N	530	2	8	N	1	7	N
469	2	8	N	1	7	N	531	2	8	N	1	7	N
470	2	a	N	1	7	N	532	2	8	N	1	7	N
471	2	a	N	1	7	N	533	2	8	N	1	7	N
472	2	8	N	1	7	N	534	2	8	N	1	7	N
473	2	8	N	1	7	N	535	2	8	N	1	7	N
474	2	a	N	1	7	N	536	2	a	N	1	7	N
475	2	3	N	1	7	N	537	2	a	N	1	7	N
476	2	8	N	1	7	N	538	2	8	N	1	7	N
477	2	8	N	1	7	N	539	2	8	N	1	7	N
478	2	a	N	1	7	N	540	2	a	N	1	7	N
479	2	8	N	1	7	N	541	2	8	N	1	7	N
480	2	8	N	1	7	N	542	2	8	N	1	7	N
481	2	8	N	1	7	N	543	2	8	N	1	7	N
482	2	a	N	1	7	N	544	2	a	N	1	7	N
483	2	a	N	1	7	N	545	2	8	N	1	7	N
484	2	8	N	1	7	N	546	2	a	N	1	7	N
485	2	3	N	1	7	N	547	2	a	N	1	7	N
486	2	a	N	1	7	N	548	2	a	N	1	7	N
487	2	a	N	1	7	N	549	2	8	N	1	7	N
488	2	8	N	1	7	N	550	2	8	N	1	7	N
489	2	8	N	1	7	N	551	2	a	N	1	7	N
490	2	8	N	1	7	N	552	2	a	N	1	7	N
491	2	3	N	1	7	N	553	2	8	N	1	7	N
492	2	a	N	1	7	N	554	2	8	N	1	7	N
493	2	8	N	1	7	N	555	2	8	N	1	7	N
494	2	8	N	1	7	N	556	2	8	N	1	7	N
495	2	8	N	1	7	N	557	2	8	N	1	7	N
496	2	a	N	1	7	N	558	2	8	N	1	7	N
497	2	8	N	1	7	N	559	2	a	N	1	7	N
498	2	8	N	1	7	N	560	2	3	N	1	7	N
499	2	8	N	1	7	N	561	2	a	N	1	7	N
500	0	11	N	##	##	N	562	2	8	N	1	7	N

Figure 675-8 DB Printout of LCR Default (Cont'd)

563	2	8	N	1	7	N	625	2	8	N	1	7	N
564	2	8	N	1	7	N	626	2	8	N	1	7	N
565	2	8	N	1	7	N	627	2	8	N	1	7	N
566	2	8	N	1	7	N	628	2	8	N	1	7	N
567	2	8	N	1	7	N	629	2	8	N	1	7	N
568	2	8	N	1	7	N	630	2	8	N	1	7	N
569	2	8	N	1	7	N	63:	2	8	N	1	7	N
570	2	8	N	1	7	N	632	2	8	N	1	7	N
571	2	8	N	1	7	N	633	2	8	N	1	7	N
572	2	8	N	1	7	N	634	2	8	N	1	7	N
573	2	8	N	1	7	N	635	2	3	N	1	7	N
	2	8	N	1	7	N	636	2	8	N	1	7	N
574	2	8	N	1	7	N	637	2	8	N	1	7	N
576	2	8	N	1	7	N	638	2	8	N	1	7	N
577	2	8	N	1	7	N	639	2	8	N	1	7	N
578	2	8	N	1	7	N	640	2	8	N	1	7	N
579	2	8	N	1	7	N	641	2	8	N	1	7	N
580	2	8	N	1	7	N	642	2	8	N	1	7	N
581	2	8	N	1	7	N	643	2	8	N	1	7	N
582	2	8	N	1	7	N	644	2	8	N	1	7	N
583	2	8	N	1	7	N	645	2	8	N	1	7	N
584	2	a	N	1	7	N	646	2	8	N	1	7	N
585	2	8	N	1	7	N	647	2	8	N	1	7	N
586	2	8	N	1	7	N	648	2	8	N	1	7	N
587	2	8	N	1	7	N	649	2	8	N	1	7	N
588	2	8	N	1	7	N	650	2	8	N	1	7	N
589	2	8	N	1	7	N	651	2	8	N	1	7	N
590	2	8	N	1	7	N	652	2	3	N	1	7	N
591	2	8	N	1	7	N	653	2	8	N	1	7	N
592	2	8	N	1	7	N	654	2	8	N	1	7	N
593	2	8	N	1	7	N	655	2	8	N	1	7	N
594	2	3	N	1	7	N	656	2	8	N	1	7	N
595	2	8	N	1	7	N	657	2	8	N	1	7	N
596	2	3	N	1	7	N	658	2	8	N	1	7	N
597	2	8	N	1	7	N	659	2	8	N	1	7	N
598	2	8	N	1	7	N	660	2	8	N	1	7	N
599	2	a	N	1	7	N	661	2	8	N	1	7	N
600	0	11	s	##	##	N	662	2	8	N	1	7	N
601	0	11	N	##	##	N	663	2	8	N	1	7	N
602	0	11	N	##	##	N	664	2	8	N	1	7	N
603	0	11	N	##	##	N	003	2	8	N	1	7	N
604	3	11	s	##	##	N	666	2	8	N	1	7	N
605	3	11	s	##	##	N	667	2	3	N	1	7	N
606	3	11	s	##	##	N	668	2	8	N	1	7	N
607	0	11	N	##	##	N	669	2	8	N	1	7	N
608	0	11	s	##	##	N	670	2	8	N	1	7	N
609	0	11	s	##	##	N	671	2	8	N	1	7	N
610	0	11	s	##	##	N	672	2	8	N	1	7	N
612	3	11	s	##	##	N	673	2	8	N	1	7	N
613	3	11	s	##	##	N	674	2	8	N	1	7	N
614	0	11	N	##	##	N	675	2	8	N	1	7	N
615	0	11	N	##	##	N	676	2	8	N	1	7	N
616	3	11	s	##	##	N	677	2	8	N	1	7	N
617	0	11	9	##	##	N	678	2	8	N	1	7	N
618	0	11	N	##	##	N	679	2	8	N	1	7	N
619	0	11	N	##	##	N	680	2	8	N	1	7	N
620	2	8	N	1	7	N	68:	2	8	N	1	7	N
621	2	8	N	1	7	N	682	2	8	N	1	7	N
622	2	8	N	1	7	N	683	2	8	N	1	7	N
623	2	8	N	1	7	N	684	2	8	N	1	7	N
624	2	8	N	1	7	N	635	2	8	N	1	7	N

Figure 675-8 DB Printout of LCR Default (Cont'd)

686	2	8	N	1	7	N	748	2	8	N	1	7	N
687	2	8	N	1	7	N	749	2	a	N	1	7	N
688	2	8	N	1	7	N	750	2	8	N	1	7	N
689	2	8	N	1	7	N	751	2	a	N	1	7	N
690	2	8	N	1	7	N	752	2	a	N	1	7	N
691	2	8	N	1	7	N	753	2	a	N	1	7	N
692	2	8	N	1	7	N	754	2	8	N	1	7	N
693	2	8	N	1	7	N	755	2	a	N	1	7	N
694	2	8	N	1	7	N	756	2	a	N	1	7	N
695	2	a	N	1	7	N	757	2	a	N	1	7	N
696	2	a	N	1	7	N	758	2	8	N	1	7	N
697	2	8	N	1	7	N	759	2	8	N	1	7	N
698	2	a	N	1	7	N	760	2	8	N	1	7	N
699	2	8	N	1	7	N	761	2	8	N	1	7	N
700	0	11	N	##	##	N	762	2	a	N	1	7	N
701	0	11	N	##	##	N	763	2	a	N	1	7	N
702	0	11	N	##	##	N	764	2	a	N	1	7	N
703	0	11	N	##	##	N	765	2	a	N	1	7	N
704	0	11	N	##	##	N	766	2	8	N	1	7	N
705	3	11	N	##	##	N	767	2	8	N	1	7	N
706	4	11	N	##	##	N	768	2	a	N	1	7	N
707	0	11	N	##	##	N	769	2	a	N	1	7	N
708	0	11	N	##	##	N	770	2	8	N	1	7	N
709	3	11	N	##	##	N	771	2	a	N	1	7	N
710	0	ii	N	##	##	N	772	2	8	N	1	7	N
712	0	11	N	##	##	N	773	2	a	N	1	7	N
713	0	11	N	##	##	N	774	2	a	N	1	7	N
714	0	11	N	##	##	N	775	2	a	N	1	7	N
715	0	11	N	##	##	N	776	2	a	N	1	7	N
716	0	11	s	##	##	N	777	2	8	N	1	7	N
717	0	11	N	##	##	N	778	2	8	N	1	7	N
718	0	11	N	##	##	N	779	2	8	N	1	7	N
719	0	11	N	##	##	N	780	2	8	N	1	7	N
720	2	8	N	1	7	N	781	2	a	N	1	7	N
721	2	a	N	1	7	N	782	2	a	N	1	7	N
722	2	8	N	1	7	N	783	2	8	N	1	7	N
723	2	8	N	1	7	N	784	2	a	N	1	7	N
724	2	a	N	1	7	N	785	2	a	N	1	7	N
725	2	a	N	1	7	N	786	2	8	N	1	7	N
726	2	8	N	1	7	N	787	2	a	N	1	7	N
727	2	a	N	1	7	N	788	2	a	N	1	7	N
728	2	3	N	1	7	N	789	2	a	N	1	7	N
	2	3	N	1	7	N	790	2	3	N	1	7	N
730	2	a	N	1	7	N	791	2	8	N	1	7	N
731	2	a	N	1	7	N	792	2	8	N	1	7	N
732	2	a	N	1	7	N	793	2	a	N	1	7	N
733	2	a	N	1	7	N	794	2	8	N	1	7	N
734	2	a	4	1	7	N	795	2	a	N	1	7	N
735	2	8	N	1	7	N	796	2	a	N	1	7	N
736	2	a	N	1	7	N	797	2	8	N	1	7	N
737	2	a	N	1	7	N	798	2	8	N	1	7	N
738	2	a	N	1	7	N	799	2	8	N	1	7	N
739	2	a	N	1	7	N	800	0	11	N	##	##	N
740	2	a	N	1	7	N	801	0	11	N	##	##	N
741	2	a	N	1	7	N	802	0	11	N	##	##	N
742	2	a	N	1	7	N	803	0	11	N	##	##	N
743	2	8	N	1	7	N	804	0	11	N	##	##	N
744	2	a	N	1	7	N	805	0	11	N	##	##	N
745	2	a	N	1	7	N	806	0	11	N	##	##	N
746	2	a	N	1	7	N	807	3	11	N	##	##	N
747	2	a	N	1	7	N	808	0	11	s	##	##	N

Figure 675-8 DB Printout of LCF? Default (Cont'd)

809	5	11	N	##	##	N	871	2	8	N	1	7	N
810	0	11	N	##	##	N	872	2	8	N	1	7	N
812	0	11	N	##	##	N	873	2	a	N	1	7	N
813	0	ii	N	##	##	N	874	2	8	N	1	7	N
814	0	11	N	##	##	N	875	2	8	N	1	7	N
815	0	11	N	##	##	N	876	2	8	N	1	7	N
816	0	11	N	##	##	N	877	2	8	N	1	7	N
817	0	11	N	##	##	N	878	2	8	N	1	7	N
818	0	11	N	##	##	N	879	2	8	N	1	7	N
819	0	11	N	##	##	N	880	2	8	N	1	7	N
820	2	8	N	1	7	N	881	2	8	N	1	7	N
821	2	8	N	i	7	N	882	2	8	N	1	7	N
822	2	8	N	1	7	N	883	2	8	N	1	7	N
823	2	8	N	i	7	N	884	2	8	N	1	7	N
824	2	8	N	1	7	N	885	2	8	N	1	7	N
825	2	8	N	1	7	N	886	2	8	N	1	7	N
326	2	8	N	1	7	N	887	2	8	N	1	7	N
827	2	8	N	1	7	N	888	2	8	N	1	7	N
828	2	8	N	1	7	N	889	2	8	N	1	7	N
829	2	8	N	1	7	N	890	2	8	N	1	7	N
330	2	8	N	1	7	N	891	2	8	N	1	7	N
831	2	8	N	1	7	N	892	2	8	N	1	7	N
832	2	8	N	1	7	N	893	2	8	N	1	7	N
333	2	3	N	1	7	N	894	2	8	N	1	7	N
834	2	8	N	1	7	N	895	2	8	N	1	7	N
335	2	8	N		7	N	896	2	8	N	1	7	N
836	2	8	N		7	N	897	2	8	N	1	7	N
837	2	8	N	1	7	N	898	2	8	N	1	7	N
838	2	8	N		7	N	899	2	8	N	1	7	N
839	2	8	N		7	N	900	0	11	N	##	##	N
840	2	8	N	1	7	N	901	0	11	N	##	##	N
841	2	3	N	1	7	N	902	3	11	N	##	##	N
842	2	8	N	1	7	N	903	0	11	N	##	##	N
843	2	8	N		7	N	904	0	11	N	##	##	N
844	2	8	N		7	N	905	4	11	N	##	##	N
845	2	8	N		7	N	906	0	11	N	##	##	N
846	2	3	N	1	7	N	907	0	11	N	##	##	N
847	2	8	N	1	7	N	908	0	11	N	##	##	N
848	2	8	N		7	N	909	0	11	N	##	##	N
849	2	8	N		7	N	910	0	11	N	##	##	N
850	2	a	N		7	N	911	-	4	N	1	3	N
351	2	8	N		7	N	912	0	11	N	##	##	N
852	a	3	N		7	N	913	3	11	s	##	##	N
853	2	8	N		7	N	914	0	11	N	##	##	N
854	2	8	N	1	7	N	915	0	11	N	##	##	N
855	2	8	N		7	N	916	0	11	N	##	##	N
856	2	8	N		7	N	917	0	11	N	##	##	N
857	2	8	6		7	N	918	3	11	N	##	##	N
858	2	8	N	-	7	N	919	0	11	s	##	##	N
859	2	8	N		7	N	920	2	8	N	1	7	N
860	2	8	N		7	N	921	2	8	N	1	7	N
861	2	8	N		7	N	922	2	8	N	1	7	N
862	2	8	N		7	N	923	2	8	N	1	7	N
863	2	8	N		7	N	924	2	8	N	1	7	N
864	2	8	N	1	7	N	925	2	8	N	1	7	N
865	2	8	N	1	7	N	326	2	8	N	1	7	N
866	2	8	N	1	7	N	927	2	8	N	1	7	N
867	2	8	N		7	N	928	2	8	N	1	7	N
868	2	8	N		7	N	929	2	8	N	1	7	N
869	2	8	N		7	N	930	2	8	N	1	7	N
870	2	3	N	1	7	N	931	2	8	N	1	7	N

Figure 675-8 DB Printout of LCR Default (Cont'd)

## PRINTING SYSTEM DATABASE PARAMETERS

932	2	8	N	1	7	N	993	2	8	N	1	7	N
933	2	8	N	1	7	N	994	2	8	N	1	7	N
934	2	8	N	1	7	N	995	2	8	N	1	7	N
935	2	8	N	1	7	N	996	2	8	N	1	7	N
936	2	8	N	1	7	N	997	2	8	N	1	7	N
937	2	a	N	1	7	N	998	2	8	N	i	7	N
938	2	a	N	1	7	N	999	2	8	N	1	7	N
939	2	a	N	1	7	N							
940	2	a	N	1	7	N							
941	2	a	N	1	7	N							
942	2	a	N	1	7	N							
943	2	a	N	1	7	N							
944	2	8	N	1	7	N							
945	2	8	N	1	7	N							
946	2	8	N	1	7	N							
947	2	8	N	1	7	N							
948	2	a	N	1	7	N							
949	2	8	N	1	7	N							
950	2	8	N	1	7	N							
951	2	8	N	1	7	N							
952	2	a	N	1	7	N							
953	2	a	N	1	7	N							
954	2	8	N	1	7	N							
955	2	a	N	1	7	N							
956	2	8	N	1	7	N							
957	2	8	N	1	7	N							
958	2	a	N	1	7	N							
959	2	a	N	1	7	N							
960	2	a	N	1	7	N							
961	2	a	N	1	7	N							
962	2	8	N	1	7	N							
963	2	8	N	1	7	N							
964	2	8	N	1	7	N							
965	2	8	N	1	7	N							
966	2	8	N	1	7	N							
967	2	a	N	1	7	N							
968	2	a	N	1	7	N							
969	2	3	N	1	7	N							
970	2	a	N	1	7	N							
971	2	a	N	1	7	N							
972	2	8	N	1	7	N							
973	2	a	N	1	7	N							
974	2	a	N	1	7	N							
975	2	a	N	1	7	N							
976	2	8	N	1	7	N							
977	2	a	N	1	7	N							
978	2	a	N	1	7	N							
979	2	8	N	1	7	N							
980	2	a	N	1	7	N							
981	2	8	N	1	7	N							
982	2	a	N	1	7	N							
983	2	a	N	1	7	N							
984	2	a	N	1	7	N							
985	2	8	N	1	7	N							
986	2	a	N	1	7	N							
987	2	a	N	1	7	N							
988	2	a	N	1	7	N							
989	2	8	N	1	7	N							
990	2	8	N	1	7	N							
991	2	3	N	1	7	N							
992	2	8	N	1	7	N							

Figure 675-8 DB Printout of LCR Default (Cont'd)

System DataBase Printouts (Cont'd)

H. Printing Entire System Data Base

Programming Steps

Description

If a complete printout of the entire database is desired:

1. Press the ENTIRE SYSTEM flexible button (Button #8). The following will be shown on the display phone:

```

PRINT DATA-BASE
PRESS HOLD
    
```

2. To print the entire database, press the HOLD button. The display will update to indicate what portion of the database is being printed.

```

PRINTING SYS PARAM
PRINTING CO UNES
PRINTING PORT-STNCO
PRINTING STATIONS
PRINTING PORT-STA/CO
PRINTING EX TABLES
PRINTING SYS SPEED NO
PRINTING LCR TABLES
PRINTING ICLID TABLES
PRINTING DIR-DIAL
PRINTING HUNT GROUPS
PRINTING ACD GROUPS
PRINTING VM GROUPS
    
```

With a printer connected to the RS-232C port (future) on the Central Processor Unit (CPU) or to either Port #3 or Port #4 on the I/O Expansion Module, the currently stored customer database can be printed or "uploaded" into a file. This command allows the entire database to be "dumped" as a permanent record which can serve as a hard copy of the database.

The system Baud rate must match that of the printer or receiving device.

Printing the entire database takes a while to print. The database is printed in the following order:

- All System Parameters
- All CO Line programming (CO Lines 01-48)
- All CO Ports
- All Station attributes (Stations 100-195)
- All Station Ports
- Exception Tables (allow, deny and special tables)
- System Speed Dial Numbers (bins 20-99)
- LCR Tables
- ICLID\* Tables
- Directory Dialing Table
- Hunt Group Parameters
- ACD\* or UCD Group Parameters
- Voice Mail\* Group Parameters

**Default:** None

**Related Programming:** Refer to Sec. 810.8, Baud Rate Assignments for setting the baud rate of the RS-232C port on the Central Processor Unit (CPU), Port #3 or Port #4 on the I/O Expansion Module.

\*Features available with optional software.

When the system has finished sending the entire database to the printer, confirmation tone will be heard.

## System DataBase Printouts (Cont'd)

## I. Printing ICLID Tables

Programming StepsDescription

If the ICLID\* Table(s) need to be printed:

1. Press the ICLID\* TABLES flexible button (Button #9). The following message will be shown on the display phone:

**PRINT ICLID TABLE  
PRESS HOLD**

2. To print the ICLID\* Tables, press the HOLD button. The following message will be shown on the display phone:

**PRINTING ICLID**

When the system has finished sending the requested information to the printer, confirmation tone is heard.

***This feature is available with optional software.***

With a printer connected to the RS-232C port (future) on the Central Processor Unit (CPU) or to either Port #3 or Port #4 on the I/O Expansion Module, the currently stored customer database can be printed or "uploaded" into a file. This command allows the entire database to be "dumped" as a permanent record which can serve as a hard copy of the database .

The system Baud rate must match that of the printer or receiving device.

When printing the ICLID Tables, the following data is printed:

- ICLID\* Features
- ICLID Translation Table
- ICLID Unanswered Call Table
- ICLID Ringing Assignments Table

Refer to the following Figure for an example of the ICLID Tables database printout.

**Default:** None

**Related Programming:** Refer to Sec. 610.8, Saud Rate Assignments, for setting the baud rate of the RS-232C port on the Central Processor Unit (CPU), Port #3 or Port #4 on the I/O Expansion Module.

\*Features available with optional software.



ICLID	NAME	BAUD	PORT		
N	Y	2400	1	053	##
				054	##
				055	##
				056	##
				057	##
				058	##
				059	##
				060	##
				061	##
				062	##
				063	##
				064	##
				065	##
				066	##
				067	##
				068	##
				069	##
				070	##
				071	##
				072	##
				073	##
				074	##
				075	##
				076	##
				077	##
				378	##
				079	##
				080	##
				081	##
				082	##
				083	##
				084	##
				085	##
				086	##
				087	##
				088	##
				089	##
				090	##
				091	##
				092	##
				093	##
				094	##
				095	##
				096	##
0	3	6		097	##
				098	##
				099	##
0	3	9		100	##
:				101	##
				102	##
				103	##
				104	##
				105	##
				106	##
0	4	6		107	##
				108	##
				109	##
0	4	9		110	##
				-1-	##
				112	##
0	5	0		113	##
0	5	2			

Figure 675-9 DB Printout of ICLID Table



System DataBase Printouts (Cont'd)

J. Printing Directory Dialing Table Parameters

Programming Steps

If Directory Dialing Table Parameters need to be printed:

1. Press the Directory Dialing Table Parameters flexible button (Button #10). The following message will be shown on the display phone:

**PRINT DIR-DIAL  
PRESS HOLD**

2. To print the Directory Dialing Table parameters, press the HOLD button. The following message will be shown on the display phone:

**PRINTING DIR-DIAL**

When the system has finished sending the requested information to the printer, confirmation tone will be heard.

Description

With a printer connected to the RS-232C port (future) on the Central Processor Unit (CPU) or to either Port #3 or Port #4 on the I/O Expansion Module, the currently stored customer database can be printed or "uploaded" into a file. This command allows either a range of station data or all stations data information to be "dumped" as a permanent record which can serve as a hard copy of the station attribute database.

The system Baud rate must match that of the printer or receiving device.

Refer to the following Figure for an example of the Directory Dialing Table database printout.

**Default:** None

**Related Programming:** Refer to Sec. 610.8, Baud Rate Assignments, for setting the baud rate of the RS-232C port on the Central Processor Unit (CPU), Port #3 or Port #4 on the I/O Expansion Module.

## PRINTING SYSTEM DATABASE PARAMETERS

LST	BIN	NAME	
			059 159
			060 160
000	100		061 161
001	101		062 162
002	102		063 163
003	103		064 164
004	104		065 165
005	105		066 166
006	106		067 167
007	i07		068 168
008	108		069 169
009	109		070 170
010	110		371 171
011	111		072 172
012	112		073 173
013	113		074 174
014	114		075 175
015	115		076 176
016	116		077 177
Oi7	ii7		078 178
Oi8	118		079 179
019	ii9		080 180
020	120		081 181
021	121		082 182
022	122		083 183
023	123		084 184
024	124		085 185
325	125		086 186
026	126		087 187
327	127		088 188
028	128		089 189
029	129		090 190
030	130		091 191
031	131		092 192
332	132		093 193
033	133		094 194
034	134		095 195
035	135		046 000
036	136		097 000
037	137		098 000
038	138		399 000
039	139		...and so on thru bin 199
040	140		
041	141		
042	142		
043	143		
044	144		
045	145		
046	146		
047	147		
048	148		
049	149		
050	150		
051	151		
052	152		
053	153		
054	154		
055	155		
056	156		
057	157		
058	158		

Figure 675-12 DB Printout of Directory Dial Table

System DataBase Printouts (Cont'd)

K. Printing Hunt Group Parameters

Programming Steps

If a printout of Hunt Group Parameters is desired:

1. Press the HUNT GROUP PARAMETERS flexible button (Button #11). The following message will be shown on the display phone:



**PRINT HUNT GROUP**  
**PRESS HOLD**

2. To print data for Hunt Group Parameters, press the HOLD button. The following display will be shown on the display phone:

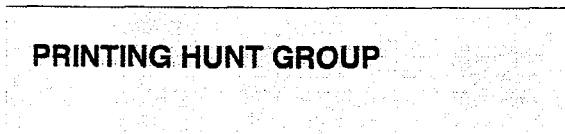

**PRINTING HUNT GROUP**

When the system has finished sending the requested information to the printer, confirmation tone will be heard.

Description

With a printer connected to the RS-232C port (future) on the Central Processor Unit (CPU) or to either Port #3 or Port #4 on the I/O Expansion Module, the currently stored customer database can be printed or "uploaded" into a file. This command allows either a range of station data or all stations data information to be "dumped" as a permanent record which can serve as a hard copy of the station attribute database.

The system Baud rate must match that of the printer or receiving device.

Refer to the following Figure for an example of the Hunt Group Parameter database printout.

**Default:** None

**Related Programming:** Refer to Sec. 610.8, Baud Rate Assignments, for setting the baud rate of the RS-232C port on the Central Processor Unit (CPU), Port #3 or Port #4 on the I/O Expansion Module.

## PRINTING SYSTEM DATABASE PARAMETERS

HUNT GROUPS	
HG0..450	PILOT HUNT
HG1..451	PILOT HUNT
HG2..452	PILOT HUNT
HG3..453	PILOT HUNT
HG4..454	PILOT HUNT
HG5..455	PILOT HUNT
HG6..456	PILOT HUNT
HG7..457	PILOT -HUNT

Figure 675-13 DB Printout of Hunt Group Parameters

System DataBase Printouts (Cont'd)

L. Printing ACD or UCD Group Parameters

Programming Steps

Description

If a printout of ACD\* or UCD Groups is desired:

***This feature is available with optional software.***

1. Press the ACD\* or UCD GROUPS flexible button (Button #12). The following message will be shown on the display phone:

With a printer connected to the RS-232C port (future) on the Central Processor Unit (CPU) or to either Port #3 or Port #4 on the I/O Expansion Module, the currently stored customer database can be printed or "uploaded" into a file. This command allows either a range of station data or all stations data information to be "dumped" as a permanent record which can serve as a hard copy of the station attribute database.

```
*****  
PRINT ACD GROUP  
PRESS HOLD
```

The system Baud rate must match that of the printer or receiving device.

2. To print data for the ACD\* or UCD Group Parameters, press the HOLD button. The following display will be shown on the display phone:

Refer to the following Figure for an example of ACD\* or UCD Group Parameter database printout.

```
*****  
PRINTING ACD GROUP
```

**Default:** None

**Related Programming:** Refer to Sec. 610.8, Baud Rate Assignments, for setting the baud rate of the RS-232C port on the Central Processor Unit (CPU), Port #3 or Port #4 on the I/O Expansion Module.

When the system has finished sending the requested information to the printer, confirmation tone will be heard.

\*Features available with optional software.

ACD	ALT	OVR	ANO	SUP	STN#	ACD TIMERS											
550						RING	MIT	OVER	WRAP	NAT	NAR	FRT					
						60	60	60	4	0	300	5					
551						ANNOUNCEMENT TABLE											
						TABLE	TYPE	INDEX	TIME								
552						1	#	###	###								
						2	#	###	###								
						3	#	###	###								
553						4	#	###	###								
						5	#	###	###								
						6	#	###	###								
554						7	#	###	###								
						8	#	###	###								
555						ACD SMDR REPORTING											
						CO	ICM	EV?	I/O	BAUD							
556						N	N	N	1	2400							
557																	
558																	
559																	
560																	
561																	
562																	
563																	
564																	
565																	

Figure 675-14 DB Printout of ACD Group Parameters



System DataBase Printouts (Cont'd)

M. Printing Voice Mail Group Parameters

Programming Steps

If a printout of Voice Mail Group Parameters is desired:

1. Press the VM\* GROUP PARAMETERS flexible button (Button #13). The following message will be shown on the display phone:

**PRINT VM GROUP  
PRESS HOLD**

2. To print data for Voice Mail\* Group Parameters, press the HOLD button. The following display will be shown on the display phone:

**PRINTING VM GROUP**

When the system has finished sending the requested information to the printer, confirmation tone will be heard.

Description

***This feature is available with optional software.***

With a printer connected to the RS-232C port (future) on the Central Processor Unit (CPU) or to either Port #3 or Port #4 on the I/O Expansion Module, the currently stored customer database can be printed or "uploaded" into a file. This command allows either a range of station data or all stations data information to be "dumped" as a permanent record which can serve as a hard copy of the station attribute database.

The system Baud rate must match that of the printer or receiving device.

When printing the VM Group Parameters, the following data is printed;

- Voice Mail\* Group Parameters
- Voice Mail\* Outpulsing Table (including the disconnect table)
- Voice Mail\* Options

Refer to the following Figure for an example of the VM Group Parameter database printout.

**Default:** None

**Related Programming:** Refer to Sec. 610.8, Baud Rate Assignments, for setting the baud rate of the RS-232C port on the Central Processor Unit (CPU), Port #3 or Port #4 on the I/O Expansion Module.

\*Features available with optional software.

## PRINTING SYSTEM DATABASE PARAMETERS

VM	ALT	LEV	RET	STN#
440	#	##	#	#
441	#	##	#	#
442	#	##	#	#
443	#	##	#	#
444	#	##	#	#
445	#	##	#	#
446	#	##	#	#
447	#	##	#	#

## VOICE MAIL OUT TABLE

TABLE	IDX	PREFIX	SUFFIX
	0		
	1		
	2		
	3		
	4		
	5		
	6		
	7		
	VOICE	MAIL	CO DISCONNECT SIGNAL

APPLY IN-BAND DIGITS TO CO CALLS  
N

ALLOW FORWARD TO VM GROUP  
N

Figure 675-15 DB Printout of Voice Mail Group Parameters

**System DataBase Printouts (Cont'd)**

**N. Abort Printing**

Programming Steps

Description

If you need to abort a printout:

1. Press the ABORT PRINTING flexible button (Button #20).
2. Press the HOLD button. The message currently on the display phone will remain unchanged, however the printing will be aborted.

## SECTION 700 SYSTEM CHECK-OUT

### 700.1 INTRODUCTION

Prior to actual power up and initialization, the Starplus Digital Key Telephone System should be checked over to avoid start up delays or improper loading. A step-by-step checklist is provided for this purpose.

### 700.2 PRELIMINARY PROCEDURES

1. Make sure that the Basic Key Service Unit (BKSU) is properly grounded.
2. Verify that all PCB's are firmly plugged into the correct card slot positions or expander modules are firmly seated onto their connectors.
3. Inspect the MDF for shorted wiring and improper polarity that would affect the Digital Terminal or DSS console.
4. Make certain that the nicad battery jumper on the Central Processor Unit (CPU) is set between pins 2 & 3 to enable Battery Backup option.
5. Make sure that plug-ended MDF cables connected to the KSU are secure and are plugged into the correct position.

### 700.3 POWER UP SEQUENCE

The power up sequence involves the proper application of AC power to the System, and CPB LEDs. A successful power up is assured if the installation checklist has been followed.

1. Plug the AC power cord of the Key Service Unit into the dedicated 117V ac outlet.
2. Turn the power switch of the KSU to ON.
3. The Central Processor Unit (CPU) has two red LEDs located on the front of the card. If the power up is successful, both red LEDs will flash.
4. Press the reset button on the CPU. The above LED indications will repeat. Initialization may be required prior to programming.
5. The system is ready for programming. If any problems have occurred, Refer to Section 800, Maintenance and Troubleshooting.

**Table 700-I Power Supply Tests**

VOLTAGE DESIGNATIONS	V O L T A G E R E A D I N G	T E S T   P O I N T L O C A T I O N	R E M A R K S
117 VAC	+117 VAC ±10%	Commercial Power Source	

The power supply is pre-set at the time of manufacturing, but should be checked at system initialization with a digital volt meter having an accuracy of ±1%.

## SECTION 800

# MAINTENANCE AND TROUBLESHOOTING

800.1 PRINTED CIRCUIT BOARD (PCB)  
 TROUBLESHOOTING CHARTS

**Table 800-1 Central Processor Unit (CPU)**

FUNCTION	CONTROL	OPTIONS	FAULT OPTIONS
1. Central Processor board (CPU) to control system operation.			1. Complete system failure. 2. Erroneous call processing. 3. Inoperative features in system operation. 4. Partial failures in system operation. 5. Continual system restarts. 6. Failure of SMDR. 7. Loss of unique customer data base programming.
2. Read Only Memory (ROM) with factory set instructions.			
3. Random Access Memory (RAM) protected by a nicad battery.			
4. Halt switch for manual system restart.			
5. Provides RS-232C port for SMDR and Terminal/Remote Programming.			

**Table 800-2 CPU Static RAM Memory Size**

SIZE OF CHIPS (in Bits)	RAM MEMORY SIZE (in bytes)
1 Megabit chip (2048 bytes)	2 * 1 Meg chips= 256K bytes 4 * 1 Meg chips= 512K bytes
4 Megabit chips (4096 bytes)	2 * 4 Meg chips= 1024 bytes 4 * 4 Meg chips= 2048K bytes

Table 8003 CPU EPROM Memory Size

SIZE OF CHIPS (in Megabits)	SW1 SWITCH POSITIONS				EPROM MEMORY SIZE (in bytes)
	1 (SA)	2 (SB)	3 (SC)	4 (not used)	
1 Megabit chips (1024 bytes)	OFF (open)	OFF (open)	OFF (open)	OFF (open)	2 • 1 Meg chips = 256K bytes 4 • 1 Meg chips = 512K bytes
2 Megabit chips (2048 bytes)	ON (closed)	OFF (open)	OFF (open)	OFF (open)	2 • 2 Meg chips = 512K bytes 4 • 2 Meg chips = 1024K bytes
4 Megabit chips (4096 bytes)	ON (closed)	ON (closed)	OFF (open)	OFF (open)	2 • 4 Meg chips = 1024K bytes 4 • 4 Meg chips = 2048K bytes
8 Megabit chips (8192 bytes)	ON (closed)	ON (closed)	ON (closed)	OFF (open)	2 • 8 Meg chips = 2048K bytes 4 • 8 Meg chips = 4096K bytes

OFF= OPEN, ON= CLOSED

Table 8004 Single Line Board (SL12)

FUNCTION	CONTROL	OPTIONS	FAULT OPTIONS
Provides interface for 12 Single Line Telephones. Also provides for SLTs with M/W lights.	Two LEDs that indicate the presence of +5V dc and -5V dc	None	1 .SLT can't receive dial tone. 2.Poor transmission characteristics

Table 800-5 Key Telephone Board (KT12)

FUNCTION	CONTROL	OPTIONS	FAULT OPTIONS
Provides interface for 12 Digital Terminals, DSS/DLS Consoles or SLA (OPX) modules.	Two LEDs that indicate the presence of +5V dc and -5V dc	None	1 .Unable to receive intercom dial tone. 2.Poor transmission characteristics, 3.Key telephone set inoperative. 4.Key telephone un-able to invoke features 5.No LED indications.

Table 800-7 CO Line Loop Board (C012)

FUNCTION	CONTROL	OPTIONS	FAULT OPTIONS
Provides interface for 12 Loop Start CO lines.	Two LEDs that indicate the presence of +5V dc and -5V dc  Additionally, 12 LEDs indicate the presence of CO line in use.	None	1 .Unable to receive intercom dial tone. 2.Poor transmission characteristics. 3.Key telephone set inoperative. 4.Key telephone un-able to invoke features 5.No LED indications.

Table 800-8 Voice Control Board (VCB)

FUNCTION	CONTROL	OPTIONS	FAULT OPTIONS
Contains "On-Board" 1200 Baud Modem  Provides all system tones such as intercom dial tone and busy tone, etc.		None	1 .Loss of unique customer database programming 2.Erroneous call processing 3.No Background Music

Table 800-9 4-circuit DTMF Module (DTM4)

FUNCTION	CONTROL	OPTIONS	FAULT OPTIONS
Used to add DTMF receivers to the system to support Single Line operation.	Adds 4 DTMF receiver.	None	1. SLT cannot receive or break dial tone. 2. DISA call can't receive or break dial tone.

Table 800-10 Backplane I/O Expansion Module (IOM)

FUNCTION	CONTROL	OPTIONS	FAULT OPTIONS
Provides two additional RS-232C ports to the system.	None	None	1 .Loss of SMDR data.

Table 800-6 Single Line Telephone Adapter (OPX)

FUNCTION	CONTROL	OPTIONS	FAULT OPTIONS
Provides one 48 volt loop to interface an OPX circuit.	Busy state LED that monitors circuits for busy condition.	/None	1 .SLT can't receive dial tone. 2.Poor transmission, characteristics.

**MAINTENANCE AND TROUBLESHOOTING****800.2 REMOTE MAINTENANCE****A. General Overview**

The Remote Maintenance feature allows authorized personnel to survey system and slot configuration information. This can be done through a modem or data terminal connected to the Backplane Expansion Module via the RS-232C port. The commands are entered from a keyboard and are limited to those listed.

**B. Overview of Maintenance Commands**

There are four basic commands available in the Remote Maintenance feature. All commands begin with a single character, followed by a space, another character and an optional digit or digits. All commands are terminated with a carriage return.

Basic format of the commands are shown in Figure 800-I :

**C. Maintenance Password**

The Remote Maintenance feature, like Remote Programming, is entered via a six-character alphanumeric string. The password prompt is given by entering a carriage return at the device connected to the Backplane Expansion Module RS-232C port. After the prompt is printed out, the password should be entered followed by a carriage return. Proper entry of the password will result in the maintenance prompt. The Remote Maintenance password is: {CONFIG}

**D. Exit Maintenance**

The Exit command will terminate the current Remote Maintenance feature session. The Exit command format is: MAINT>X

```

4896 Digital Key-System
Eng. Ver. 0.071F DATE: 06/09/93 TIME: 13:26:41
ENTER PASSWORD:
maint>?
command list:
a s[nn] - dump system or slot configuration data
         [nn] specifies an optional slot number parameter
         no parameter indicates that the entire system will be dumped
examples:
         maint>a s      (dumps entire system configuration)
         maint>d s2    (dumps slot 2 configuration, etc.)

?       - help menu
x       - exit maint
maint>

```

Figure 800-I Remote Maintenance Help Menu



**F System Configuration**

Figure 800-2 is a configuration of the Starplus Digital key Telephone System with LCR and shows what is printed out when:

- a. The installer enters **D<space>S** at the `maint>` prompt.

```

maint>d s
-----
SLOT      TYPE      FW VER.   BRD TYPE   3RD OPTS   SERV  STAT
-----
1         CPB       0.071F   CPU        4896, IAE   INS
2         KIB       N/A      KSB        0           INS
3         KIB       N/A      KSB        0           INS
4         KIB       N/A      KSB        0           INS
5         KIB       N/A      KSB        0           INS
6         coa       N/A      co1        0           INS
7         COB       N/A      COI        0           INS
8         CO3       N/A      co1        0           INS
9         COB       N/A      COI        0           INS
10        KIB       N/A      KSB        0           INS
11        IIB       N/A      KSB        0           INS
12        UNK       N/A      UNPOPULATED 0           OOS
13        SIB       N/A      SIB        1           INS
-----
maint>
    
```

**Figure 800-2 System Configuration w/LCR**

where:

**Column 1:** lists the card slot.

**Column 2:** lists card type of that card slot.

**Column 3:** lists the firmware version of the card.

**Column 4:** lists card type and if that card is installed.

**Column 5:** lists card options:

**Column 6:** lists card status:

**OOS** status can indicate the entire card is out of service or a specific station is not installed or installed but not operational

**INS** status can indicate a specific station is installed and operating correctly.

## F. CO/Station Configuration

Figure 800-3 is the CO/Station Configuration and shows what is printed out when:

- a. The installer enters **D<space>S2** at the **maint>** prompt.

```

maint>d s2
  SLOT : 1
-----
Board Type : K1B - K5B
-----
  STA      TYPE      STATUS  LCD
-----
  100     Keyset     INS     Y
  101     Keyset     OOS     N
  102     Keyset     INS     Y
  103     Keyset     INS     Y
  104     Keyset     INS     Y
  105     Keyset     INS     Y
  106     Keyset     INS     Y
  107     Keyset     INS     N
  108     Keyset     INS     Y
  109     Keyset     INS     Y
  110     Keyset     INS     Y
  111     Keyset     INS     Y

maint>
ALT-F10  HELP : ANSI-BBS : FDX : 2400 N81 :

```

Figure 800-3 CO/Station Configuration

where: **CO Lines:**

**Column 1:** lists the CO Line number.

**Column 2:** indicates status:

**OOS** status can indicate the entire card is out of service.

**INS** status can indicate a board station is installed and operating correctly. **Outgoing enabled** indicates the CO line is active in the system. **Outgoing disabled** indicates that the Attendant has disabled the CO line for outgoing access

**Column 3:** indicates whether the CO Line is Pulse or DTMF. (programmable option)

**Column 4:** indicates whether the CO Line is a CO Line or a PBX Line. (programmable option)

where: **Stations**

**Column 1:** lists the station number.

**Column 2:** indicates station type (keyset, DSS, SLT).

**Keyset** • ID 0 = Key station

**DSS/DLS** • ID 1 = DSS Map 1

**DSS/DLS** • ID 2 = DSS Map 2

**DSS/DLS** • ID 3 = DSS Map 3

**DSS/DLS** • ID 4 = DSS Map 4

**SLT** • ID 5 = SLT/OPX

**SLT w/Lamp** • ID 6 = SLT w/Message Waiting

**Relay/Sensor** • ID 7 = Relay/Sensor Module

**DDIU** • ID 8 = Digital Data Interface Unit

**Column 3:** indicates status:

**COS** status can indicate the entire card is out of service or a specific station is not installed or installed but not operational.

**INS** status can indicate a specific station is installed and operating correctly.

**Column 4:** indicates whether the station has an LCD Display or doesn't have an LCD Display.

### G. Event Trace Buffer

The Event Trace Buffer is used to store and dump event traces (up to 30) that occur just prior to a Starplus Digital Key Telephone System soft or hard restart. These can then be reviewed by authorized personnel to aid in system troubleshooting..

The basic format for the commands are:

- T<space><return> • display the current status of the Event trace buffer
- T<space>0<return> • turns the Trace buffer OFF.
- T<space>1 <return> • turns the Trace buffer ON to record events prior to a soft system reset.
- T<space>2<return> • turns the Trace buffer ON to record events prior to a hard system restart.
- T<space>3<return> • turns the Trace Buffer ON to record events prior to either a soft reset or a hard system restart.
- d<space>E<return> • dumps Trace Events stored from last system reset. (soft or hard)

**NOTE**

**Ctrl + C will abort the Data Dump and return to the maint> prompt.**

### 800.3 REMOTE SYSTEM MONITOR

#### A. General Overview

The Remote Monitor feature provides remote access to the installed system for diagnostic purposes. These capabilities benefit Service personnel enabling them to support the end user remotely. Different levels of access, via password, allows authorized personnel to trace, monitor and "up-load" critical information directly from the Starplus Digital Key Telephone System. This provides a more accurate means of acquiring system information that leads to a quick resolution of problems that may occur. This is all done without interfering with ongoing call processing or normal system operation, and in many cases may be performed without a site visit. The built-in 1200 baud modem (future) is used for remote access.

Capabilities allowed and reserved for this "High level troubleshooting" in addition are:

- Monitor Mode
- Enable & Disable Event "Trace"
- Dump "Trace Buffer" (up-load)

#### B. Monitor Password

The Remote Monitor feature, like Remote Maintenance, is entered via a six-character alphanumeric string. The password prompt is given by entering a carriage return at the device connected to the Backplane I/O Expansion Module. After the prompt is printed out, the password should be entered followed by a carriage return. Proper entry of the password will result in the MON> prompt. The Remote Maintenance password is: {ETTRACE}

#### NOTE

The remote monitor feature is intended for use only under the guidance and instruction by authorized personnel from a Technical Assistance Center (TAC). Care and caution must be observed when using this feature as permanent damage to the software structure can occur.

#### C. Help Menu (?)

A convenient on screen Help Menu is provided by typing a "?" then pressing Enter. The following will appear on the screen:

```

4896 Digital Key-System
Enc. Ver. 0.071F DATE: 06/09/93 TIME: 13:30:55
ENTER PASSWORD:
mon>?
command list:
c [c]      dump co data
s [s]      dump sta data
t [d]      set trace key
d [a] [a]  dump memory
m a        modify memory
b rate    set baud rate
?          help menu
x         - exit monitor
mon>

```

#### D. Dump Memory Data

Three options allow the memory structure to be "dumped" for viewing. The three options are entered as follows:

c [c] • Dump CO Line memory structure

s [s] • Dump Station memory Structure

d [a][a] - Dump a memory address Structure

The data obtained from these commands is in hexadecimal format and is used primarily for manufacture level support.

#### NOTE

**Ctrl + C** will abort the Data Dump and return to the mon> prompt.

### E. Event Trace Mode

The "T" command enables and disables the Starplus Digital Key Telephone System Trace mode. While the trace mode is enabled events for the trace desired will be displayed on the monitor, printer or PC connected to the Starplus Digital Key Telephone System in an event record. To view the current status of the trace mode type "T"<return>at the MON> prompt then the following screen will be displayed:

```

mon>t

  Messages      Y/N
  -----
BOARD EVT  -> N
MSC States -> N
Dev        -> N
PCM        -> N
COL States -> N
Stn States -> N
Error Msg  -> N
Que Evt    -> N

mon>

```

- To enable an event trace type "t" <space> (space bar)
- Then type of trace desired [d], where d is determined as follows:
  - B= Board event trace (traces events associated with PCB's)
  - M= Miscellaneous State event trace
  - P= Pulse Coded Modulation (PCM) traces events associated with voice communications.
  - C= CO Line (C012) States (traces events associated with CO Line activity)
  - S= Station (STA) States (traces events associated with Station activity)
  - E= Error Messages (traces error messages)
  - Q= Queue (QUE) Events (traces queuing events, i.e. DTMF receiver, UCD, LCR, etc...)
  - D= Device Command (traces commands to peripheral devices).

- Then enter the specific board, CO line or Station number of the trace desired or type "all" if all board's, CO line's or Station's events are desired.
  - 1-19 = Board KSU card slot position (CPU= 1)
  - 01-48 = CO Line port
  - 100-1 95 = Station location
  - All= All Boards, CO lines or Stations
- Then press Enter to enable the trace. A screen similar to the following will appear:

```

mon>t b

  Messages      Y/N
  -----
BOARD EVT  -> Y
MSC States -> N
Dev        -> N
PCM        -> N
COL States -> N
Stn States -> N
Error Msg  -> N
Que Evt    -> N

mon>

```

- To disable or turn off a particular trace mode do not enter a specific board, CO line or Station number (i.e. "t<space>s<return>" to disable station event trace).

To have event trace's displayed on the screen you must first exit the MONitor mode by typing "X" at the MON> prompt. After you exit the event(s), the trace will begin as shown in Figure 800-4 Event Trace as it appears on Display.

#### CAUTION

Unless instructed by personnel at a Technical Assistance Center (TAC) do not leave the trace mode enabled for! extended periods of time. The system will "dump" the requested event(s) trace which may use up paper or fill/ memory buffers on the collecting device. It is recommended that the trace events be disabled (turned off) for all event(s) traces before leaving the system site.

```

Sta 100: State= DIAL-TONE, Evt= Dial Pad (25), Data=7
Sta 100: State= DIALING, Evt= Dial Pad (25), Data=5
Sta 100: State= DIALING, Evt= Int Page (69), Data=8
Sta 100: State= PAGING, Evt= Dial Pad (25), Data=3
Sta 100: State= PAGING, Evt= Dial Pad (25), Data=9
Sta 100: State= PAGING, Evt= Dial Pad (25), Data=5
Sta 100: State= PAGING, Evt= Dial Pad (25), Data=8
Sta 100: State= PAGING, Evt= Dial Pad (25), Data=7
Sta 100: State= PAGING, Evt= Dial Pad (25), Data=4
Sta 100: State= PAGING, Evt= Dial Pad (25), Data=3
Sta 100: State= PAGING, Evt= Dial Pad (25), Data=9
Sta 100: State= PAGING, Evt= Dial Pad (25), Data=9
Sta 100: State= PAGING, Evt= Dial Pad (25), Data=9
Sta 100: State= PAGING, Evt= Dial Pad (25), Data=7
Sta 100: State= PAGING, Evt= Dial Pad (25), Data=11
Sta 100: State= PAGING, Evt= Dial Pad (25), Data=3
Sta 100: State= PAGING, Evt= Dial Pad (25), Data=2
Sta 100: State= PAGING, Evt= Page T/O (150), Data=0
Sta 100: State= MISC-TONE, Evt= Dial Pad (25), Data=4
Sta 100: State= MISC-TONE, Evt= Dial Pad (25), Data=9
Sta 100: State= MISC-TONE, Evt= Key Data (26), Data=32
Sta 100: State= MISC-TONE, Evt= Mon Key (145), Data=-1
Sta 100: State= MISC-TONE, Evt= On Hook (17), Data=0

```

Figure 800-4 Event Trace as it appears on Display

#### F. Modify Memory command

The Modify Memory Command is for Engineering Use only.

#### CAUTION

Use of this command can alter or damage the Starplus, Digital Key Telephone Systems operating data base which can result in system malfunction. If this occurs it will be necessary to power the system down and re-initialize the data base, then completely re-program the customer programming data.

#### G. Baud Rate Command

This command provides a convenient means for changing the baud rate, for the RS-232-C port located on the Central Processor Unit (CPU), while in the Monitor mode. To change the baud rate type "B" plus the desired baud rate, then the enter key.

#### NOTE

After changing the Baud Rate via Baud Rate command, you must change your Baud Rate on your Receiver/Terminal.

#### H. Exit the Monitor mode

The Exit command will terminate the current Remote Monitor enable/disable session. If Event(s) Trace have been or are still enabled the event records will be displayed only after exiting the MONITOR mode. The Exit command format is: MON> X

#### CAUTION

Unless instructed by personnel at a Technical Assistance Center (TAC) do not leave the trace mode enabled for extended periods of time. The system will "dump" the requested event(s) trace which may use up paper or fill memory buffers on the collecting device. It is recommended that the event traces be disabled (turned off) for all event(s) before leaving the system site.

# APPENDIX A CUSTOMER DATABASE PROGRAMMING

## Appendix A-I System Parameters

PROG CODE	FLEX BTN	FUNCTION	FORMAT	DEFAULT	CUSTOMER DATA
FLASH01	1	/System Hold Recall	000-300 s	060 s	
	2	Exclusive Hold Recall	000-300 s	180 s	
	3	Attendant Recall Timer	00-60 min	0 f m n	
	4	Transfer Recall	000-300 s	045 s	
	5	Preset Forward Timer	00-99 s	10 s	
	6	Call Forward No/Answer	000-600 s	015 s	
	7	Pause Timer	1-9 s	2s	
	a	/Call Park Timer	000-600 m	180 s	
	9	Conference/DISA Timer	00-99 m	10 m	
	10	Paging Timeout Timer	00-60 s	15 s	
	11	CO Ring Detect Timer	200-900 msec	300 msec	
	12	DISA/SLT Receiver Timer	005-100	020s	
	13	MSG Wait Reminder Tone	000-104 m	000 m	
	14	SLT Hook-Flash Timer	05-20 s	1.0s	
	15	SLT Hook-Flash Debounce Tmr	0.00-1.00 sec	0.1 s	
	16	SMDR* Call Qualification Timer	00-60 sec.	30 sec.	
	17	Auto Call Back Timer	00-99 sec.	00 sec.	
	18	Reminder Ring Timer	00-99 sec.	00 sec.	
	19	Release Guard Timer	01-50 msec.	300 msec	
FLASH 05	1	Attendant Override	Yes/No	No	
	2	/Hold Preference	Sys/Excl	System	
	3	External Night Ring	Yes/No	No	
	4	Executive Warning Tone	Yes/No	Yes	
	5	/Page Warning Tone	Yes/No	Yes	
	6	Background Music	Yes/No	Yes	
	7	LCR* Enable	Yes/No	No	
	8	ForcedAccount Codes*	Yes/No	No	
	9	Group Listening	Yes/No	No	
	10	Idle Speaker Mode	Yes/No	No	
	11	/Call Cost* Display Feature	Yes/No	No	
	12	/Music On Hold	Yes/No	Yes	
	13	Handset Receiver Gain	Yes/No	No	
	14	Call Qualifier Tone Option	Yes/No	No	
* ADDITIONAL SYSTEM FEATURES:					
FLASH 06	1	Barge-In Warning Tone	Enable/Disable	Enable	

\*Features available with optional software.

Appendix A-I System Parameters (Cont'd)

PROG CODE	FLEX BTN	FUNCTION	FORMAT	DEFAULT	CUSTOMER DATA
SYSTEM FLASH RATES:					
/FLASH07	1	Incoming CO Ringing	00-15	30 ipm flash	
	2	/Incoming ICM Ringing	00-15	120 ipm flutter	
	3	Call Forward	00-1 5	30 ipm flash	
	4	/Message Waiting	00-15	15 iprn flash	
FLASH10		Attendant Station Assignment	100-1 95	100	
FLASH 11	1-4	/Time/Date Format	12/24 HR:M/D	12 HR:M/D	
FLASH 12	1-5	1 PBX Dialing Codes	Five 2-Digit	None	
/FLASH 13	1	Exec/Secy Pair 1	i Sta #, Sta #	None	
	2	Exec/Secy Pair 2	Sta #, Sta #	None	
	3	Exec/Secy Pair 3	Sta #, Sta #	None	
	4	Exec/Secy Pair 4	Sta #, Sta #	None	
FLASH 1 4	1	Relay #1		None	
	2	Relay #2		None	
	3	Relay #3		None	
	4	(Sensor #1		None	
	5	Sensor #2		None	
	6	Sensor #3		None	
	8	/Stations		None	
	12	Relay/Sensor #1		None	
	13	Relay/Sensor #2		None	
	14	/Relay/Sensor #3		None	
	15	Relay/Sensor #4		None	
FLASH 15	1	Port #1 ("On-Board" RS-232C)		2 4 0 0	
	2	Port #2 ("On-Board" Modem)		1200	
	3	Port #3 (Backplane RS-232C)		2400	
	4	Port #4 (Backplane RS-232C)		2400	
FLASH 20	1	DISA Access Code	100-999	i too	
	2	Admin. Password	One 4-Digit	3226	
FLASH 21	1	SMDR* Enable/Disable	Yes/No	No	
	2	Call Type	All/LD Only	LD Only	
	3	/Print Columns	80/29	80	
	4	/Baud Rate	300/1200/2400 4800/9600	2400	
	5	I/O Port	1/2/3/4	Port #1	

\*Features available with optional software.



Appendix A-I System Parameters (Cont'd)

PROG CODE	FLEX BTN	FUNCTION	FORMAT	DEFAULT	CUSTOMER DATA
/FLASH22	1	Night Mode Operation	Auto/Manual	Manual	
	2	ANM Schedule - Monday	Off Time	0	/
	3	ANM Schedule - Tuesday	Off Time	1	/
	4	ANM Schedule - Wednesday	Off Time	2	/
	5	ANM Schedule - Thursday	Off Time / On Time	3	/
	6	ANM Schedule - Friday	Off Time / On Time	4	/
	7	ANM Schedule - Saturday	Off Time / On Time	5#####	/
	8	ANM Schedule - Sunday	Off Time / On Time	6#####	/
FLASH 23	I-4	Directory Dialing Table			
FLASH 24	I-1 2	Flexible Card Assignments		4 Station, 4 CO Line, 4 Station	
FLASH 41	1	/Dial Pulse	60/40, 66/33	60/40	
	2	Dialing Speed	10/20 p p s	10 pps	
FLASH 42	I-4	Flexible CO Port Assignments		Cards I-4	
FLASH43	1	ICLID* Ringing Assignment		None	
FLASH 52	I-8	/Flexible Station Port Assignments		Cards 1-8	

\*Features available with optional software.

Appendix A-2 Hunt Group, ACD and UCD Group Parameters

PROG CODE	FLEX BTN	FUNCTION	PILOT OR STATION	STATIONS (up to 8 Stations)
FLASH 30	1	Hunt Group 0 (450)		
	2	Hunt Group 1 (451)		
	3	Hunt Group 2 (452)		
	4	Hunt Group 3 (453)		
	5	Hunt Group 4 (454)		
	6	Hunt Group 5 (455)		
	7	Hunt Group 6 (456)		
	8	Hunt Group 7 (457)		

PROG CODE	FLEX BTN	FUNCTION	ALT	OVR RAN	STATIONS (up to 8 Stations)
FLASH 60	1	ACD*/UCD Group 0 (550)			
	2	ACD*/UCD Group 1 (551)			
	3	ACD*/UCD Group 2 (552)			
	4	ACD*/UCD Group 3 (553)			
	5	ACD*/UCD Group 4 (554)			
	6	ACD*/UCD Group 5 (555)			
	7	ACD*/UCD Group 6 (556)			
	8	ACD*/UCD Group 7 (557)			

PROG CODE	FLEX BTN	FUNCTION	FORMAT	DEFAULT	CUSTOMER DATA
FLASH 61	1	ACD*/UCD Ring Timer	000-300	060	
	2	ACD*/UCD Message Timer	000-300	060	
	3	ACD*/UCD Overflow Timer	000-300	060	
	4	ACD*/UCD Wrap-up Timer	000-999	004	
	5	ACD*/UCD No-Answer Recall Timer	000-300	000	
	6	ACD*/UCD No-Answer Retry Timer	000-999	30	
	7	*Guaranteed Message Timer	000-300	10	

PROG CODE	FLEX BTN	FUNCTION	FORMAT	DEFAULT	CUSTOMER DATA
FLASH 62	1	RAN Announcement Table 1	YXXXMMM	None	
	2	RAN Announcement Table 2	YXXXMMM	None	
	3	RAN Announcement Table 3	YXXXMMM	None	
	4	RAN Announcement Table 4	YXXXMMM	None	
	5	RAN Announcement Table 5	YXXXMMM	None	
	6	RAN Announcement Table 6	YXXXMMM	None	
	7	RAN Announcement Table 7	YXXXMMM	None	
	8	RAN Announcement Table 8	YXXXMMM	None	

\*Features available with optional software.

**Appendix A-2 Hunt, ACD, UCD Group Parameters (Cont'd)**

PROG CODE	FLEX BTN	FUNCTION	ALT	OVF?	RAN	STATIONS (up to 16 Stations)
FLASH 64	1	ACD* Group 8 (558)				
	2	ACD* Group 9 (559)				
	3	ACD* Group 10 (560)				
	4	ACD* Group 11 (561)				
	5	ACD* Group 12 (562)				
	6	ACD* Group 13 (563)				
	7	ACD* Group 14 (564)				
	8	ACD* Group 15 (565)				

\*Features available with optional software.

Appendix A-3 Voice Mail Group Parameters

PROG CODE	FLEX BTN	FUNCTION	ALT	OVR	RAN	
FLASH 65	1	Voice Mail Group 0 (440)*				
	2	Voice Mail Group 1 (441)*				
	3	/Voice Mail Group 2 (442)*				
	4	Voice Mail Group 3 (443)*				
	5	/Voice Mail Group 4 (444)*				
	6	Voice Mail Group 5 (445)*				
	7	Voice Mail Group 6 (446)*				
	8	Voice Mail Group 7 (447)*				

PROG CODE	FLEX BTN	FUNCTION	OUTPULSING DIGITS	L or R
FLASH 66	1	VM* Outpulsing Table 0	/Prefix Suffix	
	2	VM* Outpulsing Table 1	Prefix Suffix	
	3	VM* Outpulsing Table 2	/Prefix /Suffix	
	4	VM* Outpulsing Table 3	Prefix /Suffix	
	5	VM* Outpulsing Table 4	/Prefix /Suffix	
	6	VM* Outpulsing Table 5	Prefix *Suffix	
	7	VM* Outpulsing Table 6	Prefix Suffix	
	8	VM* Outpulsing Table 7	Prefix *Suffix	
	9	VM* Disconnect Table 8	Disconnect	

PROG CODE	FLEX BTN	FUNCTION
FLASH 67	1	/Voice Mail* ID digits for Incoming CO Calls
	2	/Voice Mail* Transfer/Forward

\*Features available with optional software.

Appendix A-4 CO Line Programming (Flash 40)

FLEXIBLE BUTTONS	CO1	CO2	CO3	CO4	CO5	CO6	CO7	CO8	CO9	CO10	CO11	CO12	DEF
1	Tone/ Pulse												TONE
2	CO/ PBX												CO
3	UNA												YES
4	Conf												YES
5	Privacy												YES
6	Loop supv												NO
7	DISA												NO
8	Flash Timer												10
9	Line Group												1
10	Line COS												1
11	Ring*												
13	Trunk Dir												2
14	Ring Delay												00
15													
16													
17													
18													
19													
20													

\*Refer to CO Line Ringing Assignments

Board # \_\_\_\_\_

Appendix A-4 CO Line Programming (Flash 40) (Cont'd)

CO LINE	CO LINE NAME FOR IDENTIFICATION
co1	
CO 2	
CO 3	
co4	
CO 5	
CO 6	
c o 7	
CO 8	
CO 9	
CO 10	
CO 11	
CO 12	

CO Line Board # \_\_\_\_\_

**Appendix A-5 CO Line Ringing Assignment Chart**

_____	DAY RINGING	_____	DAY RINGING
CO LINE:		CO LINE:	
_____		_____	
TYPE:	NIGHT RINGING	TYPE:	NIGHT RINGING
_____		_____	
NUMBER:		NUMBER:	
_____	DAY RINGING	_____	DAY RINGING
CO LINE:		CO LINE:	
_____		_____	
TYPE:	NIGHT RINGING	TYPE:	NIGHT RINGING
_____		_____	
NUMBER:		NUMBER:	
_____	DAY RINGING	_____	DAY RINGING
CO LINE:		CO LINE:	
_____		_____	
TYPE:	NIGHT RINGING	TYPE:	NIGHT RINGING
_____		_____	
NUMBER:		NUMBER:	
_____	DAY RINGING	_____	DAYRINGING
CO LINE:		CO LINE:	
_____		_____	
TYPE:	NIGHT RINGING	TYPE:	NIGHT RINGING
_____		_____	
NUMBER:		NUMBER:	

Button #11 = Enter Ringing Assignments

Button #17 = Display Ringing Assignments

**Ringing Assignments:**

- 0 = No Ring (deletes station from Ringing Assignments)
- 1 = D (Day Ringing)
- 2 = N (Night Ringing)
- 3 = B (Both Day and Night Ringing)

Appendix A-6 Station Programming (Flash 50)

DATA FIELD	PAGE/ BTN	STATION NUMBER							DEFAULT
PAGE ACCESS	A/1								Enabled
DO NOT DISTURB	A/2								Enabled
CONFERENCE	A/3								Enabled
EXECUTIVE OVERRIDE	A/4								Disabled
PRIVACY	A/5								Enabled
SYSTEM SPEED	A/6								Enabled
QUEUING	A/7								Enabled--
PREF LINE ANSWER	A/8								Disabled
OHVO	A/9								Disabled
CALL FORWARD	A/10								Enabled
FORCED LCR*	A/11								Disabled
ACD* SUPV BARGE-IN	A/12								Disabled
OVERRIDE BLOCKING	A/13								/Allowed
CO RINGING OPTIONS	A/14								/Muted

Page "A" is selected by pressing Button #18 of the flexible buttons

STA ID (0-7)	B/1								0
COS (1-6)	B/2								1
SPEAKERPHONE (0-2)	B/3								0
PICKUP GROUP (1-4)	B/4								1
PAGING ZONES (1-4)	B/5								1
/PRESET FORWARD	B/6								None
CO LINE GROUP (0-7)	B/7								1
LCR* CLASS OF SERVICE (0-6)	B/8								0
OFF-HOOK PREFER	B/9								00
BUTTON ASSIGN	B/10	Refer to Button Assignment Chart							

Page "B" is selected by pressing Button #19 of the flexible buttons

\* Features available with optional software.



Appendix A-7 Button Assignment Chart (Flash 50)

STA # _____		PORT # _____	
1			11
2			12
3			13
4			14
5			15
6			16
7			17
8			18
9			19
10			20

21	22	23	24
25	26	27	28

STA # _____		PORT # _____	
1			11
2			12
3			13
4			14
5			15
6			16
7			17
8			18
9			19
10			20

1	1		
21	22	23	24
25	26	27	28

This chart is to be used to assign each flexible button a function. By default, Buttons 1 through 10 are assigned as Stations 100 through 109, Buttons 11 through 18 are assigned as CO Lines 01 through 8. Buttons 19 and 20 are assigned as a Loop and Pool Button respectively. Buttons 21-24 are flexible buttons with features assigned to them.

WHERE:

- BB = Button Number (01 through 28)
- LL = CO Line Number (01 through 48)
- G = Line Group (1 through 7)

**KEY STATION BUTTON PROGRAMMING:**

1. To assign a button as a multi-function button (user programmable) enter:  
BB [0] HOLD
2. To assign a button as a CO Line button, enter:  
BB [1] LL HOLD
3. To assign a button as a loop button, enter:  
BB [2] HOLD
4. To enter a button as a pooled group button, enter:  
BB [3] G HOLD
5. To unassign a button, enter:  
BB [#] HOLD

**SLT ENTRY: (Off-I-look Preference)**

1. When an SLT is being assigned for Off-Hook Preference, enter:  
00 [1] LL HOLD for a specific CO Line  
or  
00[3] G HOLD for CO Group Access.

Appendix A-9 System Speed Dial Numbers

Programmed from the first Attendant station.

Monitored by Toll Restriction (COS)

BIN #	Telephone Number	BIN #	Telephone, Number
20		41	
21		42	
22			
23		43	
24		44	
25		45	
26		46	
27		47	
28		48	
29		49	
30		50	
31		51	
32		52	
33		53	
34		54	
35		55	
36		56	
37		57	
38		58	
39		59	

Appendix A-8 System Speed Dial Numbers (Cont'd)

Programmed from the first Attendant station.

Overrides Toll Restriction (COS).

BIN #	Telephone Number	BIN #	Telephone Number
60		80	
61		81	
62		82	
63		83	
64		84	
65		85	
66		86	
67		87	
68		88	
69		89	
70		90	
71		91	
72		92	
73		93	
74		94	
75		95	
76		96	
77		97	
78		98	
79		99	

Appendix A-9 Exception Tables (Flash 70)

Allow Table A

Allow Table B

BIN 1		BIN 1	
BIN2		BIN2	
BIN 3		BIN3	
BIN 4		BIN4	
BIN5		BIN5	
BIN 6		BIN6	
BIN 7		BIN7	
BIN 8		BIN8	
BIN 9		BIN9	
BIN 10		BIN 10	
BIN 11		BIN 11	
BIN 12		BIN 12	
BIN 13		BIN 13	
BIN 14		BIN 14	
BIN 15		BIN 15	
BIN 16		BIN 16	
BIN 17		BIN 17	
BIN 18		BIN 18	
BIN 19		BIN 19	
BIN 20		BIN 20	

Deny Table A

Deny Table B

BIN 1		BIN 1	
BIN 2		BIN2	
BIN 3		BIN3	
BIN4		BIN 4	
BIN5		BIN5	
BIN6		BIN6	
BIN 7		BIN7	
BIN 8		BIN 8	
BIN 9		BIN9	
BIN 10		BIN 10	



Appendix A-I 0 Least Cost Routing (Flash 75)

CO LINE GROUPS

1	2	3	4	5	6	7

Enter what type lines are programmed in each group.

DAILY START TIME TABLE

START TIME	DEFAULT TIME	CHANGED TIME
1	0800	
2	1700	
3	2300	
4	####	

WEEKLY SCHEDULE TABLE

START TIME (From Daily Start Table)	TIME PERIOD ROUTE LIST						
	MON	TUE	WED	THU	FRI	SAT	SUN
1							
2							
3							
4							

TOLL INFORMATION ROUTE LIST TABLE	DEFAULT 00	
-----------------------------------	---------------	--

Appendix A-1 1 Route List Table

Route	Time	1st Group	Insert/ Delete	PRIO	2nd Group	Insert/ Delete	PRIO	3rd Group	Insert/ Delete	PRIO	4th Group	Insert/ Delete	PRIO	5th Group	Insert/ Delete	PRIO	6th Group	Insert/ Delete	PRIO	7th Group	Insert/ Delete	PRIO			
00	1																								
	2																								
	3																								
	4																								
01	1																								
	2																								
	3																								
	4																								
02	1																								
	2																								
	3																								
	4																								
03	1																								
	2																								
	3																								
	4																								

Appendix A-I 1 Route List Table (Cont'd)

Route	Time	1st Group	Insert/ Delete	PRIO	2nd Group	Insert/ Delete	PRIO	3rd Group	Insert/ Delete	PRIO	4th Group	Insert/ Delete	PRIO	5th Group	Insert/ Delete	PRIO	6th Group	Insert/ Delete	PRIO	7th Group	Insert/ Delete	PRIO			
04	1																								
	2																								
	3																								
	4																								
05	1																								
	2																								
	3																								
	4																								
06	1																								
	2																								
	3																								
	4																								
07	1																								
	2																								
	3																								
	4																								



Appendix A-I 1 Route List Table (Cont'd)

Route	Time	1st Group	Insert/ Delete	PRI/O	2nd Group	Insert/ Delete	PRI/O	3rd Group	Insert/ Delete	PRI/O	4th Group	Insert/ Delete	PRI/O	5th Group	Insert/ Delete	PRI/O	6th Group	Insert/ Delete	PRI/O	7th Group	Insert/ Delete	PRI/O	
	1																						
	2																						
	3																						
	4																						
	1																						
	2																						
	3																						
	4																						
	1																						
	2																						
	3																						
	4																						
	1																						
	2																						
	3																						
	4																						

Appendix A-I 1 Route List Table (Cont'd)

Route	Time	1st Group	Insert/ Delete	PRIO	2nd Group	Insert/ Delete	PRIO	3rd Group	Insert/ Delete	PRIO	4th Group	Insert/ Delete	PRIO	5th Group	Insert/ Delete	PRIO	6th Group	Insert/ Delete	PRIO	7th Group	Insert/ Delete	PRIO		
12	1																							
	2																							
	3																							
	4																							
13	1																							
	2																							
	3																							
	4																							
14	1																							
	2																							
	3																							
	4																							
15	1																							
	2																							
	3																							
	4																							

Appendix A-1 2 Insert/Delete Tables

TABLE	DIGITS DIALED	
00	INSERT	PRE
		POST
	DELETE	(PRE)
01	INSERT	PRE
		POST
	DELETE	(PRE)
02	INSERT	PRE
		POST
	DELETE	(PRE)
03	INSERT	PRE
		POST
	DELETE	(PRE)
04	INSERT	PRE
		POST
	DELETE	(PRE)
05	INSERT	PRE
		POST
	DELETE	(PRE)
06	INSERT	PRE
		POST
	DELETE	(PRE)
07	INSERT	PRE
		POST
	DELETE	(PRE)
08	INSERT	PRE
		POST
	DELETE	(PRE)
09	INSERT	PRE
		POST
	DELETE	(PRE)
10	INSERT	PRE
		POST
	DELETE	(PRE)
11	INSERT	PRE
		POST
	DELETE	(PRE)
12	INSERT	PRE
		POST
	DELETE	(PRE)

Appendix A-12 Insert/Delete Tables (Cont'd)

T A B L E		D I G I T S   D I A L E D	
13	INSERT	PRE	
		POST	
	DELETE	(PRE)	
14	INSERT	PRE	
		POST	
	DELETE	(PRE)	
15	INSERT	PRE	
		POST	
	DELETE	(PRE)	
16	INSERT	PRE	
		POST	
	DELETE	(PRE)	
17	INSERT	PRE	
		POST	
	DELETE	(PRE)	
18	INSERT	PRE	
		POST	
	DELETE	(PRE)	
19	INSERT	PRE	
		POST	
	DELETE	(PRE)	





Appendix A-I 5 LCR Exception Code Table

CODE #	EXCEPTION CODES (XX)	ROUTE (00-1 5) (RR)	CODE #	EXCEPTION CODES (XX)	ROUTE (00-1 5) (RR)
1			1 1		
2			12		
3			13		
4			14		
			15		
6			16		
7			17		
8			18		
9			19	,	
10			20	I	

## APPENDIX B

# DIGITAL SYSTEMS PART NUMBERS

### Appendix B-1 Digital System Component List

Description	Part No.
<b>Starplus SPD 4896 Components:</b>	
Key Service Unit (KSU)	4800-00
Central Processor Unit (CPU)	4830-00
Voice Control Board (VCB)	4830-I 0
Key Telephone Board (KT12)	4832-00
Single Line Board (SL12)	4833-00
CO Line Board (C012)	4831-00
Power Supply	4871-00
<b>Starplus SPD 4896 Digital Terminals:</b>	
34-Button Executive (Display) Telephone	1414-XX*
34-Button Executive/PC Interface Telephone	1418-XX*
34-Button Enhanced (Non-Display) Telephone	1412-XX*
14-Button Basic Telephone	1411-XX*
DSS/DLS Console Unit	141 o-xx*
DSS/DLS Expansion Module	1410-10
Handset Assembly	1464-XX*
34-Button Wall Mount Bracket	1440-XX*
Single Line Adapter (SLA)	1484-00
<b>Starplus Digital Systems Manuals:</b>	
Description, Installation and Maintenance Manual	4850-00
Station User's Guide (pkg of 6)	4852-00
SLT User's Guide (pkg of 6)	4853-00
Attendant User's Guide	4854-00
Automatic Call Distribution (ACD) User's Guide (pkg of 6)	4855-00
<b>Starplus Digital Systems Optional Components:</b>	
4-Circuit DTMF Receiver Module (DTM4)	4834-00
Relay/Sensor Interface Module	1435-00
Digital Data Interface Unit (DDIU)	1485-00
Backplane I/O RS-232C Expander Module	4873-00
Tri-Output Power Supply	4872-00

\* Colors: 08=Off White, 60=Burgundy, 70=Lt. Gray, 71 =Charcoal Gray



## APPENDIX C

# ICLID GENERAL DESCRIPTION

### 1. INTRODUCTION

This specification provides the functional and implementation definition for the addition of the ICLID feature to the Starplus Digital Key Telephone Systems.

### 2. SYSTEM CONFIGURATION

The following illustration depicts the configuration presumed for the implementation of the ICLID feature for the system. The phones are presumed to be in an ACD or UCD group in order to allow proper operation with the system.

### 3. FUNCTIONAL PERFORMANCE

The ICLID (Incoming Calling Line IDentification) feature has been added to the Starplus Digital Key Systems as a first step in providing it generally. The key system operation of this feature is dependent on the feature first being activated from the central office so that the numbers of the calling party will be

delivered over the individual tip and ring of the CO lines during the first silent interval between ringing.

The features implemented are:

1. Display of calling number/name on initial ring-in of a line on the display keysets.
2. Recording of incoming call number/name on the SMDR printout.
3. Management of an "unanswered call" table from a display phone with appropriate privilege level to allow tracking of unanswered calls for statistical information and return call management.
4. Local translation of incoming numbers to names according to a table of number/name equivalences which can be administered by the system.

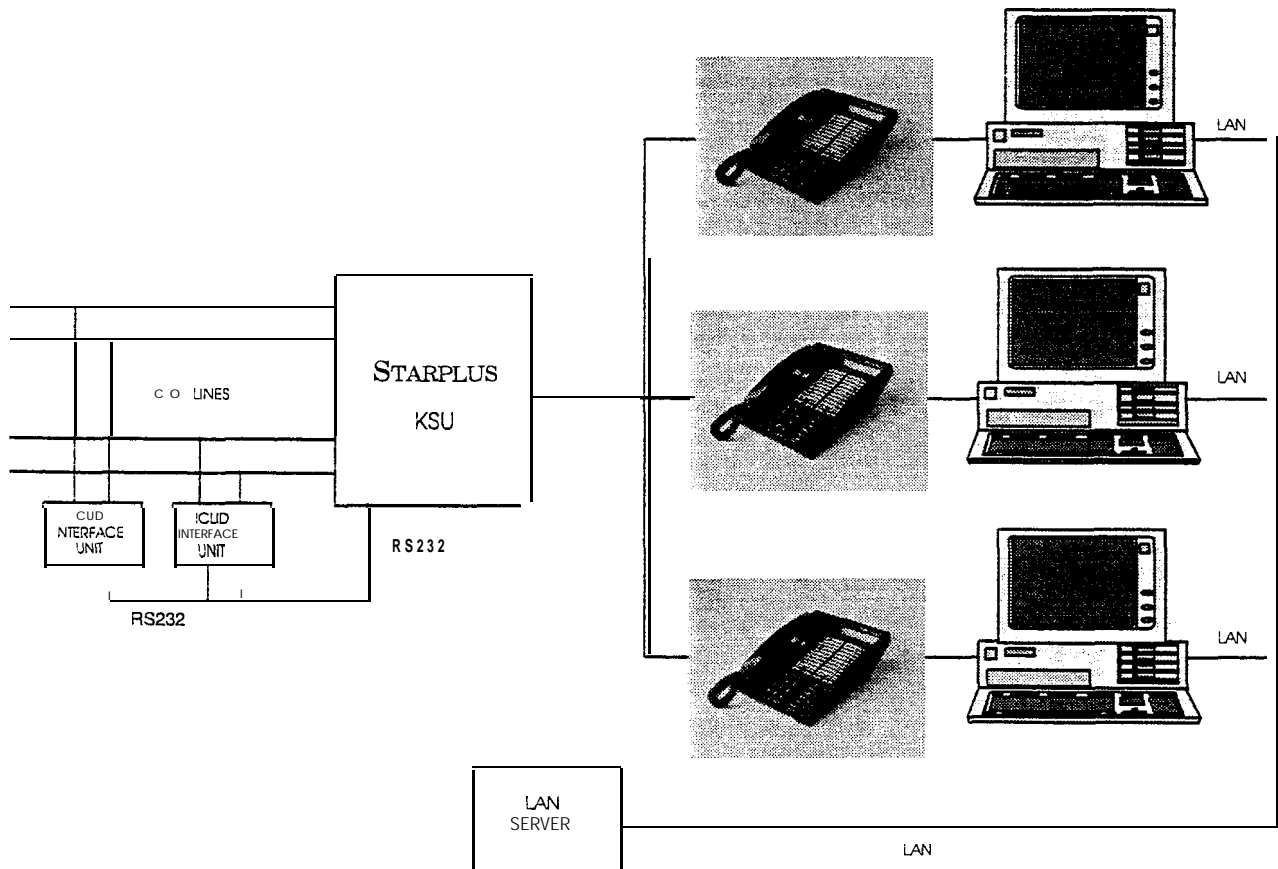

Figure 1 ICLID System Configuration

**ICLID GENERAL DESCRIPTION**

**A. Calling Number/Name Display**

This feature is intended as the **basic offering** of the **ICLID service when associated with the Starplus Digital Key Telephone System**. Essentially, whenever an incoming call is received at the system, the number received along with the ringing signal will be stored in the line control tables and used at various points in the processing of the call.

The primary function will be that the calling number will be displayed (if available) at any point at which the "LINE RINGING" is displayed in the system.

In addition, with the availability of the calling name feature, if the calling name is provided, the system will deliver that to the display instead of the calling number.

The specification for this feature is that the system will display its "LINE RINGING" message as normally implemented and alter that display to the calling number/name if the information is made present on the line. This will allow the normal operation of the system when ICLID information is not presented or the device which intercepts it and provides the information to the KSU is missing or failed.

00000000011111111122222
123456789012345678901234
bbbbbbNNNNNNNNNNNNNNNNNNbbbbbb

or

XXXXXXXXXXXXXXXXXXXXXXXXXX
----------------------------

If the *calling name* is available, the display will be shown as above where the X's represent the internal table storage of the calling name. Note that although the Central Office delivery of the calling name is **15-characters**, the internal table used to store the name for translation of a received number is **24-characters** in width. If the Central Office delivers a name, it will be positioned left justified in the **24-character** field on the display. Note that if a number is received which matches a number/name translation, the translated name will be used and the name delivered from the Central Office will be effectively discarded.

If no name is available, either supplied from the Central Office or internally from the translation table, the delivered number will be positioned centered in the display as shown above for the 14 N's.

**B. Incoming Number/Name SMDR**

As with the above feature implementation, the intent is that the system operate normally in the absence of ICLID information or the failure of the ICLID equipment. If the information is present at the time that an SMDR record is generated for a call, it will alter the content and format of the SMDR output record.

If the calling number is **available**, the number will be output in the SMDR record in the same location as the dialed number is located in the outgoing calls.

If the calling name is present, an additional line will be output in the SMDR identifying the name. This record will immediately follow the **normal** SMDR record. The normal SMDR record will include an indicator which identifies that a following record with name identification is present.

Unanswered calls will be recorded on the SMDR for incoming as a system option to allow the identification of callers for statistical and callback purposes. These calls will be identified with an indicator in the SMDR record.

**c. Unanswered Call Management**

An Unanswered Call Management Table with 100 entry capacity for the **Starplus SPD 4896** system is maintained in the system. The calling number/name information pertaining to any unanswered call will be placed in this table at the time the system has determined that the call has been abandoned.

This table may be administered from appropriately privileged phones so that the unanswered calls may be reviewed and handled by the customer.

**D. Local Name Translation**

An administrable table provides a local translation from a received calling number to a name. This table can be administered by the customer from the attendant console location. In cases of conflict between the name delivered from the CO and that in the local translation table, the local translation table shall rule. 200 entries are provided for the **Starplus SPD 4896** system.

**4. ICLID Display Phone Operation**

The phone, modified as described in paragraph, will be used to deliver specific data messages identifying call states to a device attached to the phone via a serial channel following the data transmission requirements of RS-232C. The interface parameters to be used are **2400bps**, no parity, 8 data bits, and 1 stop bit. The implementation of this will be to deliver ICLID data to a Personal Computer attached to the

phone for look-up of customer records and subsequent processing by the individual answering the telephone call.

**A. Information from the Phone to the PC**

The messages are provided from the **keyset** to the connected PC are shown in the table below.

The formats of these messages are shown in the table below.

These messages are transmitted from the KSU to the phone and subsequently from the phone to the data line as the appropriate events occur within the system. Each event is separate and does not require any history to be maintained. A PC connected to the phone must be prepared to accept and process any of these messages at any time.

The data is sent from the KSU to the **keyset** using command FO. The **keyset** then takes the data byte and sends it out to the PC at 2400 baud, no parity, eight data bits, and one stop bit. There is no handshaking in the **keyset** so the PC must always be ready to receive the data sent to it. The data is in the form specified in the ICLID specification.

**B. Information from the PC to the Phone**

The ICLID phone allows information from a connected PC to be used to simulate button depressions internally within the phone. The characters sent from the PC to the phone must be paced to provide at least **100ms** between characters (500ms for DTMF pad depressions). The data received from the PC is converted to keystroke data. The data is received at 2400 baud, no parity, eight data bits, and one stop bit. There is no handshaking in the **keyset** receive. To allow the **keyset** time to send the data to the KSU character pacing of **100ms** is required. To allow DTMF outgoing digits to complete, 500ms pacing is required. The character received has bits seven and eight striped off and is converted to the key strokes as per the following chart. Time must be allowed from the access of a CO line before digits are sent out to the line. The following table lists The ASCII characters and the button depression they cause.

Message Type	Message Format	Size
1. Caller information	1iiNNNNNNNNNNNNNNNN , NXXXXXXXXXXXXXXXXX XXXXXXXX (Cr)	42
2. Call answered at this station.	2ii (Cr)	4
3. Call answered at some other station.	3ii (Cr)	4
4. Call abandoned.	4ii (Cr)	4
5. Call completed at this station (on-hook).	5ii (Cr)	4
6. Transferred ICLID call.	6iiNNNNNNNNNNNNNNNN XXXXXXXXXXXXXXXXXXXX xxxxx ( Cr )	42
7. Recalled ICLID.	7iiNNNNNNNNNNNNNNNN XXXXXXXXXXXXXXXXXXXX XXXXX (Cr)	42

Note: ii = Two bytes used to identify a call for subsequent messages so that a PC will be able to identify current call status for processing purposes.

N...N = This is the number received from the Central Office.

X...X = This is the name to be used for look-up purposes as delivered either from the Central Office or via the number to name internal translation in the system.

ICLID GENERAL DESCRIPTION

HEX Value	Btn #	Pacing	ASCII Char(s)
00	Keypad Reset		NUL
01	Flex #01	100ms	SOH
02	Flex #02	100ms	STX
03	Flex #03	100ms	ETX
04	Flex #04	100ms	EOT
05	Flex #05	100ms	ENQ
06	Flex #06	100ms	ACK
07	Flex #07	100ms	BEL
08	Flex #08	100ms	BS
09	Flex #09	100ms	HT
0A	Flex #10	100ms	LF
0B	Flex #11	100ms	VT
0C	Flex #12	100ms	FF
0D	Flex #13	100ms	CR
0E	Flex #14	100ms	SO
0F	Flex #15	100ms	SI
10	Flex #16	100ms	DLE
11	Flex #17	100ms	DC1
12	Flex #18	100ms	DC2
13	Flex #19	100ms	DC3
14	Flex #20	100ms	DC4
15	Flex #25 <sup>4</sup>	100ms	NAK
16	Flex #26 <sup>5</sup>	100ms	SYN
17	Flex #27 <sup>6</sup>	100ms	ETB
18	Flex #28 <sup>7</sup>	100ms	CAN
19	Digit 1	500ms	EM
1A	Digit 4	500ms	SUB
1B	Digit 7	500ms	ESC
1C	Digit *	500ms	FS
1D	Flex #09	100ms	GS
1E	Flex #19	100ms	RS
1F	HOLD	100ms	US
20	TRAN	100ms	SP
21	Digit 2	500ms	!
22	Digit 5	500ms	"
23	Digit 8	500ms	#
24	Digit 0	500ms	\$
25	Flex #10	100ms	%
26	Flex #20	100ms	&
27	FLASH	100ms	'
28			(
29	Digit 3	500ms	)
2A	Digit 6	500ms	*
2B	Digit 9	500ms	+
2C	Digit #	500ms	,
2D	SPEED	100ms	-

2E	MUTE	100ms	.
2F	ON/OFF	100ms	/
30	H/W	Error	0
31			1
32			2
33			3
34			4
35			5
36			6
37			7
38			8
39			9
3A			
3B			
3c			<
3D			=
3E			>
3F			?

<sup>4</sup> Normally the MSG button.  
<sup>5</sup> Normally the FWD button.  
<sup>6</sup> Normally the DND button.  
<sup>7</sup> Normally the CONF button.

5. IMPLEMENTATION PLAN

The reference for this data delivery is the BellCoRe specification TR-TSY-000030 Issue 1 dated November 1988. Other specifications will be consulted as they become available. In particular, the implementation of the multiple message format provided by Northern Telecom must be examined for deviations from the multiple message format definition in the TR-TSY-000030 document.

The steps necessary to implement this are detailed in the following sections.

A. ICLID KTU Display Phone

The ICLID KTU provides transmit, receive, and ground data lines from the phone p-processor which are used on command from the KSU to output information. The use of this capability would be to output the ICLID information to a PC attached to the phone. Future use could be made of this capability for low speed data provided to equipment attached to the phone.

**B. Table Structures**

**a Incoming Number Table (per CO line)**

CO Line	Received # (14)	Received Name (24)	Date (2)	Time (2)	CO Line (2)
1					
2					
3					
•	•	•	•	•	•
•	•	•	•	•	•
•	•	•	•	•	•
n-1					
n					

**b Unanswered Call Table**

I	CO Line	Received # (1 4)	Received Name (24)	Date (2)	Time (2)	CO Line (2)
	0					
Oldest Index	2					
Newest index	3					
	4					
•	•	•	•	•	•	•
•	•	•	•	•	•	•
•	•	•	•	•	•	•
	48					
	49					

**c Number to Name Translation Table**

Entry #	Received # (14)	Received Name (24)
0		
1		
2		
•	•	•
•	•	•
•	•	•
99		

# STARPLUS®

## PRODUCT NOTICES



DATA: \* \* \*



# PRODUCT NOTICE

PN0001  
Starplus Digital Systems  
July 18, 1995

---

## Capacitor Discharge Procedure

**AFFECTED PRODUCTS:** 612-00, 1400-00 (612 KSU and 1428 Basic KSU)

**SYMPTOM:** To ensure proper initialization of memory at start up and proper memory protection which should eliminate the potential of inoperative cards, circuits, and telephones which may appear as false out of box failures.

**RESOLUTION:** A Procedure has been developed to clear the contents of **RAM** by discharging the capacitor which provides the voltage for the RAM chips when the AC power is off.

**PROCEDURE:**

1. Disconnect any AC power from the 612 KSU, 1400-00 Basic KSU, and any expansion KSU. Remove the cover from the KSU or Basic KSU.  
*Refer to the reference illustration for Steps 2-3*
2. Locate the IC U18 in the lower right corner of the 612 KSU or 1400-00 Basic KSU.
3. Connect one lead of a jumper wire to Pin 2 of U18. Connect the other end of the jumper wire to Pin 4 of U18.
4. Maintain this connection for 30 seconds. Remove the jumper wire and power the system up.



Top of KSU

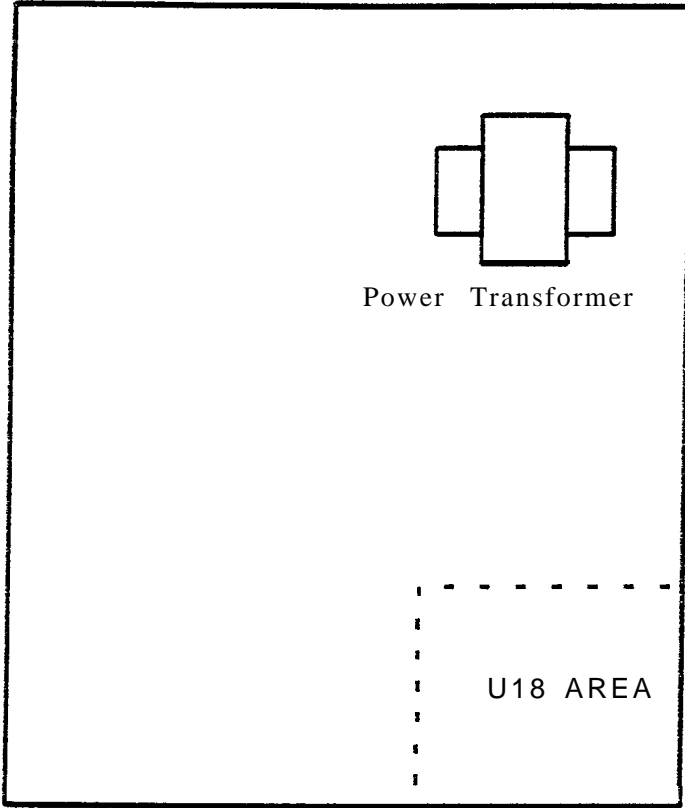

AREA IN DETAIL

ResetSwitch



Super-Capacitor

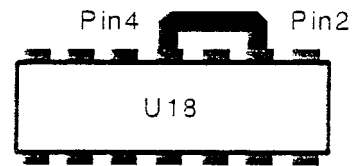



# PRODUCT NOTICE

PN0003  
Starplus Digital Systems  
July 18, 1995

## Start up and Initialization Procedure

**AFFECTED PRODUCTS:** 2830-00, 2830-16, 4830-00 (2856 CPU's and 4896 CPU)

**SYMPTOM:** To **ensure** proper initialization of memory at start up and proper memory protection which should eliminate the potential of inoperative cards, circuits, and telephones which may appear as false out of box failures.

**CONDITIONS:** The Ni-Cad battery that backs up the **RAM** has a backup time of approximately 72 hours if it is fully charged. When this battery is partially discharged, it cannot sufficiently protect the memory and contamination of the memory can occur. This can lead to erratic operation and/or failure of the system or its' components to properly power up. If the CPU cards have not had power applied long enough to fully charge the battery (48 hours) -or- if the CPU board has not had power to it for 72 or more hours after being fully charged. the following procedure must be utilized.

**PROCEDURE:** 1. Unpackage the CPU and check the battery jumper straps against the following table:

CPU TYPE	BATTERY ENABLED (JUMPER J3)	BATTERY DISABLED (JUMPER J3)
2830-00 or -16	Pins 2-3	Pins 1-2
4830-00	Pins 2-3	Pins 1-2

If the battery is enabled, remove the strap and let the battery sit for 5 minutes

**CAUTION:**  
Removing the battery strap will cause **loss** of all data programmed up to this point.

2. Install the battery jumper (J3) strap between pins 2-3 to enable the battery.

**CAUTION!**

At this time the system should be **equipped** with the following minimum equipment:

<b>2800-00</b>	<b>CPU/VCB, 4 x 8 Station card in first slot, LCD set at station 100</b>
<b>4800-00</b>	<b>CPU, VCB, KT12 in first slot, LCD set at station, 100.</b>

3. Power up the system. After initial power up, do not touch any buttons on any installed phones for 5 minutes.
4. After 5 minutes, using station 100, initialize the entire system database. Dial "3226, press the FLASH button and dial 80, press button 8, press the HCLD button. This will initialize the entire RAM contents to a default database.
5. Leave power to the CPU card for 48 continuous hours to fully charge the battery,

**CAUTION:**

**If you stage the equipment at your shop, make sure that the equipment is installed within 72 hours of removing power.**

6. You may now program the customer site specific data into memory during the 48 hour period.



# PRODUCT NOTICE

PN0006  
Starplus Digital Systems  
July 18, 1995

---

## EPROM Speed

**AFFECTED PRODUCTS:** 1400-00, 2830-00, 2830-16, 4830-00 (1428 KSU, 2856 CPU's, and 4896 CPU)

**SYMPTOM:** The system may exhibit erratic operation and intermittent operation problems. This problem could be caused by EPROM (erasable programmable read only memory) that has improper access speed. EPROM memory is used by the telephone systems to store the software operating instructions.

**CONDITIONS:** The proper EPROM access speed for each of the systems is as follows:

1400-00	KSU	150 nanoseconds (100ns is acceptable)
2830-00 or -16	CPU	100 nanoseconds
4830-00	CPU	100 nanoseconds

**PROCEDURE:** The location information of the EPROMS (silkscreened on the PCS) for each of the systems is as follows:

1400-00	KSU	U41 & U42
2830-00 or -16	CPU	U5 & U16
4830-00	CPU	U45 & U48

The EPROM speed is determined by locating the part number that is silkscreened on the EPROM itself. After the part number, a -XX will be shown. The -XX will either be:

- 10 = 100 nanoseconds
- 15 = 150 nanoseconds

If you find the CPU or KSU is equipped with the improper speed EPROM, they need to be replaced with the proper speed ones using standard Vodavi MRA procedures. All new product shipping from Vodavi is shipping with properly matched EPROM access speeds.



# PRODUCT NOTICE

PN0008  
Starplus Digital Systems  
July 18, 1995

---

## Codec information

**AFFECTED PRODUCTS:** 1400-00, 1402-00, 1431-00, 1432-00, 1433-00, 2831-00, 2831-1 0, 2831-20, 2833-00, 4831-00, 4831-10, 4831-20

**SYMPTOM:** In certain site specific environments (a quiet office or a quiet CO line), background noise from the environment may be interpreted as noise on the call. Not all locations are affected by this noise. This condition may appear as low level clipping of the voice and is caused by the zero cross over circuit in the codec IC used on all CO lines. This situation arose as a result of a revision change to the codec IC used on all CO lines by the manufacturer of the IC. VCS has corrected this in production and repair; however you may find locations where the condition is present and it can be annoying to the customer.

**RESOLUTION:** If the CO codec (coder/decoder) IC's are of a certain revision, susceptibility to this problem may be heightened. The solution is to utilize two specific versions of a Texas Instruments 3054 type codec.

**PROCEDURE:** To determine the codec types:  
Use the attached diagrams to locate the CO line codec IC's on each board type.  
Each codec has a part number and manufacturer information silkscreened on top of it.

Acceptable codec(s):

Pan Number: TP3054AN  
Mfg. Info Any

Pan Number: TP3054BN  
Mfg. Info: AAAAAAXN

The X must equal letters D-G in the manufacture information line to be the proper revision. The X will always be the next to last digit on the manufacture line regardless of the length of the line.

If you find a suspect codec IC and your customer is experiencing these symptoms, the unit should be replaced with a non-suspect unit. Your suspect unit can be upgraded using standard Vodavi **MRA** procedures.

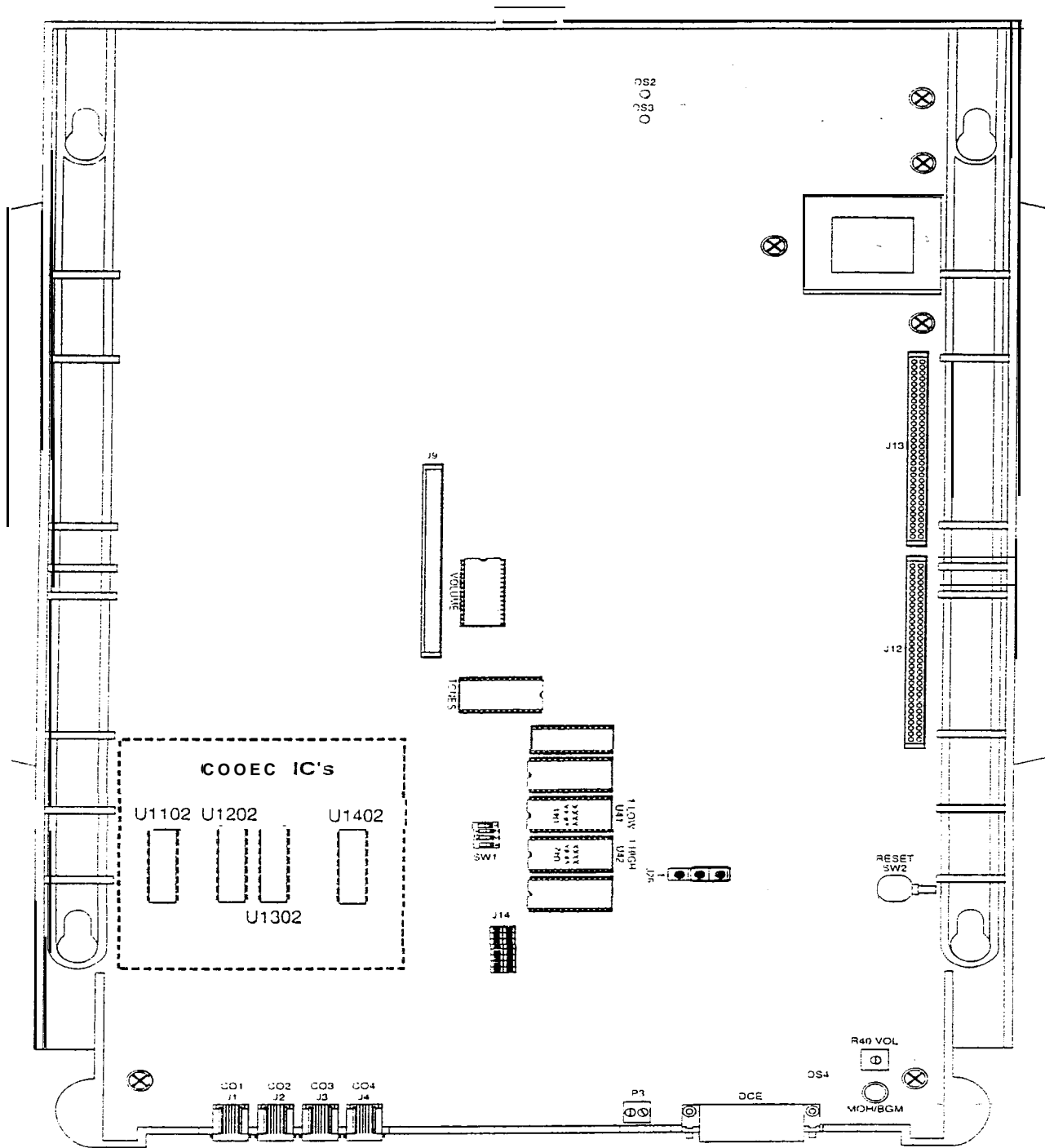

1400-00 KSU

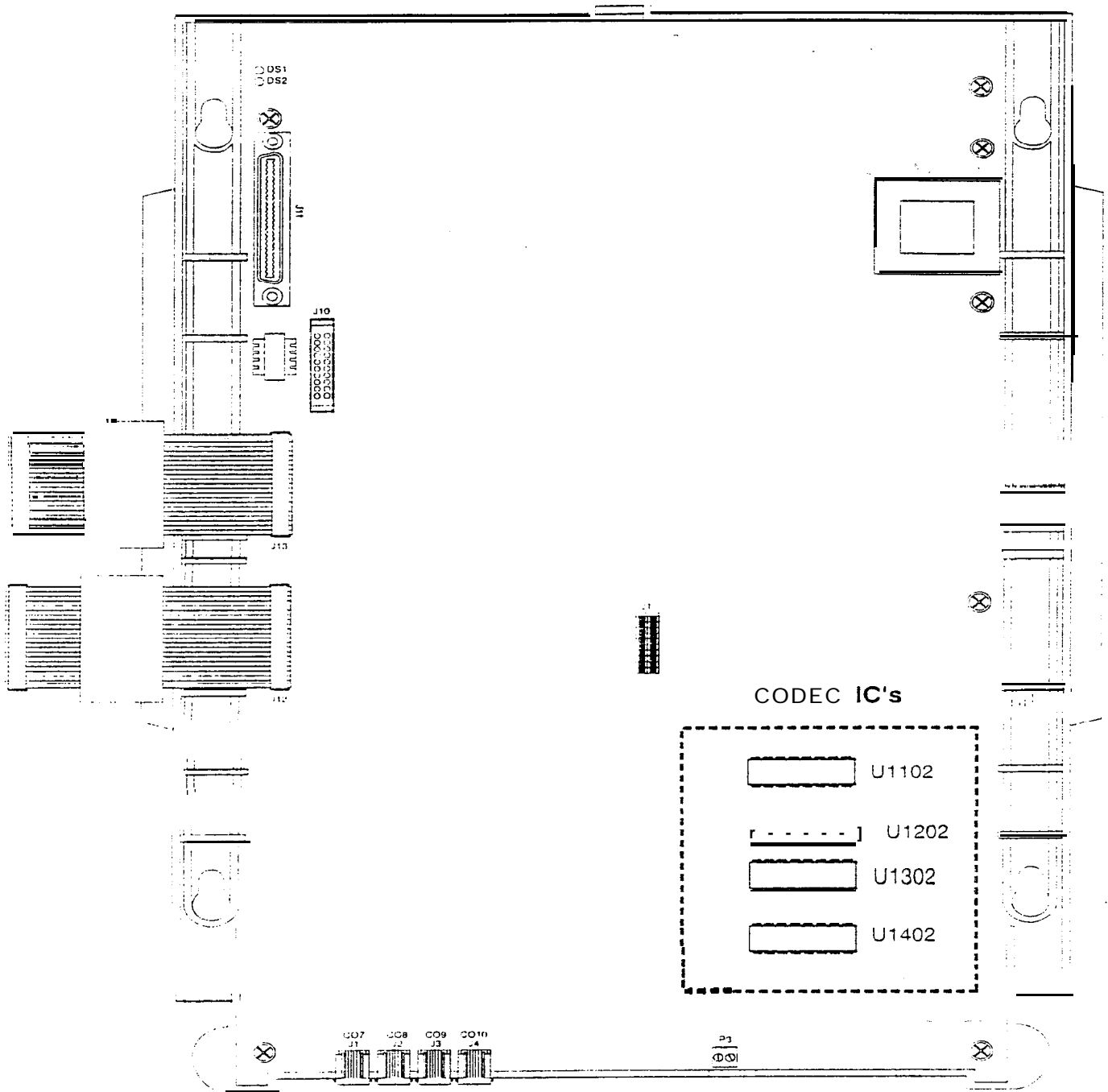

1402-00

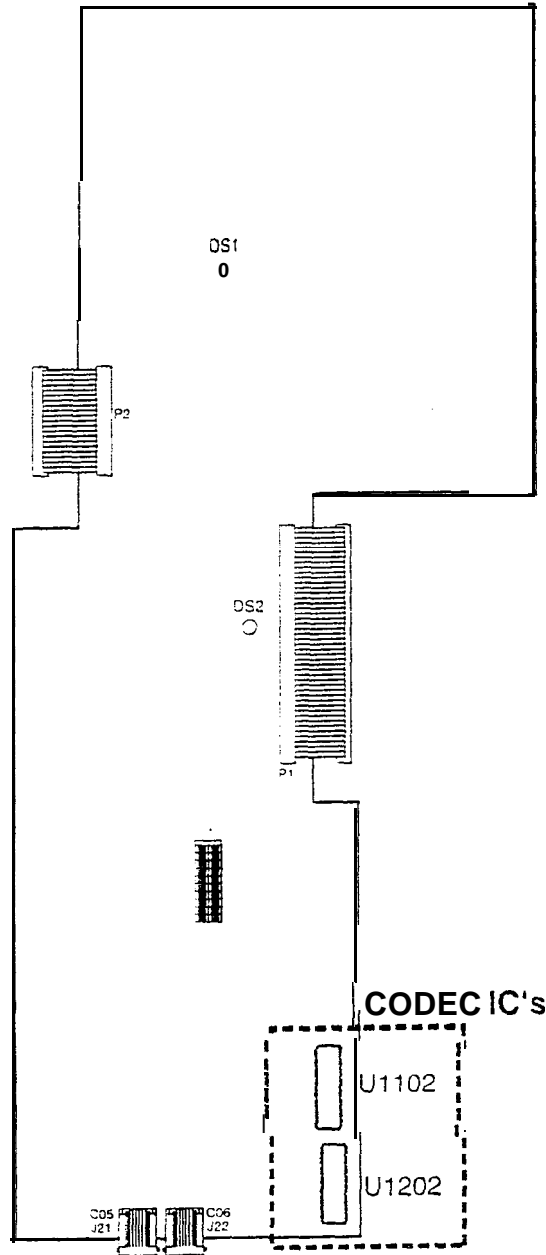

1431-00



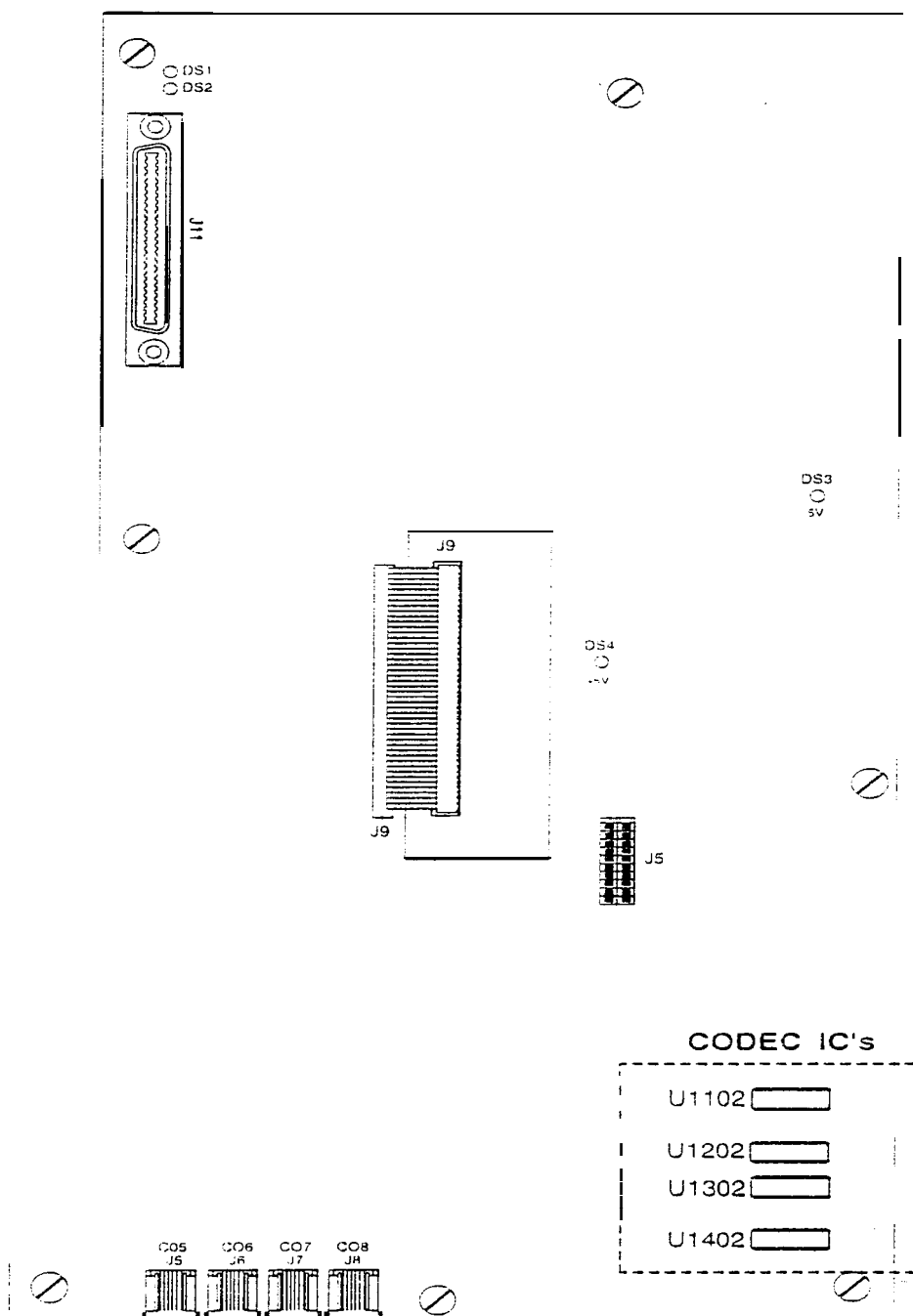

1432-00

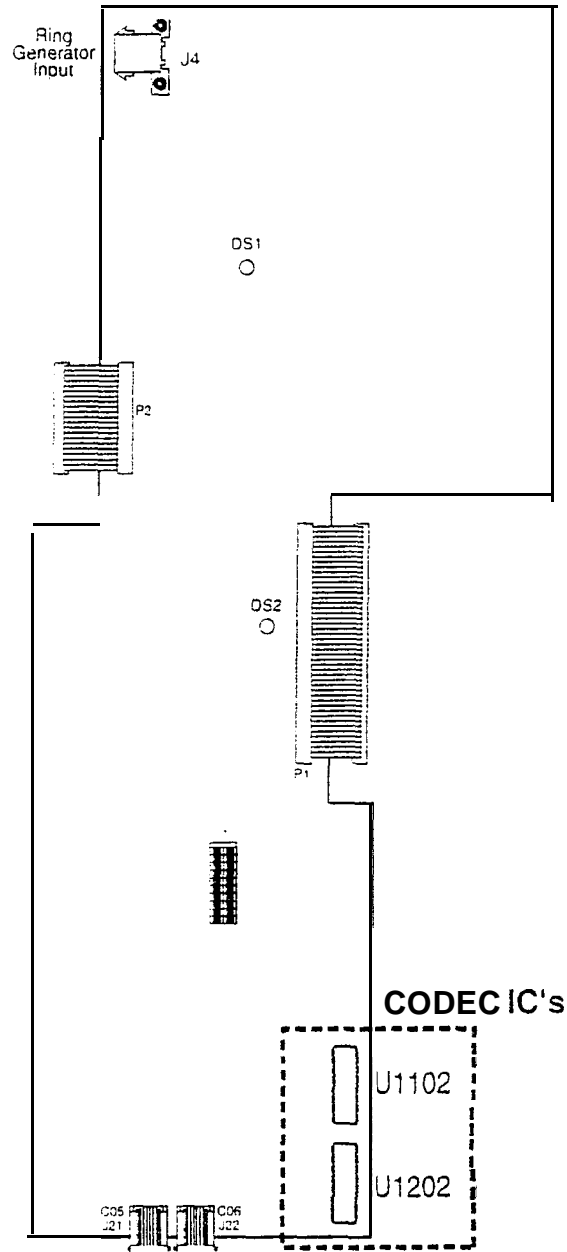

1433-00

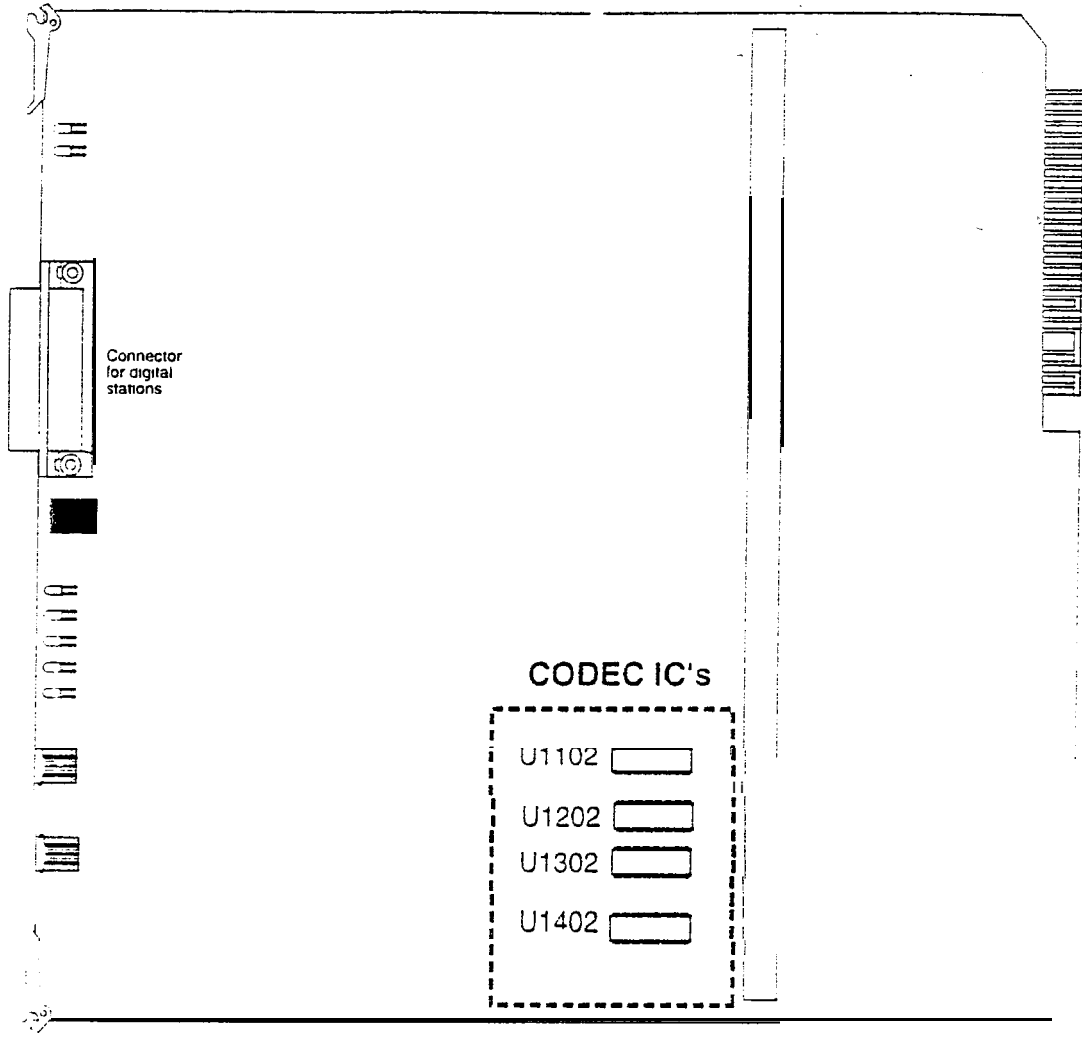

2831-00

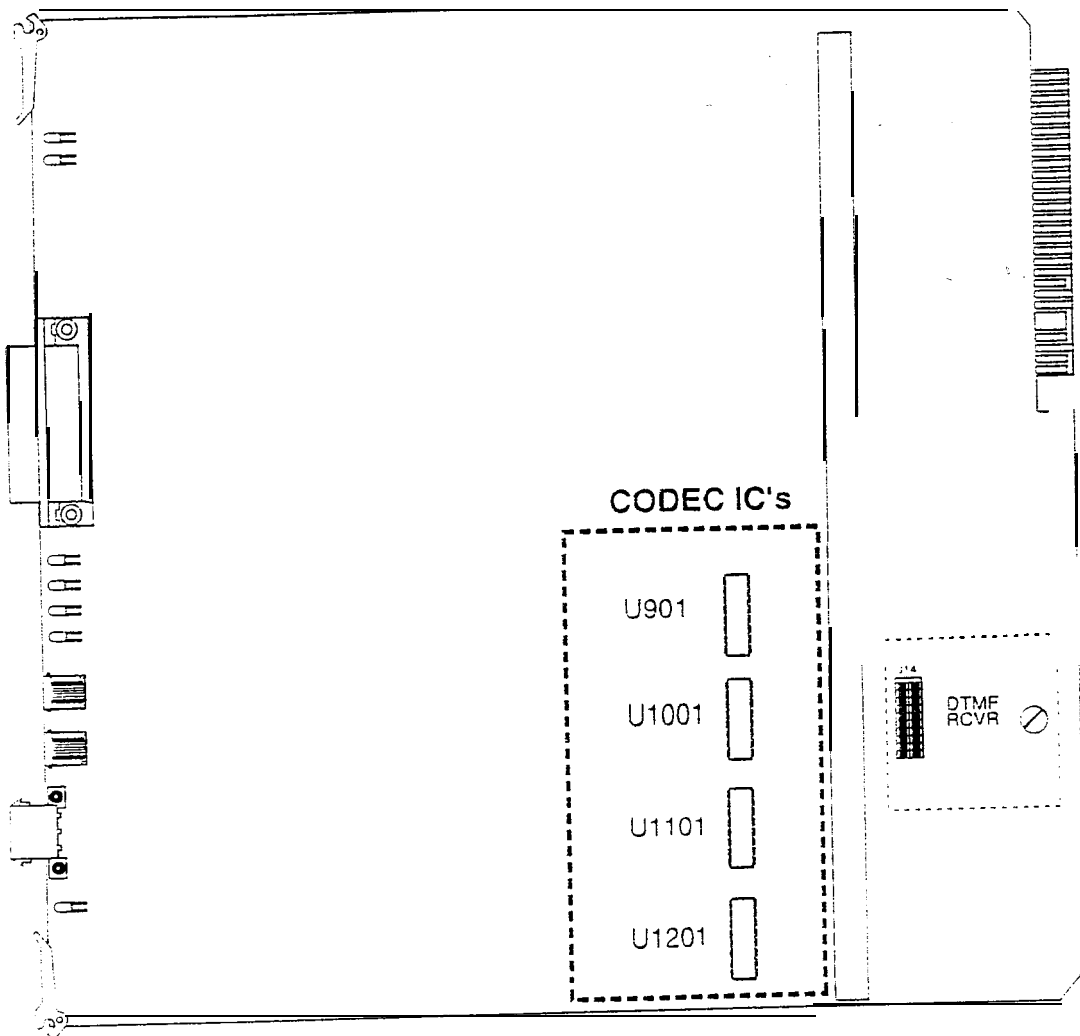

2831-10

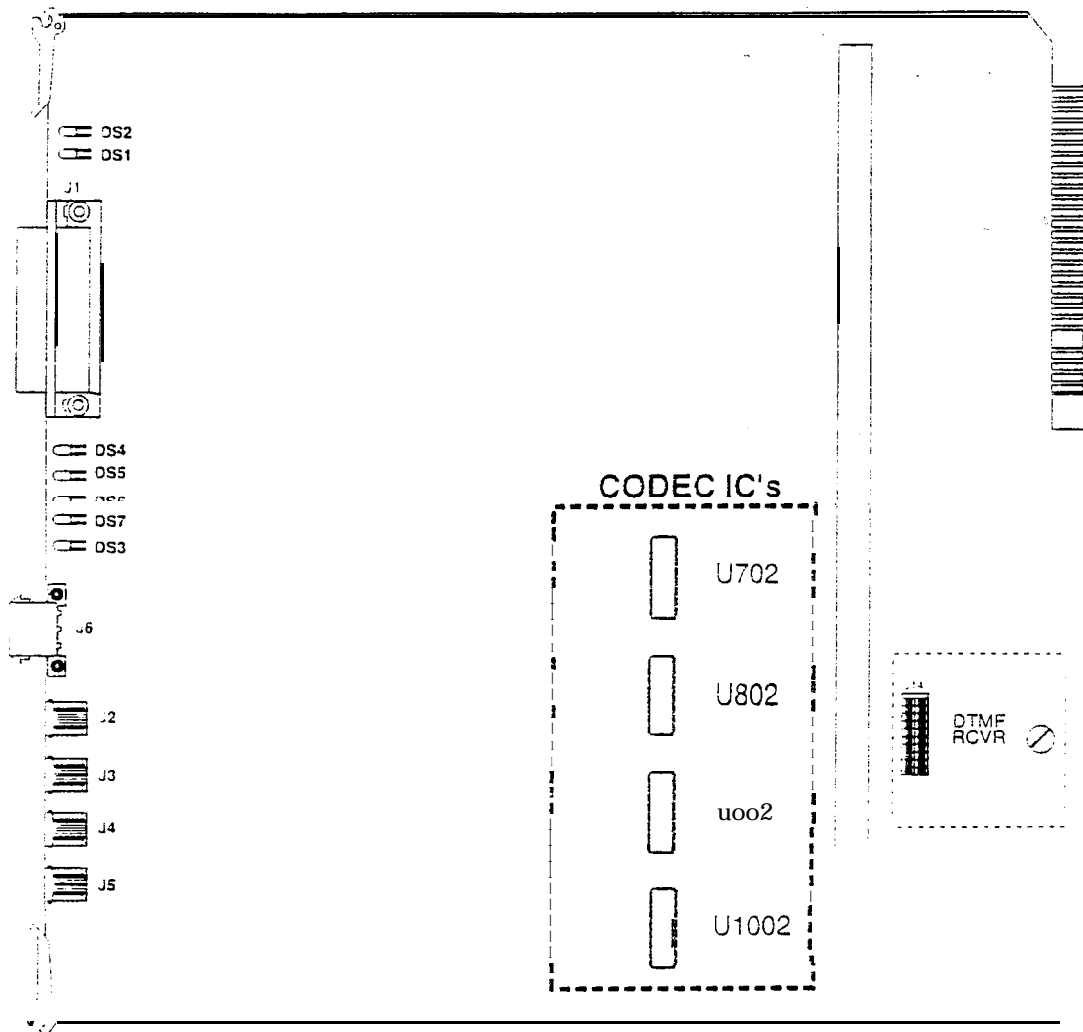

2831-20

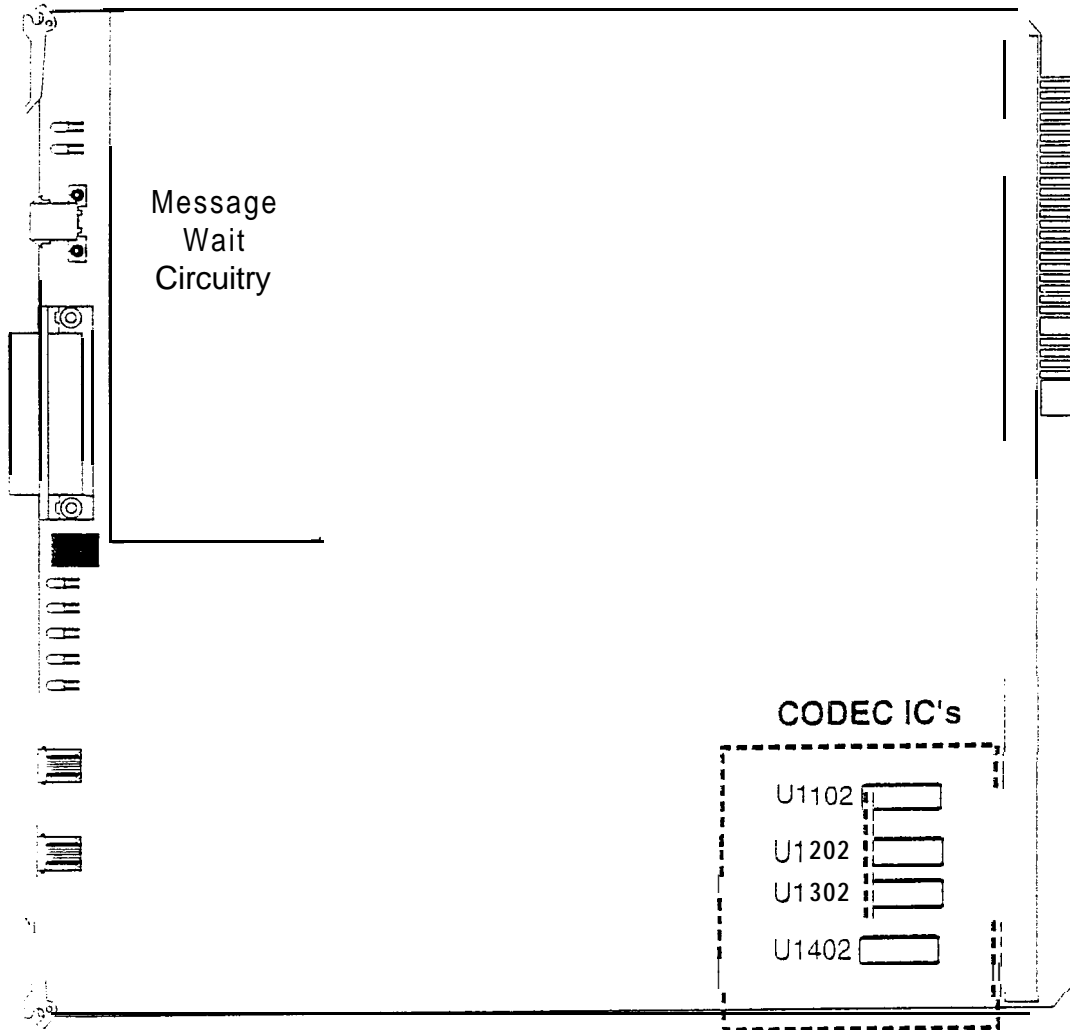

2833-00

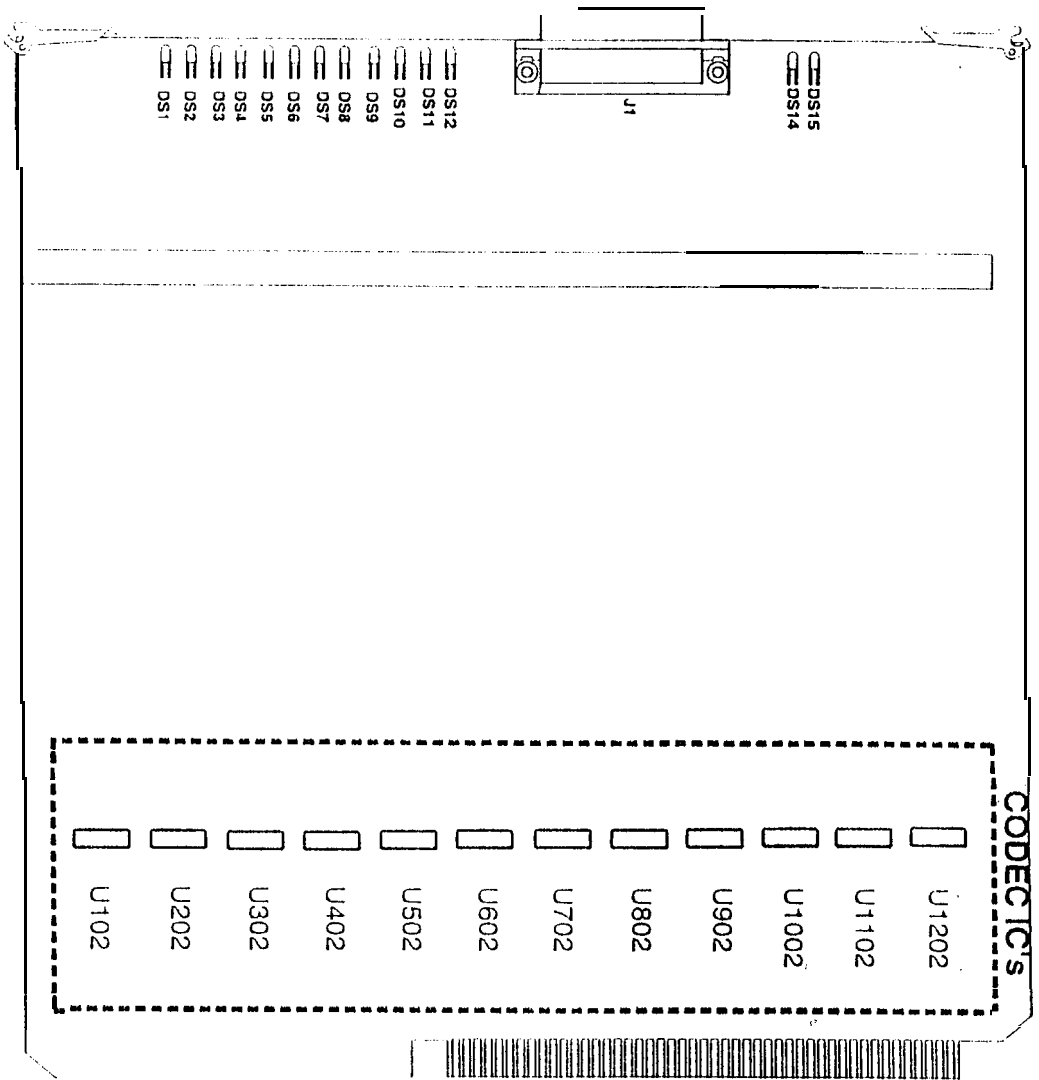

4831-00

Pa

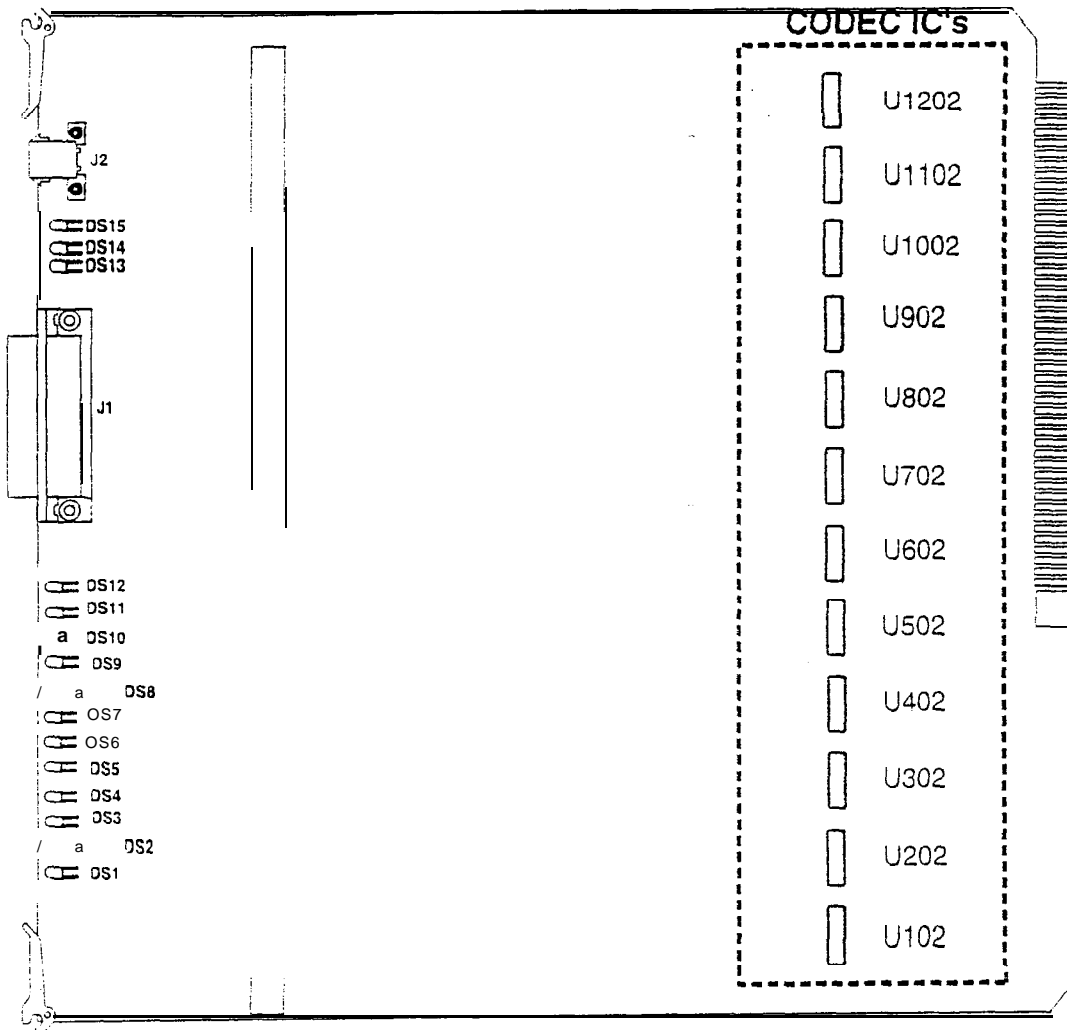

4831-10



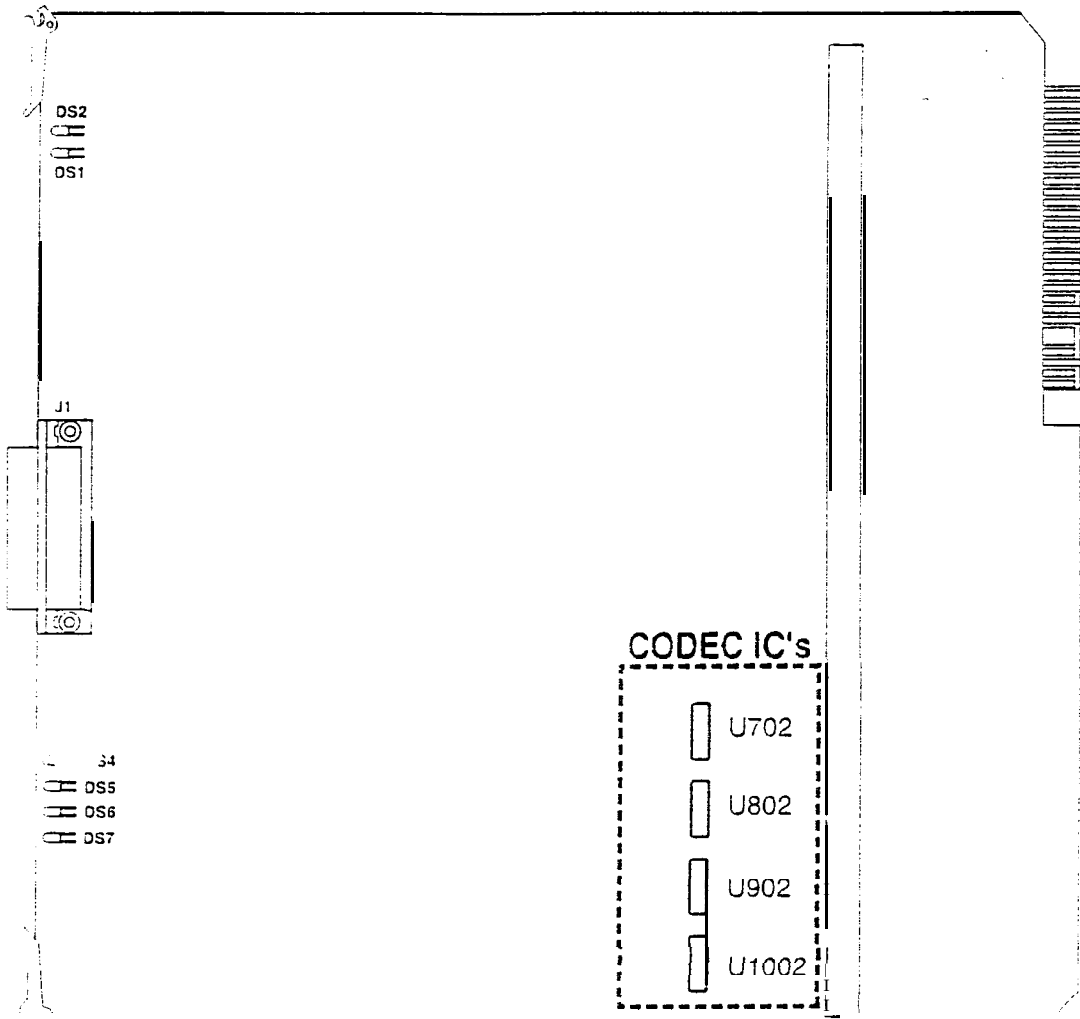

4831-20



# PRODUCT NOTICE

PN0010  
Starplus Digital Systems  
July 18, 1995

---

## Static Noise on CO Lines

**AFFECTED PRODUCTS:** 2856 CPU (2830-00 or 2830-I 6)

**SYMPTOM:** There may be times when processor communication with a CO board causes a low level static noise to be present during conversation on CO lines. This condition is caused by the timing circuit in the IC chip and was changed by the chip manufacturer during a revision update. To resolve this condition, a new type of IC chip was selected and implemented into production and repair.

**RESOLUTION:** After determining that external problems on the CO line are not causing the noise, the CPU card must be removed from the system and examined. If the old IC chip is installed on the board, it needs to be repaired with the new IC. To identify the problem IC, look for U55 as shown in the attached drawing.

1. Verify that the IC is a 74HCT138 or a 74HC138. If U55 is a 74HC138 type, you can re-install the board as the IC is correct.
2. If the chip is a 74HCT138 type, look at the date code on the CPU board. Compare the date code against the table below to determine if the IC is correct. If correct, re-install the board. If incorrect, follow standard Vodavi MRA procedures to have the board repaired or replaced.

**PROCEDURE:**

U55	DATE CODE ON PCS	CORRECT	INCORRECT
74HCT138	4094 and above		X
74HCT138	3994 and below	X	
74HC 138	ALL	X	

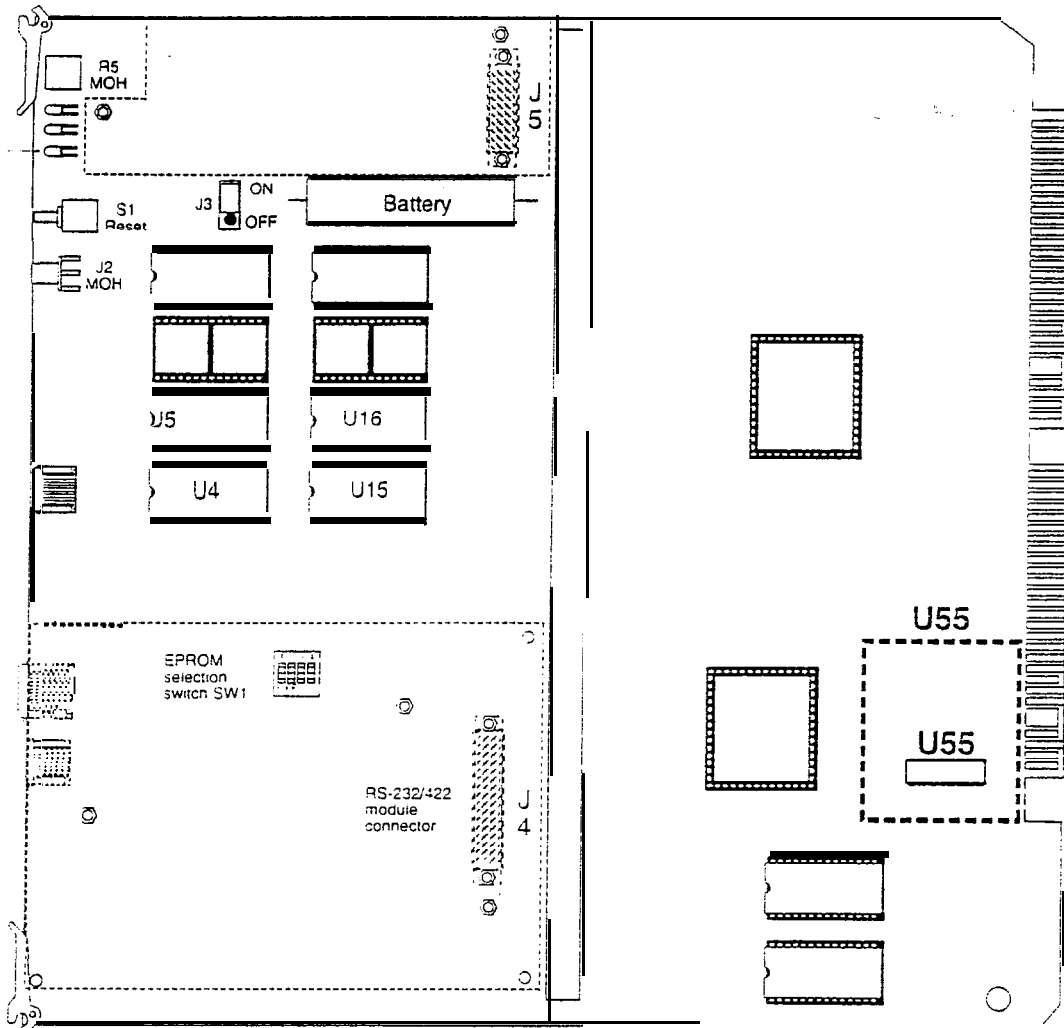



# PRODUCT NOTICE

PNO016  
Starplus Digital Systems  
July 18, 1995

---

## Voice Mail PC Speed Control Command

- AFFECTED PRODUCTS:** SP103-02, SP103-04, SP103-06, SP103-08, SP103-12, SP103-16 (Starplus AVP products)
- SYMPTOM:** Voice mail performance seems to be sluggish. Voice mail performance is defined **as** retrieving messages, leaving messages, navigating through a menu route action, and general "slow" performance.
- RESOLUTION:** If a certain keyboard combination is accidentally pressed, the system can be taken out of turbo or the high speed mode. If the [CTRL] [ALT] [-] keys are inadvertently pressed, this will place the PC in the standard or non-turbo mode.
- PROCEDURE:** Simultaneously press the [CTRL] + [ALT] + [+] keys. This will place the PC in the turbo or high speed mode. The system is defaulted in the turbo mode.



# PRODUCT NOTICE

PN0018  
Starplus Digital Systems  
July 18, 1995

---

## Sequential Shorts

**AFFECTED PRODUCTS:** 1400-00, 1402-00, 1431-00, 1432-00, 2831-00, 2831-10, 2831-20, 4832-00, 4832-10

**SYMPTOM:** Digital telephone station port(s) become inoperative after initial installation or after an add/move/change.  
Digital telephone station port(s) exhibit erratic operation after initial installation or after an add/move/change.

**CONDITIONS:** The station battery feed circuit that interfaces digital telephones to station ports can be sensitive to sequential shorts. A sequential short is a type of short that is of a short duration. This type of short can occur when using a punch down tool on a live station circuit.

**PROCEDURE:** VCS recommends that every effort be made to install stations with power off.



# PRODUCT NOTICE

PN0019  
Starplus Digital Systems  
UPDATED: August 2, 1995

## Station ID Lock feature

**AFFECTED PRODUCTS:** Feature Package 3 S/W versions 3.1 F and above.

**SYMPTOM:** A new feature has been added that allows station ID to be "locked" into memory. This feature is designed to prevent the loss of station programming that results when a different station type is plugged into a port already designated as another station type. Example: Station 101 is an executive telephone, the user unplugs station 101 and plugs in DSS unit, all button data for the executive telephone is now lost. The Station ID Lock feature if enabled, will prevent this by not allowing the DSS unit to come up.

**CONDITIONS:** This feature is available on 1428, 2856, and 4896 with Feature Package 3 version 3.i E and above.

Once this feature is enabled, station ID programming changes require that the station lock feature first be disabled. Plug the new device into the jack. The set will automatically be identified. Enable the Station ID lock feature.

This is programmable on a system wide basis and the feature is disabled by default.

- PROCEDURE:**
1. Enter the program mode from station 100. Dial "3226.
  2. Press the FLASH button and dial [OS].
  3. Press button #8. The LCD will display:

<b>STATION LOCK</b>	<b>0-1</b>
<b>DISABLED</b>	

4. Enter a one digit value on the keypad to enable/disable this feature.  
0=disable  
1=enable
5. Press the HOLD button to save the entry. Confirmation tone will be heard.



# PRODUCT NOTICE

SPPN0028  
Starplus Digital Systems  
May 20, 1996  
Revision A

---

## Connecting two 4896 systems together via T-1 circuits

AFFECTED PRODUCTS: 4896 System

**SYMPTOM:** To clarify **connecrion** requirements that are stated in the Technical Manual (4850-02). Reference page(s) 500-26, 500-27, and 500-31 in the Technical Manual.

**CONDITIONS:** This notice only applies to multiple 4896 systems that will be connected together via T-1 interfaces.

**PROCEDURE :** The manual states that no CSU is required when connecting 2 4896 systems together.  
The statement should read:

If 4896 systems are in the same building and are not physically located more than twenty-five feet (25') apart, no CSU is required to connect the systems together. **if** the 4896 systems are more than twenty-five (25') feet apart, not in the same building, or are utilizing the CO network for connection, 3 CSU is required at both ends.

The CSU build out should be adjusted accordingly via the procedure in the Technical Manual.

If the 4896 system is being connected to any T1 other than another Starplus 4896 system, a CSU is required.

JUL. XX 1996  
**UPDATED . . .**



# PRODUCT NOTICE

SPPN0023  
Starplus Digital Systems  
February 2, 1996  
Revision A

Software Version 3.1 j

**AFFECTED PRODUCTS:** SPD 612, 1428.2856, and 4896 Systems

**SUBJECT:** New Software Release for Starplus Digital Systems

**UPDATES:**

1. A change in administration programming has been added to S/W version 3.1 j and above. This change is as follows:  
**On 612, 1428, and 2856 systems, the station ID programming (Page B, button 1) has been changed. Station ID 7 now reflects a relay/sensor box and Station ID 8 now reflects a DDIU unit. The complete station ID map for all digital systems is now:**

[0] = ID0 Digital	[5] = ID5 SLT/OPX
[1] = ID1 DSS Map 1	[6] = ID6 SLT w/ MSG
[2] = ID2 DSS Map 2	[7] = ID7 Relay/Sensor Box
[3] = <b>ID3</b> DSS Map 3	[8] = ID8 DDIU Unit
[4] = ID4 DSS Map 4 (4896 only)	[9] = ID9 DSS Map 5 (4896 only)

2. In addition to the above programming change, the following information applies to S/W version 3.1 j and above:
  - a) The forward override code (5%) will allow an OHVO function to be performed at a busy station that is busy forwarded.
  - b) The 300 baud rate function of the PC Interface mode (648) is not supported. Always select 1200, 2400, or 4800 baud. Do not utilize 300 baud.
  - c) Camp on ringing to a station cannot be picked up via directed call pickup. The current technical manual states that this can be done. (Page 400.18, Directed Call Pickup)
  - d) The CO transmit volume option will not function unless the handset receiver gain option is enabled. The handset receiver gain option is programmed in FLASH 05, BUTTON 13.

UPDATED JUL XX 1996  
...



- e) Issue 2 of the Technical Manual inadvertently left out information regarding the RAN Hunt Group feature that was added to FP3 software. This enhancement allows an ACD RAN to be directed to a hunt group to permit up to eight (8) callers to receive the RAN announcement at a time. There can be up to four (4) RAN hunt groups in the system.

Programming Hunt Groups:

1. At station 100, dial "3225.
2. Press the FLASH button and dial 30.
3. The button layout for Hunt Group programming is now as follows:

Entering hunt groups in announcement tables:

HUNT GROUP 450	HUNT GROUP 460
HUNT GROUP 451	HUNT GROUP 461
HUNT GROUP 452	ST/PILOT
HUNT GROUP 453	
HUNT GROUP 454	
HUNT GROUP 455	
HUNT GROUP 456	
HUNT GROUP 457	
HUNT GROUP 458	
HUNT GROUP 459	

1. At station 100, dial "3225.
2. Press the FLASH button and dial 62.
3. Enter the desired string of digits using the keypad. The order entry is:

TYPE NUMBER  
 [1] CO Port  
 [2] SLT Port  
 [3] Hunt Group

INDEX NUMBER  
 [01-96] CO Line  
 [100-315] Station Number  
 [458-461] Hunt Group

UPDATED JUL X X 1996

**Conditions:**

1. RAN hunt group pilot numbers are 458-461.
  2. RAN hunt group numbers can be chained together by placing the RAN group number (458-461) as the last member in the desired group.
  3. Hunt group pilot numbers 458-461 are reserved exclusively for RAN functions. Both guaranteed and regular RAN announcements can be directed to a RAN hunt group.
  4. Both guaranteed and regular RAN announcements can be directed to a RAN hunt group.
  5. RAN hunt groups are pilot type only and cannot be changed. Only SLT stations can be entered into these type of hunt groups.
- f) A comprehensive RAM test has been added to the software. If this RAM test fails, the red heartbeat LED will flash rapidly. If this rapid flashing continues for more than 5 minutes, the RAM test has failed. If the RAM test fails, the problem is in the 1400-00 Basic KSU, 2830-00/16 CPU, 4830-00 CPU, or the 4830-20 Memory Expansion Kit. On the 4830-00, verify the following:
- Check the seating of the memory expansion kit if installed.  
If the memory expansion kit is installed, check that jumper J4 is installed between pins 1 & 2.
- g) Software 3.1j now supports disconnect supervision for ground start emulation of T1 circuits. This was not available in previous versions of software. Disconnect supervision is not supported for loop start emulation of T1 circuits.
- h) When programming an SLT station for off hook preference, the following sequence(s) should be entered:
- 01 [1] LL to assign a specific line to choose. Where LL is the line number 01-96.  
-or-  
01 [3] G to assign a specific line to choose. Where G is the desired group number 1-7.

JUL XX 1996  
**UPDATED** . . .



# PRODUCT NOTICE

SPPN002  
Starplus Digital System  
April 15, 1996  
Revision F

## Software Version-3.2 Series

AFFECTED PRODUCTS: SPD 612, 1428, 2856, and 4896 Systems

SUBJECT: New Software Release for Starplus Digital Systems

- UPDATES:
1. Incoming calls can now utilize trunk to trunk transfer. This was unavailable on previous versions of S/W. EXAMPLE:
    - a) Station A answers incoming call on CO line 1.
    - b) Station A places CO line 1 on hold.
    - c) Station A answers second call on CO line 2.
    - d) Station A presses the [TRANS] button followed by pressing the button for the call on hold.
  2. Regarding the operation of the Database Administration software. Using the download feature on a 4896 system, the DBA program (0.1i and above) can differentiate between the various card types installed in the system. This was unavailable on previous versions.
  3. On S/W versions 3.23 and above, the conference operation has been enhanced. Presently, if a conference master has one CO line on conference hold and is attempting to add a second CO line to the conference and receives busy tone or a wrong number, the only way to drop the second line is to make the conference with the busy line and remove it from the conference. The conference feature has been changed to allow the conference master to access one of the CO lines on conference hold. This will connect the master to the party they pulled off of conference hold and drop the party (busy/wrong number) the master was talking to.

UPDATED . . . JUL. X X 1996

4. On S/W versions 3.23 and above, the LCR default table has been modified to accommodate several new area codes.  
Area codes: 630, 847, 334, 360, 281, 520, 970, 941, 540, 860, 562, 423, 441, 954, 541, 864, 770, and 972.  
These codes in the 3 digit leading I-table have been defaulted to select Route 0, 11 digits expected, and no 6 digit routing.  
In addition, area code 441 has been defaulted to select Route 5, 11 digits expected, and no 6 digit routing.
5. On S/W versions 3.23 and above, an enhancement to the T1 area has been added. This enhancement gives the installer the ability to enable/disable the receiving of pulse dialing on T1 circuits.
  - a) Enter the programming mode.
  - b) Go to FLASH 06.
  - c) Press-button 9.
  - d) Enter a 0 or 1 on the keypad. 0 will disable the receiving of pulse dialing, 1 will enable the receiving of pulse dialing.
  - e) Press the HOLD button to save the entry. A confirmation tone will be heard and the LCD will update.
6. When utilizing the Caller ID feature in the 3.2 S/W series, it may be necessary to set the ring delay timer to 4 seconds so that all of the caller ID information can be received from the Telco. The ring delay timer is in Flash 40, Page A, Button 14.
7. It is recommended that ACD agent station not be deleted from an ACD group through database administration when that station is in the unavailable mode. This will cause the LCD to display unavailable even though the station is no longer part of the ACD group. The station can dial the 566 code to remove the message.
8. On software versions 3.24 and above, the Personalized Message operation has been corrected and enhanced.  
  
The station user can now press the pre-programmed Personalized Message button and dial a 2 digit message code. Valid codes that can be dialed during this operation are 00-10, 21-30.  
  
This feature has been enhanced to allow the user to press this button and enter a two digit code during a Silent Response operation. When receiving a Camp On or OHVO call:
  - Station A presses pre-programmed message button
  - Station A dials two digit code 31-51 (DTMF digits are muted to current party)
9. On software versions 3.24 and above, CO and intercom calls will now ring a station using the Directory Dial feature. The station user must hang up from the Directory Dial mode to answer the call.

UPDATED . . . . . JUL X X 1998

10. Starting with software version 3.24 and above, the software packaging has been modified to be three (3) packages. These packages are the Standard, VMI, and ACD packages. The 612 retains its current two (2) packages.

The systems, software packages, and optional features are broken down as follows:

	612		1428			2856/4896		
	Standard	VMI	Standard	VMI	ACD	Standard	VMI	AC3
ICLID			X	X	X	x	x	x
ACD					X			X
LCR			X	X	X	X x		x
VOICE MAIL	X			X	X		x	x
PC DBA			X	x	x	X	X	X
Volume Control			X	x	x	X	X	X
Reminder Ring			X	X	X	x	X	X
SMDR			X	X	X	X	X	X
DID/E&M/T1						X	X	X
Verified Account Codes			X	X	X	X	X	X
Call Coverage			X	X	X	X	X	X

**REMEMBER!**

- Verified Account Codes
- T1
- DID
- More than 48 CO lines or 96 stations

These features require the Memory Expansion Kit (4830-20) to be installed.

UPDATED  
JUL XX 1998

11. On software versions 3.2A and above, a problem that could result in a glare condition on TIE trunks was corrected. The glare condition occurred when a user accessed a TIE trunk at the exact moment a incoming call on the TIE trunk is being presented. The user placing the outgoing call would answer the incoming call. If the user then transferred the call, the TIE-trunk would be tied up for an indefinite period of time. The TIE type trunk can be on a TIE trunk board or a T1 circuit that is marked for TIE signaling.
  
12. On software versions 3.2A and above, an intermittent problem that could result in the loss of the customer database was corrected. Affected products:  
  
4896 without memory expansion kit  
If the system has ever been placed in night service, a potential exists for the system to lose its' database programming if power is lost or the system is reset.
  
13. On software versions 3.2C and above, a problem was corrected where station cards in slots higher-than the last single line card could not be viewed or programmed after an upload.
  
14. On software versions 3.2C and above, a problem was corrected in which flexible port assignments (FLASH 52), could cause cold starts to occur in a system. This occurred in systems that did not have all the rearranged station numbers assigned. In impiementing this function, the following should be noted with the SPD 1428 system:  
  
FLASH 52 Button #2 will display the last four station assignments as 128-131. This is normal and should not be viewed as a problem. These stations are simply stations to fill in the numbering plan, they are not available for system use.
  
15. On software versions 3.2C and above, a problem with LCR in which extra digits dialed could cause an incomplete number to be outpulsed was corrected. Extra digits dialed after the LCR table is satisfied will not be processed.
  
16. On software versions 3.2C and above, the method of hunt utiized in voice mail groups has been changed. The previous method would select the "longest idle" port, the new method always attempts to start with the first station that was entered in tile voice mail group programming. The hunt method was changed in an attempt to reduce problem reports associated with voice mail message lights operating erratically.
  
17. On software versions 3.2C and above, a conference master is now able to call voice mail when they have temporarily exiied the conference.

UPDATED JUL 22 1998  
...



# PRODUCT NOTICE

SPPN0025  
Starplus DHS Systems  
February 2, 1996  
Revision A

## initial Release • STARPLUS® DHS

AFFECTED PRODUCTS: STARPLUS® DHS

SUBJECT: Initial Release for STARPLUS® DHS

- UPDATES:
1. A station user cannot resume speaking with his remote party if another station calls him and uses "Voice Over Busy" while he has mute active.
    - a) Sta A on CO 1.
    - b) Sta B calls Sta A and performs voice over busy.
    - c) Sta A cannot resume conversation with CO 1 until Sta B hangs up.
  2. A station user must be a member of the group being paged to use Meet Me Page Feature
  3. A CO line group Feature button will not show all trunks busy if the last available line in the group is answered as in incoming call. The CC line group button will show busy if outgoing calls are placed.
  4. Incoming CO LED flashes at a station that is not assigned CO LINE RECEIVE. Page 54 of the manual incorrectly states that the line will display a busy indication.
  6. Only 1 DISA line per system is supported on the STARPLUS® DHS system at this time.
  7. Stations assigned COS O-6 do not override programmed TOLL RESTRICTION tables via EMERGENCY SPD DIAL BINS as described in the text. This will be corrected in the next version of software.
    - a. The (/) does not display when [F3] FLASH command is initiated while on a CO line.
  9. A CO line assigned as a private line can be accessed at other stations when on HOLD via an incoming button appearance, contrary to documentation.
  10. CO calls transferred or forwarded to VM queue do not ring through at the VM port but instead will recall the initiating transfer station.

UPDATED . . . JUL XX 1996



# PRODUCT NOTICE

SPPN0026  
Starplus PC-DBA  
May 8, 1996  
Revision A

PC-DBA Software Version 1.0c

AFFECTED PRODUCTS: PC-CBA

SUBJECT: S/W Release

- UPDATES:
1. CO sanderization enable/disable has been added in the SYSTEM FEATURES II area of PC-DBA. This feature is only available with KSU S/W versions 3.3 or greater. This feature provides a means to force the system into a DTMF sanderized mode. In this mode; the system will provide false dialtone to the station user and collect DTMF digits one at a time. The system will then regenerate the digits for a specific on/off time to the central office.  
After the inter-digit timer expires, the audio path is connected between the station and the central office. At this point the station user may use the dialpad in the cut through mode.
  2. Save Number Re-dial and Last Number Re-dial can now be programmed onto a flexible button.
  3. When entering a CSS type station, the Keyset Hardware ID must be entered.  
Move the cursor to the STATION ID field and press [F2].  
Select the desired CSS (map 1-5) and press [ENTER].  
Move the cursor to the Keyset Hardware ID field and press [F2].  
SPD should be displayed in the dialog box. Press the [ENTER] key.
  4. A correction was added to resolve a problem with full uploads not completing at times.

UPDATED . . . JUL. XX, 1996





# PRODUCT NOTICE

SPPNOC  
Starplus DHS System  
June 3, 1996  
Revision A

---

## Starplus® DHS KSU & 3 x 3 Board

**AFFECTED PRODUCTS:** Starplus CHS KSU (SP7000-00) and 3 x 8 Board (SP7100-00)

**SUBJECT:** Potential noise issue

**SYMPTOM:** A potential exists for noise to occur on intercom and CO calls if the ambient temperature around the KSU rises. This is due to component tolerances on the 3 x 8 board. Not all KSU and 3 x 8 boards will exhibit a problem, however, the potential does exist for this situation to occur.

**CONDITIONS:** The 3 x 8 board must be replaced with a known good 3 x 8 board. No re-programming of the KSU is required. The base KSU includes 1 3 x 8 board. Additional 3 x 8 boards are added to expand the system capacity. A total of 3 3 x 8 boards (including the 1 in the base KSU), can be accommodated in a KSU.

**PROCEDURE:** VCS will advance replace at no charge any 3 x 3 boards that are susce. This program is valid for 60 days from June 3, 1996.

UPDATED

JUL. XX 1996



# PRODUCT NOTICE

SPPN0022  
Starplus Digital Systems  
February 2, 1996  
Revision A

---

## Software Version 3.1 i

**AFFECTED PRODUCTS:** 612, 1428, 2856, and 4896

**SYMPTOM:** S/W Release for Starplus Digital Systems

**RESOLUTION:**

**PROCEDURE:** 1. A change in administration programming has been added to S/W version 3.1 i and above. This change is as follows:  
**On 612, 1428, and 2856 systems, the station ID programming (Page 3, button 1) has been changed. Station ID 7 now reflects a relay/sensor box and Station ID 8 now reflects a DDIU unit. The complete station ID map for all digital systems is now:**

[0] = ICO Digital	[5] = ID5 SLT/OPX
[1] = ID1 DSS Map 1	[6] = ID6 SLT w/ MSG
[2] = ID2 DSS Map 2	[7] = ID7 Relay/Sensor Box
[3] = ID3 DSS Map 3 (4896 only)	[8] = ID8 DDIU Unit
[4] = ID4 DSS Map 4 (4896 only)	[9] = ID9 DSS Map 5 (4896 only)

2. In addition to the above programming change, the following information applies to S/W version 3.1 i and above:

The forward override code (5#) will allow an OHVO function to be performed at a busy station that is busy forwarded.

The 300 baud rate function of the PC Interface mode (648) does not function properly. Always select 1200, 2400, or 4800 baud. Do not utilize 300 baud.

Camp on ringing to a station cannot be picked up via directed call pickup. The current technical manual states that this can be done. (Page 400.18, Directed Call Pickup)

The CO transmit volume option will not function unless the handset receiver gain option is enabled. The handset receiver gain option is programmed in FLASH 05, BUTTON 13.

UPDATED . . . JUL XX 1996

Issue 2 of the Technical Manual inadvertently left out information regarding the RAN Hunt Group feature that was added to FP3 software. This enhancement allows an ACD RAN to be directed to a hunt group to permit up to eight (8) callers to receive the RAN announcement at a time. There can be up to four (4) RAN hunt groups in the system.

**Programming Hunt Groups:**

1. At station 100, dial "3226.
2. Press the FLASH button and dial 30.

HUNT GROUP 450	HUNT GROUP 460
HUNT GROUP 451	HUNT GROUP 461
HUNT GROUP 452	STAMP/PILOT
HUNT GROUP 453	
HUNT GROUP 454	
HUNT GROUP 455	
HUNT GROUP 456	
HUNT GROUP 457	
HUNT GROUP 458	
HUNT GROUP 459	

3. The button layout for Hunt Group programming is now as follows:

**Entering hunt groups in announcement tables:**

1. At station 100, dial "3225.
2. Press the FLASH button and dial 62.
3. Enter the desired string of digits using the keypad. The order entry is:

**TYPE NUMBER**

- [1] co Port
- [2] SLT Port
- [3] Hunt Group

**INDEX NUMBER**

- [01-96] CO Line
- [100-315] Station Number
- [458-461] Hunt Group

**Conditions:**

JUL X X 1996

**UPDATED**

1. RAN hunt group pilot numbers are 458-461.
2. RAN hunt group numbers can be chained together by placing the RAN group number (458-461) as the last member in the desired group.
3. Hunt group pilot numbers 458-461 are reserved exclusively for RAN functions. Both guaranteed and regular RAN announcements can be directed to a RAN hunt group.
4. Both guaranteed and regular RAN announcements can be directed to a RAN hunt group.
5. RAN hunt groups are pilot type only and cannot be changed. Only SLT stations can be entered into these type of hunt groups.

A comprehensive RAM test has been added to the software. If this RAM test fails, the red heartbeat LED will flash rapidly. If this rapid flashing continues for more than 5 minutes, the RAM test has failed.

If the RAM test fails, the problem is in the 1400-00 Basic KSU, 2830-00/16 CPU, 4830-00 CPU, or the 4830-20 Memory Expansion Kit. On the 4830-00, verify the following:

Check the seating of the memory expansion kit if installed.  
 If the memory expansion kit is installed, check that jumper J4 is installed between pins 1 & 2.

UPDATED

JUL. XX 1996  
 . . .



# PRODUCT NOTICE

SPPN0006  
Starplus Digital Systems  
February 2, 1996  
Revision A

## EPROM Speed

**AFFECTED PRODUCTS:** 1400-00, 2830-00, 2830-16, 4830-00 (1428 KSU, 2856 CPU's, and 4896 CPU)

**SYMPTOM:** The system may exhibit erratic operation and intermittent operation problems. This problem could be caused by EPROM (erasable programmable read only memory) that has improper access speed. EPROM memory is used by the telephone systems to store the software operating instructions.

**CONDITIONS:-** The proper EPROM access speed for each of the systems is as follows:

1400-00	KSU	150 nanoseconds (100ns is acceptable)
2830-00 or -16	CPU	100 nanoseconds
4830-00	CPU	100 nanoseconds

**PROCEDURE:** The location information of the EPROMS (silkscreened on the PCB) for each of the systems is as follows:

1400-00	KSU	u41 & u42
2830-00 or -16	CPU	U5 & U16
4830-00	CPU	U45 & U48

The EPROM speed is determined by locating the part number that is silkscreened on the EPROM itself. After the part number, a -XX will be shown. The -XX will either be:

-10 = 100 nanoseconds  
-15 = 150 nanoseconds

If you find the CPU or KSU is equipped with the improper speed EPROM, they need to be replaced with the proper speed ones using standard Vodavi MRA procedures. All new product shipping from Vodavi is shipping with properly matched EPROM access speeds.

UPDATED . . . 1002-02-1996



# PRODUCT NOTICE

SPPN0019  
Starplus Digital Systems  
February 2, 1996  
Revision A

## Station ID Lock Feature

**AFFECTED PRODUCTS:** Feature Package 3 S/W versions 3.1 F and above.

**SYMPTOM:** A new feature has been added that allows station ID to be "locked" into memory. This feature is designed to prevent the loss of station programming that results when a different station type is plugged into a port already designated as another station type. Example: Station 101 is an executive telephone, the user unplugs station 101 and plugs in DSS unit, all button data for the executive telephone is now lost. The Station ID Lock feature if enabled, will prevent this by not allowing the DSS unit to come up.

**CONDITIONS:** This feature is available on 1428, 2856, and 4896 with Feature Package 3 version 3.1 E and above.

Once this feature is enabled, station ID programming changes require that the station lock feature first be disabled. Plug the new device into the jack. The set will automatically be identified. Enable the Station ID lock feature.

This is programmable on a system wide basis and the feature is disabled by default;

- PROCEDURE:**
1. Enter the program mode from station 100. Dial "3226.
  2. Press the FLASH button and dial [OS].
  3. Press button #8. The LCD will display:



4. Enter a one digit value on the keypad to enable/disable this feature.  
0=disable  
1=enable
5. Press the HOLD button to save the entry. Confirmation tone will be heard.

JUL XX 1996  
UPDATED . . .



# PRODUCT NOTICE

SPPN0008  
Starplus Digital Systems  
February 2, 1996  
Revision A

## Codec Information

**AFFECTED PRODUCTS:** 1400-00, 1402-00, 1431-00, 1432-00, 1433-00, 2831-00, 2831-10, 2831-20, 2833-00, 4831-00, 4831-10, 4831-20

**SYMPTOM:** In certain site specific environments (a quiet office or a quiet CO line), background noise from the environment may be interpreted as noise on the call. Not all locations are affected by this noise. This condition may appear as low level clipping of the voice and is caused by the zero cross over circuit in the codec IC used on all CO lines. This situation arose as a result of a revision change to the codec IC used on all CO lines by the manufacturer of the IC. VCS has corrected this in production and repair; however you may find locations where the condition is present and it can be annoying to the customer.

**RESOLUTION:** If the CO codec (coder/decoder) IC's are of a certain revision, susceptibility to this problem may be heightened. The solution is to utilize two specific versions of a Texas Instruments 3054 type codec.

**PROCEDURE:** To determine the codec types:  
  
Use the attached diagrams to locate the CO line codec IC's on each board type.  
  
Each codec has a part number and manufacturer information silkscreened on top of it.

Acceptable codec(s):

Part Number: TP3054AN  
Mfg. Info: Any

Part Number: TP3054BN  
Mfg. Info: AAAAAAXN

The X must equal letters D-G in the manufacture information line to be the proper revision. The X will always be the next to last digit on the manufacture line regardless of the length of the line.

If you find a suspect codec IC and your customer is experiencing these symptoms, the unit should be replaced with a non-suspect unit. Your suspect unit can be upgraded using standard Vodavi MRA procedures.

UPDATED . . . JUL XX 1996

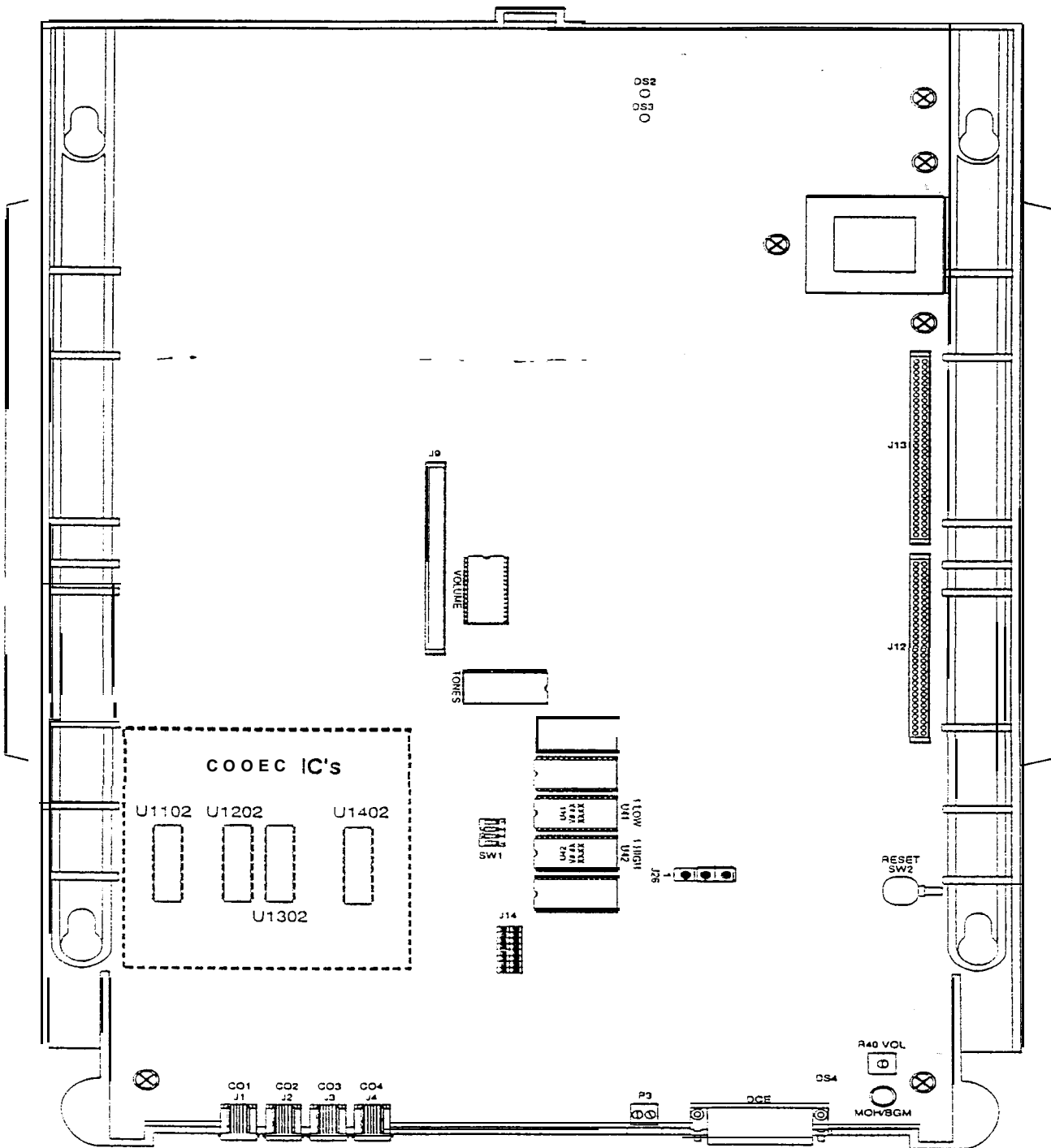

1400-00 KSU

UPDATED

JUL. XX 1996



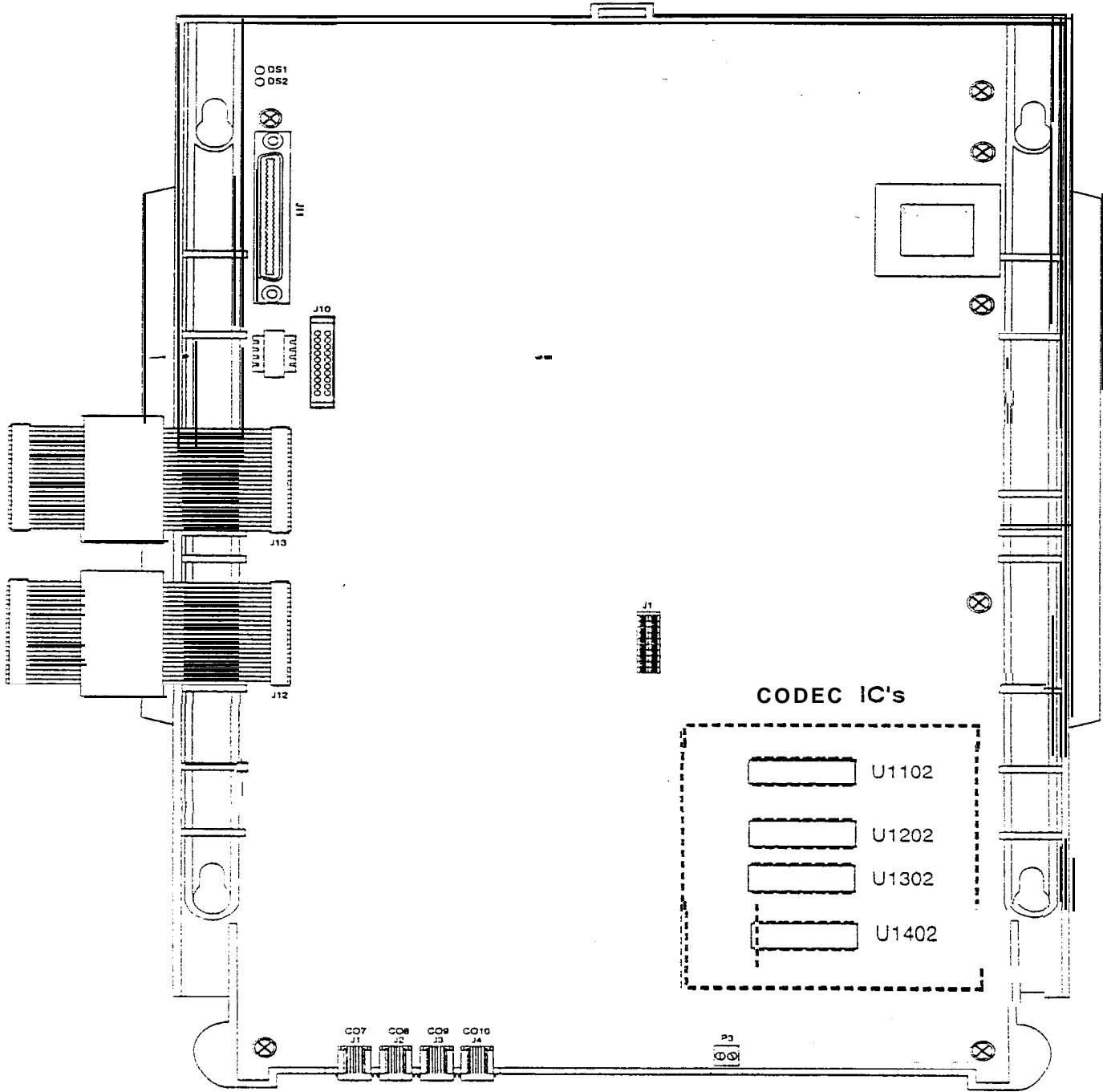

1402-00

UPDATED

JUL XX 1992

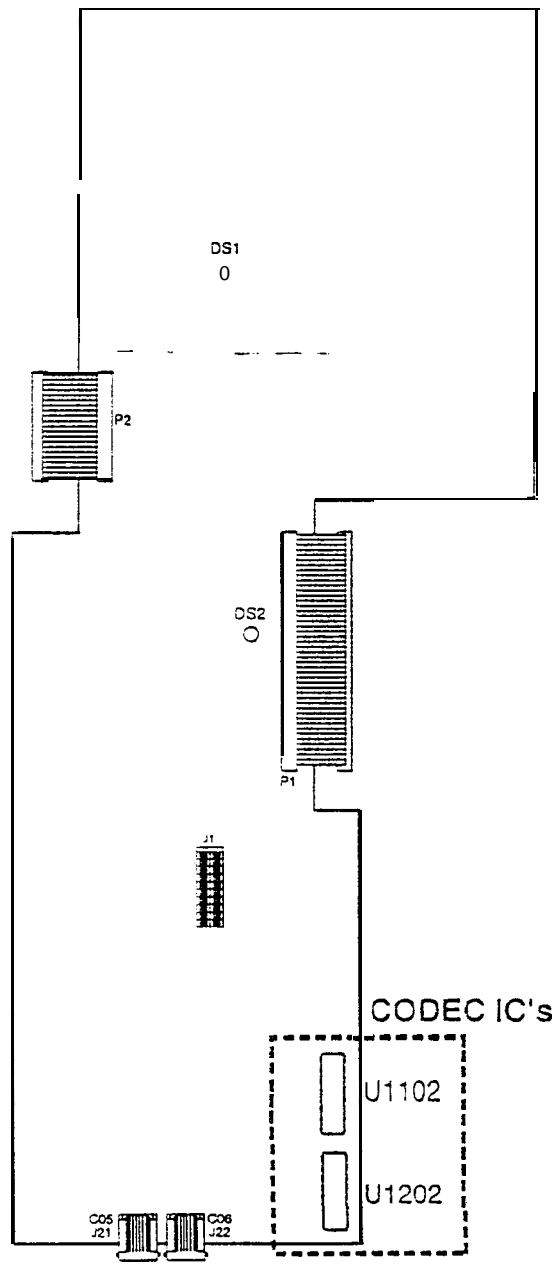

1431-00

JUL. XX 1996

UPDATED

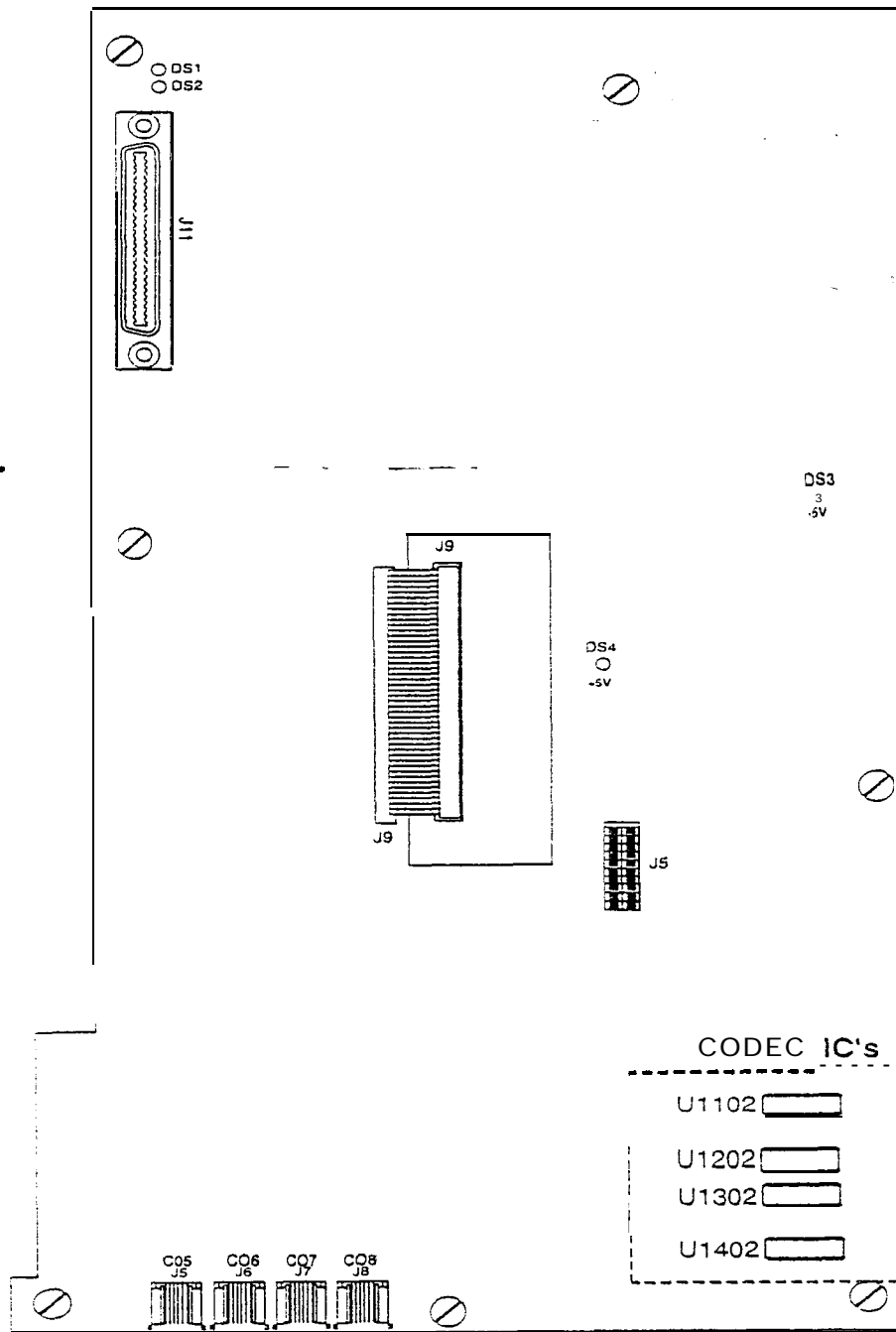

1432-00

JUL XX 1996

UPDATED . . .

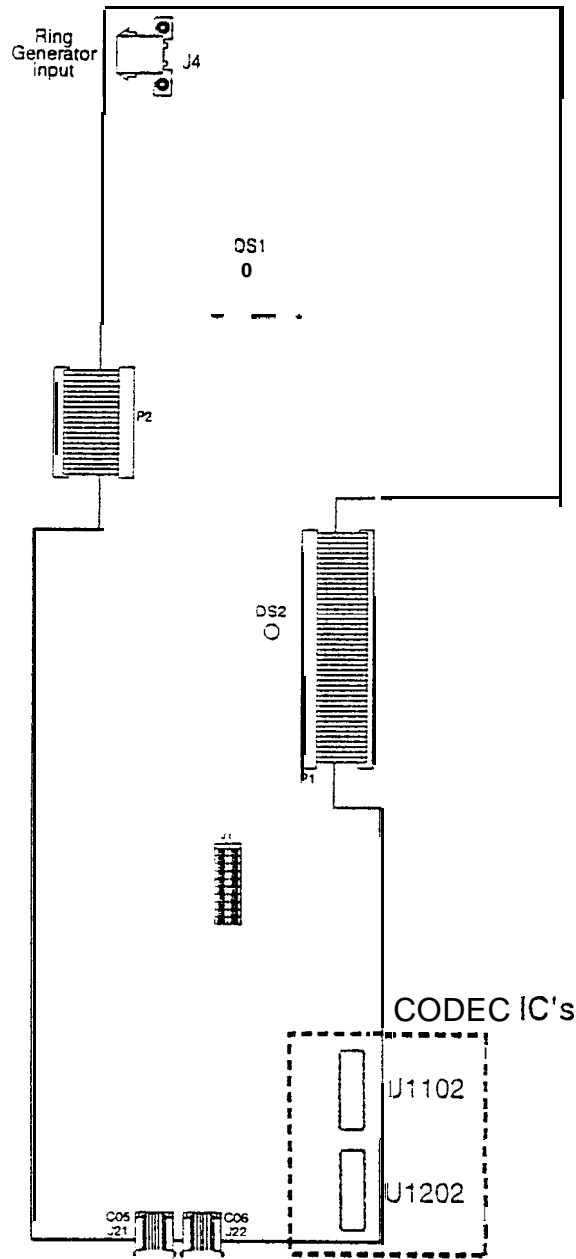

1433-00

JUL. X X 1996

UPDATED . . .

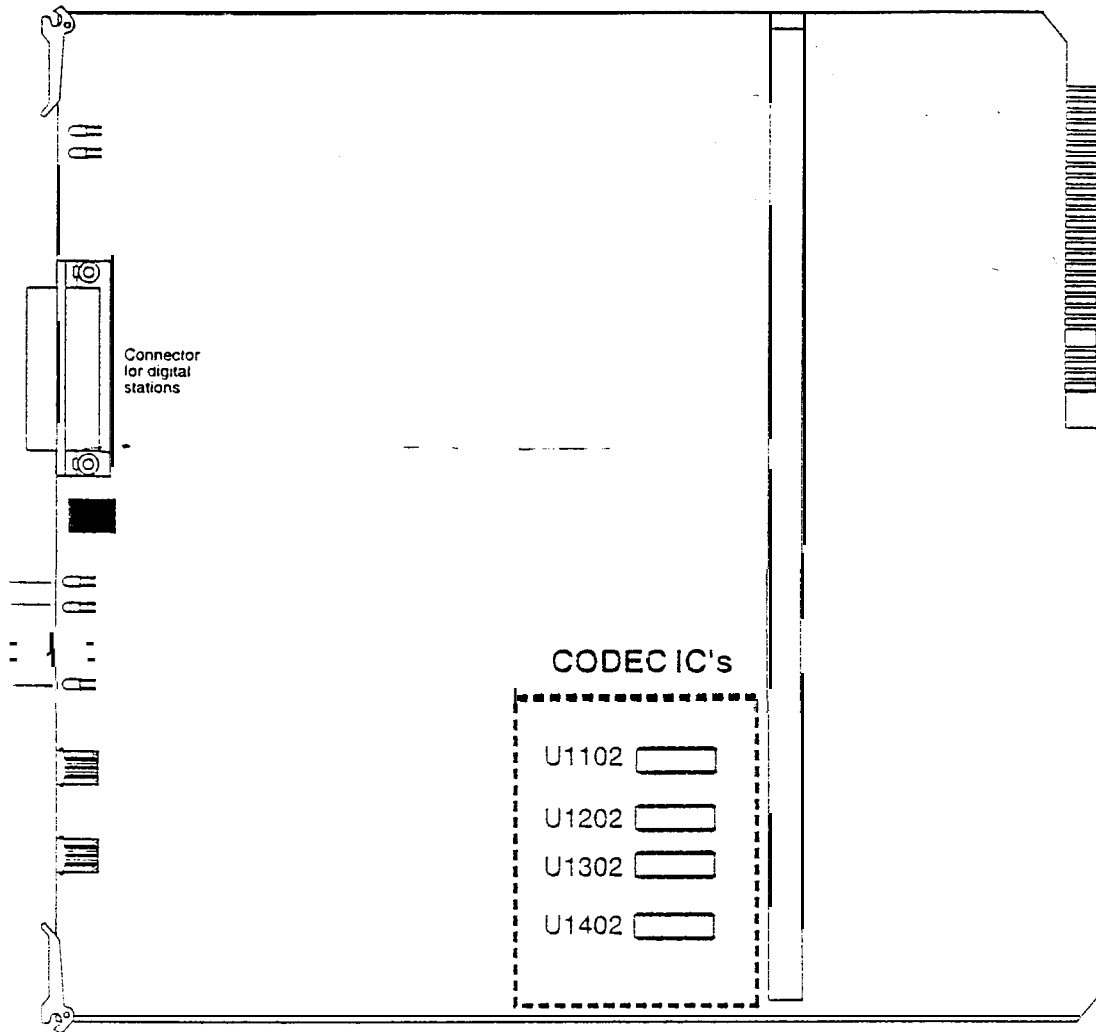

2831-00

UPDATED . . . JUL XX 1996

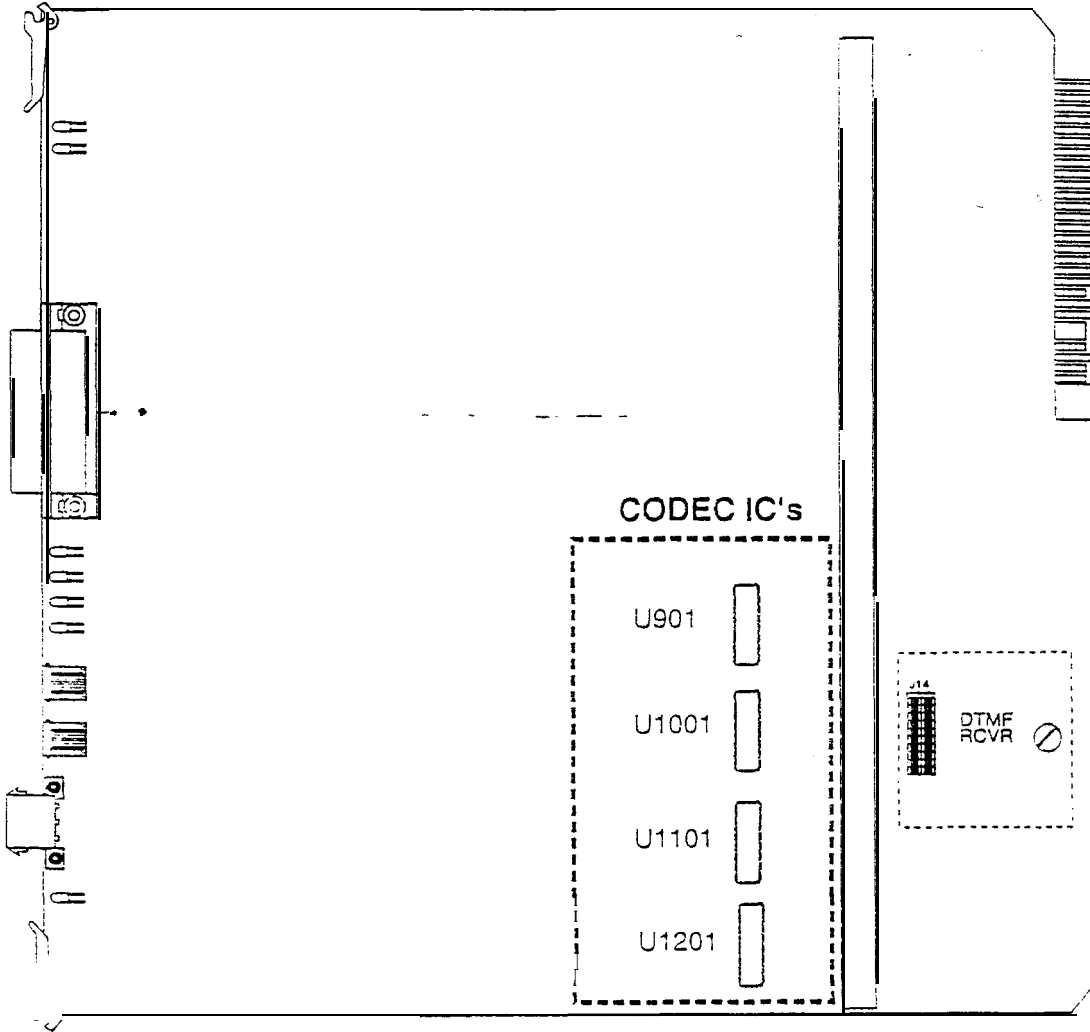

2831-I 0

JUL. X X 1996  
UPDATED . . .

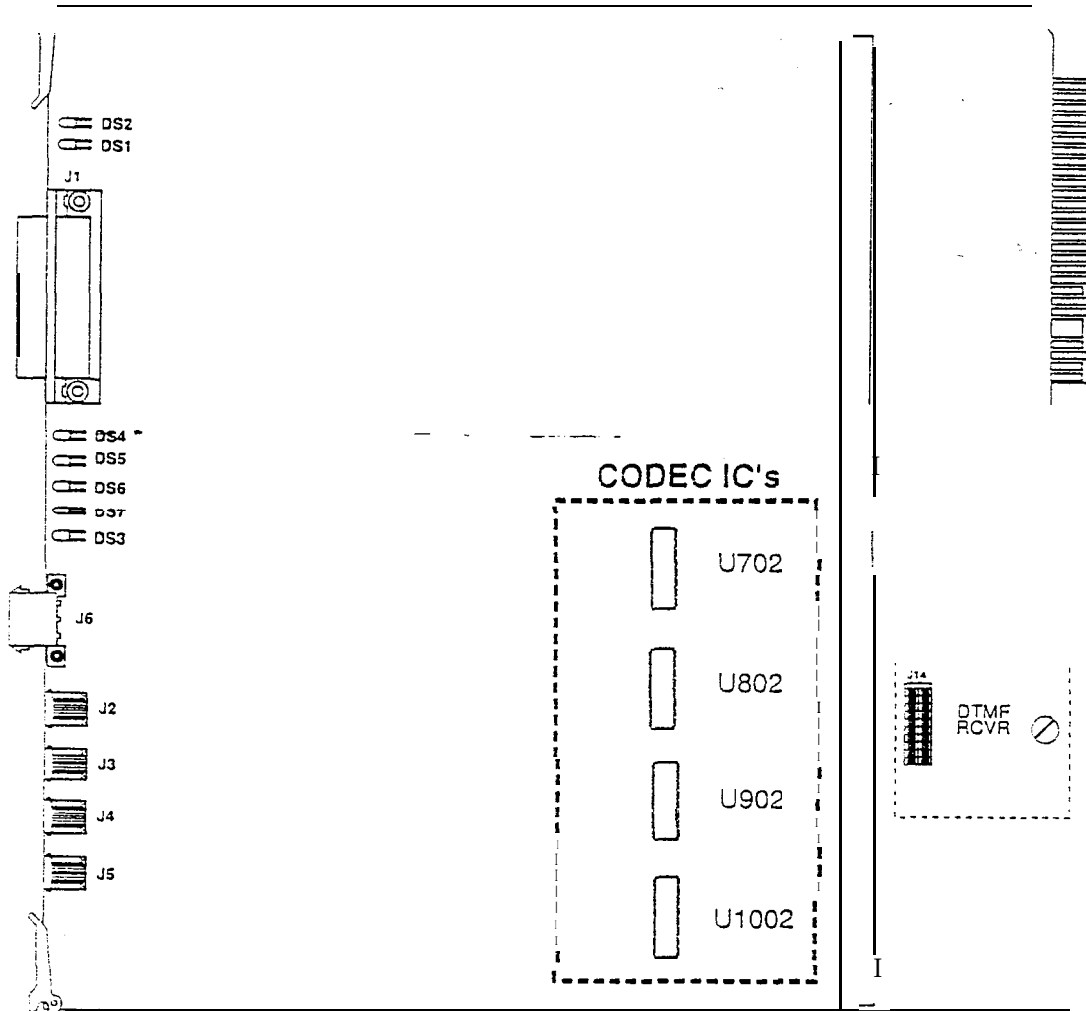

2831-20

UPDATED JUL. X X 1996 . . .

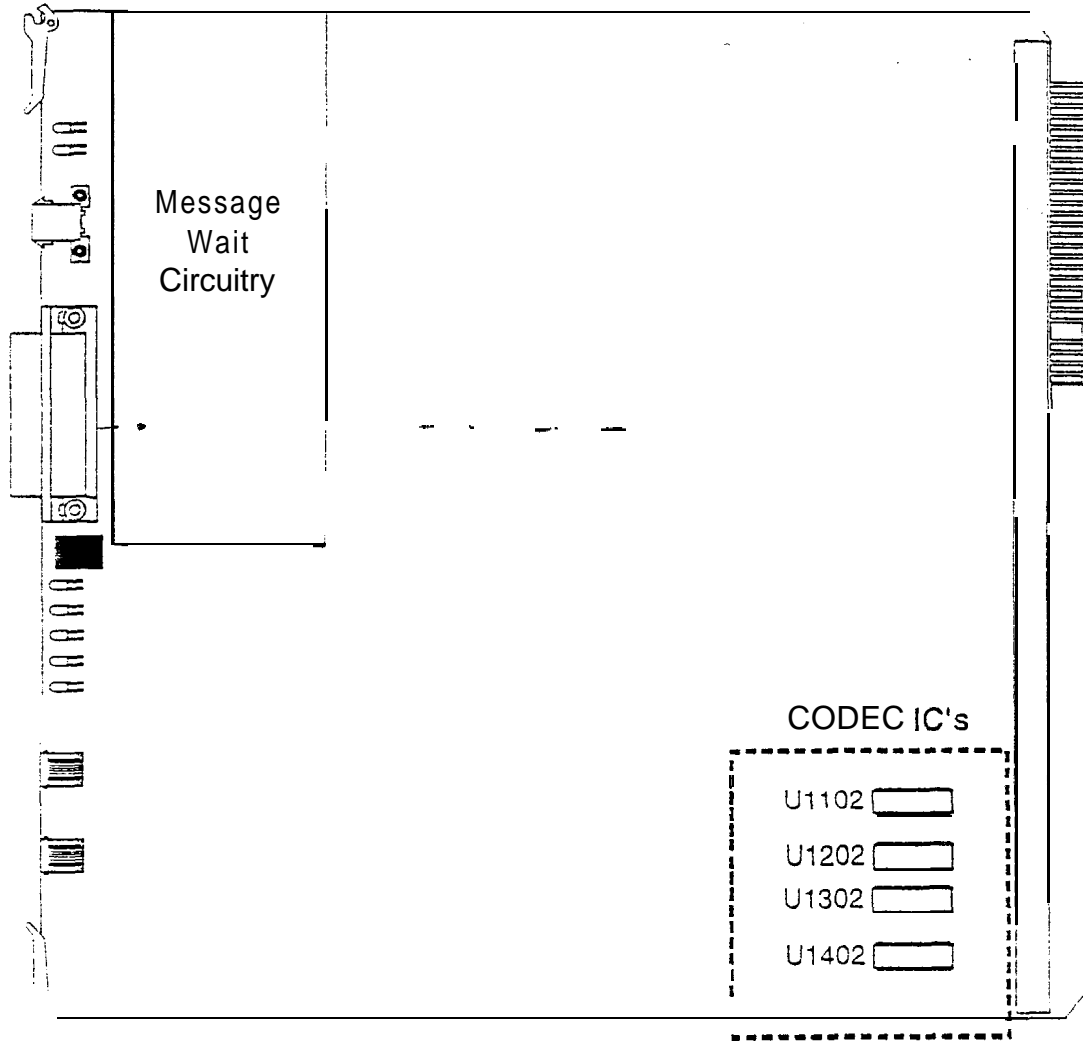

2833-00

UPDATED

JUL XX 1999

...



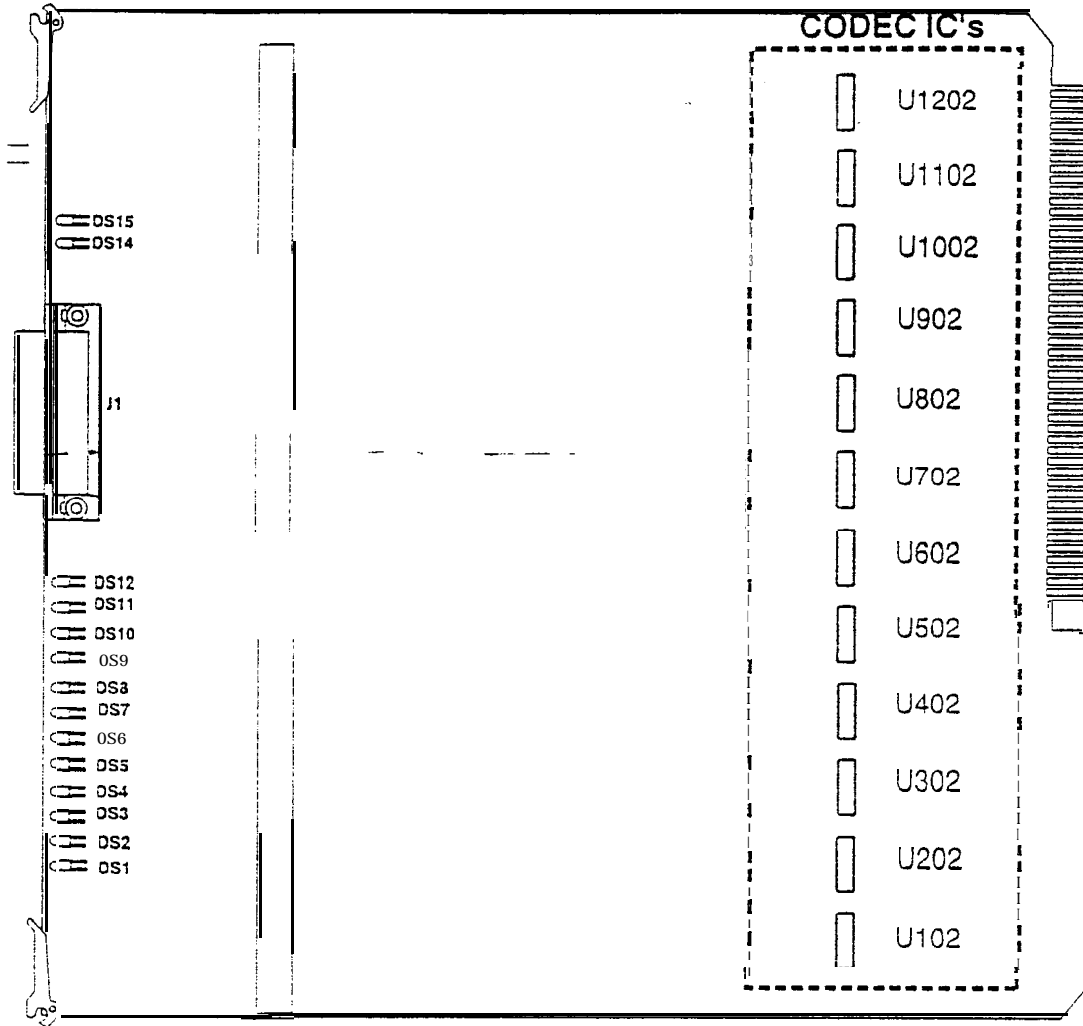

4831-00

UPDATED . . . JUL XX 1996

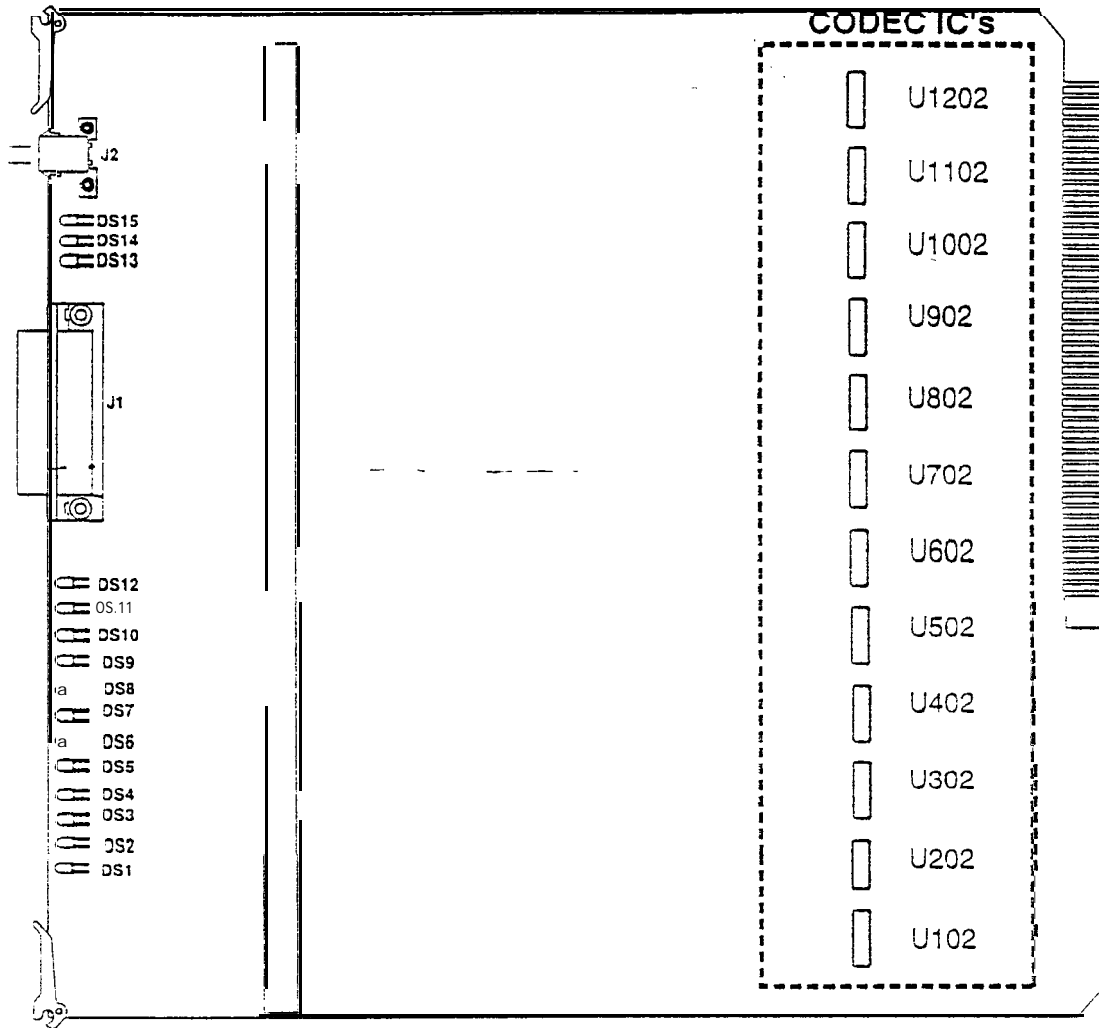

4831-10

UPDATED

JUL. XX 1996

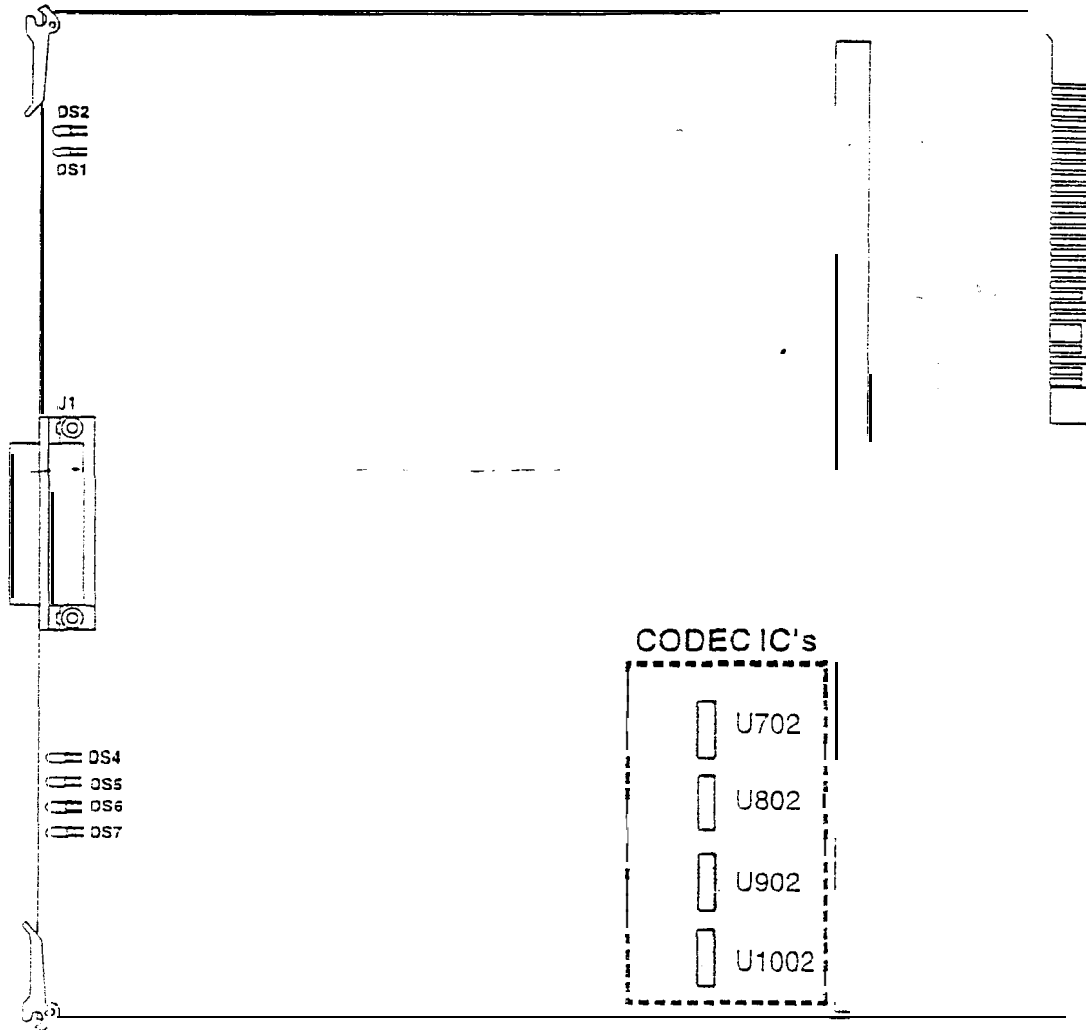

4831-20

UPDATED . . . JUL. X X 1996