

# STARPLUS® AVP

**Automated Voice Processing System**

## **Product Overview**



**VODAVI**  
**COMMUNICATIONS**  
**SYSTEMS**

**P9020-50**

**Issue 1, March 1993**

STARPLUS AVP

Automated Voice Processing System

Product Overview

Copyright © 1993 Vodavi Communications Systems

A Division of EXECUTONE Information Systems, Inc.

All Rights Reserved

This material is copyrighted by Vodavi Communications Systems. Any unauthorized reproductions, use or disclosure of this material, or any part thereof, is strictly prohibited and is a violation of the Copyright Laws of the United States (17 U.S.C. Section 101 et. seq.).

Vodavi reserves the right to make changes in specifications at any time and without notice. The information furnished by Vodavi in this material is believed to be accurate and reliable, but is not warranted to be true in all cases.

PRINTED IN UNITED STATES OF AMERICA

CJD/RJD92

## TABLE OF CONTENTS

<b>SECTION 100</b>	<b>INTRODUCTION</b> .....	<b>100-1</b>
100.1	INTRODUCTION.....	100-1
100.2	MODULES.....	100-3
100.3	HARDWARE.....	100-3
	A. BASE UNITS.....	100-3
	B. VOICE BOARDS (PORTS).....	100-4
	C. SYSTEM SIZE.....	100-4
	D. OPTIONAL EQUIPMENT.....	100-5
	E. LOCATING THE SYSTEM.....	100-6
	F. INSTALLATION.....	100-6
<b>SECTION 200</b>	<b>FEATURE DESCRIPTION</b> .....	<b>200-1</b>
200.1	INTRODUCTION.....	200-1
200.2	VOICE MESSAGING.....	200-1
	A. PASSWORD.....	200-1
	B. GREETING.....	200-1
	C. RETRIEVING MESSAGES.....	200-1
	D. SENDING A MESSAGE.....	200-2
	E. STATE.....	200-2
	F. MESSAGE NOTIFICATION.....	200-2
	G. EDIT TIME PERIOD.....	200-3
	H. DISTRIBUTION LISTS.....	200-3
200.3	AUTOMATED ATTENDANT.....	200-3
	A. SYSTEM ACCESS.....	200-3
	B. PASSWORD.....	200-3
	C. TRANSFER OPTIONS.....	200-3
	D. CALL SCREENING.....	200-4
	E. CALL HOLDING.....	200-4
	F. CALL FORWARDING.....	200-4
200.4	MENU ROUTING.....	200-4
200.5	MULTI-TASKING.....	200-5
<b>SECTION 210</b>	<b>VOICE MESSAGING</b> .....	<b>210-1</b>
210.1	VOICE MESSAGING.....	210-1
	A. PASSWORD.....	210-1
	B. GREETING.....	210-1
	C. RETRIEVING MESSAGES.....	210-1
	D. SENDING A MESSAGE.....	210-2
	E. STATE.....	210-2
	F. MESSAGE NOTIFICATION.....	210-2
	G. EDIT TIME PERIOD.....	210-3
	H. DISTRIBUTION LISTS.....	210-3
<b>SECTION 220</b>	<b>AUTOMATED ATTENDANT</b> .....	<b>220-1</b>
220.1	INTRODUCTION.....	220-1
	A. SYSTEM ACCESS.....	220-1

	B. PASSWORD.....	220-1
	C. TRANSFER OPTIONS.....	220-1
	D. CALL SCREENING.....	220-1
	E. CALL HOLDING.....	220-2
	F. CALL FORWARDING.....	220-2
<b>SECTION 230</b>	<b>Menu Routing.....</b>	<b>230-1</b>
230.1	INTRODUCTION.....	230-1
<b>SECTION 300</b>	<b>FEATURE OPERATION.....</b>	<b>300-1</b>
300.1	INTRODUCTION.....	300-1
	A. SOME BASICS.....	300-1
	B. GETTING STARTED.....	300-2
<b>SECTION 310</b>	<b>VOICE MESSAGING OPERATION.....</b>	<b>310-1</b>
310.1	INTRODUCTION.....	310-1
310.2	VOICE MESSAGING.....	310-1
	A. SYSTEM ACCESS.....	310-2
	B. RECORD NAME.....	310-3
	C. PASSWORD.....	310-4
	D. GREETING.....	310-5
	E. RETRIEVING MESSAGES.....	310-6
	F. SENDING A MESSAGE.....	310-8
	G. REPLY TO SENDER.....	310-9
	H. STATE.....	310-10
	I. MESSAGE NOTIFICATION.....	310-11
	J. EDIT TIME PERIOD.....	310-13
	K. SEND MESSAGE TO DISTRIBUTION LIST.....	310-14
<b>SECTION 320</b>	<b>AUTOMATED ATTENDANT OPERATION.....</b>	<b>320-1</b>
320.1	INTRODUCTION.....	320-1
	A. SYSTEM ACCESS.....	320-2
	B. PASSWORD.....	320-3
	C. CALL TRANSFER OPTIONS.....	320-4
	D. CALL SCREENING.....	320-5
	E. CALL HOLDING.....	320-6
	F. CALL FORWARDING.....	320-7
<b>SECTION 330</b>	<b>MENU ROUTING OPERATION.....</b>	<b>330-1</b>
330.1	INTRODUCTION.....	330-1
	A. PREPARATION.....	330-1
330.2	MENU ROUTING.....	330-2
	A. CREATE.....	330-3
	B. DELETE.....	330-3
	C. EDIT.....	330-4
	D. KEY ACTIONS.....	330-6
	E. SAMPLE MENUS.....	330-8
330.3	SETTINGS.....	330-11
	A. CANNED MENUS.....	330-12

<b>SECTION 400</b>	<b>SYSTEM CONFIGURATION</b> .....	<b>400-1</b>
400.1	HARDWARE BASE UNITS.....	400-1
	A. THREE HOUR UNIT.....	400-1
	B. SEVEN HOUR UNIT.....	400-1
	C. CUSTOM UNIT.....	400-2
400.2	VOICE BOARDS.....	400-2
	A. TWO PORT BOARD.....	400-2
	B. FOUR PORT BOARD.....	400-2
400.3	SOFTWARE PACKAGES.....	400-3
	A. STANDARD PACKAGES.....	400-3
	B. CUSTOM PACKAGES.....	400-3
400.4	ENCLOSURES.....	400-3
	A. SIX SLOT ENCLOSURE.....	400-3
	B. TWELVE SLOT ENCLOSURE.....	400-3
400.5	CPU BOARD.....	400-5
	A. 286 BOARD.....	400-5
	B. 386 BOARD.....	400-5
400.6	HARD DISK DRIVES.....	400-5
	A. FORTY (40) MEGABYTE DRIVE.....	400-5
	B. EIGHTY (80) MEGABYTE DRIVE.....	400-5
	C. TWO-HUNDRED (200) MEGABYTE DRIVE.....	400-6
400.7	VIDEO CARD.....	400-6
400.8	SCSI (HARD DRIVE) CARD.....	400-7
400.9	KEYBOARD.....	400-7
400.10	MONITOR.....	400-8
400.11	FLOPPY DISK DRIVE.....	400-8
<b>SECTION 410</b>	<b>SPECIFICATIONS</b> .....	<b>410-1</b>
410.1	ENCLOSURE.....	410-1
	A. DIMENSIONS.....	410-1
	B. ENVIRONMENTAL.....	410-1
	C. MTBF.....	410-1
	D. INPUT VOLTAGE.....	410-1
	E. OUTPUT VOLTAGE TOLERANCES.....	410-1
	F. OUTPUT CURRENT RATINGS.....	410-1
	G. COOLING.....	410-1
	H. PERIPHERALS.....	410-1
	I. MATERIAL.....	410-1
	J. REGULATORY.....	410-1
410.2	VOICE BOARDS.....	410-2
	A. REGULATORY.....	410-2

STARPLUS® AVP Product Guide Issue Control Sheet

ISSUE NUMBER	ISSUE DATE	CHANGE
1	March 1993	Initial Release of Starplus AVP Product Guide

## SECTION 100

# INTRODUCTION

### 100.1 INTRODUCTION

This manual is meant to be an instructional tool for system administrators and technicians. It describes how to install, program, and maintain the various Starplus AVP applications.

In this chapter we will discuss:

- Starplus AVP operational concepts
- The Starplus AVP component modules
- System configuration and sizing
- Starplus AVP hardware components
- Attaching Starplus AVP to your phone system

The Starplus AVP is a family of call processing products designed to increase the productivity of your telephone system. The Starplus AVP is comprised of independent software modules that perform separate and distinct functions. These functions are Voice Messaging, Auto Attendant, and Menu Routing. Voice Messaging allows users to send and receive messages. Auto Attendant allows callers to be directed to extensions without the need for a live operator. Menu Routing allows you to create custom mulatto level menus that allow callers to be routed based upon DTMF responses entered by the caller. All Starplus AVP systems, regardless of port/hour capacity provide these three features. The system can be set up so that callers may always have the option to go to a live operator. The Starplus AVP has predefined settings that enable it to integrate with the Starplus telephone systems quickly and easily. In addition, the Starplus AVP can integrate with other manufacturer's phone systems and PBX's.

The Starplus AVP is a microcomputer (PC) based product with special voice boards installed. The voice boards are specialized hardware items that digitize human speech, store and retrieve speech files from the hard disk, and provide the interface between the phone system and the computer. The voice boards enable Starplus AVP to answer the phone and play back recorded messages. A caller communicates with the Starplus AVP system by pressing keys on a touch-tone telephone. The Starplus AVP listens for this input and then makes an appropriate response.

In a typical configuration, the Starplus AVP is connected to a Starplus telephone system via the SLT or OPX ports which connect to the voice boards. When a call is sent from the phone system to the computer, the Starplus AVP will answer the phone and greet the caller. The call is then processed in terms of specific call handling procedures.

The Starplus phone system and the AVP integrate via In Band integration. This integration allows the phone system to send the extension number and other information to the AVP in the form of DTMF digits before the caller is connected to the AVP system. This allows callers to go directly to the called person's personal greeting without the caller having to enter the mailbox number. For system users, this means by dialing the voice mail group code they will be prompted to enter their password.

The Starplus AVP is made up of several programming components. Each component has a specific function. The first five components are located in the database administration program and are accessed through it. The last two are run time screens that are presented while the system is running. The programming mode does not have to be entered to view these last two items.

- Configuration - is used to set the various parameters that provide the interface between the phone system and the computer.
- Modules - define the type of telephone automation that Starplus AVP runs.
- Reports - provide complete administrative and management information that analyzes system performance and use.
- Utilities - are special functions that include a recording studio, diagnostics, screen color settings, and system upgrades.
- Housekeeping - controls various disk management functions.
- Run-Time Screens - show blockage, usage, and events in real-time.
- Multi-Tasking - allows other DOS programs to run on the same PC as Starplus AVP. This can only be utilized on 386 machines.

The Starplus AVP combines the best of two worlds. It has easy-to-use pull-down menus that provide a simple user interface. In addition, it has the underlying flexibility of a development language that provides a vehicle for the design and development of any telephone automation application you can imagine. Starplus AVP has been designed with the ability to grow and expand with your business.



---

## 100.2 MODULES

The Starplus AVP product line consists of software modules that are designed to perform specific functions. Modules are telephone automation applications that have been written in a high level development language. The Starplus AVP is a platform for running telephone automation applications. We refer to Starplus AVP as a platform because by itself it can do very little. It simply provides the foundation for running the Modules. The modules provided with each Starplus AVP system are the Voice Messaging, Auto Attendant, and Menu Routing modules.

Modules run as stand-alone applications or they can be combined to implement more sophisticated call processing routines. For example, Auto Attendant can answer a call and transfer it to the proper extension. If the called party is unavailable, the voice messaging module (Voice Messaging) can record the caller's message.

Menu Routing allows modules to be run from voice menus. A menu gives the caller a selection of choices to choose from. For example, the caller might hear the following:

"Thank you for calling, please ..."

"Dial 1 for sales.", "Dial 2 for customer support.", "Dial 3 for product information.", "Dial 4 to find a dealer in your area."

Menus can also be multi-leveled. To use the above example, if a customer dials 4 to find a dealer, he might hear the following:

"To locate a dealer, please ", "Dial 1 for retail dealers.", "Dial 2 for wholesale dealers."

The system takes action based upon the digits dialed and what that digit is programmed for.

---

## 100.3 HARDWARE

### A. BASE UNITS

The Starplus AVP base hardware is offered in two (2) platforms, a three (3) hour base unit or a seven (7) hour base unit. These base units include the following components:

- AT 286 12 Mhz CPU card with two (2) megabytes RAM (random access memory)
- Six (6) slot PC enclosure
- 3.5" Floppy drive and diskette holder
- 40 Megabyte (3 hour) or 80 Megabyte (7 hour) SCSI hard drive
- Monochrome video card
- SCSI controller card
- Monochrome monitor

- 101 keyboard
- DOS 4.01
- Documentation (1 Manual, 1 Administrators guide, 1 user guide, 1 quick reference card)

These base units form the platform for the Starplus AVP. They are high quality hardware components chosen for their trouble free performance.

In addition to the above sizes, the Starplus AVP can be configured as a custom unit. Starplus AVP custom units can be ordered in port sizes from two(2) to twenty-four(24) and storage sizes of three(3) to fifteen(15) hours. These units both hardware and software are configured individually.

## **B. VOICE BOARDS (PORTS)**

The base units provide the basic platform and storage functions, however, the voice boards must then be added to the base unit to complete the hardware requirements. The voice boards are the interface between the computer and the telephone system. The port offerings for the Starplus AVP are:

- 2 ports
- 4 ports
- 6 ports
- 8 ports

Two types of voice boards are offered, a two (2) port version or a four (4) port version. To obtain a six (6) port system, a two port voice board as well as a four port voice board would be installed in the system. There are typically three (3) slots in the enclosure that may be used for voice boards. This means that a maximum of twelve (12) ports can be obtained in the six slot enclosure. Three voice boards each with four ports give a maximum of twelve ports.

## **C. SYSTEM SIZE**

### **DISK STORAGE**

The Starplus AVP is offered in three (3) or seven (7) hour storage capacities. In addition, there is a 15 hour storage device available also. The size of your disk drive is determined by the type of application you are running. Applications involving voice messaging and voice recording generally require the most disk storage space. The storage time in the Starplus AVP takes into consideration the drive space needed by the system software and DOS. Specific factors that effect the amount of required storage include:

- Number of users
- Number of messages per day
- Average length of messages
- Retention period for each message

Starplus AVP can format about 55 minutes of voice recording per 10 meg of available disk space.

*A good rule of thumb for applications involving voice messaging is to allow 1 hour of storage (about 10 meg) for each 25 users.*

## NUMBER OF PORTS

The Starplus AVP is offered in two (2), four (4), six (6), or eight (8) port versions. The number of ports that your Starplus AVP system needs can be estimated but not guaranteed. The number depends on several factors. These include:

- The Starplus AVP applications being run
- Time of day
- Average length of call transaction
- Average and peak traffic load
- Probability of a busy signal

*A conservative rule of thumb for voice messaging applications is to estimate that each port supports 20 users.*

There are, however, installations that support 75 users per port. In environments where call routing is the primary operation, you can estimate the amount of time needed to complete an average transfer. If we assume that the amount of time to make a call transfer is 30 seconds, then a 4 port Starplus AVP system will be able to route 8 calls per minute or about 480 per hour.

## SOFTWARE

The standard software/hardware configurations for the Starplus AVP are:

- 2 port, 3 hour
- 4 port, 3 hour
- 4 port, 7 hour
- 6 port, 7 hour
- 8 port, 7 hour

The Starplus AVP is not limited to the configurations listed above. A custom system (both hardware and software) can be ordered. This system can range from two to twenty-four ports and from 3 to 15 hours of storage.

## D. OPTIONAL EQUIPMENT PRINTER

It is recommended that you use a parallel printer for your Starplus AVP application. Connect the printer to the software key on the CPU board. Remember not to remove the software key or the printer while the system is running.

## POWER SUPPLY AND POWER SURGE PROTECTOR

For protection against transmission line fluctuations and power failures, install a power surge protector and UPS power supply. These can be purchased from most computer dealers.

## REMOTE PROGRAMMING OPTION

This allows remote programming of the Starplus AVP. The option consists of a 2400 baud modem and the host end of Carbon Copy communications software.

## E. LOCATING THE SYSTEM

When choosing the location for the system consider such factors as convenience, security, and environment. It is probably best to place the system in the same room or close to the area where the phone system is located. Provide a clean, relatively dust free space with adequate ventilation. The room should have a stable temperature and comply with the computer manufacturer's specifications.

The computer needs to be connected to a reliable source of power. Fluctuations in line voltage and power surges can impede operation as well as damage the PC or its components.

## F. INSTALLATION

There are several ways the Starplus AVP can be configured. Its intended function will determine where it is installed in the telephone network. The following are the most common installation techniques.

### BEHIND A STARPLUS PBX OR KEY TELEPHONE SYSTEM

This is the most common configuration. The Starplus AVP is installed behind the telephone system using single line (analog) extensions. These terminate at the voice boards on the back of your Starplus AVP computer. The number of lines is dependent on the size of your installation. All calls from the Central Office route through the PBX first and then to Starplus AVP. When configured in this manner, Starplus AVP supports the following:

- The caller can be answered by a live operator and transferred to Starplus AVP for appropriate routing.
- All calls can be answered directly by Starplus AVP for appropriate routing.
- The call is first directed to a live operator, but if the call is not answered after a set number of rings the PBX can send the call to Starplus AVP.

To help insure a smooth integration, the Starplus AVP contains pre-defined settings for each of the Starplus phone systems. The systems are the 2448Ex, 96EX, SPD1428, SPD2856, and the SPX. When connecting the Starplus AVP to a Starplus phone system selecting one of these will load the correct interface settings. Loading these settings automatically creates a list of mailboxes and extensions to match the phone systems default programming (SPX matches the default data disk shipped with the manual). The correct feature prefixes and four (4) pre-defined class of services, as well as loading the correct tone cadences for call analysis functions.

### DIRECTLY TO THE PHONE LINE

The Starplus AVP can be connected to the phone lines directly, if desired. This method is not as flexible as behind a phone system but it is possible. The caller will have to manually enter the mailbox number. Also, call transfers are not possible unless the lines are centrex lines in which case transfers to other centrex lines is possible.

## SECTION 200

# FEATURE DESCRIPTION

---

### 200.1 INTRODUCTION

Starplus AVP is a powerful tool for telephone automation. The AVP is capable of Voice Messaging, Auto Attendant, or Menu Routing operation or any combination of these features.

---

### 200.2 VOICE MESSAGING

Voice Messaging allows users to send and receive voice messages. The following features are available with the Voice Mail Module on the Starplus AVP.

#### A. PASSWORD

To prevent unauthorized access to mailbox feature settings, each mailbox can have its' own password. The password can be changed as often as you like. It is a four digit number unless you are told otherwise by the system administrator. If you forget the code, the administrator can reset it.

#### B. GREETING

The greeting is a personal message that a caller hears when they dial your mailbox. The greeting usually tells the caller that you are not available, when you can be reached, and how to record a message. If you do not record a personal message, the system plays a default greeting.

#### C. RETRIEVING MESSAGES

When messages are retrieved, new messages are played back before previously saved messages, and they are played in the order they were received. The oldest message is played first. Features can be accessed at any time. It is not necessary, to wait until the end of the message. Note that if you hang up without doing a delete or save, your messages are automatically saved in the same state as they were when you accessed the mailbox.

After you have finished listening to the message the following options are available:

- **Forward** - Allows you to pass the message along to another mailbox owner. To use this feature you must know the mailbox number of the person you want to forward the message to. An option of this is the ability to pass the message along to another mailbox owner adding your own comments (pre-amble) in front of the message. The person receiving the forwarded message will hear your pre-amble followed by the forwarded message.
- **Reply** - Is used to respond directly to the person who left you the message without having to enter a mailbox number. To use this feature, the message must have been sent from another mailbox owner.
- **Date/Time** - Gives you the date and time that the message was sent. The system automatically attaches this information to each message.

**D. SENDING A MESSAGE**

This allows users to record and send messages to other mailbox users in the AVP system. The following features are available when sending messages:

- **Replay the message**, allows you to listen to the message you just recorded.
- **Cancel the message**, allows you to terminate the send operation.
- **Re record the message**, allows you to record the message over again if you are not satisfied with the current one.

Messages may be sent to other mailboxes in the system or a list of mailboxes called a distribution list.

**E. STATE**

The mailbox State determines how the system handles a call when someone tries to leave a message. Usually, this means playing the called party's personal greeting and then prompting the caller to leave a message. However, several other feature selections allow the call to be handled differently. The mailbox user may change this through their mailbox access. This allows each mailbox user to set up and maintain their own state preferences. Below are the selections available and a description of what they are used for:

- **Normal** - Plays personal greeting and then takes the caller's message.
- **Off** - disables the mailbox and caller hears, "This mailbox is not available. Press 1 to try another mailbox or 0 for an operator."
- **Greeting only** - plays the personal greeting only and then, "Press 1 to try another extension or 0 for an operator."
- **Forward to an extension** - transfers the call to an extension instead of taking a message.
- **Forward to a mailbox** - transfers the call to another mailbox instead of this one. For example, in the evening a sales department might want messages left in a generic mailbox with common password access.
- **Forward to a menu** - transfers the caller to a custom designed menu with a number of selections.

**F. MESSAGE NOTIFICATION**

This instructs the system to contact you on receipt of a message by dialing an alternate phone number or activating a paging device. This allows you to receive your messages immediately or at some set time when you are away from your office. The settings may be changed by the user in their mailbox. This allows the user to customize their notification schedule for maximum flexibility.

The following selections are available with notification:

- **Play** - is used to hear the current settings.
- **Off/On** - turns this feature off/on.
- **Immediate/Timed** - toggles the type of notification you want.
- **Timed** - is used to set the reminder time.
- **Number** - is used to set the number where you can be reached. This number can be an internal extension, outside phone number, or digital pager.

When the system calls you it will say, "I have a new message for (Your Name). Please enter your password to accept the message." Of course, you can access your messages manually at any time. However, if you are expecting an important message or do not plan to be in the office, this feature provides added flexibility.

If you are not available when the system tries to reach you, it will redial periodically until you receive the message.

#### **G. EDIT TIME PERIOD**

Edit Time Period allows the mailbox owner to edit mailbox settings for: Daytime, Evenings, Weekends, and Holidays. The items that may be changed are the greeting, name, password, or the other settings selection. These items can be different for all the time periods.

#### **H. DISTRIBUTION LISTS**

This feature allows users to create a message and send it to a distribution list. A list may be up to twenty (20) mailboxes. There are 100 distribution lists in the system. The lists may be connected together to obtain more than 20 total mailboxes. To use this feature, the Lists setting in Class of Service must have been set to either Personal or System. The lists are set up in programming portion of the system. The lists are set up as "pseudo" mailbox numbers. For example, if the system mailbox numbers are 100-158, the distribution list numbers may be 500-599. This enables a user to enter a list number as they would a mailbox.

---

### **200.3 AUTOMATED ATTENDANT**

This feature allows the AVP to answer calls and transfer them to an extension based upon what digits the caller dialed. This relieves the telephone load on receptionists. The caller can always reach a live operator by dialing a programmed digit (usually 0). In addition the auto attendant module can provide a company directory so that callers may dial by name to be transferred to the desired party. This module also supports call screening. This requests that callers say their name, the system will then call you and play the person's name. At this point you can accept or reject the caller by dialing a digit.

#### **A. SYSTEM ACCESS**

System access allows you to set and edit the special features that come with the automated attendant.

You access extension features like you do for voice messaging; by dialing into the system, pressing the key, and then entering your password.

#### **B. PASSWORD**

To prevent unauthorized access to your extension feature settings, the password can be changed as often as you like. It is a four digit number unless you are told otherwise by the system administrator. If you forget the code, the administrator can reset it.

#### **C. TRANSFER OPTIONS**

When Starplus AVP forwards a call to your extension the transfer can be one of three methods. The user may change these methods through extension maintenance. This allows the user to customize their extension for maximum flexibility. The call transfer methods are:

- Supervised - Starplus AVP monitors the transfer. If you do not answer, the call is forwarded.
- Unsupervised - Starplus AVP does not monitor the transfer. The call is not forwarded in the event you do not answer.
- Immediate Forward - Starplus AVP forwards the call immediately without trying to reach the extension.

If the transfer is supervised or forwarded immediately, then you need to select where the call will be forwarded to. There are several forwarding options you can choose from. See the call forward (Item F) for these options.

#### D. CALL SCREENING

This feature prompts the caller for their name before transferring the call. Then, you hear, "I have a call from (Persons Name). Press 1 to accept the call or 2 to reject." If the call is rejected, it is handled in accordance with the forwarding instructions. This allows you to screen all incoming calls to accept or reject calls.

#### E. CALL HOLDING

This feature allows the caller to remain on hold if your extension is busy. The caller hears, "That extension is busy. To hold press 1, press 2 to select another extension, or 3 to leave a message." With call holding turned off, the call is handled in accordance with the forwarding instructions.

#### F. CALL FORWARDING

This selection allows you to set how a call is handled on a supervised transfer or when the call transfer option is set to immediate. These settings may be changed by the user through extension maintenance for maximum flexibility.

- Forwarding Off - disables this feature and the call is not forwarded.
- Forward to Mailbox - probably the most common use of this feature. If you don't answer the caller hears your personal greeting and is prompted to leave a message.
- Forward to Extension - forwards the call to another extension; for example, a secretary or another sales person.
- Forward to Menu - provides the caller with a menu of special options. For example, For information on Product XXX press 1 or press 2 to leave a message.
- Forward to Outside Number - The call is connected to an outside phone number, like your home or mobile telephone.

### 200.4 MENU ROUTING

This feature allows you to build call processing applications so that callers may access information without the assistance of a live operator by dialing DTMF digits. Callers receive voice prompts such as, "to dial sales, press 1, to dial service, press 2." Based on the digits dialed the system can perform one of a number of actions. The caller could be transferred to an extension, the caller could receive an information announcement, the caller could be routed to voice messaging, etc... The highlights of this feature are:

- Multi-level menus, the system allows any number of menu levels to be created.
- Three recordings per menu, this allows three different voice recordings to be associated with each menu. There



is an introduction prompt, description prompt, and a instruction prompt.

- Time-outs/Retries on a per menu basis. Retries and time outs for user errors can be set on a per menu basis.
- Edit Prompt Feature. This allows the user to enter a menu and change the prompts at any time. This is a password protected function so that callers entering the menu cannot access this without knowing the password. All three prompts on each menu can be edited by the user. This allows messages such as daily specials to be updated while the main greeting (introduction prompt) can remain the same.

---

## 200.5 MULTI-TASKING

This module is utilized on 386 PC based systems to allow on line programming without taking the system off line. On standard 286 based machines the system must be taken off line in order to make database changes. With the Multi-Tasking module the system can still process voice messages while in the programming mode. This is only available on custom systems.

This option allows the user to run several applications at once. It uses a priority system to determine which applications receive the most processor time. The priorities are setup in programming for the multi tasker.

This option is described completely in Appendix D.



## SECTION 210

# VOICE MESSAGING

### 210.1 VOICE MESSAGING

Voice Messaging allows users to send and receive voice messages. The following features are available with the Voice Mail Module on the Starplus AVP.

#### A. PASSWORD

To prevent unauthorized access to your mailbox feature settings, the password can be changed as often as you like. It is a four digit number unless you are told otherwise by the system administrator. If you forget the code, the administrator can reset it.

#### B. GREETING

The greeting is a personal message that a caller hears when they dial your mailbox. The greeting usually tells the caller that you are not available, when you can be reached, and how to record a message. If you do not record a personal message, the system plays the following canned message, "The person you have tried to reach is unavailable. Your call is being answered by the Starplus Automated Voice Processing system. After the tone, please leave a message. When you are finished, hang-up, or press any key for more options".

#### C. RETRIEVING MESSAGES

When messages are retrieved, new messages are played back before previously saved messages, and they are played in the order they were received. The oldest message is played first. The diagram below shows the features available while you are reviewing the messages. Features can be accessed at any time. It is not necessary, to wait until the end of the message. Note that if you hang up without doing a delete or save, your messages are automatically saved in the same state as they were when you accessed the mailbox.

After you have finished listening to the message the following options are available:

- **Forward** - Allows you to pass the message along to another mailbox owner. To use this feature you must know the mailbox number of the person you want to forward the message to. An option off this feature is the ability to add your introductory comments at the beginning of the message. The person receiving the forwarded message hears your comments then the forwarded message.
- **Reply** - Is used to respond directly to the person who left you the message without having to enter a mailbox number. To use this feature, the message must have been sent from another mailbox owner.
- **Date/Time** - Gives you the date and time that the message was sent. The system automatically attaches this information to each message.

**D. SENDING A MESSAGE**

This allows users to record and send messages to other mailbox users in the AVP system. The following features are available when sending messages:

- **Replay the message**, allows you to listen to the message you just recorded.
- **Cancel the message**, allows you to terminate the send operation.
- **Re record the message**, allows you to record the message over again if you are not satisfied with the current one.

**E. STATE**

The mailbox State determines how the system handles a call when someone tries to leave a message. Usually, this means playing the called party's personal greeting and then prompting the caller to leave a message. However, several other feature selections allow the call to be handled differently. Below are the selections available and a description of what they are used for:

- **Normal** - Plays personal greeting and then takes the caller's message.
- **Off** - disables the mailbox and caller hears, "This mailbox is not available. Press 1 to try another mailbox or 0 for an operator."
- **Greeting only** - plays the personal greeting only and then, "Press 1 to try another extension or 0 for an operator."
- **Forward to an extension (option)** - transfers the call to an extension instead of taking a message.
- **Forward to a mailbox** - transfers the call to another mailbox instead of this one. For example, in the evening a sales department might want messages left in a generic mailbox with common password access.
- **Forward to a menu** - transfers the caller to a custom designed menu with a number of selections.

These options can be changed by the mailbox user through their mailbox access.

**F. MESSAGE NOTIFICATION**

This instructs the system to contact you on receipt of a message by dialing an alternate phone number or activating a paging device. This allows you to receive your messages immediately or at some set time when you are away from your office. The user can change the notification settings through their mailbox.

The following shows the available selections:

- **Play** - is used to hear the current settings.
- **Off/On** - turns this feature off/on.
- **Immediate/Timed** - toggles the type of notification you want.
- **Timed** - is used to set the reminder time.
- **Number** - is used to set the number where you can be reached. This number can be an internal extension, outside phone number, or digital pager.

When the system calls you it will say, "I have a new message for (Your Name). Please enter your password to accept the message." Of course, you can access your messages manually at any time. However, if you are expecting an important message or do not plan to be in the office, this feature provides added flexibility. If you are not available when the system tries to reach you, it will redial periodically until you receive the message.

#### **G. EDIT TIME PERIOD**

Edit Time Period allows the mailbox owner to edit mailbox settings for: Daytime, Evenings, Weekends, and Holidays. The items that may be changed are the greeting, name, password, or the other settings selection.

#### **H. DISTRIBUTION LISTS**

This feature allows users to create a message and send it to a distribution list. A list may be up to twenty (20) mailboxes. There are 100 distribution lists in the system. The lists may be connected together to obtain more than 20 total mailboxes. To use this feature, the Lists setting in Class of Service must have been set to either Personal or System. The lists are set up in programming portion of the system. The lists are set up as "pseudo" mailbox numbers. For example, if the system mailbox numbers are 100-158, the distribution list numbers may be 500-599. This enables a user to enter a list number as they would a mailbox.



## SECTION 220

# AUTOMATED ATTENDANT

### 220.1 INTRODUCTION

This feature allows the AVP to answer calls and transfer them to an extension based upon what digits the caller dialed. This relieves the telephone load on receptionists. The caller can always reach a live operator by dialing a programmed digit (usually 0). In addition, the auto attendant module can provide a company directory so that callers who do not know their party's extension number may dial by name to be transferred to the desired party. This module also supports call screening. This requests that callers say their name and the system will then call you and play the person's name. At this point you can accept or reject the caller by dialing a digit.

#### A. SYSTEM ACCESS

System access allows you to set and edit the special features that come with the automated attendant.

You access extension features like you do for voice messaging; by dialing into the system, pressing the key, and then entering your password.

#### B. PASSWORD

To prevent unauthorized access to your extension feature settings, the password can be changed as often as you like. It is a four digit number unless you are told otherwise by the system administrator. If you forget the code, the administrator can reset it.

#### C. TRANSFER OPTIONS

When Starplus AVP forwards a call to your extension the transfer can be one of three methods. The user may change these methods through extension maintenance. This allows the user to customize their extension for maximum flexibility. These methods are:

- Supervised - Starplus AVP monitors the transfer. If you do not answer, the call is forwarded.
- Unsupervised - Starplus AVP does not monitor the transfer. The call is not forwarded in the event you do not answer.
- Immediate Forward - Starplus AVP forwards the call immediately without trying to reach the extension.

If the transfer is supervised or forwarded immediately, then you need to select where the call will be forwarded to. There are several forwarding options you can choose from.

#### D. CALL SCREENING

This feature prompts the caller for his name before transferring the call. Then you hear, "I have a call from (Persons Name). Press 1 to accept the call or 2 to reject." If the call is rejected, it is handled in accordance with the forwarding instructions. This allows you to screen all incoming calls to accept or reject the call.

**E. CALL HOLDING**

This feature allows the caller to remain on hold if your extension is busy. The caller hears, "That extension is busy. To hold press 1, press 2 to select another extension, or 3 to leave a message." With call holding turned off, the call is handled in accordance with the forwarding instructions.

**F. CALL FORWARDING**

This selection allows you to set how a call is handled on a supervised transfer or when the call transfer option is set to immediate. These settings may be changed by the user through extension maintenance for maximum flexibility.

- **Forwarding Off** - disables this feature and the call is not forwarded.
- **Forward to Mailbox** - probably the most common use of this feature. If you don't answer the caller hears your personal greeting and is prompted to leave a message.
- **Forward to Extension** - forwards the call to another extension; for example, a secretary or another sales person.
- **Forward to Menu** - provides the caller with a menu of special options. For example, "For information on Product XXX press 1 or press 2 to leave a message."
- **Forward to Outside Number** - If you do pick up the phone, the call is connected to an outside phone number, like your home or mobile telephone.



## SECTION 230

# Menu Routing

---

### 230.1 INTRODUCTION

This feature allows you to build call processing applications so that callers may access information without the assistance of a live operator by dialing DTMF digits. Callers receive voice prompts such as, "to dial sales, press 1, to dial service, press 2." Based on the digits dialed the system can perform one of a number of actions. The caller could be transferred to an extension, the caller could receive an information announcement, the caller could be routed to voice messaging, etc.. The highlights of this feature are:

- Multi-level menus, the system allows any number of menu levels to be created.
- Three recordings per menu, this allows three different voice recordings to be associated with each menu. There is an introduction prompt, description prompt, and a instruction prompt.
- Time-outs/Retries on a per menu basis. Retries and time outs for user errors can be set on a per menu basis.
- Edit Prompt Feature. This allows the user to enter a menu and change the prompts at any time. This is a password protected function so that callers entering the menu cannot access this without knowing the password. All three prompts on each menu can be edited by the user. This allows messages such as daily specials to be updated while the main greeting (introduction prompt) can remain the same.



## SECTION 300

# FEATURE OPERATION

### 300.1 INTRODUCTION

Starplus AVP is a powerful tool for telephone automation. With it, you can:

- receive voice messages
- send voice messages
- forward messages to a paging device or outside number
- record a personal greeting
- verify the date and time a message was sent
- screen incoming calls
- activate voice menus when you are away from your desk
- be notified of an important message anytime, anyplace
- allow a calling party to wait on hold

This guide is designed to show you how to use the Starplus AVP system features. You will learn:

- What the features are used for.
- How to access them.
- How to change their settings.

Voice prompts guide you through the operation of all the features. In fact, Starplus AVP is so easy to use that you almost do not need this manual. However, by taking the time to read it, you will get the most out of the product.

Note that the system administrator may not have activated all the features described in this manual and, therefore, some may not be accessible. Check with your system administrator about which features are available on your system.

#### A. SOME BASICS

A menu is a group of features or selections. The features can be accessed by pressing 0-9, \*, or # from the dialpad of any push button telephone. Menus are connected in what we call a tree structure, where general topics are broken into more specific areas. For example, "press 1 to retrieve messages, press 2 to send a message, press 8 for personal options." These selections are general topics that deal with a number of feature settings. If you select personal options you hear the following: "press 1 to edit greeting, press 2 to enter name..."

Special keys include the \* which replays the selections of the current menu, and # which takes you back to the previous menu. The \* is also used at specific points in the program to gain access to system features.

**Special Keys**

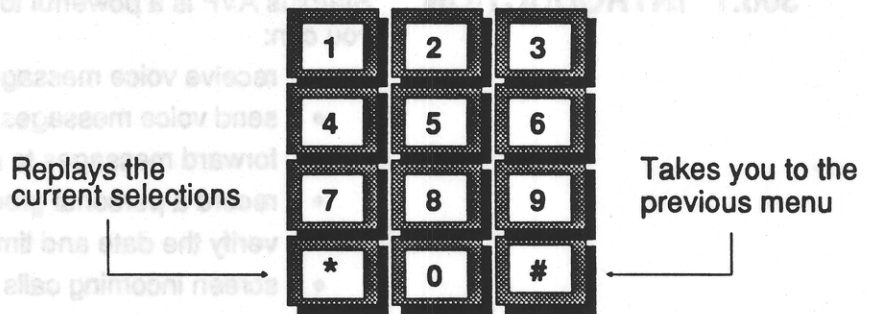

As a new user, press the [\*] key often to replay the menu choices. In this way you will quickly become familiar with the system.

Experienced users may not want to listen to the menu selections at all. In that case, the type ahead feature overrides the voice prompts and allows you to enter a string of keys that will take you to where you want to be.

**B. GETTING STARTED**

Before going further, you need to have the following information:

- The internal number or phone number to access the Starplus AVP system
- Your mailbox number
- Your extension number
- Your Password

The feature operation contains the sections for Voice Messaging, Auto Attendant, and the Menu Routing modules of the Starplus AVP. These sections are described individually.

# SECTION 310

## VOICE MESSAGING OPERATION

### 310.1 INTRODUCTION

Voice Messaging allows users to send and receive voice messages. This eliminates "telephone tag" and increases productivity.

### 310.2 VOICE MESSAGING

The following drawing shows the menu structure for voice messaging:

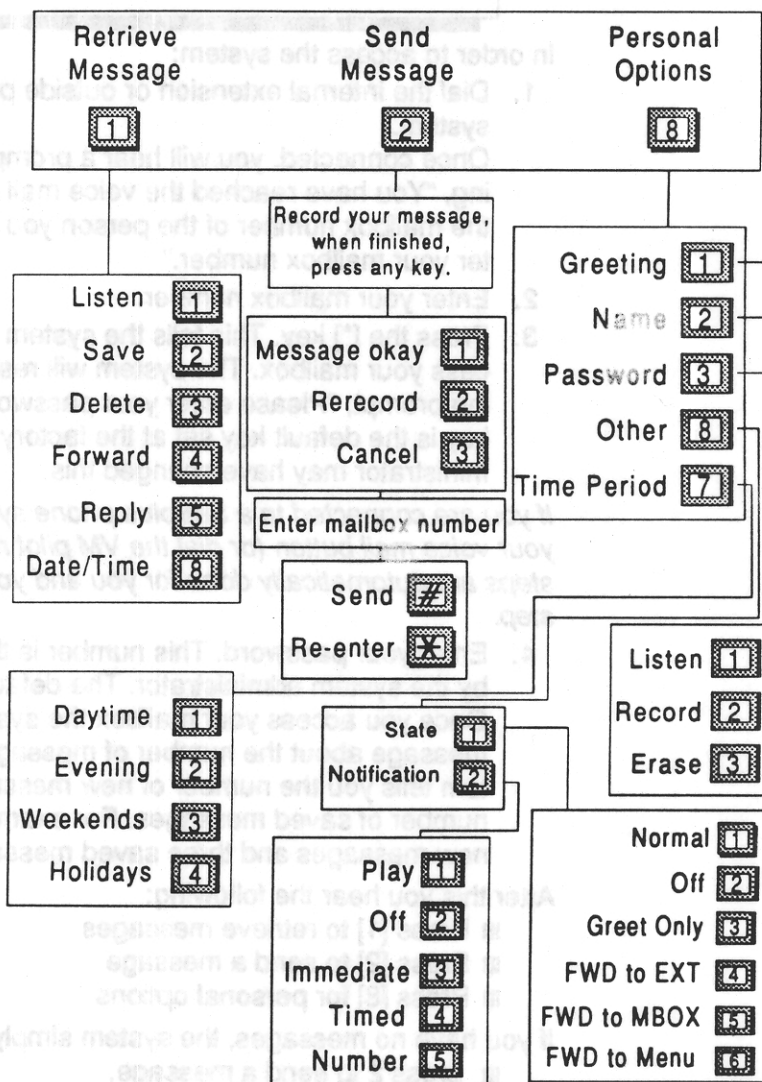

## A. SYSTEM ACCESS

## to Access your Mailbox

1. Dial the internal extension;   
or outside phone number;
2. Enter your mailbox number;
3. Press
4. Enter your password:

In order to access the system:

1. Dial the internal extension or outside phone number of the system.  
Once connected, you will hear a prompt similar to the following, "You have reached the voice mail center please enter the mailbox number of the person you are trying to reach. Enter your mailbox number."
2. Enter your mailbox number.
3. Press the [\*] key. This tells the system that you want to access your mailbox. The system will respond with the following prompt, "Please enter your password." Note that the \* key is the default key set at the factory and the system administrator may have changed this.

*If you are connected to a Starplus phone system, simply press your voice mail button (or dial the VM pilot number). The first three steps are automatically done for you and you begin at the next step.*

4. Enter your password. This number is the initial password set by the system administrator. The default password is 0000. Once you access your mailbox the system always plays a message about the number of messages you have. The system tells you the number of new messages, and then the number of saved messages. For example, "you have two new messages and three saved messages."

After this you hear the following:

- Press [1] to retrieve messages
- Press [2] to send a message
- Press [8] for personal options

If you have no messages, the system simply prompts you to:

- press 2 to send a message,
- or press 8 for personal options.

As a new user, you need to:

1. Record your name as the owner of this mailbox
2. Change the security code
3. Record a personal greeting

**B. RECORD NAME**

Recording your name provides a personalized identity for your mailbox. For example, when another VM user leaves you a message they hear the following prompt, "message has been sent to (Your Name)." This gives the caller a confirmation that the message has been sent to the correct person. If a name is not recorded the caller hears, "message has been sent to mailbox 1234."

**to Record your Name**

1. Press **8** for personal options
2. Press **2** to edit name
3. Press **2** to record a new name

1. Press [8] for personal options.

2. Press [2] for name option.

*The current name (if recorded) will be played.*

3. Press [2] to record your name.

Once the name has been recorded you can

■ press [1] to listen to the current name

■ press [2] to record again

■ press [3] to erase it

### C. PASSWORD

To keep your messages confidential and prevent unauthorized use of your mailbox, you need to change the password. The password can be changed as often as you like.

The password is a four digit number, unless you are told otherwise by the system administrator. Select a code that is easy to remember but is not obvious. For example, do not use 5555. However, the first four digits of your home telephone number might work well. If you forget the code, the administrator can reset the mailbox.

#### to Enter a new Password

1. Press **8** for personal options
2. Press **3** to edit your password
3. Press **2** to record a new password

1. Press [8] for personal options.

2. Press [3] for password option.

*The current password is played.*

3. Press [2] to enter a new password.

Once the security code is entered, you can:

- press [1] to review it
- press [2] record a new code



## D. GREETING

The greeting is a personal message that a caller hears when he dials your mailbox. The greeting usually tells the caller that you are not available, when you can be reached, and how to record a message. When you record a greeting, try speaking at a natural pace, perhaps just slightly faster than normal.

An example of a typical greeting might be, "Hello, this is Roger Smith. I'm either on the phone or out of the office. After the tone please leave your name, number, and a detailed message. I'll return the call as soon as possible. When you have finished the message you can hang up, or press any key for more options."

Instructing the caller to press any key at the end of his message allows him to select from a number of editing options including, review, re record, and send.

If you do not record a personal message, the system plays the following canned message, "The person you are trying to reach is unavailable. Your call is being answered by the Starplus Automated Voice Processing system. After the tone record your message. When you are finished, you can hang up or press any key for other options."

### to Record a new Greeting

1. Press **8** for personal options
2. Press **1** to edit your greeting
3. Press **2** to record a new greeting

1. Press [8] for personal options.
2. Press [1] for greeting.

*The current greeting (if recorded) is played.*

3. Press [2] to record a greeting.

Once the greeting has been recorded, you can:

- press [1] to review it
- press [2] re-record
- press [3] to erase it

## E. RETRIEVING MESSAGES

When messages are retrieved, new messages are played back before previously saved messages, and they are played in the order they were received. The oldest message is played first.

The diagram below shows the features available while you are reviewing the messages. Features can be accessed at any time. It is not necessary, to wait until the end of the message. After hearing you have a message, Press 1 to listen to the message.

### to Retrieve Messages

1. Enter your mailbox # + \* + password

2. Press **1** to retrieve messages

3. Message must be deleted, or saved

1. Press [1] to listen to the message.

After listening to a message, you must do one of the following:

- Delete, Press [3]
- Save, Press [2]
- Forward, Press [4]

**Note that even if a message is forwarded, it must be deleted or saved.**

In most cases, you will probably delete the message. If you save it, be aware that the system will automatically erase the message after a period of time. This time is called the retention period and is typically set to a week or so, but ask the system administrator to be sure.

- Forward, Press [4] - allows you to pass the message along to another mailbox owner. To use this feature you must know the mailbox number of the person you want to forward the message to. You may forward the message as is or you may add introductory comments (pre-amble) to the message. In this case, the person receiving the forwarded message will hear your pre-amble (comments) first followed by the message.
- Reply, Press [5] - is used to respond directly to the person who left you the message without having to enter a mailbox number. To use this feature, the message must have been sent from another mailbox owner.

- Date/Time, Press [8] - gives you the date and time that the message was sent. The system automatically attaches this information to each message.

**Note that if you hang up without doing a delete or save, your messages are automatically saved in the same state as they were when you accessed the mailbox.**

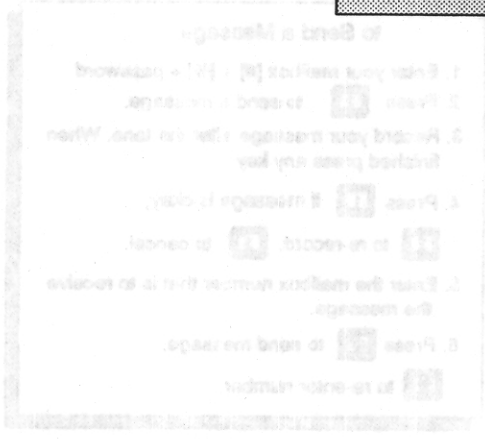

1. Press [5] to enter mailbox number.
  2. Record your message after the tone and press any key after recording to end the message.
  3. Press [1] if message is okay.
  4. Enter the desired mailbox number.
  5. Press [4] to send the message or [7] to re-enter the mailbox number.
  6. Enter the next mailbox number to send to, or press [9].
- After you finish recording the message and before you press 1 (step 3) to send it, you are given the following options:
- a. Listen to the message. Press [4].
  - b. Cancel the message. Press [3].
  - c. Re-record the message. Press [2].

FUNCTION	MESSAGE
SEND the message	[4]
RECORD the message	[2]
CANCEL the message	[3]
LISTEN to the message	[4]



**F. SENDING A MESSAGE**

You may send messages to other mailbox owners or to a distribution list. A distribution list is a group of mailboxes which will receive the message. You only have to record the message once and the system will automatically send it to the mailboxes in the distribution list. You may send a message to one or any number of mailboxes after recording it.

**to Send a Message**

1. Enter your mailbox [#] + [\*] + password
2. Press **[2]** to send a message.
3. Record your message after the tone. When finished press any key.
4. Press **[1]** if message is okay,  
**[2]** to re-record, **[3]** to cancel.
5. Enter the mailbox number that is to receive the message.
6. Press **[#]** to send message,  
**[\*]** to re-enter number.

You may repeat from step 5 until all desired mailboxes are entered.

1. Press [2] to send a message.
2. Record your message after the tone and press any key after recording to end the message.
3. Press [1] if message is okay.
4. Enter the desired mailbox number.

**The person's name (if recorded) or mailbox number is played.**

5. Press [#] to send the message or \* to re-enter the mailbox number.
6. Enter the next mailbox number to send to, or press [#].

After you finish recording the message and before you press 1 (at Step 3) to send it, you are given the following options:

- Re-record the message, Press [2]
- Cancel the message, Press [3]
- Listen to the message, Press [4]

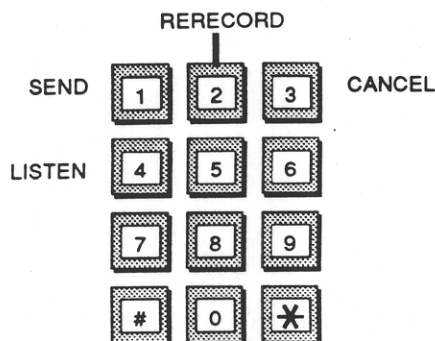

PRESS	FUNCTION
<b>[1]</b>	SEND the message
<b>[2]</b>	RERECORD the message
<b>[3]</b>	CANCEL the message
<b>[4]</b>	LISTEN to the message

**G. REPLY TO SENDER**

Reply to Sender allows the user to respond to a mailbox message. Starplus AVP will automatically send your reply to the person whose message you are responding to. If a response is not permitted, the option key will not be included as part of the menu.

**to Reply to Message**

1. Enter your mailbox # + \* + password
2. Press **[1]** to retrieve messages
3. Press **[5]** to reply to message
4. Press **[1]** to continue reply
5. After the tone leave your message
6. Hangup to automatically send the reply

1. Press [1] to retrieve your message.
2. Press [5] to reply to message.
3. Press [1] to continue reply.
4. After the tone, leave your message.
5. Hangup to send the reply automatically.

If you need to edit the message, press any key on the telephone key pad instead of hanging up the phone to send the message. Starplus AVP will present the following options:

- Send the message, Press [1]
- Replay the message, Press [2]
- Cancel the message, Press [3]
- Re-record the message, Press [4]

**Press                      Function**

send	1	2	3	4	5	6	7	8	9	*	0	#	cancel
rerecord													

<b>1</b>	<b>SEND</b> the message
<b>2</b>	<b>REPLAY</b> the message
<b>3</b>	<b>CANCEL</b> the message and replay menu
<b>4</b>	<b>RERECORD</b> the message

To use this feature, the message that you are responding to must have been sent from within a mailbox in your Starplus AVP system.

**H. STATE**

The mailbox State determines how the system handles a call when someone tries to leave a message. Usually, this means playing the called party's personal greeting and then prompting the caller to leave a message. However, several other feature selections allow the call to be handled differently.

**to Set the State**

1. Enter your mailbox number and password
2. Press **8** for Personal Options
3. Press **8** for Other options
4. Press **1** for State
5. Select the State

1. Press [8] for personal options.
2. Press [8] for other options.
3. Press [1] for the state option.

The diagram below shows the selections available and a description of what they are used for:

Press	Function
<b>1</b>	NORMAL mode of operation
<b>2</b>	OFF mailbox is not available
<b>3</b>	GREETING ONLY does not take message
<b>4</b>	FORWARD to an extension
<b>5</b>	FORWARD to a mailbox
<b>6</b>	FORWARD to a menu

- Normal, Press [1] - plays personal greeting and then takes the caller's message.
- Off, Press [2] - disables the mailbox and caller hears, "This mailbox is not available. Press 1 to try another mailbox or 0 for an operator."
- Greeting only, Press [3] - plays the personal greeting only and then, Press 1 to try another extension or 0 for an operator.
- Forward to an extension, Press [4] - transfers the call to an extension instead of taking a message.
- Forward to a mailbox, Press [5] - transfers the call to another mailbox instead of this one. For example, in the evening a sales department might want messages left in a generic mailbox with common password access.
- Forward to a menu, Press [8] - transfers the caller to a custom designed menu with a number of selections.

**I. MESSAGE NOTIFICATION**

Message Notification instructs the system to contact you on receipt of a message by dialing an alternate phone number or activating a paging device.

**to Set Message Notification**

1. Enter your mailbox number and password
2. Press **8** for Personal Options
3. Press **8** for Other options
4. Press **2** for Notification
5. Select the type of notification

1. Press [8] for personal options.
2. Press [8] for other options.
3. Press [2] for notification.

Notification type can either be immediate or timed. Where immediate the system will dial you as soon as the message is left, or timed where the system waits to a set time before dialing you.

The following diagram shows you the selections:

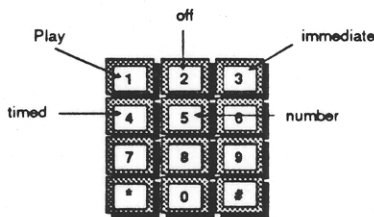

**Press                      Function**

- 1**      PLAY the current setting
- 2**      OFF disables message notification
- 3**      IMMEDIATE notifies on receipt
- 4**      TIMED to set the time of day
- 5**      NUMBER to notify at ext or outside phone

- Play, Press [1] - is used to hear the current settings.
- Off/On, Press [2] - turns this feature off/on.
- Immediate/Timed, Press [3] - toggles the type of notification you want.
- Timed, Press [4] - is used to set the reminder time.
- Number, Press [5] - is used to set the number where you can be reached. This number can be an internal extension, outside phone number, or digital pager.

When the system calls you it will say, "You have a new message for Your Name. Please enter your password to accept the message."

Of course, you can access your messages manually at anytime. However, if you are expecting an important message or do not plan to be in the office, this feature provides added flexibility.

If you are not available when the system tries to reach you, it will redial periodically until you receive the message.

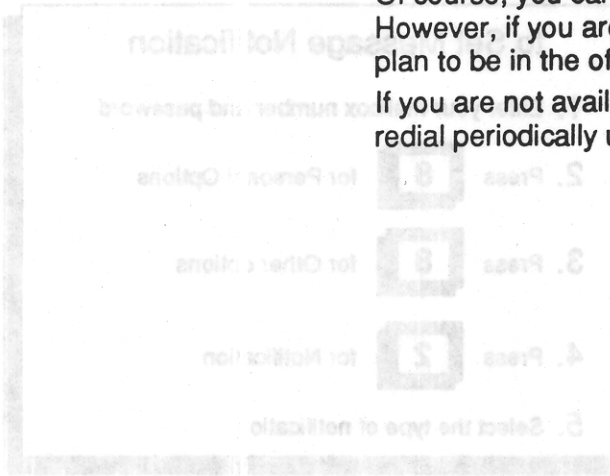

1. Press [5] for Notification.
2. Press [8] for Other Options.
3. Press [8] for Other Options.

Notification type can either be immediate or timed. When a timed notification type is selected, the system will dial you as soon as the message is left. The following diagram shows you the 5 options:

Function	Press
PLAY the current setting	[1]
OFF disables message notification	[2]
IMMEDIATE notifies on receipt	[3]
TIMED to set the time of day	[4]
NUMBER to notify at ext or outside phone	[5]

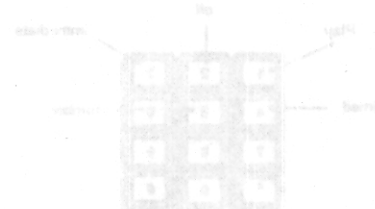

At Play, Press [1] - is used to hear the current setting.  
 At Off, Press [2] - turns this feature off.  
 At Immediate/Timed, Press [3] - to give the type of notification you want.  
 At Timed, Press [4] - is used to set the reminder time.  
 At Number, Press [5] - is used to set the number where you can be reached. This number can be an internal extension, outside phone number, or digital pager.



**J. EDIT TIME PERIOD**

Edit Time Period allows the mailbox owner to edit mailbox settings for: Daytime, Evenings, Weekends, and Holidays. To select a time period:

**to Edit Time Period**

1. Enter your mailbox # + \* + password
2. Press **8** for personal options
3. Press **7** to edit time period
4. Select a Time Period to edit

1. Press [8] for personal options.
2. Press [7] for time period option.
3. Press [1 - 4] to edit desired period.

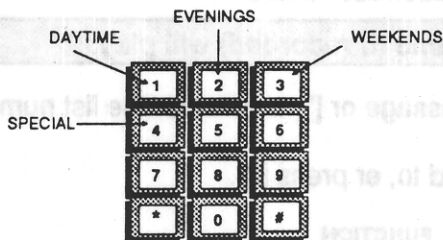

**Press Function**

- 1** for DAYTIME
- 2** for EVENINGS
- 3** for WEEKENDS
- 4** for HOLIDAYS or SPECIALDAYS

After selecting a time period, additional options will be presented. The options correspond to the specific Timed Settings options and parameters found in Edit Mailbox:

- Press [1] to edit Greeting
- Press [2] to edit Name (the same for all time periods)
- Press [3] to edit Password (the same for all time periods)
- Press [7] to change edit time period
- Press [8] for Other Settings
- Press [1] to edit Mailbox State
- Press [2] to edit Message Notification State

**K. SEND MESSAGE TO DISTRIBUTION LIST**

Send Message To Distribution List allows the user to create a message and send it to a distribution list. To use this feature, the Lists setting in Class of Service must have been set to either Personal or System.

Send a Message to a Distribution List

1. Enter your mailbox # + \* + password
2. Press **[2]** to send a message.
3. Record your message after the tone. When finished, press any key.
4. Press **[1]** if message is okay  
**[2]** to re-record, or **[3]** to cancel.
5. Enter the three digit list number that is to receive the message.
6. Press **[#]** to send, or press **[\*]** to re-enter.

1. Press [2] to send a message.
2. Record your message after the tone and press any key after recording to end the message.
3. Press [1] if message is okay.
4. Enter the desired distribution list number.

**The distribution name (if recorded) will play.**

5. Press [#] to send the message or [\*] to re-enter the list number.
6. Enter the next list to send to, or press [#].

PRESS	FUNCTION
<b>[1]</b>	SEND the message
<b>[2]</b>	RERECORD the message
<b>[3]</b>	CANCEL the message
<b>[4]</b>	LISTEN to the message

After you finish recording the message and before you press 1 (at Step 3) to send it, you are given the following options:

- Re-record the message, Press [2]
- Cancel the message, Press [3]
- Listen to the message, Press [4]

# SECTION 320 AUTOMATED ATTENDANT OPERATION

**320.1 INTRODUCTION** The following drawing shows the menu structure for the automated attendant:

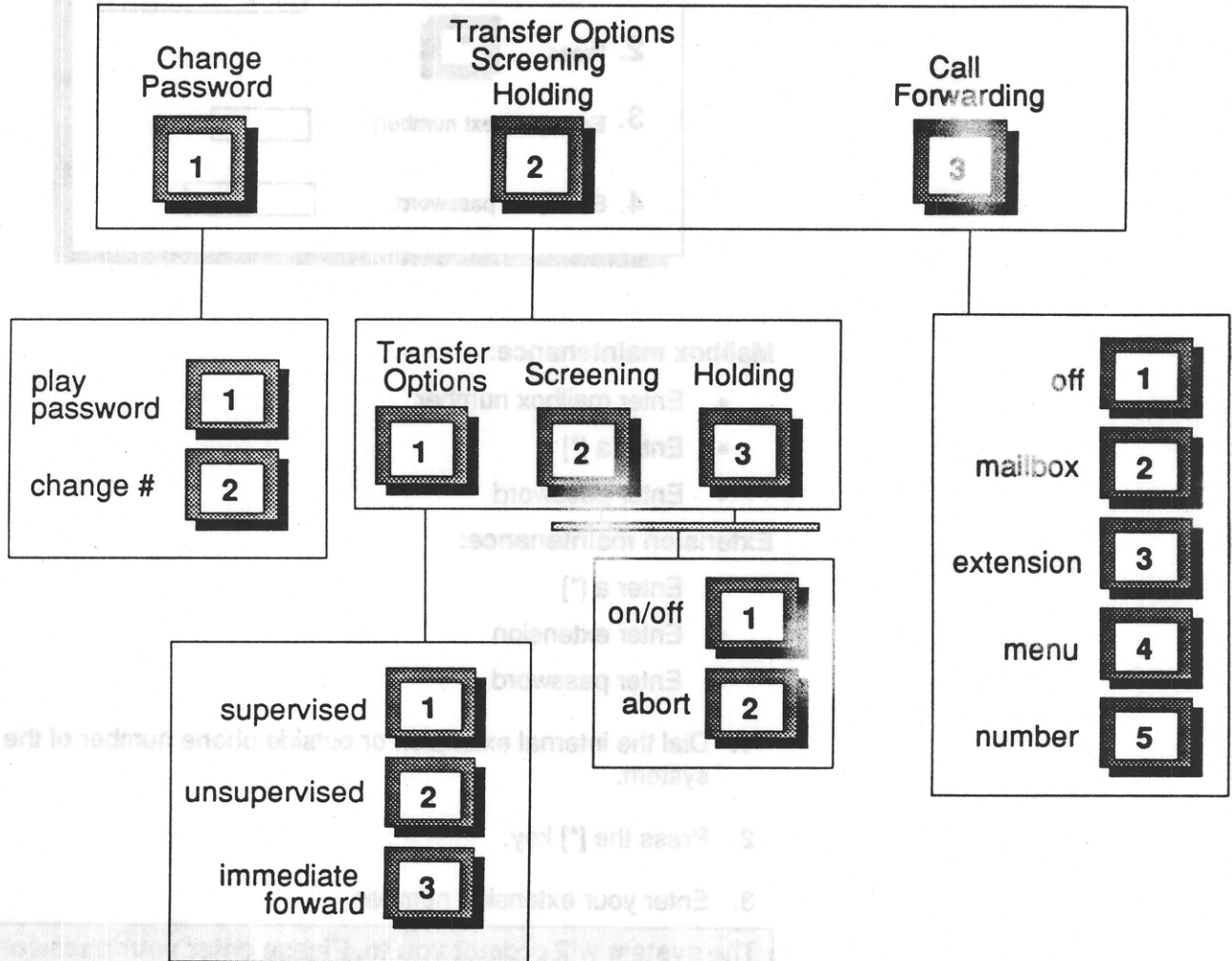

**A. SYSTEM ACCESS**

System access allows you to set and edit the special features that come with the automated attendant. You access extension features like you do for voice messaging; by dialing into the system, pressing the key, and then entering your password. However, note that the key sequences are slightly different.

**to Access Extension Maintenance**

1. Dial the internal extension;   
 or outside phone number;
2. Press
3. Enter your ext number;
4. Enter your password:

Call Forwarding

1

2

3

4

5

**Mailbox maintenance:**

- Enter mailbox number
- Enter a [\*]
- Enter password

**Extension maintenance:**

- Enter a [\*]
- Enter extension
- Enter password

1. Dial the internal extension or outside phone number of the system.
2. Press the [\*] key.
3. Enter your extension number.

**The system will prompt you to, Please enter your password.**

4. Enter your password.

This number is the initial password set by the system administrator. Once you access the extension maintenance menu you hear the following:

"To change password press 1, to change call options, screening, or call holding press 2, to change call forwarding press 3."

As a new user, you need to change your security code

**B. PASSWORD**

To prevent unauthorized access to your extension feature settings, you need to change the password. The password can be changed as often as you like. It is a four digit number unless you are told otherwise by the system administrator. If you forget the code, the administrator can reset it.

**to Enter a new Password**

1. Press **1** to change your password

2. Press **2** to record a new password

1. Press [1] for the password.

Once the security code is entered, you can:

- press [1] to review it
- press [2] record a new code

**You should always record your own personal password for security purposes.**

**C. CALL TRANSFER OPTIONS**

The diagram below shows the transfer option selections. The Starplus AVP can transfer calls utilizing several methods. The user can change these methods through extension maintenance.

**to Set Call Transfer Option**

1. Enter your extension number and password
2. Press **[2]** to change Transfer Option
3. Press **[1]** to select Transfer Option
4. Select Transfer Option

1. Press [2] for the call transfer option.
2. Press [1] to select transfer option.

When Starplus AVP forwards a call to your extension the transfer can be:

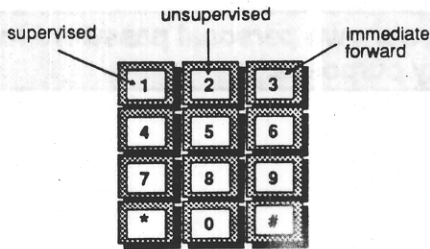

**Press                      Function**

- [1]**      SUPERVISED TRANSFER
- [2]**      UNSUPERVISED TRANSFER
- [3]**      IMMEDIATE FORWARDING

- Supervised, Press [1] - Starplus AVP monitors the transfer. If you do not answer, the call is forwarded.
- Unsupervised, Press [2] - Starplus AVP does not monitor the transfer. The call is not forwarded in the event you do not answer.
- Immediate Forward, Press [3] - Starplus AVP forwards the call immediately without trying to reach the extension.

If the transfer is supervised or forwarded immediately, then you need to select where the call will be forwarded to.

**D. CALL SCREENING**

This feature prompts the caller for his name before transferring the call. Then, you hear, "I have a call for Your Name. Press 1 to accept the call or 2 to reject." If the call is rejected, it is handled in accordance with the forwarding instructions. To change these options:

**to Set Call Screening**

1. Enter your extension number and password
2. Press **2** to change Screening Option
3. Press **2** to select Screening Option
4. Select Screening Option

1. Press [2] for the call transfer option.
2. Press [2] to select screening option.

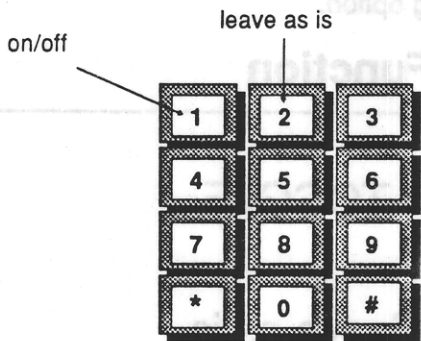

**Press Function**



**ON/OFF TOGGLE**



**ABORT leave as is**

Select the screening option:

- On/Off, Press [1] to toggle.
- Abort, leave as is, Press [2]

**E. CALL HOLDING**

This feature allows the caller to remain on hold if your extension is busy. The caller hears, "That extension is busy. To hold press 1, press 2 to select another extension, or 3 to leave a message." With call holding turned off, the call is handled in accordance with the forwarding instructions.

**to Set Call Holding**

1. Enter your extension number and password
2. Press **2** to change Holding Option
3. Press **3** to select Holding Option
4. Select Screening Option

To change these options:

1. Press [2] for the call transfer option.
2. Press [3] to select holding option.

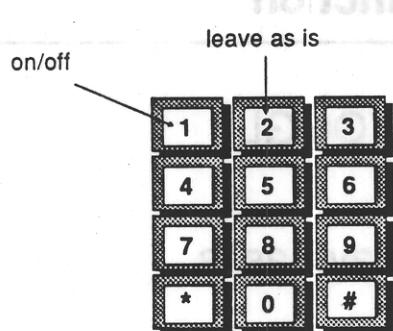

**Press Function**

- 1** ON/OFF TOGGLE
- 2** ABORT leave as is

Select the holding option:

- On/Off, Press [1] to toggle.
- Abort, leave as is, Press [2]



## F. CALL FORWARDING

This selection allows you to set how a call is handled on a supervised transfer or when the call transfer option is set to immediate.

### to Set Call Forwarding

1. Enter your extension number and password
2. Press **3** to change Forwarding
3. Select Forwarding Option

1. Press [3] to select forward option.

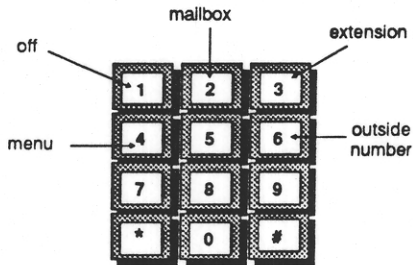

Press	Function
<b>1</b>	OFF forwarding disabled
<b>2</b>	MAILBOX forward
<b>3</b>	EXTENSION forward
<b>4</b>	MENU forward
<b>5</b>	OUTSIDE NUMBER forward

Select forward option.

- Forwarding Off, Press [1] - disables this feature and the call is not forwarded.
- Forward to Mailbox, Press [2] - probably the most common use of this feature. If you don't answer the caller hears your personal greeting and is prompted to leave a message.
- Forward to Extension, Press [3] - forwards the call to another extension; for example, a secretary or another sales person.
- Forward to Menu, Press [4] - provides the caller with a menu of special options. For example, "For information on Product XXX press 1 or press 2 to leave a message."
- Forward to Outside Number, Press [5] - if you do pick up the phone, the call is connected to an outside phone number, like your home or mobile telephone.



## SECTION 330

# MENU ROUTING OPERATION

### 330.1 INTRODUCTION

This feature allows you to build custom call processing applications so that callers may access information without the assistance of a live operator by dialing DTMF digits. Callers receive voice prompts such as, "to dial sales, press 1, to dial service, press 2". Based on the digits dialed by the user the system can perform one of a number of actions. The caller could be transferred to an extension, the caller could receive an information announcement, the caller could be routed to voice messaging, etc.

Two terms need to be defined before going into the Menu Routing feature, they are:

- Menu
- Action

A menu is a list of actions that is executed through touch tone key pads. As an example, "to dial sales, press 1, to dial service, press 2". A menu can have up to twelve (12) options each one corresponding to a key on a standard telephone keypad plus one option for a default action.

An action is an instruction that is selected from the menu action list. It tells the system how to respond when a specific key is pressed. An action can invoke another module (for example, voice messaging or bring up another menu in menu routing) or perform a special feature (for example, play a prerecorded message).

#### A. PREPARATION

Before you attempt to set up a complicated, multi-level menu, you need to read this section of the manual first. It is important that you understand the mechanics of building a Menu Routing menu. Next, draft your ideas on a piece of paper. If you can, prepare a draft flow chart to define your ideas. If your ideas are not yet sufficiently organized to do this, jot them down on a piece of paper. Don't worry about a specific order, at this stage it is more important to document your thoughts on paper so that alternatives won't be forgotten. Obviously, your drawing will depend on your application and does not need to be as detailed. However, try to put your concept in print so you have a blueprint that can be used to build your system.

To facilitate the create of the menus use a form like the one below. It is a replica of what you will see when you edit your Menu Rout-

**MENU ROUTE DATABASE FORM**

Menu Name \_\_\_\_\_

**PROMPTS**

Introduction \_\_\_\_\_ .Hvx

Description \_\_\_\_\_ .Mvx

Instruction \_\_\_\_\_ .Ivx

Password \_\_\_\_\_

**KEY ACTIONS**

<b>1</b> _____	<b>6</b> _____
<b>2</b> _____	<b>7</b> _____
<b>3</b> _____	<b>8</b> _____
<b>4</b> _____	<b>9</b> _____
<b>5</b> _____	<b>0</b> _____
<b>/</b> _____	<b>X</b> _____

Time Out \_\_\_\_\_

ing menus. Again, the idea is to put your thoughts on paper first. When you make mistakes, they can be easily changed.

### 330.2 MENU ROUTING

1. Highlight Menu Routing in the Modules sub menu and press [ENTER]. The Menu Routing sub menu will be presented.

MAINT an525100 Configuration Modules Reports Utilities HouseKeeping v+3.10a

Menu Routing  
Menu Maintenance  
Settings

---

Edit, Create, Delete, and Print menus.  
Esc: back a menu    Return: selects    ⇐: back a menu    ↓: moves bar

- **Menu Maintenance** - is used to create, delete, or edit menus
- **Settings** - is used to define the timers and counters that reset the menu state in the event of a caller time-out or series of incorrect dial pad entries.

When you enter the menu, Menu Maintenance will be highlighted.

2. Press [ENTER] again to display the Menu Maintenance mode.

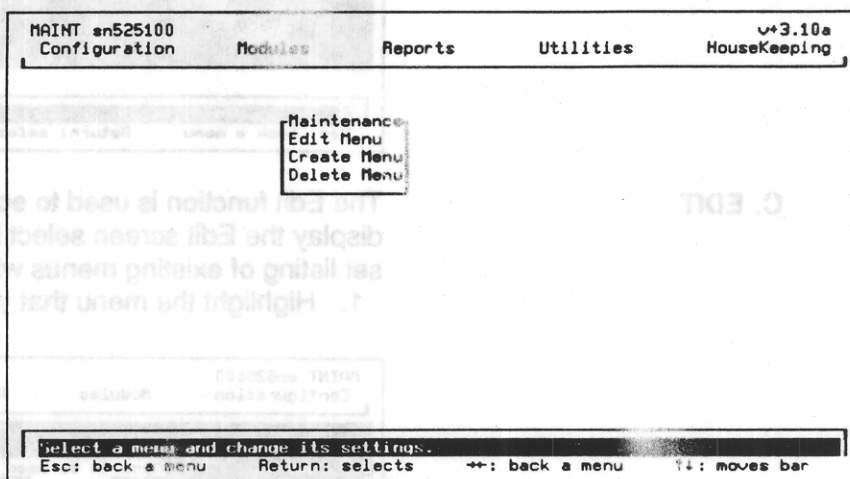

Three maintenance options are available:

- **Edit Menu** - is used to edit a new or existing voice menu
- **Create Menu** - is used to create a new voice menu
- **Delete Menu** - is used to delete an existing voice menu

As with the other Starplus AVP modules, you must first create a menu before you can edit it. After you have created the menu the actual menu design is done in Edit menu topic.

This command allows you to create a menu that does not currently exist.

1. Select Create from the Menu Maintenance menu and the Create data entry screen will be presented.
2. Enter up to eight characters that describe the menu. The name should be descriptively recognizable so that later you can select it from a list and know what its about without looking at it. Also, any spaces are converted to underscores.
3. After pressing [F9] you will be put into the edit screen.

See Edit in the following pages.

## A. CREATE

## B. DELETE

If you want to remove a menu that is no longer needed use the Delete option.

1. Select Delete from Menu Maintenance and an inset listing of existing menus will be presented.
2. Move the highlight bar to select the menu that is to be deleted and press [Enter].

*Be very careful with this option. Once a menu is deleted it is no longer recoverable.*

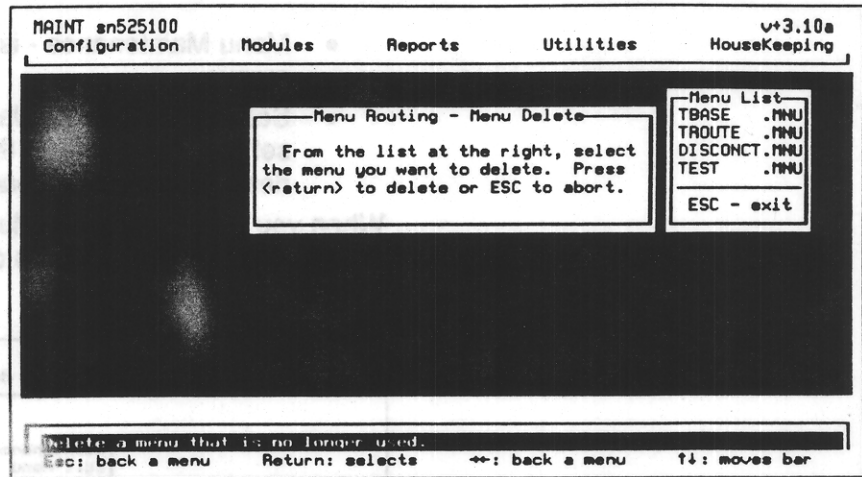

C. EDIT

The Edit function is used to edit both new and existing menus. To display the Edit screen select Edit from Menu Maintenance. An inset listing of existing menus will be presented.

1. Highlight the menu that you wish to edit and press [ENTER].

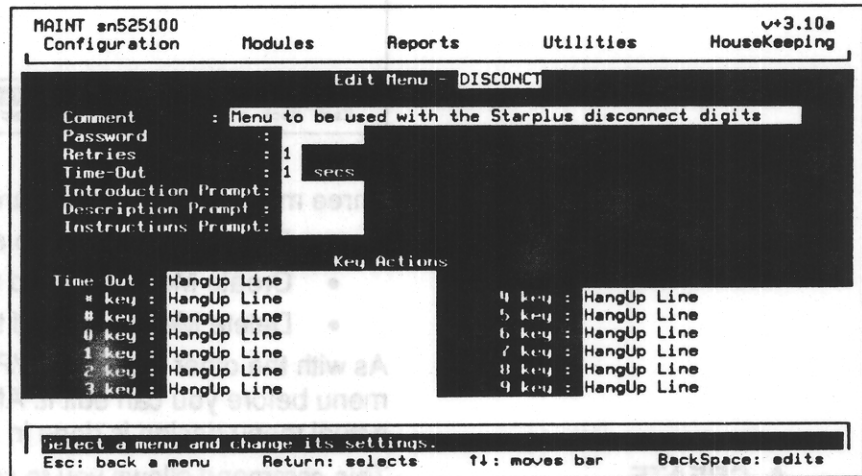

The Edit Menu screen will be presented. If it is a new menu being edited, the data entry fields will be blank. If it is an existing menu, entries will already be provided.

The Edit screen is made up of several sections. At the very top of the screen is the name of the menu.

2. Enter the desired comment in the comment line.  
This is usually a brief statement as to the purpose of the menu. For example, description of product information or transfers of bank funds. It might also be used to remind yourself of a special message like need to complete this by Tuesday.
3. Enter the password that will be needed if the voice prompts on this menu are to be edited over the phone.  
Users may edit the prompts on the menu by pressing the correct key. Upon pressing this key, they will be required to en-

ter the password. This key is set up in the key actions area of the screen.

4. Enter the desired number of retries a user can have on this menu, [0-9].

If the user exceeds this value, the system will play an ending prompt and disconnect the caller. A value of 0 allows an infinite number of retries.

5. Enter the desired time-out in seconds the menu should use, [0-99]

This defines the maximum time, if a user takes no action, the system will wait before taking action.

Each menu can have up to three prompts associated with it.

These prompts are broken down into introduction, description, and instructions.

- Introduction is played only once; when the caller enters the menu and it is always played first. The introduction is often a greeting or special message.  
For example, Thank-you for calling The Corner Grocery..
- Description sometimes contains special information, but usually is the main topic of the menu. It is played right after the Introduction.

An example of a special message that changes regularly might be, Don't miss our special of the week; turkey cutlets for twenty five cents a pound..

An example of a main topic is a product description. Assume the menu is a previous menu that says, Dial 1 for information on product A, dial 2 for information on product B....

The information on product A would be recorded in the Description prompt.

- Instructions includes the basic instructions on how to use this menu. This file is always played right after the Description.  
For example, Please dial 1 for administration, 2 for support, 3 for instructions or stay on the line and an operator will be with you momentarily. Almost all menus have Instructions. Usually the first menu in a multi-level structure has an Introduction and Description. However, It is not mandatory to have these prompt files and their existence is dependent on the application design.

6. Move the highlight bar to Introduction and press [ENTER] to select from a list of previously created voice prompts. If the prompt file has not yet been created do the following:

- Press [F9]
- Enter the name of the file and press [ENTER]. (Use a descriptively recognizable name.)
- Select Record Over from the Operations list and follow the screen directions. (See Utilities\Recording Studio for complete instructions.)

7. Move the highlight bar to Description and press [ENTER] to select from a list of previously created voice prompts. If the

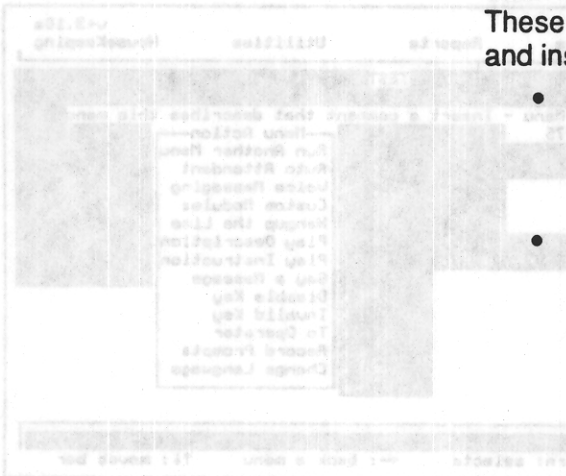

- prompt file has not yet been created, follow the procedure given above for the Introduction prompt.
8. Move the highlight bar to Instructions and press [ENTER] to select from a list of previously created voice prompts. If the prompt file has not yet been created, follow the procedure given above for the Introduction prompt.

The bottom part of the screen is concerned with Key Actions.

**D. KEY ACTIONS**

Key actions define the response that is invoked when a particular key is selected. Note there is a field for each dial-pad key and a special field labeled time-out. The time-out field is used to describe what happens when the caller fails to do anything.

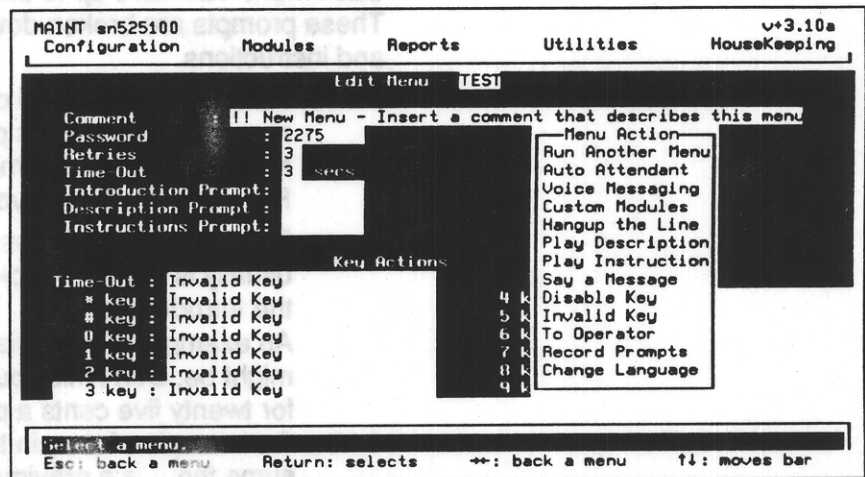

1. To define an action, move the highlight bar to select the desired key and press [ENTER].
2. Move the highlight bar to select an action and press [ENTER]. A description of the action appears next to the key.
  - Run Another Menu - executes the menu selected.
  - Auto Attendant - is used to transfer a call through either a direct transfer, a request for the caller to enter an extension number, or by means of a start key. If you select Auto Attendant, 3 transfer options will be presented:
    - Direct Transfer - select this option to automatically route a caller to a specific extension. Choose the appropriate extension from a listing of extensions that is presented when the option is entered.
    - Request Extension - choose this option when you want Starplus AVP to request that the caller enter a specific extension to which the transfer is to be made.
    - Start Key - choose this option to designate a specific key to be the beginning digit of an extension number. For example, if all of your office extensions begin with 1, 2, or 3, you can set these specific keys as start keys. When a caller enters the extension number, Menu Routing will automatically know by the first key pressed that it is an extension and will automatically pass the extension number to Auto Atten-



dant. Your instructions would read Enter the extension of the person you wish to reach or press (for example) 4 for sales, ....

- **Voice Messaging** - is used to record the caller's message by either sending him directly to a default mailbox, requesting him to enter a mailbox number, or by means of a start key. If you select Voice Messaging, 3 transfer options will be presented:
  - **Direct Transfer** - Select this option to automatically route a caller to a specific mailbox. Choose the appropriate mailbox from a listing that is presented when the option is entered.
  - **Request Mailbox** - choose this option when you want Starplus AVP to request that the caller enter a specific mailbox to which the transfer is to be made.
  - **Start Key** - choose this option to designate a specific key to be the beginning digit of an mailbox number. For example, if all of your office mailboxes begin with 1, you can designate this specific key as start keys. When a caller presses 1, Menu Routing will automatically know by the key pressed that it is a mailbox number and will automatically route the call. Your instructions would read, Enter the mailbox number of the person you wish to reach, or press (for example) 4 for sales....
- **Other Modules** - allows you to select from a list of special modules. *This feature is not used at this time.*
- **Custom Modules** - other modules that Starplus AVP supports. *This feature is not used at this time*
- **Hang-up the Line** - plays the message, "thank-you for calling," and the caller is disconnected. For example, a menu might include this option at the end of a list, press 1 for sales, 2 for support, # to return to the previous menu, and 9 to disconnect.
- **Play Description** - replays the Description prompt followed by the Instruction prompt. For example, "to listen again to the specials of the week, press 4".
- **Play Instruction** - replays only the Instructions prompt. For example, To hear this menu again press \*.
- **Previous Menu** - takes the caller back one menu as specified in the Previous Menu field at the top of the screen.
- **Say a Message** - can be any type of information. The message is not restricted in recording length. Therefore, it can be a brief description or a lengthy discussion. However, in general, do not record main topics here. That information is reserved for the Description prompt which has greater flexibility. Note, that the Instruction prompt file is always repeated right after the Say message.
- **Disable Key** - pressing a key with this action has no affect at all. It's as if the key were never pressed.
- **Invalid Key** - plays the message, "invalid key," and then repeats the Instructions prompt.

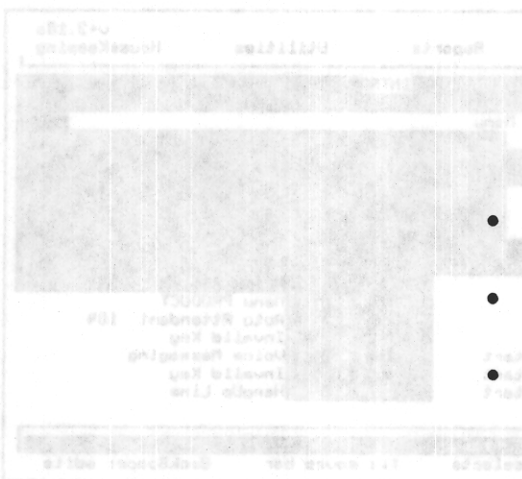

- To Operator - transfer caller to operator by doing a blind transfer to 0.
  - Record Prompts - allows caller to re-record prompts for a menu. The caller, after pressing the key associated with this action, is prompted for the menu password. The Introduction, Description, Instructions, or any say file attached to a particular key can then be edited. This feature is useful for menus that are changed often. The system will prompt the different voice files that can be edited.
3. Repeat this procedure for all keys entering the desired function at each key.

Press the [ESC] key when you are finished.

**E. SAMPLE MENUS**

Intro is a typical menu. The name of the menu, Intro, is at the top. There is no Previous Menu since this is the top level.

The Introduction is a file called Intro. It is played once when the call is answered. There is no Description to this menu, just a set of

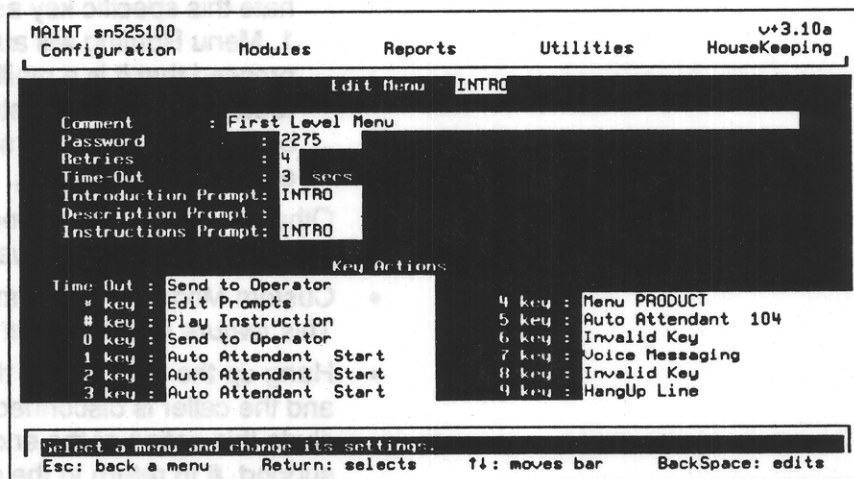

Instructions. As soon as a caller enters a menu the voice files are played, one after the next. The caller can interrupt the message at any time by pressing a key.

- Keys #1, #2, and #3 are Auto Attendant start keys. Anytime a caller presses one of these keys, Starplus AVP will assume that it is the first digit of an extension number and will automatically route the call when the remaining digits are entered.
- Key #7 is Voice Messaging alone, while the rest of the Auto Attendant keys (Time-out, 0, 4, and 5) have extension numbers. This is because key #5 is a transfer by requesting the caller for the extension number. The others involve direct transfers to departments.
- Note that the \* and # keys perform special editing functions and 0 sends the caller to a live operator. The Time-out key, as well as the #0, key are direct transfers to the operator.
- Key #4 and Key #5 are direct transfers to other extensions.
- Key #7 will permit a caller to leave a voice message in any specified mailbox.

- Key #9 will disconnect the caller.
- Key #4 takes the caller to a secondary menu.

The name of this menu is Product and it is accessed by pressing key #4 from the Intro menu as described on the page before. The Comment field describes the purpose of the menu.

Neither an Introduction prompt nor a Description prompt is needed. There isn't any need for one. The purpose of this menu is

MAINT en525100		Files	Reports	Utilities	v+3.10a
Configuration					HouseKeeping
		Edit Menu PRODUCT			
Comment :	Off of Intro, to provide information on SPAVP.				
Password :	2275				
Retries :	4				
Time Out :	3 secs				
Introduction Prompt :					
Description Prompt :					
Instructions Prompt :					
Key					
Time Out :	Send to Operator				
* key :	Invalid Key				
# key :	Menu INTRO				
0 key :	Send to Operator				
1 key :	Menu SPAVP				
2 key :	Invalid Key				
3 key :	Voice Messaging 2000				
4 key :	Invalid Key				
5 key :	Invalid Key				
6 key :	Invalid Key				
7 key :	Invalid Key				
8 key :	Invalid Key				
9 key :	HangUp Line				
Select a menu and change its settings.					
Esc: back a menu		Return: selects		f1: moves bar BackSpace: edits	

to find out what product information the caller is after: Starplus AVP. This is done by Instructions to press the appropriate key.

Note that the # key takes the caller back to the menu specified in the Previous Menu field at the top of the screen.

- Key #3 is Voice Messaging followed by a mailbox number. If you look at the previous menu, Key #7 lists Voice Messaging alone. The difference is that the previous menu sends the caller to voice messaging and asks him to enter a mailbox number, while here the caller is defaulted to a specific mailbox.
- Key #9 allows the caller to disconnect.

Let's look at a menu on a deeper level off of this one which details the SPAVP product.

This menu is called SPAVP and it is accessed by pressing #1 from the Previous Menu, Product. This menu is concerned with giving the caller detailed product information on the Starplus AVP line.

```

MAINT en525100          v+3.10a
Configuration          Modules  Reports  Utilities  HouseKeeping

                                Edit Menu  SPAVP

Comment      : Detailed description of product.
Password     : 2275
Retries      : 4
Time Out     : 3
Introduction Prompt :
Description Prompt : SPAUP
Instructions Prompt : SPAUP

                                Key Actions:
Time Out : Send to Operator
* key : Play Instruction
# key : Menu PRODUCT
0 key : Send to Operator
1 key : Say SPAUP
2 key : Say SPAUP1
3 key : Say SPAUP2
4 key : Say SPAUP3
5 key : Say SPAUP4
6 key : Say SPAUP5
7 key : Say SPAUP6
8 key : Say SPAUP7
9 key : HangUp Line

Select a menu and change its settings.
Esc: back a menu  Return: selects  f4: moves bar  BackSpace: edits
    
```

There is no Introduction, but there is a long Description. The function of the Description is to provide a general overview of Starplus AVP. This recording lasts for about two minutes. The Instruction prompt tells the caller how to use the menu and, of course, it is played right after the Description. By recording the Description and the Instruction separately, it is possible to replay the instructions without subjecting the caller to the long presentation on Starplus AVP. That's exactly what is accomplished by press the \* key. The Say action on keys #1 through #8 provides more detailed product information. When Say is activated the associated voice file is played followed by the instructions. It is interesting to note that we could have defined these keys as other Menus and then used the Description prompt to play a message. However, since the instructions for each of those menus would have been the same as this one, we opted to use Say in order to streamline the menu design.

**330.3 SETTINGS**

Select Settings from the Menu Routing menu to display the following:

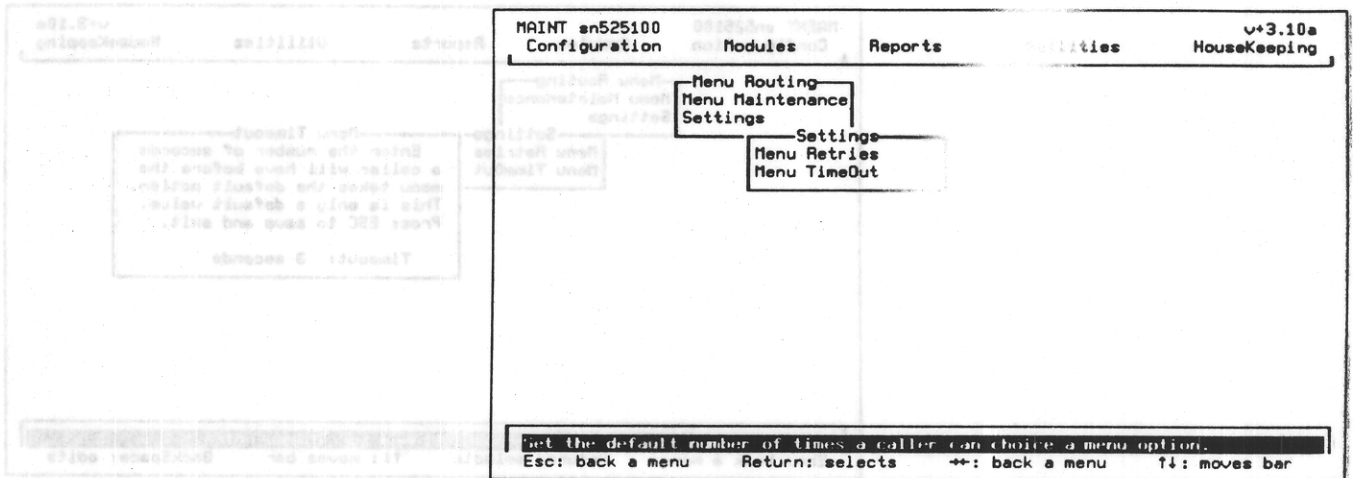

- **Menu Retries:** is the number of invalid entries allowed for all menus other than the first menu. If this number is reached the following prompt is displayed, "Please call the account supervisor for assistance and the call is disconnected."

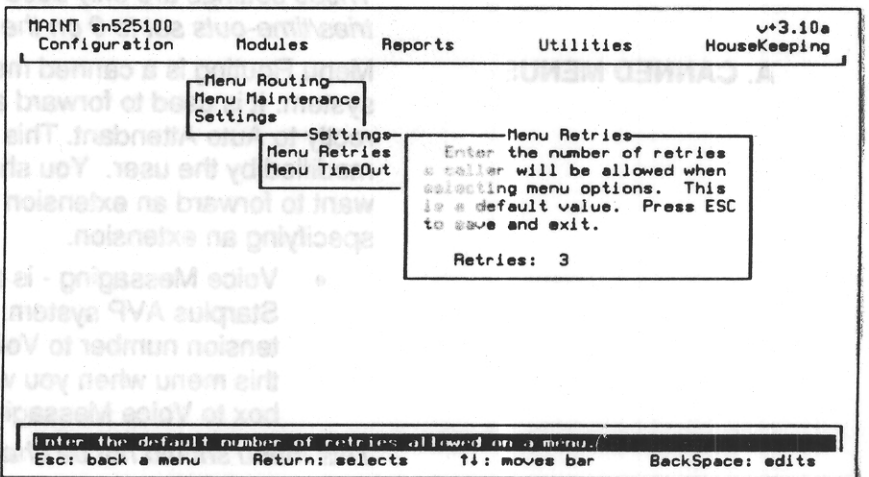

- **Menu Time-out:** is the maximum length of time the caller is allowed to do nothing on all menus other than the first menu. If this value is exceeded, the instructions in the Time-Out key action field are activated.

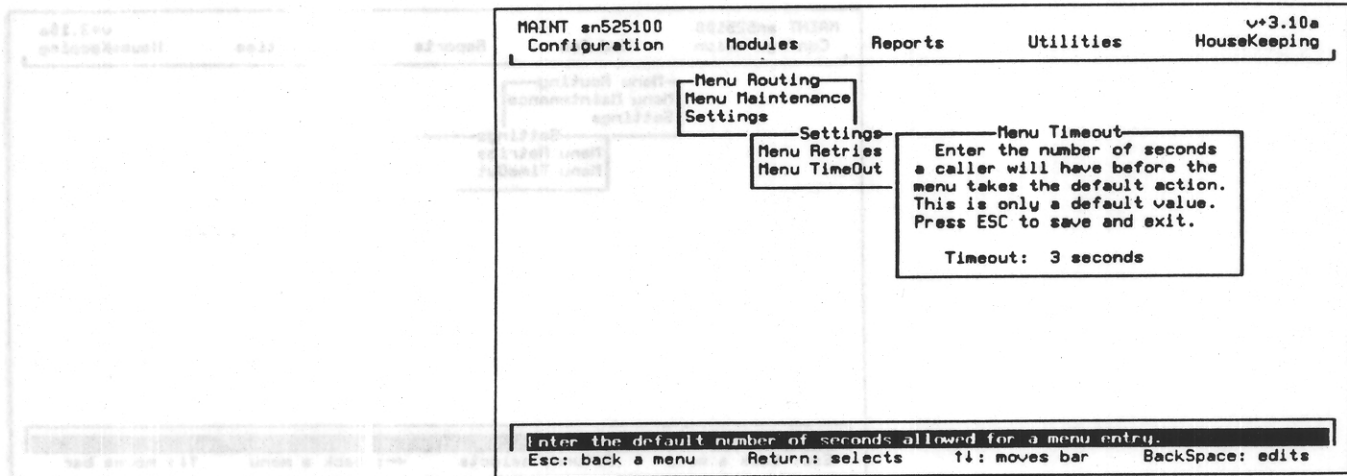

To set these values, type the desired value. To erase an existing value use the BackSpace key. Retry values can be set from 0 to 9 (recommended is 3). Time-out values can range from 0 to 99 seconds (recommended is 5 seconds). [ESC] exits and saves your entry.

*These settings are only used on menus that have their retries/time-outs set to 0 on the individual menu settings.*

### A. CANNED MENUS

Menu Routing is a canned menu provided with your Starplus AVP system. It is used to forward a mailbox or extension number directly to Auto Attendant. This menu should not be changed or modified by the user. You should only use this menu when you want to forward an extension or mailbox to Auto Attendant without specifying an extension.

- **Voice Messaging** - is a canned menu provided with your Starplus AVP system. It is used to forward a mailbox or extension number to Voice Messaging. You should only use this menu when you want to forward an extension or mailbox to Voice Messaging without specifying a mailbox.

*This menu should not be changed or modified by the user.*

- **Auto Attendant** - is a canned menu provided with your Starplus AVP system. It is used to forward a extension number to the Auto Attendant.

*This menu should not be changed or modified by the user.*

## SECTION 400

# SYSTEM CONFIGURATION

### 400.1 HARDWARE BASE UNITS

The hardware base units are the microcomputer (PC) items that run the Starplus AVP software. These units are incomplete by themselves. The base units are combined with voice boards and software to obtain a complete Starplus AVP system that can be connected to the phone system. The base units are high quality industrial grade components designed for years of trouble free service.

#### A. THREE HOUR UNIT

This hardware platform provides up to three(3) hours of voice storage. The components included are the six(6) slot enclosure with power supply, 286 CPU board with two(2) Megabytes RAM, SCSI controller card, monochrome video card, 40 Megabyte SCSI hard drive, a serial and parallel port, keyboard, and a monochrome monitor.

In the standard Starplus AVP software offerings this base unit is offered in either a two(2) or four(4) port version.

#### B. SEVEN HOUR UNIT

This hardware platform provides up to seven(7) hours of voice storage. The components included are the six(6) slot enclosure, 286 CPU board with two(2) Megabytes RAM, SCSI controller card, monochrome video card, 80 Megabyte SCSI hard drive, a serial and parallel port, keyboard, and a monochrome monitor.

In the standard Starplus AVP software offerings this base unit is offered in a four(4), six(6), or eight(8) port version.

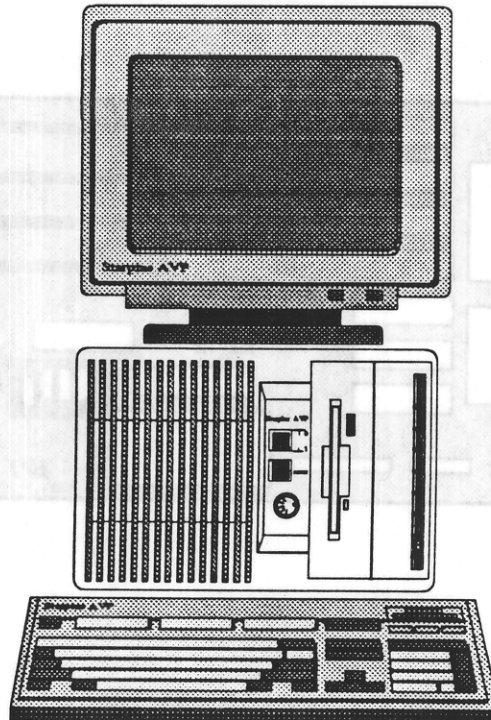

C. CUSTOM UNIT

In addition to the above base units, the Starplus AVP can be ordered to fit a custom port/storage capacity. Any port (line) configuration up to 24 and a storage capacity of up to 15 hours can be ordered. Other custom items are a 386 CPU, more RAM memory, and a color (VGA) screen.

400.2 VOICE BOARDS

The voice boards are the interface from the Starplus AVP to the phone system. These boards digitize human speech and recognize DTMF digits. Typically these boards are connected to SLT ports from a Starplus phone system. The phone system and the Starplus AVP communicate through DTMF (in-band) signaling. The voice boards are offered in two(2) configurations.

A. TWO PORT BOARD

This board provides two ports (lines) to interface to the phone system. The lines are connected to the board via two RJ14 modular plugs on the back of the board. The inner pair of conductors (GN-RD) on each connector provides access to the lines. *All jumper and switch settings on the board are set correctly when you receive a new system. Do not change any voice board settings on a new system.*

B. FOUR PORT BOARD

This board provides four ports (lines) to interface to the phone system. The lines are connected to the board via two RJ14 modular plugs on the back of the board. The upper modular plug contains ports one and two. On this plug, the inner pair of conductors GN-RD are port one and the outer pair of conductors BK-YL are port two. The lower modular plug contains ports three and four. On this plug, the inner pair of conductors GN-RD are port three and the outer pair of conductors BK-YL are port four.

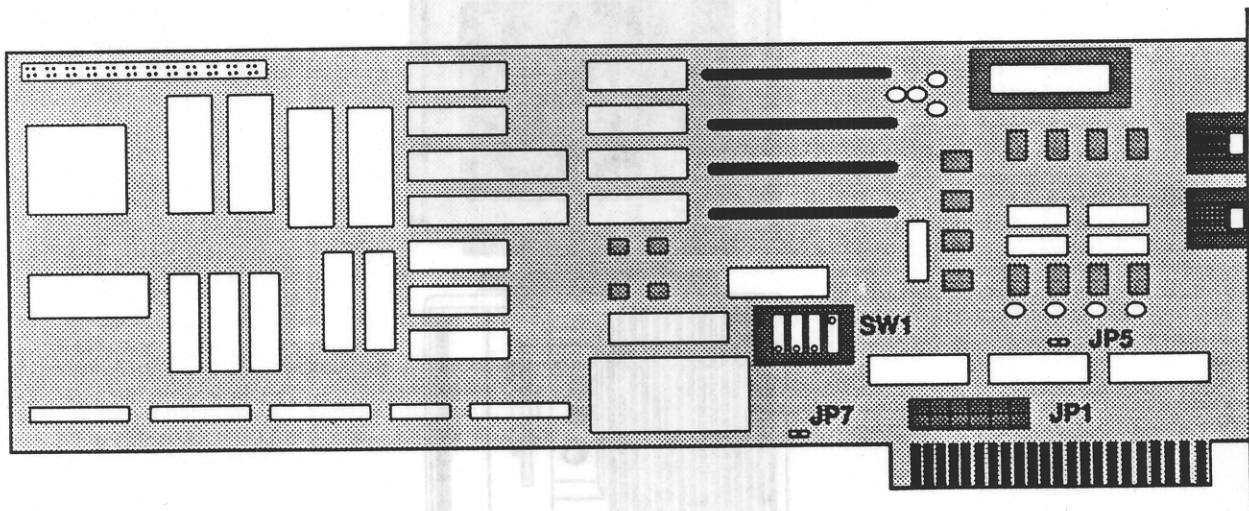



### 400.3 SOFTWARE PACKAGES

The software packages for the Starplus AVP contain the system disks and software key that make the system function. The software is preloaded onto the machine when the system is ordered. The software packages offered on the Starplus AVP are two port-three hour, four port-three hour, four port-seven hour, six port-seven hour, eight port-seven hour, or the custom package.

#### A. STANDARD PACKAGES

The standard software packages on the Starplus AVP are pre-defined port/hour configurations that can be ordered. These packages are: (The first number is the port size, the second the hour capacity.)

- 2 X 3
- 4 X 3
- 4 X 7
- 6 X 7
- 8 X 7

#### B. CUSTOM PACKAGES

The Starplus AVP software can be custom configured to a specific port/hour size upon request. The system can handle up to 24 ports and can be equipped for a maximum storage time of 15 hours. These capacities are available by ordering special hardware items in addition to the custom software. Some of these items include a 12 slot enclosure, 386 CPU, and a 200 Megabyte SCSI hard drive.

### 400.4 ENCLOSURES

The enclosure is the case that houses all PCB's, power supply and drives in the Starplus AVP system. Two versions of the enclosure are available.

#### A. SIX SLOT ENCLOSURE

This enclosure provides six consecutive slots for PCB's, a 135 watt power supply, and two half height (3.5") drive bays. This is the enclosure provided on the three and seven hour base units. Once the CPU, hard drive card, and video card are installed there are three expansion slots remaining. These slots can be used for voice boards to expand the port size.

#### B. TWELVE SLOT ENCLOSURE

This enclosure provides twelve consecutive slots for PCB's, a 200 watt power supply, and two half height (3.5") drive bays. This enclosure can be ordered for a custom system. Once the CPU, hard drive card, video card are installed there are nine expansion slots remaining. These slots can be used for voice boards to expand the port size.

In addition this enclosure can be ordered in a two six slot layout. In this version the mother board is divided into two enclosures which are separate from each other.

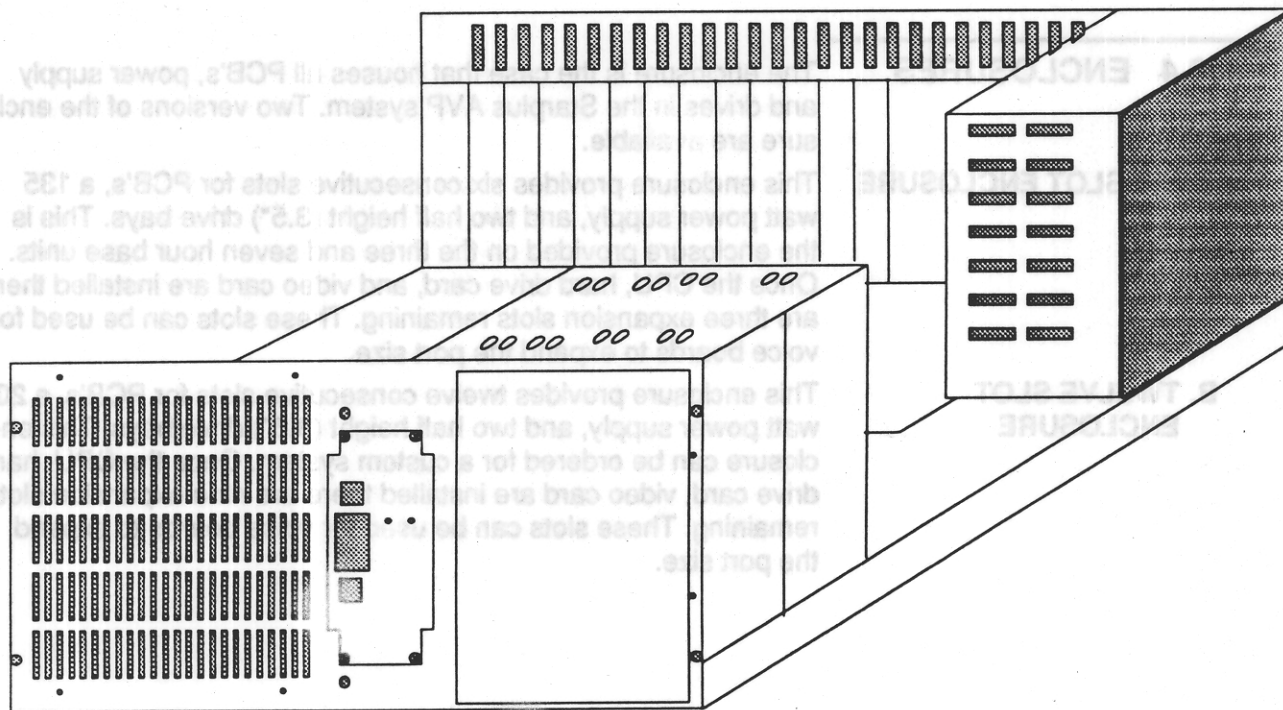
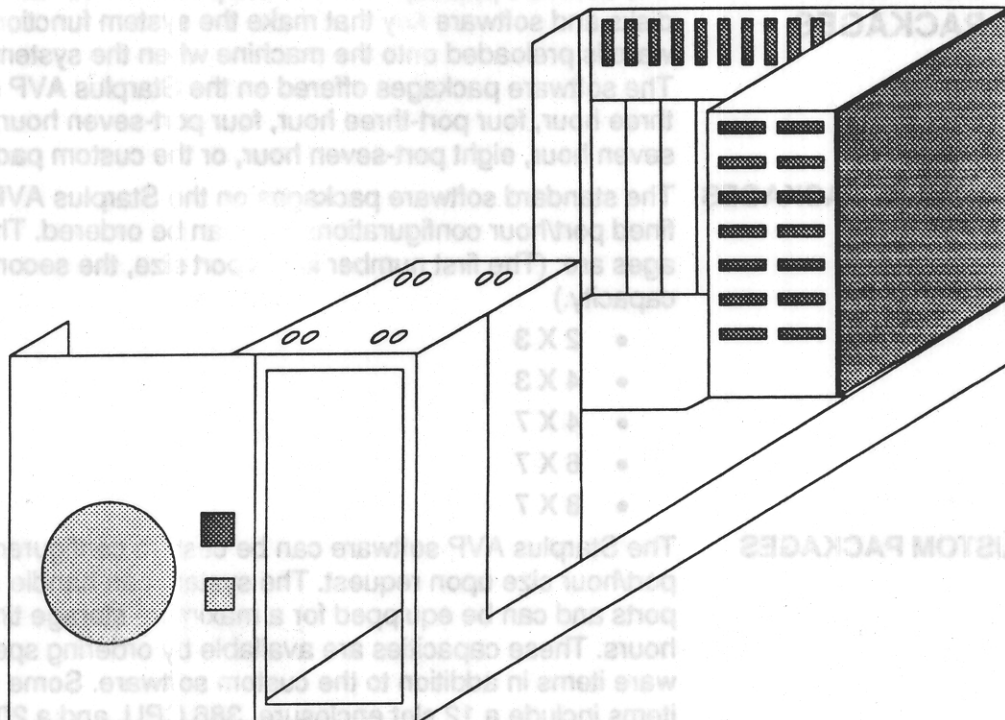

## 400.5 CPU BOARD

The CPU is the controller card of the system. This card controls all functions under command from the software. The card is offered in two versions, a 286 or 386 model. The 286 is included with all standard base units while the 386 is reserved for custom units.

### A. 286 BOARD

This board contains a 286 CPU chip running at 12 Megahertz clock speed. The board can be equipped for up to four megabytes of RAM. The board has a battery for the clock/calendar and is fully AT compatible. The board has 2 MB of RAM installed on it.

### B. 386 BOARD

This board contains a 386 CPU chip running at 25 Megahertz clock speed. The board can be equipped for up to sixteen megabytes of RAM. The board has a battery for the clock/calendar and is fully AT compatible.

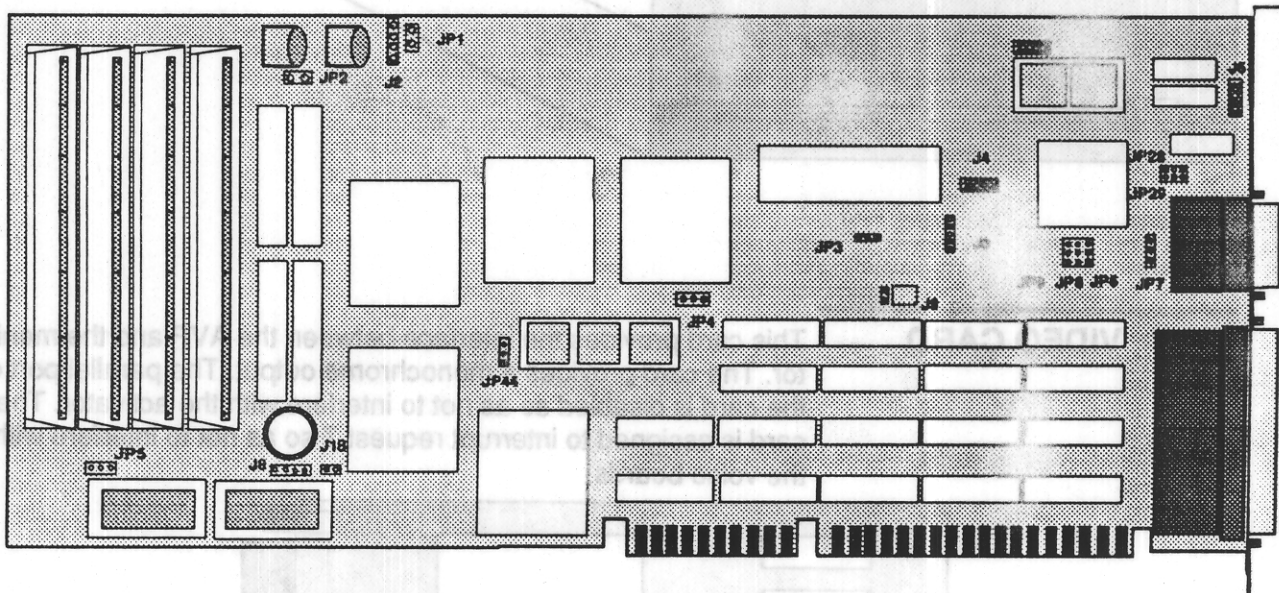

## 400.6 HARD DISK DRIVES

The hard drives provide the system with the storage capacity for voice messages. The drive also contains the system software on it. The drives are SCSI (small computer standard interface) type and are offered in three sizes. The sizes are 40, 80, or 200 Megabytes.

### A. FORTY (40) MEGABYTE DRIVE

The 40 megabyte drive will handle approximately three(3) hours of voice storage on the Starplus AVP system. This is the drive included with all three hour base units.

### B. EIGHTY (80) MEGABYTE DRIVE

The 80 megabyte drive will handle approximately seven(7) hours of voice storage on the Starplus AVP system. This is the drive included with all seven hour base units.

**C. TWO-HUNDRED (200) MEGABYTE DRIVE**

The 200 megabyte drive will handle approximately fifteen(15) hours of voice storage on the Starplus AVP system. This drive can be ordered in a custom system.

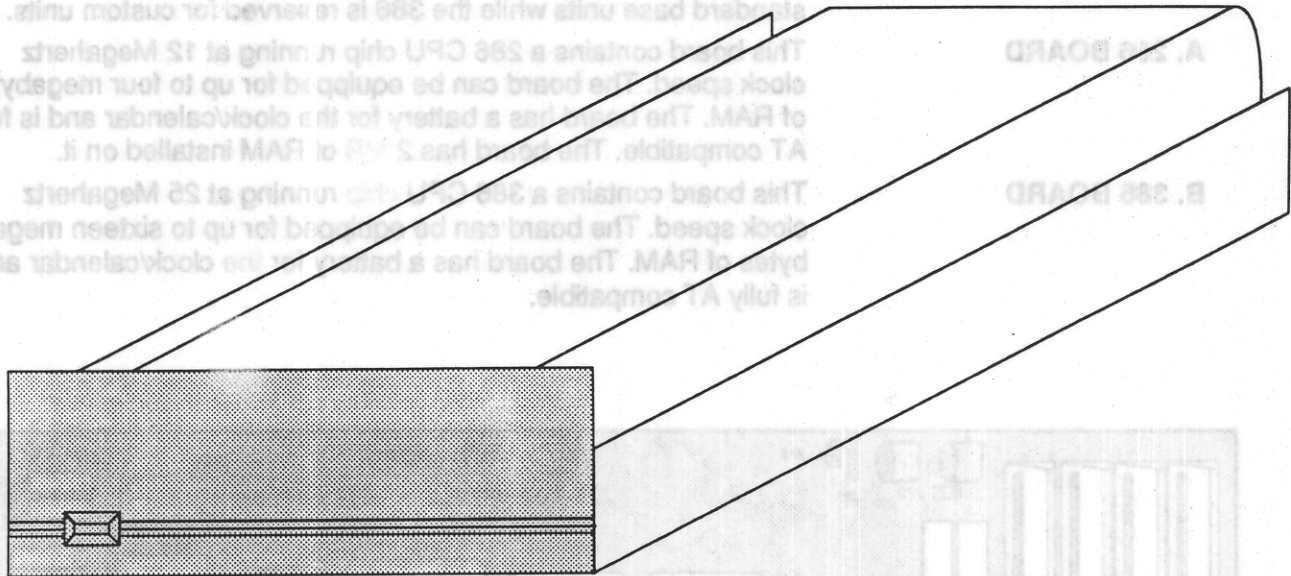

**400.7 VIDEO CARD**

This card provides the interface between the AVP and the monitor. The card provides a monochrome output. The parallel port on the card is disabled so as not to interfere with the activator. The card is assigned to interrupt request 7 so as not to interfere with the voice boards.

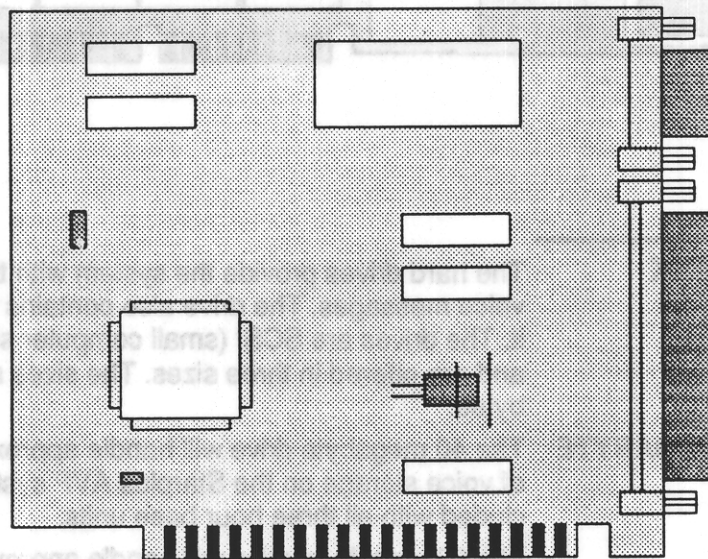

#### 400.8 SCSI (HARD DRIVE) CARD

This card is the interface between the disk drives and the AVP. The card controls both the floppy and hard drives on the system. There are two DIP switches on the card labeled SW1 and SW2. Set all switches on SW1 to the open position. On SW2, switch 1 should be in the closed position, switches 2-7 should be in the open position, switches 8 and 9 should be in the closed position, and switch 10 should be in the open position.

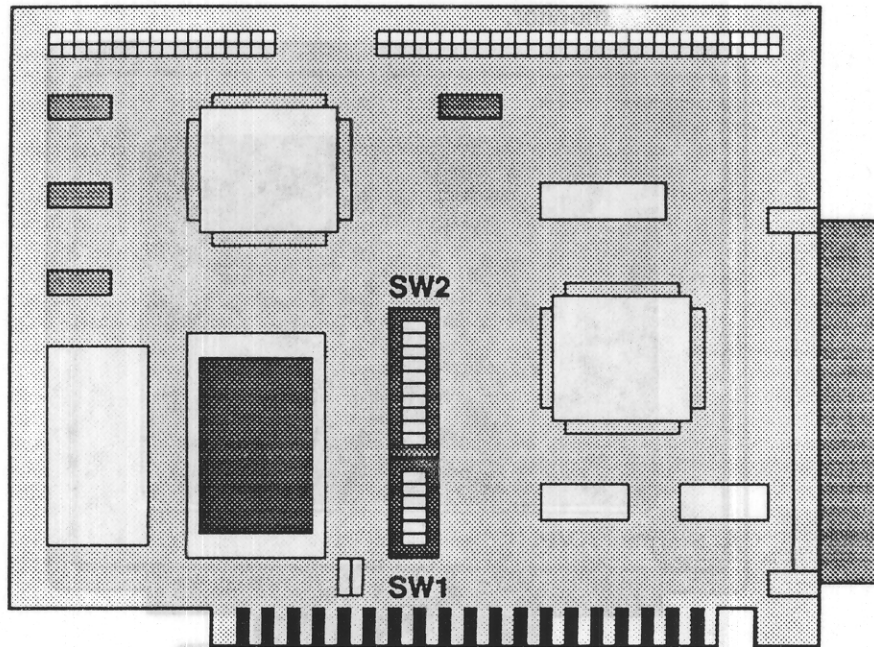

#### 400.9 KEYBOARD

The keyboard provided with the Starplus AVP is a 101 type keyboard. This keyboard plugs into the front of the enclosure. This must be plugged in at all times or the system will shut down.

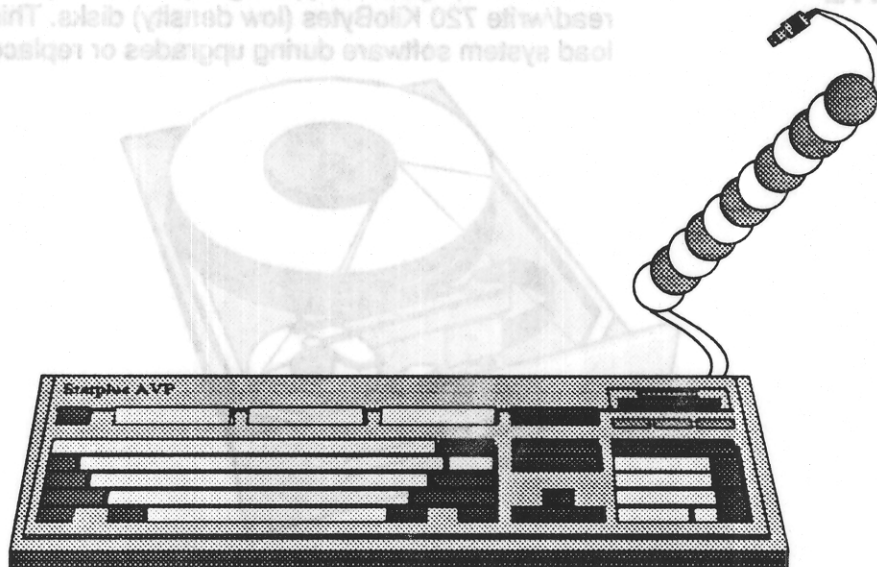

#### 400.10 MONITOR

The monitor provided with the Starplus AVP is a 14" monochrome (black/white) type. This monitor connects to the video card in the back of the enclosure via a 9 pin connector. This type of monitor requires the least amount of memory to run which provides the AVP with more system memory. It is recommended that monochrome always be used, however, the Starplus AVP does offer a color version as a custom option. This requires a new board and monitor.

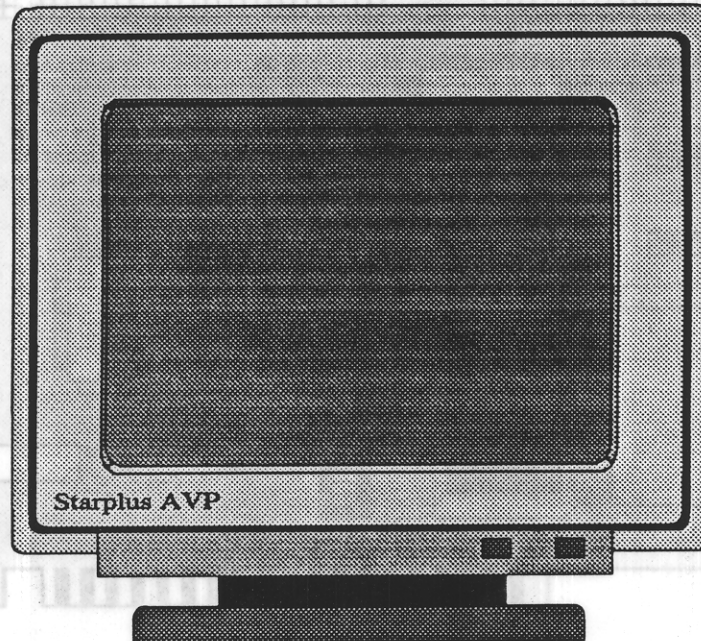

#### 400.11 FLOPPY DISK DRIVE

The floppy disk drive provided with the Starplus AVP is a 3.5" size with a 1.44 (high density) MegaByte capacity. This disk drive will read/write 720 KiloBytes (low density) disks. This disk is used to load system software during upgrades or replacements.



---

**400.12 PART NUMBERS**

• 3 Hour Base Unit	SP100-03
• 7 Hour Base Unit	SP100-07
• 2 Port Voice Board	SP130-02
• 4 Port Voice Board	SP130-04
• 2 x 3 S/W Kit	SP120-23
• 4 x 3 S/W Kit	SP120-43
• 4 x 7 S/W	SP120-47
• 6 x 7 S/W	SP120-67
• 8 x 7 S/W	SP120-87
• Custom S/W Kit	SP120-99
• 2 Port Upgrade	SP132-02
• 4 Port Upgrade	SP132-04
• 7 Hour Upgrade	SP132-07
• 15 Hour Upgrade	SP132-15
• Remote Programming Option	SP137-00
• Technical Manual	SP150-00
• System Administrator Guide	SP151-00
• User Guide	SP152-00
• Quick Reference Card	SP153-00

400.12 PART NUMBERS

- 3 Hour Base Unit SP100-03
- 7 Hour Base Unit SP100-07
- 2 Port Voice Board SP130-02
- 4 Port Voice Board SP130-04
- 2 x 3 SW Kit SP150-23
- 4 x 3 SW Kit SP150-43
- 4 x 7 SW SP150-47
- 6 x 7 SW SP150-67
- 8 x 7 SW SP150-87
- Custom SW Kit SP150-99
- 2 Port Upgrade SP135-02
- 4 Port Upgrade SP135-04
- 7 Hour Upgrade SP135-07
- 15 Hour Upgrade SP135-15
- Remote Programming Option SP137-00
- Technical Manual SP150-00
- System Administrator Guide SP151-00
- User Guide SP152-00
- Quick Reference Card SP153-00



## SECTION 410

# SPECIFICATIONS

### 410.1 ENCLOSURE

#### A. DIMENSIONS

- 7" height (7.25 with rubber feet)
- 10.5" width
- 16.88" depth

#### B. ENVIRONMENTAL

- 0 to 50°C, 10 to 90% humidity, non-condensing

#### C. MTBF:

- 35,000 hours

#### D. INPUT VOLTAGE

- 90-132 or 180-260 Vac, 47-63 Hz

#### E. OUTPUT VOLTAGE TOLERANCES

- +5 Vdc 4.75 to 5.25
- -5 Vdc -4.50 to -5.50
- +12 Vdc 11.40 to 12.60
- -12 Vdc 10.80 to 13.20

#### F. OUTPUT CURRENT RATINGS

- +5 Vdc 2.3 to 15 Amps
- -5 Vdc 0 to .5 Amps
- +12 Vdc .4 to 4.2 Amps
- -12 Vdc 0 to .5 Amps

#### G. COOLING

- One 21 cfm fan for card cage and one internal fan for power supply.

#### H. PERIPHERALS

- Two half height 5.25" mounting spaces (accessible from exterior of enclosure)

#### I. MATERIAL

- Chassis - .060 Aluminum Gold Alodine finish
- Cover - .040 Aluminum painted
- Front Panel - ABS plastic
- The paint meets federal standard 595.

#### J. REGULATORY

- The unit meets the FCC Part 15 requirements for a Class A computing device.

410.2 VOICE BOARDS

A. REGULATORY

- The board meets the FCC Part 15 requirements for a Class A computing device.
- FCC regulatory number : EB26FN-71693-MA-E Ringer Equivalence.3A
  - Dialogic D21/B
  - Dialogic D21/D
  - Dialogic D41/B
  - Dialogic D41/D

• 32,000 hours

• 90-135 or 180-260 Vac 47-63 Hz

- +5 Vdc 4.75 to 5.25
- -5 Vdc -4.50 to -5.50
- +12 Vdc 11.40 to 12.60
- -12 Vdc 10.80 to 13.20

- +5 Vdc 0.3 to 1.5 Amps
- -5 Vdc 0 to 0.5 Amps
- +12 Vdc 4 to 4.5 Amps
- -12 Vdc 0 to 0.5 Amps

• One 21 cfm fan for card cage and one internal fan for power supply.

• Two half height 5.25" mounting bays (accessible from exterior of enclosure)

- Chassis - 080 Aluminum Gold A loding finish
- Cover - 040 Aluminum painted
- Front Panel - ABS plastic
- The paint meets federal standard 265.

• The unit meets the FCC Part 15 requirements for a Class A computing device.



