

Important Safety Instructions

When using your telephone equipment, basic safety precautions should always be followed to reduce the risk of fire, electric shock and injury, including the following:

1. Read and understand all instructions.
2. Follow all warnings and instructions marked on the product.
3. Unplug this product from the wall outlet before cleaning. Do not use liquid or aerosol cleaners. Use a damp cloth for cleaning.
4. Do not use this product near water (for example, near a bath tub, kitchen sink or swimming pool).
5. Do not place this product on an unstable surface, such as a table, shelf or stand. The product may fall, causing serious damage.
6. Slots and openings in the back or bottom of the Base Unit and Handset are provided for ventilation. To protect them from overheating, these openings must not be blocked by placing the product on a soft surface such as a bed, sofa or rug. This product should never be placed near or over a radiator or heat register. This product should not be placed in any area where proper ventilation is not provided.
7. This product should be operated only from the type of power source indicated on the marking label. If you are not sure of the type of power supply in your home, consult your dealer or local power company.
8. Do not allow anything to rest on the power cord. Do not install this product where the cord may have anyone walking on it.
9. Never push objects of any kind into this product through slots in the Base or Handset as they may touch dangerous voltage points or short out parts that could result in a risk of fire or electric shock. Never spill liquid of any kind on the product.
10. To reduce the risk of electric shock, do not disassemble this product, but take it to an authorized service facility. Opening or removing parts of the Base or Handset other than specified access doors may expose you to dangerous voltages or other risks. Incorrect reassembling can cause electric shock when the product is subsequently used.
11. Do not overload wall outlets and extension cords as this can result in the risk of fire or electric shock.

Important Safety Instructions

12. Unplug this product from the wall outlet and refer servicing to an authorized service facility under the following conditions:
 - A. When the power supply cord or plug is damaged or frayed.
 - B. If liquid has been spilled onto the product.
 - C. If the product has been exposed to rain or water.
 - D. If the product does not operate normally by following the operating instructions. Adjust only those controls that are covered by the operating instructions, as improper adjustment of other controls may result in damage and often requires extensive work by an authorized technician to restore the product to normal operation.
 - E. If the product has been dropped and the Base and/or Handset has been damaged.
 - F. If the product exhibits a distinct change in performance.
13. Avoid using a telephone (other than cordless) during an electrical storm. There is a remote risk of electric shock from lightning.
14. Do not use the telephone to report a gas leak in the vicinity of the leak.
15. Only put the Handset of your telephone next to your ear when it is in normal talk mode.

Introduction

The **2621** is an advanced cordless telephone that operates in the 2.4GHz frequency range.

This manual is designed to familiarize you with your **2621** cordless telephone. We strongly recommend you read the manual before using your phone.

Parts Check List

1. Handset
2. Base Unit
3. AC Power Adapter
4. Telephone Line Cord
5. Belt Clip
6. Battery
7. Owner's Manual



Handset

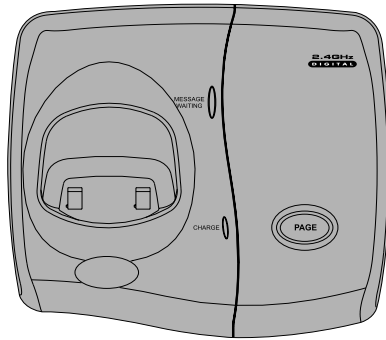

Base Unit

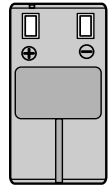

Battery

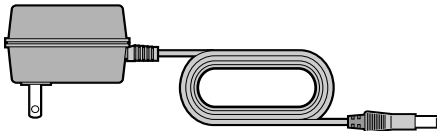

AC Power Adapter

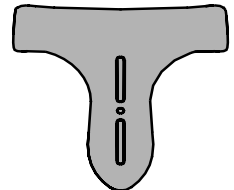

Belt Clip



Telephone Line Cord

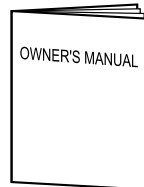

Owner's Manual

The Handset Layout

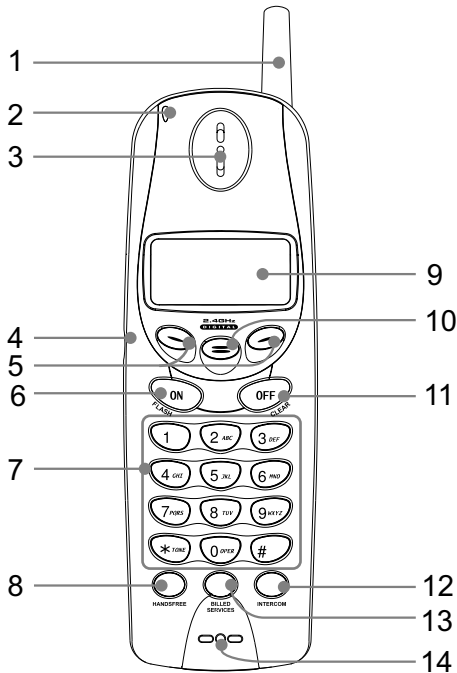

- | | |
|------------------------------|---------------------------|
| 1. Antenna | 8. Handsfree Speakerphone |
| 2. Message Waiting Indicator | 9. LCD Display |
| 3. Earpiece | 10. Select |
| 4. Headset Jack (2.5mm) | 11. Off/Clear |
| 5. Scroll Keys | 12. Intercom |
| 6. On/Flash | 13. Billed Services |
| 7. Dialing Key (0 - 9, *, #) | 14. Microphone |

The Base Unit Layout

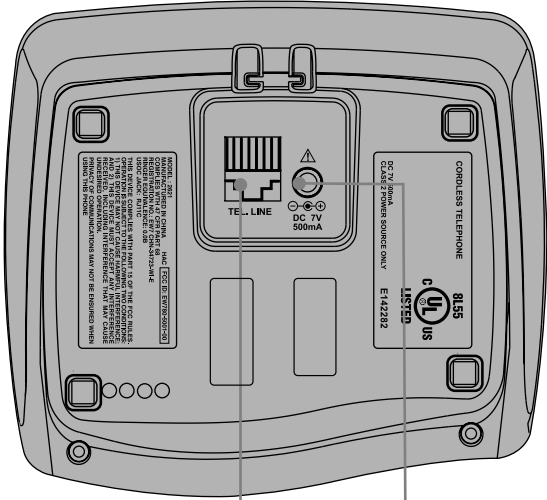

Phone Cord Jack AC Power Jack

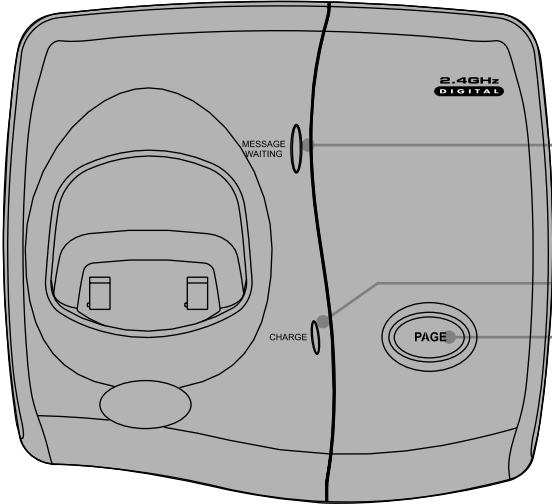

Message Waiting Indicator
 Charge Indicator
 Page Key

Setup

Plug the AC power adapter into an electrical outlet, and the DC connector into the bottom of the Base Unit.

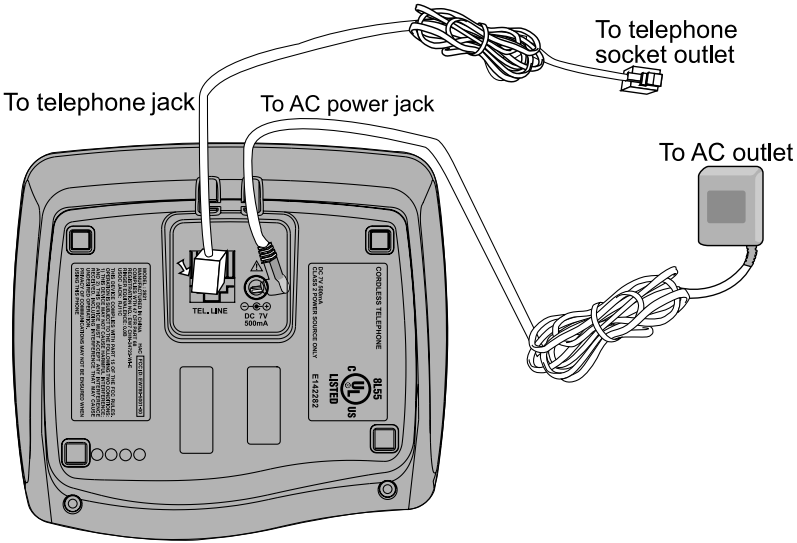

Battery Installation

1. Remove the battery compartment cover by pressing on the indent and sliding downward.
2. Place the new battery in the Handset with the metal contacts aligned with the charge contacts in the battery compartment.
3. Replace the battery compartment cover by sliding it upward.
4. If the new battery is not already charged, place the Handset in its Base and allow to charge a minimum for 12 hours (or overnight). After that, be sure to replace the Handset on its Base when not in use to ensure maximum daily battery performance.

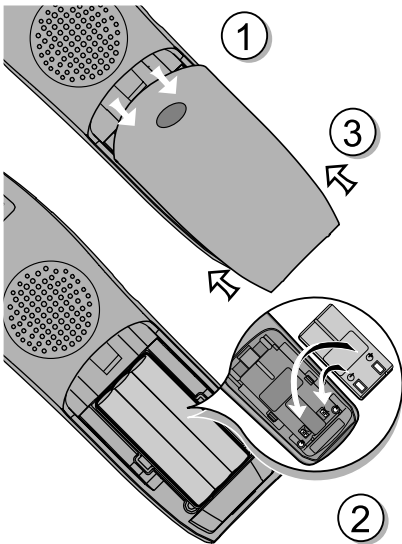

Setup

Charging Of Handset Battery

The Handset of your **2621** cordless telephone is powered by a rechargeable battery. It charges automatically whenever the Handset is in the Base Unit.

You should charge the battery for 12 hours when you first receive your phone. You'll know the battery needs charging when:

- The low battery message is displayed:
- The Handset seems completely dead, the LCD is completely clear and does not activate when you press the keys.

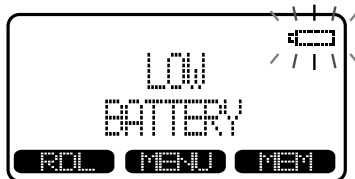

IMPORTANT:

1. Do not dispose of a battery in a fire, the cell may explode.
2. Do not open or mutilate the battery. Toxic substances may be released, causing harm to eyes or skin.
3. Exercise care in handling batteries in order to prevent an accidental short of the charge contacts, potentially causing the battery to overheat.
4. Do not dispose of this battery into household garbage. Please contact your local, state or municipal recycling organization for information on how to properly dispose of your rechargeable battery.
5. If the phone will not be used for a long time, remove the batteries to prevent possible leakage.

Setup

Connecting to Phone Line





Before connecting the phone line, make sure to properly charge the battery for at least 12 hours.

Plug one end of the telephone line cord into the jack on the bottom of the Base Unit. Plug the other end of this cord into the wall jack.

Checking For Dial Tone

After the battery is charged press **ON** on the Handset. The phone icon  will appear on the Handset display, and you will hear dial tone. If not, see **In Case of Difficulty**.

Tone/Pulse Selection

- With the Handset in the idle (**OFF**) mode, press **MENU**.
- Use  /  to Scroll to **TONE/PULSE**, then press **OK**.
- Use  /  to Scroll to **TONE** or **PULSE**; press **OK**.
- You'll hear a confirmation beep.

NOTE: Your **2621** is preset for **TONE** dialing.

Temporary Tone Dialing

If you have dial pulse (rotary) service, you can switch to touch tone dialing during a call by pressing ***TONE**. This can be useful if you need to send tone signals for access to answering systems or long distance services.



CAUTION: Use only the power supply provided with your **2621**.

IMPORTANT:

For best performance the **2621** should be installed as follows:



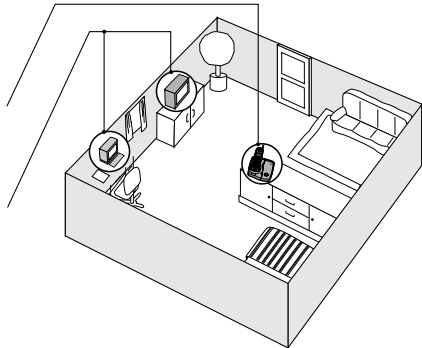

In an elevated location, in the center of the room, with no obstructions nearby.

In a location that is away from other electrical appliances such as microwave ovens, personal computers, or televisions.



Handset and Base Indicators

Handset Icons

Icon	Description
	<u>Extension In Use indicator</u> Appears in idle or phone on modes to indicate a parallel set in use. It replaces phone on icon during phone on mode and parallel set is detected.
	On steady when Handset is in use. Flashes when there is an incoming call.
	<u>Battery indicator</u> Cycles (Low, Medium, and High) when Handset battery is charging. Flashes when a low battery condition is detected.
M	<u>Mute indicator</u> On steady when the Handset microphone is muted.
H	<u>Hold indicator</u> On steady when the line is on hold.
E	<u>Range Extender indicator</u> On steady when the Range Extender is on.
	Flashes when Handset is being paged.
	On steady when Handset is searching for Base Unit.

Handset LEDS

LED	Description
Message Waiting	Flashes to indicate that you have new messages in your voicemail. Service must be subscribed to through your local telephone company.

Base LEDS

LED	Description
Message Waiting	Flashes to indicate that you have new messages in your voicemail. Service must be subscribed to through your local telephone company
Charging	Lights whenever the handset is placed in the base unit charging cradle.

Soft Menu Functions

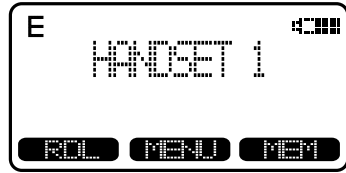

The 2621 has an advanced design that uses a menu structure and softkeys to access all of the built-in features.

Example of the idle mode display:



RDL (Redial)

Press **RDL** to display the last 5 telephone numbers dialed. The number on top line is the most recent number dialed.

- Use the  /  scroll keys to select the desired number.
- To dial the number, you can simply press the **ON** or **HANDSFREE** key.

To Save Redial to Memory:

Use the scroll keys to select the desired number. Then press **SELECT**. Press **SAVE**. Use the steps from 1 to 3 of **To Store a Number/Name**.



To Erase Redial:

Use the scroll keys to select the desired number. Then press **SELECT**. Press **ERASE**.

MENU

With the Handset in the idle (OFF) mode, press the **MENU** key to access the following options:

- **CALLS LOG (CALLER ID)**
- **HANDSET SETTINGS**
- **RANGE EXTENDER**
- **STONE/PULSE**
- **REGISTER** (Disregard this option, the Handset was registered to the Base at the factory.)

Use the  /  keys to select the desired option, then press **OK**.

Calls Log (Caller ID)

Caller ID - Call Waiting Caller ID



Your **2621** is capable of displaying the name and/or number of the party calling before you answer the phone (**Caller ID**). It is also capable of displaying Caller ID information in conjunction with a Call Waiting alert signal (**Call Waiting Caller ID**). With Call Waiting Caller ID, the Caller ID data is displayed so you can decide whether to answer the incoming call, or continue with your current conversation.

NOTE: For all unviewed CID records, an **N** will be displayed with the CID record.



ABOUT CALLER ID & CALL WAITING CALLER ID

These are subscription services, provided by most regional telephone service providers. You must subscribe to these services to get the benefits of these features. If you do not subscribe to Caller ID services, you can still use your **2621** and the other features it offers.

Due to regional incompatibilities, Caller ID information may not be available for every call you receive. In addition, the calling party may intentionally block their name and phone number from being sent.

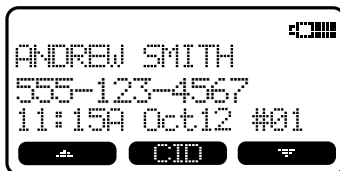
From the idle (OFF) mode, press **MENU**, use the  /  scroll keys to select **CALLS LOG**, then press **OK**. The Caller ID information of the most recently received call will be displayed. For example:



To scroll to other records, use the  /  scroll keys.

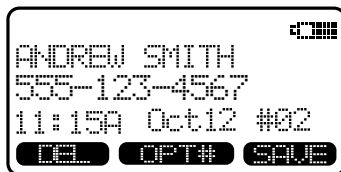

To dial the number displayed, simply press the **ON** or **HANDSFREE** key.



You can also press the **CID** key to access the following options (**DEL**, **OPT#**, **SAVE**):

DEL: Select this option to delete **THIS** or **ALL** records in Caller ID memory.

OPT#: Select this option to display up to four possible dialing options of the numbers stored in Caller ID memory. If a number is provided in the Caller ID data, the possible options to choose from will be either 7, 8, 10, or 11 digits. For example, if the original number in Caller ID memory was 555-123-4567, then the display options will be:

Use the  /  keys to make selection, and then press **DIAL**, **ON** or **HANDSFREE** to dial the number.

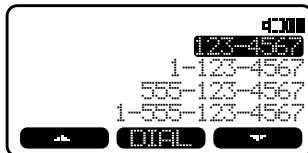



SAVE: Select this option to save the displayed Caller ID record into Phonebook Memory. Only Caller ID records with telephone numbers can be saved into Phonebook Memory. If you need to modify the number after saving, see **To Edit a Number/Name**.



Handset Settings

From the Handset Settings menu you can select the following options to modify:

- **RINGER VOLUME**

Select this option to adjust the ringer volume. Use the  /  scroll keys to adjust the volume up or down. The Handset will display a graphic indicator of the selected volume setting. Press **OK** to confirm your selection and return to the Handset Settings menu.

- **RINGER MELODY**

Select this option to adjust the ringer melody. Use the  /  scroll keys to select from the six available ringers. Press **SAVE** to confirm your selection and return to the Handset Settings menu.

- **LOW BATT TONE**

Select this option to turn the Low Battery warning tone ON or OFF. Press the **OFF** or **ON** softkeys, to make your selection. Press **OK** to confirm your selection and return to the Handset Settings menu. When set to **ON**, the Handset will emit a warning tone when a Low Battery condition is detected.



- **RANGE TONE**

Select this option to turn the Out of Range warning tone ON or OFF. Press the **OFF** or **ON** softkeys to make your selection. Press **OK** to confirm your selection and return to the Handset Settings menu. When set to **ON**, the Handset will emit a warning tone whenever the Handset is taken out of range of the Base.



- **KEYPAD TONE**

Select this option to turn the Keypad tones ON or OFF. Press the **OFF** or **ON** softkeys to make your selection. Press **OK** to confirm your selection and return to the Handset Settings menu. When set to ON, the Handset will emit a beep whenever a key is pressed.

- **CONTRAST**

Select this option to adjust the contrast level of the Handset display. Use the  /  scroll keys to make your selection. The Handset display will automatically adjust as you make your selection. Press **OK** to confirm your selection and return to the Handset Settings menu.

- **LANGUAGE**

Select this option to change the display to appear in English, Spanish or French. Use the  /  scroll keys to select language, then press **OK** to confirm your choice.

Range Extender

Your **2621** has an enhanced feature designed to improve its performance. This feature is useful if you are using your **2621** in an area with excessive interference or you require a moderate increase in operating range. The Range Extender feature can help to improve both the sound quality and range. Actual range will depend on your environment.

Range Extender Feature

- In the idle (**OFF**) mode, press **MENU** and use the scroll keys to select **RANGE EXTENDER**, then press **OK**.
- There are three option settings in the RANGE EXTENDER menu:
 - Select **OFF** to disable RANGE EXTENDER.
 - Select **ON** to enable RANGE EXTENDER. An **E** icon will appear in the upper left corner of Handset display, indicating that RANGE EXTENDER is **ON**.
 - Select **AUTO** to allow your **2621** to automatically monitor the signal strength between the Handset and Base Unit, and activate whenever necessary. With this option selected, your **2621** may occasionally enable or disable the RANGE EXTENDER feature.
- Use the scroll keys to select the desired setting, and then press **OK** to confirm the selection.

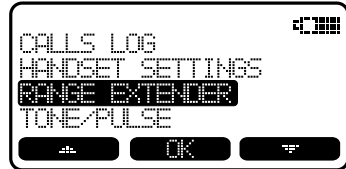

NOTE: When Range Extender mode is enabled, your **2621** will consume more battery power. That means the standby and talk time of your Handset will be shorter.

MEM (Memory)

The **2621** can store up to 50 numbers with names in memory. Each memory location can hold up to 32 digits for the number and 16 characters for the name.

When prompted to **ENTER NAME**, use the number keys to spell the name. Each press of a particular key causes characters to be displayed in the following order:

Number Key	Characters (in order)
1	& ' , . 1
2	A B C a b c 2
3	D E F d e f 3
4	G H I g h i 4
5	J K L j k l 5
6	M N O m n o 6
7	P Q R S p q r s 7
8	T U V t u v 8
9	W X Y Z w x y z 9
0	0
*	*
#	#

MEM (Memory)

To Store a Number/Name:

- Starting from the idle screen, enter the number you want to store in memory.
- Be sure to include long distance codes and pauses (using the **Pause** softkey) if necessary. Press **OFF** to correct if you make mistake. Press the **MEM** softkey.

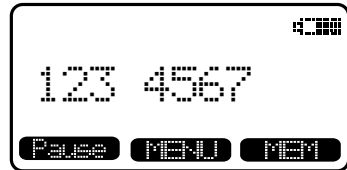
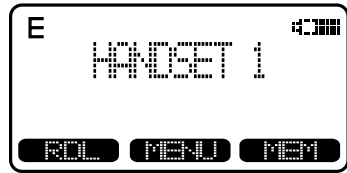

NOTE: If the memory is full the Handset will display **PHONEBOOK IS FULL** and exit to the pre-dial mode without saving the entry.

- You will then be prompted to **ENTER NAME**. Use the digit keys to spell the name. If you make a mistake, press the **CLR** softkey. To enter a space press **[Space]**. When finished, press **SAVE**.



MEM (Memory)

To Search For and Dial a Number/Name:

- Starting from the idle screen, press the **MEM** softkey to review memory contents.
- Using the  /  softkeys scroll through the memory contents in alphabetical order.

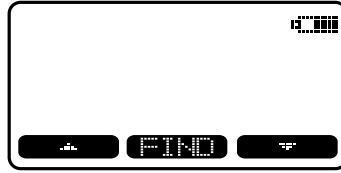

Or, you can press the **FIND** softkey, enter the first few characters of the name. If you make a mistake, press the **CLR** softkey. Press **FIND** to search. The closest match, alphabetically, will be displayed.

- Once you find the entry you want, simply press **ON** or **HANDSFREE** to dial the number.

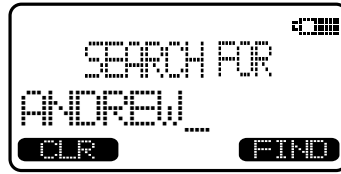

To Delete a Number/Name:

- Using steps 1 and 2 in **To Search For and Dial a Number/Name**, locate the entry you want to delete.
- Press the **EDIT** softkey. The Handset will display:



MEM (Memory)

- Press the **DEL** softkey. The Handset will display:
- To delete the displayed records, press **THIS**. To delete all records, press **ALL**.
- If you press **ALL**, The screen will display: **ARE YOU SURE?**
- To confirm the deletion of all records, press **YES**. To exit without deleting press **NO**.

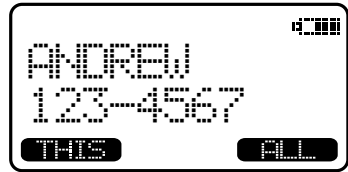

To Edit a Name or a Number

- Using steps 1 and 2 in **To Search For and Dial a Number/Name**, locate the entry you want to edit.
- Press the **EDIT** softkey twice. Then choose **NAME** or **NUM**.
- Using the **←** softkey move the cursor to the character you want to edit and then enter the corrections as needed. Press **MORE** to access **DEL**, **BACK** and **PAUSE** (when editing a name, this option will be **SPACE**) functions. When finished press the **SAVE** softkey. To exit without saving press **OFF**.
- When finished the Handset will display the edited entry.

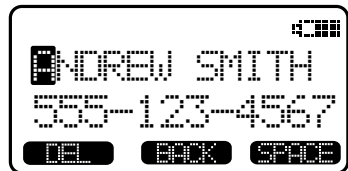

Handset and Base Operation

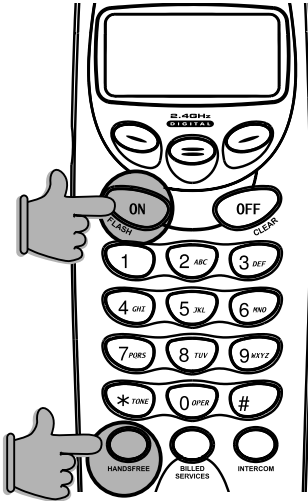

Making Calls

- Press **ON** (or, **HANDSFREE** to use the Handset Speakerphone feature). Dial the phone number.
-OR-
- Dial the phone number first; then press **ON** (or **HANDSFREE**). If you make a mistake while dialing, press **CLEAR(OFF)** to backspace and make corrections, then redial correctly.
- Press **OFF** to end your call.
-OR-
Place the Handset back in its Base.

Answering Calls

- Press any key except **OFF** or the softkeys.
- Press **OFF** to end your call.
-OR-
Place the Handset back in its Base.

Hold Function

- Press the **HOLD** softkey to place a call on hold. To return to the call press the **ON** or **HANDSFREE** key.



Flash Function

- You can use your **2621** with services such as Call Waiting. Simply press the **ON/FLASH** key on the Handset. Please read Call Waiting Deluxe on page 21 for details.

Mute Function

- During an active call, pressing the **MUTE** softkey on the Handset will disable the microphone. Press **MUTE** again to return to two-way conversation.

Volume Control

- During an active call, press the **VOL** softkey, then use the  and  softkeys to adjust the earpiece or Handsfree Speakerphone volume. Press **OK** to confirm your choice.

Handset and Base Operation

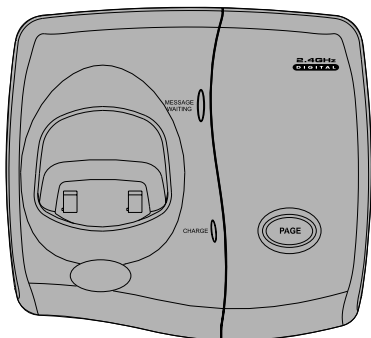

Page Feature



- To page the Handset from the Base press the **PAGE** key. The Handset will ring for approximately 20 seconds.
The Handset will display **PAGE FROMBASE**.
- To end the page, press **PAGE** on the Base or any key on the Handset except for **OFF** or the three softkeys.

Handsfree Speakerphone Operation

Your **2621** Handset has a built-in handsfree speakerphone. This feature allows you to stand the Handset upright on a table or desktop and have handsfree conversations. For more information, refer to **MAKING CALLS** in the **HANDSET AND BASE OPERATION** section.

Extension in Use Indication

When the telephone line is currently being used by a parallel set (a telephone or other device other than the **2621** on the same line); the phone icon will remain on steadily, and **EXTENSION IN USE** will be displayed.



Low Battery Indication

When a low battery is detected, the battery icon will flash and a warning beep will sound. The status message **LOW BATTERY** will be displayed when the Handset is in idle mode. To prevent an unexpected call drop, a drained Handset battery should be replaced by a fully charged spare battery.

Handset and Base Operation

Message Waiting Indication

The **2621** is compatible with optional voicemail service provided by some local telephone companies. If you subscribe to this service and you have new, unplayed messages in your voicemail, a Visual Message Waiting Indicator (VMWI) signal is transmitted by your local telephone company.

The **2621** will detect a VMWI signal and activate the Message Waiting lights on the Handset and Base.

After you check your messages, the Message Waiting indicator will automatically turn off.

Please note that whenever new, unplayed messages are stored in your voicemail, the local Telephone Company will continue to send a VMWI signal.

Call Waiting Deluxe

Your **2621** is compatible with Call Waiting Deluxe. In order to use this feature you must subscribe to this service through your local telephone company.

Your **2621** will automatically enter into Call Waiting Deluxe mode if you receive a call waiting signal. Upon receiving a call waiting signal, the caller ID information will be displayed.

Call Waiting Deluxe mode will be indicated on the Handset for 15 seconds at which time you can disposition the call using the following options:



Function	Press:
End the 1st call and answer the 2nd call	5
Place the 1st call on hold and answer the waiting call	FLASH
Add the waiting call to your first call	3
Send a hold message to your waiting call	6
Forward the waiting call to your Voicemail *	9



- Voicemail service, provided by your local telephone company, is required.

If you do not wish to disposition a call, simply press **EXIT**.

Custom Pay-Per-Use(PPU) Features

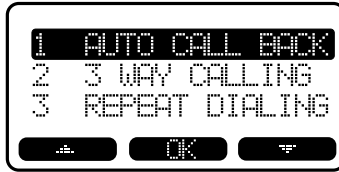
Press **BILLED SERVICES**.
Screen displays:







Use  /  to scroll to the desired option, then press OK to select.
- OR -

Please use the corresponding number from the keypad to select the desired function. For example, pressing 3 will select **REPEAT DIALING**.

AUTO CALL BACK dials the last party who called you, whether or not you answered the call. A charge is added to your phone bill each time you use this feature.

3-WAY CALLING allows you to talk with 2 separate parties from a single line. To use this feature, follow these steps:

- 1) Call your first party, after the party answers,
- 2) Press **BILLED SERVICES**, then use the  /  keys to scroll to **3 WAY CALLING**. Press OK to confirm. Wait for dial tone.
- 3) Call your second party, after the call is answered,
- 4) Press **BILLED SERVICES**, then use the  /  keys to scroll to **3 WAY CALLING** again.

A charge is added to your phone bill each time this service is used.

REPEAT DIALING repeatedly dials the last number you called, over a time interval determined by your local phone company. This is useful in reaching a party whose line is busy. A charge is added to your phone bill each time this service is used.

NOTE: It is likely that your local telephone company will assess charges to use custom features. You should check with your local service provider regarding which custom services are available in your area, and the associated costs for the intentional or unintentional use of Pay Per Use services.

Your local telephone company may provide a monthly subscription to an individual service or a package of services which gives you unlimited usage for a small monthly fee.

Headset Operation

Your **2621** Handset is equipped with a 2.5mm Headset Jack for use with an optional accessory Headset for handsfree operation. If you choose to use the Headset option, you must obtain an optional accessory Headset, which is compatible with the **2621**. To purchase a Headset, call the Supplier.

Once you have a compatible 2.5mm Headset, locate the Headset Jack on the **2621** Handset. Connect the plug on the Headset cord to the jack (under a small rubber flap) on the cordless Handset. The plug should fit securely. Do not force the connection.

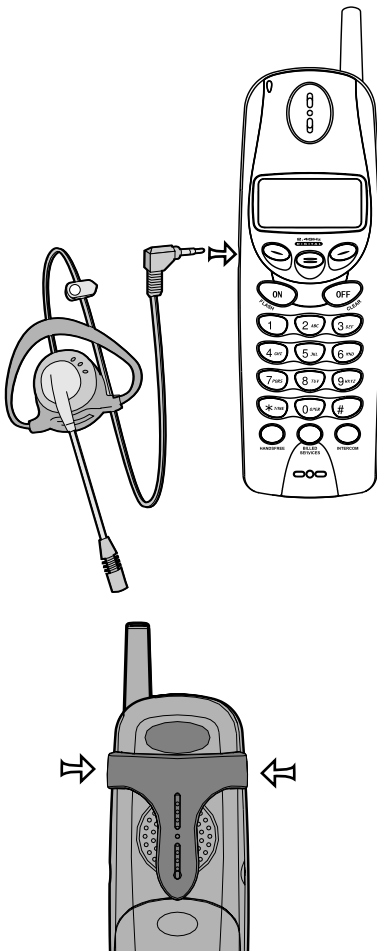

NOTE:

Whenever a compatible Headset is connected to the cordless Handset, the microphone on the Handset will be muted. This is done to limit the effect of background noise.

Belt Clip

The **2621** is also equipped with a detachable belt clip. Align the pins on the inside edge of the clip with the notches on the sides of the Handset. The belt clip should snap securely into place. Do not force the connection.

Maintenance

Taking care of your telephone

Your cordless telephone contains sophisticated electronic parts, so it must be treated with care.

Avoid rough treatment

Place the Handset down gently. Save the original packing materials to protect your telephone if you ever need to ship it.

Avoid water

Your telephone can be damaged if it gets wet. Do not use the Handset outdoors in the rain, or handle it with wet hands. Do not install your Base Unit near a sink, bathtub or shower.

Electrical storms

Electrical storms can sometimes cause power surges harmful to electronic equipment.

For your own safety, use caution when using electric appliances during storms.

Cleaning your telephone

Your telephone has a durable plastic casing that should retain its luster for many years. Clean it only with a soft cloth slightly dampened with water or a mild soap. Do not use excess water or cleaning solvents of any kind.

Remember that electrical appliances can cause serious injury if used when you are wet or standing in water. If your Base Unit should fall into water, **DO NOT RETRIEVE IT UNTIL YOU UNPLUG THE POWER CORD AND TELEPHONE LINE CORDS FROM THE WALL.** Then pull the unit out by the unplugged cords.

In Case Of Difficulty

If you have difficulty operating your phone, the suggestions below should solve the problem. If you still have difficulty after trying these suggestions, call the Supplier.

The phone doesn't work at all

- Make sure the Power Cord is plugged in.
- Make sure the telephone line cord is plugged firmly into the Base Unit and the telephone wall jack.
- Make sure the battery is properly charged. If you get a **LOW BATTERY** message or indication, the battery needs charging.

No dial tone

- First try all the suggestions above.
- If you still don't hear a dial tone, disconnect the Base Unit from the telephone jack and connect a different phone. If there is no dial tone on that phone either, the problem is in your wiring or local service. Contact your local telephone company.

You get noise, static, or a weak signal even when you're near the Base Unit

- Household appliances plugged into the same circuit as the Base Unit can sometimes cause interference. Try moving the appliance or the Base Unit to another outlet.

You get noise, static, or a weak signal when you're away from the Base Unit

- You may be out of range. Either move closer to the Base, or relocate the Base Unit.
- The layout of your home may be limiting the range. Try moving the Base Unit to another position.

The Handset does not ring when you receive a call

- Make sure you have the ringer activated. Refer to the section(s) on **ringer selection** in this User's Manual.
- Make sure the telephone line cord is plugged firmly into the Base Unit and the telephone jack. Make sure the power cord is plugged in.
- You may be too far from the Base Unit.
- You may have too many extension phones on your telephone line to allow all of them to ring. Try unplugging some of the other phones.

You hear other calls while using your phone

- Disconnect your Base Unit from the telephone jack, and plug in a regular telephone. If you still hear other calls, the problem is probably in your wiring or local service. Call your local telephone company.

You hear noise in the Handset, and none of the keys or buttons work

- Make sure the power cord is plugged in.

In Case Of Difficulty

Common cure for electronic equipment

If the unit does not seem to be responding normally, then try putting the Handset in its Base. If it does not seem to respond, do the following (in the order listed):

1. Disconnect the power to the Base.
2. Disconnect the Handset battery, and spare battery, if applicable.
3. Wait a few minutes.
4. Connect power to the Base.
5. Re-install the battery(ies).
6. Wait for the Handset to reestablish its link with the Base. To be safe, allow up to one minute for this to take place.

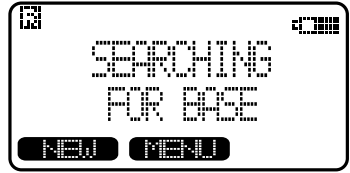

Warranty Statement

The Supplier warrants, to the original purchaser only, the material and workmanship of this product for ONE YEAR from the date of purchase. We will repair or replace, at our option, this product without charge should it fail due to a defect in material or workmanship within that time period.

This warranty does not apply to loss or damage that is the result of accident, misuse or negligence. All other warranties, expressed, implied or statutory, including warranties of fitness for a particular purpose, are limited to the time period listed and are otherwise excluded from this warranty if unauthorized repairs are attempted. Additionally, the Supplier shall not be liable for any incidental or consequential damage or commercial loss, nor for any other loss or damages.

The Supplier assumes no responsibility for products sent without prior return authorization.

FCC and ACTA Regulations

This equipment complies with Parts 15 of the Federal Communications Commission (FCC) rules for the United States. It also complies with regulations RSS210 and CS-03 of Industry and Science Canada. Operation is subject to the following two conditions: (1) this device may not cause interference, and (2) this device must accept any interference, including interference that may cause undesired operation of the device.

A label is located on the underside of the Base Unit containing either the FCC registration number and Ringer Equivalence Number (REN) or the IC registration number and Load Number. You must, upon request, provide this information to your local telephone company.

This equipment is compatible with inductively coupled hearing aids.

Should you experience trouble with this telephone equipment, please contact the Supplier for repair/warranty information. The telephone company may ask you to disconnect this equipment from the line network until the problem has been corrected.

FCC Part 15

Warning: Changes or modifications to this unit not expressly approved by the party responsible for compliance could void the user's authority to operate the equipment. The equipment has been tested and found to comply with part 15 of the FCC rules. These limits are designed to provide reasonable protection against harmful interference in a residential installation. This equipment generates, uses and can radiate radio frequency energy and, if not installed and used in accordance with the instructions, may cause harmful interference to radio communications. However, there is no guarantee that interference will not occur in a particular installation. If this equipment does cause harmful interference to radio or television reception, which can be determined by turning the equipment off and on, the user is encouraged to try and correct the interference by one or more of the following measures:

- Reorient or relocate the receiving antenna.
- Increase the separation between the equipment and receiver.
- Connect the equipment into an outlet or on a circuit different from that to which the receiver is connected.
- Consult the dealer or an experienced radio/TV technician for help.

FCC and ACTA Information

If this equipment was approved for connection to the telephone network prior to July 23, 2001, it complies with Part 68 of the Federal Communications Commission (FCC) rules. If the equipment was approved after that date, it complies with the Part 68 rules and with Technical Requirements for

FCC and ACTA Regulations

Connection of Equipment to the Telephone Network adopted by the Administrative Council for Terminal Attachments (ACTA). We are required to provide you with the following information.

1. Product identifier and REN information

The label on the back or bottom of this equipment contains, among other things, an identifier indicating product approval and the Ringer Equivalence Number (REN). This information must be provided to your local telephone company upon request. For equipment approved prior to July 23, 2001, the product identifier is preceded by the phrase "FCC Reg No." and the REN is listed separately. For equipment approved after that date, the product identifier is preceded by "US" and a colon (:), and the REN is encoded in the product identifier without a decimal point as the sixth and seventh characters following the colon. For example, the product identifier US:AAAEQ03T123XYZ would indicate an REN of 0.3.

The REN is used to determine how many devices you may connect to your telephone line and still have them ring when you are called. In most, but not all areas, the sum of all RENs should be five (5.0) or less. For more information, please contact your local telephone company.

2. Connection and use with the nationwide telephone network

The plug and jack used to connect this equipment to the premises wiring and the telephone network must comply with the applicable Part 68 rules and technical requirements adopted by ACTA. A compliant telephone cord and modular plug is provided with this product. It is designed to be connected to a compatible modular jack that is also compliant. An RJ11 jack should normally be used for connecting to a single line and an RJ14 jack for two lines. See Installation Instructions in this user's manual. This equipment may not be used with Coin Telephone Lines or with Party Lines. If you have specially wired alarm dialing equipment connected to your telephone line, ensure the connection of this equipment does not disable your alarm equipment. If you have questions about what will disable alarm equipment, consult your telephone company or a qualified installer.

3. Repair instructions

If this equipment is malfunctioning, it must be unplugged from the modular jack until the problem has been corrected. Repairs to this telephone equipment can only be made by the manufacturer or its authorized agents. For repair procedures, follow the instructions outlined under the Limited Warranty.

4. Rights of the telephone company

If this equipment is causing harm to the telephone network, the telephone company may temporarily discontinue your telephone service. The telephone company is required to notify you before interrupting service. If advance notice

FCC and ACTA Regulations

is not practical, you will be notified as soon as possible. You will be given the opportunity to correct the problem and the telephone company is required to inform you of your right to file a complaint with the FCC. Your telephone company may make changes in its facilities, equipment, operation, or procedures that could affect the proper functioning of this product. The telephone company is required to notify you if such changes are planned.

5. Hearing aid compatibility

If this product is equipped with a corded or cordless Handset, it is hearing aid compatible.

6. Programming/testing of emergency numbers

If this product has memory dialing locations, you may choose to store police, fire department and emergency medical service telephone numbers in these locations. If you do, please keep three things in mind:

- a. We recommend that you also write the telephone number on the directory card, so that you can still dial the emergency number manually if the memory dialing feature doesn't work.
- b. This feature is provided only as a convenience, and the manufacturer assumes no responsibility for customer reliance upon the memory feature.
- c. Testing the emergency telephone numbers you have stored is not recommended.

However, if you do make a call to an emergency number:

- You must remain on the line and briefly explain the reason for the call before hanging up.
- Programming/testing of emergency numbers should be performed during off-peak hours, such as in the early morning or late evening, when the emergency services tend to be less busy.

IC (Industry Canada)

This telephone is registered for use in Canada.

The term "IC:" before the radio certification number only signifies that Industry Canada technical specifications were met.

Notice: This equipment meets the applicable Industry Canada Terminal Equipment Technical Specifications. This is confirmed by the registration number. The abbreviation, IC, before the registration number signifies that registration was performed based on a Declaration of Conformity indicating that Industry Canada technical specifications were met. It does not imply that Industry Canada approved the equipment.

Notice: The Ringer Equivalence Number (REN) for this terminal equipment is 0.1. The REN assigned to each terminal equipment provides an indication

FCC and ACTA Regulations

of the maximum number of terminals allowed to be connected to a telephone interface. The termination on an interface may consist of any combination of devices subject only to the requirement that the sum of the Ringer Equivalence Numbers of all the devices does not exceed five.

Before installing this equipment, users should ensure that it is permissible to be connected to the facilities of the local telecommunications company. The equipment must also be installed using an acceptable method of connection. The customer should be aware that compliance with the above conditions may not prevent degradation of services in some situations.

Repairs to certified equipment should be made by an authorized Canadian maintenance facility designated by the Supplier. Any repairs or alterations made by the user to this equipment, or equipment malfunctions, may give the telecommunications company cause to request the user to disconnect the equipment.

Users should ensure for their own protection that the electrical ground connections of the power utility, telephone lines and internal metallic water pipe system, if present, are connected together. This precaution may be particularly important in rural areas.

Caution: Users should not attempt to make such connections themselves, but should contact the appropriate electrical inspection authority or electrician as appropriate.

Your Cordless Phone is designed to operate at the maximum power allowed by the FCC and IC. This means your Handset and Base Unit can communicate only over a certain distance - which will depend on the location of the Base Unit and Handset, weather, and the construction and layout of your home or office.

Technical Specifications

FREQUENCY CONTROL

Crystal controlled
PLL synthesizer

WEIGHT

Handset: 187 grams
Base: 210 grams

TRANSMIT FREQUENCY

2401.056-2481.408 MHz

RECEIVE FREQUENCY

2401.056-2481.408 MHz

CHANNELS

95 Channels

NOMINAL EFFECTIVE RANGE

Maximum power allowed by FCC and IC. Actual operating range may vary according to environmental conditions at the time of use.

SIZE

Handset: 176mm x 51mm x 41mm
Base: 138mm x 126mm x 65mm

POWER REQUIREMENTS

Handset: 800 mAh Ni-Cd Battery Pack or 1500 mAh NiMH Battery Pack

Base: 7 VDC @ 500mA

MEMORY

Phonebook: 50 Memory locations; up to 32 digits for Number, 16 characters for Name, per location.

CID: 50 Memory locations

SPECIFICATIONS ARE TYPICAL AND MAY CHANGE WITHOUT NOTICE.

Table Of Contents

1. Important Safety Instructions

3. Introduction

- 4. Parts Check List
- 5. The Handset Layout
- 6. The Base Unit Layout

7. Getting Started

- 7. Setup

10. Basic Operation

- 10 Handset and Base Indicators
- 11. Soft Menu Functions
- 11. RDL (Redial)
- 11. MENU
- 12. Calls Log (Caller ID)
- 13. Handset Settings
- 13. Ringer Volume
- 13. Ringer Melody
- 13. Low Batt Tone
- 13. Range Tone
- 13. Keypad Tone
- 13. Contrast
- 13. Language
- 14. Range Extender
- 15. MEM (Memory)
- 16. To Store a Number/Name
- 17. To Search For and Dial a Number/Name
- 17. To Delete a Number/Name
- 18. To Edit a Name or a Number

19. Advanced Operations

- 19. Handset and Base Operation
- 19. Making Calls
- 19. Answering Calls
- 19. Hold Function
- 19. Flash Function
- 19. Volume Control
- 20. Page Feature
- 20. Handsfree Speaker Operation
- 20. Extension in Use Indication

- 20. Low Battery Indication
- 21. Message Waitin Idication
- 21. Call Waiting Deluxe
- 22. Custom Pay-Per-Use(PPU) Features
- 23. Headset Operation

24. Additional Information

- 24. Maintenance
- 25. In Case Of Difficulty
- 27. Warranty Statement
- 28. FCC and ACTA Regulations
- 32. Technical Specifications

BellSouth

Premium Systems®

OWNER'S MANUAL

2.4GHz DIGITAL SPREAD SPECTRUM
CORDLESS TELEPHONE SYSTEM

MODEL: 2621

