

vtech®

Innovation Beyond Technology™

USER'S MANUAL



**FULL COLOR Expandable Cordless System
with Dual Caller ID**

Model: i 5858

FEATURING:

- **High Resolution 65K color display includes picture & animation caller ID**
- **Musical Ringer - Personalize your ringer by recording directly from your PC or stereo equipment**
- **Phonebook Download - export your phonebook from popular applications (ie MS Outlook, Palm) directly into the handset.**

5.8
GHz
Digital Spread
Spectrum

Premium Cordless System

Important Safety Instructions

When using your telephone equipment, basic safety precautions should always be followed to reduce the risk of fire, electric shock and injury, including the following:

1. Read and understand all instructions.
2. Follow all warnings and instructions marked on the product.
3. Unplug this product from the wall outlet before cleaning. Do not use liquid or aerosol cleaners. Use a damp cloth for cleaning.
4. Do not use this product near water (for example, near a bath tub, sink or swimming pool).
5. Do not place this product on an unstable surface such as a table, shelf or stand. The product may fall, causing serious damage.
6. Slots and openings in the back or bottom of the base unit and handset are provided for ventilation. To protect them from overheating, these openings must not be blocked by placing the product on a soft surface such as a bed, sofa or rug. This product should never be placed near or over a radiator or heat register. This product should not be placed in any area where proper ventilation is not provided.
7. This product should be operated only from the type of power source indicated on the marking label. If you are not sure of the type of power supply in your home, consult your dealer or local power company.
8. Do not allow anything to rest on the power cord. Do not install this product where the cord may have anyone walking on it.
9. Never push objects of any kind into this product through slots in the base or handset as they may touch dangerous voltage points or short out parts that could result in a risk of fire or electric shock. Never spill liquid of any kind on the product.
10. To reduce the risk of electric shock, do not disassemble this product, but take it to an authorized service facility. Opening or removing parts of the base or handset other than specified access doors may expose you to dangerous voltages or other risks. Incorrect reassembling can cause electric shock when the product is subsequently used.
11. Do not overload wall outlets and extension cords as this can result in the risk of fire or electric shock.
12. Unplug this product from the wall outlet and refer servicing to an authorized service facility under the following conditions:
 - A. When the power supply cord or plug is damaged or frayed.
 - B. If liquid has been spilled onto the product.
 - C. If the product has been exposed to rain or water.
 - D. If the product does not operate normally by following the operating instructions. Adjust only those controls that are covered by the operating instructions, as improper adjustment of other controls may result in damage and often requires extensive work by an authorized technician to restore the product to normal operation.
 - E. If the product has been dropped and the base and/or handset has been damaged.
 - F. If the product exhibits a distinct change in performance.

Important Safety Instructions

13. Avoid using a telephone (other than cordless) during an electrical storm. There is a remote risk of electric shock from lightning.
14. Do not use the telephone to report a gas leak in the vicinity of the leak.
15. Only put the handset of your telephone next to your ear when it is in normal talk mode.

WARNING: To insure your safety from possible electric shock, only use the enclosed VTech audio patch cable to record custom ring tones. Do NOT leave the audio patch cable attached to the handset while charging in its charger.

Introduction

The **i 5858** is an advanced cordless telephone that operates in the 5.8GHz frequency range. Your **i 5858** is capable of supporting up to a maximum of eight handsets. Using additional handsets, up to four people can be conferenced on a call (three handsets and the base speakerphone).

This manual is designed to familiarize you with the **i 5858** cordless telephone. We strongly recommend you read the manual before using your phone.

To order additional system handsets (model number **i 5808**), batteries or headsets, visit us on the web at www.vtechphones.com or call VTech Communications, Inc. at 1-800-595-9511. In Canada, call 1-800-267-7377.

Parts Check List

1. Base Unit
2. Handset
3. Base Power Adapter
4. Telephone Line Cord
5. Special Features Guide
6. Quick Start Guide
7. Belt Clip
8. User's Manual
9. Audio Patch Cord
10. Battery
11. VTech Phonebook Manager CD
12. USB Cable

To purchase replacement batteries, visit us on the web at www.vtechphones.com or call VTech Communications, Inc. at 1-800-595-9511. In Canada, call VTech Telecommunications Canada Ltd. at 1-800-267-7377.

NOTE: Use only VTech batteries P/N 89-1324-00-00.

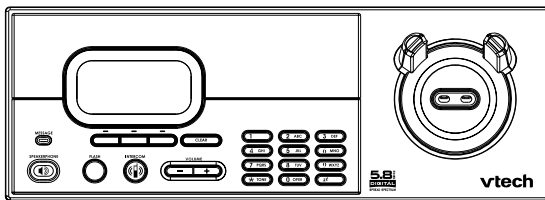

Base Unit

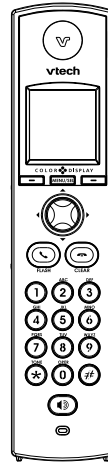

Handset



Belt Clip

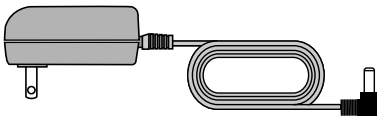

Base Power Adapter



Battery

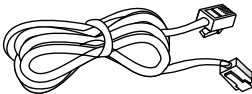

Telephone Line Cord

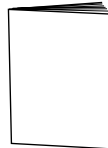

Special Features Guide
(English and Spanish)

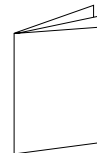

Quick Start Guide
(English and Spanish)

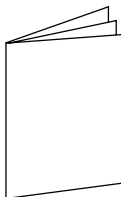

User's Manual
(English and Spanish)

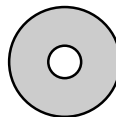

VTech Phonebook
Manager CD

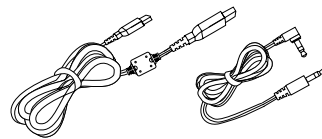

USB Cable

Audio Patch Cord

The Handset Layout

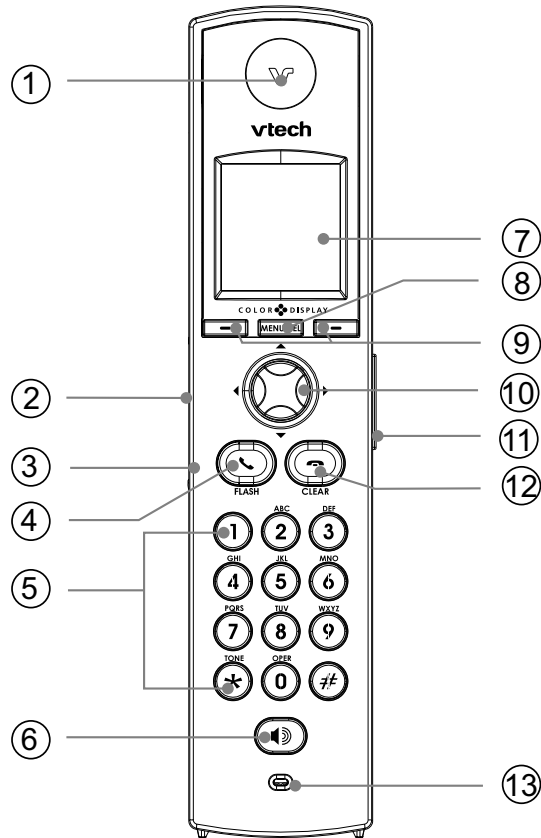

- | | |
|--|-------------------------------|
| 1. Earpiece | 7. LCD Display |
| 2. USB Cable Jack | 8. Menu/Select Key |
| 3. Headset Jack / Audio Patch Cable Jack (2.5mm) | 9. Softkeys |
| 4. On/Flash Key | 10. NavKeys (Navigation Keys) |
| 5. Dialing Keys (0-9, *, #) | 11. Volume Keys |
| 6. Speakerphone Key | 12. Off/Clear Key |
| | 13. Microphone |

The Base Unit Layout

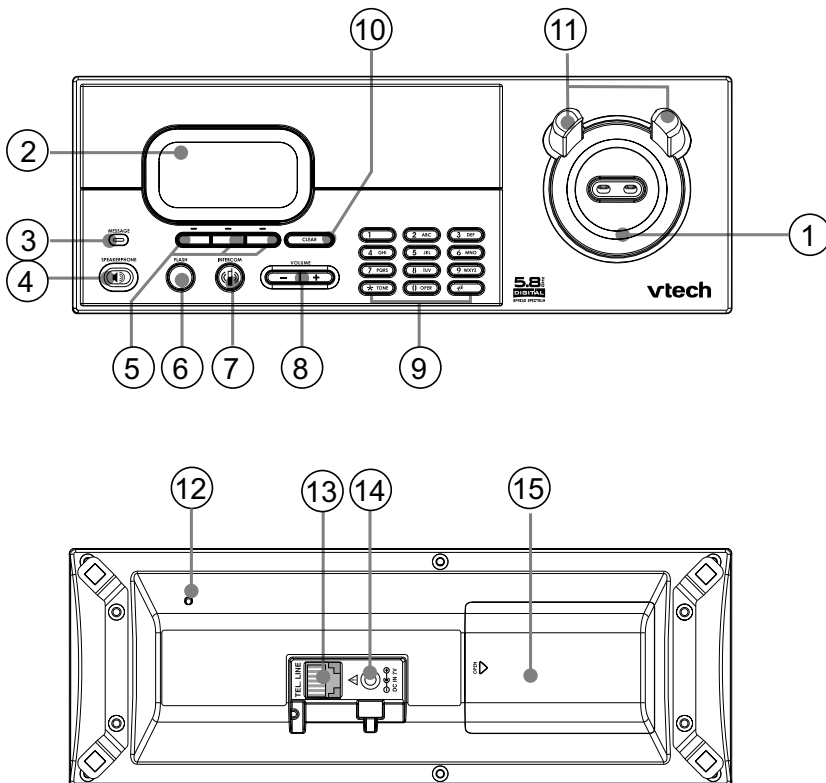

1. Charging LED
2. LCD Display
3. Message LED
4. Speakerphone
5. Softkeys
6. Flash
7. Intercom
8. Volume Key
9. Dialing Keys (0-9, *, #)
10. Clear
11. Antenna
12. Microphone
13. Telephone Jack
14. DC Connector Jack
15. Spare Battery Compartment

Setup

Connecting Power to Base Unit

Plug the power adapter into an electrical outlet, and the connector into the bottom of the base unit.

To outlet

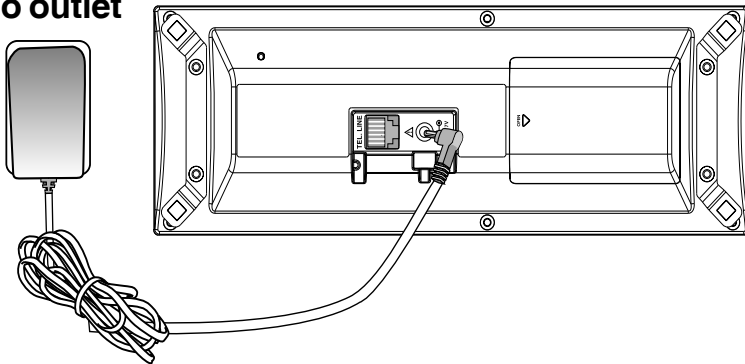

Installation and Charge of Battery

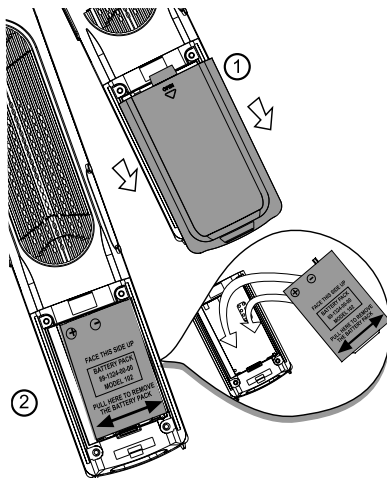

Follow these steps:

1. Remove the battery cover and place the battery in the compartment with the metal contacts aligning, as shown in the diagram.
2. Replace the cover by sliding it upwards.
3. If the new battery is not already charged, place the handset in its base unit, and allow it to charge for a minimum of 12 hours. After initial charge, a maintenance charge of eight hours should be sufficient.

Setup

Charging of the Handset Battery

The handset of your **i 5858** cordless telephone is powered by a rechargeable battery. It charges automatically whenever the handset is in its base. Maximum talk time on fully charged battery is seven hours, and maximum standby time is four days.

You should charge the battery for a minimum of 12 hours when you first receive your phone.

You'll know the battery need charging when:

- The low battery message is displayed:
- The handset seems completely dead, the LCD is completely dark and does not activate when you press the keys.



IMPORTANT:



1. Do not dispose of batteries in a fire, they might explode.
2. Do not open or mutilate the batteries. Toxic substances may be released, causing harm to eyes or skin.
3. Exercise care in handling batteries in order to prevent an accidental short of the charge contacts, potentially causing the batteries to overheat.
4. Do not dispose of batteries into household garbage. They should be properly recycled.
5. If the phone will not be used for long periods of time, remove the battery to prevent possible leakage.

Connecting to Phone Line

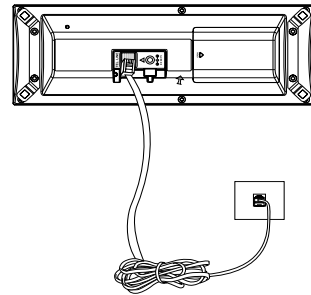
Plug one end of the telephone line cord into the jack on the bottom of the base unit. Plug the other end of this cord into the wall jack.



Checking for Dial Tone

After the battery is charged, press /FLASH (on) on the handset. The Phone icon  will appear on the handset display, and you will hear dial tone. If not, see **In Case of Difficulty**.

Setup



CAUTION: Use only the VTech power supply provided with your telephone.

IMPORTANT! FOR MAXIMUM PERFORMANCE OF YOUR CORDLESS TELEPHONE SYSTEM:

1. Choose a central location for your base unit.
2. Install your base unit and accessory handsets away from electronic equipment, such as personal computers, television sets and microwave ovens.
3. In locations where there are multiple cordless telephones, separate base units as much as possible.
4. Install your telephone equipment away from heat sources and sunlight.
5. Avoid excessive moisture, dust or extreme cold.

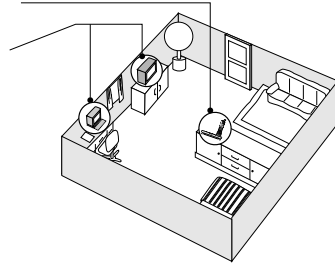

Power Guard/Spare Battery Charger Feature

Power Guard

The **i 5858** uses the spare battery charger in the base unit to provide operational backup in the event of a power failure. With a fully charged battery in the spare battery charger, you will still be able to place and receive calls, for up to 2.5 hours.

The spare battery can also be used to replace drained handset battery ensuring uninterrupted use. The spare battery is optional and purchased separately.

NOTE: When using the **i 5858** during power guard mode, audio quality may be compromised due to reduced power availability.

Installation

1. Open the spare battery compartment by pressing on the cover and sliding in the direction as indicated on the cover.
2. Place the battery in the charger with the metal contacts aligning, as shown in the diagram below.
3. Replace the spare battery compartment cover. The spare battery charger takes 20 hours to fully charge drained battery.

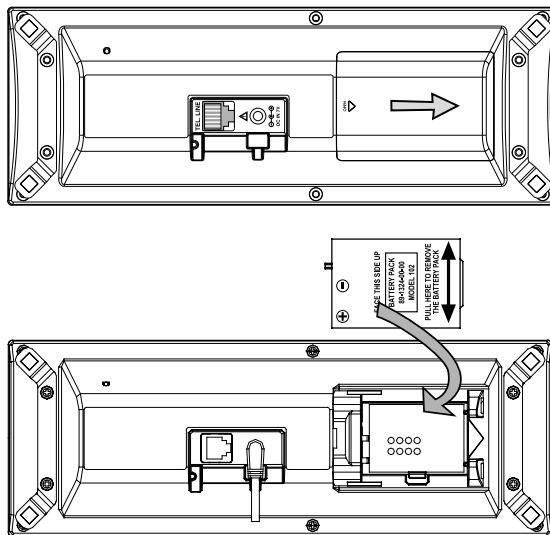

To order batteries, headsets and additional handsets (model i 5808), visit us on the web at www.vtechphones.com or call VTech Customer Service at 1-800-595-9511. In Canada, call 1-800-267-7377.

Installation and Registration of Accessory Handset

Expand your i 5858 system by adding accessory handsets. Bring telephone access to rooms where a phone jack isn't available!

Your VTech i 5858 system can operate up to eight handsets. To order additional handsets (model i 5808), visit us on the web at www.vtechphones.com or call VTech Customer Service at 1-800-595-9511. In Canada, call: 1-800-267-7377.

The original handset that is shipped with your i 5858 system will be automatically registered to the base. This handset is HANDSET 1.

As you register additional accessory handsets (model i 5808) to the system, they will be assigned extension numbers in the following order: **HANDSET 2, HANDSET 3**, etc.

Whenever a charged handset battery is installed, the handset will automatically begin **Searching for Base...** (if previously registered), or it will prompt you to register the new handset.

The i 5808 accessory handset consists of the following:



Handset



Battery



Belt Clip

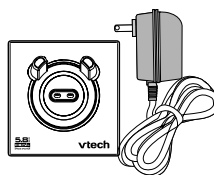

Charger

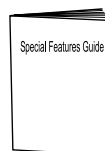

Special Features Guide
(English and Spanish)

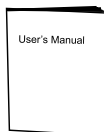

User's Manual
(English and Spanish)

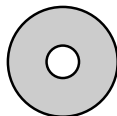

VTech Phonebook
Manager CD

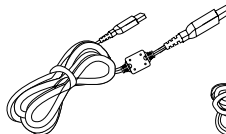

USB Cable

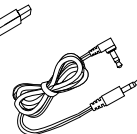

Audio Patch Cable

Installation and Registration of Accessory Handset

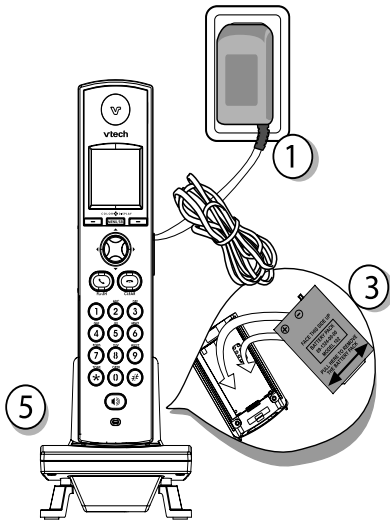

Setup of i 5808 Accessory Handset

1. Plug the power adapter into an electrical outlet.
2. Place the battery in the handset with the metal contacts aligning, as shown in the diagram to the left.
3. Replace the battery compartment cover by sliding it upward.
4. Place the handset in the charger, and allow it to charge for a minimum of 12 hours. After the initial charge, a maintenance charge of eight hours should be sufficient.

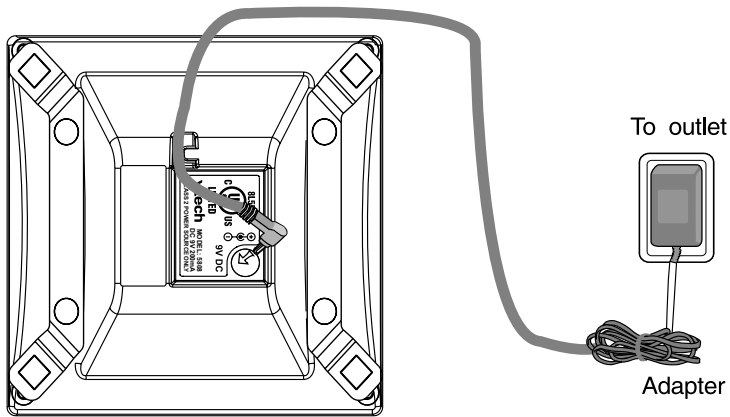

Installation and Registration of Accessory Handset

Registration

Your **i 5858** handset comes registered to the base unit. To register additional **i 5808** handsets (purchased separately):

Registering the i 5808 handset for the first time

After charging, the handset will display registration directions, which are as follows:

- On the base unit, press **MENU**, then select **REGISTER HANDSET**.



- When the base unit shows **READY TO REGISTER NEW HANDSET**, press **REGISTER** on the handset.

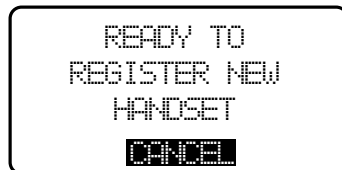









- The handset displays **Registration in Progress**.



- Within approximately 15 – 60 seconds the base and handset will beep, and the newly registered handset will be assigned the lowest extension number not previously assigned to another system handset (1 – 8).

Handset and Base Indicators

Handset Icons





Icon	Description
	<p><u>Line In Use Indicator</u></p> <ul style="list-style-type: none"> On steady when an extension handset or parallel set is in use. <p><u>Hold Indicator</u></p> <ul style="list-style-type: none"> Flashes when a call is on hold.
	<p><u>Mute Indicator</u></p> <ul style="list-style-type: none"> Flashes when the handset microphone is muted.
	<p><u>Ringer Off Indicator</u></p> <ul style="list-style-type: none">  is displayed when the ringer is turned off.
	<p><u>Battery Indicator</u></p> <ul style="list-style-type: none"> When the handset is removed from the charger, this lets you know the level of charge in the battery, from FULL () to EMPTY () Cycles (low, medium, and full) when handset battery is charging. Flashes when a low battery condition is detected.
	<p><u>Message Waiting Indicator</u></p> <ul style="list-style-type: none"> Flashes to indicate that you have new voicemail messages. (Service must be subscribed to through your local telephone company.)

Handset LEDs

LED	Description
	On when handset speakerphone is in use.

Handset and Base Indicators

Base Unit Icons

Icon	Description
	<u>Ringer Off Indicator</u>  is displayed when the base ringer is turned off.
	<u>Line In Use Indicator</u> <ul style="list-style-type: none">• On steady when an extension handset or parallel set is in use. <u>Hold Indicator</u> <ul style="list-style-type: none">• Flashes when a call is on hold.
	Battery Indicator <ul style="list-style-type: none">• Cycles (low, medium, and full) when battery is charging in the spare battery compartment.• Flashes when the base is under power backup mode (No AC power is detected).
MUTE	Mute Indicator <ul style="list-style-type: none">• Flashes when the microphone is muted.

Base LEDs

LED	Description
Message	<ul style="list-style-type: none">• Flashes to indicate that you have new voicemail messages. (Service must be subscribed to through your local telephone company.)
Speakerphone	<ul style="list-style-type: none">• Flashes when a call is on hold.• Lights when base speakerphone is in use.
Charging	<ul style="list-style-type: none">• On when the handset is in its base.

Handset Menu

Handset Main Menu

Enter the handset main menu options by pressing **MENU/SEL**. Use the ▲ and ▼ NavKeys to select from the seven menu items described below.

NavKeys (Navigation Keys)



Press the ▲ and ▼ NavKeys to maneuver through the various options in the handset main menu. Press **MENU/SEL** to choose the displayed menu item.

Phonebook

Enter and retrieve up to 100 names and phone numbers, each can be assigned a distinctive ring and image.

Call Log

Review caller ID data, select and dial from the caller ID data .

Intercom

Talk between handset(s) and base unit (when at least one **i 5808** accessory handset is registered to your **i 5858** base unit.), or use to page the handset(s) or base.

Settings

Set the time, change the tone setting, adjust the phone settings, change the language of the menu prompts or reset all to factory settings.

Sounds

Record custom sound clips, turn ringer and vibrate feature on or off, select main ringer tone.

Pictures

Choose from the many preset images or download new images into the handset to be used as your idle screen (wallpaper) or assign an image to a specific phonebook directory.

Animations

Choose from many preset images to use as your idle (wallpaper) screen or assign as a distinctive image to a specific phonebook directory.

Use the up and down NavKeys to maneuver to the desired menu option, then press **MENU/SEL** to select.

Screen Saver

After 30 seconds of inactivity in idle mode, your handset will go into screen saver mode. While in screen saver mode, your handset will display a digital clock. To illuminate the screen and read the clock, simply press the volume buttons on the right edge of the handset.

Handset Menu

Phonebook



Enter the phonebook directly from idle mode by pressing the ▲ or ▼ Navkeys.

— OR —

Press **MENU/SEL**, then using the ▲ and ▼ NavKeys, scroll to phonebook, then press **MENU/SEL**. If there are no entries, the screen will display **Phonebook is empty**. The i 5858 handset can store up to 100 numbers with names in the phonebook directory, along with a distinctive ring and image for each. Each memory location can hold up to 32 digits and up to 16 characters, including spaces.

Each press of a key will cause characters to be displayed as follows:

Number Key	Characters (in order)
1	& ' , . 1 Space
2	A B C a b c 2
3	D E F d e f 3
4	G H I g h i 4
5	J K L j k l 5
6	M N O m n o 6
7	P Q R S p q r s 7
8	T U V t u v 8
9	W X Y Z w x y z 9
0	0
*	*
#	#

Adding Phonebook Entries

- From the handset idle (off) mode, press the ▲ or ▼ NavKey.
- Press the **NEW** softkey.



NOTE: When the phonebook is full and **NEW** is pressed, **Phonebook is full** will display and an error tone will sound.

Handset Menu

- You will then be prompted to **Enter Name**. Use the digit keys to spell the name. If you make a mistake, press the **BACK** softkey. To add a space between characters, press **RIGHT** twice. When finished, press the **SET** softkey.

NOTE: Press **RIGHT** to advance the cursor. Press again to add a space.

- Enter the number you want to store in the phonebook. Press and hold the # key to insert a pause. If you make a mistake, press the right softkey **BACK**. When finished, press **SET**. The screen will display:

NOTE: If you do not wish to assign a distinctive ring tone or image to this phonebook entry, press **SAVE** now.

- If you wish to be alerted to calls from this phone number, you can assign a unique ring tone to this phonebook entry. Press the up or down NavKey to scroll to **Ringer : < Default >**.
- Press the left or right NavKey to sample the ringer options. Press **BACK** to return to the default ring tone.
- OR -
Press **MENU/SEL** then press the up or down NavKey to sample the options. Once you have selected a ringer, press **SET**.
- Once you have selected a ringer, press the down NavKey to move on and select a distinct image or animation for this entry or press **SAVE** to confirm your selections. You must subscribe to caller ID service for the distinctive ring function to work.

NOTE: There are eight traditional ring tones and 17 musical ringers. For **Recordable Ringer**, see page 25.

- If you wish to be visually alerted to calls from this number by changing to a distinctive image or animation, press the **UP** or **DOWN** NavKey to scroll to **Picture: < (none) >**.

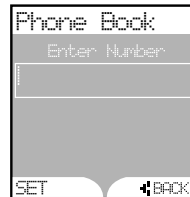

Handset Menu

- Press the ◀ or ▶ NavKey to sample the picture and animation options. If you make a mistake, press  to delete.
— OR —
- Press **MENU/SEL** then press the ▲ or ▼ NavKey to sample the picture and image options.
- Once you have selected an image or animation, press **SET**. You must subscribe to caller ID service for the distinctive image or animation feature to work.

NOTE: There are 29 preset pictures and animations to choose from. For **Picture Download** information, see page 26.

- Once you've selected a picture or an animation, press **SAVE**.
- Your phonebook entry has been saved and the screen will display:



Searching for and Dialing Phonebook Entries

- With the handset in idle (off) mode, press the ▲ or ▼ NavKey to enter the phonebook.
- Continue pressing the ▲ or ▼ NavKeys to scroll through the contents in alphabetical order.

— OR —

Use the number keys to enter the first characters of the name. The closest match alphabetically will be displayed.



— OR —

Press the **FIND** softkey, enter the first few characters of the name and then press **SET** to search. If you make a mistake, press the  softkey. The closest match alphabetically will be displayed.



Handset Menu

- Once you find the entry you want, simply press /FLASH (on) or **SPEAKERPHONE** to dial the number.



Editing Phonebook Entries

- Following the first two steps in **Searching for and Dialing Phonebook Entries**, locate the entry you want to edit.

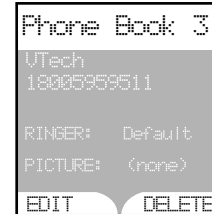

- Press the **MENU/SEL**. The screen will display:
- Press the **EDIT** or **MENU/SEL** softkey.



- Press  or  NavKeys to the option you want to edit then enter the corrections as needed. Press the softkey  to delete.



- When finished, press the **SAVE** softkey. The screen will display the edited entry.

Deleting Phonebook Entries

- Following the first two steps in **Searching for and Dialing Phonebook Entries**, locate the entry you want to delete.

- Press **MENU/SEL**. The screen will display:
- Press **DELETE** softkey. The entry will be deleted.



Handset Menu

Call log



To access the call log, press the **CALL LOG** softkey.
- **OR** -
Press **MENU/SEL**, then the **▲** or **▼** NavKeys to scroll to call log menu. Press **MENU/SEL**.

Then use the **▲** and **▼** NavKeys to scroll and view the CID records in the call log.

This feature allows you to scroll through the 100 current caller ID and call waiting records received. With a CID record displayed, press **SAVE** to store it in the phonebook (see page 17), or press **DELETE** to remove the entry from the log.

You can also dial a CID record while reviewing. With the desired CID displayed, press **#** or **MENU/SEL**. The possible options to choose from will be either 7, 10, or 11 digits. For example, if the original number in caller ID memory was 800-595-9511, then the display options will be:

Press the **▲** and **▼** NavKeys to make the selection, then press left softkey, **📞/FLASH** (on) or **🔊** to dial the number.

NOTE: Due to regional incompatibilities, CID information may not be available for every call you receive. In addition, the calling party may intentionally block their name and/or phone number from being sent.

Intercom



From Handset to Handset (or Base):

- With the **Intercom** icon highlighted, press **MENU/SEL**.
- Press the **▲** and **▼** NavKey to the desired handset.
- Press **MENU/SEL**.
- The ringing handset (or base) can answer by pressing **📞/FLASH** (on) , **🔊** or any of the number keys (or the intercom button on the base)
- To end an intercom call, press **📞/CLEAR** (off) on any handset or place the handset to base unit.



Handset Menu

NOTE: To access this feature, you must have at least one additional handset. To order accessory handsets, please refer to page 11.

Global Page from Handset:

- With the **Intercom** icon highlighted, press **MENU/SEL**.
- Press the up or down NavKey to highlight **Global Page**. Press **MENU/SEL**.
- Any registered handset and base can answer the global page, thus entering intercom mode.
- To end the intercom call, press  /**CLEAR (off)** on any handset or base.



Settings



Enter the settings menu by pressing **MENU/SEL**, then the ▲ and ▼ NavKeys. When **Settings** are displayed, press **MENU/SEL**. Use the up and down NavKeys to choose from the following:

Clock Setting

This option allows you to change the time that will display on the idle screen. If you subscribe to caller ID, the time will be set automatically when the first caller ID record is received.

NOTE: If you choose to set the time manually, use the number keys and the ▲ and ▼ NavKeys.

Tone Settings

This option allows you to turn the following options on or off: keypad tone, low battery tone, and out of range tone.

Phone Settings

Choose this option to change the contrast of your handset screen, edit handset name, show handset name, select dial type (choose from tone or pulse), display product ID.

NOTE: Your phone is preset for tone dialing.

Language

This option allows you to change the screen prompts to English, Spanish or French.

Reset Settings

Choose this option to reset the following settings: Clear Msg Indication, Phonebook, Call Log, Redial List, Wallpaper, Registration, Factory Settings.

NOTE: The **Factory Settings** option will reset the settings listed above back to the factory defaults. The screen will display **Restore Factory Settings Are you sure?** Press the **YES** or **NO** softkey to make your selection.

Handset Menu

Sounds



Play Sound Clips

This option allows you to access all preset melodies and the melodies you have recorded using the **Recordable Ringer** option (see page 25 for details.)

Record Sound Clip

Choose this selection to record your own ring tones. See recordable ringer on page 25 for complete instructions.

Ringer Melody

This option allows you to assign various ring tones for incoming calls. You can choose from eight preset traditional ringers or 17 preset musical ringers or the ring tones you have recorded.

Ringer Volume

Adjust the ringer volume to a comfortable setting or turn the ringer off.

NOTE: When the phone is ringing, press **SILENCE** softkey or **CLEAR** key to temporarily mute the ringer

Ringer Vibrate

Turn the vibrating ringer on or off.

Use the ▲ and ▼ NavKeys to maneuver through the menu options. Press the **SET** softkey to confirm your selection.

Pictures



Your **i 5858** handset is preset with 23 pictures you can use as the background for your idle screen (wallpaper) or assign a specific image to a phonebook directory. You can also download your own pictures (see **Picture Download** on page 26).

Set a Wallpaper image

To set a wallpaper image, select the icon **Pictures** in the main menu. Then use the up and down Navkeys to view the available images. Once you have selected the image, press the **SET** softkey to set the image as your wallpaper. You will receive a message on the screen confirming **Wallpaper Set** and an audio confirmation.

Set an Animation image



To set an animation as your wallpaper, select **Animation** in the main menu. Then use the ▲ and ▼ Navkeys to view the available images. Once you have selected an animation, press the **SET** softkey to set the image as your wallpaper. You will receive a message on the screen confirming **Wallpaper Set** and an audio confirmation.

Handset Menu

Redial

- Press the **REDIAL** softkey to display the last 20 telephone numbers dialed from the handset. The number on the top line represents the last number dialed.



- Use the ▲ and ▼ NavKey to scroll to the desired number.



- To dial, press  /FLASH (on) or .



Saving Redial Number in Phone Book Memory

- Press **REDIAL**, then scroll to the desired number.
- Press **SAVE**.



- You will be asked to **ENTER NAME**. Use the keypad to enter the desired name (see **Phonebook** for more information).
- Press **SET**. The name and number has been stored in Phonebook memory.



Deleting Numbers in Redial Memory

- Press **REDIAL**, then scroll to the desired number.
- Press **DELETE**.



Recordable Ringer

Record a Ringer

You can easily record a unique ringer to be used as either your default ringer or for a distinctive ringer assigned to a specific phonebook directory. You can record with either the provided audio patch cord (not the USB cord), or with the handset microphone.

NOTE: The space allotted for recordable ringers and picture download are dynamic. This means you can delete pictures to make more room for custom ring tones, if you wish.

Cued-up music typically produces the best sounding recorded ringer. It is recommended to begin recording your ringer at the beginning of a song, rather than a portion from the middle to produce an audibly pleasing custom ringer.

Note: Your **i 5858** handset is preset with 17 musical ringer options (i.e. harmony, reflection, harmonic, swing, etc.) for you to use as your default ringer or a distinctive ringer. Four of the ringers are protected, you cannot replace them. You can replace the other ringers with your own recordings. You will find 14 additional sound clips excluding those preset in the handset on the accompanying CD-ROM.

- You can use the audio patch cord by inserting the 3.5mm plug (the larger end) into the headset jack of your PC or audio source. Then insert the 2.5mm plug (the smaller end) into the headset jack on the side of the **i 5858** handset.

You can listen to the playing music through your handset speaker after connecting the audio patch cord and selecting the **Using Audio Cable** menu option. Adjust the recording volume at the audio source. To begin recording, press **RECORD**.

If you want to use the handset microphone to record ringers, select the **Using Microphone** menu option. After the beep, and with the handset microphone facing the audio source, start recording.

- Select the **Sounds** icon  in the main menu.
- Select the **Record Sound Clips** option, the handset will show **Using Microphone** or **Using Audio Cable**. The handset will record up to 15 seconds.

NOTE: If the memory is full, the handset will prompt **Sound Clip memory full**.

- Press the **STOP** softkey stop the recording.
- After recording, you may **PLAY** or **SAVE** the melody. If you choose **SAVE**, you will be prompted to **Enter Clip Name**. Enter a name (up to ten characters) for the recording. If you make a mistake, press the  softkey to backspace. Press **SAVE** to confirm. **Sound Clip saved** will display. The melody will be stored in the **Play Sound Clips** section. You can listen to all of your recorded music clips in this location. If you want, when in **Play Sound Clips**, you can press **DELETE** then **YES** to erase.



NOTE: When you want to use the handset microphone to record ringers, do not insert the audio patch cord into the headset jack.

Picture Download

Getting Started

The **VTech Phonebook Manager** allows you to download pictures and edit your handset phonebook from the convenience of your PC. It also allows you to import/export contacts from/to comma separated text files. This great feature allows you to get contacts from your existing PC applications such as Microsoft Outlook or Palm programs.

One-time Software Installation

- Insert the enclosed **VTech Phonebook Manager** CD into your personal computer.
- An installation window will open on your monitor giving you three options:
 1. Install/Uninstall the phonebook manager software.
 2. Browse the installation CD.
 3. Visit VTech on the web.
- To install the software, click on the **Install/Uninstall the VTech Phonebook Manager** icon  and follow the download instructions.
- After the installation is complete, you will find a VTech phonebook manager icon  on your PC desktop.

Graphics Tab Functions

The VTech phonebook manager allows you to open graphic files on your PC and transfer them to your phone. Once the graphics are transferred, they can be used for your wallpaper image or to assign to a particular phonebook entry, quickly alerting you to your caller's identification.

With the phonebook manager you can also modify the graphic prior to sending it to the handset. Common graphic editing functions such as zoom, rotate, brightness/contrast adjustment and red/green/color balance adjustments can all be done from the VTech phonebook manager.

Open a Graphic File



- Open the phonebook manager by double-clicking on the desktop icon: 
- Click on the **Graphics** tab.
- Click on the **OPEN IMAGE** button.
- A window will open to allow you to browse for the graphic file on your computer.
- Find the folder containing your graphic file and double-click to open it.

Picture Download

Once you've opened a graphic file, it can be transferred from your PC to your handset. There are many images loaded onto the phonebook manager software you can download into your handset, or you can transfer your own pictures onto the handset. The phonebook manager supports the following graphic formats: GIF, JPEG, BMP, TIFF and PNG.

NOTE: The space allotted for recordable ringers and picture downloads in your handset are dynamic. This means you can delete ring tones to make more room for image downloads, if you wish.

To transfer images from the software to the handset:

- Connect one end of the enclosed USB cable to the handset and the other end to your PC.
- If you have the phonebook manager program open, you should see the status in the bottom right corner update that the PC has detected the phone. You are now ready to transfer a graphic to the phone. 
- Following the steps in **Open a Graphic File**.
- Once you have opened the desired image, click on the Transfer to Handset button. 

Picture Download/Phonebook Tab Functions

- The graphic transfer will now begin and complete within approximately four seconds.
- Once the graphic transfer is complete, the image is saved in the phone, you do not need to do anything else to save the image.

Graphic Editing

The VTech phonebook manager allows you to perform basic graphic editing functions such as zoom, rotate, adjust brightness/contrast and adjust the color balance. As you use these tools to edit your pictures, you can see them update on the preview panel on the left side of the phonebook manager application.

NOTE: None of the graphic editing functions will alter the actual graphic file – they will only modify how the graphic will look once it has been downloaded to the handset.

While in graphic edit mode, you will notice a red preview box over the center of main graphic panel. This preview box contains the image shown in the preview panel on the left side of the application. You can move the preview box by:

1. Move the mouse pointer so it's inside the red preview box.
2. Press and hold the left mouse button.
3. Use the mouse to move the red preview box to hover over a new location on the graphic.



4. Once the preview box is over the area of the graphic you want to download onto your handset, release the mouse button.

Phonebook Tab Functions

The VTech phonebook manager can be used to create, modify and backup phonebook files from your handset. The phonebook manager has many useful functions:

- Export existing contacts from any contact manager (such as Microsoft Outlook, Palm, etc.) to a comma separated text file. Import those contacts into the phonebook manager and transfer the entire phonebook to your handset.
- Transfer a phonebook from your handset to your PC and save it to disk. Connect a different handset and transfer the phonebook from your PC to the new handset. This allows you to easily store a copy of a phonebook on your PC and transfer it to several different handsets.
- Use the phonebook manager to backup your handset phonebook onto your PC. If for any reason you need to restore the phonebook on your handset, you have a copy safely stored on your PC.
- Use the phonebook manager to create a phonebook offline on your PC. When you have finished editing it, connect your handset and transfer it from the PC to your handset.

NOTE: The phonebook manager application does **not** perform any synchronization of the phonebook between the PC and the handset. When the **Transfer to Handset** button is pressed, the entire phonebook is transferred to the handset replacing the existing phonebook on the handset.

Creating an Empty Phonebook

To create an empty phonebook to input data:

- Double-click on the VTech phonebook manager icon on your PC.
- Click on the **Phonebook** tab.
- Select the **CREAT PHONEBOOK**  button.
- Using the phonebook manager application, make any changes required to the phonebook. You can add entries or import contacts from other PC applications such as Microsoft Outlook or Palm.



Phonebook Tab Functions

- Once you have completed editing the phonebook, you must either save the data to your PC's hard drive or transfer it to your handset:
- Select the **SAVE PHONEBOOK**  button to save the data to your PC's hard drive.
- OR-
- Click on **Transfer** 

NOTE: This operation will replace the phonebook on your handset with the new one you have currently transferred from the phonebook manager.

Edit a Phonebook

You can either open an existing phonebook stored in your PC's hard drive by pressing the **OPEN PHONEBOOK**  button using the phonebook manager software, or by transferring the phonebook from your handset by transferring it to the phonebook manager software using the supplied USB cable. To accomplish this:

- Connect your handset to your PC using the USB cable.
- Start the phonebook manager application on your PC.
- Verify the connection by insuring the green icon on the status bar. (If it is not, re-connect the handset to the PC with the USB cable.)
- Press the **Phonebook** tab.
- Press the **Transfer**  button.
- Using the phonebook manager software, edit the phonebook entries as you wish. At this time you can also add new entries or import contacts from other programs such as Microsoft Outlook or Palm, etc.
- When you are finished editing the phonebook, save it to your PC's hard drive by pressing the **SAVE PHONEBOOK**  button. To transfer the newly edited phonebook to your handset, use the **transfer phonebook**  button.

Import Contacts Into Phonebook Manager From Other PC Applications

Use this feature to import contacts from a comma separated text file into the VTech phonebook manager software. The contacts will be merged into the currently loaded phonebook.

1. Create a comma separated text file containing the contacts you want to import into your handset. This is accomplished by using the export function from your other contact management application (such as Microsoft Outlook, Outlook Express or Palm applications). The export function in these programs is normally located under the file menu. Be sure to specify the export file as a text file or comma separated file (CSV). An example of exporting contacts from Microsoft Outlook is as follows:
 - a. Start Microsoft Outlook on your PC.
 - b. Select **import/export** from the file menu.
 - c. Select **export to file** and press **next**.
 - d. Select a file type of **comma separated values** (in Windows).
 - e. Select the folder containing the contacts you want to export.
 - f. Once you've selected a contact folder, press **next**.
 - g. Enter a file name to save your contacts to. This will be the file you select to import into the phonebook manager program. Be sure to make note of where on your PC you save the file for later reference.

Phonebook Tab Functions

2. Start the VTech phonebook manager program on your PC. Load the newly created phonebook into the phonebook manager software using these steps:

- Press the **Transfer**  button.
- Press the **CREAT PHONEBOOK**  button. This will create an empty phonebook.
- Press the **OPEN PHONEBOOK**  button to load the previously saved phonebook from your PC's hard drive.

NOTE: For first time users, try the import operation on an empty phonebook until you have mastered the process.

- Press the **Import/Export**  button.
- Select **Import Contacts** and press the **next** button.
- Use the **browse** button to locate the comma separated text file you saved in step one. Press **next**.
- The next screen displays how the fields from the comma separated text file will be mapped to the handset phonebook entries. There are two fields in the VTech phonebook; name and number. However, most PC contact managers separate names into the first and last name fields. To allow import of this type of file, the mapping dialog allows you to instruct how the name fields from your import file will be placed in the VTech phonebook name field. For example, the following mappings will import the fields first name and last name into the VTech name field. The home phone field will be imported into the VTech phone number field:
If the mapping displayed is not what is desired, select one of the rows and press the **Change Map** button to correct it. You can only use each of the three fields (VTech name first, VTech name last and VTECH phone number) once. If you want to change one that has already been mapped, you must first select that row and use the **Change Map** button to remove the association.
- When you are done editing the mapping, press the **Finish** button. The contacts will now be imported and merged into the currently loaded phonebook.

Exporting Contacts to a Comma Separated Text File

This feature allows you to export some or all of your VTech phonebook entries into a comma separated text file. This comma separated text file can then be imported into common contact manager software such as Microsoft Outlook or Palm applications.

- Load a phonebook into the phonebook manager.
- If you wish to only export some of your contacts, select the desired contacts in the list of contacts loaded. You can use your mouse to select to a single row. If you want to select multiple rows, hold down the **CTRL** key while using your mouse to click on the rows to be selected.
- Press the **Import/Export**  button.
- Select **Export Contacts** and press the **next** button.
- Select whether you want to **Export All Contacts** or **Selected Contacts**.
- Enter the name of the file to export the contacts to. You can use the browse button to locate the folder and enter a file name.
- Press the **Finish** button to complete the export operation.

Deleting Phonebook Records From the Currently Loaded Phonebook

- Start the phonebook manager software on your PC.
- Press the **Phonebook** tab.
- Load a phonebook into the phonebook manager.
- Select the rows of the phonebook records that are to be deleted. You can use your mouse to select a single row. If you want to select multiple rows, hold down the **CTRL** key while using your mouse to click on the rows to be selected.
- Press the **Delete Selected Contacts**  button.
- Save the file to disk and/or transfer it to the handset.

Base Menu Soft Functions

Your **i 5858** has an advanced design that uses a menu structure and softkeys to access many of the features.

Example of the idle mode display:

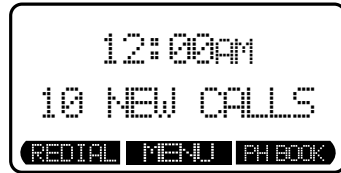

Redial

Your **i 5858** base remembers the last 10 numbers dialed from it. Press **REDIAL**. The number on the top line represents the last number that was dialed.

- Use the scroll keys to highlight the desired number.
- To dial, press **SPEAKERPHONE**.

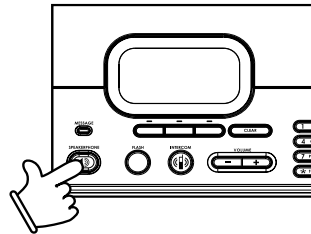

Erasing Numbers in Redial Memory

- Press **REDIAL**, then scroll to the desired number.



- Press **SELECT**, then **DELETE**.

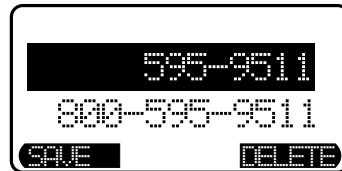

Saving Redial Numbers in Phonebook Memory

- Press **REDIAL**, then scroll to the desired number.



Base Menu Soft Functions

- Press **SELECT**, then **SAVE**.
- You will be asked to **ENTER NAME**. Use the keypad to enter the desired name (see **To Store a Number/Name** on page 37).
- Press **SAVE**. The name and number has been stored in phonebook memory.

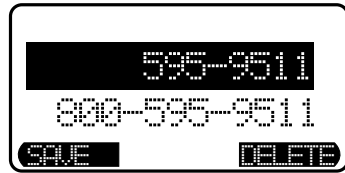

Base Unit Menu

With the base unit in the idle (off) mode, press the **MENU** key to access the **CALL LOG**, **BASE SETTINGS** and **REGISTER HANDSET** options.

Press the **CLEAR** key to go backward through the menu. Press and hold **CLEAR** to immediately return to the idle screen.

Base Menu Soft Functions

Calls Log

Caller ID - call waiting ID

Your **i 5858** is capable of displaying the name and/or number of the party calling before you answer the phone (caller ID). It is also capable of displaying caller ID information in conjunction with a call waiting alert signal (call waiting caller ID). With call waiting caller ID, the caller ID data is displayed so you can decide whether to answer the incoming call, or continue with your current conversation.

NOTES ABOUT CALLER ID & CALL WAITING CALLER ID

These are subscription services, provided by most regional telephone service providers. You must subscribe to these services to get the benefits of these features. If you do not subscribe to caller ID services, you can still use your **i 5858** and the other features it offers. Due to regional incompatibilities, caller ID information may not be available for every call you receive. In addition, the calling party may intentionally block their name and/or phone number from being sent.

Reviewing caller ID from the base

As new caller ID/call waiting ID records are received, your base display will alert you to the new caller ID records, for example:



The number of new calls displayed on each system handset and base may not be the same. If, for example, you answer a call on a handset, the handset will not count the caller ID information for that call as new. However, the base displays will consider it a new call, and add it to the **NEW CALLS** total.

After you review a new caller ID record, the **NEW CALLS** status will be turned off.

From the idle (off) mode, press **MENU**, highlight the **CALL LOG** option, then press **SELECT**. The caller ID information of the most recently received call will be displayed. For example:





To scroll to other records, use the **▲** and **▼** softkeys.



Base Menu Soft Functions

Dialing from Caller ID

To dial the number displayed, simply press the  key.

You can also use the dialing option as follows:

Dialing Option: Press **SELECT**. Use the  and  Navkeys to scroll to **DIAL OPTION**, then press **SELECT**. Up to three possible dialing options of the number stored in caller ID memory will display. If a number is provided in the caller ID data, the possible options to choose from will be either 7, 10, or 11 digits. For example, if the original number in caller ID memory was 800-595-9511, then the display options will be:

Use the  and  softkeys to make a selection, then press **DIAL** or  to dial the number.



Dialing Tip: With a caller ID record displayed, press **#** repeatedly to cycle through the three dialing options. When the correct dialing option is displayed, press **DIAL** or  to dial.

Save CID Records to Phonebook Memory

Press **SELECT**, then **SAVE TO PH. BOOK**. Only caller ID records with telephone numbers can be saved into the phonebook. If you need to modify the number after saving, see **To Edit a Number**.

Deleting CID Records

To delete the displayed caller ID record, press **SELECT**, then **DELETE CALL LOG**. You will then have the option of deleting the current CID record (press **THIS**) or all stored CID records (press **ALL**).

If you press **ALL**, the screen will ask **ARE YOU SURE?** Press **YES** to confirm the deletion of all CID records. Or press **NO** to return to the CID record previously displayed.

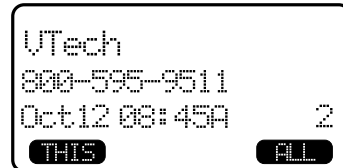

NOTE: You do not have to manually delete caller ID records. Your **i 5858** saves up to 50 most current CID records in base unit. As new records come in, the oldest records are automatically deleted to make room.

Base Menu Soft Functions

Base Settings

To access base settings, with the base in the idle (off) mode, press **MENU**, scroll down to **BASE SETTINGS**, then press **SELECT**. You can now access the following setting options:

CLOCK SETTING	RINGER VOLUME	RINGER MELODY
KEYPAD TONE	CONTRAST	DIAL TYPE
CLEAR MSG WAIT	FACTORY SETTINGS	DELETE HANDSETS
PRODUCT ID		

Press **CLEAR** at any time to back out of the base settings mode.

Clock Setting

If you subscribe to caller ID, the clock will automatically be set when the first call is received. If you don't have caller ID or wish to set the clock manually:

- Press **MENU**, then scroll to **BASE SETTINGS**.
- **CLOCK SETTINGS** will be highlighted, press **SELECT**.
- Press the **CHANGE** softkey to change the first digit of the hour, press **NEXT**. (Follow this procedure to change the remaining digits of the time and select AM or PM.)
- When finished, press **SET**, you'll hear a confirmation tone.

Ringer Volume

To adjust the base unit ringer volume:

- Press **MENU**. Scroll down to **BASE SETTINGS**, then press **SELECT**. Use the up and down softkeys to **RINGER VOLUME**, press **SELECT**. You will see a graph on the base display indicating the current volume setting.
- Press the **←** softkey to lower the ringer volume. At the lowest setting (graph is completely clear), the base will not ring when a call comes in.
- Press the **→** softkey to raise the volume. At the loudest setting, the graph is completely shaded in.
- Press **SET** to confirm your setting.

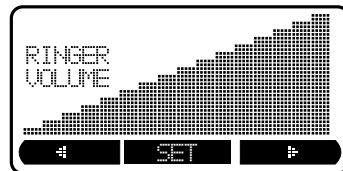

NOTE: When the phone is ringing, press **QUIET** softkey or **CLEAR** key to temporarily mute the ringer.

Ringer Melody

There are six base ringer melody choices. To change the melody:

- Press **MENU**. Scroll down to **BASE SETTINGS**, press **SELECT**. Scroll down to **RINGER MELODY**.
- Press **SELECT**. Use either scroll key to sample the melodies.
- Press **SET** to confirm your selection.



Base Menu Soft Functions

Keypad Tone (preset to ON)

Keypad tones are the beeps you hear each time you press a key on the base unit.



To turn this feature **ON** or **OFF**:

- Press **MENU**. Scroll down to **BASE SETTINGS**, press **SELECT**. Scroll down to **KEYPAD TONE**.
- Press **SELECT**. Choose **ON** or **OFF**.
- Press **SET** to confirm.



Contrast

You can adjust the contrast of the base unit's LCD screen to suit your eyes:

- Press **MENU**. Scroll down to **BASE SETTINGS**, press **SELECT**. Scroll down to **CONTRAST**.
- Press **SELECT**. Use the  and  scroll keys to lower and raise the screen's contrast.
- Press **SET** to confirm your selection.

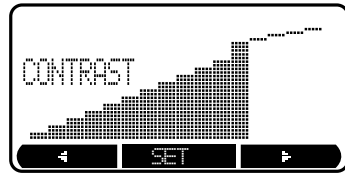

Dial Type

To change the dialing mode:

- Press **MENU**. Scroll down to **BASE SETTINGS**, press **SELECT**. Scroll down to **DIAL TYPE**.
- Press **SELECT**. Choose **TONE** or **PULSE**.
- Press **SET** to confirm.

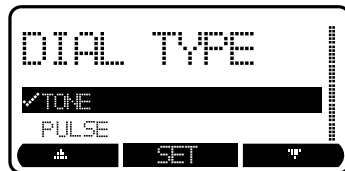

Clear Message Waiting Indicator

To manually clear the message waiting indicator:

- Press **MENU**, then scroll to **BASE SETTINGS**.
- Press **SELECT**, Scroll down to **Clear Msg Wait**.
- Press **YES** or **NO**.

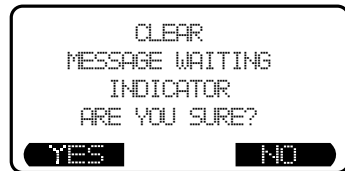

Base Menu Soft Functions

Factory Settings

If you wish to reset your i 5858 to the settings programmed at the factory:

- Press **MENU**, then scroll to **BASE SETTINGS**.
- Press **SELECT**, then scroll to **FACTORY SETTINGS**.
- Press **SELECT**, the screen will display **RESTORE FACTORY SETTINGS ARE YOU SURE?**
- Press **YES** or **NO**.

Delete Handsets

To deregister all handsets from the i 5858 base:

- Press **MENU**, then scroll to **BASE SETTINGS**.
- Press **SELECT**, then scroll to **DELETE HANDSETS**.
- Press **SELECT**. The screen will display **DELETE REGISTRATION FOR ALL HANDSETS ARE YOU SURE?** Press **YES** to deregister all handsets.

NOTE: If you choose this option, you will need to re-register the handset(s) to the i 5858 base before you can use your phone. See **Installation and Registration of Accessory Handset** on page 11-13 for instructions.

Phonebook Memory

Your i 5858 base can store up to 50 numbers with names in memory. Each memory location can hold up to 32 digits for the number and 16 characters for the name.

When prompted to **Enter Name**, use the digit keys to spell the name. Each press of a particular key causes characters to be displayed in the following order:

Number Key	Characters (in order)
1	& ' , . 1
2	A B C a b c 2
3	D E F d e f 3
4	G H I g h i 4
5	J K L j k l 5
6	M N O m n o 6
7	P Q R S p q r s 7
8	T U V t u v 8
9	W X Y Z w x y z 9
0	0
*	*
#	#

Base Menu Soft Functions

NOTE: Each system handset and the base unit can independently store names and numbers in memory. Adding, editing or deleting items stored in one unit does not affect the phonebook in any other system handset or the base.

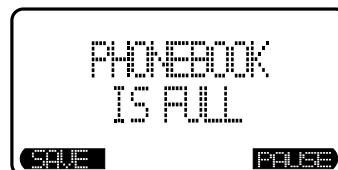
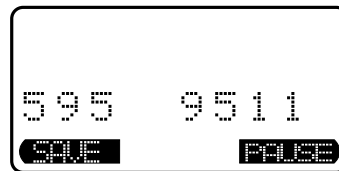

To Store a Number/Name:

- Starting from the idle screen, enter the number you want to store in memory.
- Be sure to include long distance codes and pauses (using the **PAUSE** softkey).
- Press the **SAVE** softkey.
- You will then be prompted to **Enter Name**. Use the digit keys to spell the name. If you make a mistake, press the **BACK** softkey. To enter a space press **SPACE**. When finished, press **SAVE**.
- If there is space available in memory, the entry will be saved and the base will return to pre-dial mode.
- If the memory is full, the base will display **PHONEBOOK IS FULL** and exit to pre-dial mode without saving the entry.



Base Menu Soft Functions

To Search For and Dial a Number/ Name:

- Starting from the idle screen, press the **PH BOOK** softkey to review memory contents.
- Use the  /  softkeys to scroll through the memory contents in alphabetical order.



-OR-

Press the **FIND** softkey, enter the first few characters of the name and then press **FIND** to search. If you make a mistake, press the  softkey. The closest match alphabetically will be displayed.



- Once you find the entry you want, simply press **SPEAKERPHONE** to dial the number.



To Delete a Number/Name:

- Following the first two steps in **To Search For and Dial a Number/Name**, locate the entry you want to delete.



- Press the **EDIT** softkey. The screen will display:
- Press the **DELETE** softkey. The screen will display:
- To delete this record, press **THIS**. The record will be deleted, and the next entry in the phonebook will be displayed.
- To delete all records in your phonebook memory, press **ALL**. The display will ask **ARE YOU SURE?**
- To confirm the deletion of all records, press **YES**. To exit without deleting press **NO**.



Base Menu Soft Functions

To Edit a Number

- Following the first two steps in **To Search For and Dial a Number/Name**, locate the entry you want to edit.

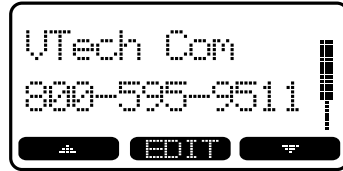

- Press the **EDIT** softkey twice. The handset will display:

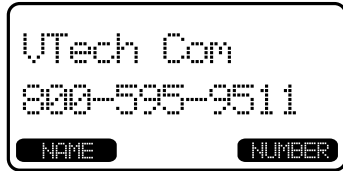

- Press **NAME** or **NUMBER**, depending on which you want to edit.

- Using the **NEXT** softkey move the cursor to the character you want to edit then enter the corrections as needed. Press **MORE** to access **SPACE** and **BACK** functions. Pressing **MORE** again will return the previous screen. When finished press the **SAVE** softkey. To exit without saving press **CLEAR**.

When finished, the screen will display the edited entry:

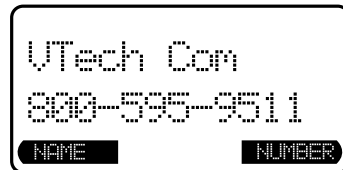

Handset and Base Operation

Making Calls

From the handset:

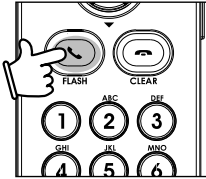

- Press /FLASH (on) or to use the handset speakerphone feature.
- Dial the phone number.
- OR-
- Dial the phone number first, then press /FLASH (on) or .
- Press /CLEAR (off) to end your call or place the handset in its base to end your call.

From the base unit:

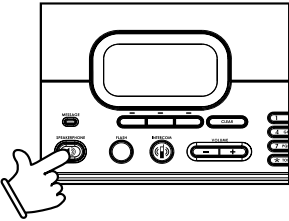

- Press .
- Dial the phone number.
- OR-
- Dial the phone number first, then press .
- Press again to end your call.

NOTE: In pre-dial mode, press **PAUSE** softkey to add pause. Press **CLEAR** to make correction. Or press and hold the **CLEAR** to delete all the input.

Answering Calls

From the handset:

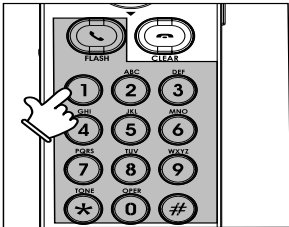

- Press /FLASH (on) or or any dialing keys.
- Press /CLEAR (off) to end your call.
- OR-
- Place the handset in its base to end your call.

From the base unit:



- Press .
- Press again to end your call.

Handset and Base Operation

Handset Volume

The volume control is on the right edge of the handset. During a call, press the + or – keys to adjust the listening volume to a comfortable level. You can adjust the volume for the headset and speakerphone this way also.

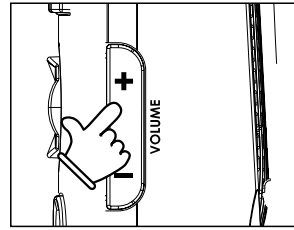

Base Speakerphone Volume

During a call simply press the volume (or speakerphone volume) keys to adjust the speakerphone volume.

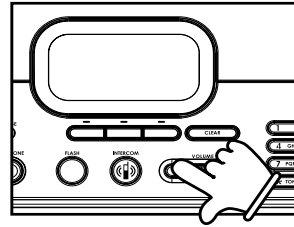

Sound Select (Handset Only)

During a call, you can adjust the quality of the sound to best suit your hearing. Pressing ◀ and ▶ NavKeys repeatedly will cycle you through four different frequency responses:

BASS - Low frequency sounds enhanced.

MID - Mid-range sounds enhanced. (This is the recommended setting for hearing aid users).

TREBLE - High frequency sounds enhanced.

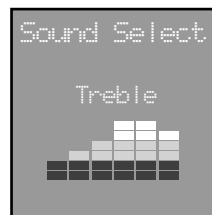
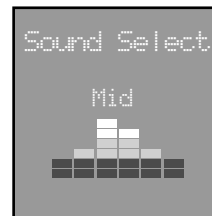
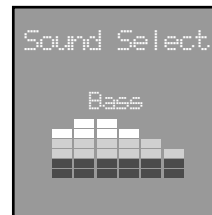

Handset and Base Operation

NATURAL - No frequency enhancement. (Your handset is preset to this selection).

NOTE: The sound select feature cannot be used when in speakerphone or headset mode.

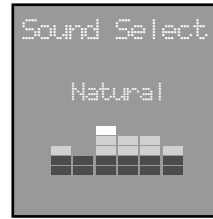

Mute Function

During an active call pressing either the **MUTE** softkey on the handset or base (when in speakerphone mode), will disable the microphone. Press **UNMUTE** to return to normal two-way conversation.

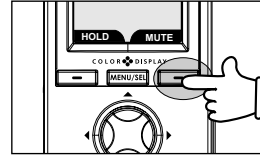

Hold Function

From the handset:

- Press the **HOLD** softkey to place a call on hold. To return to the call, press the **FLASH** (on) key.

NOTE: The handset will display **Call on Hold** when a call is placed on hold. A  will flash to remind you a call is on hold. If a call remains on hold for one minute, your **i 5858** handset will ring to remind you the call is being held. The phone will display **Call on Hold Ringback!** You have 30 seconds to return to the call before it is dropped.

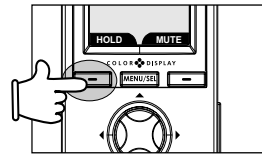

From the base:

- During an active call, press the **HOLD** softkey to place a call on hold. The **SPEAKERPHONE LED** will flash to indicate a call is on hold.
- To return to the call, press **SPEAKERPHONE**.

NOTE: If a call remains on hold for one minute, your **i 5858** base will ring to remind you the call is being held. The phone will display **CALL ON HOLD RING BACK!** You have 30 seconds to return to the call before it is dropped.

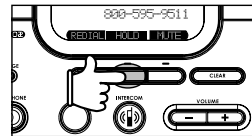

Flash Function

You can use your **i 5858** with services such as call waiting. Simply press the **FLASH** (on) key on the handset or the **FLASH** key on the base (when in speakerphone mode) to flash the line.

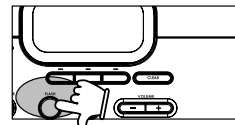
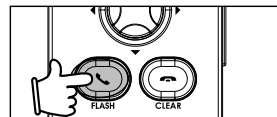

Handset and Base Operation

Intercom



From Base to ALL Handsets:

- At the base press **INTERCOM**, scroll to **GLOBAL PAGE**, then press **SELECT**.
- Each handset will display **Global Call from BASE**.
- Any handset can then answer the page, and enter intercom mode by pressing /**FLASH** (on) or any dialing keys.
- To end an intercom call, press /**CLEAR** (off) on the handset or **INTERCOM** on the base.

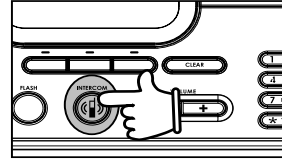

From Base to a Specific Handset:

- Press **INTERCOM**, then scroll to the handset you want to call (e.g. **HANDSET 2**). Press **SELECT**.
- Handset 2 can then answer the intercom call pressing /**FLASH** (on) or any dialing keys.
- To end an intercom call press /**CLEAR** (off) on the handset or **INTERCOM** on the base.

For handset intercom operation, please refer to **Handset Menu - Intercom** (see page 21).

Handset Speakerphone Operation

Your **i 5858** handset has a built-in handsfree speakerphone. This feature allows you to stand the handset upright on a table or desktop and have handsfree conversations. For more information, refer to **Making Calls in Handset and Base Operation** (see page 40).

Base Speakerphone Operation

The base of your **i 5858** is equipped with a speakerphone. This is a very useful feature for handsfree conversations or conference calls at the base unit. For more information, refer to **Making Calls in Handset and Base Operation** (see page 40).

Line in Use Indication

On the Handset:

When the telephone line is currently being used by **i 5858** handset or base or another phone in your home, the screen will display:





On the Base:

Similar to handset, when a **i 5858** handset or another phone in your home is in use, your **i 5858** base screen will display **LINE IN USE**.



Handset and Base Operation

Conference Calling

The **i 5858** is capable of supporting conference calls with up to three registered handsets and the base unit. To enter a conference call, simply press  /FLASH (on) or  on the handset or base. The phone icon  will be displayed in the upper middle of the handset display.





Transferring Calls

You can transfer calls on the **i 5858** system from the base to handset, handset to handset, or handset to base.



Announced Transfer

Perform an announced transfer (call and advise another extension) of an active call:

From the Handset:

- Press **HOLD** to place your call on hold.
- Press **MENUSEL**, then use  NavKey scroll to **Intercom**, press **MENUSEL** again.
- Press the  or  NavKey to the desired destination.
- Press the **MENUSEL** again.
- When the ringing handset or base answers, announce that there's an active call on hold.
- Press  /CLEAR (off) on the handset or **INTERCOM** on the base.
- Press  /FLASH (on) on the destination handset or **SPEAKERPHONE** on the destination base to pick up the call on hold.

From the Base:

- Press **HOLD** to place your call on hold.
- Press **INTERCOM**.
- Scroll to the desired destination, then press **SELECT**.
- When the ringing handset answers, announce that there's an active call on hold.
- Press  /CLEAR (off) on the handset or **INTERCOM** on the base to exit the internal call.
- Press  /FLASH (on) on the destination handset to pick up the call on hold.

Headset Operation

Your **i 5858** handset is equipped with a 2.5mm headset jack for use with an optional accessory headset for handsfree operation. If you choose to use the headset option, you must obtain an optional accessory headset that is compatible with the **i 5858**. For best results, use a VTech 2.5mm headset.

To purchase a headset, visit us on the web at www.vtechphones.com or call VTech Customer Service at 1-800-595-9511.

Once you have a compatible 2.5mm headset, locate the headset jack on the **i 5858** handset. Connect the plug on the headset cord to the jack (under a small rubber flap) on the cordless handset. The plug should fit securely. Do not force the connection.

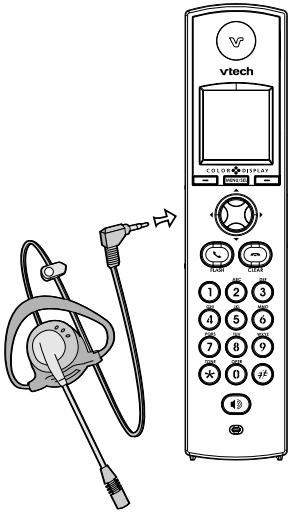

NOTE:

Whenever a compatible headset is connected to the cordless handset, the microphone on the handset will be muted. This is done to limit the effect of background noise.

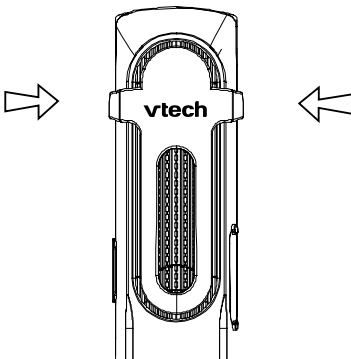

Belt Clip

The **i 5858** is also equipped with a detachable belt clip. Align the pins on the inside edge of the clip with the notches on the sides of the handset. The belt clip should snap securely into place. Do not force the connection.

Maintenance

Taking care of your telephone

Your cordless telephone contains sophisticated electronic parts, so it must be treated with care.

Avoid rough treatment

Place the handset down gently. Save the original packing materials to protect your telephone if you ever need to ship it.

Avoid water

Your telephone can be damaged if it gets wet. Do not use the handset outdoors in the rain, or handle it with wet hands. Do not install your base unit near a sink, bathtub, or shower.

Electrical storms

Electrical storms can sometimes cause power surges harmful to electronic equipment. For your own safety, use caution when using electric appliances during storms.

Cleaning your telephone

Your telephone has a durable plastic casing that should retain its luster for many years. Clean it only with a soft cloth slightly dampened with water or a mild soap. Do not use excess water or cleaning solvents of any kind.

Remember that electrical appliances can cause serious injury if used when you are wet or standing in water. If your base unit should fall into water, **DO NOT RETRIEVE IT UNTIL YOU UNPLUG THE POWER CORD AND TELEPHONE LINE CORDS FROM THE WALL.** Then pull the unit out by the unplugged cords.

In Case Of Difficulty

If you have difficulty operating your phone, the suggestions below should solve the problem. If you still have difficulty after trying these suggestions, call VTech Communications at 1-800-595-9511. In Canada, call VTech Telecommunications Canada Ltd. at 1-800-267-7377.

The phone doesn't work at all

- Make sure the power cord is plugged in.
- Make sure the telephone line cord is plugged firmly into the base unit and the telephone wall jack.
- Make sure the batteries are properly charged. If you get a **LOW BATTERY** message or indication, the batteries need charging.

No dial tone

- First try all the suggestions above.
- If you still don't hear a dial tone, disconnect the base unit from the telephone jack and connect a different phone. If there is no dial tone on that phone either, the problem is in your wiring or local service. Contact your local telephone company.

You get noise, static, or a weak signal even when you're near the base unit

- Household appliances plugged into the same circuit as the base unit can sometimes cause interference. Try moving the appliance or the base unit to another outlet.

You get noise, static, or a weak signal when you're away from the base unit

- You may be out of range. Either move closer to the base, or relocate the base unit.
- The layout of your home may be limiting the range. Try moving the base unit to another position.

The handset does not ring when you receive a call

- Make sure you have the ringer activated. Refer to the section on **Sounds - Ringer Volume** in this user's manual.
- Make sure the telephone line cord is plugged firmly into the base unit and the telephone jack. Make sure the power cord is plugged in.
- You may be too far from the base unit.
- You may have too many extension phones on your telephone line to allow all of them to ring. Try unplugging some of the other phones.

Your handset vibrates or shakes when a call comes in

- It is likely that your vibrating handset ringer option has been set to **ON**. If you'd like to turn it off, see the section on **Sounds - Ringer Vibrate** in this user's manual.

You hear other calls while using your phone

- Disconnect your base unit from the telephone jack, and plug in a regular telephone. If you still hear other calls, the problem is probably in your wiring or local service. Call your local telephone company.

In Case Of Difficulty

You hear noise in the handset, and none of the keys or buttons work

- Make sure the power cord is plugged in.

Common cure for electronic equipment

If the unit does not seem to be responding normally, then try putting the handset in the charger. If it does not seem to respond, do the following (in the order listed):

1. Disconnect the power to the base.
2. Disconnect the handset batteries, and spare batteries, and spare battery cells, if applicable.
3. Wait a few minutes.
4. Connect power to the base.
5. Re-install the batteries.
6. Wait for the handset to re-establish its link with the base. To be safe, allow up to one minute for this to take place.

Warranty Statement

What does this limited warranty cover?

- The manufacturer of this VTech product, VTech Communications, warrants to the holder of a valid proof of purchase (“Consumer” or “you”) that the product and all accessories provided by VTech in the sales package (“Product”) are free from material defects in material and workmanship, pursuant to the following terms and conditions, when installed and used normally and in accordance with operation instructions. This limited warranty extends only to the Consumer for Products purchased and used in the United States of America.

What will VTech Communications do if the Product is not free from material defects in materials and workmanship during the limited warranty period (“Materially Defective Product”)?

- During the limited warranty period, VTech’s authorized service representative will repair or replace at VTech’s option, without charge, a Materially Defective Product. If we repair this product, we may use new or refurbished replacement parts. If we choose to replace this product, we may replace it with a new or refurbished product of the same or similar design. VTech will return repaired or replacement products to you in working condition. VTech will retain defective parts, modules, or equipment.
Repair or replacement of Product, at VTech’s option, is your exclusive remedy. You should expect the repair or replacement to take approximately 30 days.

How long is the limited warranty period?

- The limited warranty period for the product extends for ONE (1) YEAR from the date of purchase if we repair or replace a Materially Defective Product under the terms of this limited warranty. This limited warranty also applies to repaired or replacement Products for a period of either (a) 90 days from the date the repaired or replacement Product is shipped to you or (b) the time remaining on the original one-year warranty; whichever is longer.

What is not covered by this limited warranty?

This limited warranty does not cover:

1. Product that has been subjected to misuse, accident, shipping or other physical damage, improper installation, abnormal operation or handling, neglect, inundation, fire, water or other liquid intrusion; or
2. Product that has been damaged due to repair, alteration or modification by anyone other than an authorized service representative of VTech; or
3. Product to the extent that the problem experienced is caused by signal conditions, network reliability or cable or antenna systems; or
4. Product to the extent that the problem is caused by use with non-VTech electrical accessories; or
5. Product whose warranty/quality stickers, Product serial numbers plates or electronic serial numbers have been removed, altered or rendered illegible; or
6. Product purchased, used, serviced or shipped for repair from outside the United States, or used for commercial or institutional purposes (including but not limited to Products used for rental purposes); or
7. Product returned without valid proof of purchase (see 2 below); or
8. Charges for installation or set up, adjustment of customer controls and installation or repair of systems outside the unit.

Warranty Statement

How do you get warranty service?

- To obtain warranty service in the United States of America, call 1-800-595-9511 for instructions regarding where to return the Product. Before calling for service, please check the user's manual. A check of the Product controls and features may save you a service call.
- Except as provided by applicable law, you assume the risk of loss or damage during transit and transportation and are responsible for delivery or handling charges incurred in the transport of Product(s) to the service location. VTech will return repaired or replaced product under this limited warranty to you, transportation, delivery or handling charges prepaid. VTech assumes no risk for damage or loss of the Product in transit.
- If the Product failure is not covered by this limited warranty, or proof of purchase does not meet the terms of this limited warranty, VTech will notify you and will request that you authorize the cost of repair prior to any further repair activity. You must pay for the cost of repair and return shipping costs for the repair of Products that are not covered by this limited warranty.

What must you return with the Product to get warranty service?

1. Return the entire original package and contents including the Product to the VTech service location along with a description of the malfunction or difficulty;
2. Include "valid proof of purchase" (sales receipt) identifying the Product purchased (Product model) and the date of purchase or receipt; and
3. Provide your name, complete and correct mailing address, and telephone number.

Other Limitations

- This warranty is the complete and exclusive agreement between you and VTech. It supersedes all other written or oral communications related to this Product. VTech provides no other warranties for this product. The warranty exclusively describes all of VTech's responsibilities regarding the product.

There are no other express warranties. No one is authorized to make modifications to this limited warranty and you should not rely on any such modification.

State Law Rights: This warranty gives you specific legal rights, and you may also have other rights which vary from state to state.

Limitations: Implied warranties, including those of fitness for a particular purpose and merchantability (an unwritten warranty that the product is fit for ordinary use) are limited to one year from date of purchase. Some states do not allow limitations on how long an implied warranty lasts, so the above limitation may not apply to you.

- In **no** event shall VTech be liable for any indirect, special, incidental, consequential, or similar damages (including, but not limited to lost profits or revenue, inability to use the product, or other associated equipment, the cost of substitute equipment, and claims by third parties) resulting from the use of this product. Some states do not allow the exclusion or limitation of incidental or consequential damages, so the above limitation or exclusion may not apply to you.

FCC, ACTA and IC Regulations

This equipment complies with Parts 15 of the Federal Communications Commission (FCC) rules for the United States. It also complies with regulations RSS210 and CS-03 of Industry and Science Canada. Operation is subject to the following two conditions: (1) this device may not cause interference, and (2) this device must accept any interference, including interference that may cause undesired operation of the device.

A label is located on the underside of the base unit containing either the FCC registration number and Ringer Equivalence Number (REN) or the IC registration number and Load Number. You must, upon request, provide this information to your local telephone company.

This equipment is compatible with inductively coupled hearing aids.

Should you experience trouble with this telephone equipment, please contact: **VTech Communications Inc. CUSTOMER SERVICE at 1-800-595-9511. In Canada, call VTech Telecommunications Canada Ltd. at 1-800-267-7377** for repair/warranty information. The telephone company may ask you to disconnect this equipment from the line network until the problem has been corrected.

FCC Part 15

Warning: Changes or modifications to this unit not expressly approved by the party responsible for compliance could void the user's authority to operate the equipment.

The equipment has been tested and found to comply with part 15 of the FCC rules. These limits are designed to provide reasonable protection against harmful interference in a residential installation. This equipment generates, uses and can radiate radio frequency energy and, if not installed and used in accordance with the instructions, may cause harmful interference to radio communications. However, there is no guarantee that interference will not occur in a particular installation. If this equipment does cause harmful interference to radio or television reception, which can be determined by turning the equipment off and on, the user is encouraged to try and correct the interference by one or more of the following measures:

- Reorient or relocate the receiving antenna.
- Increase the separation between the equipment and receiver.
- Connect the equipment into an outlet or on a circuit different from that to which he receiver is connected.
- Consult the dealer or an experienced radio/TV technician for help.

To ensure safety of users, the FCC has established criteria for the amount of radio frequency energy that can be safely absorbed by a user or bystander according to the intended usage of the product. This product has been tested and found to comply with the FCC criteria. The handset has such a low power that it does not require testing. It may be safely held against the ear of the user. The base unit shall be installed & used such that parts of the user's body other than the hands should be maintained at a comfortable distance of approximately 20 cm or more. If you choose to use a clipping device, please make sure to only use the supplied VTech belt clip.

FCC and ACTA Information

If this equipment was approved for connection to the telephone network prior to July 23, 2001, it complies with Part 68 of the Federal Communications Commission (FCC) rules. If the equipment was approved after that date, it complies with the Part 68 rules and with Technical Requirements for Connection of Equipment to the Telephone Network adopted by the Administrative Council for Terminal Attachments (ACTA). We are required to provide you with the following information.

FCC, ACTA and IC Regulations

1. Product identifier and REN information

The label on the back or bottom of this equipment contains, among other things, an identifier indicating product approval and the Ringer Equivalence Number (REN). This information must be provided to your local telephone company upon request. For equipment approved prior to July 23, 2001, the product identifier is preceded by the phrase "FCC Reg No." and the REN is listed separately. For equipment approved after that date, the product identifier is preceded by "US" and a colon (:), and the REN is encoded in the product identifier without a decimal point as the sixth and seventh characters following the colon. For example, the product identifier US:AAAEQ03T123XYZ would indicate an REN of 0.3.

The REN is used to determine how many devices you may connect to your telephone line and still have them ring when you are called. In most, but not all areas, the sum of all RENs should be five (5.0) or less. For more information, please contact your local telephone company.

2. Connection and use with the nationwide telephone network

The plug and jack used to connect this equipment to the premises wiring and the telephone network must comply with the applicable Part 68 rules and technical requirements adopted by ACTA. A compliant telephone cord and modular plug is provided with this product. It is designed to be connected to a compatible modular jack that is also compliant. An RJ11 jack should normally be used for connecting to a single line and an RJ14 jack for two lines. See Installation Instructions in this user's manual. This equipment may not be used with Coin Telephone Lines or with Party Lines. If you have specially wired alarm dialing equipment connected to your telephone line, ensure the connection of this equipment does not disable your alarm equipment. If you have questions about what will disable alarm equipment, consult your telephone company or a qualified installer.

3. Repair instructions

If this equipment is malfunctioning, it must be unplugged from the modular jack until the problem has been corrected. Repairs to this telephone equipment can only be made by the manufacturer or its authorized agents. For repair procedures, follow the instructions outlined under the Limited Warranty.

4. Rights of the telephone company

If this equipment is causing harm to the telephone network, the telephone company may temporarily discontinue your telephone service. The telephone company is required to notify you before interrupting service. If advance notice is not practical, you will be notified as soon as possible. You will be given the opportunity to correct the problem and the telephone company is required to inform you of your right to file a complaint with the FCC. Your telephone company may make changes in its facilities, equipment, operation, or procedures that could affect the proper functioning of this product. The telephone company is required to notify you if such changes are planned.

5. Hearing aid compatibility

If this product is equipped with a corded or cordless handset, it is hearing aid compatible.

6. Programming/testing of emergency numbers

If this product has memory dialing locations, you may choose to store police, fire department and emergency medical service telephone numbers in these locations. If you do, please keep three things in mind:

- a. We recommend that you also write the telephone number on the directory card, so that you can still dial the emergency number manually if the memory dialing feature doesn't work.

FCC, ACTA and IC Regulations

- b. This feature is provided only as a convenience, and the manufacturer assumes no responsibility for customer reliance upon the memory feature.
- c. Testing the emergency telephone numbers you have stored is not recommended. However, if you do make a call to an emergency number:
 - You must remain on the line and briefly explain the reason for the call before hanging up.
 - Programming/testing of emergency numbers should be performed during off-peak hours, such as in the early morning or late evening, when the emergency services tend to be less busy.

IC (Industry Canada)

This telephone is registered for use in Canada.

The term "IC:" before the radio certification number only signifies that Industry Canada technical specifications were met.

Notice: This equipment meets the applicable Industry Canada Terminal Equipment Technical Specifications. This is confirmed by the registration number. The abbreviation, IC, before the registration number signifies that registration was performed based on a Declaration of Conformity indicating that Industry Canada technical specifications were met. It does not imply that Industry Canada approved the equipment.

Notice: The Ringer Equivalence Number (REN) for this terminal equipment is 0.1. The REN assigned to each terminal equipment provides an indication of the maximum number of terminals allowed to be connected to a telephone interface. The termination on an interface may consist of any combination of devices subject only to the requirement that the sum of the Ringer Equivalence Numbers of all the devices does not exceed five. Before installing this equipment, users should ensure that it is permissible to be connected to the facilities of the local telecommunications company. The equipment must also be installed using an acceptable method of connection. The customer should be aware that compliance with the above conditions may not prevent degradation of services in some situations.

Repairs to certified equipment should be made by an authorized Canadian maintenance facility designated by the Supplier. Any repairs or alterations made by the user to this equipment, or equipment malfunctions, may give the telecommunications company cause to request the user to disconnect the equipment.

Users should ensure for their own protection that the electrical ground connections of the power utility, telephone lines and internal metallic water pipe system, if present, are connected together. This precaution may be particularly important in rural areas.

Caution: Users should not attempt to make such connections themselves, but should contact the appropriate electrical inspection authority or electrician as appropriate.

Your Cordless Phone is designed to operate at the maximum power allowed by the FCC and IC. This means your handset and base Unit can communicate only over a certain distance - which will depend on the location of the base unit and handset, weather, and the construction and layout of your home or office.

Technical Specifications

FREQUENCY CONTROL

Crystal controlled
PLL synthesizer

TRANSMIT FREQUENCY

Base: 5725-5850 MHz
Handset: 5725-5850 MHz

RECEIVE FREQUENCY

Base: 5725-5850 MHz
Handset: 5725-5850 MHz

CHANNELS

95 Channels

NOMINAL EFFECTIVE RANGE

Maximum power allowed by FCC and IC.
Actual operating range may vary
according to environmental conditions at
the time of use.

SIZE

Handset: 190mm x 42mm x 31mm
Base: 250mm x 90mm x 84mm
(including antenna)

WEIGHT

Handset: 145 grams
(excluding Battery)
Base: 463 grams

POWER REQUIREMENTS

Handset: 3 cell AAA 3.6V 800mAh
NiMH Battery
Base: 7 VDC @ 1100mA

MEMORY

Handset:

Phonebook: 100 Memory locations; up to 32
digits, 16 characters per location

Caller ID: 100 Memory locations

Base:

Phonebook: 50 Memory locations; up
to 32 digits, 16 characters per location

Caller ID: 50 Memory locations

**SPECIFICATIONS ARE TYPICAL AND
MAY CHANGE WITHOUT NOTICE.**

Table Of Contents

Important Safety Instructions	1
Introduction	3
Parts Check List	4
The Handset Layout	5
The Base Unit Layout	6
Getting Started	7
Setup	7
Connecting Power to Base Unit	7
Installation and Charge of Battery	7
Charging of the Handset Battery	8
Connecting to Phone Line	8
Checking for Dial Tone	8
Power Guard	10
Installation and Registration of Accessory Handset	11
Basic Operations	14
Handset and Base Indicators	14
Handset Icons	14
Handset LEDs	14
Base Unit Icons	15
Base LEDs	15
Handset Menu	16
Handset Main Menu	16
NavKeys(Navigation Keys)	16
Menu Shortcuts	16
Phonebook	17
Adding Phonebook Entries	17
Searching for and Dialing Phonebook Entries	19
Editing Phonebook Entries	20
Deleting Phonebook Entries	20
Call Log	21
Intercom	21
Settings	22
Sounds	23
Pictures	23
Set a Wallpaper image	23
Set an Animation image	23
Redial	24
Saving Redial Number in Phone Book Memory	24
Deleting Redial Number in Phone Book Memory	24
Recordable Ringer	25
Record a Ringer	25
Picture Download	26
Phonebook Tab Functions	27
Creating an Empty Phonebook	27
Edit a Phonebook	28
Import Contacts Into Phonebook Manager From Other Contact Manager PC Applications	28
Exporting Contacts to a Comma Separated Text File	29
Deleting Phonebook Records From the Currently Loaded Phonebook	29
Base Menu Soft Functions	30
Redial	30
Erasing Numbers in Redial Memory	30
Saving Redial Numbers in Phonebook Memory	30

Table Of Contents

Base Unit Menu	31
Calls log	32
Caller ID - Call Waiting ID	32
Reviewing Caller ID from the Base	32
Dialing from Caller ID	33
Save CID Records to Phonebook Memory	33
Deleting CID Records	33
Base Settings.....	34
Clock Setting.....	34
Ringer Volume	34
Ringer Melody	34
Keypad Tone	35
Contrast	35
Dial Type	35
Clear Message Waiting Indicator.....	35
Factory Settings.....	36
Delete Handsets.....	36
Phonebook Memory	36
To Store a Number/Name	37
To Search For and Dial a Number/Name	38
To Delete a Number/Name	38
To Edit a Number	39
Advanced Operations	40
Handset and Base Operation	40
Making Calls	40
Answering Calls	40
Handset Volume	41
Base Speakerphone Volume	41
Sound Select(handset only)	41
Mute Function.....	42
Hold Function	42
Flash Function	42
Intercom	43
Handset Speakerphone Operation	43
Base Speakerphone Operation	43
Line in Use Indication	43
Conference Calling	44
Transferring Calls	44
Announced Transfer.....	44
Additional Information	45
Headset Operation	45
Belt Clip	45
Maintenance	46
In Case of Difficulty	47
Warranty Statement	49
FCC, ACTA and IC Regulations	51
Technical Specifications	54

Index

Adding Phonebook Entries.....	17	Applications.....	28
Additional Information.....	45	Important Safety Instructions.....	1
Advanced Operations.....	40	In Case of Difficulty.....	47
Announced Transfer.....	44	Installation and Charge of Battery.....	7
Answering Calls.....	40	Installation and Registration of Accessory Handset.....	11
Base LEDs.....	15	Intercom.....	43
Base Menu Soft Functions.....	30	Intercom.....	21
Base Settings.....	34	Introduction.....	3
Base Speakerphone Operation.....	43	Keypad Tone.....	35
Base Speakerphone Volume.....	41	Line in Use Indication.....	43
Base Unit Icons.....	15	Maintenance.....	46
Base Unit Menu.....	31	Making Calls.....	40
Basic Operations.....	14	Menu Shortcuts.....	16
Belt Clip.....	45	Mute Function.....	42
Call Log.....	21	NavKeys (Navigation Keys).....	16
Caller ID - Call Waiting ID.....	32	Parts Check List.....	4
Calls log.....	32	Phonebook Memory.....	36
Charging of the Handset Battery.....	8	Phonebook Tab Functions.....	27
Checking for Dial Tone.....	8	Phonebook.....	17
Clear Message Waiting Indicator.....	35	Picture Download.....	26
Clock Setting.....	34	Pictures.....	23
Conference Calling.....	44	Power Guard.....	10
Connecting Power to Base Unit.....	7	Record a Ringer.....	25
Connecting to Phone Line.....	8	Recordable Ringer.....	25
Contrast.....	35	Redial.....	30
Creating an Empty Phonebook.....	27	Redial.....	24
Delete Handsets.....	36	Reviewing Caller ID from the Base.....	32
Deleting CID Records.....	33	Ringer Melody.....	34
Deleting Phonebook Entries.....	20	Ringer Volume.....	34
Deleting Phonebook Records From the Currently Loaded Phonebook.....	29	Save CID Records to Phonebook Memory.....	33
Deleting Redial Number in Phone Book Memory.....	24	Saving Redial Number in Phone Book Memory.....	24
Dial Type.....	35	Saving Redial Numbers in Phonebook Memory.....	30
Dialing from Caller ID.....	33	Searching for and Dialing Phonebook Entries.....	19
Edit a Phonebook.....	28	Set a Wallpaper image.....	23
Editing Phonebook Entries.....	20	Set an Animation image.....	23
Erasing Numbers in Redial Memory.....	30	Settings.....	22
Exporting Contacts to a Comma Separated Text File.....	29	Setup.....	7
Factory Settings.....	36	Sound Select (handset only).....	41
FCC, ACTA and IC Regulations.....	51	Sounds.....	23
Flash Function.....	42	Technical Specifications.....	54
Getting Started.....	7	The Base Unit Layout.....	6
Handset and Base Indicators.....	14	The Handset Layout.....	5
Handset and Base Operation.....	40	To Delete a Number/Name.....	38
Handset Icons.....	14	To Edit a Number.....	39
Handset LEDs.....	14	To Search For and Dial a Number/Name.....	38
Handset Main Menu.....	16	To Store a Number/Name.....	37
Handset Menu.....	16	Transferring Calls.....	44
Handset Speakerphone Operation.....	43	Warranty Statement.....	49
Handset Volume.....	41		
Headset Operation.....	45		
Hold Function.....	42		
Import Contacts Into Phonebook Manager From Other Contact Manager PC			



vtech

VTECH TELECOMMUNICATIONS LTD.



vtech A member of THE VTECH GROUP OF COMPANIES.

Distributed in the U.S.A. by VTech Communications, Inc. Beaverton,
Oregon, 97008

Distributed in Canada by VTech Telecommunications Canada Ltd. 7671
Alderbridge Way, Richmond, B.C. V6X 1Z9.

Copyright 2005 for VTECH TELECOMMUNICATIONS LTD.
Printed in China

91-000210-010-000
ISSUE 0



Congratulations on your purchase
of this VTech product

NEED HELP?

Our representatives are here
to help you with any questions
concerning the operation of this
product, available accessories,
or any other related issues.

Call Toll Free:

1-800-595-9511

In Canada, Call:

1-800-267-7377

or visit our website at
www.vtechphones.com