

Introduction

EXPAND YOUR i 5853, i 5866 OR i 5867 SYSTEMS. YOUR BASE WILL WORK WITH UP TO 8 HANDSETS!!!

IMPORTANT:

The **i 5807** is an Accessory Handset for use with the i 5853, i 5866 or i 5867 systems. You must have one of these Base Units in order to use the **i 5807** Accessory Handset.

This manual is designed to familiarize you with the **i 5807** Accessory Handset setup, registration and basic functions. For detailed operational instructions, please refer to your i 5853, i 5866 or i 5867 User's Manual.

Important Safety Instructions

When using your telephone equipment, basic safety precautions should always be followed to reduce the risk of fire, electric shock and injury, including the following:

1. Read and understand all instructions.
2. Follow all warnings and instructions marked on the product.
3. Unplug this product from the wall outlet before cleaning. Do not use liquid or aerosol cleaners. Use a damp cloth for cleaning.
4. Do not use this product near water (for example, near a bath tub, kitchen sink or swimming pool).
5. Do not place this product on an unstable surface, such as a table, shelf, or stand. The product may fall, causing serious damage.
6. Slots and openings in the back or bottom of the Base Unit and Handset are provided for ventilation. To protect them from overheating, these openings must not be blocked by placing the product on a soft surface such as a bed, sofa or rug. This product should never be placed near or over a radiator or heat register. This product should not be placed in any area where proper ventilation is not provided.
7. This product should be operated only from the type of power source indicated on the marking label. If you are not sure of the type of power supply in your home, consult your dealer or local power company.
8. Do not allow anything to rest on the power cord. Do not install this product where the cord may have anyone walking on it.
9. Never push objects of any kind into this product through slots in the Base or Handset as they may touch dangerous voltage points or short out parts that could result in a risk of fire or electric shock. Never spill liquid of any kind on the product.
10. To reduce the risk of electric shock, do not disassemble this product, but take it to an authorized service facility. Opening or removing parts of the Base or Handset other than specified access doors may expose you to dangerous voltages or other risks. Incorrect reassembling can cause electric shock when the product is subsequently used.
11. Do not overload wall outlets and extension cords as this can result in the risk of fire or electric shock.
12. Unplug this product from the wall outlet and refer servicing to an authorized service facility under the following conditions:
 - A. When the power supply cord or plug is damaged or frayed.
 - B. If liquid has been spilled onto the product.
 - C. If the product has been exposed to rain or water.
 - D. If the product does not operate normally by following the operating instructions. Adjust only those controls that are covered by the operating instructions, as improper adjustment of other controls may result in damage and often requires extensive work by an authorized technician to restore the product to normal operation.
 - E. If the product has been dropped and the Base and/or Handset has been damaged.



Important Safety Instructions

- F. If the product exhibits a distinct change in performance.
13. Avoid using a telephone (other than cordless) during an electrical storm. There is a remote risk of electric shock from **lighting**.
 14. Do not use the telephone to report a gas leak in the vicinity of the leak.

WARNING: Only put the Handset of your telephone next to your ear when it is in normal talk mode (off-hook). There is a potential risk of hearing damage or loss if the ringer were to go off while the Handset is next to your ear.

WARNING: To insure your safety from possible electric shock, **only** use the enclosed VTech Audio Patch Cable to record custom ring tones. Do **NOT** leave the Audio Patch Cable attached to the Handset while charging in its cradle.

Parts Check List

1. Handset
2. Belt Clip
3. Battery Cells
4. Handset Charger
5. User's Manual
6. Software CD-ROM Disc
7. Audio Patch Cable
8. USB Cable



Handset

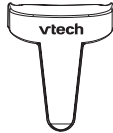

Belt Clip

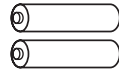

Battery Cells

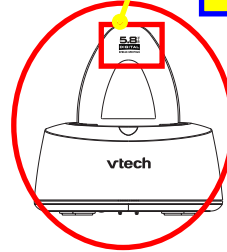

Charger

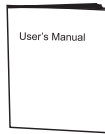

User's Manual

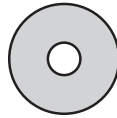
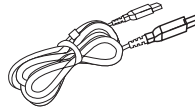

Image Editor Software



USB Cable



Audio Patch Cable

NOTE:
These comments on this page are for the the whole manual. If they are agreed here, each part with the same problems in the whole manual needs to be changed.
-- X.J. Su



The Handset Layout

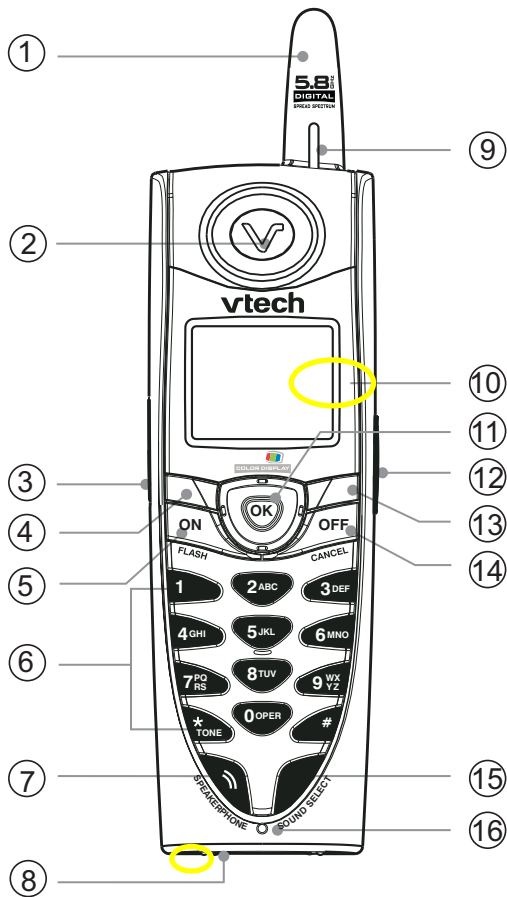

- | | |
|--|---------------------------------------|
| 1. Antenna | 9. <u>In Use/Incoming Ringing LED</u> |
| 2. Earpiece | 10. LCD Display |
| 3. Headset Jack and Audio Patch Cable Jack (2.5mm) | 11. Navigation Key (NavKey) |
| 4. Soft/Select Key | 12. Volume Keys |
| 5. On/Flash Key | 13. Softkey |
| 6. Dialing Keys (0-9, *, #) | 14. Off/Cancel Key |
| 7. Speakerphone Key | 15. Sound Select Key |
| 8. <u>USB cable jack</u> | 16. Microphone |



Setup

Connecting Power to Handset Charger

Because the **i 5807** is an accessory Handset to the **i 5853, i 5866 or i 5867**, all you need to do is choose the location for your Handset Charger, and plug in the power supply into an electrical outlet.

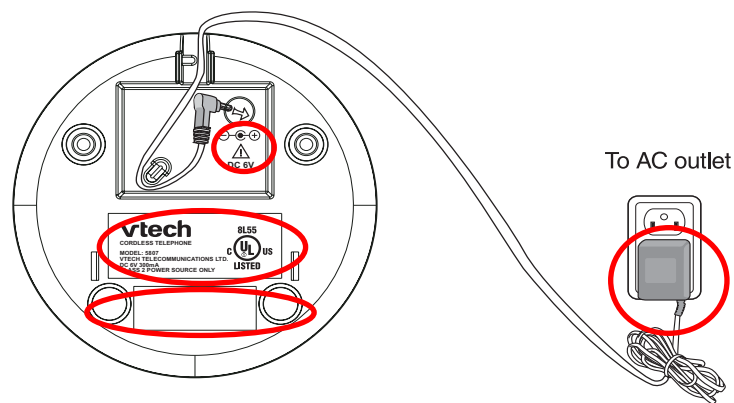

AC Adapter

Installation and Charge of Battery Cells in Handset

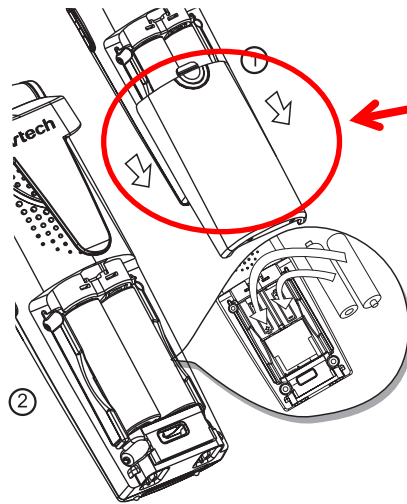

Follow these steps:

1. Place the new battery cells in the Handset with the positive and negative poles aligned in the battery compartment.
2. Replace the **battery cover** by sliding it upwards.
3. If the new battery cells are not already charged, place the Handset in its Charger or Base Unit, and allow it to charge for **10-12 hours**. After initial charge, a maintenance charge of **8 hours** should be sufficient.

Setup

Battery Life

A fully charged battery provides an average talk time of about 8 hours or standby time of 5 days.

NOTE: Talk time and standby time may vary depending on operating conditions.

Battery Indicator

Ten minutes before the battery charge level gets too low to operate the Handset, an empty battery icon will start flashing, five short tones are generated, and a **LOW BATTERY** message is displayed.

If you continue to use the Handset without charging or replacing the battery (spare battery purchased separately), the Handset will turn off automatically when the battery charge level is no longer sufficient to power up the Handset, and the call will be dropped.

Charging the Handset Battery Pack

After a low battery indication, place the Handset in the charger and make sure the **CHARGING** light turns on. With the exception of the first charge, the battery pack typically takes 8 hours to fully charge.

NOTE: If you repeatedly get a low battery indication, even after 8 hours of charging, then the battery should be replaced.

As you register additional Handsets to i 5853, i5866 or i 5867 system, they will be assigned extension numbers in the following order: **HANDSET 2, HANDSET 3, HANDSET 4**, and so forth.

Whenever a charged Handset battery pack is installed, the Handset will automatically begin **Searching For Base...** (if previously registered), or it will prompt you to **Enter Base ID** to register the new Handset.

BEFORE USING YOUR HANDSET(S), CAREFULLY PEEL OFF THE PROTECTIVE FILM, COVERING THE DISPLAY.

Registration

Registering the i 5807 Handset for the first time





After charging, the screen on the Handset will display:

If your Base Unit is model number **i 5866:**

- 1) Find the **Base ID Code** on the underside of the Base Unit.
- 2) Enter the 15-digit Base ID Code into the Handset. If you make a **mis** **take**, press the left NavKey to backspace or press the right softkey  to erase a character.
- 3) Press **OK** to complete the registration process.

If your Base Unit is model number **i 5853 or i 5867**, find the **BASE ID Code** (Base must be **OFF**) and register the Handset by:

- 1) At the Base, press **MENU**.
- 2) Scroll down to **DISPLAY BASE-ID**, then press **OK**.
- 3) Enter the 15-digit Base ID Code into the Handset. If you make a mistake, move the joystick to the left () to backspace or press the right softkey  to erase a character.
- 4) Press **OK** to complete the registration process.

NOTE: If the Handset, after charging, says “**Searching for Base...**”, press the **NEW** soft key. “**Enter Base ID**” will now be displayed. Follow the steps above. Wait approximately 15-60 seconds. You will hear confirmation beeps from the Base and Handset. The newly registered Handset will now be assigned the lowest extension number not previously assigned to a different system Handset **(1 - 6)**.

If you do not enter the correct digit sequence, you will see **Invalid Base ID!** and hear an **error** tone. Press the left NavKey to backspace or press the right softkey  to erase a character, and carefully re-enter the **Base ID Code** following the above directions.

NOTE: The 15-digit BASE ID Code may contain numbers and characters, such as *. Make sure you carefully enter all 15 digits.

Handset Indicators

Handset Icons

Icon	Description
	<p><u>Line In Use Indicator</u></p> <ul style="list-style-type: none"> On steady with one or more numbers next to it, indicating which extensions are using the line. For example, 12 indicates that Handset 1 and Handset 2 are on an outside call. Appears in idle or phone on modes to indicate a parallel set in use. It replaces phone on icon during phone on mode and parallel set is detected.
	<p><u>Handset Number Indicator</u></p> <ul style="list-style-type: none"> Indicates the Handset number. It's permanently displayed at the top left corner after the Handset has found the Base.
	<p><u>Searching for Base Indicator</u></p> <ul style="list-style-type: none"> Indicates that the Handset is still searching for the Base.
	<p><u>Intercom Indicator</u></p> <ul style="list-style-type: none"> On steady with the extension numbers currently on an intercom call. For example, 02 indicates that the Base and Handset 2 are on intercom call.
H	<p><u>Hold indicator</u></p> <ul style="list-style-type: none"> On steady when the line is on hold.
M	<p><u>Mute indicator</u></p> <ul style="list-style-type: none"> On steady when the Handset microphone is muted.
	<p><u>Ringer Off indicator</u></p> <ul style="list-style-type: none"> is displayed when the ringer is turned off.
	<p><u>Battery indicator</u></p> <ul style="list-style-type: none"> When the Handset is removed from the charger, this lets you know the level of charge in the battery pack, from FULL () to EMPTY () Cycles (Low, Medium, and Full) when Handset battery is charging. Flashes when a low battery condition is detected.
	<p><u>Answering Machine Indicator</u></p> <ul style="list-style-type: none"> Indicates that the answering machine is answering an incoming call <p>NOTE: This is only applicable to the Handset registered with the Base Answering Machine.</p>

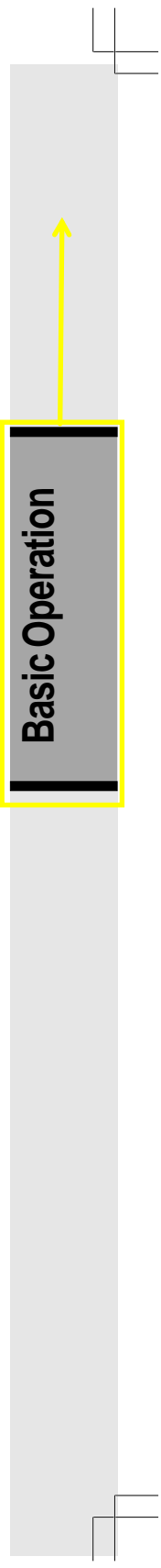

Handset Menu

Navigation Keys (NavKey):

- Press any NavKey button to display the Main Menu. Press the NavKey buttons (left, right, up and down) to navigate through menus. Press the middle NavKey to select the highlighted menu item.

Menu Shortcuts

- When viewing menu options, pressing the corresponding number on the dialing pad will automatically select that item. For example, in the Main Menu screen, pressing the 1 key will automatically take you to the Intercom menu screen, pressing the 6 key will automatically take you to the Settings menu screen, and so on through all 6 menu options.
- Similarly, when viewing a list menu, pressing the corresponding number will automatically select that option and save it, if necessary. For example, pressing the 2 key when in the Appearance screen will select and save the Green option.

Main Menu

Press any NavKey to display the 6 menu options. Then use the Navkey buttons to navigate to the desired menu option. You can also press the dialing key assigned for each icon (see information below for the assigned key numbers), to activate that menu option.

Intercom  (dialing key 1) - **Talk between Handset(s).** or use to page the cordless Handset(s).

Phonebook  (dialing key 2) - Enter and retrieve up to 50 names and phone numbers, each can be assigned a distinctive ring and image.

Calls Log  (dialing key 3) - Review Caller ID data; select and dial from the Caller ID data or from the Redial list which contains the last 10 phone numbers dialed.

Pictures  (dialing key 4) - Choose from the many preset images or download new images into the Handset to be used as your idle screen (wall paper) or assign an image to a specific phonebook directory.

Sounds & Alerts  (dialing key 5) - Record custom sound clips, turn ringer and vibrate feature on and off, select main ringer tone, turn tones (low battery, keypad, and out-of-range) on or off.

Settings  (dialing key 6) - Set the time, adjust screen contrast, reset to default settings, change color of the text, register new Handsets, change screen language.

Press the NavKeys to maneuver to the desired menu option, then press the middle NavKey to select the highlighted option. You can also press the dialing key assigned to each menu item. The top menu is assigned to dialing key 1 and so forth on down the menu.

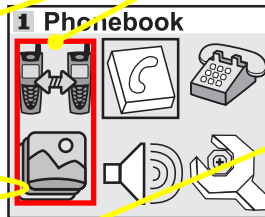

NOTE:
These comments on this page are for the whole manual. If they are agreed here, each part with the same problems in the whole manual needs to be changed.
-- X.J. Su

Handset Menu

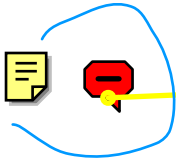

Intercom



From Handset to Handset:

- With the **Intercom** icon highlighted, press the middle NavKey or **press** the left softkey.
- Press the up or down NavKey to **navigate** to the desired Handset.
- Press the middle NavKey, left softkey or the assigned dialing key **(1-6)** to confirm.
- The ringing Handset can answer by pressing **ON** or any of the number keys.
- To end an intercom call, press **OFF** on either Handset.

1 Intercom Call
Handset 2
Handset 3
GLOBAL PAGE

Calling
Handset 2



Global Page from Handset:

- With the **Intercom** icon highlighted, press the middle NavKey or left softkey.
- Press the up or down NavKey to highlight **GLOBAL PAGE**. Press the middle NavKey, the left softkey or the * key to confirm.
- **Any registered Handset** can answer the global page, thus entering Intercom mode.
- **To end the intercom call, press OFF on either Handset.**

1 Intercom Call
Handset 2
Handset 3
GLOBAL PAGE

Performing
global page



Phonebook



With this icon highlighted, press the middle NavKey or left softkey to reveal the contents of your phonebook. If there are no entries, the screen will display **Phonebook is Empty**. The i 5807 Handset can store up to 50 numbers with names in the phonebook directory, along with a distinctive ring and image for each. Each memory location can hold up to 32 digits and up to 16 characters, including spaces.

Handset Menu

When prompted to **Enter Name**, use the digit keys to spell the name. Each press of a key will cause characters to be displayed as follows:

Number Key	Characters (in order)
1	Space & ' , - 1
2	A B C a b c 2
3	D E F d e f 3
4	G H I g h i 4
5	J K L j k l 5
6	M N O m n o 6
7	P Q R S p q r s 7
8	T U V t u v 8
9	W X Y Z w x y z 9
0	0
*	*
#	#

Adding Phonebook Entries

- From the Handset idle (**OFF**) mode, press the **NavKey in any direction**. The **Phonebook** icon should be highlighted.

Press the middle NavKey or left softkey to select.

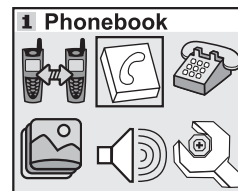

- Press **NEW**.

NOTE: When the phonebook is full and **NEW** is pressed, **Phonebook is Full** will display and an error tone will sound.

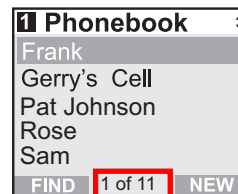

- You will then be prompted to **Enter Name**. Use the digit keys to spell the name. If you make a mistake, press the **←** softkey. To add a space between characters, press the 1 key or press the right NavKey twice. When finished, press **OK**.

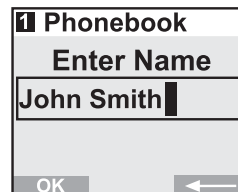

Handset Menu

- Enter the number you want to store in the Phonebook. Press and hold the # key to insert a pause. If you make a mistake, press the right softkey  . When finished, press **OK**.

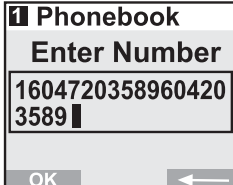

The screen will display:

NOTE: If you do not wish to assign a distinctive ring tone or image to this Phonebook entry, press **SAVE** now.

- If you wish to be alerted to calls from this phone number, you can assign a unique ring tone to this Phonebook entry. Press the up or down NavKey to scroll to **RINGER** : ◀ Default ▶.
- Press the left or right NavKey to sample the ringer options.

— OR —

- Press the middle NavKey then press the up or down NavKeys to sample the ringer options.
- Once you have selected a ringer, press **OK** to confirm.



NOTE: There are 8 traditional ring tones and 12 musical ringers. For **Recordable Ringer**, please refer to page 19 for details.

NOTE: If you do not wish to assign a distinctive image to this Phonebook entry, press **SAVE** now.

If you wish to be visually alerted to calls from this number by changing to a distinctive image, press the up or down NavKey to scroll to **PICTURE** : ◀ (none) ▶.

- Press the left or right NavKey to sample the pictures and images options.

— OR —

- Press the middle NavKey then the up or down NavKey to sample the picture and image options.
- Once you have selected an image, press **OK** to confirm.

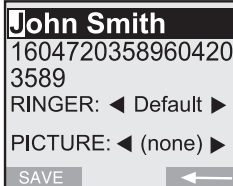
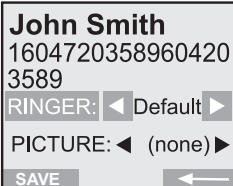
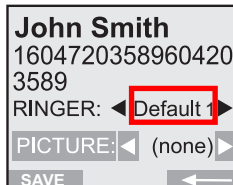

Handset Menu

NOTE: For directions on the **Picture Download** feature, please refer to page 22.

- Once you've selected a picture, press **SAVE**.
- Your phonebook entry has been saved and the screen will display:

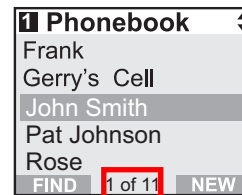

- Your phonebook entry has been saved and the screen will display:



Searching for and Dialing Phonebook Entries

- From the Handset idle (**OFF**) mode, press any NavKey. The Phonebook icon should be highlighted. Press the middle NavKey or left softkey.
- Press the up or down NavKey to scroll through the contents in alphabetical order.

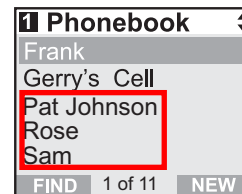

— OR —

You can enter the first characters of the name. The closest match alphabetically will be displayed:

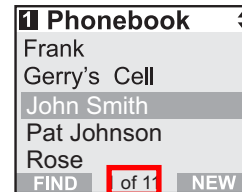

— OR —

You can press the **FIND** softkey, enter the first few characters of the name and then press **OK** to search. If you make a mistake, press the **←** softkey. The closest match alphabetically will be displayed.

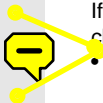

- Once you find the entry you want, simply press **ON** or **SPEAKERPHONE** to dial the number.

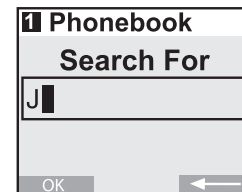

Editing Phonebook Entries

- Following the first 2 steps in **Searching for and Dialing Phonebook Entries**, locate the entry you want to edit.

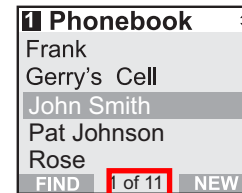

Handset Menu

- Press the middle **NavKey**. The screen will display:
- Press the **EDIT** softkey.



- Press the up or down NavKey to the option you want to edit then enter the corrections as needed. Press the softkey  to delete.

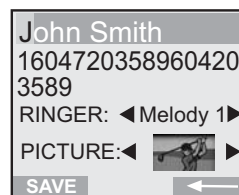

- When finished, press the **SAVE** softkey. The screen will display the edited entry.

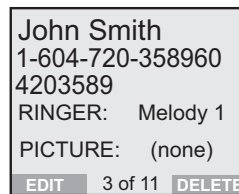

Deleting Phonebook Entries

- Following the first 2 steps in **Searching for and Dialing Phonebook Entries**, locate the entry you want to delete.

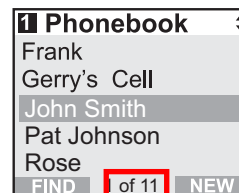

- Press the middle NavKey. The screen will display:



- Press the **DELETE** softkey. The screen will display:
- To confirm deletion, press **YES**. To exit without deleting, press **NO**.



Handset Menu

Calls Log

With this icon highlighted, press the middle NavKey or left softkey to view your Caller ID and Redial options:

Review CID Log
Clear CID Log
Review Redial
Clear Redial

Move the up or down NavKey to highlight the desired option, then press the middle NavKey or left softkey. You can also press the dialing key assigned to each menu item. The top menu is assigned to dialing key 1 and so on down the menu options.

NOTE: you can also view your Caller ID and Redial options from the Idle Menu by selecting the **REDIAL** and **CID LOG** using the softkeys.

Review CID Log (dialing key 1) - Allows you to scroll through the 50 most recent Caller ID and Call Waiting records received. With a CID record displayed, you can **SAVE** it in the phonebook, press **ON** or **SPEAKERPHONE** to dial the number, or **DELETE** the entry from the log.

Clear CID Log (dialing key 2) - Choose this option if you want to delete all CID records at once. You will be asked **Are you sure?** Choosing **YES** clears all records. Choosing **NO** returns you to the previous screen.

Review Redial (dialing key 3) - Select this option to display the last 10 numbers dialed. Use the NavKeys to highlight the desired number, press and hold the middle NavKey to view numbers that are longer than 11 digits, then press **ON** or **SPEAKERPHONE** to dial. You can press **SAVE** to save it in the Phonebook, or press **DELETE** to erase.

Clear Redial (dialing key 4) - Select this option to delete all phone numbers stored in redial memory. You will be asked **Are you sure?** Choosing **YES** clears all records. Choosing **NO** returns you to the previous screen.

Settings

With this icon highlighted, press the middle NavKey or left softkey to reveal the following menu:



Appearance (dialing key 1) - This option allows you to change the color of the text at the top and bottom of the Handset screen. Your color choices are:

Blue
Green
Tan
Rose



Handset Menu



Set Time (dialing key 2) - This option allows you to set the time to be displayed on the bottom of the idle screen. If you subscribe to Caller ID, the time will be set automatically when your first CID record is received.
NOTE: Press the number keys to change the time.



Contrast (dialing key 3) - This option allows you to adjust the Handset screen contrast.



Phone Setup (dialing key 4) - This option allows you to return the Handset to Enter Base ID mode, change the TONE/PULSE or TeleZapper options.



Language (dialing key 5, preset to English) - This option allows you to change the screen prompts to English, Spanish or French.



Reset Settings (dialing key 6) - This option allows you to return the Handset to factory preset settings. There are four options can be reset:

- Clear My Clips**
- Clear My Pictures**
- Clear Phonebook**
- Default Settings**

Choose the setting you wish to reset. You will be asked **Are you sure?** Choose **YES** to reset. Choose **NO** to return to the previous screen.

Press the NavKeys to maneuver to the desired option and make the change, or press the dialing key that is assigned to the icon.

To confirm, press the middle NavKey or the **SAVE** softkey.

Sounds & Alerts



With this icon highlighted, press the middle NavKey or left softkey to reveal the following options:



Sound Clips (dialing key 1) - This option allows you to record and access your personal melodies. See the **Recordable Ringer** section on page 19 for details.



Ringer Control (dialing key 2) - This option allows you to change the Ringer Volume, turn the Ringer **On/Off** and control the Vibrating Ringer.



Ringers (dialing key 3) - This option allows you to assign a Ring Tone. You can choose one of 8 traditional ringers or 12 musical ringers. Please refer to the **Recordable Ringer** section on page 19 for details on how to record your own personalized ringer.



Handset Menu



Low Battery Tone (dialing key 4) - This option allows you to turn the Low Battery Tone **On/Off**.



Keypad Tone (dialing key 5) - This option allows you to turn the Keypad tones **On/Off**.



Range Tone (dialing key 6) - This option allows you to turn the Range Tone **On/Off**.

Press the NavKeys to navigate to the desired option and make the change, or press the dialing key that is assigned to the icon.

For confirmation, press the middle NavKey or the **SAVE** softkey.

Pictures



Your **i 5807** Handset is preset with the following number of images:

My Pictures – 10 images
Images – 9 images
Emotions – 10 images
CD ROM – 44 images

You have the ability to assign one image as your background for the idle screen (wallpaper) or assign a specific image to a phonebook directory in the available 50 directories.

Set a Wallpaper **image**

To set a wallpaper image, select the icon **Pictures**  in the main menu. Then choose an image in one of the three menu options (**My Pictures**, **Images** or **Emotions**). Once you have selected the image, press the **SET** softkey to set the image as your wallpaper. You will receive a message on the screen confirming **"Wallpaper Set!"** and an audio confirmation.

To assign a personal image into your Handset, see the **Picture Download** section in page 22 for instructions.

NOTE: After 30 seconds of inactivity, your Handset will go into idle mode. While in idle mode, your handset will display a digital clock. To illuminate the idle screen and read the clock, simply press the volume button.

Clear a Wallpaper **image**

To **set** a wallpaper image, select the icon **Pictures**  in the main menu. Press the up or down NavKey until **Clear Wallpaper** is highlighted. Then press the middle NavKey or left softkey to clear the wallpaper.



Recordable Ringer



Record a Ringer

You can easily record a unique ringer to be used as either your Default Ringer or for a distinctive ringer assigned to a specific phonebook directory. You can record with either the provided Audio Patch Cord (not the USB cord), or with the Handset microphone. You may record up to 9 unique ringers for a maximum of 10 seconds each.

Cued-up music typically produces the best sounding recorded ringer. It is recommended to begin recording your ringer at the beginning of a song, rather than a portion from the middle to produce an audibly pleasing custom ringer.

Note: Your **i 5807** Handset is preset with many musical ringer options (i.e. Jazz, R&B, Reggae, Rock, etc) for you to use as your default ringer or a distinctive ringer. Three of them are protected, you can't replace them. You can replace the other 6 preset ringers with your own recorded ringers. You can also record your own ringers in another 3 blank locations in "My Clips". You will find 10 additional sound clips excluding those preset in the Handset on the accompanying CD-ROM.

To record a ringer, follow these steps:

- Select the **Sounds & Alerts icon**  in the Main Menu.
- Select the **Sound Clips icon** .

If you are using the Audio Patch Cord, insert the 3.5mm plug (the larger end) into the headset jack of your PC or audio source. Insert the 2.5mm plug (the smaller end) into the Headset jack on the side of the **i 5807** Handset. You can listen to the playing music through your Handset speaker after connecting the Audio Patch Cord and selecting the **Record Preview** menu option. Adjust the recording volume at the audio source. When you hear what you desire to record, press **RECORD**. If you want to use the Handset microphone to record ringers, select the **Record Clip** menu option. After the beep, and with the Handset microphone facing the audio source, start recording.

NOTE: If the memory is full, the Handset will prompt **Clip memory full!**

- Hit the **STOP** softkey to stop the recording.
- After recording, you may **PLAY** or **SAVE** the melody. If you choose **SAVE**, you will be prompted to **Enter Clip Name**. Enter a name (up to 8 characters) for the recording. If you make a mistake, press the **←** softkey to backspace. Press **SAVE** to confirm. **Clip has been saved** will display. The melody will be stored in the **My Clips** section. You can listen to all of your recorded musical ringers in **My Clips**. If you want, when in **My Clips**, you can press **DELETE** then **YES** to erase one of them.

NOTE: When you want to use the Handset microphone to record ringers, do not insert the Audio Patch Cord into the headset jack.

Using The Telezapper® Feature

General Information

The TeleZapper feature in your **i 5807** cordless telephone is a patented device that helps eliminate many of those annoying telemarketing calls.

- The TeleZapper feature in your **i 5807** covers all the telephones and answering machines connected to that phone line in your home or office.
- When you or your answering machine picks up the phone, the TeleZapper emits a special tone that fools the computer into thinking your number is disconnected.
- Instead of connecting you to a salesperson, the computer drops the call and stores your number as disconnected in its database.
- As your number is eliminated from more and more lists, those annoying computer generated calls just about stop altogether.
- The TeleZapper won't interfere with manually dialed calls, or with answering machines, Caller ID or Call Waiting features.
- Once you've activated the TeleZapper feature in your **i 5807**, keep in mind that if you answer your telephone and there's no one there, the odds are that you just "zapped" a telemarketer. After a few weeks, you'll notice that you are receiving fewer and fewer of these calls.
- The TeleZapper even works with your answering machine to "zap" telemarketers when you are away or when you prefer not to answer the phone. When your answering machine pick up a call for you, the TeleZapper emits its special tone to "zap" the telemarketer. We recommend that you re-record your message and delay speaking for a few seconds to allow time for the TeleZapper tone prior to the start of your recorded message.

Programming Instructions

The TeleZapper feature in your **i 5807** has two levels of privacy to help "zap" computer dialed telemarketing calls. Your **i 5807** is shipped with the **BASIC** level of privacy activated, which will help with the majority of telemarketing calls. At this level, the TeleZapper feature will emit a single tone, which is the first of three (3) tones for the disconnected signal. The **ADVANCED** level of privacy will switch the TeleZapper feature to all three tones of the disconnected signal and will "zap" even more telemarketing calls. To switch from **BASIC** to **ADVANCED** privacy or to disable the feature:

1. Press **PROG/CHAN**, then the ◀ key until the screen displays **TELEZAPPER=**
BAS.
2. Press **SELECT**. The current option is flashing.
3. Use ◀ or ▶ to choose **BAS**, **ADV** or **OFF**.
4. Press **SELECT** to activate the selected option.

NOTE: If you are dialing in **Pulse** (rotary) mode from another phone sharing the same line, your TeleZapper feature must be set to either **BASIC** or **OFF**.

Telezapper Q&A:

Q. How does the TeleZapper feature work?

A. The TeleZapper uses the technology of telemarketers' automatic dialing equipment against them. When you or your answering machine picks up a call, the TeleZapper emits a special tone that "fools" the computer into thinking your number is disconnected.

Using The Telezapper® Feature

Instead of connecting you to a salesperson, the computer stores your number as disconnected in its database. Over time, as your number is removed from more and more databases, you'll see a dramatic decrease in the number of annoying telemarketing calls you receive.

Q. How do I know when I've "zapped" a telemarketer?

A. If you answer your telephone and there's no one there, the odds are that you just "zapped" a telemarketer. Quite often you will see the caller ID from such a call is "unavailable." After a few weeks, you will notice that you receive fewer and fewer of these calls.

Q. Do I need one for each telephone or telephone jack in my home or office?

A. No. One **i 5807** with the TeleZapper feature covers ALL telephones and answering machines connected to the same line (telephone number). If you have two lines, you need an additional unit for your second line.

Q. Will it interfere with my computer or fax machine?

A. No. The TeleZapper does not interfere with the operation of your computer, your fax machine or other telecommunications or electronic equipment. It plays the tone briefly when the line is answered, then goes to "sleep" waiting for the next call.

Q. Will it interfere with my answering machine?

A. No. This is the best way to use your TeleZapper feature. Let your answering machine pick up the call, the TeleZapper feature "zaps" the telemarketer, and you were not bothered at all! You will need to delay your message for a few seconds to allow the tone to play. A caller who wishes to leave a message on your answering machine will hear a short tone followed by your recording.

NOTE: With your TeleZapper feature set to **ADV** (Advanced), if your answering device answers the call before you do, the answering device may not automatically stop once you've answered (if your answering device has an Auto Stop feature). You would need to press Stop on the answering device to return it to the idle, or sleep mode. With the TeleZapper set to **BAS** (Basic), your answering system's Auto Stop feature should function normally when you pick up a call.

Q. I have voicemail from the telephone company. Will it work with this?

A. Yes and No. Your telephone must go off-hook for the TeleZapper to emit its tone. As long as you pick up a call, the phone goes off-hook and the TeleZapper emits its tone to "zap" telemarketers. If, instead, the telephone company answers your calls through voicemail, your phone does not go off-hook and the TeleZapper cannot emit its tone. The TeleZapper will not interfere with the normal operation of your voicemail.

Q. Will the TeleZapper "zap" calls from anyone other than telemarketers?

A. The TeleZapper is designed to "zap" calls made by predictive dialer computers by doing two things: first, by disconnecting predictive-dialed calls before you can be connected to a live telemarketer, and, second, by deleting your phone number from telemarketing computer lists. Whether the TeleZapper will affect computer-dialed calls from other sources depends on the type of computer equipment and how that equipment is being used. Therefore, it may also "zap" calls from businesses and organizations that use predictive dialing systems – not just telemarketers. Many companies and organizations do not rely entirely on computerized calling systems to reach you. Most have secondary means in place to contact or notify people with important information. Furthermore, these organizations can always contact you by simply dialing your phone number manually. Manually dialed calls will not be zapped. As such, you can contact businesses and organizations to determine if they use predictive dialers and, if so, to ask that your phone number be manually dialed or that alternate means be used in order to contact you.

Picture Download

Download Your Own Image

Do you have a favorite image stored in your personal computer that you would like to use as your **i 5807** Handset wallpaper or to assign to one of your 50 available phonebook directories? Using the provided Image Editor Software, you can view and convert your image. Once you have selected your file and viewed your image in the software, use the included USB cord to send the converted image directly into the Handset. You'll start by downloading the software into your **computer**:

ONE-TIME SOFTWARE INSTALLATION



1. Insert the enclosed Image Editor Tool CD into your personal computer.
2. You will see a pop-up window giving you three options:
 - a. Install/Uninstall the Image Editor Software.
 - b. Browse the installation CD.
 - c. Visit Vtech on the web.
 To install the software, click on the **Install/Uninstall the Image Editor Software** icon  and follow the download instructions.
3. After the installation process is complete, you will find a **Image Editor Software** icon  on your PC desktop. Click on this icon to run the Image Editor software.

Image Download

Once you have installed the software, follow these steps to view and convert your selected image.

- Click on the **OPEN**  icon. Then the pictures in the accompanied CD-ROM Disc can be found automatically. Or navigate to the directory where your desired image file is stored, and open the file.
- You will see your image displayed in the middle of the screen and inside the telephone display on the right. You can select the following options to edit your image:



- Zoom In and Zoom Out



- Rotate Left and Rotate Right



- Adjust Brightness and Contrast



- Adjust Color

Picture Download

- Before downloading your image, make sure that the provided USB cord is correctly installed into your computer (using the large connector) and Handset (using the small connector). After you have completed the image editing process, press **Send to Phone** (⬇️) and your image will be downloaded into the Handset. Within a few seconds, you will see the new image displayed on your Handset and it will be saved in your **My Pictures** directory. You have the option to either **SET** (set the picture to be wallpaper) or **DELETE** the downloaded image. You can store a total of 14 images in the **My Pictures** directory. You can delete the preset images in this directory to make room for more if you wish. Additional image samples can be found on the accompanying CD-ROM.

NOTE: Do not leave the USB cord connected to the Handset for an extended period of time. This will drain the battery.

NOTE: All preset images in **My Pictures** can be deleted and replaced by new ones. You can record a total of 14 images in **My Pictures**.

Handset Operation

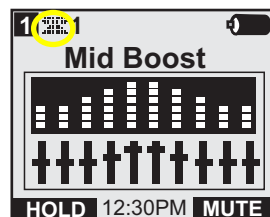
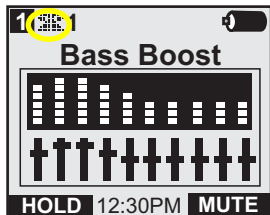
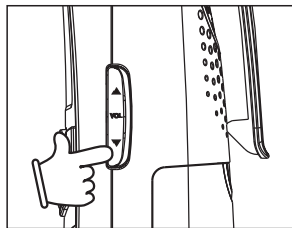
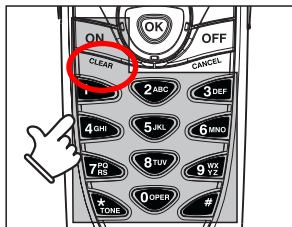
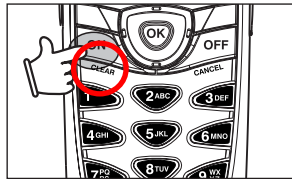

Making Calls



- Press **ON** (or, **SPEAKERPHONE**) to use the Handset Speakerphone feature). Dial the phone number.

-OR-

- Dial the phone number first; then press **ON** (or **SPEAKERPHONE**).
- Press **OFF** or place the Handset in the charger cradle to end your call.

Answering Calls

- Press **ON**, **SPEAKERPHONE** or any of number keys.
- Press **OFF** or place the Handset in the charger cradle to end your call.

Adjust the Handset Volume

The volume control is on the **right** edge of the Handset. During a call, press the ▲ or ▼ key to adjust the listening volume to a comfortable level. The procedure is the same for the Handset ear-piece, Headset and Speakerphone.

NOTE: Also use the volume ▲ or ▼ keys to illuminate and view the Handset clock feature when in idle (**OFF**) mode.

Sound Select

During a call, you can adjust the quality of the sound to best suit your hearing. Pressing **SOUND SELECT** repeatedly will cycle you through four different frequency options:

BASS - Low Frequency sounds enhanced.

MID - Mid-Range sounds enhanced (This is the recommended setting for hearing aid users).

Handset Operation

TREBLE - High Frequency sounds enhanced.

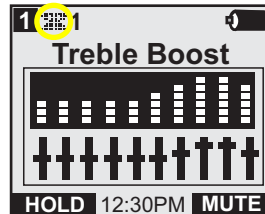

NATURAL - No frequency enhancement (Your Handset is preset to this selection).

The Handset will graphically display these four modes.

NOTE: The Sound Select feature cannot be used when in Speakerphone or Headset talk mode.

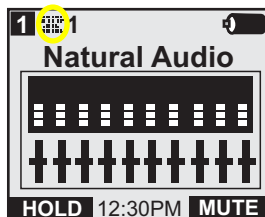

Mute Function

During an active call pressing the **MUTE** softkey on the Handset, will disable the microphone. Press **MUTE** again to return to normal two-way conversation.

Hold Function:

Press the **HOLD** softkey to place a call on hold. To return to the call, press the **ON** (or **SPEAKER PHONE**) key.

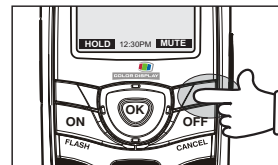

NOTE: The Handset will display **CALL ON HOLD** when a call is placed on hold. If you have new calls in call log, **CALL ON HOLD** will display alternately. An **H** will be displayed to remind you a call is on hold. If a call remains on hold for 5 minutes, your **i 5807** Handset will ring to remind you the call is being held. The phone will display **Call On Hold Ring Back!** You have 30 seconds to return to the call before it is dropped.

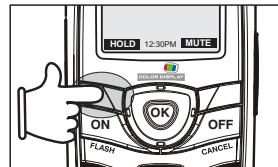

Flash Function

You can use your **i 5807** with services such as Call Waiting. Simply press the **ON/FLASH** key on the Handset to flash the line.

Handset Operation

Handset Locator (from Base):

Press the **PAGE** button from the Base Unit to page all Handsets. Each Handset will beep for 20 seconds to alert you to their locations. To stop the beeping, press ON or any dial pad button on the Handset, or PAGE on the Base Unit.

Handset Speakerphone Operation

Your **i 5807** Handset has a built-in handsfree speakerphone. This feature allows you to stand the Handset upright on a table or desktop and have handsfree conversations. For more information, refer to **Making Calls** in the **Handset Operation** section.

Line in Use Indication

When the telephone line is currently being used by a Handset from the **i 5807** system, a status message similar to this will display on idle Handset(s):

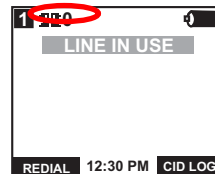

When the telephone line is currently being used by another phone (other than the **i 5807** system), the phone icon will remain on steadily, and **EXTENSION IN USE** will be displayed:

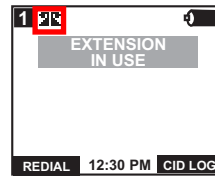

Conference Calling

The **i 5807** is capable of supporting conference calls with up to two registered Handsets. To enter a conference call, simply access the line with two extensions by pressing **ON** (or **SPEAKERPHONE**) on the Handsets. The phone icon and two extension numbers will be displayed in the upper left corner of the Handset displays.

Transferring Calls

You can transfer calls on the **i 5807** system from Handset to Handset in two ways.

Blind Transfer

You can directly transfer any active call to another **i 5807** extension without notification by following these steps:

- Press the middle NavKey then press the up or down NavKey to the desired location.
- Press the middle NavKey to confirm.
- The ringing Handset can pick up the transferred call just like any incoming call.

Announced Transfer

You can perform an announced transfer (call and advise another extension) of an active call by following these steps:

- Press **HOLD** to place the call on hold.
- Press any NavKey then press the left NavKey to select **Intercom**, press the **OK** key to confirm.

-OR-

- Press any NavKey then press the **1** key.
- Press the up or down NavKey to the desired location.

Handset Operation

- Press the middle NavKey to confirm.
- When the ringing Handset answers, announce that there's an active call on hold.
- Press **OFF** on either handset.
- Press **ON** (on the destination Handset) to pick up the call on hold.

Headset Operation

Your **i 5807** Handset is equipped with a 2.5mm Headset Jack for use with an optional accessory Headset for handsfree operation. If you choose to use the Headset option, you must obtain an optional accessory Headset, which is compatible with the **i 5807**. For best results, use a VTech 2.5mm headset.

To purchase a Headset, call VTech Customer Service at 1-800-595-9511.

Once you have a compatible 2.5mm Headset, locate the Headset Jack on the **i 5807** Handset. Connect the plug on the Headset cord to the jack (under a small rubber flag) on the cordless Handset. The plug should fit securely. Do not force the connection.

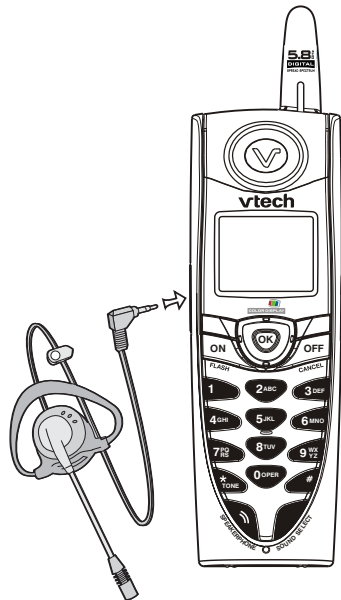

NOTE:

Whenever a compatible Headset is connected to the cordless Handset, the microphone on the Handset will be muted. This is done to limit the effect of background noise.

Many compatible Headsets have a reversible, monaural design. This means you can wear your Headset on either ear, leaving one ear free for other conversations.

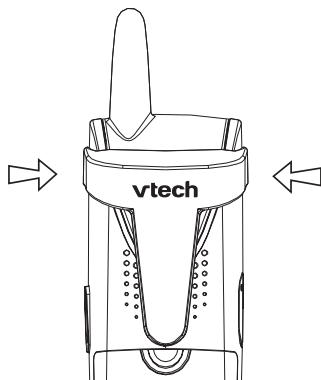

Belt Clip

The **i 5807** is also equipped with a detachable belt clip. Align the pins on the inside edge of the clip with the notches on the sides of the Handset. The belt clip should snap securely into place. Do not force the connection.

Maintenance

Taking care of your telephone

Your cordless telephone contains sophisticated electronic parts, so it must be treated with care.

Avoid rough treatment

Place the Handset down gently. Save the original packing materials to protect your telephone if you ever need to ship it.

Avoid water

Your telephone can be damaged if it gets wet. Do not use the Handset outdoors in the rain, or handle it with wet hands. Do not install your Base Unit near a sink, bathtub, or shower.

Electrical storms

Electrical storms can sometimes cause power surges harmful to electronic equipment. For your own safety, use caution when using electric appliances during storms.

Cleaning your telephone

Your telephone has a durable plastic casing that should retain its luster for many years. Clean it only with a soft cloth slightly dampened with water or a mild soap. Do not use excess water or cleaning solvents of any kind.

Remember that electrical appliances can cause serious injury if used when you are wet or standing in water. If your Base Unit should fall into water, **DO NOT RETRIEVE IT UNTIL YOU UNPLUG THE POWER CORD AND TELEPHONE LINE CORDS FROM THE WALL.** Then pull the unit out by the unplugged cords.

In Case Of Difficulty

If you have difficulty operating your phone, the suggestions below should solve the problem. If you still have difficulty after trying these suggestions, call VTech Communications at 1-800-595-9511. In Canada, call VTech Telecommunications Canada Ltd. at 1-800-267-7377.

The phone doesn't work at all

- Make sure the Power Cord is plugged in.
- Make sure the telephone line cord is plugged firmly into the Base Unit and the telephone wall jack.
- Make sure the batteries are properly charged. If you get a 'LOW BATTERY' message or indication, the battery cells need charging.

No dial tone

- First try all the suggestions above.
- If you still don't hear a dial tone, disconnect the Base Unit from the telephone jack and connect a different phone. If there is no dial tone on that phone either, the problem is in your wiring or local service. Contact your local telephone company.

You get noise, static, or a weak signal even when you're near the Base Unit

- Household appliances plugged into the same circuit as the Base Unit can sometimes cause interference. Try moving the appliance or the Base Unit to another outlet.

You get noise, static, or a weak signal when you're away from the Base Unit

- You may be out of range. Either move closer to the Base, or relocate the Base Unit.
- The layout of your home may be limiting the range. Try moving the Base Unit to another position.

The Handset does not ring when you receive a call

- Make sure you have the ringer activated. Refer to the section(s) on **Sounds & Alerts - Ringer Control** in this User's Manual.
- Make sure the telephone line cord is plugged firmly into the Base Unit and the telephone jack. Make sure the power cord is plugged in.
- You may be too far from the Base Unit.
- You may have too many extension phones on your telephone line to allow all of them to ring. Try unplugging some of the other phones.

Your Handset vibrates or shakes when a call comes in

- It is likely that your Vibrating Handset Ringer option has been set to **ON**. If you'd like to turn it off, see the section on **Sounds & Alerts - Ringer Control** in this User's manual.

In Case Of Difficulty

You hear other calls while using your phone

- Disconnect your Base Unit from the telephone jack, and plug in a regular telephone. If you still hear other calls, the problem is probably in your wiring or local service. Call your local telephone company.

You hear noise in the Handset, and none of the keys or buttons work

- Make sure the power cord is plugged in.

Common cure for electronic equipment

If the unit does not seem to be responding normally, then try putting the Handset in the cradle. If it does not seem to respond, do the following (in the order listed):

1. Disconnect the power to the Base.
2. Disconnect the Handset battery cells and spare battery compartment's battery cells, if applicable.
3. Wait a few minutes.
4. Connect power to the Base.
5. Re-install the battery cells.
6. Wait for the Handset to re-establish its link with the Base. To be safe, allow up to one minute for this to take place.

Warranty Statement

What does this limited warranty cover?

- The manufacturer of this VTech product, VTech Communications, warrants to the holder of a valid proof of purchase (“Consumer” or “you”) that the product and all accessories provided by VTech in the sales package (“Product”) are free from material defects in material and workmanship, pursuant to the following terms and conditions, when installed and used normally and in accordance with operation instructions. This limited warranty extends only to the Consumer for Products purchased and used in the United States of America.

What will VTech Communications do if the Product is not free from material defects in materials and workmanship during the limited warranty period (“Materially Defective Product”)?

- During the limited warranty period, VTech’s authorized service representative will repair or replace at VTech’s option, without charge, a Materially Defective Product. If we repair this product, we may use new or refurbished replacement parts. If we choose to replace this product, we may replace it with a new or refurbished product of the same or similar design. VTech will return repaired or replacement products to you in working condition. VTech will retain defective parts, modules, or equipment. Repair or replacement of Product, at VTech’s option, is your exclusive remedy. You should expect the repair or replacement to take approximately 30 days.

How long is the limited warranty period?

- The limited warranty period for the product extends for ONE (1) YEAR from the date of purchase if we repair or replace a Materially Defective Product under the terms of this limited warranty. This limited warranty also applies to repaired or replacement Products for a period of either (a) 90 days from the date the repaired or replacement Product is shipped to you or (b) the time remaining on the original one-year warranty; whichever is longer.

What is not covered by this limited warranty?

This limited warranty does not cover:

1. Product that has been subjected to misuse, accident, shipping or other physical damage, improper installation, abnormal operation or handling, neglect, inundation, fire, water or other liquid intrusion; or
2. Product that has been damaged due to repair, alteration or modification by anyone other than an authorized service representative of VTech; or
3. Product to the extent that the problem experienced is caused by signal conditions, network reliability or cable or antenna systems; or
4. Product to the extent that the problem is caused by use with non-VTech electrical accessories; or
5. Product whose warranty/quality stickers, Product serial numbers plates or electronic serial numbers have been removed, altered or rendered illegible; or
6. Product purchased, used, serviced or shipped for repair from outside the United States, or used for commercial or institutional purposes (including but not limited to Products used for rental purposes); or
7. Product returned without valid proof of purchase (see 2 below); or
8. Charges for installation or set up, adjustment of customer controls and installation or repair of systems outside the unit.

Warranty Statement

How do you get warranty service?

- To obtain warranty service in the United States of America, call 1-800-595-9511 for instructions regarding where to return the Product. Before calling for service, please check the user's manual. A check of the Product controls and features may save you a service call.
- Except as provided by applicable law, you assume the risk of loss or damage during transit and transportation and are responsible for delivery or handling charges incurred in the transport of Product(s) to the service location. VTech will return repaired or replaced product under this limited warranty to you, transportation, delivery or handling charges prepaid. VTech assumes no risk for damage or loss of the Product in transit.
- If the Product failure is not covered by this limited warranty, or proof of purchase does not meet the terms of this limited warranty, VTech will notify you and will request that you authorize the cost of repair prior to any further repair activity. You must pay for the cost of repair and return shipping costs for the repair of Products that are not covered by this limited warranty.

What must you return with the Product to get warranty service?

1. Return the entire original package and contents including the Product to the VTech service location along with a description of the malfunction or difficulty;
2. Include "valid proof of purchase" (sales receipt) identifying the Product purchased (Product model) and the date of purchase or receipt; and
3. Provide your name, complete and correct mailing address, and telephone number.

Other Limitations

- This warranty is the complete and exclusive agreement between you and VTech. It supersedes all other written or oral communications related to this Product. VTech provides no other warranties for this product. The warranty exclusively describes all of VTech's responsibilities regarding the product.

There are no other express warranties. No one is authorized to make modifications to this limited warranty and you should not rely on any such modification.

State Law Rights: This warranty gives you specific legal rights, and you may also have other rights which vary from state to state.

Limitations: Implied warranties, including those of fitness for a particular purpose and merchantability (an unwritten warranty that the product is fit for ordinary use) are limited to one year from date of purchase. Some states do not allow limitations on how long an implied warranty lasts, so the above limitation may not apply to you.

- In no event shall VTech be liable for any indirect, special, incidental, consequential, or similar damages (including, but not limited to lost profits or revenue, inability to use the product, or other associated equipment, the cost of substitute equipment, and claims by third parties) resulting from the use of this product. Some states do not allow the exclusion or limitation of incidental or consequential damages, so the above limitation or exclusion may not apply to you.

FCC, ACTA and IC Regulations

This equipment complies with Parts 15 of the Federal Communications Commission (FCC) rules for the United States. It also complies with regulations RSS210 and CS-03 of Industry and Science Canada. Operation is subject to the following two conditions: (1) this device may not cause interference, and (2) this device must accept any interference, including interference that may cause undesired operation of the device.

A label is located on the underside of the Base Unit containing either the FCC registration number and Ringer Equivalence Number (REN) or the IC registration number and Load Number. You must, upon request, provide this information to your local telephone company.

This equipment is compatible with inductively coupled hearing aids.

Should you experience trouble with this telephone equipment, please contact: **VTech Communications Inc. CUSTOMER SERVICE at 1-800-595-9511. In Canada, call VTech Telecommunications Canada Ltd. at 1-800-267-7377** for repair/warranty information. The telephone company may ask you to disconnect this equipment from the line network until the problem has been corrected.

FCC Part 15

Warning: Changes or modifications to this unit not expressly approved by the party responsible for compliance could void the user's authority to operate the equipment.

The equipment has been tested and found to comply with part 15 of the FCC rules. These limits are designed to provide reasonable protection against harmful interference in a residential installation. This equipment generates, uses and can radiate radio frequency energy and, if not installed and used in accordance with the instructions, may cause harmful interference to radio communications. However, there is no guarantee that interference will not occur in a particular installation. If this equipment does cause harmful interference to radio or television reception, which can be determined by turning the equipment off and on, the user is encouraged to try and correct the interference by one or more of the following measures:

- Reorient or relocate the receiving antenna.
- Increase the separation between the equipment and receiver.
- Connect the equipment into an outlet or on a circuit different from that to which the receiver is connected.
- Consult the dealer or an experienced radio/TV technician for help.

To ensure safety of users, the FCC has established criteria for the amount of radio frequency energy that can be safely absorbed by a user or bystander according to the intended usage of the product. This product has been tested and found to comply with the FCC criteria. The handset has such a low power that it does not require testing. It may be safely held against the ear of the user. The base unit shall be installed & used such that parts of the user's body other than the hands should be maintained at a comfortable distance of approximately 20 cm or more.

FCC and ACTA Information

If this equipment was approved for connection to the telephone network prior to July 23, 2001, it complies with Part 68 of the Federal Communications Commission (FCC)

FCC, ACTA and IC Regulations

rules. If the equipment was approved after that date, it complies with the Part 68 rules and with Technical Requirements for Connection of Equipment to the Telephone Network adopted by the Administrative Council for Terminal Attachments (ACTA). We are required to provide you with the following information.

1. Product identifier and REN information

The label on the back or bottom of this equipment contains, among other things, an identifier indicating product approval and the Ringer Equivalence Number (REN). This information must be provided to your local telephone company upon request. For equipment approved prior to July 23, 2001, the product identifier is preceded by the phrase "FCC Reg No." and the REN is listed separately. For equipment approved after that date, the product identifier is preceded by "US" and a colon (:), and the REN is encoded in the product identifier without a decimal point as the sixth and seventh characters following the colon. For example, the product identifier US:AAAEQ03T123XYZ would indicate an REN of 0.3.

The REN is used to determine how many devices you may connect to your telephone line and still have them ring when you are called. In most, but not all areas, the sum of all RENs should be five (5.0) or less. For more information, please contact your local telephone company.

2. Connection and use with the nationwide telephone network

The plug and jack used to connect this equipment to the premises wiring and the telephone network must comply with the applicable Part 68 rules and technical requirements adopted by ACTA. A compliant telephone cord and modular plug is provided with this product. It is designed to be connected to a compatible modular jack that is also compliant. An RJ11 jack should normally be used for connecting to a single line and an RJ14 jack for two lines. See Installation Instructions in this user's manual. This equipment may not be used with Coin Telephone Lines or with Party Lines. If you have specially wired alarm dialing equipment connected to your telephone line, ensure the connection of this equipment does not disable your alarm equipment. If you have questions about what will disable alarm equipment, consult your telephone company or a qualified installer.

3. Repair instructions

If this equipment is malfunctioning, it must be unplugged from the modular jack until the problem has been corrected. Repairs to this telephone equipment can only be made by the manufacturer or its authorized agents. For repair procedures, follow the instructions outlined under the Limited Warranty.

4. Rights of the telephone company

If this equipment is causing harm to the telephone network, the telephone company may temporarily discontinue your telephone service. The telephone company is required to notify you before interrupting service. If advance notice is not practical, you will be notified as soon as possible. You will be given the opportunity to correct the problem and the telephone company is required to inform you of your right to file a complaint with the FCC. Your telephone company may make changes in its facilities, equipment, operation, or procedures that could affect the proper functioning of this product. The telephone company is required to notify you if such changes are planned.

FCC, ACTA and IC Regulations

5. Hearing aid compatibility

If this product is equipped with a corded or cordless handset, it is hearing aid compatible.

6. Programming/testing of emergency numbers

If this product has memory dialing locations, you may choose to store police, fire department and emergency medical service telephone numbers in these locations. If you do, please keep three things in mind:

- a. We recommend that you also write the telephone number on the directory card, so that you can still dial the emergency number manually if the memory dialing feature doesn't work.
- b. This feature is provided only as a convenience, and the manufacturer assumes no responsibility for customer reliance upon the memory feature.
- c. Testing the emergency telephone numbers you have stored is not recommended. However, if you do make a call to an emergency number:
 - You must remain on the line and briefly explain the reason for the call before hanging up.
 - Programming/testing of emergency numbers should be performed during off-peak hours, such as in the early morning or late evening, when the emergency services tend to be less busy.

IC (Industry Canada)

This telephone is registered for use in Canada.

The term "IC:" before the radio certification number only signifies that Industry Canada technical specifications were met.

Notice: This equipment meets the applicable Industry Canada Terminal Equipment Technical Specifications. This is confirmed by the registration number. The abbreviation, IC, before the registration number signifies that registration was performed based on a Declaration of Conformity indicating that Industry Canada technical specifications were met. It does not imply that Industry Canada approved the equipment.

Notice:

The Ringer Equivalence Number (REN) for this terminal equipment is 0.1. The REN assigned to each terminal equipment provides an indication of the maximum number of terminals allowed to be connected to a telephone interface. The termination on an interface may consist of any combination of devices subject only to the requirement that the sum of the Ringer Equivalence Numbers of all the devices does not exceed five.

Before installing this equipment, users should ensure that it is permissible to be connected to the facilities of the local telecommunications company. The equipment must also be installed using an acceptable method of connection. The customer should be aware that compliance with the above conditions may not prevent degradation of services in some situations.

Repairs to certified equipment should be made by an authorized Canadian maintenance facility designated by the Supplier. Any repairs or alterations made by the user to this equipment, or equipment malfunctions, may give the telecommunications company cause to request the user to disconnect the equipment.



FCC, ACTA and IC Regulations

Users should ensure for their own protection that the electrical ground connections of the power utility, telephone lines and internal metallic water pipe system, if present, are connected together. This precaution may be particularly important in rural areas.

Caution:

Users should not attempt to make such connections themselves, but should contact the appropriate electrical inspection authority or electrician as appropriate.

Your Cordless Phone is designed to operate at the maximum power allowed by the FCC and IC. This means your Handset and Base Unit can communicate only over a certain distance - which will depend on the location of the Base Unit and Handset, weather, and the construction and layout of your home or office.

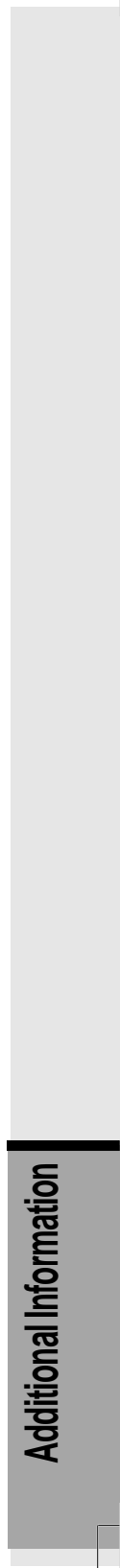

Additional Information



Technical Specifications

FREQUENCY CONTROL

Crystal controlled
PLL synthesizer

TRANSMIT FREQUENCY

Base: 5725-5850 MHz
Handset: 2400-2483.5 MHz

RECEIVE FREQUENCY

Base: 2400-2483.5 MHz
Handset: 5725-5850 MHz

CHANNELS

95 Channels

NOMINAL EFFECTIVE RANGE

Maximum power allowed by FCC and IC. Actual operating range may vary according to environmental conditions at the time of use.

SIZE

Handset: 197mm x 53mm x 40mm
(including antenna)
Charger: 85.0mm x 85.0mm x
86.5mm

WEIGHT

Handset: 164 grams
(excluding battery pack)
Charger: 207 grams

POWER REQUIREMENTS

Handset: 2 cell AA 1.2V 1400mAh
← NiMH Battery

Charger: 6VDC @300mA

MEMORY

Phone Book: 50 Memory locations;
up to 32 digits, 16 characters per
location
CID: 50 Memory locations

**SPECIFICATIONS ARE
TYPICAL AND MAY CHANGE
WITHOUT NOTICE.**



vtech

VTECH TELECOMMUNICATIONS LTD.

A member of THE VTECH GROUP OF COMPANIES.

Distributed in the U.S.A. by VTech Communications (Inc.);
Beaverton, Oregon, 97008

Distributed in Canada by VTech Telecommunications Canada
Ltd., 200-7671 Alderbridge Way, Richmond, B.C. V6X 1Z9.

Copyright 2004 for VTECH TELECOMMUNICATIONS LTD.
Printed in China

91-5631-10-00
ISSUE 0



Table of Contents

Introduction	1
Important Safety Instructions	2
Getting Started	4
Parts Check List.....	4
The Handset Layout.....	5
Setup.....	6
Registration.....	8
Basic Operation	9
Handset Indicators.....	9
Handset Menu.....	10
Navigation Keys.....	10
Menu Shortcuts.....	10
Main Menu.....	10
Intercom.....	11
Phonebook.....	11
Calls Log.....	16
Settings.....	16
Sounds & Alerts.....	17
Pictures.....	18
Recordable Ringer.....	19
Using The Telezapper® Feature.....	20
Pictures Download.....	22
Advance Operation	24
Handset Operation.....	24
Making Calls.....	24
Answering Calls.....	24
Adjust the Handset Volume.....	24
Sound Select.....	24
Mute Function.....	25
Hold Function.....	25
Flash Function.....	25
Conference Calling.....	26
Transferring Calls.....	26
Blind Transfer.....	26
Announced Transfer.....	26
Additional Information	28
Headset Operation.....	28
Maintenance.....	29
In Case Of Difficulty.....	30
Warranty Statement.....	32
FCC, ACTA and IC Regulations.....	34
Technical Specifications.....	38

