



**ISU 128**  
**128 kbps ISDN Service Unit**  
**USER MANUAL**

**Part Numbers**

1202029L2	115 VAC
1202029L3	115 VAC with V.34 Modem Option

61202.029L2-1D  
January 1998

**Trademarks:**

DMS-100 is a trademark of Northern Telecom.

ISU is trademark of ADTRAN, Incorporated.

Macintosh is a registered trademark of Apple Computer, Incorporated.

Stac is a registered trademark and LZS is a trademark of Stac Electronics.

Windows is a registered trademark of Microsoft Corporation.

5ESS is a registered trademark of AT&T.

Windows<sup>®</sup> 95 is a registered trademark of Microsoft Corporation.

MNP<sup>®</sup> is a registered trademark of Microcom, Incorporated.



901 Explorer Boulevard  
P.O. Box 140000  
Huntsville, AL 35814-4000  
Phone: (205) 963-8000

© 1998 ADTRAN, Inc.  
All rights reserved.  
Printed in USA.

**FCC regulations require that the following information be provided to the customer in this manual.**

1. If your telephone equipment ( ISU 128) causes harm to the telephone network, the telephone company may discontinue your service temporarily. If possible, they will notify you in advance. But if advance notice isn't practical, you will be notified as soon as possible. You will be advised of your right to file a complaint with the FCC.
2. Your telephone company may make changes in its facilities, equipment, operations, or procedures that could affect the proper operation of your equipment. If they do, you will be given advance notice so as to give you an opportunity to maintain uninterrupted service.
3. If you experience trouble with this equipment ( ISU 128), please contact ADTRAN (see inside back cover) for repair/warranty information. The telephone company may ask you to disconnect this equipment from the network until the problem has been corrected, or until you are sure the equipment is not malfunctioning.
4. This unit contains no user-serviceable parts.

To ADTRAN service personnel: For continued protection against risk of fire, replace F1 with the same type and rating of fuse *only*: .2 A, 250 V.

**FEDERAL COMMUNICATIONS COMMISSION  
RADIO FREQUENCY INTERFERENCE STATEMENT  
FCC ID: HDC1202029TL**

This equipment has been tested and found to comply with the limits for a Class B digital device, pursuant to Part 15 of the FCC Rules. These limits are designed to provide reasonable protection against harmful interference in a residential environment. This equipment generates, uses, and can radiate radio frequency energy and, if not installed and used in accordance with the instructions, may cause harmful interference to radio or TV reception, which can be determined by turning the equipment off and on. The user is encouraged to try to correct the interference by one or more of the following measures:

- Reorient or relocate the receiving antenna.
- Increase the separation between the equipment and receiver.
- Connect the equipment into an outlet on a circuit different from that to which the receiver is connected.
- Consult the dealer or an experienced radio/TV technician for help.

**WARNING**

*This device is FCC Class B certified only on the EIA-232 interface. The V.35 and RS-530 interfaces are FCC Class B verified.*

*Changes or modifications not expressly approved by ADTRAN will void the user's authority to operate this equipment.*

## CANADIAN EMISSIONS REQUIREMENTS

This digital apparatus does not exceed the Class B limits for radio noise emissions from digital apparatus as set out in the interference-causing equipment standard entitled "Digital Apparatus," ICES-003 of the Department of Communications.

Cet appareil numérique respecte les limites de bruits radioélectriques applicables aux appareils numériques de Class B prescrites dans la norme sur le matériel brouilleur: "Appareils Numériques," NMB-003 édictée par le ministre des Communications.

## CANADIAN EQUIPMENT LIMITATIONS

Notice: The Canadian Industry and Science Canada label identifies certified equipment. This certification means that the equipment meets certain telecommunications network protective, operational, and safety requirements. The Department does not guarantee the equipment will operate to the user's satisfaction.

Before installing this equipment, ensure that it is permissible to be connected to the facilities of the local telecommunications company. The equipment must also be installed using an acceptable method of connection. In some cases, the company's inside wiring associated with a single-line individual service may be extended by means of a certified connector assembly (telephone extension cord). Compliance with the above conditions may not prevent degradation of service in some situations.

Repairs to certified equipment should be made by an authorized Canadian maintenance facility designated by the supplier. Any repairs or alterations made by the user to this equipment, or equipment malfunctions, may give the telecommunications company cause to request the user to disconnect the equipment.

Users should ensure for their own protection that the electrical ground connections of the power utility, telephone lines, and internal metallic water pipe system, if present, are connected together. This precaution may be particularly important in rural areas.



*Users should not attempt to make such connections themselves, but should contact the appropriate electric inspection authority, or an electrician, as appropriate.*

The **Load Number (LN)** assigned to each terminal device denotes the percentage of the total load to be connected to a telephone loop which is used by the device, to prevent overloading. The termination on a loop may consist of any combination of devices subject only to the requirement that the total of the Load Numbers of all devices does not exceed 100.

# Table of Contents

---

<b>Chapter 1. Understanding ISDN and the ISU 128 .....</b>	<b>1</b>
ISDN Overview .....	1
The ADTRAN ISU 128.....	1
ISU 128 Interoperability .....	4
Recommended Operating Protocols.....	6
<b>Chapter 2. ISDN Ordering Codes (IOCs) .....</b>	<b>9</b>
Ordering ISDN using IOCs.....	9
Capability S .....	10
Applications.....	10
Capability R.....	10
Applications.....	10
Capability B .....	10
Capability C.....	10
<b>Chapter 3. Installation .....</b>	<b>11</b>
Network Connection.....	11
DTE Data Connection .....	12
Dial Interface Connection.....	12
Maintenance Interface .....	13
<b>Chapter 4. Operation .....</b>	<b>15</b>
Menu Navigation .....	15
Getting Started .....	16
Status Buffer .....	16
VT 100 Terminal Menu Support .....	17
Status Screen.....	17
Configuration Screen .....	18
<b>Chapter 5. Testing .....</b>	<b>19</b>
TEST Options .....	19
Loopback DTE.....	20
Loopback Network.....	20
Loopback Protocol.....	20
Loopback Remote .....	21
Test Remote .....	21
Loopback Disable .....	21
No Remote Loopbacks.....	21
DDS Accepted.....	21
V.54 Accepted .....	21
DDS+V54 Accept.....	22

Table of Contents

---

Near-End Block Errors/Far-End Block Errors (NEBE/FEBE) .....	22
Software Version.....	22
<b>Chapter 6. Configuration .....</b>	<b>23</b>
Dial Line Operation.....	23
Switch Protocol .....	24
Call Type .....	24
Speech .....	24
Audio .....	25
Data 56 kbps.....	25
Data 64 kbps (default) .....	25
Terminal Identification .....	25
Setting the SPID.....	25
Setting the LDN.....	26
Dial Options.....	29
Front Panel .....	29
RS-366 .....	29
1 sec or EON.....	30
2 sec or EON.....	30
5 sec or EON (default).....	30
10 sec or EON .....	30
20 sec or EON .....	30
Wait for EON .....	30
AT Commands .....	30
Using AT Commands .....	31
Using S-Registers.....	31
Reading S-Registers.....	32
Reading S-Register Strings.....	32
Changing S-Registers.....	32
Changing S-Register Strings .....	32
Dialing a Call Using the AT Command Processor .....	32
V.25 bis .....	33
V.25 ASYNC Dialing .....	34
V.25 SYNC HDLC Dialing .....	35
V.25 SYNC BISYNC Dialing .....	35
V.25 HDLC FLAG.....	35
Disabled.....	35
Auto Answer .....	36
Disabled.....	36
Enabled .....	36
Dump all calls.....	36
Answer Tone .....	37
No Answer Tone (Default) .....	37
Incoming Tone.....	37
Outgoing Tone.....	37
Always Tone .....	37
Connect Timeout.....	38
Call Screening.....	38

Leased Line Service.....	40
Clock Mode: Slave/Master .....	40
Channel rate .....	41
DTE OPTIONS.....	42
Bit Rate .....	42
Connector Type.....	43
RTS Options.....	43
CTS Options .....	43
CD Options.....	43
DTR Options.....	43
DSR Options .....	44
Flow Control (Asynchronous Data Format).....	44
Data Format (Asynchronous) .....	45
Transmit Clock (Synchronous Data Format).....	45
<b>Chapter 7. Protocol Options .....</b>	<b>47</b>
Protocol Options.....	47
Clear Channel.....	48
BONDING Mode 1 .....	48
TXINIT .....	49
TXFA .....	49
TXADD01 .....	50
TXDEQ.....	50
TANULL.....	50
TCID .....	50
V.120 .....	50
V.110 .....	51
V.34 .....	51
Error Control.....	51
Compression .....	52
Microcom™ Network Protocol Block Size (MNP® Blk) .....	52
DSU 57.6 ASYNC.....	53
T-Link .....	53
Simple ADTRAN Protocol (SAP) .....	53
FALLBACK .....	54
Point-to-Point (PPP) Async-to-Sync .....	56
Point-to-Point Protocol (PPP).....	56
Multilink Point-to-Point Protocol (MP).....	56
PPP with Compression .....	57
<b>Chapter 8. Quick Setup .....</b>	<b>59</b>
Quick Setup Configuration.....	59
Quick Setup .....	60
Dial 56K sync* .....	60
Dial 64K sync* .....	61
Dial 112K sync* .....	61
Dial 128K sync* .....	62



Table of Contents

Dial PPP* .....	62
V34 115.2 asyn* .....	63
Dial 57.6 asyn* .....	63
Dial 115.2 asyn* .....	64
Fallback 57.6k* .....	64
More .....	65
Leased 128K.....	65
Ldm 128 Master .....	65
Factory Setup.....	66
<b>Chapter 9. Dial Options .....</b>	<b>67</b>
Dialing Options.....	67
Hang Up Line .....	68
Dial Number.....	68
Redial Last Number .....	68
Answer Call .....	68
Dial Stored Number .....	68
Store/Review Number .....	69
<b>Chapter 10. Remote Configuration .....</b>	<b>71</b>
Remote Configuration .....	71
Configuring with AT Commands .....	71
Configuring and Testing with the Front Panel or VT 100 Terminal .....	72
Configure Remote Unit.....	73
Remote Testing.....	74
Loopback Remote 1B .....	74
Loopback Remote 2B .....	74
Set Password.....	74
<b>Chapter 11. Troubleshooting.....</b>	<b>77</b>
If Self Test Fails .....	77
If The ISU 128 Does Not READ READY .....	77
<b>Chapter 12. Specifications .....</b>	<b>83</b>
Specifications and Features.....	83
Network Interface.....	83
DTE Interface .....	83
Dialing Selections .....	83
Data Rates (Network) .....	83
Data Rates (DTE) .....	83
Rate Adaption .....	84
Interoperability .....	84
Switch Compatibility .....	84
B Channel Aggregation .....	84
Display .....	84

Table of Contents

---

Environmental .....	85
Physical .....	85
Power .....	85
<b>Appendix A. AT Commands.....</b>	<b>87</b>
<b>Appendix B. Current Status Messages.....</b>	<b>93</b>
<b>Appendix C. Status Buffer Messages.....</b>	<b>97</b>
<b>Appendix D. S-Register List .....</b>	<b>107</b>
<b>Appendix E. Connector Pinouts .....</b>	<b>115</b>
<b>Acronyms .....</b>	<b>121</b>
<b>Glossary .....</b>	<b>123</b>

## Table of Contents

---

# List of Figures

---

Figure 1-1:	ISU 128 Rear Panel .....	2
Figure 1-2:	ISU 128 Front Panel .....	3
Figure 1-3:	ISU 128 Interoperability.....	5
Figure 4-1:	VT 100 Status Screen .....	17
Figure 4-2:	VT 100 Configuration Screen .....	18
Figure 5-1:	VT 100 Test Screen.....	19
Figure 5-2:	Test Menu Tree .....	20
Figure 5-3:	Loopback Points .....	20
Figure 6-1:	Dial Line Menu Tree .....	23
Figure 6-2:	VT 100 Configuration Screen .....	24
Figure 6-3:	Configuration Menu Tree.....	27
Figure 6-4:	Dial Options, RS-366 Menu Tree .....	29
Figure 6-5:	Dial Options, V.25 bis Menu Tree .....	33
Figure 6-6:	Dial Line, Auto Answer Menu Tree .....	34
Figure 6-7:	Data Bits Menu Tree.....	34
Figure 6-8:	V.25 bis ASYNC Menu Tree.....	35
Figure 6-9:	Answer Tone Menu Tree.....	37
Figure 6-10:	Connect Timeout Menu Tree .....	38
Figure 6-11:	Call Screening Menu Tree .....	38
Figure 6-12:	Leased Line Menu Tree .....	40
Figure 6-13:	Limited Distance Modem Application.....	40
Figure 6-14:	Leased Application with Channel Banks.....	41
Figure 6-15:	Asynchronous DTE Options Menu Tree.....	42
Figure 6-16:	Synchronous DTE Options Menu Tree .....	42
Figure 6-17:	Flow Control Menu Tree .....	44
Figure 6-18:	Data Format Menu Tree .....	45
Figure 7-1:	Protocol Menu Tree.....	48
Figure 7-2:	BONDING Mode 1 Protocol Menu Tree.....	49
Figure 7-3:	V.34 Error Control Menu Tree.....	51
Figure 7-4:	V.34 Compression Menu Tree .....	52
Figure 7-5:	V.34 MNP Block Size Menu Tree .....	52
Figure 7-6:	FALLBACK Menu Tree .....	55
Figure 7-7:	PPP Menu Tree .....	56
Figure 8-1:	Quick Setup Menu Tree.....	59
Figure 9-1:	VT 100 Terminal Dial Options Screen .....	67
Figure 9-2:	Dial Menu Tree .....	68

## List of Figures

---

Figure 10-1:	Remote Configuration Menu Path .....	72
Figure 10-2:	Remote Configuration Screen .....	72
Figure 10-3:	Remote Unit Configuration Screen .....	73
Figure 10-4:	Test Menu Path .....	74
Figure 10-5:	Loopback Remote 1B.....	75
Figure 10-6:	Set Password Screen.....	75
Figure E-1:	EIA-232/RS-530 Interface.....	115
Figure E-2:	V.35 Interface.....	117
Figure E-3:	RS-366 Interface.....	118
Figure E-4:	RJ-45 Interface .....	118
Figure E-5:	Maintenance Port.....	119

# List of Tables

---

Table 1-A:	DTE Indicators .....	3
Table 1-B:	Recommended Operating Modes .....	7
Table 3-A:	Maximum DTE Interface Cable Lengths.....	12
Table 7-A:	Rate Adaption Protocols.....	54
Table E-A:	EIA-232 Interface .....	115
Table E-B:	RS-530 Interface .....	116
Table E-C:	V.35 Interface.....	117
Table E-D:	RS-366 Interface .....	118
Table E-E:	RJ-45 ISDN IFC .....	118
Table E-F:	Maintenance Port.....	119

## List of Tables

---

# Chapter 1

## Understanding ISDN and the ISU 128

---

### ISDN OVERVIEW

The Integrated Services Digital Network (ISDN) is a public or private switched digital network. ISDN is an international standard for digital communications, allowing a full range of enhanced services supporting voice, data, and image applications through standard interfaces over a single telephone wire. ISDN provides a means of integrating these services and modernizing communication networks for information movement and management efficiency.

### THE ADTRAN ISU 128

The ADTRAN ISU™ 128 is a stand-alone device that connects data terminal equipment (DTE) to the ISDN network or to a leased digital network for data transmission. The ISU 128 allows high-speed data transmission (up to 128 kbps) over a single ISDN line. The ISU 128 meets the Microsoft Windows®95 Plug-an-Play specifications. The file **MDMADTN.INF** is required. To obtain this file contact our website at URL of [www.adtran.com](http://www.adtran.com) ADTRAN technical support. The number is located on the inside back cover of this manual.

From the network, ISDN is delivered by a single 2-wire 2B1Q U-interface which is connected directly to the ISU 128. ISDN network termination is designed into the ISU 128, eliminating the need and expense of a separate NT1. For network testing, the ISU 128 responds to NT1 test commands from the telephone company central office (CO).

The ISU 128 transmits data over an RS-530, V.35 interface, or EIA-232 interface, selectable on the front panel. The ISU 128 performs at synchronous data transfer rates of 2400 bps to 128 kbps and asynchronous rates of 300 bps to 115.2 kbps. For speeds over 64 kbps, the industry standard BONDING or MULTI-LINK PPP protocol aggregates the two 64 kbps B channels for a maximum of 128 kbps. The ISU 128 is intended to support the transfer of data and images



over ISDN. The ISU 128 may be viewed as an *ISDN dial modem* that allows cost-effective high-speed data transmission at rates up to 128 kbps.

The ISU 128 has one RJ-45 jack available on the rear panel for network connection (see Figure 1-1). The RJ-45 jack labelled **ISDN IFC** is for ISDN Basic Rate. ISDN Basic Rate service divides a standard telephone line into three digital channels capable of simultaneous voice and data transmission. The three channels are comprised of two bearer (B) channels at 64 kbps and one data (D) channel at 16 kbps (2B+D).

The ISU 128 also supports a leased digital connection that allows data to be transferred at up to 128 kbps over a 2-wire facility using the U-interface jack labelled **ISDN IFC**. This type of service is a permanent connection between end points and is sometimes referred to as a leased connection, a dedicated connection, a nailed-up connection, a private circuit, or a limited distance modem connection. These types of service are referred to in this manual as Leased Line Service.

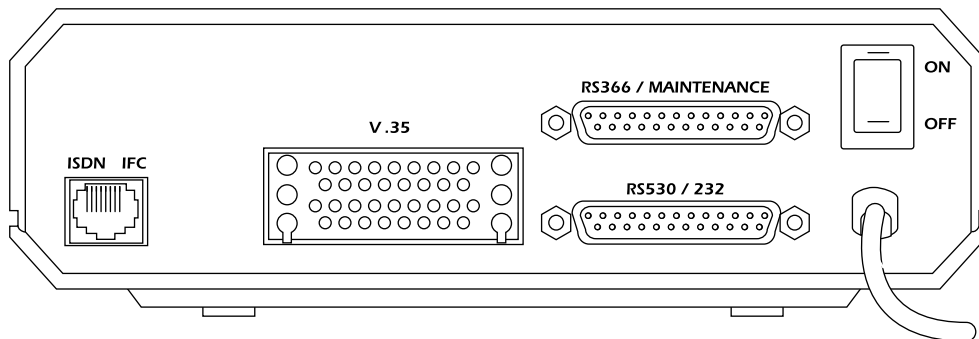

**Figure 1-1**  
*ISU 128 Rear Panel*

Dialing from the ISU 128 is accomplished in a variety of ways:

- From the front panel
- From up to ten stored numbers
- Through an RS-366 dial port used in facsimile and video conferencing applications
- Over the DTE interface using the AT command set
- With V.25 bis in-band dialing (used in applications such as LAN/WAN bridging)

- With DTR asserted, some bridges/routers raise DTR when bandwidth on their dedicated line is exceeded. In high-traffic times, this allows the ISU 128 to dial out over the ISDN for an extra 128 kbps of bandwidth-on-demand.

The ISU 128 front panel accommodates a 2-line, 16 character LCD display. Seven LED indicators monitor data flow and display the status of key DTE interface leads as described in Table 1-A. A front panel keypad supports configuration, test modes, test status, and dialing (see Figure 1-2).

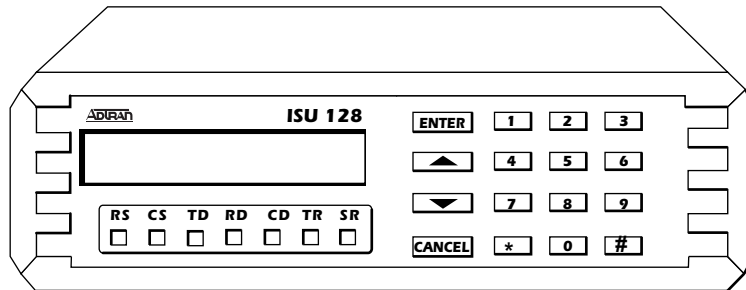

**Figure 1-2**  
ISU 128 Front Panel

**Table 1-A**  
DTE Indicators

Indicator	Definition
RS	Request to Send. Indicates the DTE is ready to transmit.
CS	Clear to Send. Indicates the ISU 128 is ready to transmit.
TD	Transmit Data. On when the DTE is transmitting to the ISU 128.
RD	Receive Data. On when the ISU 128 is receiving data from the far end.
CD	Carrier Detect. On when the ISU 128 is connected to a remote unit.
TR	Data Terminal Ready from DTE. On when DTR is active at DTE interface.
SR	Data Set Ready.

## **ISU 128 INTEROPERABILITY**

Telephone networks are evolving from analog technologies to digital technologies such as ISDN. This transition is time-consuming and costly for the telephone companies. Upgrading all locations and facilities is a lengthy process.

The ISU 128 bridges this transition by supporting communications with existing and future network services and equipment. The ISU 128 supports communications with Switched 56 service, Switched 56 DSUs (2-wire and 4-wire), various ISDN terminal adapters, ISDN terminal equipment, BONDING compatible inverse multiplexers, and analog modems with the optional V.34 modem (part number 1202029L3).

Figure 1-3 illustrates the ISU 128 operation in various switched network services and customer premises products.

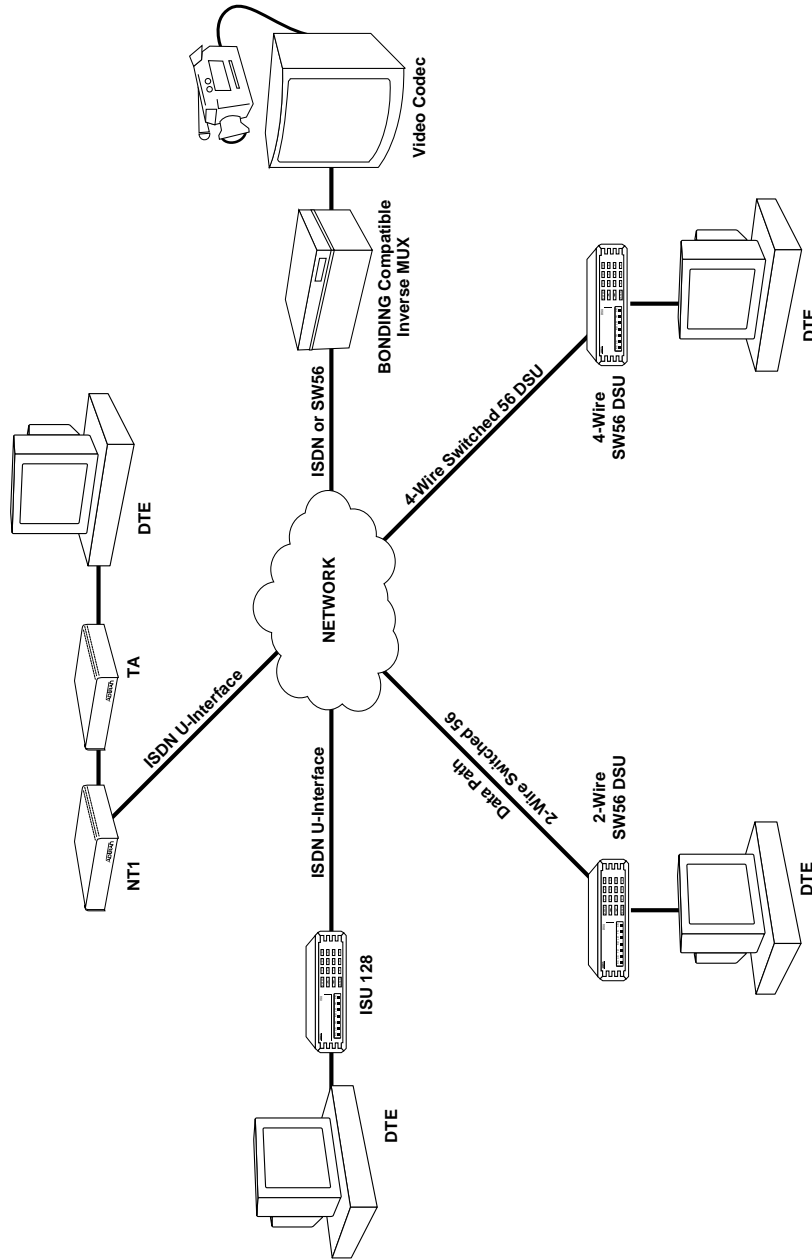

**Figure 1-3**  
*ISU 128 Interoperability*

## **RECOMMENDED OPERATING PROTOCOLS**

The ISU 128 supports a wide range of operating modes. Many combinations of circuit type, protocol, and data rate may be selected. However, only the combinations shown in Table 1-B are recommended. As noted in Table 1-B, all asynchronous rates will support flow control. Flow control is required when operating at 115,200 bps using PPP (Point-to-Point Protocol), V.120, SAP (Simple Adtran Protocol), or asynchronous bonding.

Table 1-B shows that a given data rate may be achieved by more than one protocol/rate adaption selection. The table is organized so that selections with the least transport delay are closer to the top of the table for any given circuit type. Therefore, users should choose a protocol and rate closer to the top of the protocol rate list for a given circuit type.

**Table 1-B**  
Recommended Operating Modes

Call Type	Protocol	Sync/ Async	Rates Supported (bps)								
			56000	64000	48000	64000	19200	38400	56000	64000	
DIAL-64K	BONDING	Sync	56000	64000							
	Clear Chan	Sync	48000	56000	64000						
	PPP	Sync	2400	4800	9600	19200	38400	56000	64000		
	V.110	Sync	2400	4800	9600	19200	38400				
	V.120	Sync	9600	19200	38400	48000					
	Tlink	Sync	2400	4800	9600	19200	56000	64000			
	SAP	Sync	38400								
	PPP async-sync	Async	1200	2400	4800	9600	19200	38400	57600	115200 <sup>f</sup>	
	BONDING	Async	2400	4800	9600	19200	38400	57600			
	V.110	Async	1200	2400	4800	9600	19200	38400 <sup>v</sup>			
	V.120	Async	1200	2400	4800	9600	19200	38400	57600	115200 <sup>f</sup>	
	Tlink	Async	1200	2400	4800	9600	19200				
	SAP	Async	38400	57600	115200 <sup>f</sup>						
	DIAL-56K	BONDING	Sync	56000							
Clear Chan		Sync	48000	56000							
PPP		Sync	2400	4800	9600	19200	38400	56000			
V.110		Sync	2400	4800	9600	19200					
V.120		Sync	9600	19200	38400	48000					
Tlink		Sync	2400	4800	9600	19200	56000				
PPP async-sync		Async	1200	2400	4800	9600	19200	38400	57600	115200 <sup>f</sup>	
BONDING		Async	2400	4800	9600	19200	38400	57600			
DSU 57.6		Async	57600								
V.110		Async	1200	2400	4800	9600	19200				
V.120		Async	1200	2400	4800	9600	19200	38400	57600	115200 <sup>f</sup>	
Tlink		Async	1200	2400	4800	9600	19200				
DIAL-64K*2		BONDING	Sync	128000							
		MPPP	Sync	128000							
	MPPP	Async	115200 <sup>f</sup>								
	BONDING	Async	115200 <sup>f</sup>								
DIAL-56K*2	BONDING	Sync	112000								
	MPPP	Sync	112000								
	MPPP	Async	115200 <sup>f</sup>								
	BONDING	Async	115200 <sup>f</sup>								
LEASED 64K	Clear Chan	Sync	48000	56000	64000						
	SAP	Sync	2400	4800	9600	19200	38400				
	DSU 57.6	Async	57600								
LEASED 128K	SAP	Async	1200	2400	4800	9600	19200	38400	57600 <sup>f</sup>	115200 <sup>f</sup>	
	Clear Chan	Sync	128000								



1. All asynchronous rates support flow control.
2. All dial-up modes support front panel, DTR, RS-366, AT command, and V.25 bis dialing methods.
3. Rates marked with *f* require flow control.
4. Given a choice between two protocols, pick the protocol closer to the top of the list.
5. Multilink PPP supports the same rates as single-link PPP async-sync. Use the recommended rates for PPP async-sync.



# Chapter 2

## ISDN Ordering Codes (IOCs)

---

### ORDERING ISDN USING IOCS

The development of ISDN ordering codes (IOCs) simplifies the process of ordering ISDN service. The ISDN Solutions Group, a consortium of ISDN equipment vendors, service providers, and Bellcore, established these codes to represent predetermined line configurations for ISDN Basic Rate service for specific applications.

ADTRAN and Bellcore have registered and tested eight generic IOCs. Of these, four are recommended for operation of the ISU 128. After reviewing the following list, order ISDN lines from the local service provider. Request the appropriate IOC for your application. They are described in detail in this chapter.

In some areas, ISDN tariffs may warrant the use of ordering codes with less features. For example, in a particular region, there may be additional monthly expense associated with having voice service on each B channel. If you have a data only application, **Capability R** (previously **Generic Data I**) may be more cost-effective.

If these are not available from your service provider or you would like more information regarding ordering ISDN see the ADTRAN document *Ordering ISDN Service User Guide* part number 60000.015-8 or contact your telephone company for alternative line configurations. The *Ordering ISDN Service User Guide* is available on the ADTRAN home page at <http://www.adtran.com> or by calling ADTRAN.



ADTRAN has registered the following ISDN ordering codes to support a variety of tariffs and applications:

### **Capability S**

- 2B service
- Both B channels alternating voice and data
- Two directory numbers

#### **Applications**

- Host data center, internet access, bulletin board, and modem pooling applications
- Modem capability
- Generic data transfer, including remote access and LAN/WAN connectivity and telecommuting

### **Capability R**

- 2B service
- Data only
- Two directory numbers

#### **Applications**

- Host data center, internet access, bulletin board, and modem pooling applications
- Data only applications, no modem capability
- Data transfer applications, including remote access and LAN/WAN connectivity, telecommuting

### **Capability B**

- 1B service
- Data only
- One directory number
- 

### **Capability C**

- 1B service
- Alternating voice and data
- One directory number

# Chapter 3

## Installation

---

After unpacking the unit, immediately inspect it for possible shipping damage. If damage is discovered, file a claim immediately with the shipping carrier, then contact ADTRAN Repair and Return Department (see the end of this manual).



**NOTE** *Ensure that a grounded, 115 VAC, 60 Hz receptacle is used to provide power.*

### **NETWORK CONNECTION**

The ISU 128 supports either dial or leased operation. An eight-pin RJ-45 modular jack labelled **ISDN IFC** on the rear panel allows connection to ISDN Basic Rate Service provided by the telephone company or to a leased type of service.

Dial operation uses the ISDN Basic Rate U-interface and allows the ISU 128 to dial out over the ISDN network. The Leased Line Service can be dedicated 2B1Q data service or a nailed-up circuit (twisted pair) that provides a dedicated connection between end points such as a limited distance modem or point-to-point connection. When using the ISU 128 in either of these types of service, connect the network interface to the RJ-45 connector labelled **ISDN IFC**.

See the appendix *Connector Pinouts* for network connection pin assignments.

## DTE DATA CONNECTION

Data terminal equipment is connected to the ISU 128 by using either the RS-530 interface, the V.35 interface, or EIA-232 interface on the rear panel of the ISU 128. The maximum recommended cable lengths are shown in Table 3-A. See the appendix *Connector Pinouts* for each interface pin assignments. Be sure to configure the menu option for the connector type used in your application. Refer to the section *DTE Options for Asynchronous and Synchronous Operation* in Chapter 6 to configure the connector type.

**Table 3-A**  
*Maximum DTE Interface Cable Lengths*

DTE Interface	Max Cable Length
RS-530	50 feet
V.35	30 feet
EIA-232	15 feet

The RS-530 interface and the V.35 interface support data rates up to 128 kbps. The DTE rate is configured from the front panel of the ISU 128 or by using AT commands. See the chapter *Configuration* to configure the ISU 128 with the appropriate data rates.

To prevent possible radio frequency interference emissions, a shielded V.35 cable is required.

## DIAL INTERFACE CONNECTION

If out-of-band RS-366 dialing is required for applications such as videoconferencing or FAX machines, the dialing interface of the host DTE should be connected to the dial port marked **RS-366/Maintenance**. Pin assignments for the RS-366 connector are listed in the appendix *Connector Pinouts*.

---

## MAINTENANCE INTERFACE

The Maintenance Interface is available at 9600 bps, 8 data bits, no parity, asynchronous format, through the RS-366/Maintenance port. See the appendix *Connector Pinouts* for Maintenance port pin assignments. The VT 100 terminal or null modem can be connected to the RS-366/Maintenance port using an EIA-232 cable. This interface can be used to set internal S-registers, dial ISDN connections, and disconnect calls. This port also allows ADTRAN Technical Support personnel to retrieve vital information from the unit if a problem is encountered during initial configuration of the ISU 128. Most problems can be solved without resorting to this port for assistance.

In order to activate the Maintenance port, ensure the dial mode is either **Front Panel** or **AT commands**. When the dial mode is set for **RS-366**, the Maintenance port is disabled.

**NOTE**

*The Maintenance port cannot be used to pass data or to remotely configure another ISU 128 using the Cfg. Rmt. Unit option.*

AT commands sent to the Maintenance port are not preceded by "AT."

Example: To display the unit model number, enter: I0

## Chapter 3. Installation

---

# Chapter 4 Operation

---

## MENU NAVIGATION

Four function keys on the left-hand side of the keypad allow the user to enter, exit, and scroll through the various menu branches. The four function keys are defined below.

<b>Enter</b>	Enters the selected item.
<b>Up Arrow</b>	Scrolls up a menu tree.
<b>Down Arrow</b>	Scrolls down a menu tree.
<b>Cancel</b>	Exits (back one level) from the current branch of the menu tree.



### NOTE

*For reading ease, function keys are represented in bold, initial caps text. Selectable menu items and messages displayed on the LCD are represented in bold type as they appear on the LCD.*

Press either the **Up** or **Down** arrow to scroll through the menu tree. To choose an item, press the corresponding number on the keypad. The item blinks to show that it is selected and has been stored in non-volatile memory. Press **Enter** to select the item. Press **Cancel** to exit back through the menu tree.

It is important to note that some features in the ISU 128 do not immediately take effect upon selection. This prevents unintentional reconfiguration of the ISU 128 during an active call. **Leased/Dial Line**, and ISDN **Switch Protocol**, take effect only when the ISU is powered up or the U-interface is bounced (line broken and restored). To ensure the ISU is actually performing as configured, cycle the power off, then back on again, after these items are changed. Also, items such as **Bit Rate**, **Protocol**, and **Call Type** take effect only at the beginning of a new call.

## GETTING STARTED

At power up, the front panel display is in the Current Status mode. This is the recommended resting place for the display as it shows the current operational status of the unit. For example, if the ISU 128 is not connected to the network, the Current Status menu displays **ADTRAN ISU 128 Link Down**. If the unit is connected to the network and functioning properly, it displays **ADTRAN ISU 128 Ready**. A list of Current Status messages is provided in the appendix *Current Status Messages*. Pressing **Cancel** repeatedly returns the unit to the **Current Status** menu. While at the **Current Status** menu, pressing any key changes the display to the top of the menu tree.

The menu tree allows for set up and operation of the ISU 128 from the front panel. The main branches of the menu tree follow:

1. **STATUS**
2. **TEST**
3. **CONFIG (Configuration)**
4. **DIAL**

### Status Buffer

Select **1=STATUS** from the top of the menu tree to display the status buffer. The **Up** and **Down** arrows allow viewing of the last fifty status messages generated during the operation of the unit. The most recent message displays last. An explanation of Status Buffer Messages can be found in the appendix *Status Buffer Messages*. To return to the top of the menu, press **Cancel**. The buffer can be cleared by pressing **0**.

## VT 100 TERMINAL MENU SUPPORT

When connected to an asynchronous VT 100 terminal or VT 100 terminal emulator, use the built-in ISU 128 menu system for configuration. To enter into the menus, type **AT!V Enter**. To go to a particular menu, simply press the hot keys for that menu. The main branches of the menu tree and their hot keys are:

- STATUS (Ctl-V)
- TEST (Ctl-T)
- CONFIG (Ctl-C)
- DIAL (Ctl-D)

### Status Screen

To determine the current status of the unit, press **Ctrl+V** to access the Status Screen (see Figure 4-1). The Status Screen displays unit information such as the loop status, software revision, the result of the initial self test, and the status buffer messages. The most recent message always displays as Status Buffer 1. An explanation of status buffer messages can be found in the appendix *Status Buffer Messages*.

```

                                ISU 128 Status Menu
UNIT/LOOP STATUS                STATUS BUFFER
Loop Rate      = Data 64Kbps      1 = MaintPort Setup
DTE Rate       = 2400             2 = EMPTY
DTE Format      = Asynchronous     3 = EMPTY
Test Status    = No Test          4 = EMPTY
Self Test      = Passed           5 = EMPTY
Software Rev   = ISU Ver A.00     6 = EMPTY
Checksum       = ebfc             7 = EMPTY
Loop Status    = Link down        8 = EMPTY
Num Dialed     = No Call          9 = EMPTY
RTS            = ON              10 = EMPTY
CTS            = ON              11 = EMPTY
TD             = OFF             12 = EMPTY
RD             = OFF             13 = EMPTY
DCD            = OFF             14 = EMPTY
DTR            = ON              15 = EMPTY
DSR            = ON _            16 = EMPTY
                                   17 = EMPTY
                                   18 = EMPTY
                                   19 = EMPTY
                                   20 = EMPTY

Ctl-V STATUS  Ctl-T TEST  Ctl-C CONFIG  Ctl-D DIAL  Ctl-X EXIT

```

**Figure 4-1**  
VT 100 Status Screen



## Configuration Screen

Once the unit is selected using the terminal interface, the display shows the Configuration Menu (see Figure 4-2). This screen shows the current configuration, line, and call status for the selected unit. See the chapter *Configuration* for more information about configuring the ISU 128.

```

ISU 128 Configuration Menu
1) Netw. options = Dial Line      17) CD Options = Normal
2) Switch Protocol = AT&T 5ESS   18) DTR Options = Ignore DTR
3) Call type = Data 64Kbps       19) DSR Options = DSR forced on
4) SPID 1 = 0192255360          20) Flow Control = Hardware Flow
5) SPID 2 = 0192255370          21) Data Bits = 8 Data bits
6) LDN 1 = 9225536              22) Parity Bits = None
7) LDN 2 = 9225537              23) Stop Bits = 1 Stop bit
8) Auto answer = Enabled        24) Protocol = Clear Channel
9) Answer tone = No Answer tone 25) Quick setup
10) Connect Timeout = 30 sec (def) 26) Cfg. Rmt. Unit
11) Call Screening = Answer any  27) Set Password
12) DTE options = Asynchronous   28) Lpbk remote 1B
13) Bit Rate = 9600              29) Lpbk remote 2B
14) Connector Type = RS-232
15) RTS Options = 1 ms delay
16) CTS Options = Follows RTS

Select =                               Enter SELECT   Esc NO CHANGE

Ctl-V STATUS  Ctl-T TEST  Ctl-C CONFIG  Ctl-D DIAL  Ctl-X EXIT

```

**Figure 4-2**  
*VT 100 Configuration Screen*

To configure the ISU 128 quickly and easily for most applications, see the chapter *Quick Setup*.

# Chapter 5 Testing

## TEST OPTIONS

Pressing **Ctl-T** from any VT 100 terminal screen or selecting **2=TEST** from the top of the menu tree on the front panel displays local testing options. Figure 5-1 shows the VT 100 terminal test screen and the menu tree is illustrated in Figure 5-2.

```
ISU 128 Test Menu
1) Loopback Netw.
2) Lpbk Disable = U54 Accepted
3) NEBE/FEBE

Select =                               Enter SELECT   Esc NO CHANGE

Ctl-V STATUS  Ctl-T TEST  Ctl-C CONFIG  Ctl-D DIAL  Ctl-X EXIT
```

**Figure 5-1**  
*VT 100 Test Screen*

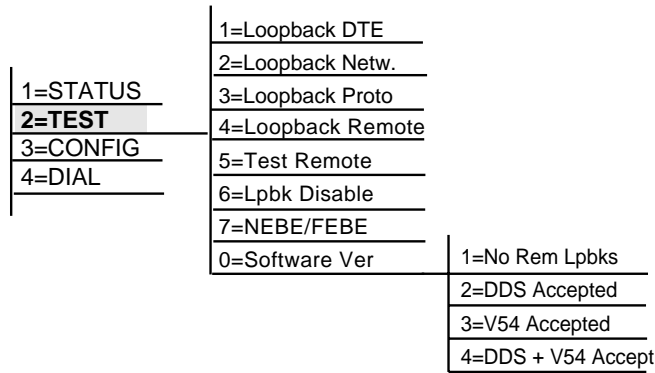

**Figure 5-2**  
*Test Menu Tree*

## Loopback DTE

**Loopback DTE** causes the ISU DTE port to loop back toward user equipment. This allows performance of a bit error rate test (BERT) between the ISU 128 and the end user equipment to verify proper cable connection.

## Loopback Network

**Loopback Network** forces the ISU 128 to loopback both the B1 and B2 channels toward the network. This can be used to allow a far-end user to perform a BERT all the way through the network.

## Loopback Protocol

**Loopback Protocol** allows data to loopback toward the network after passing through a selected protocol such as T-Link or BONDING. See Figure 5-3 for loopback points.

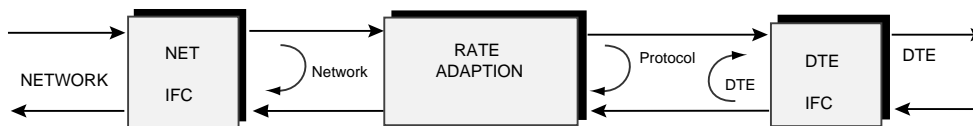

**Figure 5-3**  
*Loopback Points*

---

## Loopback Remote

**Loopback Remote** allows the ISU 128 to issue a V.54 in-band loopback command to a far-end unit while still accepting data from the DTE connector. This provides bit error rate testing of an entire link using an external BERT test set. To use this feature, both units must be configured for Clear Channel operation and the far-end unit must be able to respond to V.54 loopback commands. See the chapter *Protocol Options* to configure the unit for Clear Channel operation. Press the **Cancel** key to end the test.



*Loopback Remote 1B and 2B are only used with the DTE set to asynchronous.*

## Test Remote

**Test Remote** allows the ISU 128 to issue a V.54 in-band loopback command to a far-end unit and BERT the link using a built-in 2047 pattern generator/checker. This allows for testing a circuit without any extra test equipment. To use this feature, both units must be configured for Clear Channel operation and the far-end unit must be able to respond to V.54 loopback commands. See the chapter *Protocol Options* to configure the unit for Clear Channel operation. The built-in 2047 pattern generator/checker displays the number of bytes transmitted on the top line and the number of errored bytes received on the lower line of the front panel display. Press **0** to clear the counts. By pressing the down arrow, you can loop down the far end unit and run a head to head 2047 pattern test. Press **Cancel** to end the test.

## Loopback Disable

The following options are available when disabling loopbacks:

### **No Remote Loopbacks**

The ISU 128 ignores all V.54 and DDS loopback commands.

### **DDS Accepted**

The ISU 128 responds to DSU Latching Loopback commands. This option only takes effect if the unit is in leased line mode.

### **V.54 Accepted**

The ISU 128 responds to V.54 loopback commands.

### **DDS+V54 Accept**

The ISU 128 responds to both DSU Latching Loopback commands (leased line mode only) and V.54 loopback commands.



#### **NOTE**

*The ISU must be optioned for Clear Channel operation for DSU Latching and V.54 loopback commands to take effect.*

### **Near-End Block Errors/Far-End Block Errors (NEBE/FEBE)**

NEBE/FEBE allows the user to determine the quality of the network connection by viewing the number of near-end (NEBE) and far-end (FEBE) block errors occurring on the ISDN interface. A large or incrementing count indicates problems with network equipment. An incrementing or large count of NEBEs indicates problems from the switch to the terminal adapter. An incrementing or large count of FEBEs indicates problems in the direction from the terminal adapter to the switch.

### **Software Version**

**Software Ver** displays the software version and checksum in use on the ISU 128.



#### **NOTE**

*Press **Cancel** to exit any of these options.*

# Chapter 6 Configuration

## DIAL LINE OPERATION

This section explains how to configure the ISU 128 when using ISDN basic rate switched service. Figure 6-3 illustrates the entire **CONFIG** branch of the menu tree.

The following are step-by-step procedures for configuring the unit for dial line operation, switch protocol, call type, terminal ID, dial options, auto answer, answer tone, connect timeout, and call screening.

To dial calls over the ISDN, the unit must be configured for **Dial Line**. The menu path to select Dial line operation is shown in Figure 6-1.

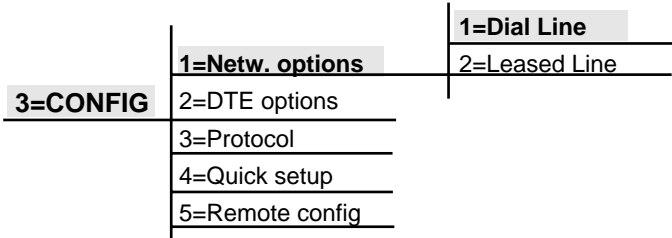

**Figure 6-1**  
*Dial Line Menu Tree*

When using a VT 100 terminal, press **Ctrl-C** to access the Configuration screen, then set the **Line type** option to **Dial Line**. The Configuration screen appears as shown in Figure 6-2.

```

ISU 128 Configuration Menu
1) Netw. options = Dial Line      17) CD Options = Normal
2) Switch Protocol = AT&T 5ESS   18) DTR Options = Ignore DTR
3) Call type = Data 64Kbps       19) DSR Options = DSR forced on
4) SPID 1 = 0192255360          20) Flow Control = Hardware Flow
5) SPID 2 = 0192255370          21) Data Bits = 8 Data bits
6) LDN 1 = 9225536              22) Parity Bits = None
7) LDN 2 = 9225537              23) Stop Bits = 1 Stop bit
8) Auto answer = Enabled        24) Protocol = Clear Channel
9) Answer tone = No Answer tone 25) Quick setup
10) Connect Timeout = 30 sec (def) 26) Cfg. Rmt. Unit
11) Call Screening = Answer any  27) Set Password
12) DTE options = Asynchronous   28) Lpbk remote 1B
13) Bit Rate = 9600              29) Lpbk remote 2B
14) Connector Type = RS-232
15) RTS Options = 1 ms delay
16) CTS Options = Follows RTS

Select =                               Enter SELECT   Esc NO CHANGE

Ctl-U STATUS  Ctl-T TEST  Ctl-C CONFIG  Ctl-D DIAL   Ctl-X EXIT
    
```

**Figure 6-2**  
VT 100 Configuration Screen

## Switch Protocol

Find out what kind of ISDN switch your local CO is using by asking the telephone administrator or telephone company representative. Configure the ISU 128 for either a Northern Telecom DMS-100<sup>®</sup>, AT&T 5ESS<sup>®</sup> switch, or a switch conforming to the National ISDN-1 standard (usually an AT&T 5ESS, NTI DMS-100, or Siemens EWSD). In the Far East, configure for the NEC switch.

## Call Type

The call type can be configured four different ways, depending on the type of service used: speech, audio, data 56 kbps, or data 64 kbps.



**NOTE** When placing outgoing calls using the optional V.34 modem, the unit must be optioned for either speech or audio call type.

### Speech

**Speech** directs the call control software to request a Mu-law/A-law speech circuit as the bearer capability for outgoing calls. The **Speech** option is used with an ISDN line configured for voice service. In some areas voice service costs

---

less than data service. A **Speech** call type does not guarantee an end-to-end digital connection with some local and long distance carriers.

### **Audio**

**Audio** directs the call control software to request a 3.1 kHz audio circuit as the bearer capability for outgoing calls. The **Audio** option is used with an ISDN line configured for voice service. In some areas audio service is less expensive than data service. Selecting an **Audio** call type guarantees a digital end-to-end ISDN connection.

### **Data 56 kbps**

Data 56 kbps directs the call control software to request a 64 kbps data circuit that is rate-adapted to 56 kbps. **Data 56 kbps** is intended for use in circumstances where interoperability with Switched 56 service is desired.

### **Data 64 kbps (default)**

The default Call type for ISDN service is **Data 64 kbps**. This directs the call control software to request an unrestricted 64 kbps circuit.

## **Terminal Identification**

Terminal identification is assigned by the local telephone company and consists of a Service Profile Identifier (SPID) and Local Directory Number (LDN).

### **Setting the SPID**

The SPID is a sequence of digits used to identify ISDN terminal equipment to the ISDN switch. The SPID is assigned by the local phone company when the ISDN line is installed and it usually looks similar to the phone number. Obtain SPIDs from the telephone administrator or local telephone representative.

The number of SPIDs required (0, 1, or 2) depends on how your ISDN line is configured. For instance, a point-to-point line has no SPID. Multipoint lines may have one or two SPIDs. The ISU 128 uses the presence of SPID 1 to determine if the line is multipoint. If the line has only one SPID, then it must be entered in SPID 1.



When selecting a SPID, use the **Up** and **Down** arrows to choose between SPID 1 and SPID 2. Press **Enter** to select the SPID and use the keypad to enter the SPID number. While entering/editing a SPID, the **Down** arrow allows you to backspace through the number string to correct mistakes. The **Up** arrow scrolls back to the last digit entered. To cancel a number, use the **Down** arrow to backspace through it and press **Enter**. Press **Enter** after entering each SPID. To abort changes at any time, press **Cancel**.



**NOTE**

*Disconnect the network interface from the unit before initially entering and/or altering the SPIDs or LDNs.*

**Setting the LDN**

This option allows the entry of 0, 1, or 2 LDNs. The LDN is used when placing or receiving BONDING calls. The LDN is the seven-digit local phone number assigned to the line.

When entering an LDN, use the **Up** and **Down** arrows to choose between LDN 1 and LDN 2. Press **Enter** to select the LDN and use the keypad to enter the LDN number. While entering/editing an LDN, the **Down** arrow allows you to backspace through the number string to correct mistakes. The **Up** arrow scrolls back to the last digit entered. To cancel a number, use the **Down** arrow to backspace through it and press **Enter**. Press **Enter** after entering each LDN. To abort changes at any time, press **Cancel**.

## Chapter 6: Configuration

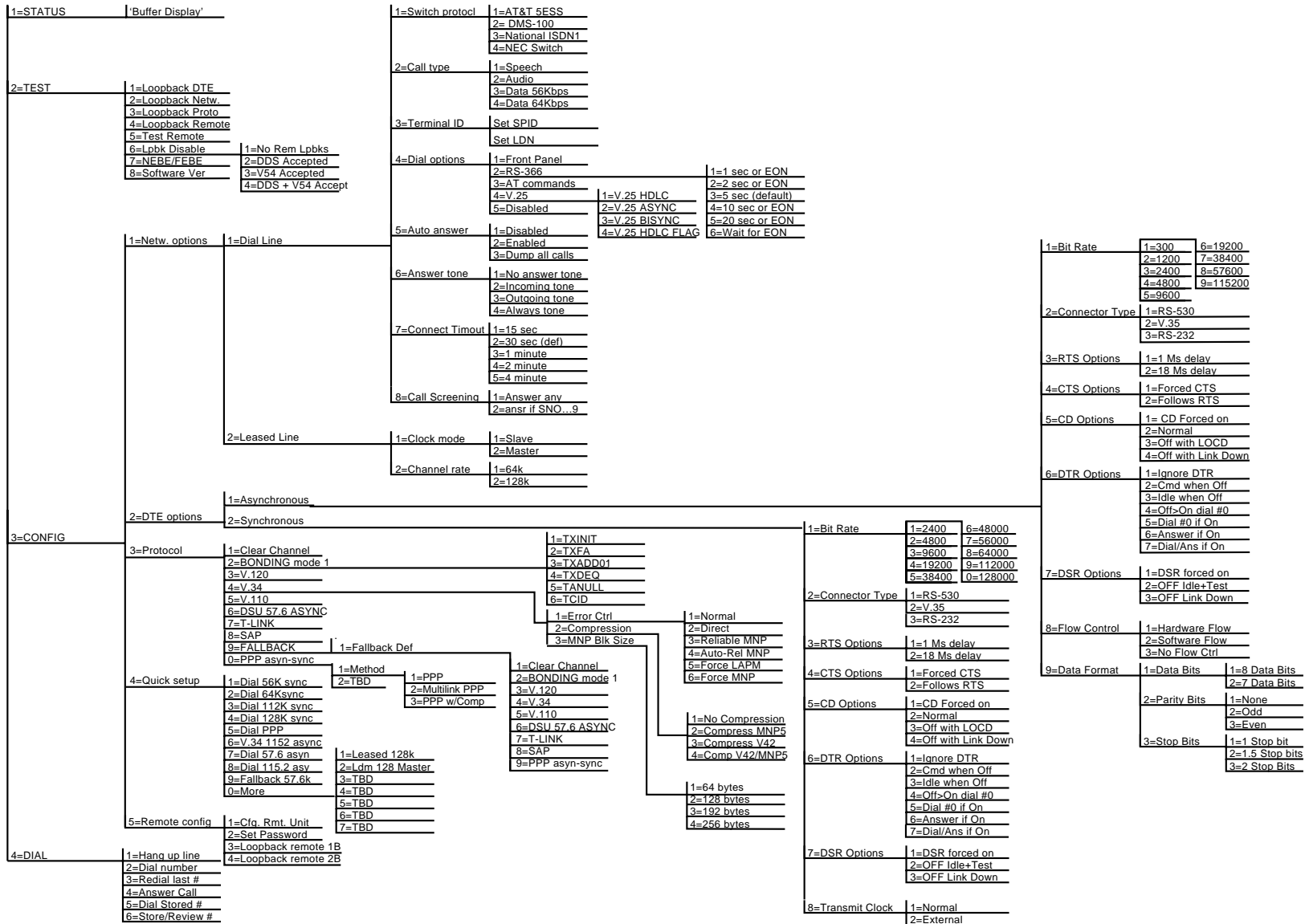

**Figure 6-3**  
Configuration Menu Tree



## Dial options

The ISU 128 can be configured to dial using the Front Panel, RS-366 port, AT Commands, or V.25 bis Commands. Figure 6-4 illustrates the menu tree.

### Front Panel

To establish and disconnect calls from the front panel keypad, configure **Dial options** for **Front Panel**. See the section *Front Panel Dialing Options* for more detail.

### RS-366

To establish and disconnect calls using the RS-366 parallel dialing port, configure the unit for RS-366 dialing. This enables the RS-366 port on the rear of the unit. Whenever this dialing mode is enabled, DTR must be active before a call is placed. The call may be disconnected by dropping DTR, or from the front panel by selecting the # (pound) key to go directly to the Dial menu and selecting **1=Hang up line**, then **Enter**.

DTE RS-366 dialers can end a string of dialed numbers in two different ways. The end of number (EON) alerts the ISU 128 that the entire number has been sent. Another method is to simply stop sending numbers and allow the ISU to time out, then dial the number. The ISU 128 supports both methods of dialed number terminations. The following options in Figure 6-4 allow for fine-tuning the dialed number termination.

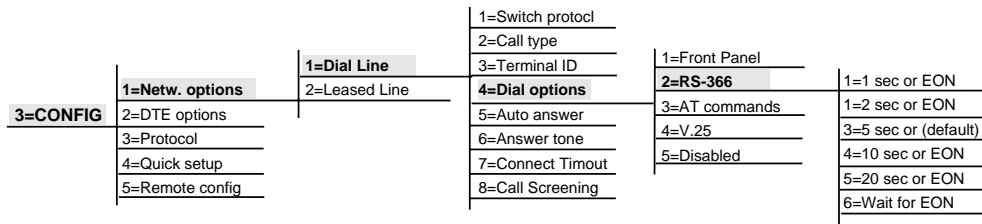

**Figure 6-4**  
*Dial Options, RS-366 Menu Tree*

**1 sec or EON**

The ISU 128 assumes the dial string is fully entered if more than one second elapses since the last digit was entered, or the unit receives the EON command.

**2 sec or EON**

The ISU 128 assumes the dial string is fully entered if more than two seconds elapse since the last digit was entered, or the unit receives the EON command.

**5 sec or EON (default)**

The ISU 128 assumes the dial string is fully entered if more than five seconds elapse since the last digit was entered, or the unit receives the EON command. This is the factory default setting.

**10 sec or EON**

The ISU 128 assumes the dial string is fully entered if more than 10 seconds elapse since the last digit was entered, or the unit receives the EON command.

**20 sec or EON**

The ISU 128 assumes the dial string is fully entered if more than 20 seconds elapse since the last digit was entered, or the unit receives the EON command.

**Wait for EON**

The ISU 128 assumes the dial string is fully entered only if the unit receives the EON command.

## AT Commands

Configuring the ISU 128 for AT commands enables in-band dialing over the DTE interface using asynchronous AT commands. AT commands can be used to set up the ISU 128 as well as establish and end a call. Calls can be disconnected from the front panel (as previously described) or from the far-end unit.

When AT commands are selected, the DTE port becomes dual purpose. First, while a call is not established, the port accepts AT commands. During this time, the Carrier Detect (CD) signal is inactive. Second, when a call is established, the port is used for data. This data mode is indicated by the CD signal active. See the appendix *AT Commands* for a listing of the supported AT commands and their functions. In addition to the front panel, the ISU 128 can be configured and controlled with in-band AT commands from an asynchronous DTE port.

To exit the data mode and enter the command mode, the asynchronous DTE device must transmit a proper escape sequence to the ISU 128. A specified time delay must occur between the last data character and the first escape sequence character. This is the guard time delay, and it can be changed by writing a value to the S12 register. The default value for the guard time is one second. For a valid escape sequence to occur, the DTE must transmit the escape code character three times in succession with delay between each character being less than the guard time. The default escape sequence is +++.

Once the command mode is entered, AT commands can be transmitted to the ISU 128 to configure most of the options, dial remote DSUs, or initiate tests to check both the ISU 128 and the network connections. All command lines must begin with the AT character set in either capital or lower case letters and end with a terminating character. A command line can be terminated at any time by transmitting the **Ctl-X** (ASCII 018) after the AT attention code. The ISU 128 ignores this command line and issues an **OK** response.

The command line may contain a single command or a series of commands after the AT attention code. When a series of commands are used, the individual commands may be separated with spaces for readability. The maximum length for a command line is 40 characters. Each command line is executed by the ISU 128 upon receipt of a terminating character.

The default terminating character is a carriage return (ASCII 013), but it can be changed by writing a different value to register S3. Before the terminating character is transmitted, the command line can be edited by using the back-space character (ASCII 008) to erase errors so the proper commands can be entered. Examples of using AT commands are provided in this section.

### Using AT Commands

Type **AT** followed by the letter of the command and numeric value of the setting desired and then press **Enter**. The following command returns the software version of the unit:

```
ATI1
```

### Using S-Registers

The configuration of the ISU 128 can be changed and/or reviewed with S-registers. See the appendix *S-Register List* for a description of each S-register and its corresponding range of values.

### Reading S-Registers

Type **ATS** followed by the number of the S-register to be read followed by a question mark and press **Enter**.

```
ATS0?
```

### Reading S-Register Strings

The ISU 128 uses S-register strings to store strings of digits for stored phone numbers, SPIDs, etc. Type **ATSS** followed by the number of the string S-register to be read followed by a question mark and press **Enter**.

```
ATSS80?
```

### Changing S-Registers

Type **ATS** followed by the number of the S-register to be changed, an equal sign, the numeric value to be assigned to the register, then press **Enter**.

```
ATS0=2
```

### Changing S-Register Strings

Type **ATSS** followed by the number of the string S-register to be changed, an equal sign, the numeric string to be assigned to the register, then press **Enter**.

```
ATSS80=5551212
```

### Dialing a Call Using the AT Command Processor

To dial a number using the DTE terminal and AT commands type **ATD** and the telephone number on one line and press **Enter**.

```
ATD5551212
```

When the dialing process begins, the front panel reads **Dialing 5551212**. If the call is successful, **Connect** is displayed on the front panel, followed by the rate adaption protocol in use and the bit rate. If the call is not successful, the front panel displays **Disconnect** followed by **Ready**. At this point the unit is ready for another call. The status buffer can be examined to find the reason for an unsuccessful call.

To end an active call with the AT command processor, press the break in key sequence (+++) or the redefined key, then type **ATH** and press **Enter** to hang up the line.

## V.25 bis

Configuring the ISU 128 for **V.25 bis** (see Figure 6-5) enables in-band dialing over a DTE interface using asynchronous or synchronous V.25 bis commands. V.25 bis can be used to establish and end a call. Disconnecting calls can also be done from the front panel (as previously described) or from the far-end unit.

V.25 bis dialing is used primarily by DTE with synchronous interfaces (HDLC/SDLC or BSC/BISYNC) not supporting the AT command set, which is commonly used by asynchronous devices. The ISU 128 supports V.25 bis in-band dialing in accordance with Fascicle VIII.I - V.25 bis (Malaga-Torremolinos 1984, Melbourne 1988).

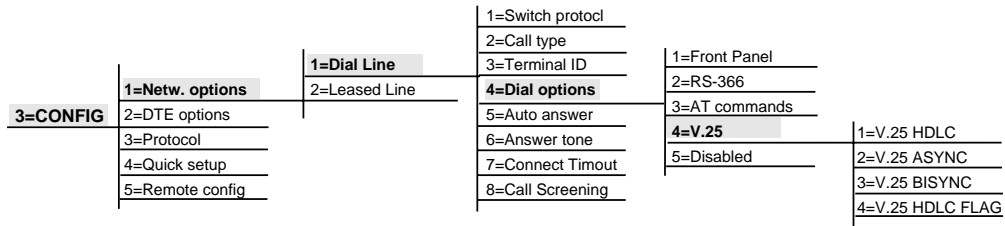

**Figure 6-5**  
Dial Options, V.25 bis Menu Tree

Recommendation V.25 uses the following DCE/DTE control signals:

Transmitted data .....	circuit 103
Received data .....	circuit 104
Ready for sending .....	circuit 106
Data set ready .....	circuit 107
Data terminal ready .....	circuit 108/2
Calling indicator .....	circuit 125

The ISU 128 supports the following V.25 bis commands to control automatic calling and answering:

CRN .....	call request (number in command)
CRS .....	call request (using stored number)
PRN .....	program stored number
RLN .....	list stored number
CIC .....	connect incoming call
DIC .....	disconnect incoming call





When using stored numbers, V.25 bis accesses stored numbers 1 through 9 used by front panel dialing. See *Front Panel Dialing Options*.

Auto Answer should be set to **Disabled** (shown in Figure 6-6) if V.25 bis is in control of answering incoming calls with the CIC/DIC commands, since the other settings for **Auto Answer** will override V.25 control of the answer function.

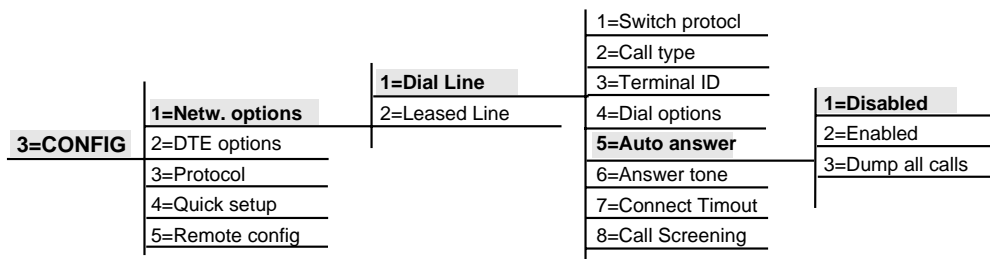

**Figure 6-6**  
*Dial Line, Auto Answer Menu Tree*

### V.25 ASYNC Dialing

V.25 bis specifies that the characters should be ASCII, 7 bits, even parity and one stop bit. However, for versatility the ISU 128 allows the data, parity, and stop bits as defined under **Data bits**. (See Figure 6-7.)

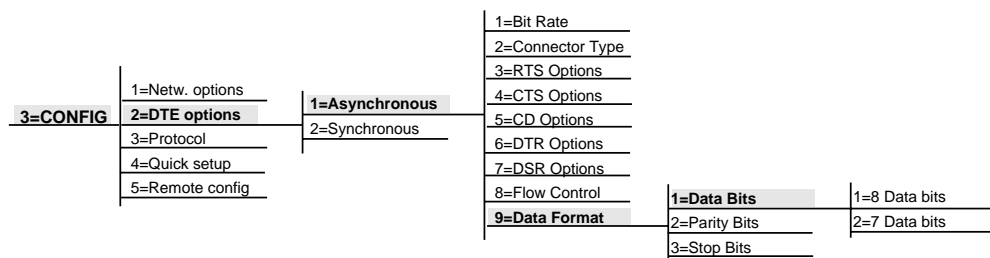

**Figure 6-7**  
*Data Bits Menu Tree*

The setting in Figure 6-8 allows for V.25 bis messages in asynchronous (start/stop) data format.

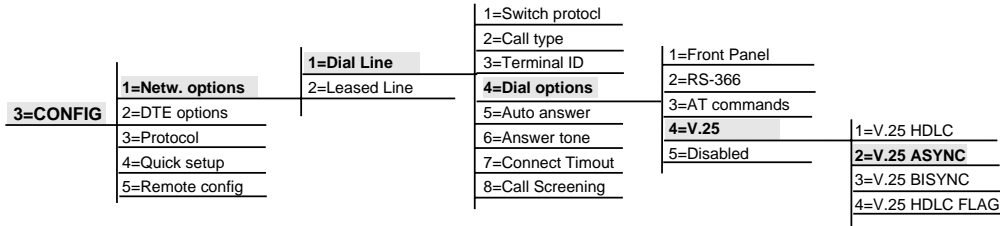

**Figure 6-8**

*V.25 bis ASYNC Menu Tree*

Although V.25 bis allows asynchronous data format, asynchronous DTE is more likely to support the AT command set than V.25 bis.

### V.25 SYNC HDLC Dialing

This setting provides V.25 bis messages in bit-synchronous format (for example HDLC, SDLC, X.25). The bit-synchronous format is the most commonly used by V.25 bis.

This option specifies that the characters should be 7-bit ASCII, with the 8th bit ignored (it may be either 0 or 1).

The first byte of each packet contains all ones (A = FF HEX), and the second byte of each packet (the C byte) is either 13 HEX or 03 HEX if not the final packet.

### V.25 SYNC BISYNC Dialing

This setting allows for V.25 bis messages in byte synchronous format (BISYNC). V.25 bis specifies that the characters should be ASCII, 7 bits, and odd parity. This setting allows synchronous DTE which does not use HDLC to support serial in-band dialing.

### V.25 HDLC FLAG

Configuring the ISU 128 for HDLC FLAG V.25 bis enables in-band dialing over a DTE interface using standard synchronous HDLC V.25 bis commands with 0x7E hex idle.

### Disabled

This selection disables in-band dialing over the DTE interface.

## Auto Answer

The ISU 128 auto answer parameter can be configured in one of three ways: Disabled, Enabled, or Dump all calls.

### Disabled

When **Disabled** is selected, the ISU 128 will not automatically answer an incoming call. The AT answer command (ATA) must be issued to the ISU 128 before it accepts the incoming call. The ringing call can be dumped using the **Hang up line** command, or answered using the **Answer Call** command. These commands are listed under the **Dial** branch of the main tree. See the chapter *Dial Options* for more detail.

### Enabled

When **Enabled** is selected, the incoming call is answered. If that call is a BONDING call and requires two B channels, the second call is answered. If the unit is configured for a call that uses only one B channel, such as 56 kbps or 64 kbps, the ISU 128 will not accept a second incoming call.

### Dump all calls

When **Dump all calls** is selected, the ISU 128 will not accept any incoming calls. This keeps the line clear for outgoing calls.

## Answer Tone

The **Answer tone** option (shown in Figure 6-9) enables the transmission of a modem answer tone at the start of voice and audio calls. The purpose of this tone is to disable echo suppression and echo cancelling on the circuit in order to get a clear digital circuit. This may be necessary on some long distance circuits. The specifics of the tone are 4 seconds, 2100 Hz at a -10 dB level, with phase reversals every 475 ms.

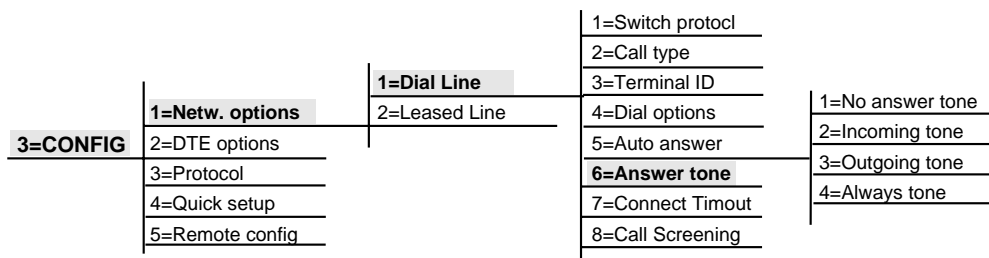

**Figure 6-9**  
*Answer Tone Menu Tree*

### No Answer Tone (Default)

This option disables **Answer tone** on incoming calls.

### Incoming Tone

This option enables **Answer tone** on incoming calls.

### Outgoing Tone

This option enables **Answer tone** on outgoing calls.

### Always Tone

This option enables **Answer tone** on either incoming or outgoing calls.

## Connect Timeout

**Connect Timeout** sets the length of time that the ISU 128 waits for a far-end unit to answer an outgoing call. These choices are illustrated in Figure 6-10.

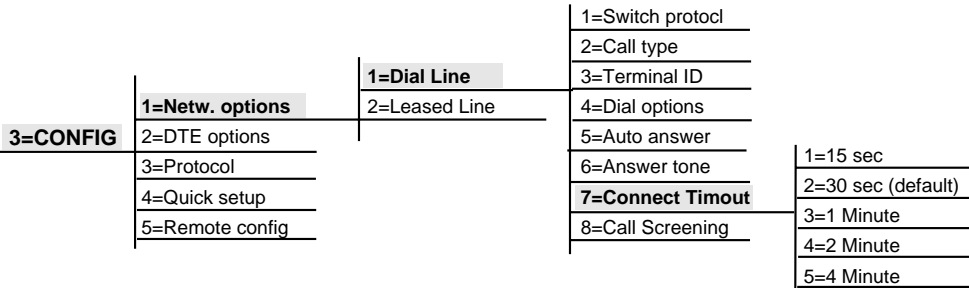
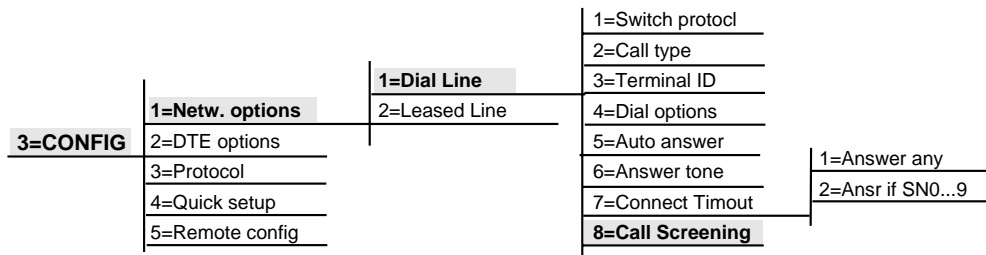

**Figure 6-10**

*Connect Timeout Menu Tree*

## Call Screening

**Call Screening** allows the ISU 128 to answer all incoming calls (default) or only calls originating from phone numbers stored in the **DIAL** menu as stored numbers SN0 through SN9. See the section *Front Panel Dialing Options*, to review how to store numbers. Figure 6-11 illustrates the menu tree for setting call screening.



**Figure 6-11**

*Call Screening Menu Tree*

When Call Screening is set to answer any numbers if stored in SN0 through SN9 (Ansr if SN0...9), an incoming call is not answered if the Call ID received from the switch does not match a stored number. Depending on the switch protocol, the Call ID may be presented in either a seven- or ten-digit format.

---

The ISU 128 displays the Call ID for all dumped calls in the Status buffer. See the section *Status Buffer* for more information on the Status buffer.

Because different switches handle calls and Call ID differently, use the following procedure to determine if a seven or ten digit Call ID (phone number) should be stored:

1. Select **Ansr if SN0. .9** under **Call Screening**.
2. Store your seven digit number in SN0.
3. Place a call to the ISU 128 with the stored number to determine whether it answers properly.
4. If the ISU 128 does not answer the call, look at the Call ID message in the Status buffer. An explanation of Status buffer messages is located in the appendix *Status Buffer Messages*. More than likely, the Call ID number is a ten digit number
5. Reenter the number in SN0 as it is displayed in the Call ID message and test **Call Screening** again.

## LEASED LINE SERVICE

This section explains how to configure the ISU 128 when using a 2B1Q leased digital service or a service that provides a permanent connection between end points. Figure 6-12 illustrates the menu tree for setting leased line.

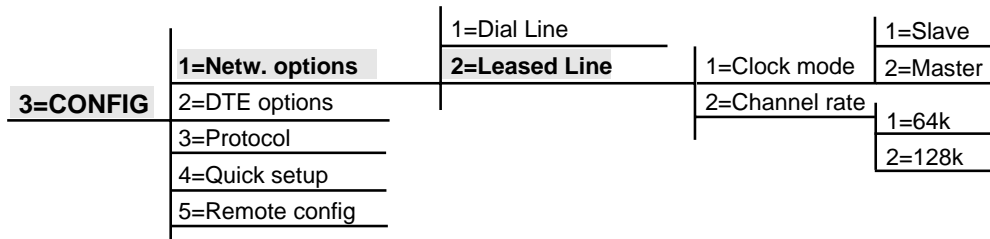

**Figure 6-12**  
*Leased Line Menu Tree*

Selecting leased line configures the unit for leased line service or service that provides a permanent connection between end points such as limited distance modem.

Follow this step-by-step procedure to configure the ISU 128 for **Leased Line Clock mode** and **Channel rate**.

### Clock Mode:Slave/Master

By configuring the ISU 128 for **Master** timing, the ISU 128 can provide clocking for both ends of the phone line. This **Master** option is used at one end of a limited distance modem application, where two ISU 128 units are directly connected without the use of channel banks (see Figure 6-13). The far-end unit should be configured for **Slave** and it derives its clocking from the ISU 128 configured as **Master**.

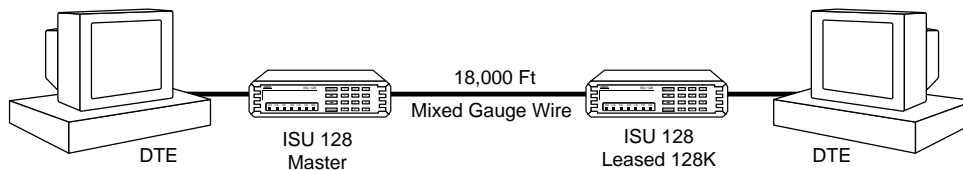

**Figure 6-13**  
*Limited Distance Modem Application*

If two ISU 128 units are connected through channel banks, both units should be configured for **Slave** mode (see Figure 6-14). To easily configure ISU 128s for this application, one unit can be optioned using Quick Setup, Ldm 128 Master and the other using Quick Setup, Leased 128k sync. For more information, refer to the chapter *Quick Setup*.

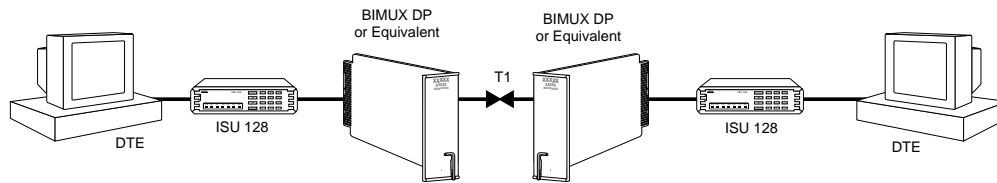

**Figure 6-14**  
*Leased Application with Channel Banks*

## Channel Rate

In **Leased Line** operation, the data rate for the ISU 128 can be configured for 64 kbps or 128 kbps. When 64 kbps is selected, only one bearer channel (B1) is used. When 128 kbps is selected both bearer channels (B1 and B2) are used.



## DTE OPTIONS

The following procedure configures the DTE options for asynchronous and synchronous applications. Figure 6-15 and Figure 6-16 illustrate the menu trees for both asynchronous and synchronous operation.



Ensure your DTE equipment is set for asynchronous operation before attempting to make an asynchronous call. Failure to do so will cause the call attempt to fail.

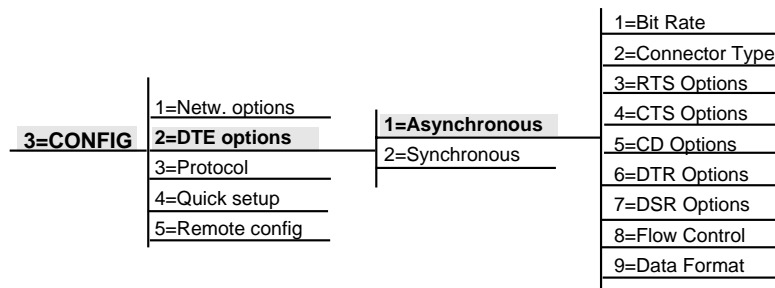

**Figure 6-15**

*Asynchronous DTE Options Menu Tree*

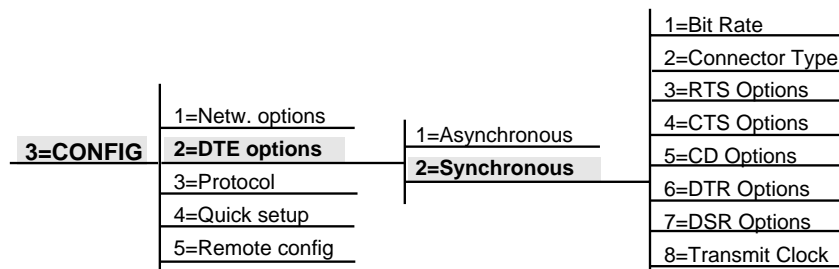

**Figure 6-16**

*Synchronous DTE Options Menu Tree*

### Bit Rate

The **Bit Rate** can be set *asynchronously* for 300, 1200, 2400, 4800, 9600, 19200, 38400, 57600, and 115200 bps.

The **Bit Rate** can be set *synchronously* for 2400, 4800, 9600, 19200, 38400, 48000, 56000, 64000, 112000, and 128000 bps.

---

## Connector Type

The ISU 128 can provide an EIA-232, RS-530, or V.35 interface to a DTE by selecting the desired connector type.

## RTS Options

Selecting **1 MS delay** causes the Clear-to-Send (CTS) signal to change states 1 millisecond after the DTE Ready-to-Send (RTS) signal changes state. The **18 MS delay** causes the CTS signal to change state 18 milliseconds after the DTE RTS signal changes state.

## CTS Options

Selecting **Forced CTS** causes the CTS signal on the DTE connector to be continually asserted. Selecting **Follows RTS** causes the CTS signal to follow the state of the RTS lead.

## CD Options

Selecting **CD Forced on** causes the carrier detect (CD) signal to always be asserted. Selecting **Normal** causes the CD signal to be asserted when a call has been successfully established. Selecting **Off with LOCD** causes the CD signal to be disasserted for a period of 5 seconds, then reasserted at the termination of a call. Selecting **Off with Link Down** causes the CD signal to be disasserted when the U-interface is not present.

## DTR Options

Selecting **Ignore DTR** causes the ISU 128 to disregard the state of the data terminal ready (DTR) pin. **Cmd when Off** forces the unit into the AT command processor mode when DTR is not asserted. To return on-line, DTR must be asserted, followed by the AT0 command. **Idle when Off** forces the unit to end the current call when DTR is no longer asserted. **Off>On dial #0** allows one call attempt to be automatically established when the DTR signal goes from inactive to active. While DTR is active, front panel dialing is also possible. When DTR goes inactive, any outgoing call present is disconnected. **Off>On dial #0** uses the phone number in stored number register 0 to establish the call. To store a number for automatic dialing see the chapter *Dialing Options*. Selecting **Dial #0 if On** allows calls to be automatically established when the

DTR signal is in the active state. The unit attempts to establish a call using SNO until the call is established or DTR goes inactive. Selecting **Answer if On** only allows the unit to answer an incoming call if the DTR signal is asserted. **Dial/Ans if On...** allows the unit to dial Stored Number 0 or answer if DTR is asserted.

### DSR Options

Selecting **DSR forced on** causes the Data Set Ready (DSR) signal on the DTE connector to always be asserted. Selecting **OFF Idle+Test** causes DSR to be disasserted if the network interface is in test or there is not an active call. **OFF Link Down** causes DSR to be disasserted if the network interface is disrupted.

### Flow Control (Asynchronous Data Format)

Selecting **Hardware Flow** (as shown in Figure 6-17) causes the ISU 128 received data to be presented to the DTE interface only when RTS is asserted. **Software Flow** control uses **Xon/Xoff** to control data transferred between the DTE and the ISU 128. Selecting **No Flow Ctrl** disables flow control.

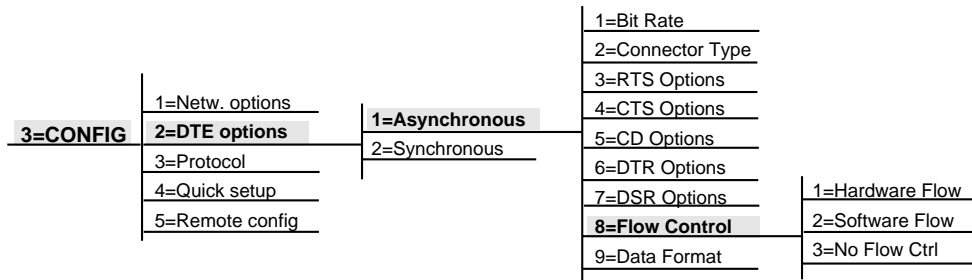

**Figure 6-17**  
*Flow Control Menu Tree*

## Data Format (Asynchronous)

A frame consists of a start bit, 7 or 8 data bits, 0 or 1 parity bit, and 1 to 2 stop bits. The settings for **Data Bits**, **Parity Bits**, and **Stop Bits** are available as shown in Figure 6-18.

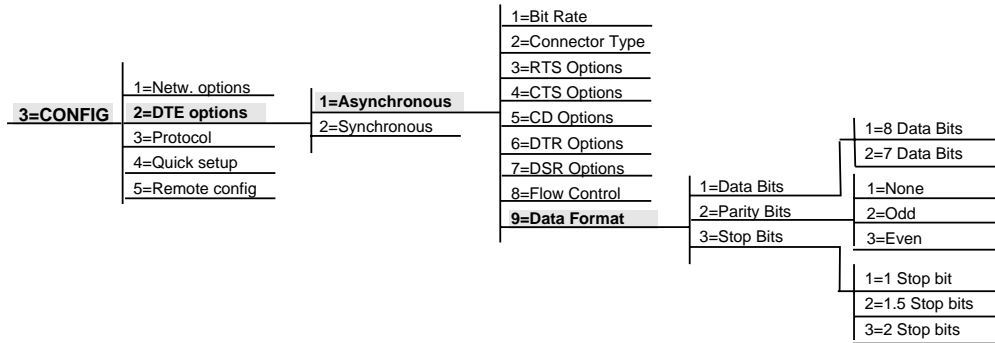

**Figure 6-18**  
*Data Format Menu Tree*

## Transmit Clock (Synchronous Data Format)

Selecting the **Normal** option causes the ISU 128 to be the synchronous DTE interface transmit timing source. Transmit data is timed from the transmit clock provided by the ISU 128 on the DTE connector. **Normal clock** is the normal mode of operation for the ISU 128.

With the **External** option selected, the ISU 128 slaves to an external transmit timing source. The external clock is provided to the ISU 128 by the external transmit clock signal at the DTE connector. This signal is echoed by the ISU 128 to the transmit clock signal on the DTE connector.

This option provides for situations where equipment connected to the ISU 128 DTE connector cannot slave to the ISU 128 provided clock. The ISU 128 uses the U-interface as the frequency standard when it must provide a synchronous receive or transmit clock. The externally provided clock must be of the same average frequency as the clock that the ISU 128 would provide if internal clock were selected. If this is not the case, then bit errors may occur.

## Chapter 6. Configuration

---

# Chapter 7

## Protocol Options

---

### PROTOCOL OPTIONS

The ISU 128 communicates with many different types of telecommunication equipment including other ISU 128s, ISDN terminal adapters, Switched 56 DSUs, BONDING-compatible inverse multiplexers, and V.34 (1202029L3 only) compatible analog modems. Communicating between such diverse types of equipment requires the use of various rate adaptation protocols to support various bit rates and DTE settings. Figure 7-1 illustrates the menu tree for setting protocol options. The ISU 128 supports the following rate adaptation protocols:

- Clear Channel (no rate adaptation protocol)
- BONDING mode 1 (Bandwidth on Demand Interoperability Group)
- CCITT V.120
- CCITT V.110
- V.34 (for communicating with analog modems)  
V.34 is only available in PN 1202029L3
- DSU 56.7 Async (for communication with ADTRAN DSUs)
- TLINK (Dial Switched 2-wire 56 or Datapath DSU)
- SAP (Simple ADTRAN Protocol)
- FALLBACK
- Point-to-point protocol (PPP) asynchronous to synchronous conversion

<b>3=CONFIG</b>	1=Netw. options	1=Clear Channel
	2=DTE options	2=BONDING mode 1
	<b>3=Protocol</b>	3=V.120
	4=Quick setup	<b>4=V.34</b>
	5=Remote config	5=V.110
		6=DSU 57.6 ASYNC
		7=T-LINK
		8=SAP
		9=FALLBACK
		0=PPP asyn-sync

**Figure 7-1**  
Protocol Menu Tree

See the section *Recommended Operating Protocols* and *Table 1-B* in Chapter 1 for more information on recommended modes of operation.

The desired protocol may be selected with AT commands at the DTE port or from the ISU 128 front panel. A description of each protocol follows.

## Clear Channel

**Clear Channel** provides the entire bearer channel to the DTE without regard to data format or protocol. This provides a rate adaptation at or near the ISDN circuit rate. The primary usage for **Clear Channel** in the dial line mode is for 56 kbps and 64 kbps synchronous. It is useful when the DTE performs its own internal synchronous protocol/rate adaptation or the ISU 128 is calling a 4-wire Switched 56 DSU. In the leased line mode, **Clear Channel** can provide synchronous bit rates of 56 kbps, 64 kbps, 112 kbps, and 128 kbps.

## BONDING Mode 1

The **BONDING mode 1** protocol allows the ISU 128 to communicate at bit rates in excess of 64 kbps to a maximum of 128 kbps. **BONDING** provides high-speed communication between ISU 128s, ISDN TE/TAs, and inverse multiplexing equipment supporting the **BONDING** protocol. The protocol allows use of both synchronous and asynchronous bit rates. When the ISU 128 uses the **BONDING mode 1** protocol, it must make two separate ISDN phone calls to seize control of both ISDN bearer channels. The protocol corrects any delays existing between the two bearer channels and presents a single high-speed data channel to the DTE. For successful high-speed operation, both the

near- and far-end DCE need to be configured to use the **BONDING mode 1** protocol. Also, if the second B channel number is different from the first B channel, it is important that the 7-digit LDN is programmed in the answering unit. The **BONDING mode 1** protocol negotiation phase has numerous timers to allow for transmission delays due to satellite hops, international calls, etc. The timers may be adjusted if necessary by entering into the **BONDING mode 1** submenu. Figure 7-2 illustrates the menu path for setting the timers.

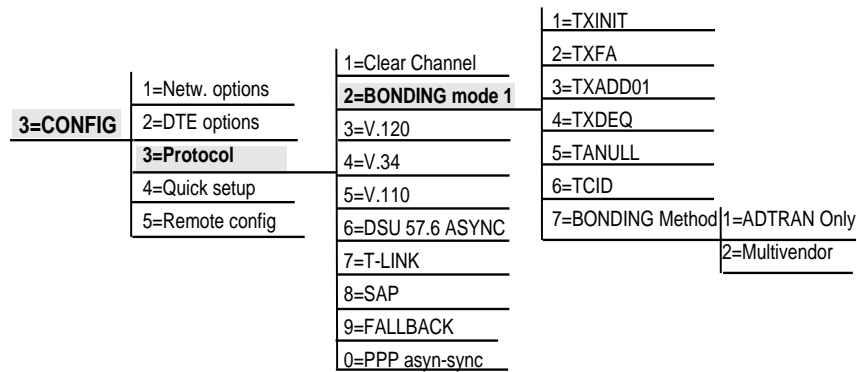

**Figure 7-2**  
*BONDING Mode 1 Protocol Menu Tree*

The timers are defined as follows:

**TXINIT**

This option specifies the length of time the originating endpoint attempts to detect the BONDING negotiation pattern from the answering endpoint before deciding the BONDING call has failed. In general, this timer value should be left at the factory default setting of 10 seconds. Values of 1, 2, 5, 10 (default), 20, 50, 100, and 200 seconds may be selected.

**TXFA**

This option specifies the length of time both endpoints attempt to detect the BONDING frame pattern when a call is connected before deciding the BONDING call has failed. This timer value should be left at the factory default setting of 10 seconds. However, when interoperating with other manufacturers' BONDING equipment, it may be necessary to lengthen this timer so that it matches TXADD01. Values of 1, 2, 5, 10 (default), 20, 50, 100, and 200 seconds may be selected.



### **TXADD01**

This option specifies the length of time both endpoints wait for the additional call to be connected at the end of negotiation before deciding the BONDING call has failed. The factory default setting of 20 seconds will be sufficient for most calls to go through, although when dialing overseas it may be necessary to lengthen this timer to allow for slower call routing. Values of 1, 2, 5, 10, 20, 50 (default), 100, and 200 seconds may be selected.

### **TXDEQ**

This option specifies the length of time both endpoints attempt to equalize the network delay between the bearer channels before deciding the BONDING call has failed. The default setting is 50 seconds. Values of 1, 2, 5, 10, 20, 50 (default), 100, and 200 seconds may be selected.

### **TANULL**

This option specifies the length of time the answering endpoint attempts to detect the BONDING negotiation pattern from the originating endpoint before aborting to clear channel mode. In general, this timer value should be left at the factory default setting of 10 seconds. However, it may be necessary to shorten this timer, if the DTE equipment connected to the ISU also has timer constraints for completing non-BONDING parameter negotiation. Values of 1, 2, 5, 10 (default), 20, 50, 100, and 200 seconds may be selected.

### **TCID**

This option specifies the length of time both endpoints attempt to negotiate an agreeable value for bearer channels and channel capacities before deciding the BONDING call has failed. This timer default setting is 5 seconds. Values of 1, 2, 5 (default), 10, 20, 50, 100, and 200 seconds may be selected.

## **V.120**

The **V.120** protocol is a CCITT compliant rate adaption method which provides DTE service between the ISU 128 and other V.120 compliant devices at rates less than the 64 kbps ISDN bearer channel rate. **V.120** supports synchronous and asynchronous DTE rates. See the section *Recommended Operating Modes* and *Table 1-B* in Chapter 1 for available V.120 rates. Figure 7-2 illustrates the menu path for selecting V.120.

## V.110

The **V.110** protocol is a CCITT compliant rate adaption method which provides DTE service between the ISU 128 and other V.110 compliant devices. **V.110** supports synchronous and asynchronous DTE rates. See the section *Recommended Operating Modes* and *Table 1-B* in Chapter 1 for available V.110 rates. Figure 7-2 illustrates the menu path for selecting V.110.

## V.34

The **V.34** protocol allows the ISU to originate and receive calls to analog modems on POTS lines. The V.34 modem only supports asynchronous DTE rates. To place an outgoing call to an analog modem, the call type must be changed to **Audio**. See *Call Type* in Chapter 6 to change call types. Figure 7-3 illustrated the menu path for selecting the V.34 modem operational parameters.



*The ISU 128 with optional V.34 modem (part number 1202029L3) must be used for operation of this protocol.*

### Error Control

This option sets the type of error control to be negotiated with the far-end modem during train-up. **Normal** turns all error control off and makes allowances for flow control. **Reliable MNP** uses MNP error control. If the far end does not support MNP then the call is terminated. When **Auto-Rel MNP** is selected, the ISU 128 attempts to use MNP error control. If the far end does not use MNP then normal operation is used. **Force LAPM** allows only LAPM (V.42) error corrected calls to connect. **Force MNP** allows only MNP error corrected calls to connect.

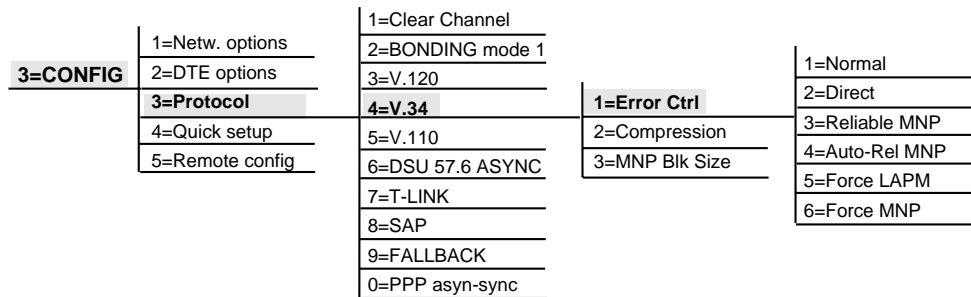

**Figure 7-3**  
V.34 Error Control Menu Tree

**Compression**

**No Compression** turns off the MNP5 compression algorithms in the ISU 128. **Compress MNP5** enables MNP5 data compression. **Compress V42** enables V.42 bis data compression. **Compress V42/MNP5** allows the 128 to negotiate MNP5 or V.42 bis compression.

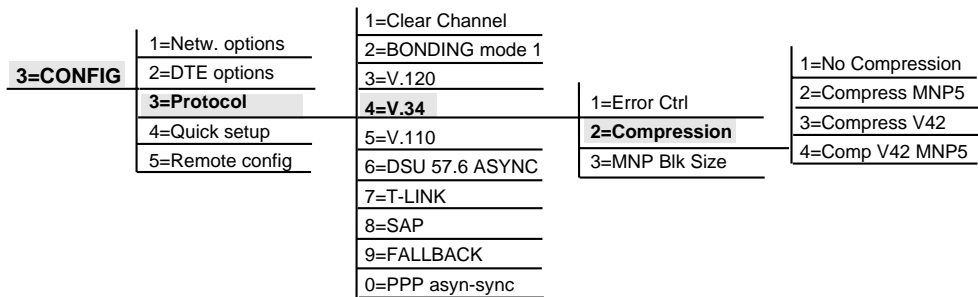

**Figure 7-4**  
*V.34 Compression Menu Tree*

**Microcom™ Network Protocol Block Size (MNP® Blk)**

When error control is enabled, this option sets the amount of data sent in a single packet during MNP error-controlled stream operation. Options available are 64, 128, 192, and 256 bytes.

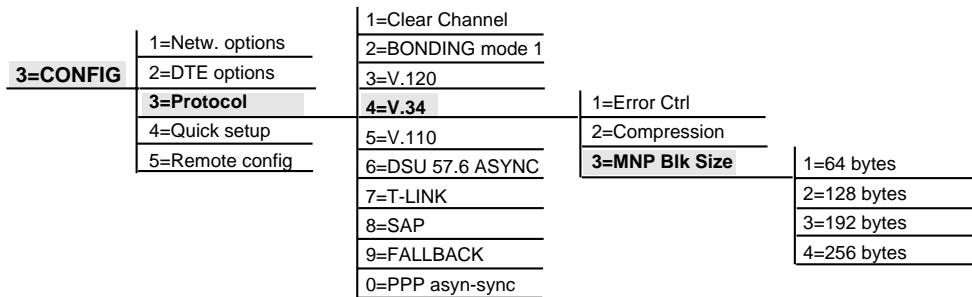

**Figure 7-5**  
*V.34 MNP Block Size Menu Tree*

## **DSU 57.6 ASYNC**

The **DSU 57.6 ASYNC** or **DSTOP** protocol allows the ISU 128 to communicate asynchronously at 57.6 kbps with ADTRAN 2- and 4-wire Switched 56 DSU products. In addition, the ISU 128 will communicate with other ISUs over dial and leased connections using this protocol. Figure 7-1 illustrates the menu path for setting the **DSU 57.6 ASYNC** protocol.

## **T-Link**

The **T-Link** protocol allows the ISU 128 to communicate with 2-wire Switched 56 DataPath Data Units (DUs) such as the ADTRAN DSU III 52W. The T-Link protocol performs two functions:

- The T-link protocol adapts DTE data subrates of 64 kbps to the 64 kbps bandwidth of the ISDN bearer channel.
- For asynchronous and synchronous DTE rates up to 19.2 kbps, **T-Link** transmits the status of the DCE-DTE EIA leads to facilitate flow control and maintenance.

In addition to 2-wire Switched 56 DataPath DUs, the ISU 128 can communicate with any other device that uses the T-Link protocol. Figure 7-1 shows the menu path for selecting **T-Link**.

## **Simple ADTRAN Protocol (SAP)**

Simple ADTRAN Protocol (SAP) is a rate adaption method providing DTE service between ISU 128 units at a sub 64 kbps ISDN bearer channel rate. Selecting this menu item causes the ISU 128 to use **SAP** protocol.

The primary usage for SAP is general purpose asynchronous rate adaption in a dial-up or leased environment. SAP only operates on a 64 kbps data link. See Figure 7-2 for the menu path to select **SAP**.

## FALLBACK

The **FALLBACK** asynchronous rate adaption protocol provides the capability to automatically establish calls with other ISDN terminal adapters, Switched 56 DSUs, V.34 modems (optional), as well as other ISUs using a single configuration. To communicate with analog modems, the ISU 128 with V.34 modem option (part numbers 1202029L3) must be used.

The ISU 128 must be optioned as follows for **FALLBACK** operation:

- Any asynchronous bit rate up to 115.2 kbps which is supported by the DTE.
- Flow control must be enabled and supported by the DTE.

**FALLBACK** supports the following protocols based on the call type: BONDING Mode 1, V.120, T-Link, and V.34.

When answering calls, the ISU 128 uses the incoming call type to determine which rate adaption protocols to support. See Table 7-A for the call type and the supported rate adaption protocols.

**Table 7-A**  
*Rate Adaption Protocols*

Call Type	Rate Adaption Protocols Supported	Typical Units Supported
Data 64k	BONDING Mode 1 V.120 PPP	ISUs ISDN TAs PPP compatible bridges/routers
Data 56k	V.120 T-Link PPP	ISDN TAs 2-Wire Switched-56 DSUs PPP compatible bridges/routers
Speech or Audio	V.34	V.34 compatible modems

When originating calls to unknown units, the ISU begins protocol selection based on the local call type. Data 64k is used for **FALLBACK** selected from **Quick Setup** menu. Upon connection at 64k call type, BONDING, V.120, and PPP are attempted. If connection is not made at 64k, the ISU 128 attempts another call at 56k call type. If connection is made at 56k, then V.120, T-Link, and PPP are attempted. If connection is not made at 56k, then an audio call type is attempted, provided the ISU 128 with the V.34 modem option is used. If the ISU connects the audio call type, the V.34 protocol is attempted for V.34 compatible modems. Once a call connects, if the protocol cannot be negotiated, the protocol is negotiated as specified by S11 register (default is DSTOP). If this protocol fails, the call is disconnected.

If FALLBACK fails to determine which protocol is running, the user has the option to select which protocol will run. Figure 7-6 illustrates the FALLBACK default settings.

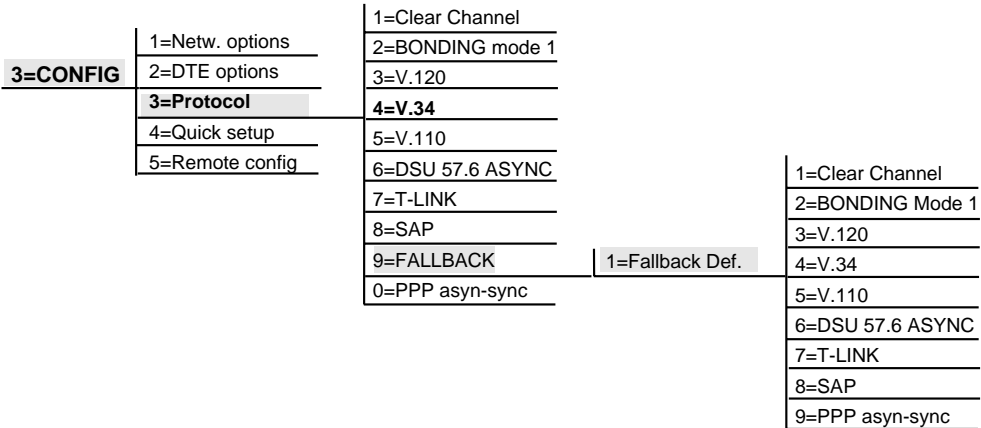
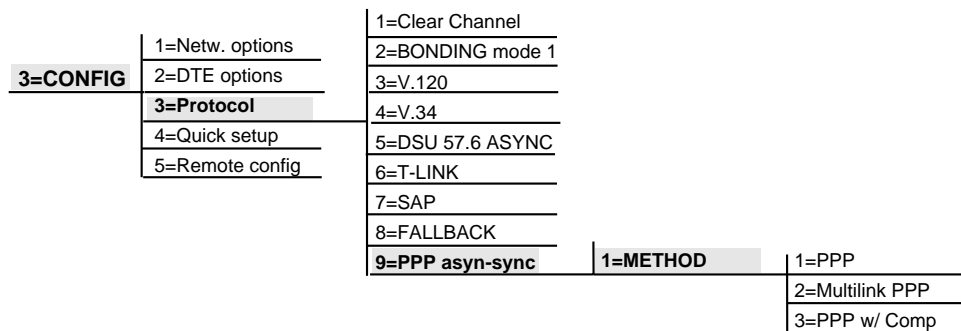

**Figure 7-6**  
*FALLBACK Menu Tree*

## Point-to-Point (PPP) Async-to-Sync

PPP provides a standard method for transporting multi-protocol datagrams over point-to-point links. The ADTRAN PPP async-sync protocol allows the ISU 128 and a PC or Macintosh® running PPP software, to communicate with a PPP-compatible bridge or router. The PPP async-sync protocol complies with Internet Engineering Task Force (IETF) RFC 1662. The menu path to select PPP is shown in Figure 7-7.

The asynchronous control character map (ACCM) option is scanned during the negotiation. When the ACCM option is seen in a configure ACK link control packet, it is adopted by the ISU 128. In addition, when the ACCM option is not seen in the configure-request packet from the network, the ISU 128 adds it to the packet.



**Figure 7-7**  
PPP Menu Tree

### Point-to-Point Protocol (PPP)

The ISU 128 is configured for PPP from the protocol options of the configuration menu by selecting **1=PPP** or by setting S-register S27 to a value of 0. Figure 7-6 illustrates the menu path for setting PPP, Multilink PPP, and PPP w/ Comp.

### Multilink Point-to-Point Protocol (MP)

Multilink PPP is an extension of point-to-point protocol and is a method for splitting and recombining data packets across multiple logical data links.

The ISU 128 is configured for multilink PPP from the protocol options of the configuration menu by selecting **2=Multilink PPP** or by setting S-register S27 to a value of 1. In this mode, the ISU 128 dials a second number to establish a second point-to-point link. Once the second link is established, multilink PPP is performed over both B-channels.

The phone number for the second call should be placed in stored number 1 (SN1). If no number is stored in SN1, the same phone number is dialed to establish the second link.

### **PPP with Compression**

The ISU 128 is configured for PPP with compression from the protocol options of the the configuration menu by selecting **3=PPP w/Comp** or by setting S-register S27 to a value of 2.

When setup for PPP with compression, the ISU 128 will negotiate the compression control protocol (CCP) with the network PPP peer. If STAC™ compression is successfully negotiated with the peer, data packets from the DTE are compressed before being sent out through the network. Likewise, compressed packets from the network are decompressed before being transmitted through the DTE.





# Chapter 8

## Quick Setup

### QUICK SETUP CONFIGURATION

To configure the **DTE Options** quickly and easily, the **Quick Setup** menu is available to automatically set up the most common DTE configurations (Figure 8-1). For fine-tuning a particular application and DTE settings, see the section *DTE Options for Asynchronous and Synchronous Operation* in Chapter 6 for a step-by-step procedure for configuration of the DTE Options.

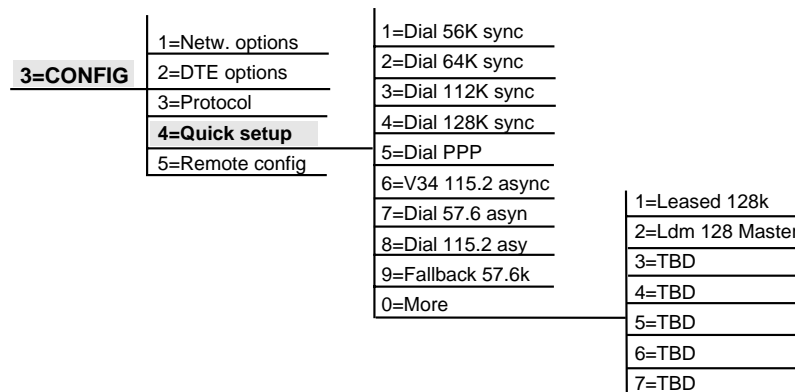

**Figure 8-1**  
*Quick Setup Menu Tree*



**NOTE**

*Option 1=DIAL 56K sync will always flash upon entry of the Quick Setup Menu regardless of previous configuration selections.*

---

## Quick Setup

To assist in configuring the DTE options for the ISU 128, ten common configurations are preset in **Quick Setup**. These include:

- Synchronous dial operation for 56, 64, 112, and 128 kbps
- Asynchronous dial operation for 57.6, and 115.2 kbps
- 128 kbps Leased service
- 128 kbps Limited Distance Modem using Master Clocking
- V.34 modem service
- Fallback 57.6



*In the following descriptions, an asterisk (\*) following the option indicates the option requires ISDN switch protocol to be configured. Multipoint lines will also require SPID1 & LDN1. See the chapter **Dial Options**.*

### **Dial 56K sync\***

When the ISU 128 is configured for **Dial 56K sync** service, the following parameters are automatically preset:

Service type.....	ISDN dial line
Automatic answering.....	Enabled
ISDN call type .....	56 kbps data
Data protocol .....	Clear Channel
DTE mode .....	Synchronous
DTE connector bit rate .....	56 kbps
DTE flow control.....	none
RTS line .....	1 ms delay
CTS line .....	Forced on
Transmit data clock .....	Normal clock source
V.54 Loopbacks .....	Accepted

**Dial 64K sync\***

When the ISU 128 is configured for **Dial 64K sync** service the following parameters are automatically preset:

Service type.....	ISDN dial line
Automatic answering .....	Enabled
ISDN call type .....	64 kbps data
Data protocol .....	Clear Channel
DTE mode .....	Synchronous
DTE connector bit rate .....	64 kbps
DTE flow control.....	none
RTS line.....	1 msec delay
CTS line .....	Forced on
Transmit data clock .....	Normal clock source
V.54 Loopbacks .....	Accepted

**Dial 112K sync\***

When the ISU 128 is configured for **Dial 112K sync** service, the following parameters are automatically preset:

Service type.....	ISDN dial line
Automatic answering .....	Enabled
ISDN call type .....	56 kbps data
Data protocol .....	BONDING mode 1
DTE mode .....	Synchronous
DTE connector bit rate .....	112 kbps
DTE flow control.....	none
RTS line.....	1 ms delay
CTS line .....	Forced on
Transmit data clock .....	Internal clock source
BONDING timer TXINIT .....	10 seconds
BONDING timer TXFA.....	10 seconds
BONDING timer TXADD01.....	50 seconds
BONDING timer TXDEQ .....	50 seconds
BONDING timer TANULL .....	10 seconds
BONDING timer TCID .....	5 seconds
V.54 Loopbacks .....	Accepted

**Dial 128K sync\***

When the ISU 128 is configured for **Dial 128K sync** service, the following parameters are automatically preset:

Service type.....	ISDN dial line
Automatic answering.....	Enabled
ISDN call type .....	64 kbps data
Data protocol .....	BONDING mode 1
DTE mode .....	Synchronous
DTE connector bit rate .....	128 kbps
DTE flow control.....	None
RTS line .....	1 ms delay
CTS line .....	Forced on
Transmit data clock .....	Internal clock source
BONDING timer TXINIT .....	10 seconds
BONDING timer TXFA.....	10 seconds
BONDING timer TXADD01.....	50 seconds
BONDING timer TXDEQ .....	50 seconds
BONDING timer TANULL .....	10 seconds
BONDING timer TCID .....	5 seconds
V.54 Loopbacks .....	Accepted

**Dial PPP\***

When the ISU 128 is configured for **Dial PPP** service, the following parameters are automatically preset:

Service type.....	ISDN dial line
ISDN call type .....	64 kbps data
Data Protocol .....	PPP asyn-sync
DTE mode .....	Asynchronous
Data Bits .....	8
Parity Bits.....	None
Stop Bits.....	1
DTE connector bit rate .....	Hardware
DTE flow control.....	None
RTS line .....	1 msec delay
CTS line .....	Follow RTS

**V34 115.2 async\***

When the ISU 128 is configured for **V34 115.2 async** service, the following parameters are automatically preset:

Service type.....	ISDN dial line
ISDN call type .....	Audio
Data Protocol .....	V.34
DTE mode .....	Asynchronous
Data Bits .....	8
Parity Bits .....	None
Stop Bits.....	1
DTE connector bit rate .....	115.2 kbps
DTE flow control.....	Hardware
RTS line.....	1 msec delay
CTS line .....	Follows RTS
Error Control .....	Auto-reliable
Compression.....	Compress V42/MNP5
MNP block size .....	256 bytes

**NOTE**

*This option is only used with the ISU 128 with V.34 modem option (part numbers 1202029L3).*

**Dial 57.6 asyn\***

When the ISU 128 is configured for **Dial 57.6 asyn** service, the following parameters are automatically preset:

Service type.....	ISDN dial line
ISDN call type .....	64 kbps data
Data Protocol .....	V.120
DTE mode .....	Asynchronous
Data Bits .....	8
Parity Bits .....	None
Stop Bits.....	1
DTE connector bit rate .....	57.6 kbps
DTE flow control.....	None
RTS line.....	1 msec delay
CTS line .....	Forced on

### **Dial 115.2 asyn\***

When the ISU 128 is configured for **Dial 115.2 asyn** service, the following parameters are automatically preset:

Service type.....	ISDN dial line
ISDN call type .....	64 kbps data
Data Protocol .....	BONDING mode 1
DTE mode .....	Asynchronous
Data Bits .....	8
Parity Bits .....	None
Stop Bits.....	1
DTE connector bit rate .....	115.2 kbps
DTE flow control.....	Hardware
RTS line .....	1 msec delay
CTS line .....	Follows RTS

### **Fallback 57.6k\***

When the ISU 128 is configured for **Fallback 57.6k** service, the following parameters are automatically preset:

Service type.....	Dial line
Automatic answering .....	yes
ISDN call type .....	64 kbps data
Data Protocol .....	Fallback
DTE mode .....	Asynchronous
Data Bits .....	8
Parity Bits .....	None
Stop Bits.....	1
DTE connector bit rate .....	57.6 kbps
DTE flow control.....	Hardware
RTS line .....	1 msec delay
CTS line .....	Follows RTS

**More**

**More** takes the user into the following level of choices:

**Leased 128K**

When the ISU 128 is configured for **Leased 128K** service the following parameters are automatically preset:

Service type.....	Leased Line
Network clock source.....	Slave
Channel rate.....	128K
Data Protocol .....	Clear Channel
DDS loopbacks enabled .....	Yes
DTE mode .....	Synchronous
DTE connector bit rate .....	128 kbps
DTE flow control.....	none
RTS line.....	1 msec delay
CTS line .....	Forced on
Transmit data clock .....	Normal clock source

**Ldm 128 Master**

When the ISU 128 is configured for a point-to-point application such as a limited distance modem (LDM) arrangement, the **Ldm 128 Master** option automatically presets the following parameters:

Service type.....	Leased Line
Network clock source.....	Master
Channel rate.....	128K
Data Protocol .....	Clear Channel
DDS loopbacks enabled .....	Yes
DTE mode .....	Synchronous
DTE connector bit rate .....	128 kbps
DTE flow control.....	none
RTS line.....	1 msec delay
CTS line .....	Forced on
Transmit data clock .....	Normal clock source



**Factory Setup**

This option restores the ISU 128 to the factory default setup:

Service type.....	ISDN dial line
ISDN switch protocol.....	AT&T 5ESS
ISDN call type.....	64 kbps data
Dialing Mode.....	Front Panel
Data protocol.....	Clear Channel
DTE connector bit rate.....	64 kbps
DTE flow control.....	none
RTS line.....	Forced on
CTS line.....	Forced on 1 msec after RTS
CD line.....	Turned on when call is up
DSR line.....	Forced on
Transmit data clock.....	Internal clock source
BONDING timer TXINIT.....	10 seconds
BONDING timer TXFA.....	10 seconds
BONDING timer TXADD01.....	10 seconds
BONDING timer TXDEQ.....	50 seconds
BONDING timer TANULL.....	50 seconds
BONDING timer TXID.....	5 seconds
AT Commands Escape character.....	+
End-of-Line character value.....	13
Line Feed character value.....	10
Backspace character value.....	8
Transmit Data Clock.....	Normal clock source

# Chapter 9

## Dial Options

### DIALING OPTIONS

Selecting **4=DIAL** or pressing the # (pound) key from the Current Status menu displays the front panel available dialing options. (See Figure 9-2.) Access the VT 100 terminal dial options screen (Figure 9-1) by pressing **Ctl-D** from any screen. The dial options are only available when the ISU is configured for Dial Line operation (not Leased Line).

```
ISU 128 Dial Menu
1) Hang up line
2) Dial number
3) Redial last #
4) Answer Call
5) Dial stored #
6) Store/Review #
Menu option:

Ctl-U STATUS  Ctl-T TEST  Ctl-C CONFIG  Ctl-D DIAL  Ctl-X EXIT
```

**Figure 9-1**  
*VT 100 Terminal Dial Options Screen*

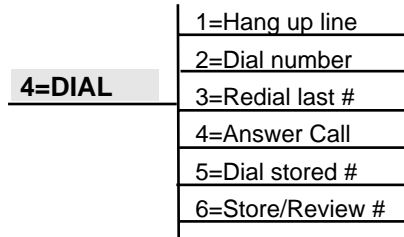

**Figure 9-2**  
*Dial Menu Tree*

## Hang Up Line

Terminates current call.

## Dial Number

Enter and dial a number from the keypad. If an error is made while entering a number, press the **Down** arrow to correct the mistake. Press **Cancel** twice consecutively to exit this menu item without dialing a number. Press **Enter** to dial the number and save as stored number 9 for redialing purposes.

## Redial Last Number

Redial the last number called (or attempted). This number is saved as stored number 9 from the last attempted phone call.

## Answer Call

Selectively answer incoming calls when Auto Answer is configured for disable. (Auto Answer is described in the section Auto Answer in Chapter 6.)

## Dial Stored Number

Dial one of ten stored phone numbers. The **Up** and **Down** arrows permit viewing and selecting of stored number. Press **Enter** to dial the number and save as stored number 9 (SN9) for redial purposes.

---

## Store/Review Number

Enter and review stored numbers. Press the **Up** or **Down** arrow to scroll through the 10 stored numbers (SN0 - SN9). To store a number, scroll to the desired stored number location, enter the number to be stored, and press **Enter** to save the number. If a mistake is made, use the **Up** and **Down** arrows to edit the number. Press **Enter** to save the number and exit. Press **Cancel** to exit without changing the number.



**NOTE** *The Dial Options Menu must be exited after dialing in order for CD (carrier detect) to be activated.*



# Chapter 10

## Remote Configuration

---

### Remote Configuration

Remote Configuration allows configuration and testing of a remote unit by calling the remote unit from a local unit. The remote unit can be configured using AT commands, the Front Panel, or the VT 100 terminal interface.

There are six items that cannot be set through remote configuration. The items are Dial Line Mode, SPID(s), LDN(s), Switch Type, Quick Setup, and Factory Default.

### Configuring with AT Commands

A remote unit can be configured by issuing an ATD command with the phone number of the remote unit plus a dial string modifier. The configuration command syntax is:

```
ATD nnnnnnn#6#yyyyyy
```

Where nnnnnnn is the remote number to call, and yyyyyy is a password of up to six digits.

After the connection is established, AT commands issued to the local unit are sent to the remote unit and executed. The remote unit sends response back to the local unit which then sends the response out of the DTE interface connector. See the appendices *AT Commands* and *S-Registers* of the ISU 128 manual for a complete list of commands.

## Configuring and Testing with the Front Panel or VT 100 Terminal

The menu path to follow to select remote configuration on the Front Panel is shown in Figure 10-1.

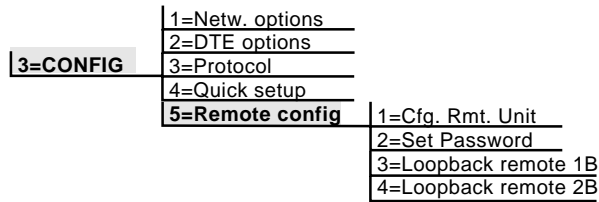

**Figure 10-1**  
*Remote Configuration Menu Path*

When using the VT 100 terminal interface, select the main menu option **Cfg. Rmt. Unit**. The Remote Configuration screen appears as shown in Figure 10-2.

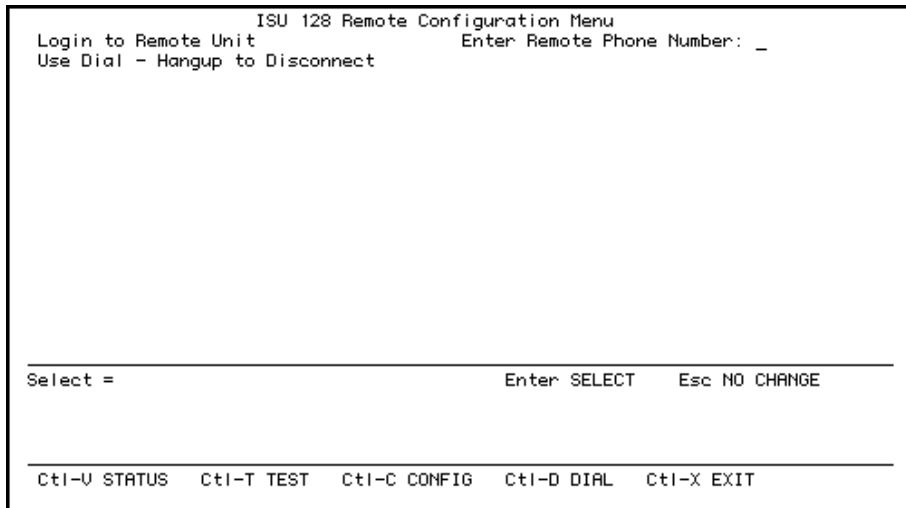

**Figure 10-2**  
*Remote Configuration Screen*

## Configure Remote Unit

This option allows configuration of a remote ISU 128. The Front Panel will display a prompt for the remote number to dial. Enter a number and press **Enter** to continue. A prompt for the remote password is displayed. Enter up to six digits for the password to access the remote unit and press **Enter** to continue. The Front Panel displays status information about the call. When a connection is established, the Front Panel will display information as if it were the remote unit. If the connection was not successful, the Front Panel displays information for the local unit connection. Pressing **Cancel** anytime up to this point cancels the call. Pressing **Cancel** at the first remote display screen or selecting **Hang up line** disconnects the call.

Figure 10-2 illustrates the VT 100 terminal screen when **Cfg. Rmt. Unit** is selected from the main menu. Enter the remote number to call and press **Enter**. When prompted, enter the password and press **Enter**. If a password has not been set for accessing the remote unit, press **Enter**. The VT 100 terminal will first display the Status Menu screen as it attempts to connect to the remote unit. Once successfully connected, the terminal will change back to the Configuration Menu screen and display remote information as if the remote unit were connected to the VT 100 terminal. Figure 10-3 illustrates the terminal screen when connected to a remote ISU 128. The call may be terminated by selecting **Hang up line** from the Dial menu.

```

Remote ISU 128 Configuration Menu
1) Netw. options = Dial Line          17) CTS Options = Forced CTS
2) Switch Protocol = AT&T 5ESS      18) CD Options = Normal
3) Call type = Speech                19) DTR Options = Ignore DTR
4) SPID 1 =                           20) DSR Options = DSR forced on
5) SPID 2 =                           21) Transmit Clock = Normal
6) LDN 1 =                             22) Protocol = Clear Channel
7) LDN 2 =                             23) Quick setup
8) Dial options = AT commands        24) Cfg. Rmt. Unit
9) Auto answer = Enabled             25) Set Password
10) Answer tone = No Answer tone
11) Connect Timeout = 30 sec (def)
12) Call Screening = Answer any
13) DTE options = Synchronous
14) Bit Rate = 48000
15) Connector Type = RS-232
16) RTS Options = 1 ms delay

Select =                               Enter SELECT   Esc NO CHANGE

Cti-V STATUS  Cti-T TEST  Cti-C CONFIG  Cti-D DIAL   Cti-X EXIT

```

**Figure 10-3**  
Remote Unit Configuration Screen





The Front Panel can only be used to configure other ISU devices with front panels. AT commands and the VT 100 terminal can be used to configure any ISU device that supports remote configuration, such as the Express XR/XRT and the ISU 2x64 Rack-mount.

## Remote Testing

Two tests may be performed from the local unit before connecting to the remote unit. Figure 10-4 illustrates the menu path for choosing Loopback Remote 1B and Loopback Remote 2B from the Test menu on the front panel.

	1=Loopback DTE
	2=Loopback Netw.
2=TEST	3=Loopback Proto
	4=Loopback Remote
	5=Test Remote
	6=Lpbk Disable
	7=NEBE/FEBE
	0=Software Ver

**Figure 10-4**  
Test Menu Path

### Loopback Remote 1B

The **Lpbk Remote 1B** option allows a local unit to call, loopback, and BERT test a remote unit on one B-channel if both the local and remote units are configured for Fallback protocol. The Front Panel and VT 100 terminal will prompt for the remote number to dial. When a connection is established, error information is displayed. Press **1) Exit Test** or **Escape** to exit the test. Figure 10-5 illustrates the VT 100 terminal while testing Loopback Remote 1B.

### Loopback Remote 2B

The **Lpbk Remote 2B** option allows a local unit to call, loopback, and BERT test a remote unit on two B-channels if both the local and remote units are configured for Fallback protocol. The Front Panel and VT100 terminal will prompt for the remote number to dial. When a connection is established, error information will be displayed. Press **1) Exit Test** or **Escape** to exit the test.

### Set Password

The **Set Password** option allows the user to store a password up to six digits for remote configuration access. If a password is entered, any other unit used to configure this unit remotely must send a password matching the stored password. If passwords do not match, the remote configuration fails to

connect. The screen from a VT 100 terminal is illustrated in Figure 10-6. To set the password, choose **Set Password** from the Main Configuration Menu. Type the six digit (or less) password, then press **Enter**. To clear the existing password, do not enter numbers for Set Password. Just press enter.

```

ISU 128 Loopback Remote Menu

Bytes = 0
Errors = 0
1) Exit Test
0) Clear Bytes and Errors

-----
Select =                               Enter SELECT   Esc NO CHANGE

-----
Ctl-U STATUS  Ctl-T TEST  Ctl-C CONFIG  Ctl-D DIAL  Ctl-X EXIT

```

**Figure 10-5**  
*Loopback Remote 1B*

```

ISU 128 Configuration Menu
1) Netw. options = Dial Line          17) CD Options = Normal
2) Switch Protocol = AT&T 5ESS       18) DTR Options = Ignore DTR
3) Call type = Data 64Kbps           19) DSR Options = DSR forced on
4) SPID 1 = 0192255360               20) Flow Control = Hardware Flow
5) SPID 2 = 0192255370               21) Data Bits = 8 Data bits
6) LDN 1 = 9225536                   22) Parity Bits = None
7) LDN 2 = 9225537                   23) Stop Bits = 1 Stop bit
8) Auto answer = Enabled              24) Protocol = FALLBACK
9) Answer tone = No Answer tone      25) Quick setup
10) Connect Timeout = 30 sec (def)    26) Cfg. Amt. Unit
11) Call Screening = Answer any       27) Set Password
12) DTE options = Asynchronous        28) Lpbk remote 1B
13) Bit Rate = 9600                   29) Lpbk remote 2B
14) Connector Type = RS-232
15) RTS Options = 1 ms delay
16) CTS Options = Follows RTS

-----
27) Password =                          Enter SELECT   Esc NO CHANGE
    Change Password: _

-----
Ctl-U STATUS  Ctl-T TEST  Ctl-C CONFIG  Ctl-D DIAL  Ctl-X EXIT

```

**Figure 10-6**  
*Set Password Screen*



# Chapter 11

## Troubleshooting

---

When the ISU 128 powers up, it performs an internal self test. This takes about 10 seconds. At the end of the test, the front panel displays **Self Test Passed**.

### IF SELF TEST FAILS

If **Self Test Passed** is not displayed, perform the following procedure to verify if the problem can be fixed locally:

1. Ensure that the ISU 128 is receiving power and is switched on.
2. Turn off the ISU 128. While holding down the **0** key, power back on. Continue to press **0** for 15 seconds. This will reset all the internal settings to factory defaults.
3. If the ISU 128 still does not pass self test, call ADTRAN Technical Support for assistance. See the back of this manual for phone numbers.

### IF THE ISU 128 DOES NOT READ READY

When the ISU 128 has been set up and connected to an ISDN line but the front panel does not read **Ready** after a few minutes, use the following troubleshooting procedure:

1. Cycle power on the ISU 128, leaving it off for a minimum of two seconds. Turn the power on for one minute to ensure the unit does not read **Ready**.

2. Disconnect the ISU 128 from the ISDN line. From a functioning voice phone, call the local directory number(s) provided with your line. Calling a good ISDN line with nothing connected usually results in a ring or fast busy tone. If someone answers or a not-in-service intercept is received, there is probably something wrong with the translation of the ISDN line. The phone service provider should be able to help.
3. If the ISU 128 continues to read **Link Down**, there is a physical problem with the ISDN phone line (more than likely, a problem with the Layer 1 setup). The problem may be one or more of the following:
  - The ISU 128 software setup
  - The ISU 128 hardware
  - The wiring on your premises
  - The telephone service provider's wiring
  - The telephone service provider's hardware
  - The telephone service provider's software setup

To isolate the problem, perform the following procedure:

- A. Make sure the ISU 128 is configured for dial line service. Check that **CONFIG, Netw. options, Dial Line**, is selected on the menu.
- B. Try another piece of functioning ISDN equipment with a U-interface on the ISDN line.
- C. Talk to your service provider and ensure you have an ISDN Basic Rate U-Interface with 2B1Q line coding (wrong options are an S or T interface or AMI line coding).
- D. Ensure that your ISDN phone line is connected to the actual telephone line (U-interface) provided by your telephone company. Make sure your ISDN line is not connected through another piece of equipment such as an NT1 in a wiring closet somewhere.
- E. Make sure nothing else is bridged across the ISDN line pair.
- F. With a minimum of extra wiring, try connecting to the ISDN line pair at the point where service provider's wiring ends.

- 
- G. With the ISU 128 connected to the ISDN line and powered up, talk to your service provider's repair group and inform them that your ISDN basic rate line has a physical layer 1 problem. Ask them to check the ISDN line. Tell them that you have an NT1-like device at the end of the ISDN line.
  4. If the ISU 128 continues to read **Getting TEI #1**, the ISU 128 is physically connected to your local telephone service provider but is unable to establish logical layer 2. The problem may be one or more of the following:
    - The ISU 128 software setup
    - The telephone service provider's software setup
    - Hardware configuration if the ISDN line is extended from the switch

To isolate the problem, use the following procedure:

- A. Ensure the ISU 128 is set up for the correct switch protocol by selecting **CONFIG, Netw. options, Dial Line, Switch protocol**.
- B. Ensure the line quality is satisfactory by checking for near- and far-end block errors (NEBEs and FEBEs). To do this, select **Test, NEBE/FEBE**. If the counts are non-zero and incrementing, there may be a physical link problem as described under **Link Down** (Step 3).
- C. Try another piece of functioning ISDN equipment with a U-interface on the line.
- D. With the ISU 128 connected to the line and powered up, talk to your service provider's repair group and tell them you have an ISDN basic rate line that appears physically okay but has no terminal endpoint identifier (TEI). Ask them to check the ISDN line translation and ensure that the ISDN line supports dynamic TEI allocation. Tell them that you have an NT1 and terminal adapter device connected to the line.

5. If the ISU 128 continues to read **Register SPID #1**, the ISU 128 is physically connected to the local telephone service provider and has established logical layer 2. The ISU 128 is unable to establish layer 3. The problem may be one or more of the following:

- The ISU 128 software setup
- The telephone service provider's software setup

To isolate the problem, use the following procedure:

- A. Ensure the ISU 128 is set up for the correct switch protocol by selecting **CONFIG, Netw. options, Dial line, Switch protocol**.
  - B. Ensure the ISDN line is multipoint.
  - C. Make sure that the ISU 128 is set up with the correct SPID and LDN by selecting **CONFIG, Netw. options, Dial Line, Terminal ID, SPID/LDN**.
  - D. Try another piece of functioning ISDN equipment with a U-interface on the line.
  - E. With the ISU 128 connected to the ISDN line and powered up, talk to your service provider's repair group and tell them you have an ISDN basic rate line that appears physically okay but has no terminal endpoint identifier (TEI). Ask them to check the line translation and ensure that the line supports dynamic TEI allocation. Tell them that you have an NT1 and terminal adapter device connected to the line.
6. If the ISU 128 continues to read **Getting TEI #2**, the ISU 128 has completely initialized the first phone number but is unable to establish logical layer 2 for the second phone number. The problem may be one or more of the following:

- The ISU 128 software setup
- The telephone service provider's software setup

To isolate the problem, use the following procedure:

- A. Ensure the ISDN line is multipoint with two phone numbers.

- 
- B. Ensure that the ISU 128 is set up with the correct SPID and LDN by selecting **CONFIG, Netw. options, Dial Line, Terminal ID, SPID/LDN**.
  - C. Try swapping SPID1 with SPID2 and LDN1 with LDN2. Determine if the problem is the second phone number or the quantity of phone numbers.
  - D. Try another piece of functioning ISDN equipment with a U-interface on the ISDN line.
  - E. With the ISU 128 connected to the ISDN line and powered up, talk to your service provider's repair group and tell them you have an ISDN basic rate line that appears physically okay but has no TEI. Ask them to check the line translation and ensure that the line supports *dynamic* TEI allocation. Tell them that you have an NT1 and terminal adapter device connected to the line.
7. If the ISU 128 continues to read **Register SPID #2**, the ISU 128 has completely initialized the first phone number but is unable to establish logical layer 3 for the second phone number. The problem is in one or more of the following places:
    - The ISU 128 software setup
    - The telephone service provider's software setup

To isolate the problem, use the following procedure:

- A. Ensure the ISDN line is multipoint with two phone numbers.
- B. Ensure that the ISU 128 is set up with the correct SPID and LDN by selecting **CONFIG, Netw. options, Dial Line, Terminal ID, SPID/LDN**.
- C. Try swapping SPID1 with SPID2 and LDN1 with LDN2. Determine if the problem is the second phone number or the quantity of phone numbers.
- D. Try another piece of functioning ISDN equipment with a U-interface on the line.



- E. With the ISU 128 connected to the line and powered up, talk to your service provider's repair group and tell them you have an ISDN basic rate line that appears physically okay but has no terminal endpoint identifier (TEI). Ask them to check the line translation and ensure that the line supports dynamic TEI allocation. Tell them that you have an NT1 and terminal adapter device connected to the line.

# Chapter 12

## Specifications

---

### **SPECIFICATIONS AND FEATURES**

This section describes the standard specifications and features incorporated in the ISU 128.

#### **Network Interface**

- RJ-45 for ISDN Basic Rate U-Interface, and Leased 2B1Q service

#### **DTE Interface**

- RS-530
- V.35
- EIA-232

#### **Dialing Selections**

- In-band DTE dialing: V.25 or AT commands
- Manual or automatic stored number dialing, DTR assertion
- Dial interface: RS-366
- Front panel manual dialing

#### **Data Rates (Network)**

64 kbps (one B channel), 128 kbps (two B channels)

#### **Data Rates (DTE)**

- 300 bps to 115.2 kbps asynchronous
- 2400 bps to 128 kbps synchronous

**Rate Adaption**

- T-Link
- CCITT V.120
- CCITT V.110
- SAP
- DSU 57.6 Async
- BONDING mode 1
- V.34 (optional)
- PPP
- MP

**Interoperability**

- BONDING Inverse Multiplexers
- Switched 56 DSUs
- ISDN TAs
- V.34 modems (optional)

**Switch Compatibility**

- AT&T 5ESS
- NTI DMS-100
- National ISDN-1
- NEC

**B Channel Aggregation**

- BONDING Mode 1
- MP

**Display**

- Two-line by 16 character LCD
- LED indicators
  - RS Request to Send.  
Indicates the DTE is ready to transmit.
  - CS Clear to Send.  
Indicates the ISU 128 is ready to transmit.
  - TD Transmit Data.  
On when the DTE is transmitting to the ISU 128.
  - RD Receive Data.  
On when the ISU 128 is receiving data from the far end.
  - CD Carrier Detect.  
On when the ISU 128 is connected to a remote unit.

TR	Data Terminal Ready from DTE. On when DTR is active at DTE interface.
SR	Data Set Ready.

**Environmental**

- Operating Temperature: 0 to 50 °C
- Storage Temperature: 20 to 70 °C
- Relative Humidity: Up to 95%, non-condensing

**Physical**

- Dimensions: 2.25"H x 8.75"W x 11.00"D
- Weight: 3 lbs.

**Power**

- 115 VAC, 60 Hz, 8 W maximum dissipation (part numbers 1202029L2 and 1202029L3)

## Chapter 12. Specifications

---

# Appendix A

## AT Commands

---

This appendix lists the supported AT commands and describes their functions.

<b>Command</b>	<b>Function</b>
A	Answer. Puts the ISU 128 in answer mode.
D	Dial. Precedes the telephone access number [ATD5551212].
H	Hang up. Disconnects the current call.
O	On-line. Commands the unit to go back on line.
S	S Register.
SS	S String register.
Z	Reset. Resets the AT command processor.
&N0	Number 1. Read far-end phone number 1 if service subscribed from telephone company.
&N1	Number 2. Read far-end phone number 2 if service subscribed from telephone company.
&R	Ram. Copy EEPROM configuration to RAM.
&W	Save. Save current configuration to EEPROM.
+++	Break in. Break in AT command processor during an active call. The break in key can be defined in S2.

---

<b>Command</b>	<b>Function</b>
----------------	-----------------

**Carrier Detect (CD) Control Line Options**

&C0	CD forced On
&C1	CD normal
&C2	CD off with local disconnect (LOCD)
&C3	CD off with link down

**Data Terminal Ready (DTR Control Line Options)**

&D0	Ignore DTR
&D1	DTR off forces command
&D2	Idle when off, DTR off forces idle (On allows auto answer)

**Generic Unit Configurations**

&F0	Reset all S-registers to factory preset values
&F1	Configures unit for Dial 56K sync
&F2	Configures unit for Dial 64K sync
&F3	Configures unit for Dial 112K sync
&F4	Configures unit for Dial 128K sync
&F5	Configures unit for Leased 128K
&F6	Configures unit for Ldm 128K master
&F7	Configures unit for Dial 57.6K async
&F8	Configures unit for Dial 115.2K async
&F9	Configures unit for Dial PPP
&F10	Configures unit for Dial V34 115.2K async
&F11	Configures unit for FALLBACK 57.6K async

**Network Options**

&L0	Dial network
&L1	Leased network

**Calling Number Identifiers**

&N0	Number 1. Read far-end phone number 1 if service subscribed from telephone company.
&N1	Number 2. Read far-end phone number 2 if service subscribed from telephone company.

**DTE Data Type Options**

&Q0	DTE is async
&Q1	DTE is sync

<b>Command</b>	<b>Function</b>
<b>Clear-To-Send (CTS) Control Line Options</b>	
&R0	Follows RTS
&R1	Forced CTS
<b>Data Set Ready (DSR) Control Line Options</b>	
&S0	DSR forced On
&S1	DSR if call up
&S2	DSR Off if link down
&S3	DSR Off if Dial Up
<b>DTE Connector Data Synchronous Data Clocking Options</b>	
&X0	Internal transmit clock
&X1	External transmit clock
<b>Accessing Stored numbers for Dialing Options</b>	
&Z0	Stored number 0
&Z1	Stored number 1
&Z2	Stored number 2
&Z3	Stored number 3
&Z4	Stored number 4
&Z5	Stored number 5
&Z6	Stored number 6
&Z7	Stored number 7
&Z8	Stored number 8
&Z9	Stored number 9
<b>Local Echo Options</b>	
E0	Echo off. Does not allow command characters typed to be displayed on the screen.
E1	Echo on. Determines if the command characters typed are displayed on the screen.
<b>Unit Identification</b>	
I0	Identify unit. Commands the unit to display model number.
I1	Identify software. Commands the unit to display software version.
<b>AT Command Response Message Options</b>	
Q0	Response messages on
Q1	Response messages off



---

<b>Command</b>	<b>Function</b>
----------------	-----------------

**AT Command Response Message Types**

V0	Numeric response messages
V1	Verbal response messages words

**AT Command Connect Message Options**

X0	Simple connect message
X1-7	Connect messages with bit rate

**Ready-To-Send (RTS) Control Line Options**

_D0	1 ms delay
_D1	18 ms delay

**Service Profile Identification (SPID) Access Options**

_I1	Access SPID 1
_I2	Access SPID 2

**Local Directory Number (LDN) Access Options**

_N0	Access LDN1
_N1	Access LDN2

**ISDN Switch Protocol Options**

_S0	5ESS
_S1	DMS-100
_S2	National ISDN-1
_S3	NEC

**ISDN U-Interface Operational Mode Options**

_X0	ISU timing slaves to network (NT)
_X1	ISU is U-interface timing master (LT)

**Data Flow Control Options**

\Q0	No flow control
\Q1	Software
\Q2	CTS only
\Q3	Hardware
\Q4	Software from DCE only

---

<b>Command</b>	<b>Function</b>
----------------	-----------------

The following AT commands require that the optional V.34 modem board be installed:

**V.34 Compression Options**

%C0	No compression
%C1	Use MNP compression
%C2	Use V.42 bis compression
%C3	Use V.42 bis/MNP compression

**V.34 Compression Block Size Options**

\A0	MNP 64 byte blocks
\A1	MNP 128 byte blocks
\A2	MNP 192 byte blocks
\A3	MNP 256 byte blocks

**V.34 Operational Mode Options**

\N0	MNP Normal
\N1	MNP Direct
\N2	Reliable
\N3	Auto-reliable
\N4	Force LAPM
\N5	Force MNP

## Appendix A. AT Commands

---

# Appendix B

## Current Status Messages

---

This appendix lists the status line messages and their definitions. Messages shown entirely in capital letters are generated by the ISDN network. Messages with lower case letters are generated by the ISU 128.

### **AT&T-5ESS Ready**

The ISU 128 is connected to an AT&T 5ESS switch and is ready to place/receive calls.

### **Call Connect B1**

Bearer channel 1 has been connected and is now active.

### **Call Connect B2**

Bearer channel 2 has been connected and is now active.

### **CALL xxxxxxxx**

The ISU 128 is calling phone number xxxxxxxx.

### **DISCONNECTING**

The current phone call is being disconnected (hung up).

### **DMS-100 Ready**

The ISU is connected to a DMS-100 switch and is ready to place/receive calls.

### **Getting TEI #1**

The ISU is receiving its first TEI from the network.

### **Getting TEI #2**

The ISU is receiving its second TEI from the network.

### **ISDN-1 Ready**

The ISU 128 is connected to an ISDN-1 compliant switch and is ready to place/receive calls.

**Link down**

The network interface is not active.

**LPBK DTE Port**

The DTE connector is looped back in the DTE direction.

**LPBK Protcl Net**

The ISU 128 has been commanded to perform a loopback in the network direction after letting the incoming data pass through the current protocol.

**NEC Ready**

The ISU 128 is connected to an NEC switch and is ready to place/receive calls.

**NET EOC LOOPBACK**

The ISU 128 has been commanded to perform an ISDN loopback toward the network.

**NET REM LOOPBACK**

The ISU 128 is performing a V.54 or DDS latching loopback toward the network.

**Register SPID #1**

The ISU 128 is registering its first SPID with the network.

**Register SPID #2**

The ISU 128 is registering its second SPID with the network.

**RINGING**

The phone number just dialed is ringing.

**xxxx nnnn**

A rate adaption is running at the bit rate specified by nnnn.

**xxxxx Quitting**

A rate adaption protocol is turning off.

**xxxxx Ready**

A rate adaption protocol is ready.

**xxxxx Setup**

A rate adaption protocol is setting up.

**xxxxxx can be any of the following:**

**BONDING**

Bandwidth on Demand Industry Users Group protocol.

**CLEAR CHAN**

No rate adaption protocol (allows use of maximum bandwidth).

**DSTOP**

DSU 57.6 async rate adaption protocol.

**FALLBACK**

FALLBACK rate adaption protocol.

**PPP**

Point-to-point protocol.

**SAP**

Simple ADTRAN protocol.

**TLINK**

TLINK rate adaption protocol.

**V110**

V.110 rate adaption protocol.

**V120**

V.120 rate adaption protocol.

**V34**

V.34 modem (optional).

## Appendix B. Current Status Messages

---

# Appendix C

## Status Buffer Messages

---

This appendix lists the status buffer message and their definitions. Messages shown entirely in capital letters are generated by the ISDN network. Messages with lower case letters are generated by the ISU 128.

**Answer 1/2**

The ISU 128 answered a call on either the first or second channel. The calling phone number is displayed if available.

**ACCESS\_INFO\_DISCARDED**

The network was unable to deliver access information to the far end.

**Back to on-line**

ISU 128 went back on line.

**Bad async BPS**

The BONDING protocol determined that the selected asynchronous bit rate is not supported.

**Bad AT bit field**

User issued an AT command with an argument that was out of range.

**Bad B channel**

Bonding negotiation determined the delay in one of the Bearer channels was uncorrectable.

**Bad call type**

ISU 128 placed a call with an improper call type.

**Bad DTE baud**

The DTE bit rate does not match a valid bit rate for the protocol selected.

**Bad DTE bps**

Bonding negotiation determined the chosen DTE bit rate is invalid.



**BAD\_INFO\_ELEM**

Call control error.

**Bad phone number**

ISU 128 attempted to call an invalid phone number.

**Bad TLK Version**

Invalid TLINK parameters found during end-to-end negotiations.

**BaudRate**

ISU 128 does not support the negotiated TLINK baud rate.

**BEAR\_CAP\_NOT\_AVAIL**

The bearer channel requested by the user is not available.

**Bearer mode**

Incoming call is not of a type the ISU128 can accept.

**Bearer info mode**

Incoming call information transfer capability is not known.

**BONDING (+/- XXX)**

The amount of bytes of corrected delay between the B2 and B1 bearer channels (XXX can range from -8000 to +8128 bytes).

**BPS mismatch**

Bonding negotiation found a bit rate mismatch.

**Break to AT cmd**

User issued a break-in request (+++).

**Break ignored**

User issued an extra break-in request.

**BUSY**

The called number is busy.

**CallID 1 in use**

ISU 128 tried to place a call using SPID 1 though SPID 1 was already in use.

**CallID 2 in use**

ISU 128 tried to place a call using SPID 2 though SPID 2 was already in use.

**Call not ringing**

User executed an answer command (ATA) but there was not a call present.

**CALL\_REJECTED**

The call has been rejected by the ISDN Network.

**Can't go on-line**

ISU 128 cannot go back on line. User issued an unknown AT command.

**CAP\_NOT\_IMPLEMENTED**

The network or far end does not support the bearer capability requested.

**CHAN\_DOES\_NOT\_EXIST**

The bearer channel requested is not present.

**CHAN\_NOT\_IMPLEMENTED**

The bearer channel requested has not been implemented.

**CHANNEL\_UNACCEPTABLE**

The channel requested has not been subscribed.

**CID>0 rcvd**

Received an incoming call from a third party during negotiations with a far-end BONDING unit on the use of the second bearer channel.

**DEST NOT ISDN**

The number called is not ISDN (warning only).

**DEST\_OUT\_OF\_ORDER**

The called number is out of order.

**Dial 1/2**

The ISU 128 placed a call on either the first or second channel. The number called is displayed following the message.

**Disconnect 1/2**

The call on either the first or second channel was disconnected from the network. The far-end phone number is displayed if available.

**Disconnect Req**

Far-end unit disconnected during BONDING negotiation.

**DPUMP END RCVD**

Indication of a hang-up or disconnect occurring during BONDING. Does not indicate an error condition has occurred.

**DTE must be SYNC**

For the protocol chosen, the DTE connector must be optioned as synchronous.

**DTE not set V25**

The DTE equipment is not optioned for the same bit rate as the ISU 128 for V.25 bis dialing.

**DTR not up**

ISU 128 tried to place a call in a dialing mode that requires DTR to be in an active state but it is not.

**Dump call**

ISU 128s could not accept an incoming call because it was already involved in a call.

**Dump 1/2**

An incoming call on either the first or second channel was discarded by the ISU. The calling number is displayed if available.

**FACILITY\_NOT\_IMPLEMENT**

The network does not support the requested supplementary service.

**FACILITY\_REJECTED**

A facility requested cannot be provided by the network.

**FACILITY\_NOT\_SUBSCRIBED**

The channel type requested has not been subscribed.

**FALLBACK ERROR**

Attempted to fallback to normal mode failed.

**FBW disconnect**

BONDING negotiation has failed due to a disconnect on a B-Channel.

**FlowCtl mismatch**

Bonding negotiation determined a flow control mismatch.

**FlowCtl required**

Bonding negotiation determined that flow control needs to be optioned on.

**Hangup 1/2**

The call on either the first or second channel was disconnected by the ISU 128. The far-end phone number is also displayed.

**InCmptblFound**

TLINK end-to-end negotiations found an optioning incompatibility between the two end units.

**INCOMMING\_CALL\_BARRED**

The network will not allow an incoming call.

**INCOMPATIBLE\_DEST**

The called number cannot accept the type of call that has been placed.

**INVALID\_CALL\_REF**

Call control error.

**INVALID\_ELEM\_CONTENTS**

Call control error.

**INVALID\_MSG\_UNSPEC**

Invalid message, protocol error.

**INVALID\_NUMBER\_FORMAT**

The dialed number has an invalid format.

**L1 not up**

The network interface is not active.

**L2 not up**

The data link layer interface is not active.

**L3 not up**

The call control interface is not active.

**L2 #2 not up**

The data link layer interface for a second call (BONDING) is not active.

**L3 #2 not up**

The call control layer interface for a second call (BONDING ) is not active.

**LDN TOO LONG**

The entered local directory number has too many digits.

**MANDATORY\_IE\_LEN\_ERR**

Mandatory information element length error.

**MANDATORY\_IE\_MISSING**

Mandatory information element missing.

**Need 2 B chan**

The DTE bit rate requires the BONDING protocol.

**Need 64K call**

The BONDING protocol requires the ISU 128 to be configured for a 64k data call type.

**Negotiation fail**

The BONDING negotiation has failed.

**NETWORK BUSY**

The ISDN switch is busy and unable to process a call.

**NETWORK\_CONGESTION**

The phone network is currently congested.

**NETWORK\_OUT\_OF\_ORDER**

The phone network is out of order.

**No 48K Support**

The ISU 128 does not support 48 kbps TLINK. Local DTE setup error.

**NO\_CIRCUIT\_AVAILABLE**

The requested bearer channel is not available.

**NO\_CARRIER**

The V.34 modem board did not detect a modem carrier at the far end.

**NONEXISTENT\_MSG**

Nonexistent message was sent by the ISU 128.

**No Sreg number**

Attempt to access an S-register without specifying a specific S-register (example: ATS=1).

**No Sreg value**

Attempt to change an S-register without specifying a value (example: ATS2= ).

**NO\_ROUTE**

The phone network was unable to find a route to the destination number.

**NO\_USER\_RESPONDING**

The dialed number is not responding.

**NORMAL\_CLEARING**

The network is disconnecting the current call.

**NOT\_end2end\_ISDN**

The path that the call was routed over is not ISDN from end-to-end (warning only).

**NUMBER\_CHANGED**

The number dialed has been changed.

**OUTGOING\_CALL\_BARRED**

The network will not allow the outgoing call to be placed.

**PROTOCOL\_ERROR**

Call control error.

**REQ\_CHANNEL\_NOT\_AVAIL**

The channel type requested is currently not available.

**Remote not ISU**

Bonding negotiation determined the far-end unit is not another ISU product (asynchronous rates can only be supported between two ADTRAN ISU products).

**RESP\_TO\_STAT\_ENQ**

Response to status enquiry.

**Ring 1/2**

An incoming call on either the first or second channel (third channel if call waiting) entered the Ring state. The calling phone number is displayed if available.

**S cmd not = or ?**

User did not use proper syntax.

**SAP idle timeout**

Unit at far end is not configured to use the SAP protocol.

**SERVICE\_NOT\_AVAIL**

The service requested by the user is not available.

**SOURCE NOT ISDN**

The incoming calling party is not ISDN (warning only).

**SReg SetError**

Local DTE invalid S-register setting.

**Sync BPS < 56K**

The synchronous bit rate selected is too slow for the BONDING protocol.

**Sync Mismatch**

Both ends Bad Synchronization.

**TAINIT expired**

Bonding timer TAINIT expired.

**TANULL expired**

Bonding timer TANULL expired, non-BONDING equipment attempted to call into the ISU 128 while optioned for BONDING.

**TEMPORARY\_FAILURE**

The network has temporarily failed, try the call again.

**TIMER\_EXPIRY**

Call control error.

**TLINK ErrorOne**

Catastrophic TLINK error.

**TXADD01 expired**

Bonding timer TXADD01 expired, probably making a long distance call to a foreign country, adjust timer value to correct.

**TXFA1 expired**

Bonding timer TXFA1 expired, other vendors BONDING equipment did not operate properly.

**TXFA2 expired**

Bonding timer TXFA1 expired, other vendors BONDING equipment did not operate properly.

**TX FLOW ERROR**

Flow control needs to be enabled.

**TXINIT expired**

Bonding timer TXINIT expired, called non-BONDING equipment.

**UNASSIGNED\_NUMBER**

The phone number dialed does not exist.

**Unknown AT & cmd**

User issued an unknown AT command.

**UNSPECIFIED\_CAUSE**

Received a cause message from the network that is not understood.

**Unsupported baud**

The ISU 128 does not support the negotiated baud rate.

**USER\_BUSY**

The dialed number is busy.

**V120 timeout**

The far-end unit is not set up for V.120.

**V120 connected**

The V.120 rate adaption successfully connected to the far-end unit.

**WRONG\_MESSAGE**

Call control error.

**WRONG\_MSG\_FOR\_STATE**

Call control error.



## Appendix C. Status Buffer Messages

---

# Appendix D

## S-Register List

---

<b>S0</b>	<b>AUTO ANSWER</b>	Determines how the ISU 128 answers an incoming call. 0 = Disable (ISU 128 does not answer call). 1 = Enable (ISU 128 answers all calls). 2 = Dump all calls.
<b>S2</b>	<b>BREAK IN CHARACTER</b>	Determines which key or character (in ASCII code) defines the escape command. The standard escape character is a + sign (ASCII value of 43 decimal). To change the character set, set S2 to the desired ASCII value. Range = 0 to 127
<b>S3</b>	<b>END OF LINE CHARACTER</b>	Determines which key or character (in ASCII code) ends a command line. The standard end-of-line character is the carriage return (ASCII value of 13 decimal). Range = 0 to 127
<b>S4</b>	<b>LINE FEED CHARACTER</b>	Determines which key or character (in ASCII code) advances the cursor to the next line after ending a command line or after an ISU 128 message. The standard character is the line feed (ASCII value of 10 decimal). Range = 0 to 127
<b>S5</b>	<b>BACK SPACE CHARACTER</b>	Determines which key moves the cursor back one space to erase a character. The standard character is the backspace (ASCII value of 8 decimal). Range = 0 to 127
<b>S7</b>	<b>CONNECT TIME</b>	Determines how long the ISU 128 waits for an outgoing call to be answered. 15 = 15 seconds 30 = 30 seconds 60 = 1 minute 120 = 2 minutes 240 = 4 minutes

---

<b>S11</b>	<b>FALLBACK DEFAULT</b>	<p>Determines how the ISU 128 answers an incoming call if all of the protocols in Fallback failed.</p> <ul style="list-style-type: none"> <li>1 = Clear Channel</li> <li>2 = BONDING Mode 1</li> <li>3 = SAP</li> <li>4 = T-link</li> <li>5 = V.110</li> <li>6 = V.120</li> <li>7 = V.34</li> <li>8 = DSU 57.6 Async (default)</li> <li>9 = PPP asyn-syn</li> </ul>
<b>S12</b>	<b>ESCAPE TIME</b>	<p>Determines the delay required immediately before and after entering the escape command for the ISU 128 to recognize and execute the command.</p> <p>Range = 0 to 127</p>
<b>S14</b>	<b>MISC BITS</b>	<p>Miscellaneous bits (bit 8 is most significant bit).</p> <ul style="list-style-type: none"> <li>Bit 2 = 1: Enables on-screen echo of AT commands.</li> <li>Bit 2 = 0: Disables on-screen echo of AT commands.</li> <li>Bit 3 = 0: Enables AT responses from the ISU 128.</li> <li>Bit 3 = 1: Disables AT responses from the ISU 128.</li> <li>Bit 4 = 1: Enables AT responses to be displayed in text form.</li> <li>Bit 4 = 0: Enables AT responses to be displayed in numeric form.</li> <li>Bit 7 = 1: Disables PPP ACCM Spoofing.</li> <li>Bit 7 = 0: Enables PPP ACCM Spoofing.</li> <li>Bit 8 = 1: Ring indicator uses cadence.</li> <li>Bit 8 = 0: Ring indicator remains on.</li> </ul>
<b>S15</b>	<b>ASYNC BONDING</b>	<ul style="list-style-type: none"> <li>0 = ADTRAN Only</li> <li>1 = Multi-Vendor</li> </ul>
<b>S22</b>	<b>MSG BITS</b>	<p>Miscellaneous message bits (Bit 8 is most significant bit).</p> <ul style="list-style-type: none"> <li>Bit 5 = Bit 6 = Bit 7 = 1: Allows connect message with baud rate.</li> <li>Bit 5 = Bit 6 = Bit 7 = 0: Connects message without baud rate.</li> </ul>
<b>S24</b>	<b>V120 LLC</b>	<p>Value determines whether the V.120 bit is set in setup message for CCITT V.120 calls. Some terminal adapters require this bit be set to connect V.120 calls.</p> <ul style="list-style-type: none"> <li>0 = Set V.120 bit in call setup message. (default)</li> <li>1 = Do not set V.120 bit in call setup message.</li> </ul>

---

<b>S27</b>	<b>PPP MODE</b>	Determines type of PPP connection. 0= Single-link operation (default) 1= Multilink operation 2= Use compression
<b>S30</b>	<b>DTE CTS</b>	Controls the operation of the DTE connector clear to send (CTS) line. 0= Follows RTS 1= Force CTS
<b>S31</b>	<b>DTE RTS</b>	Controls operation of the request to send (RTS) line. 0= 1 ms delay 17= 18 ms delay
<b>S32</b>	<b>DTE DSR</b>	Controls the operation of the data set ready (DSR) signal on the DTE connectors. 0= Force DSR on always 1= DSR off OOS + Test 2= DSR off Link Down
<b>S33</b>	<b>DTE CD</b>	Controls the operation of the carrier detect (CD) line on the DTE connectors. 0= Force CD on always 1= CD is active during a call (normal operation) 2= Off with LOCD
<b>S34</b>	<b>DTE DTR</b>	Determines how the ISU 128 responds to changes in DTR. This is a bit-mapped register. 0= Ignore DTR. 1= Force AT command mode when DTR is off 2= Dump incoming call when DTR is off
<b>S35</b>	<b>DTE CONN</b>	Determines which is the current operating DTE connector. 0= RS-530 connector 1= V.35 2= EIA-232 connector

**NOTE**

*S-registers 36 through 38 require the optional V.34 modem P/N 1202029L3.*

---

<b>S36</b>	<b>ERROR CORRECTION</b>	<p>Sets the type of error control to be negotiated with the far-end modem.</p> <ul style="list-style-type: none"> <li>0 = Normal operation no error control. Allows speed matching, buffering, and flow control.</li> <li>1 = Direct error control, no error control. Does not allow the terminal and ISU 128 to operate at different speeds or use flow control.</li> <li>2 = Reliable MNP error control. If the far end does not use MNP error control then the call is ended.</li> <li>3 = Auto-reliable MNP error control . The ISU 128 attempts to use MNP error control. If the far end does not use MNP, then normal operation is used.</li> <li>4 = Force LAPM. Force the modem to connect only if V.42 (LAPM) error correct can be used.</li> <li>5 = Force MNP. Force the modem to connect only if MNP 2-4 error correction can be used.</li> </ul>
<b>S37</b>	<b>V34 COMPRESSION</b>	<p>Enables compression in the V.34 modem.</p> <ul style="list-style-type: none"> <li>0 = No compression</li> <li>1 = MNP5 compression</li> <li>2 = V42 compression</li> <li>3 = MNPS or V42 compression</li> </ul>
<b>S38</b>	<b>V34 BLOCK SIZE</b>	<p>Sets the amount of data sent in a single packet during MNP error controlled stream operation.</p> <ul style="list-style-type: none"> <li>0 = Block size of 64 bytes</li> <li>1 = Block size of 128 bytes</li> <li>2 = Block size of 192 bytes</li> <li>3 = Block size of 256 bytes</li> </ul>
<b>S40</b>	<b>BOND TXINIT</b>	<p>Specifies the number of seconds the originating endpoint attempts to detect the BONDING negotiation pattern from the answering endpoint before deciding the BONDING call has failed.</p> <p>Range = 0 to 255, 10 sec is default</p>
<b>S41</b>	<b>BOND TXFA</b>	<p>Specifies the number of seconds both endpoints attempt to detect the BONDING frame pattern when a call is connected before deciding the BONDING call has failed. When operating with other manufacturers' BONDING equipment, it may be necessary to lengthen this timer so that it matches TXADD01.</p> <p>Range = 0 to 255, 10 sec is default</p>

---

<b>S42 BOND TXADD01</b>	The number of seconds both endpoints wait for the additional call to be connected at the end of negotiation before deciding the BONDING call has failed. When dialing overseas, it may be necessary to lengthen this timer to allow for lower call routing. Range = 0 to 255, 50 sec is default
<b>S43 BOND TXDEQ</b>	The number of seconds both endpoints attempt to equalize the network delay between the bearer channels before deciding the BONDING call has failed. Range = 0 to 255, 50 sec is default
<b>S44 BOND TANULL</b>	The number of seconds the answering endpoint attempts to detect the BONDING negotiation pattern from the originating endpoint before aborting to clear channel mode. It may be necessary to shorten this timer if the DTE equipment connected to the ISU 128 also has timer constraints for completing non-BONDING parameter negotiation. Range = 0 to 255, 10 sec is default
<b>S45 BOND TCID</b>	The number of seconds both endpoints attempt to negotiate agreeable values for bearer channels and channel capacities before deciding the BONDING call has failed. Range = 0 to 255, 5 sec is default
<b>S46 V25 MODE</b>	Selects the type of V.25 bis dialing used. 0 = Asynchronous V.25 1 = HDLC V.25 2 = BISYNC V.25 3 = HDLC with flags V.25
<b>S47 RS-366 TIME</b>	Determines the amount of time the RS-366 port will wait for EON or inactivity to terminate a dial string before dialing a number. 0 = Wait for EON only 10= Wait for 1 second or EON 20= Wait for 2 seconds or EON 50= Wait for 5 seconds or EON 100=Wait for 10 seconds or EON 200=Wait for 20 seconds or EON
<b>S50 LINE MODE</b>	Selects the operating mode of the ISU 128. 0 = Dial service (switched service) 1 = Leased service (non-switched service)

Appendix D. S-Register List

---

<b>S51</b>	<b>LINE CLOCK</b>	Selects the clock mode in leased mode. 0 = Slave (default) 1 = Master (Leased line only, limited distance MODEM application only).
<b>S52</b>	<b>SWITCH PROTOCOL</b>	Selects the network switch type for dial service. 0 = AT&T 5ESS 1 = Northern Telecom DMS-100 2 = National ISDN-1 3 = NEC
<b>S53</b>	<b>CALL TYPE</b>	Call type (dial service only) 0 = Speech 1 = Audio 2 = 56 kbps data 3 = 64 kbps data
<b>S54</b>	<b>PROTOCOL TYPE</b>	Rate adaption protocol type. 1 = Clear Channel (no rate adaption) 2 = BONDING mode 1 3 = SAP (simple ADTRAN protocol) 4 = T-link 5 = V.110 6 = V.120 7 = V.34 9 = DSU 57.6 kbps asynchronous 11= FALLBACK 12= PPP async-to-sync
<b>S55</b>	<b>DIAL MODE</b>	Selects dialing interface. 0 = Front panel only (always available) 1 = RS-366 dialing port 2 = AT commands 3 = V.25 bis dialing
<b>S56</b>	<b>ECHO TONE</b>	Enables an echo tone which suppresses the echo cancellers in a voice circuit. Can be used to trick the switch to allow sending data over a line optioned for voice ISDN service. 0 = None 1 = Answer 2 = Originate 3 = Both

---

<b>S57</b>	<b>DDS TEST</b>	Allows an ISU 128 optioned as a leased line unit to respond to DDS in-band latching loopback or V.54 loopback commands. 0 = No checking 1 = Check for DDS latching loopbacks 2 = Check for v.54 loopbacks 3 = Check for V.54 and DDS latching loopbacks
<b>S58</b>	<b>CALL SCREENING</b>	Allows the ISU 128 to screen incoming calls. 0 = Answer any call 1 = Answer only calls from numbers matching those stored in SN0 through SN9.
<b>S59</b>	<b>CHANNEL RATE</b>	Sets the available network bandwidth when the ISU 128 is in leased mode. 3 = 64 kbps 5 = 128 kbps
<b>SS60</b>	<b>SPID1 LOC</b>	Primary SPID location.
<b>SS61</b>	<b>SPID2 LOC</b>	Secondary SPID string location.
<b>SS62</b>	<b>LDN1 LOC</b>	Primary local directory number string location.
<b>SS63</b>	<b>LDN2 LOC</b>	Secondary local directory number string location.
<b>S70</b>	<b>DTE MODE</b>	Selects asynchronous or synchronous mode on the DTE connector. 0 = Asynchronous 1 = Synchronous
<b>S71</b>	<b>DTE RATE</b>	Selects the DTE connector bit rate. 1 = 300 3 = 1200 6 = 2400 8 = 4800 11 = 9600 15 = 19200 17 = 38400 18 = 48000 19 = 56000 20 = 57600 21 = 64000 22 = 112020 23 = 115200 24 = 128000



Appendix D. S-Register List

---

<b>S72</b>	<b>DATA BITS</b>	Selects the number of asynchronous data bits. 0 = 8 bits 1 = 7 bits
<b>S73</b>	<b>DTE PARITY</b>	Selects the number of asynchronous parity bits. 0 = None 1 = Odd 2 = Even
<b>S74</b>	<b>DTE STOP</b>	Selects the number of asynchronous stop bits. 0 = 1 stop bit 1 = 1.5 stop bits 2 = 2 stops bits
<b>S75</b>	<b>DTE FLOW</b>	Selects asynchronous flow control. 0 = None 1 = Hardware flow XON/OFF from DCE controls DTE 2 = XON/OFF from DTE controls DCE 3 = Hardware flow. RTS and CTS flow control. 12= Software flow. XON/OFF controls DTE and DCE.
<b>S76</b>	<b>DTE CLOCK</b>	Selects DTE connector transmit clock timing source. 0 = Internal (ISU 128 supplies timing) 1 = External (DTE supplies timing)

The following are the string locations for stored numbers 0 - 9.

<b>SS80</b>	<b>SN0 LOC</b>	Stored number 0 string
<b>SS81</b>	<b>SN1 LOC</b>	Stored number 1 string
<b>SS82</b>	<b>SN2 LOC</b>	Stored number 2 string
<b>SS83</b>	<b>SN3 LOC</b>	Stored number 3 string
<b>SS84</b>	<b>SN4 LOC</b>	Stored number 4 string
<b>SS85</b>	<b>SN5 LOC</b>	Stored number 5 string
<b>SS86</b>	<b>SN6 LOC</b>	Stored number 6 string
<b>SS87</b>	<b>SN7 LOC</b>	Stored number 7 string
<b>SS88</b>	<b>SN8 LOC</b>	Stored number 8 string
<b>SS89</b>	<b>SN9 LOC</b>	Stored number 9 string

# Appendix E

## Connector Pinouts

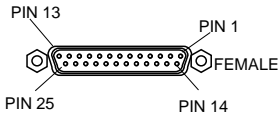

**Figure E-1**  
EIA-232/RS-530 Interface

**Table E-A**  
EIA-232 Interface

Pin	Name	I/O	Description
1	Shield	I/O	Shield for cable
2	TD	I	Transmitted Data
3	RD	O	Received Data
4	RTS	I	Request to Send
5	CTS	O	Clear To Send
6	DSR	O	Data Set Ready
7	SG	I/O	Signal Ground
8	CD	O	Carrier Detect
9	NC	N/A	No Connection
10	NC	N/A	No Connection
11	NC	N/A	No Connection
12	NC	N/A	No Connection
13	NC	N/A	No Connection
14	NC	N/A	No Connection
15	TC	O	Transmit Clock
16	NC	N/A	No Connection
17	RC	O	Receive Clock
18	NC	N/A	No Connection
19	NC	N/A	No Connection
20	DTR	I	Data Terminal Ready
21	NC	N/A	No Connection
22	RI	O	Ring Indicator
23	NC	N/A	No Connection
24	ETC	I	External Transmit Clock
25	NC	N/A	No Connection

I= Input, O= Output, N/A= Not Applicable

Appendix E: Connector Pinouts

**Table E-B**  
*RS-530 Interface*

Pin	Name	I/O	Description
1	Shield	I/O	Shield for cable
2	TD-A	I	Transmitted Data
3	RD-A	O	Received Data
4	RTS-A	I	Request to Send
5	CTS-A	O	Clear To Send
6	DSR-A	O	Data Set Ready
7	SG	I/O	Signal Ground
8	CD-A	O	Carrier Detect
9	RC-B	O	Receive Clock (return)
10	CD-B	O	Carrier Detect (return)
11	ETC-B	I	External Transmit Clock (return)
12	TC-B	O	Transmit Clock (return)
13	CTS-B	O	Clear To Send (return)
14	TD-B	I	Transmit Data (return)
15	TC-A	O	Transmit Clock
16	RD-B	O	Receive Data (return)
17	RC-A	O	Receive Clock
18	NC	N/A	No Connection
19	RTS-B	I	Request To Send (return)
20	DTR-A	I	Data Terminal Ready
21	NC	N/A	No Connection
22	DSR-B	O	Data Set Ready (return)
23	DTR-B	I	Data Terminal Ready (return)
24	ETC-A	I	External Transmit Clock
25	NC	N/A	No Connection

I= Input, O= Output, N/A= Not Applicable

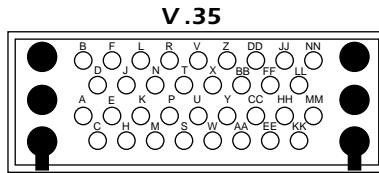
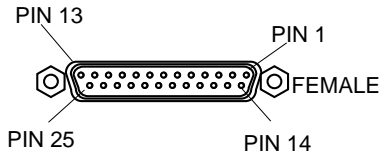

**Figure E-2**  
V.35 Interface

**Table E-C**  
V.35 Interface

Pin	Name	I/O	Description
A	Shield	I/O	Shield for cable
B	SG	I/O	Signal Ground
C	RTS	I	Request To Send
D	CTS	O	Clear To Send
E	DSR	O	Data Set Ready
F	CD	O	Carrier Detect
H	DTR	I	Data Terminal Ready
J*	RI	O	Ring Indicator
P	SDA	I	Send Data
R	RD-A	O	Receive Data
S	SD-B	I	Send Data (return)
T	RD-B	O	Receive Data (return)
U	TC-A	I	External Transmit Clock
V	RC-A	O	Receive Clock
W	TC-B	I	External Transmit Clock (return)
X	RC-B	O	Receive Clock (return)
Y	STA	O	Send Timing
AA	STB	O	Send Timing (return)
K,L	NC	N/A	No Connection
M,N	NC	N/A	No Connection
BB	NC	N/A	No Connection
CC	NC	N/A	No Connection
DD	NC	N/A	No Connection
EE	NC	N/A	No Connection
FF	NC	N/A	No Connection
HH	NC	N/A	No Connection
JJ	NC	N/A	No Connection
KK	NC	N/A	No Connection
LL	NC	N/A	No Connection
MM	NC	N/A	No Connection
NN	NC	N/A	No Connection

\*Pin J (ring indicator) is needed for most video conferencing applications.  
I= Input, O= Output, N/A= Not Applicable

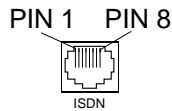

**Figure E-3**  
RS-366 Interface

**Table E-D**  
RS-366 Interface

Pin	Name	I/O	Description
1	Shield	I/O	Shield for cable
2	DPR	I	Digit Present
3	ACR	O	Abandon Call and Retry
4	CRQ	I	Call Request
5	PND	O	Present Next Digit
6	PWI	O	Power Indication
7	SG	I/O	Signal Ground
13	DSC	O	Distant Station Connect
14	NB1	I	Digit LSB
15	NB2	I	Digit bit 2
16	NB4	I	Digit bit 3
17	NB8	I	Digit bit MSB
22	DLO	O	Data Line Occupied
8-12	NC	N/A	No Connection
18-21	NC	N/A	No Connection
23-25	NC	N/A	No Connection

I= Input, O= Output, N/A= Not Applicable



**Figure E-4**  
RJ-45 Interface

**Table E-E**  
RJ-45 ISDN IFC

Pin	Description
4	Ring
5	Tip

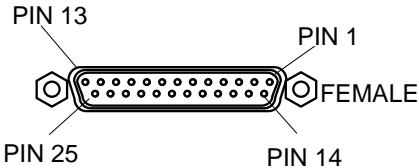

**Figure E-5**  
*Maintenance Port*

**Table E-F**  
*Maintenance Port*

Pin	Name	I/O	Description
2	TD-A	I	Transmitted Data
3	RD-A	O	Received Data

## Appendix E: Connector Pinouts

---

# Acronyms

---

<b>AMI</b>	Alternate Mark Inversion
<b>ANSI</b>	American National Standards Institute
<b>B (Channel)</b>	A 64 kbps digital information channel
<b>BONDING</b>	Bandwidth On Demand Interoperability Group
<b>bps</b>	Bits per second
<b>BRI</b>	Basic Rate Interface
<b>CCITT</b>	Consultative Committee for International Telegraphy and Telephony
<b>CD</b>	Carrier Detect
<b>CIC</b>	Carrier Identification Code
<b>CPE</b>	Customer Premises Equipment
<b>CPU</b>	Central Processing Unit
<b>CRS</b>	Call Request (using stored number)
<b>CRN</b>	Call Request (number in command)
<b>CTS</b>	Clear to Send
<b>DCE</b>	Data Communications Equipment
<b>DIC</b>	Disconnect Incoming Call
<b>DMS</b>	Digital Multiplex Switching
<b>DN</b>	Directory Number
<b>DSR</b>	Data Set Ready
<b>DTE</b>	Data Terminal Equipment
<b>EIA</b>	Electronic Industries Association
<b>EKTS</b>	Electronic Key Telephone Service
<b>ESS</b>	Electronic Switching System
<b>FAX</b>	Facsimile
<b>FEBE</b>	Far End Block Errors
<b>ID</b>	Identification
<b>I/O</b>	Input/Output
<b>ISDN</b>	Integrated Services Digital Network
<b>kbps</b>	Kilobits per second
<b>kHz</b>	Kilohertz
<b>LAN</b>	Local Area Network



## Acronyms

---

<b>LATA</b>	Local Access and Transport Area
<b>Mbps</b>	Megabits per second
<b>MF</b>	Multi-Frequency Signalling
<b>MNP</b>	Microcom™ Network Protocol
<b>NEBE</b>	Near End Block Errors
<b>NT</b>	Network Termination
<b>PBX</b>	Private Branch Exchange
<b>PC</b>	Personal Computer
<b>POTS</b>	Plain Old Telephone Service
<b>PRI</b>	Primary Rate Interface
<b>PRN</b>	Program Stored Number
<b>RAM</b>	Random Access Memory
<b>RLN</b>	List Stored Number
<b>RTS</b>	Ready to Send
<b>SPCS</b>	Stored Program Controlled Switching System
<b>SAP</b>	Simple Adtran Protocol
<b>SPID</b>	Service Profile Identifier
<b>SS7</b>	Signalling System 7
<b>TA</b>	Terminal Adapter
<b>TE</b>	Terminal Equipment
<b>TEI</b>	Terminal Endpoint Identifier
<b>USART</b>	Universal Synchronous/Asynchronous Receiver/ Transmitter
<b>WAN</b>	Wide Area Network

# Glossary

---

***B-Channel***

64 kbps bearer channel used for voice, circuit, or packet switched data.

***bearer service***

As defined by CCITT standards, a type of telecommunication service that provides the capability for the transmission of information between user-to-network interfaces. Bearer services defined for ISDN are circuit mode and packet mode.

***BONDING mode 1 Protocol***

Industry standard B channel aggregation protocol. Developed by the Bandwidth on Demand Interoperability Group.

***CCITT***

Consultative Committee on International Telephony and Telegraphy. A body of the International Telegraph Union (ITU) which prepares recommendations, commonly referred to as international standards, to resolve technical telegraph and telephone problems.

***central office (CO)***

In telephony, the phone company switching facility or center, usually a Class 5 end office, at which subscribers local loops terminate. Handles a specific geographic area, identified by the first three digits of the local telephone number. Usually the facilities of the local BOC.

***clear channel***

A channel in which all the 64 kbps are used for transmission. To achieve this bit robbing signalling must be eliminated.

***D-channel***

The ISDN channel that carries signalling information to control the call setup, teardown, or invocation of supplementary services. The D-Channel may also be used to provide packet mode data service.

**DDS**

Dataphone Digital Service. AT&T private line service for transmitting data over a digital system. The digital transmission system transmits electrical signals directly, instead of translating the signals into tone of varied frequencies as with traditional analog transmission systems. Digital techniques provide more efficient use of transmission facilities, resulting in lower error rates and costs than analog systems.

***digital loopback***

Technique for testing the digital processing circuitry of a communications device. May be initiated locally or remotely via a telecommunications circuit. Device being tested will echo back a received test message after first decoding and then encoding it. The results are compared with the original message (compare with analog loopback).

***four-wire circuits***

Telephone lines using two wires for transmitting and two wires for receiving offering much higher quality than a 2-wire circuit. All long distance circuits are 4-wire. Almost all local phone lines and analog phones are 2-wire.

***hub***

(1) Communications center, (2) Major routing station for connecting channels, (3) DDS connecting center.

***in-band signalling***

Signalling made up of tones which pass within the voice frequency band and are carried along the same circuit as the talk path being established by the signals. Virtually all signalling (request for service, dialing, disconnect, etc.) in the U.S. is in-band signalling. Most of that signalling is MF (multi-frequency) dialing. The more modern form of signalling is out-of-band.

***interexchange carrier***

Since divestiture, any carrier registered with the FCC authorized to carry customer transmissions between LATAs interstate, or if approved by a state public utility commission, intrastate. Includes carriers such as AT&T Communications, Satellite Business Systems, GTE Telenet, GTE Sprint, and MCI.

***information element***

The name for the data fields within an ISDN Layer 3 message.

***interworking***

Communication between two types of networks or end equipment. This may or may not involve a difference in signalling or protocol elements supported.

***ISDN***

Integrated Services Digital Network. A network architecture that enables end-to-end digital connections. The network supports diverse services through integrated access arrangements and defines a limited set of standard, multipurpose interfaces for equipment vendors, network providers, and customers. Interworking with a public switched telephone network is retained.

***LATA***

Local Access and Transport Area. One of 161 local telephone serving areas in the United States, generally encompassing the largest standard statistical metropolitan areas. Subdivisions established as a result of the AT&T divestiture that now distinguish local from long distance service. Circuits with both end-points within the LATA (intraLATA) are generally the sole responsibility of the local telephone company, while circuits that cross outside the LATA (interLATA) are passed on to an interexchange carrier.

***loopback***

A diagnostic procedure where data is sent to the device being tested, and the output of the device is fed directly back to its input, looped around, and the returning data is checked against that which was sent.

***message***

The Layer 3 information that is passed between the CPE and SPCS for signalling.

***multiplexing***

The combining of multiple data channels onto a single transmission medium. Any process through which a circuit normally dedicated to single user can be shared by multiple users. Typically, user data streams are interleaved on a bit or byte basis (time division) or separated by different carrier frequencies (frequency division).

***multipoint circuit***

A circuit consisting of three or more stations connected directly electrically.

***narrowband ISDN***

A collective term for BRA and PRA at speeds up to 1.544 Mbps.

***non-ISDN line***

Any connection from a CPE to a SPCS that is not served by D-Channel signalling.

***non-ISDN trunk***

Any trunk not served by either SS7 or D-Channel signalling.

***NT1***

Network Termination 1. A unit that provides physical and electromagnetic termination of the U-interface 2-wire transmission line, converts between Layer 1 formats used at the U- and T- reference points, and performs some maintenance functions.

**NT2**

Network Termination 2. A unit that provides switching and concentration of subscriber lines at the S-interface. This unit performs the functions of a customer premises switch or multiplexer to multiplex B-channel(s) and D-channel(s) onto one physical path and to route calls to the appropriate B or D channel.

**PRA**

Primary Rate Access. Connects high-capacity CPE, such as PBXs, to the network. In the US, this is composed of twenty-three 64 kbps channels and one 64 kbps D-channel. Also known as Primary Rate Interface (PRI).

***point-to-point***

Describing a circuit connecting two points directly with no intermediate processing nodes or computers (although switching facilities could exist). A type of connection that links two logical entities (i.e., phone-line circuit).

***-serving area***

Region surrounding a broadcasting station where signal strength is at or above a stated minimum. The geographic area handled by a telephone central office facility. Generally equivalent to a LATA.

***S-interface***

S-Reference point. The interface that connects an ISDN terminal (TE1) or Terminal Adapter (TA) to the NT2 reference point as defined in the I.411 Recommendation.

**SPCS**

Stored Program Controlled Switch. A digital switch that supports call control, routing, and supplementary services provision under software control. All ISDN switches are SPCSs.

***synchronous***

(1) The condition occurring when two events happen in a specific time relationship with each other, both under control of a master clock; (2) A method of data transmission requiring the transmission of timing pulses to keep the sender and receiver synchronized in their communication used to send blocks of information. Synchronous data transmission is used in high speed data circuits because there is less overhead than asynchronous transmission of characters which contain two extra bits per character to effect timing.

**T1**

Also T-1. A digital transmission link with a capacity of 1.544 Mbps. T1 uses two pairs of normal twisted wires. T1 normally can handle 24 voice conversations with each conversation being digitized at 64 kbps. With more advanced digital voice encoding techniques, it can handle more voice channels. T1 is a standard for digital transmission in North America.

***T1C***

3.152 Mbps. Capable of handling 48 voice conversations. T1C is further up the North American digital carrier hierarchy.

***T2***

6.312 Mbps. Capable of handling 96 voice conversations. T2 is four times the capacity of T1.

***T3***

44.736 Mbps. Commonly referred to as 45 Mbps. Capable of handling 672 voice conversations. T3 runs on fiber optic and is typically called FT3.

***TA***

Terminal Adaptor. A DCE that connects to the ISDN S-Interface and enables non-ISDN terminal equipment to communicate over the ISDN.

***TE1***

Terminal Equipment Type 1. ISDN-compatible terminals.

***TE2***

Terminal Equipment Type 2. Non-ISDN terminal equipment linked at the EIS-232, RS-449, or V.35 interfaces.

***tandem***

The connection of networks or circuits in series. The connection of the output of one circuit to the input of another.

***T-interface***

T-Reference point. Performs the same function as the S-Interface but uses an NT1, rather than an NT2.

***twisted pair***

Two wires twisted around each other to reduce induction (interference) from one wire to the other. Several sets of twisted pair wires may be enclosed in a single cable. Twisted pair is the normal cabling from a central office to your home or office, or from your PBX to your office phone. Twisted pair wiring comes in various thicknesses. As a general rule, the thicker the cable is, the better the quality of the conversation and the longer cable can be and still get acceptable conversation quality. However, the thicker it is, the more it costs.

**2B+D**

The Basic Rate Interface (BRI) in ISDN. A single ISDN circuit divided into two 64 kbps digital channels for voice or data and one 16 kbps channel for low speed data (up to 9,600 baud) and signalling. 2B+D is carried on one or two pairs of wires depending on the interface, the same wire pairs that today bring a single voice circuit into your home or office. See ISDN.

**23B+D**

In ISDN, also known as the Primary Rate Interface. A circuit with a wide range of frequencies that is divided in twenty-three 64 kbps paths for carrying voice, data, video, or other information simultaneously. It bears a remarkable similarity to today's T1 link, except that T1 carries 24 voice channels. In ISDN, 23B+D gives twenty-three channels and one D channel for out of band signalling. However, in T1, signalling is handled in band. See ISDN.

***two-wire circuit***

A transmission circuit composed of two wires, signal and ground, used to both send and receive information. In contrast, a 4-wire circuit consists of two pairs. One pair is used to send. One pair is used to receive. All trunk circuits (long distance) are 4-wire. A 4-wire circuit delivers better reception, but also costs more. All local loop circuits (those coming from a Class 5 central office to the subscriber's phone system) are 2-wire, unless a 4-wire circuit is requested.

***U-interface***

A twisted pair subscriber loop that connects the NT1 reference point to the ISDN network, as defined in the I.411 Recommendation. This interface provides Basic Rate Access with an operating frequency of 160 kbps and an information rate of 144 kbps. Under U.S. regulations, this also marks the line of demarcation between customer-owned equipment and the public network.

***video-conferencing***

The real-time, usually two-way, transmission of digitized video images between two or more locations. Teleconferencing requires a wideband transmission facility. Transmitted images may be freeze-frame (where television screen is repainted every few seconds to every 20 seconds) or full motion. Bandwidth requirements for two-way video conferencing range from 6 MHz for analog, full-motion, full-color, commercial grade TV to 56 kbps for digitally-encoded freeze-frame to 1.544 kbps for very good quality, full-color, full-motion TV.

***wideband***

Generally, a communications channel offering a transmission bandwidth greater than a voice grade channel. Data transmission speeds on wideband facilities are typically in excess of 9.6 kbps and often at rates such as 56 kbps and 1.544 Mbps.

**X.25**

A packet data transfer protocol for the B and D Channels. Defines the interface between Data Terminal Equipment (DTE) and Data Circuit Terminating Equipment (DCE) for terminals operating in the packet mode and connected to public data networks by dedicated circuits.



## Glossary

---

# Index

## A

- answer call 68
- answer tone 37
  - always tone 37
  - incoming tone 37
  - no answer tone 37
  - outgoing tone 37
- asynchronous data format 45
- AT command
  - connect message options 90
  - remote configuration 71
  - response message options 89
  - response message types 90
- AT commands 30, 87
  - changing S-register strings 32
  - changing S-registers 32
  - dialing a call using the AT command processor 32
  - reading S-register strings 32
  - reading s-registers 32
  - using AT commands 31
  - using S-registers 31
- audio 25
- auto answer
  - disabled 36
  - dump all calls 36
  - enabled 36

## B

- B-channel aggregation 84
- bit rate 42
- BONDING mode 1 7, 26, 48

## C

- cable lengths 12
- call screening 38
- call type 24
  - audio 25
  - data 56 kbps 25
  - data 64 kbps 25
  - default 25
  - speech 24, 25
- calling number identifiers 88
- Capability B 10
- Capability C 10
- Capability R 9, 10
- Capability S 10
- carrier detect 88
- CD options 43
- channel rate 41
- clear channel 7, 48
- clear to send control line options 89
- clock mode
  - master 40
  - slave 40
- compression 52, 57
- configuration 23
  - quick setup 59
  - remote 71
- configuration menu 18
- configure remote unit 73
  - VT 100 screen 73
- connect timeout 38
- connector pinouts 115
  - EIA-232 interface 115

- maintenance port 119
  - RJ-45 ISDN IFC 118
  - RS-366 interface 118
  - RS-530 116
  - V.35 interface 117
- connector type 43
- connector types
  - EIA-232 12
  - RS-366 12
  - RS-530 12
  - V.35 12
- CTS options 43
- current status messages 93
- D**
- data 56 kbps 25
- data 64 kbps 25
- data bits 34
- data flow control options 90
- data format
  - asynchronous flow control) 44
  - transmit clock 45
- data format (asynchronous) 45
- data rates 83
- data set ready control line options 89
- dial 112k sync 61
- dial 115.2 asyn 64
- dial 128k sync 62
- dial 56K 7
- dial 56k sync 60
- dial 56K\*2 7
- dial 57.6 asyn 63
- dial 64K 7
- dial 64k sync 61
- dial 64K\*2 7
- dial interface connection 12
- dial line
  - menu tree 23
  - operation 23
- dial number 68
- dial options 29
  - AT commands 30
  - disabled 35
  - front panel 29
  - RS-366 29
  - V.25 bis 33
- dial ppp 62
- dial stored number 68
- dialing
  - ways to dial 2
- dialing options 67
  - answer call 68
  - dial number 68
  - dial stored number 68
  - hang up line 68
  - redial last number 68
  - store/review number 69
- dialing selections 83
- display 84
- DSR options 44
- DSU 57.6 async 53
- DTE
  - data rates 83
  - interface 83
- DTE connector data synchronous data
  - clocking options 89
- DTE control line options 88
- DTE data connection 12
- DTE data rates 83
- DTE date type options 88
- DTE indicators 3
- DTE interface 83
  - cable lengths 12
- DTE options 42
  - bit rate 42
  - CD options 43
  - connector type 43
  - CTS options 43
  - data format (async) 45
  - DSR options 44
  - DTR options 43

- flow control (async data format ) 44
    - RTS options 43
    - transmit clock (sync) 45
  - DTR options 43
  - dump all calls 36
- E**
- EIA-232 12
  - interface 115
- environmental specifications 85
- EON (end of number) 30
- error control 51
- F**
- factory setup 66
- fallback 54
  - 57.6k 64
- FAX service 12
- features 83
- flow control 6, 7
- flow control (async data format) 44
- front panel 29
- function keys 15
- G**
- Generic Data I 9
- generic unit configurations 88
- getting started 16
- H**
- hang up line 68
- I**
- if self test fails 77
- if the ISU 128 does not read ready 77
- installation 11
- interoperability 84
- ISDN
  - basic rate service 11
  - basic rate service (defined) 2
  - ordering codes 9
    - Capability B 10
    - Capability C 10
    - Capability R 9, 10
    - Capability S 10
    - Generic Data I 9
  - overview 1
  - switch protocol options 90
  - U-interface operational mode options 90
- ISU 128
  - front panel 3
  - interoperability 4
  - overview 1
  - rear panel 2
  - specifications and features 83
- L**
- ldm 128 master 65
- LDN
  - setting 26
- LDN access options 90
- leased 128K 7, 65
- leased 64K 7
- leased line 40
  - channel rate 41
  - clock mode 40
- leased line service
  - defined 2
- LED indicators 84
- local echo options 89
- loopback disable 21
  - DDS accepted 21
  - DDS+V54 accept 22
  - no remote loopbacks 21
  - V.54 accepted 21

- loopback DTE 20
- loopback network 20
- loopback points 20
- loopback protocol 20
- loopback remote 21
- loopback remote 1B 74
  - VT 100 screen 75
- loopback remote 2B 74

## M

- maintenance interface 13, 119
- menu navigation 15
- menu tree
  - main branches 16
- microcom™ network protocol block size (MNP® blk) 52
- more 65
- multilink ppp 56

## N

- NEBE/FEBE 22
- negotiation fail 102
- network
  - data rates 83
  - interface 83
  - options 88
- network connection 11

## O

- operating protocols
  - recommended 6, 7
- operation 15
- ordering ISDN with IOCs 9

## P

- password
  - remote configuration 74
- physical specifications 85

- point-to-point protocol 56
- power supply 85
- PPP
  - with compression 57
- ppp 7
- ppp async-to-sync 56
- protocol options 47
  - BONDING mode 1 7, 48
  - clear channel 7, 48
  - DSU 57.6 async 53
  - fallback 54
  - multilink ppp 56
  - ppp 7, 56
  - ppp async-sync 56
  - SAP 7, 53
  - T-link 7, 53
  - V.110 7, 51
  - V.120 7, 50
  - V.34 51
- protocols
  - rate adaption 54
  - recommended 6, 7

## Q

- quick setup 59
  - dial 112k sync 61
  - dial 115.2 asyn 64
  - dial 128k sync 62
  - dial 56k sync 60
  - dial 57.6 asyn 63
  - dial 64k sync 61
  - dial ppp 62
  - factory setup 66
  - fallback 57.6k 64
  - ldm 128 master 65
  - leased 128K 65
  - V34 115.2 async 63

**R**

rate adaption 84  
rate adaption protocols 54  
recommended operating protocols 6, 7  
redial last number 68  
remote configuration 71, 73  
    AT commands 71  
    loopback remote 1B 74  
    loopback remote 2B 74  
    menu path 72  
    set password 74  
    testing 72  
    VT 100 screen 72  
remote testing 74  
repair and return 11  
RJ-45  
    connector 11  
    interface 118  
    jack 2  
RS-366 12, 29  
    interface 118  
    menu tree 29  
RS-530 12  
    interface 116  
RTS control line options 90  
RTS options 43

**S**

SAP 7  
self test failure 77  
set password 74  
    VT 100 screen 75  
Simple ADTRAN Protocol (SAP) 53  
software version 22  
specifications 83  
speech 24  
SPID  
    obtaining 25  
    setting 25

SPID access options 90  
S-registers 107  
status buffer 16  
    messages 97  
status menu 17  
store/review number 69  
stored numbers 89  
switch compatibility 84  
switch protocol 24  
synchronous data format  
    transmit clock 45

**T**

TANULL 50  
TCID 50  
terminal identification 25  
test menu 19  
test menu path 74  
test menu tree 20  
test options 19  
    loopback disable 21  
    loopback DTE 20  
    loopback network 20  
    loopback protocol 20  
    loopback remote 21  
    NEBE/FEBE 22  
    software version 22  
    test remote 21  
test remote 21  
testing 19  
time-out 29  
timers 49, 50  
T-link 7, 53  
troubleshooting 77  
TXADD01 50  
TXDEQ 50  
TXFA 49  
TXINIT 49

## U

unit identification 89

## V

V.110 7, 51

V.120 7, 50

V.25

    V.25 HDLC flag 35

    V.25 sync bisync dialing 35

    V.25 sync HDLC dialing 35

V.25 bis 33

    menu tree 33

    V.25 async dialing 34

V.34 51

    compression block size options 91

    compression options 91

    operational mode options 91

V.35 12

    interface 117

V34 115.2 async 63

videoconferencing 12

VT 100

    configuration screen 18

    set password screen 75

VT 100 terminal

    configuration screen 18, 24

    dial options screen 67

    status screen 17

    test screen 19

## Product Support Information

### Presales Inquiries and Applications Support

Please contact your local distributor, ADTRAN Applications Engineering, or ADTRAN Sales:

Applications Engineering	(800) 615-1176
Sales	(800) 827-0807

### Post-Sale Support

Please contact your local distributor first. If your local distributor cannot help, please contact ADTRAN Technical Support and have the unit serial number available.

Technical Support	(888) 4ADTRAN
-------------------	---------------

### Repair and Return

If ADTRAN Technical Support determines that a repair is needed, Technical Support will coordinate with the Return Material Authorization (RMA) department to issue an RMA number. For information regarding equipment currently in house or possible fees associated with repair, contact RMA directly at the following number:

RMA Department	(205) 963-8722
----------------	----------------

Identify the RMA number clearly on the package (below address), and return to the following address:

ADTRAN, Inc.  
RMA Department  
901 Explorer Boulevard  
Huntsville, Alabama 35806

RMA # \_\_\_\_\_