

# UNIT TYPE VIDEO INTERCOM DOOR STATION

**MODELS: MB-D** (with plastic cover)  
**MB-DA** (with metal cover)

## — INSTRUCTIONS —

MB-D/DA ARE DOOR STATIONS OF MB-SERIES VIDEO INTERCOM SYSTEM, IN COMBINATION WITH MB-U VIDEO MONITOR UNIT AND IC CHIME TONE INTERCOM: EITHER IC-1AD(U), IC-1GD(U) OR IC-2AD(U). ALSO, WORKS WITH EXISTING TB-F OR TB-H PHONE TYPE INTERCOM SYSTEM.

## NAMES AND FUNCTIONS

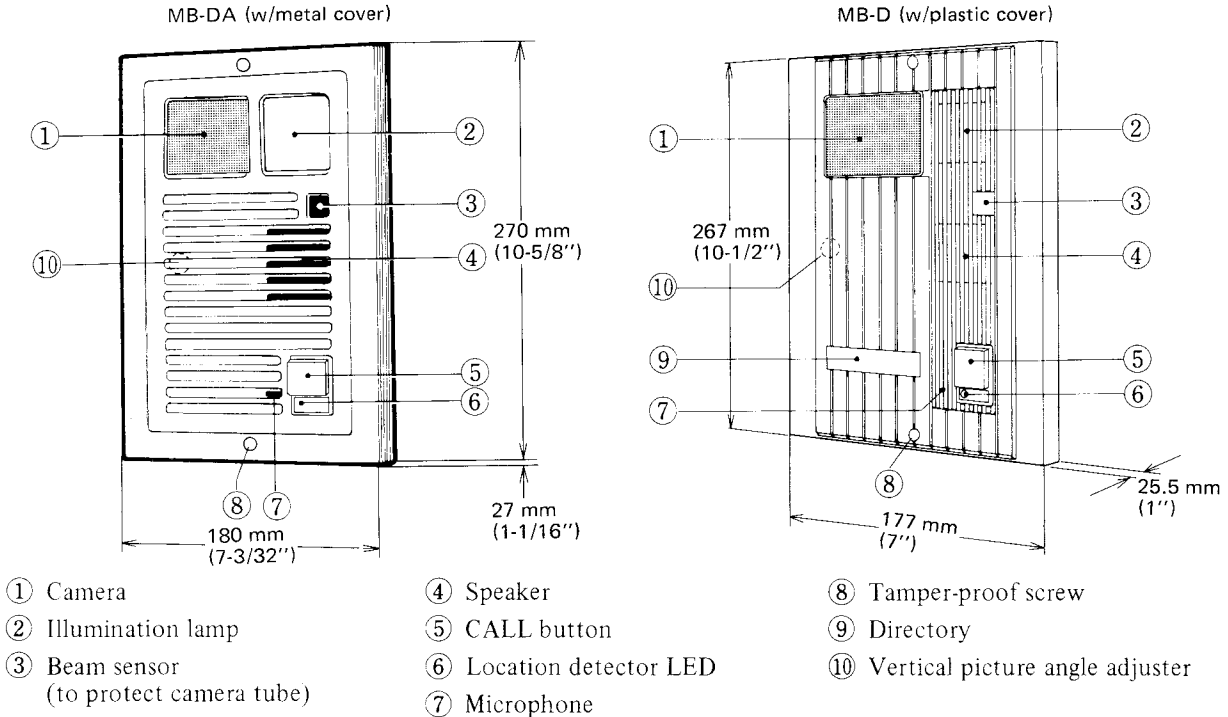

## FEATURES

1. Thin and compact design. Projects only 25.5 mm (1'') from the wall.
2. Weather-resistant type.
3. Camera lens is protected by high impact-resistant shield. Front panel is of polycarbonate resin for MB-D and of aluminum alloy for MB-DA, both with tamper-proof screws.
4. Sharp camera focus. The camera has wide-angle lens, capturing image from 25 cm to up to 5 m (10'' to 16').
5. Beam sensor protects the camera from potential damage due to excessive light.
6. Quick response door station. Illuminating lamp is lit upon pushing call button. The video monitor displays image of caller immediately after call tone sounds.
7. Either semi-flush or surface mounting.
8. Simple wiring. One coaxial cable plus two pair wires.
9. Vertical picture angle adjuster included on door station.
10. MAW-B relay box for auxiliary light to illuminate the caller from the front.

## BEFORE YOU INSTALL THE EQUIPMENT — Prohibitions and precautions —

1. DO NOT OPEN THE BACK COVER OF MB-D/DA UNIT, WITHOUT FIRST REMOVING PLUG OF PS-24N POWER SUPPLY FROM AC OUTLET. The high voltage is loaded on the camera unit.
2. DO NOT CONNECT ANY TERMINAL ON MB-D/DA TO AC POWER LINES.
3. Avoid to run the coaxial cable thru doors or windows or between furniture, which may pinch connecting wires.
4. Handle MB-D/DA unit with utmost care. The built-in camera-tube, if dropped or struck, can be damaged.

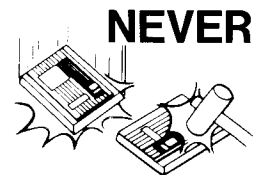

# SPECIFICATIONS

- \* Camera tube: 2/3 inch vidicon.
- \* Illumination requirements: Approximately 100 lux (minimum).
- \* Scanning line: 625/525 lines.
- \* Calling: 4-stroke electronic chime.
- \* Wiring: One coaxial cable plus two pairs of wires (one pair for illumination and the other for communication).
- \* Wiring:

Video;

Coaxial cable	3C-2V	5C-2V
Distance between MB-D/DA & MB-U	100 m	300 m
Coaxial cable	RG-59/U (22GA)	RG-59/U (20GA)
Distance between MB-D/DA & MB-U	600'	1000'

\*Coaxial cable requirements on Page 4 must be met.

Power line for illumination lamp and communication line;

Wire gauge	0.9 mm dia.	1.2 mm dia.	1.6 mm dia.
Distance	100 m	200 m	300 m
Wire gauge	20AWG	16AWG	14AWG
Distance	330'	660'	1000'

## MB-D·DA/MB-U VIDEO INTERCOM SYSTEM COMPONENTS

Door stations;



MB-D: Door station with camera and communication circuits. Also, includes illumination lamp & beam sensor.



MB-DA: —do—, with metal panel.



(IC-JA)

IC-DC, IC-JA, IC-NA, IC-FY, IC-RA, IC-KA:  
Intercom door station without camera. One per system. Select either type to suit your requirements.

Accessories;



PS-24N: Power supply for an entire system. DC 24V, 2A.



ICR-1: Chime call extension.



MAW-B: Relay box to illuminate additional lamp. Powered by PS-24N power supply.



EL-9S: Electric door release. AC 12V, 0.25A. Must be powered by a separate transformer.

Room stations;



MB-U: Main video monitor unit. Used with main room station or an intercom master.

Chime tone intercom main room station. Includes a button for door release.

IC-1AD(U): Type 1 door-1 room.

IC-1GD(U): Type 1 door-3 rooms.

IC-2AD(U): Type 2 doors-3 rooms.



(IC-2AD(U))



MBH-U: Sub video monitor unit. Used with ICH-1CD/A or an intercom master.

ICH-1CD/A:

Chime tone intercom sub room station. Includes a button for door release.

Mounting accessories;

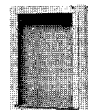

MAW-J: Flush-mounting back box for MB-D/DA.



MAW-R: Surface-mounting box for MB-D/DA.

Note: The MB-D·DA/MB-U video intercom system can also work with the existing TB-F or TB-H phone type intercom system.

## INSTALLATION LOCATION REQUIREMENTS

- The location of the door station should not be exposed to:
  - \* Direct sunlight, rain or snow.
  - \* A strong light source such as mercury street lamps, porch or gate lights, which may create the spotted stain (permanent burn-out) in the picture tube of room stations.
  - \* If the sunlight or other strong light source is behind the person standing at the door station, and there is not illuminating lamp spotlighting the face, the face will appear dark on the room station monitors. This situation can occur when buildings create shadows on entry areas.
  - \* A separate illumination light may be necessary. The AIPHONE Relay Unit MAW-B is available, to turn on an external light when the visitor depresses the call button on the door station.
- Taking the adults' average height in consideration, please decide most suitable height of MB-D/DA door station. It is suggested that the center of a camera lens be installed at an adults' average height minus 10 cm (4").

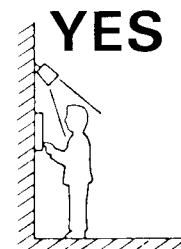
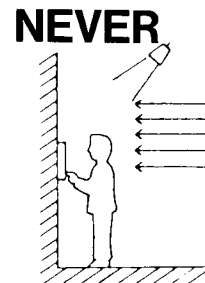
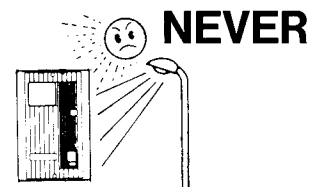

## ACTUAL TERMINAL LOCATIONS

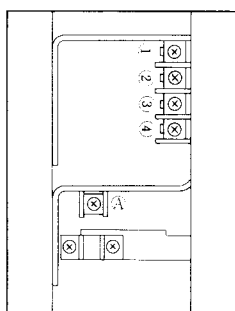

- 1 , 2 : For calling and communication  
3 , 4 : For illumination lamp.  
A : For video

## FLUSH-MOUNTING TO WALL

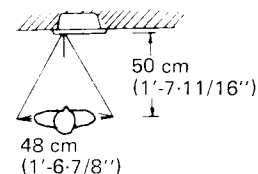
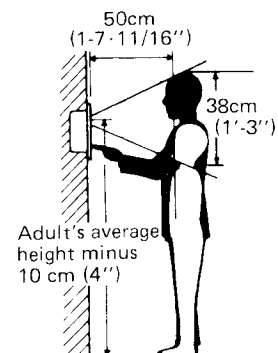
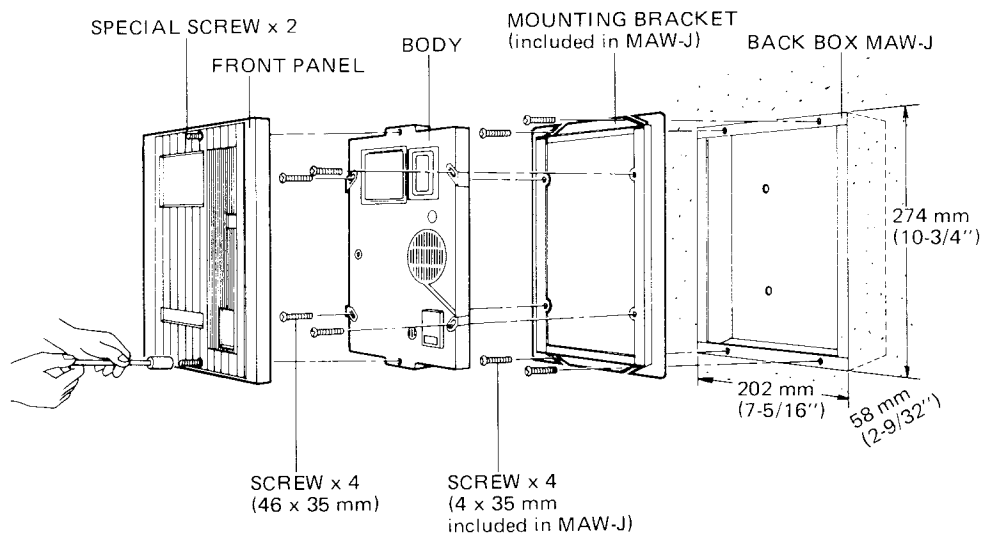

- Use the template provided to open a hole of H: 274 mm x W: 202 mm (H: 10-3/4" x W: 7-15/16") securing depth of 58 mm (2-5/16") or deeper.
- Install MAW-J back box into the wall.
- Connect wires on MB-D/DA terminals.
- Attach the bracket to the back box with 4 screws so as to be fitted vertically.
- Attach MB-D/DA body to the bracket with 4 screws.
- Remove the protective black paper put on the camera lens.
- Attach front panel to the MB-D/DA body with 2 special tamper-proof screws (driver is included).

NOTE: When mounting MB-D/DA on the surface of gate or wall, use MAW-R surface-mounting box.

## ADJUSTING VERTICAL PICTURE ANGLE

The MB-D/DA unit includes an adjuster for vertical picture angle to move a picture by 2.5 cm (1") each upward and downward at a distance of 50 cm (1'-7 1/16").

1. Remove the front panel, using a special driver provided.
2. Remove the cap.
3. Adjust using a small standard screwdriver.
4. Replace the cap for weather resistance.

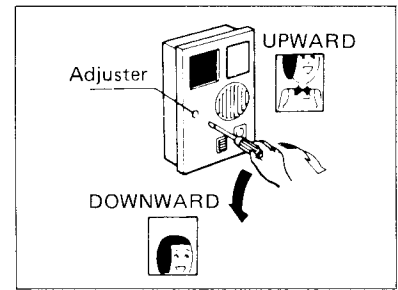

## REPLACEMENT OF AN ILLUMINATION LAMP

1. Remove a front panel, using a special driver provided.
2. Remove 4 screws and lamp cover.
3. Attach the tube provided to lamp and pull it off.

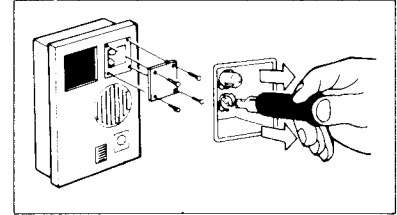

## DIRECTORY CARD PLACEMENT (MB-D ONLY)

Fill in the name by permanent ink pen. As shown, attach firmly the directory between the covers to the front panel. Be careful not to place the back cover reversely.

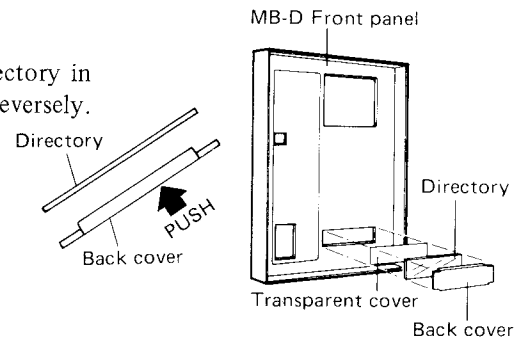

## COAXIAL CABLE CONNECTION

### COAXIAL CABLE REQUIREMENTS:

Use 5C-2V or 3C-2V OR RG-59/U which must meet the following specifications;

- \* Both core and braided conductors must be of copper (not of copper-weld).
- \* Impedance: 75 ohm.
- \* Permitted closed loop DC resistance: 14 ohm.
- \* Permitted attenuation: 6 dB at 4 MHz.
- \* Cable sheath size should not exceed 7.4 mm (5/16").

When using 3C-2V, strip the insulation and fold back the braided conductors, as shown to avoid shorting to core conductors.

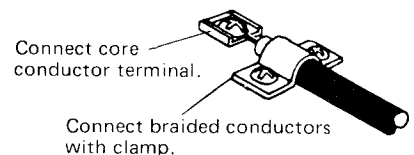
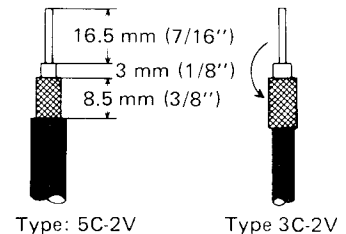

## WARRANTY

Aiphone warrants its products to be free from defects of material and workmanship under normal use and service for a period of one year after delivery to the ultimate user and will repair free of charge or replace at no charge, should it become defective upon which examination shall disclose to be defective and under warranty. Aiphone reserves unto itself the sole right to make the final decision whether there is a defect in materials and/or workmanship; and whether or not the product is within the warranty.

This warranty shall not apply to any Aiphone product which has been subject to misuse, neglect, accident, or to use in violation of instructions furnished, nor extended to units which have been repaired or altered outside of the factory.

This warranty does not cover batteries or damage caused by batteries used in connection with the product.

This warranty covers bench repairs only, and any repairs must be made at the shop or place designated in writing by Aiphone. Aiphone will not be responsible for any costs incurred involving on site service calls.

Aiphone Co., Ltd., Nagoya, Japan  
Aiphone Corporation, Bellevue, Washington  
MB-D-I-0686 ©

INTERCOM SYSTEMS  
**AIPHONE**  
HOME, BUSINESS, INDUSTRY  
Printed in Japan (E)