

IE VIDEO DOOR STATION

Model;

MF-D

(Video door station, semi-flush mount)

INSTRUCTIONS

1

NAMES AND FUNCTIONS

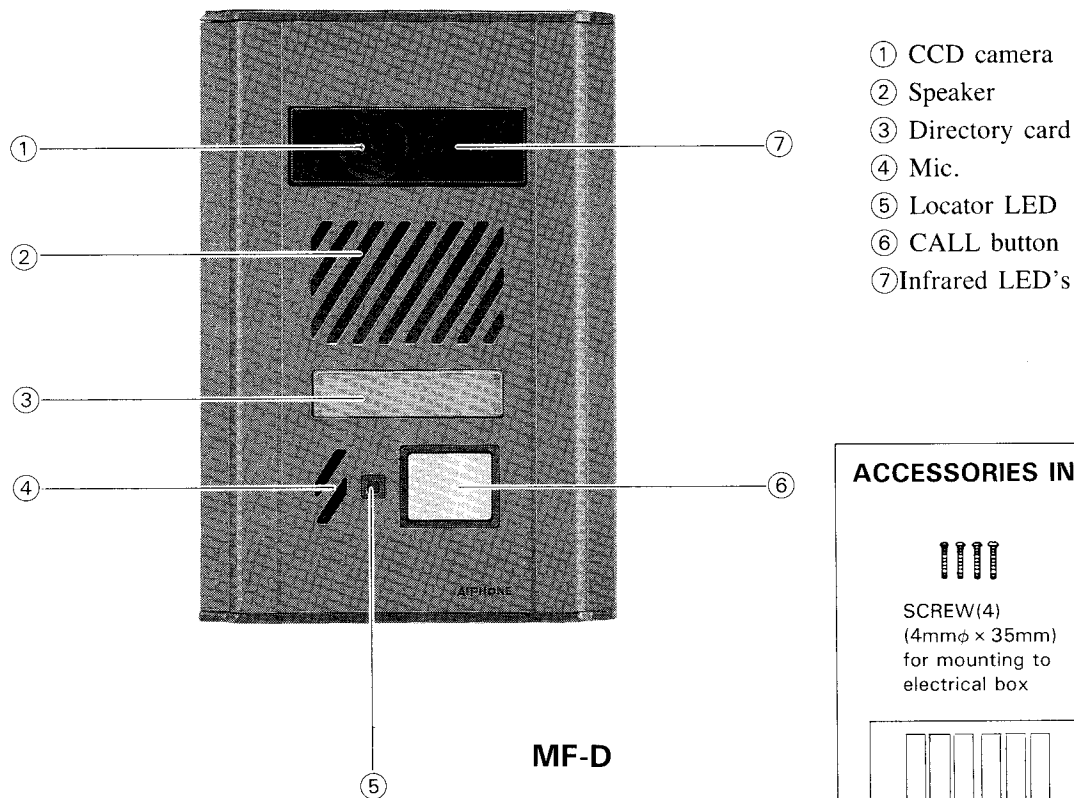

ACCESSORIES INCLUDED;



SCREW(4)
 (4mmφ × 35mm)
 for mounting to
 electrical box

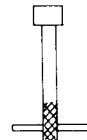

SPECIAL DRIVER
 for panel mounting
 screw

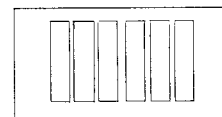

DIRECTORY
 CARD(6)

2

FEATURES

- * MF-D is a video door station for use with IE Chime Tone Intercom Systems: IE-1AD(U), IE-1GD(U) & IE-2AD(U).
- * Employs CCD (Charge-Coupled Device) camera and infrared LED's.
- * Weather-resistant type.
- * Semi-flush mounts to an electrical box or surface-mounts to MCW-R box.
- * Camera lens is protected by vandal-resistant shield.
- Front panel is of anodized aluminum with tamper-proof screw.

3

BEFORE YOU INSTALL AND OPERATE THE EQUIPMENT

- Prohibitions and precautions -

INSTALLATION

- ① DO NOT CONNECT ANY TERMINAL TO AC POWER LINES.
When you mount MF-D in place of existing bell or chime, be sure to disconnect wires from the present transformer.
- ② DO NOT OPEN THE MF-D UNIT, WITHOUT FIRST REMOVING PLUG OF POWER SUPPLY FROM AC OUTLET.
- ③ Do not drop or hit the MF-D which may damage the CCD camera unit.
- ④ Avoid running the connecting wires through doors, windows or between furniture, which may pinch and disconnect the wires.

INSTALLATION LOCATION

- ⑤ Select the MF-D installation location, observing the following conditions.
- ⑥ Avoid installing the MF-D in a location that would be exposed to; * direct sunlight, * temperature/humidity extremes, * water, * oil, * dust, * iron dust, * inflammable and chemical products, etc., or * where the strong light source is behind the person standing at the door station. This situation can occur when buildings create shadows on entry areas.
- ⑦ As shown, it is recommended that the MF-D be installed at an entrance not exposed to direct sunlight and with 200 to 300 lux secured on the object.

INSTALLATION HEIGHT

- ⑧ Taking the adults' average height into consideration, decide a most suitable height of MF-D door station. It is suggested that the center of a camera lens be installed at an adults' average height minus 10cm(4").

MAINTENANCE

- ⑨ Clean your MF-D unit with a soft cloth dampened with neutral household cleanser. Never use lacquer thinner or benzine, etc.
- ⑩ Do not splash water directly on unit.

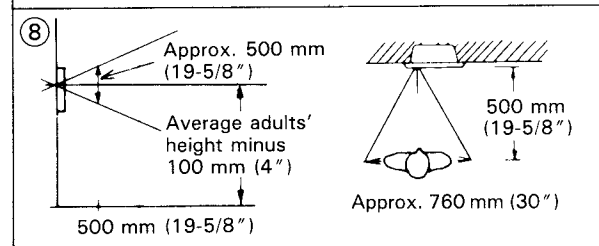
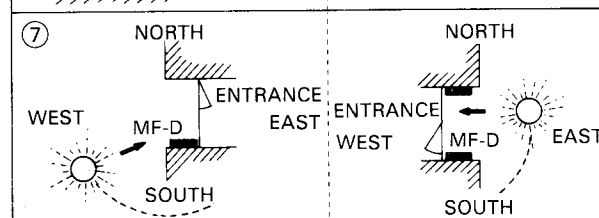
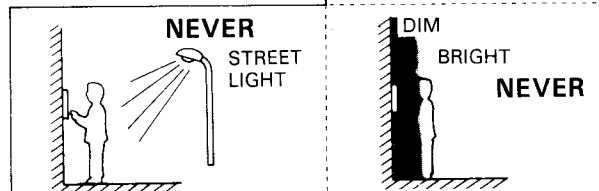
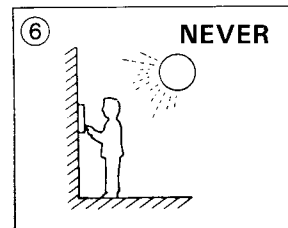

4

INSTALLATION

(1) ACUTAL TERMINAL LOCATION

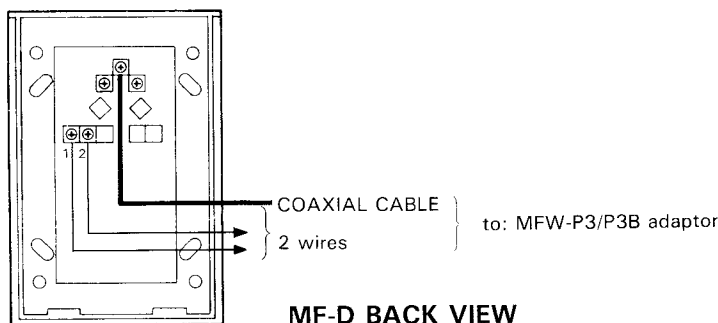

COAXIAL CABLE: Connect to 1, 2, 3 on MFW-P3/P3I

1 } Connect to either **D1 E1**, **D2 E2** or **D3 E3**
2 } terminals (on MFW-P3/P3B)(non-polarized).

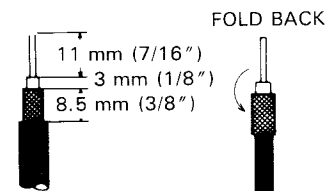

Type: 5C-2V Type: 3C-2V

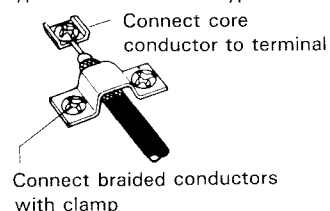

(2) COAXIAL CABLE CONNECTION

Use 5C-2V or 3C-2V OR RG-59/U which must meet the following specifications;

- * **Both core and braided conductors must be of copper (not of copper-weld)**
- * Impedance: 75 ohm.
- * **Permitted closed loop DC resistance; 7 ohm.**
- * Permitted attenuation: 6 dB at 4 MHz.
- * Cable sheath size should not exceed 7.4 mm (5/16").

When using 3C-2V, strip the insulation and fold back the braided conductors, as shown to avoid shorting to core conductors.

(3) WALL MOUNTING

SEMI-FLUSH MOUNTING (to new and plastered wall);

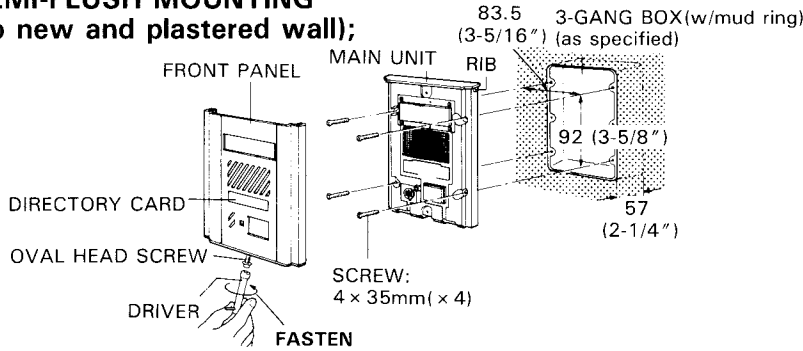

MCW-V DIMENSIONS:

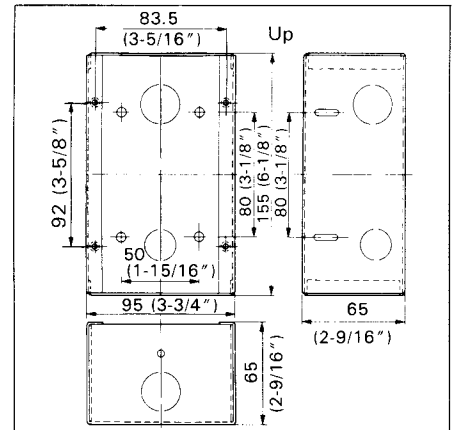

1. Loosen the oval head screw on bottom front panel by the provided driver.
2. Pull the front panel at bottom and remove from the main unit.
3. Connect wires on terminals on back of the main unit.
4. Mount the main unit on the electrical box with supplied four screws (4 mm ϕ \times 35 mm).
5. Attach the front panel to the main unit inserting to the rib provided on top main unit.
6. Rescrew the special screw on bottom front panel by the provided driver.

GANG BOX REQUIREMENTS;

MF-D can be mounted on the 3-GANG BOX as specified below;

For North America; * 3-GANG BOX, 1-5/8" DEEP, WITH RAISED COVER, NEMA standards

* 3-GANG BOX, SHALLOW, Tile Wall Box 1/2" knockouts, NEMA standards

For everywhere except N. America; * JIS 3-SWITCH BOX (w/mud ring) (Model: DS4913, to be supplied by AIPHONE).

SEMI-FLUSH MOUNTING (in existing constructions);

To mount MF-D on existing wall or on marble wall (where no plaster is used), use Aiphone's MCW-V box, without mud ring. Cut out a hole in the wall, of W:95 mm \times H:155 mm (W: 3-3/4" \times H:6-1/8"), securing depth of 65 mm (2-9/16").

SURFACE-MOUNTING;

Aiphone supplies MCW-R box, designed for MF-D surface-mounting. For details, refer to the Instructions packed with MCW-R box.

(4) DIRECTORY CARD REPLACEMENT

The six directory cards are supplied with the MF-D unit. When replacing the card, first remove front panel and the card cover can be removed, using a screwdriver.

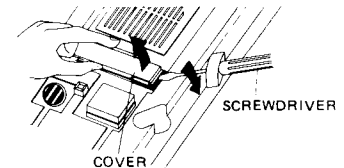

5 WIRING DIAGRAM

IE-2AD(U)/MF-D VIDEO SYSTEM;

1. Connect power supply PS-24N to MFW-P3/P3B & IE main room station individually.
2. MFW-CZ video camera installation is optional (for surveillance of 3rd entry/area).
3. When IE-1AD(U) or IE-1GD(U) main room stations are used, there are no **D2**, **E2** terminals and only one MF-D video door station can be connected.

For wiring connections on MFW-P3/P3B, be sure that door station and door release terminals collate with one another in the following manner;

Coaxial cable terminals	1	2	3
Door station terminals	D1, E1	D2, E2	D3, E3
Door release terminals	L1	L2	L3

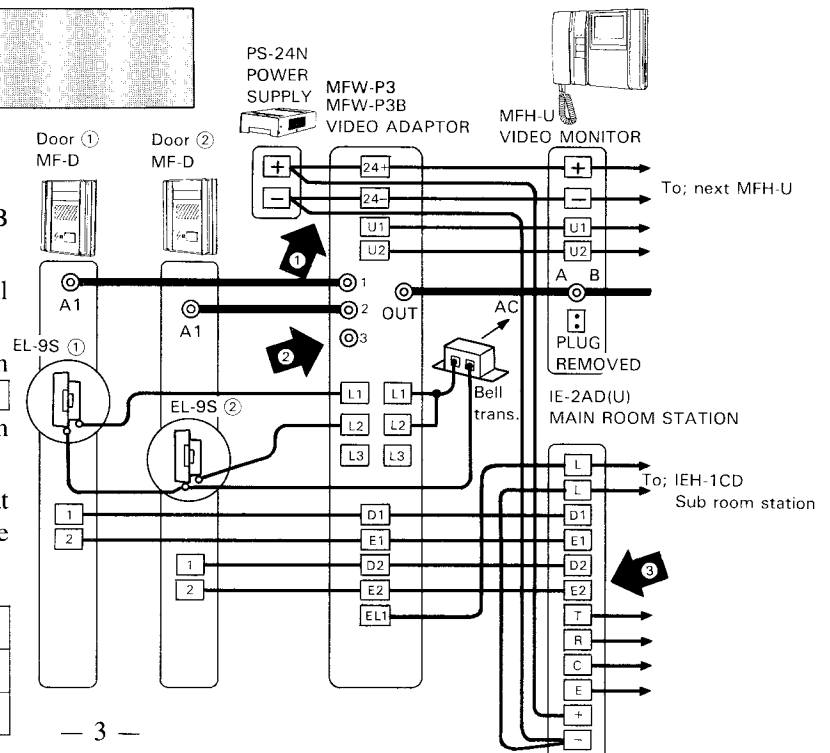

6

OPERATIONS

To call room station;

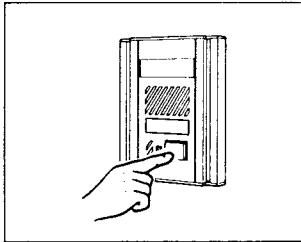

Momentarily depress CALL button.

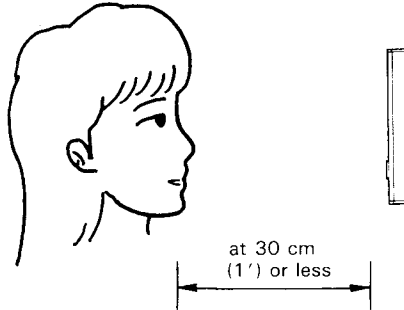
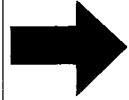

Communicate handsfree when the room station replies.
Stand in front of the camera at approx. 30 cm (1') distance,
to obtain the best picture at night.

7

SPECIFICATIONS

- * Power source: Supplied by MFW-P3/P3B video adaptor.
- * Camera unit: CCD (Charge-Coupled Device) and infrared LEDs.
- * Minimum illumination: 1 lux or less on the object at a distance of 30 cm (1') or less.
It is suggested to secure brightness of 200 to 300 lux in the dark area to obtain best picture.
- * Scanning line: 525 lines.
- * Object pickup range: Approx. 50 cm (19-5/8") (average) vertically.
Approx. 76 cm (30") (average) horizontally.
- * Calling: Electronic chime tone.
- * Wiring: One coaxial cable plus 2 wires.
- * Wiring distance: For audio/video;

Coaxial cable AWG	RG-59/U (22GA) 22AWG	RG-59/U (20GA) 22AWG	Coaxial cable Diameter	3C-2V 0.65 mm	5C-2V 0.65 mm
Distance	165'	495'	Distance	50 m	150 m

- * Dimensions and weight: (H × W × D) 175 × 120 × 63.5 (mm) (6-7/8" × 4-3/4" × 2-1/2"). Approx. 560 g (1.23 lbs.).
Projects 25.5 mm (1") from the wall.

WARRANTY

Aiphone warrants its products to be free from defects of material and workmanship under normal use and service for a period of one year after delivery to the ultimate user and will repair free of charge or replace at no charge, should it become defective upon which examination shall disclose to be defective and under warranty. Aiphone reserves unto itself the sole right to make the final decision whether there is a defect in materials and/or workmanship; and whether or not the product is within the warranty.

This warranty shall not apply to any Aiphone product which has been subject to misuse, neglect, accident, or to use in violation of instructions furnished, nor extended to units which have been repaired or altered outside of the factory.

This warranty does not cover batteries or damage caused by batteries used in connection with the product.

This warranty covers bench repairs only, and any repairs must be made at the shop or place designated in writing by Aiphone. Aiphone will not be responsible for any costs incurred involving on site service calls.

AIPHONE CO., LTD., NAGOYA, JAPAN
AIPHONE CORPORATION, BELLEVUE, WA.



INTERCOM SYSTEMS
AIPHONE
HOME, BUSINESS, INDUSTRY

Printed in Japan(E)

MF-D-I(E)0390C