

# VIDEO DOOR STATION

Model; **MY-CB** (Surface-mount, charcoal gray)

## INSTRUCTIONS

### 1 NAMES AND FUNCTIONS

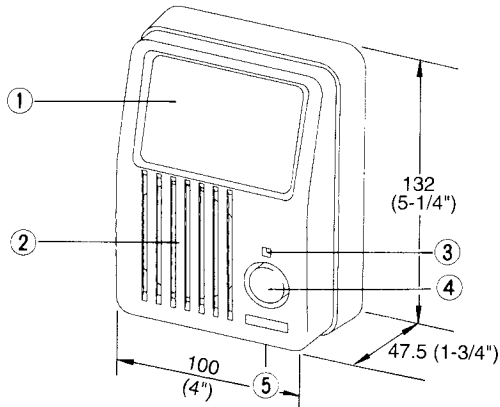

- ① CCD camera with infrared LEDs
- ② Speaker
- ③ Locator LED
- ④ CALL button
- ⑤ Microphone

#### Mounting accessories

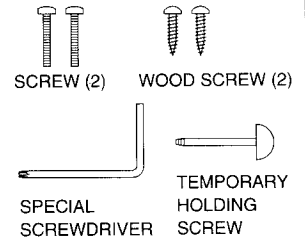

MY-CB is the video door station for use with MY-1BD or MY-1AD fixed camera system.

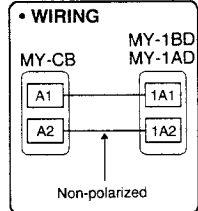
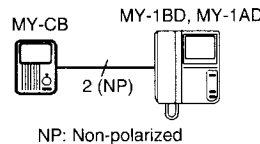

### 2 INSTALLATION LOCATION

The picture quality could be affected by outside light, as shown in drawings. Avoid the locations which are exposed to;

- Strong backlight (sunlight, street light, etc.) (darkens object image on monitor),
- Fluorescent light (creates flickering on monitor),
- Drastic temperature drops after rainfalls, etc. (fogging inside camera; can be restored soon)

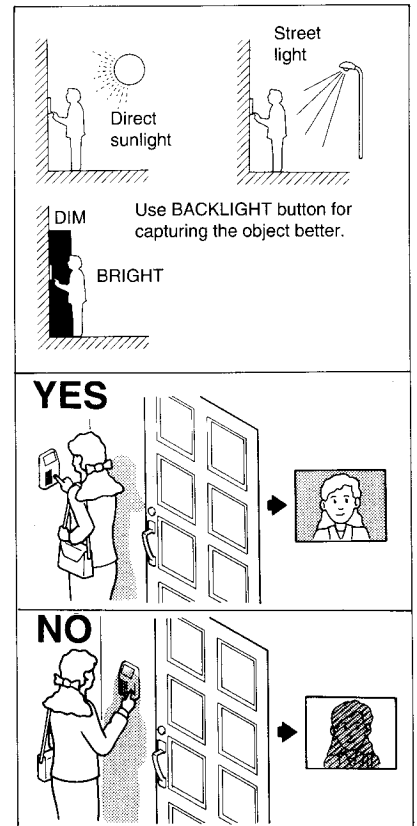

#### Image viewing area;

All the figures are approximate.

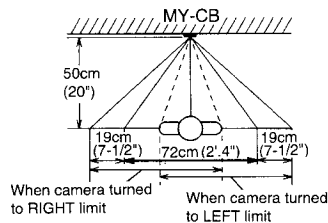
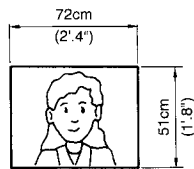

#### • When shipped;

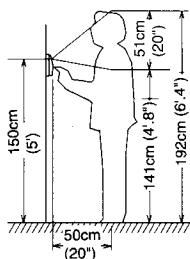

#### • When camera is turned upward;

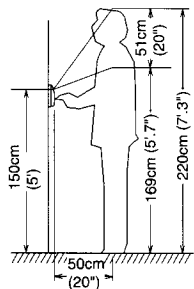

#### • When camera is turned downward;

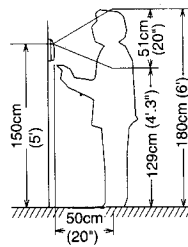

# 3 INSTALLATION

If camera angle is not changed, proceed with installation, following steps ①, ②, ④ and ⑩ only.

- ① Remove a screw cover, pulling from the bottom notch. Loosen tamper-proof screw with the supplied screwdriver.
- ② Attach the back frame to SINGLE-GANG BOX or to wall with the supplied screws or wood screws.
- ③ Pull the tamper screw, and push CALL button, and remove the front case from the MY-CB main unit.
- ④ Connect wires on 2 terminals.
- ⑤ Insert the supplied screw to temporarily hold the main unit to back frame.
- ⑥ Unscrew at 2 points to open the camera cover. Take away the camera lens fixer (will not be reused).
- ⑦ Change the camera angle, pushing arrow part. Be careful not to touch the lens surface. The camera gearing sound is heard, but this is not an unit disorder.
- ⑧ Reattach the camera cover. Be careful that the weather-stripping rests in place.
- ⑨ Loosen the temporary holding screw. Reattach the front case to the main unit, until it locks.
- ⑩ Fasten the tamper screw and attach the cover.

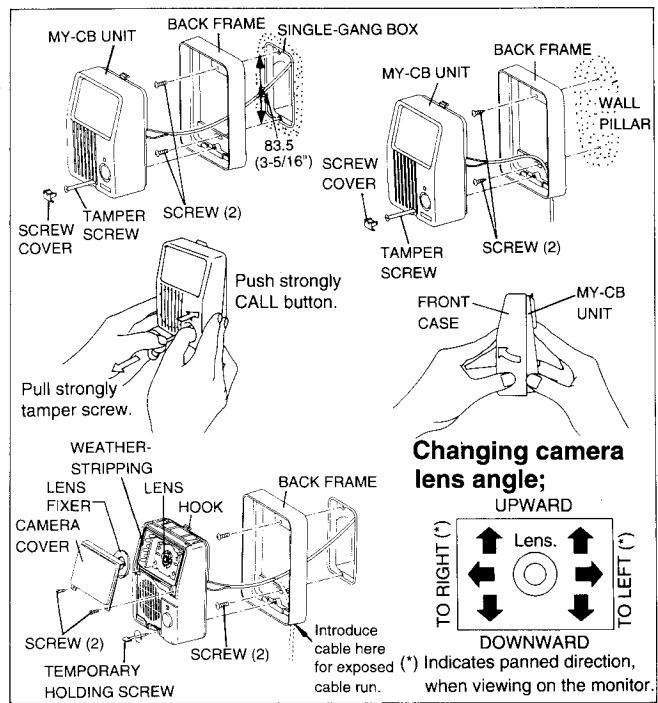

# 4 SPECIFICATIONS

*Power source:	Supplied by MY-1BD or main video monitor.
*Camera unit:	CCD (Charge-Coupled Device) with infrared LEDs.
*Scanning line:	525 lines.
*Image viewing area:	Vertically: approx. 51cm (1'8") Horizontally: approx. 72cm (2'5")
*Camera angle adjustable:	Upward: approx. 14.5° Downward: approx. 11.5° To each left or right: approx. 12°
*Minimum illumination:	1 lux or less (at 50cm/20" distance)
*Dimensions (H x W x D) & weight:	132 x 100 x 47.5 (mm) (5-1/4" x 4" x 1-3/4"). Approx. 300g (0.66 lbs.)

\*For further information, refer to the Instructions furnished with main room stations.

# 5 TO MAINTAIN PROPERLY

- Clean MY-CB unit with a soft cloth dampened with neutral household cleanser. Never use lacquer thinner or benzene, etc. Be careful with the camera cover, as it could be scratched.
- Do not splash water to MY-CB door station by hose, etc.

## WARRANTY

Aiphone warrants its products to be free from defects of material and workmanship under normal use and service for a period of one year after delivery to the ultimate user and will repair free of charge or replace at no charge, should it become defective upon which examination shall disclose to be defective and under warranty. Aiphone reserves unto itself the sole right to make the final decision whether there is a defect in materials and/or workmanship; and whether or not the product is within the warranty.

This warranty shall not apply to any Aiphone product which has been subject to misuse, neglect, accident, or to use in violation of instructions furnished, nor extended to units which have been repaired or altered outside of the factory.

This warranty does not cover batteries or damage caused by batteries used in connection with the product.

This warranty covers bench repairs only, and any repairs must be made at the shop or place designated in writing by Aiphone.

Aiphone will not be responsible for any costs incurred involving on site service calls.

Aiphone Co., Ltd., Nagoya, Japan  
Aiphone Corporation, Bellevue, WA, USA

MY-CB-I (E) 1192C

COMMUNICATION SYSTEMS  
**AIPHONE**  
HOME, BUSINESS, INDUSTRY.

Printed in Japan (E)