



IDEA

User's Guide

Part No. 17500IDE02
Issue 1-0, April 1995
Printed in U.S.A. (183)

This manual has been developed by Nitsuko America. It is intended for the use of its customers and service personnel, and should be read in its entirety before attempting to install or program the system. Any comments or suggestions for improving this manual would be appreciated. Forward your remarks to:

Nitsuko America, Telecom Division
4 Forest Parkway
Shelton, CT 06484

Attention: Manager, Technical Publications

Nothing contained in this manual shall be deemed to be, and this manual does not constitute, a warranty of, or representation with respect to, any of the equipment covered. This manual is subject to change without notice and Nitsuko America has no obligation to provide any updates or corrections to this manual. Further, Nitsuko America also reserves the right, without prior notice, to make changes in equipment design or components as it deems appropriate. No representation is made that this manual is complete or accurate in all respects and Nitsuko America shall not be liable for any errors or omissions. In no event shall Nitsuko America be liable for any incidental or consequential damages in connection with the use of this manual. This document contains proprietary information that is protected by copyright. All rights are reserved. No part of this document may be photocopied or reproduced without prior written consent of Nitsuko America.

© 1995 by Nitsuko America. All Rights Reserved

Printed in U.S.A.

Chapter 1	Getting Started	1
	What Does IDEA Do ?	3
	What This Guide Includes	4
	Required Setup for Using Small IDEA	4
	How to Use IDEA: A Step-By-Step Overview	7
	Installing Small IDEA	8
	Starting Up Small IDEA	9
	About the Main Menu	11
	A Menu Tree for the Main Menu	13
	Moving Around IDEA	14
	Getting Help	16
	Exiting IDEA	17

Chapter 2	Setting Up a Link Between IDEA and NVM-Series	19
	Setting Up a COM Port	21
	Saving the COM Port Setup Data	28
	Loading the COM Port Setup Data	29
	Establishing a Communications Link	31
	Hanging Up the Modem	34
	Exiting Terminal Emulation Mode	34
	Accessing the Memory/Load/Verify (MLV) Functions ..	35
	Exiting MLV (Restarting NVM-Series)	38

Chapter 3	Working With the NVM-Series Database	39
	Using and/or Modifying the Password	41
	Saving the NVM-Series Database to the IDEA Computer	43
	Verifying the NVM-Series Backup	45
	Restoring the NVM-Series Database	46
	Archiving the NVM-Series Database to the NVM-Series Computer	48
	De-Archiving the NVM-Series Database	50
	Upgrading the NVM-Series Software	52

Getting Started

What Does IDEA Do ?	3
What This Guide Includes	4
Required Setup for Using Small IDEA	4
How to Use IDEA: A Step-By-Step Overview	7
Installing Small IDEA	8
Starting Up Small IDEA	9
About the Main Menu	11
A Menu Tree for the Main Menu	13
Moving Around IDEA	14
Getting Help	16
Exiting IDEA	17

What Does IDEA Do?

The Interactive Data/Environment Archive System (IDEA) is a software tool which lets you access an NVM-Series system from another computer and work with the NVM-Series database. There are three versions of the IDEA program: *Small*, *Medium*, and *Big*. All three versions let you do the following:

- **Backup** (copy) the NVM-Series database to the another computer.
- **Verify** that the backup was successful.
- **Restore** the NVM-Series database. This procedure copies the NVM-Series database backup to the NVM-Series computer and then activates that database.
- **Archive** (backup) the NVM-Series database to a directory on the NVM-Series computer.
- **De-Archive** an archived NVM-Series database so that it becomes the active database.
- **Upgrade** NVM-Series software

The *Medium* Version also lets you pack system files, unpack system files, and decode system history into a readable format.

The *Big* Version provides all the features of the *Medium* Version plus an Advanced Mode for working with the NVM-Series database. The Advanced Mode lets you work with individual database files.

The IDEA program can also be used as a simple ANSI terminal emulation program for any IBM-compatible PC.

What This Guide Includes

This guide describes how to use the IDEA Small Version only.

For details on using the *Medium* and *Big* Versions, call the technical support staff at Nitsuko America. To get started in using the *Medium* and *Big* versions, you can use this guide to establish a communications link between IDEA and the NVM-Series system. This guide does not, however, include instructions for packing/unpacking files, decoding history, or using the Advanced Mode.

Required Setup for Using Small Idea

You can use the IDEA program locally (at the NVM-Series installation site) or remotely via a modem. An RS-232 (serial) connection between the IDEA and NVM-Series computers is required.

You will need the following:

- IDEA installation disk
- IBM-compatible PC with a 3 1/2 " high density floppy drive and a standard DOS environment (IDEA Version 1.02 requires DOS Version 5.0 or higher). Since you must install the IDEA program on this PC, it will be referred to as the IDEA Host Computer.
- Color monitor (Optional, but recommended)
- 563Kbytes conventional RAM
- Free disk space:
 - To install *Small* IDEA and its Help files requires 391867 bytes
 - To install *Small* IDEA without Help files requires 387379 bytes
 - To back up the NVM-Series database onto the IDEA Host Computer or onto the NVM-Series Computer can require from 2-6 MB. If NVM-Series has many recordings (e.g., Welcome Messages), you will need closer to 6 MB than 2 MB.

Required Setup for Using Small Idea (cont'd)

- For a modem connection, make sure there is a modem and telephone line at both the NVM-Series and IDEA sites. If one or both of the modems are external, use a straight-through cable to connect the modem to the computer. In a 9-pin to 9-pin or 25-pin to 25-pin straight-through cable, pin 1 goes to pin 1, pin 2 goes to pin 2, etc. For a 9-pin to 25-pin straight-through cable, see below:

9-pin to 25-pin Straight-Through Cable

To Voice Mail (9-pin)	To IDEA (25-pin)
--------------------------	---------------------

2	3
3	2
4	20
6	6
7	4
8	5
1	8
5	7

- Notes:**
- (1) To use the IDEA's automated modem control, you will need to use a Hayes-compatible modem.
 - (2) If the NVM-Series cabinet has an internal modem and the modem is accessible through the Automated Attendant, make sure you know the Automated Attendant number, the codes you press to access the Modem Mailbox, and the Modem Mailbox's security code, if any.

Required Setup for using Small IDEA (cont'd)

- For a non-modem (i.e., local) connection you will need a null modem cable with the following pin-outs:

9-pin to 25-pin Null Modem Cable

To Voice Mail (9-pin)	To IDEA (25-pin)
2-----	2
3-----	3
4-----	6
6-----	20
7-----	8
8-----	
1-----	4
	5
5-----	7

9-pin to 9-pin Null Modem Cable

To Voice Mail (9-pin)	To IDEA (9-pin)
2-----	3
3-----	2
4-----	6
6-----	4
7-----	1
8-----	
1-----	7
	8
5-----	5

25-pin to 25-pin Null Modem Cable

To Voice Mail (25-pin)	To Modem (25-pin)
3-----	2
2-----	3
20-----	6
6-----	20
4-----	8
5-----	
8-----	4
	5
7-----	7

IDEA25

How To Use IDEA: A Step-By-Step Overview

1. Install IDEA on the Host Computer. See page 8.
2. Connect the IDEA Host Computer to the NVM-Series. See *Required Setup for Using Small IDEA* on page 4.
3. Start Up IDEA. See page 9.
4. Set the COM port parameters on the IDEA Host Computer. See page 21.
5. Establish a communications link between the IDEA Host Computer and the NVM-Series system. This includes setting the COM port parameters for the NVM-Series system. See page 31.
6. Access the IDEA MLV (Memory Load/Verify) functions. See page 35.
7. Access the desired feature. See Chapter 3.
8. (Optional) Save the setup parameters. See page 28.
9. Exit MLV. See page 38.
10. Exit IDEA. See page 17.

Installing Small IDEA

Before you begin the installation procedure, make sure the IDEA Host Computer has enough free disk space. For the disk space requirements, see *Required Setup for Using Small Idea* on page 4.

The installation procedure gives you the option of not installing the HELP files. Just follow the instructions on the screen.

To INSTALL Small IDEA:

1. Insert the IDEA disk into a floppy drive on the Host Computer.
2. Change to the drive containing the IDEA disk.
3. Use the following command to begin the installation:
INSTALL size [source] [destination]

For example: To install *Small IDEA* from the “A” drive to c:\idea, type the following: **INSTALL small a: c:\idea**
Then press ENTER.

The INSTALL program will automatically create the destination directory if it does not exist.

4. Follow the instructions on the screen and wait for the DOS prompt to return. Remove the disk from the drive and store it in a safe place.

Starting Up Small IDEA

To start up Small IDEA:

1. Install Small IDEA on the Host Computer (see page 8).
2. Change to the directory that contains the IDEA program.
3. Type **SM_IDEA**, press ENTER. Wait for the startup screen (shown below).

```
----- INTERACTIVE DATA/ENVIRONMENT ARCHIVE SYSTEM -----  
IDEA Memory Load and Verify                               Copyright (c) 1992 CTL Inc.  
Version 1.R2                                             All rights reserved  
  
Welcome to the IDEA System, the remote maintenance utility for the  
CTL Voice Mail system (CVM).  
  
Using standard serial asynchronous channels, the IDEA System provides  
its users with the ability to not only communicate remotely with any  
CVM system, but also to perform Save, Restore, and Verify functions on  
the resident data of the CVM.  
  
The IDEA System's main menu HELP selection offers on-screen guidance  
so that even novice users may successfully navigate among the many  
features of the program.  
  
Thank you for choosing a CTL solution for your voice mail requirements.  
  
      << Press any key when ready to continue >>
```

Setup Data: DEFAULT

Starting Up Small IDEA (cont'd)

4. Press any key. You see the Main Menu (shown below).



For more information on the Main Menu, see *About the Main Menu* and *Main Menu Tree* in this chapter.

About the Main Menu

The items on the Main Menu are briefly described below. A menu tree is shown on the next page. For instructions on using the IDEA menus and screens, see *Moving Around IDEA* later in this chapter.

- **Setup** lets you set the parameters for the COM ports on the IDEA Host Computer. *Setup* also lets you save the parameters so you can load them at a later date. IDEA shows which setup parameters have been loaded in the *Setup Data* field at the bottom right-hand corner of the Main Menu screen.

The related topics in Chapter 2 are as follows:

Setting Up a COM Port

Saving the Setup Data

Loading the Setup Data

- **MLV** (Memory Load/Verify) gives you access to the following features: *Backup*, *Restore*, *Verify*, *Archive*, *De-Archive*, *Upgrade*, and *Modify Password*. This guide only describes the *Easy Mode MLV*, which includes the features listed above. The additional features provided by *Advanced Mode MLV* are available only in BIG_IDEA.

The related topics in Chapter 2 are as follows:

Accessing the MLV Functions

Exiting MLV

About the Main Menu (cont'd)

The related topics in Chapter 3 are as follows:

Saving the NVM-Series Database to the IDEA Computer

Verifying the NVM-Series Backup

Restoring the NVM-Series Database

Archiving the NVM-Series Database to the NVM-Series Computer

De-Archiving the NVM-Series Database

Upgrading the NVM-Series Software

Using and/or Modifying the Password

- **Connect** establishes a serial communications link between the IDEA Host Computer and the NVM-Series system. In fact, *Connect* can be used to establish a serial communications link between the IDEA Host Computer and any other RS-232 device.

The related topics in Chapter 2 are as follows:

Establishing a Communications Link

Hanging Up the Modem

Exiting Terminal Emulation Mode

- **Help** gives you a Help screen for each item on the Main Menu.

The related topic in Chapter 1 is as follows:

Getting Help

- **Quit** lets you exit IDEA.

The related topic in Chapter 1 is as follows:

Exiting IDEA

A Menu Tree for the Main Menu

The IDEA Main Menu is shown below. For more information on the items on the Main Menu, see *About the Main Menu* in this chapter or see the chapter reference in the Main Menu title boxes.

Menu Tree for IDEA Main Menu

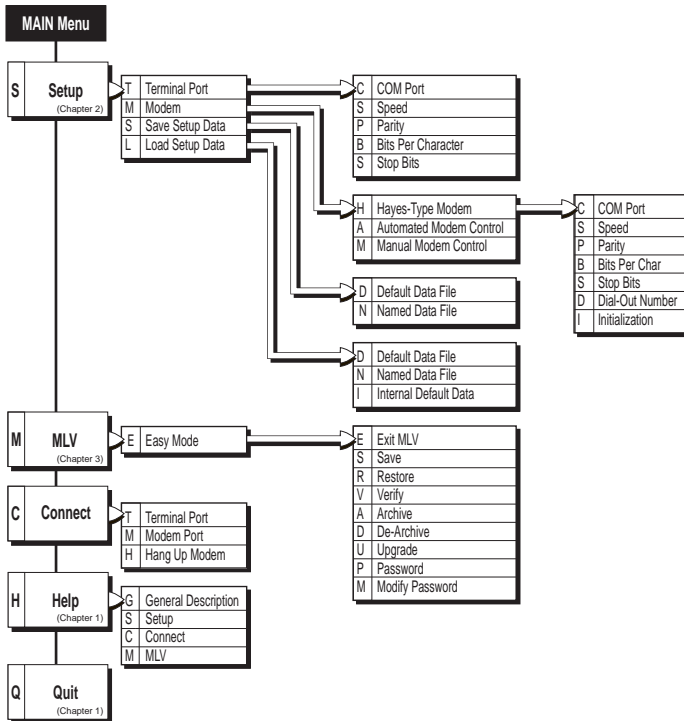

Moving Around IDEA

The chart below shows you how to move around the IDEA screens, which include menus, list boxes, and dialog boxes. If a menu item has an arrow next to it, this means the item has a sub-menu.

To:	Do this:
Highlight a menu item	Use the arrow keys. OR Press the highlighted letter in the item's name
Select a menu item	Highlight item (see above), press ENTER OR Press ALT+ highlighted letter in item's name
Exit any menu except Main Menu	Press ESC OR Press LEFT ARROW key to exit the screen and go to the previous item in the previous menu. Press RIGHT ARROW to exit the screen and go to next menu.
Exit Main Menu	Select <i>Quit</i>
Select an item in a list box	Highlight item using arrow keys, press ENTER

Moving Around IDEA (cont'd)

To:	Do this:
Exit a list or dialog box	Press ESC
Enter data	Type data, press ENTER
Delete a character	Press DEL to delete character on cursor or press BACKSPACE to delete character before cursor
Move cursor left/right in data string	Press LEFT/RIGHT ARROW
Move cursor to end/beginning of data string	Press END/HOME
Toggle insert/overwrite mode for data entry	Press INSERT

Getting Help

IDEA provides help screens, but only if you installed them during the installation procedure. There is a Help screen for General Description and another for each of the three items on the Main Menu: *Setup*, *MLV* and *Connect*.

To get Help:

1. From the Main Menu: Select *Help*. You see the menu below.

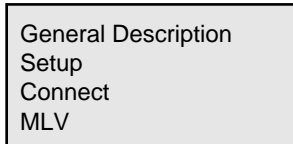

2. Select the desired item.
3. When done, press any key to return to the Main Menu.

Exiting IDEA

The IDEA exit procedure closes all open COM ports and files and returns you to DOS on the IDEA Host Computer.

If you use the IDEA exit procedure while in the MLV mode, the NVM-Series system will be restarted.

To exit IDEA:

1. From the Main Menu: Select *Quit*.
2. Type Y, press ENTER to exit.
OR
Type N, press ENTER to go back to the IDEA Main Menu.

Setting Up a Link Between IDEA and NVM-Series

Setting Up a COM Port	21
Saving the COM Port Setup Data	28
Loading the COM Port Setup Data	29
Establishing a Communications Link	31
Hanging Up the Modem	34
Exiting Terminal Emulation Mode	34
Accessing the Memory/Load/Verify (MLV) Functions ..	35
Exiting MLV (Restarting NVM-Series)	38

Setting Up a COM Port

Once you know which COM port you will be using on the IDEA Host Computer, you must use the IDEA program to set the communications parameters for that port. The IDEA program has two COM port designations: TERMINAL and MODEM. Use the chart below to figure out which designation you should use when you go to set the COM port parameters. If necessary, you can have one connection going on the TERMINAL port and another on the MODEM port.

For this type of connection:	Use this designation to set the parameters:
Local (Direct)	TERMINAL
Modem (any type), where you manually enter the modem commands	TERMINAL
Modem (Hayes-type), where IDEA dials the number and sends the initialization string (this will be referred to as <i>Automated Modem Control</i>)	MODEM

To save setup time in the future, you may save the current IDEA COM port parameters and load them when you need them. See *Saving Setup Data* and *Loading Setup Data* in this chapter.

Setting Up a COM Port (cont'd)

To set up a COM port:

1. Start up IDEA (see Chapter 1). Get to the Main Menu.
2. Check the CURRENT COMMUNICATION PORT SETTINGS chart at the bottom of the screen. See if the displayed settings meet your needs. Keep in mind that they must match the parameters of the NVM-Series COM port you plan on using.

If the chart is not visible, select *Setup* on the Main Menu. The *Setup* menu and the CURRENT COMMUNICATION PORT SETTINGS chart will appear. Press ESC to exit the menu.

3. If the settings are correct, go to the topic, *Establishing a Communications Link* in this chapter. If some or all of the settings need to be changed, go to Step 4 below.
4. From the Main Menu: Select *Setup*. You see the menu below:

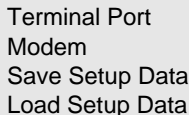

```
Terminal Port
Modem
Save Setup Data
Load Setup Data
```

Setting Up a COM Port (cont'd)

5. Select a port designation:
 - To set the TERMINAL port: Select *Terminal Port*.
 - To set the MODEM port: Select *Modem*, then *Hayes-Type Modem*.

You see the menu below:

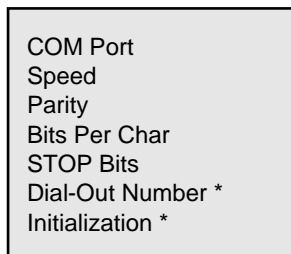

* Only appears if you selected *Modem*, then *Hayes-Type Modem*.

6. Select an item that needs to be changed (for an explanation of the items, see *About the Options* on the next page). You will see a list of choices. Select the appropriate choice. Your choices will show up in the CURRENT COMMUNICATION PORT SETTINGS chart.
7. When done, press ESC until you return to the Main Menu.

Setting Up a COM Port (cont'd)

About the Options

► COM Port

This is the IDEA COM port that will be used for the serial link.

DEFAULT: COM 1
ENTRIES: COM1-COM 5
NOTES: N/A

► Speed

This option lets you set the speed (baud rate) for the IDEA COM port.

DEFAULT: 9600
ENTRIES: 110 baud
150 baud
300 baud
600 baud
1200 baud
2400 baud
4800 baud
9600 baud
19200 baud
38400 baud (not recommended)

NOTES: The speed of the selected IDEA COM port must match the speed of the connected NVM-Series COM port

Setting Up a COM Port (cont'd)

About the Options

► **Parity**

This option lets you set the parity for the IDEA COM port.

DEFAULT: None (No parity)

ENTRIES: None
Odd
Even
Mark
Space

NOTES: The parity for the selected IDEA COM port must match the parity of the connected NVM-Series COM port.

► **Bits Per Char**

This option lets you set the number of data bits per character for the IDEA COM port.

DEFAULT 8 bits per character

ENTRIES: 5-8 bits

NOTES The Bits Per Char (BPC) for the selected IDEA COM port must match the BPC of the NVM-Series COM port.

Setting Up a COM Port (cont'd)

About the Options

► STOP Bits

This option lets you set the number of stop bits for the IDEA COM port.

DEFAULT: 1

ENTRIES: 1 or 2

NOTES: The number of stop bits for the selected IDEA COM port must match the number of stop bits of the connected NVM-Series COM port.

► Dial-Out Number (For MODEM port only)

This option lets you enter the number that IDEA must dial in order to connect to the NVM-Series modem.

DEFAULT: No number. Dial mode is DTMF digits.

ENTRIES: Up to 32 digits including the following special characters:

, = Pause

T = Dial out number as DTMF digits (Enter the “T” before the digits that should be dialed as DTMF digits).

P = Dial out number as rotary-dial pulses. (Enter the “P” before the digits that should be dialed as pulse digits).

NOTES: If calling an NVM-Series internal modem through the Automated Attendant, enter the Automated Attendant number, 6 pauses, the access codes for the Modem Mailbox, 6 pauses, then the Modem Mailbox security code. (You may have to adjust the number of pauses.)

Setting Up a COM Port (cont'd)

About the Options

► Initialization (For MODEM Port Only)

This option lets you enter the initialization string that IDEA should send to the modem connected to the Host Computer.

DEFAULT: AT&FS0=0S2=43E0Q0V1X4&C1&D1&W

The codes mean the following:

&F Restore factory defaults

S0=0 Do not auto-answer

S2=43 ASCII escape character (+)

E0 Turns off echoing of commands to modem

Q0 Enables result codes to be returned from modem

V1 Tells modem to use the long form for result codes

X4 Tells modem to send extended result codes (NO DIALTONE, BUSY, CONNECT)

&C1 Serial port carrier detect signal (DCD) follows that of the modem

&D1 Enter the command mode upon detecting an ON-to-OFF transition of the Data Terminal Ready signal (DTR)

&W Write the modem configuration back to the modem's memory

ENTRIES: Up to 32 characters

NOTES: N/A

Saving the COM Port Setup Data

You can save the IDEA COM port settings and load them at a later date. This way, you do not have to configure the COM ports every time you use IDEA. The save procedure also saves the current passwords.

The COM port setup data may be saved as one of the following types of files:

■ **Default Data File**

IDEA assigns the name “IDEA.DAT” to this file and automatically loads it upon startup.

■ **Named Data File**

You can assign a name to the file and load it whenever you need it.

To load the saved COM port settings, use the *Load Setup Data* command (see page 29).

To save the setup data:

1. Start up IDEA (see Chapter 1). Get to the Main Menu.
2. Select *Setup*, then *Save Setup Data*. You see the menu below:

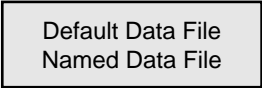

Default Data File
Named Data File

3. Select the desired file.
 - If you select *Default Data File*, IDEA saves the data and returns you to the Main Menu.
 - If you select *Named Data File*, IDEA asks you to enter a name. Do not use the name “IDEA.DAT.” Enter a name, press ENTER. IDEA returns you to the Main Menu.

Loading the COM Port Setup Data

You can load any COM port settings that you have saved using the *Save Setup Data* command (see *Saving Setup Data* in this chapter.) More specifically, you can load COM port setup data from:

■ **Default Data File**

This is the “IDEA.DAT” file you saved. IDEA automatically loads this file upon startup. You can reload it any anytime.

■ **Named Data File**

This is the setup data file you named.

In addition, you can load this COM port setup data file:

■ **Internal Default Data**

The values in this setup data file are constant and are as follows:

TERMINAL Port:

COM1
9600 baud
8 bits per character
1 STOP bit
No parity

MODEM Port:

COM2
1200 baud
8 bits per character
1 STOP bit
No parity

Level 1 Password: CTLINC

Level 2 Password: MASTER

Loading the COM Port Setup Data (cont'd)

To load the setup data:

1. Start up IDEA (see Chapter 1). Get to the Main Menu.
2. Select *Setup*, then *Load Setup Data*. You see the menu below:

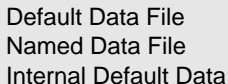

```
Default Data File
Named Data File
Internal Default Data
```

3. Select the desired file.
 - If you select *Default Data File* or *Internal Default Data*, IDEA loads the file and returns you to the Main Menu.
 - If you select *Named Data File*, IDEA shows you a list of all valid choices. Select a file. If you select the choice *some other file*, you will have to enter a filename, then press enter. IDEA then returns you to the Main Menu. (If the selected file is not a valid IDEA setup data file, IDEA displays an error message.)

Establishing a Communications Link

After the COM port parameters have been set up and the physical connections have been made, you can establish a communications link between IDEA and NVM-Series (or any other RS-232 device). If necessary, you can connect to one device on the TERMINAL port (directly or via a modem) and another on the MODEM port.

To establish a link between IDEA and NVM-Series (or an RS-232 device):

1. Set the parameters for the selected COM port on the NVM-Series or RS-232 device. In addition to setting the NVM-Series baud rate, parity, etc., enable XON/XOFF for the COM port. To set the NVM-Series COM port parameters, use the NVM-Series *Maintenance Menu*. Select *Set Up Serial Communication Ports*.
2. Set the parameters for the selected IDEA COM port. Make sure they match the NVM-Series COM port parameters. For details, see *Setting up a COM Port* in this chapter.
3. **For a local link:** Connect the IDEA COM port to the NVM-Series COM port using a null modem cable. For pin-outs, see *Required Setup for Small IDEA* in Chapter 1.

OR

For a modem link: If using external modems, connect them to the NVM-Series and IDEA computers using a straight-through cable. Otherwise, go to step 4b or 4c below. For more information, see *Required Setup for Small IDEA* in Chapter 1.

Establishing a Communications Link (cont'd)

4. Establish a link using a, b, or c below. Once you establish a link on the TERMINAL port, you can press Alt-X to exit terminal emulation mode, then establish a link on the MODEM port (or vice versa). To alternate between the links, press Alt + X.
 - a. **To set up a local (direct) link on the TERMINAL port:**
 - From the IDEA Main Menu: Select *Connect*.
 - Select *Terminal Port*. The Main Menu disappears.
 - Press ENTER to verify that the NVM-Series system is responding to the IDEA keyboard. A menu prompt should appear. To now use the IDEA MLV functions, see *Accessing the MLV Functions* later in this chapter.

OR

Press ENTER to verify that the RS-232 device is responding to the IDEA keyboard.
 - b. **To set up a modem connection using the TERMINAL port (where you will be manually entering the modem commands):**
 - From the IDEA Main Menu: Select *Setup*.
 - Select *Modem*, then *Manual Modem Control*. Make sure it is highlighted.
 - Press ESC twice to get back to the Main Menu.
 - Select *Connect*, then *Terminal Port*. The Main Menu disappears. Enter the modem commands and/or numbers. Wait for a Connect message (if appropriate).

Establishing a Communications Link (cont'd)

4. b. (cont'd)

- Press ENTER to verify that the NVM-Series system is responding to the IDEA keyboard. A menu prompt should appear. To now use the IDEA MLV functions, see *Accessing the MLV Functions* later in this chapter.

OR

Press ENTER to verify that the RS-232 device is responding to the IDEA keyboard.

c. To set up a modem link using the MODEM port (where IDEA will be sending the modem commands):

- From the IDEA Main Menu: Select *Setup*.
- Select *Modem*.
- Select *Automated Modem Control*. Make sure it is highlighted.
- Press ESC twice to get to the Main Menu.
- Select *Connect*.
- Select *Modem Port*. The Main Menu disappears and IDEA sends the initialization string and telephone number. Wait for a Connect message (if appropriate).
- Press ENTER to verify that the NVM-Series system is responding to the IDEA keyboard. A menu prompt should appear. To now use the IDEA MLV functions, see *Accessing the MLV Functions* later in this chapter.

OR

Press ENTER to verify that the RS-232 device is responding to the IDEA keyboard.

Hanging up the Modem

To hang up the modem when controlling it manually through the TERMINAL port:

- While connected to the modem, type its hang-up command (e.g., the hang-up command for a Hayes-type modem is ATH).

To hang up the modem when using IDEA's Automated Modem control on the MODEM port:

- FROM the IDEA Main Menu: Select *Connect*, then *Hang Up Modem*.

OR

From the IDEA Main Menu: Select *Quit*, then type Y, press ENTER

Exiting Terminal Emulation Mode

When IDEA is in terminal emulation mode, you will see the phrase Terminal Emulation at the bottom right-hand corner of the screen. When you exit terminal emulation mode, you return to the IDEA Main Menu.

To exit terminal emulation mode:

- ALT+ X. You return to the IDEA Main Menu.

Accessing the Memory Load/Verify (MLV) Functions

After you establish a communications link between IDEA and the NVM-Series system, you can access the MLV functions. The MLV functions let you do the following:

- Save (Backup), Restore, and/or Verify the NVM-Series database
- Archive and/or De-Archive the NVM-Series database
- Upgrade the NVM-Series software
- Modify the IDEA password

Accessing MLV shuts down the NVM-Series system. If NVM-Series does not receive an MLV command within a 10-minute interval, NVM-Series will automatically cancel the MLV activities and restart.

To access the MLV functions:

1. Establish a communications link. See *Establishing a Communications Link* earlier in this chapter.
2. From the NVM-Series MAIN Menu: Access the *Backup/Restore* function of the NVM-Series system as follows:
 - With the NVM-Series “MAIN MENU ->” prompt on the screen: Press MA, ENTER, then the NVM-Series password, if requested. This brings you to the MAINTENANCE Menu.
 - From the MAINTENANCE Menu: Press BR (Backup and Restore), then press ENTER.
You see the message:
**Remote MLV will suspend all activity of the Voice Mail System.
Do you wish to continue [Y/N]**

Accessing the Memory Load/Verify (MLV) Functions (cont'd)

- Press Y. This suspends (but does not shut down) the NVM-Series system. If any NVM-Series ports are busy at this point, NVM-Series will ask you if you want to wait (W) until all ports are idle or abort (A), which returns you to the MAINTENANCE Menu. If you press W, NVM-Series will wait 15 seconds then check again for port activity. When all ports are idle, NVM-Series system activity will be suspended and you will see the IDEA Main Menu screen.

OR

Press N to return to the NVM-Series MAINTENANCE Menu.

IMPORTANT: To access an MLV command (e.g., Save, Restore, etc.), you must complete Step 3 (on the next page) within 60 seconds of completing Step 2. Otherwise, you will have to re-enter the BR command.

Accessing the Memory Load/Verify (MLV) Functions (cont'd)

3. Select the desired MLV Function as follows:
 - Select *MLV*, then *Easy Mode*. You see the menu below. The highlight is on Password.

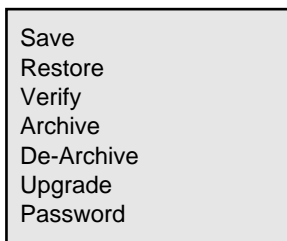

- Press ENTER.
- Type the Level 1 or Level 2 password, then press ENTER. (This shuts down NVM-Series.)
 - **Default Level 1 password is CTLINC.**
It provides access to the following MLV functions:
Save, Verify, Archive.
 - **Default Level 2 password is MASTER.**
It provides access to all the MLV functions (on the above menu).

See also *Modifying the Password* in Chapter 3.

Accessing the Memory Load/Verify (MLV) Functions (cont'd)

4. Wait for the modified MLV Menu (shown below):



5. Select the desired command. For details on the commands, see Chapter 3.

Exiting MLV (Restarting NVM-Series)

Exiting the MLV mode restarts NVM-Series.

To exit MLV mode:

- Select *Exit MLV*. You return to the IDEA Main Menu.

Working With the NVM-Series Database

Using and/or Modifying the Password	41
Saving the NVM-Series Database to the IDEA Computer	43
Verifying the NVM-Series Backup	45
Restoring the NVM-Series Database	46
Archiving the NVM-Series Database to the NVM-Series Computer	48
De-Archiving the NVM-Series Database	50
Upgrading the NVM-Series Software	52

Using and/or Modifying the Password

IDEA provides two password levels to protect the MLV functions:

- *Level One Password* lets the user access only the following MLV functions: Save, Verify, Archive, and Modify Password. The default *Level One Password* is CTLINC.
- *Level Two Password* lets the user access all the MLV functions: Save, Verify, Restore, Archive, De-Archive, Upgrade, and Modify Password. The default *Level Two Password* is MASTER.

After you use a password to access the MLV functions, you can then modify the password. To save a modified password, see *Saving the Setup Data* in Chapter 2.

If you modify the passwords, then forget what they are, you can use the *Load Setup Data* command to load the *Internal Default Data* file. This file loads the default Level One and Level Two passwords (CTLINC and MASTER respectively). For loading instructions, see *Loading the Setup Data* in Chapter 2.

Using and/or Modifying the Password (cont'd)

To modify a password:

1. Access the *MLV Easy Mode* Menu. See *Accessing the MLV Function* in Chapter 2.
2. Select *Modify Password*.
3. Enter the password you want to change, press ENTER
4. Enter the new password, press ENTER.
5. Re-enter the new password for verification, press ENTER
If you do not re-enter it correctly, IDEA will not change the password - go back to step 2.

Saving the NVM-Series Database to the Idea Computer

The *Easy Mode Save* command lets you save (backup) the NVM-Series database and recordings to the IDEA Host Computer. This way, you will have an intact database on hand should the NVM-Series database become damaged in some way. To “fix” the damaged database, you use the *Easy Mode Restore* command. This command replaces the damaged database with the backed up database. For details, see *Restoring the Database* in this chapter.

Before you use the *Easy Mode Save* command, you should make sure that the IDEA Host Computer has enough free disk space to hold the backup. You will typically need about 2-6 MB depending on the amount of recordings in the NVM-Series system. If the NVM-Series system has many Welcome Messages, Instruction Menus, Paging Messages, etc., make sure you have closer to 6 MB of free disk space. If you think the database is close to 6 MB, you may not wish to back it up via a modem if the modem will be using a baud rate of 2400 or less. It would take a very long time and you may not want to tie up a telephone line for that long. Instead, you may want to backup the NVM-Series database using the *Archive* command. See *Archiving the Database* in this chapter.

Note: The *Easy Mode Save* does not backup the personal messages in the Guest, Subscriber, Network, and/or Message Center Mailboxes.

Saving the NVM-Series Database to the Idea Computer (cont'd)

To save the NVM-Series database to the IDEA computer:

1. Make sure IDEA computer has enough disk space to hold the entire backup (see the second paragraph on the previous page).
2. Access the *MLV Easy Mode Menu*. See *Accessing the MLV Functions* in Chapter 2.
3. Select *Save*.
4. Type Y, press ENTER to start the *Save*. Then go to step 5.
OR
Type N, press ENTER to go back to the MLV Menu.
5. Type the name of the directory that will hold the saved files, press ENTER. (If the directory does not yet exist, IDEA will create it for you).

The **ACTIVITY LOG** box shows which files are being saved. The bottom of the screen shows the elapsed time and the different options you have while the *Save* procedure is taking place.

6. Wait for the message, **Operation completed** in the bottom right-hand corner of the screen. Press any key to continue.

Verifying the NVM-Series Backup

The *Easy Mode Verify* command checks to see if the data in the NVM-Series *Save* (backup) files on the IDEA Host Computer match the data in the corresponding source files on the NVM-Series computer.

The *Verify* procedure will work correctly only if you execute it before the data on the NVM-Series computer changes (i.e., before the NVM-Series system restarts). Therefore, it is a good idea to use *Verify* immediately after you use the *Save* procedure.

To verify the NVM-Series database backup:

1. Access the MLV Easy Mode Menu. See *Accessing the MLV Functions* in Chapter 2.
2. Select *Verify*.
3. Type Y, press ENTER to start the *Verify*. Then go to step 4.
OR
Type N, press ENTER to go back to the MLV Menu.
4. Type the name of the directory that holds the files to be verified, press ENTER

The ACTIVITY LOG box shows which files are being verified. The bottom of the screen shows the elapsed time and the different options you have while the *Verify* procedure is taking place.

5. Wait for the message, **Operation completed** in the bottom right-hand corner of the screen. Press any key to continue.

Restoring the NVM-Series Database

The *Easy Mode Restore* command lets you replace the current NVM-Series database with an NVM-Series database that was backed up via the *Easy Mode Save* command. The *Easy Mode Restore* command requires a Level Two password.

CAUTION

When you do a Restore, all current personal messages in Subscriber, Message Center and Guest Mailboxes will be erased.

To restore the NVM-Series database:

1. Make sure NVM-Series Computer has at least 2 % disk space available. To see how much is available, use the NVM-Series *Message Usage* Report.

If the database backup is large (closer to 6 MB than 2 MB), you may not want to restore it via a modem if you will be using 2400 baud or less. This is because the telephone line will be tied up for a long time and there is a pretty good chance of losing modem carrier at some point during a prolonged telephone call.

2. Access the MLV Easy Mode Menu. See *Accessing the MLV Functions* in Chapter 2.
3. Select *Restore*.
4. Type Y, press ENTER to start the Restore. Then go to step 5.
OR
Type N, press ENTER to go back to the MLV Menu.

Restoring the NVM-Series Database (cont'd)

5. Type the name of the directory that holds the saved files, press ENTER.

The ACTIVITY LOG box shows which files are being restored. The bottom of the screen shows the elapsed time and the different options you have while the *Restore* procedure is taking place.

6. Wait for the message, **Operation completed** in the bottom right-hand corner of the screen. Press any key to continue.

Archiving the NVM-Series Database to the NVM-Series Computer

The *Easy Mode Archive* command lets you backup the NVM-Series database and recordings to a directory on the NVM-Series hard disk. This provides a means for quick recovery in the event of database damage or misprogramming. To “fix” a damaged database, you would simply use the *Easy Mode De-Archive* command to replace the damaged database with the backed up database. For details, see *De-Archiving the Database* in this chapter. The *Easy Mode Archive* feature is accessible using a Level One or Level Two password.

Note: The *Easy Mode Archive* command backs up all recordings except personal messages left in Guest, Subscriber, and/or Message Center, Network Mailboxes.

1. Make sure NVM-Series Computer has at least 2 % disk space available. To see how much is available, use the NVM-Series *Message Usage* Report.
2. Access the MLV Easy Mode Menu. See *Accessing the MLV Functions* in Chapter 2.
3. Select *Archive*.
4. Type Y, ENTER to start the *Archive*. Then go to step 5.
OR
Type N, ENTER to go back to the MLV Menu.

Archiving the NVM-Series Database to the NVM-Series Computer (cont'd)

4. (cont'd)

The ACTIVITY LOG box shows which files are being archived. The bottom of the screen shows the elapsed time and the different options you have while the *Archive* procedure is taking place.

- 5.** Wait for the message, **Operation completed** in the bottom right-hand corner of the screen. Press any key to continue.

De-Archiving the NVM-Series Database

The *Easy Mode De-Archive* command lets you replace the current NVM-Series database with an NVM-Series database that was backed up using the IDEA *Easy Mode Archive* command or the NVM-Series *Archive* (ARC) command. The *Easy Mode De-Archive* command requires Level Two password.

CAUTION

When you do a De-Archive, all personal messages in Subscriber, Message Center, Network and Guest Mailboxes will be erased.

To De-Archive the NVM-Series database:

1. Make sure NVM-Series Computer has at least 2 % disk space available. To see how much is available, use the NVM-Series *Message Usage* Report.
2. Access the MLV Easy Mode Menu. See *Accessing the MLV Functions* in Chapter 2.
3. Select *De-Archive*.
4. Type Y, press ENTER to start the *De-Archive*. Then go to step 5.
OR
Type N, press ENTER to go back to the MLV Menu.

De-Archiving the NVM-Series Database (cont'd)

4. (cont'd)

The ACTIVITY LOG box shows which files are being de-archived. The bottom of the screen shows the elapsed time and the different options you have while the De-Archive procedure is taking place.

- 5.** Wait for the message, **Operation completed** in the bottom right-hand corner of the screen. Press any key to continue.

Upgrading the NVM-Series Software

The *Easy Mode Upgrade* command lets you download a compressed file to NVM-Series. This command is typically used to upgrade the NVM-Series software, where the NVM-Series manufacturer provides the software upgrade information in compressed files on floppy disks. The *Easy Mode Upgrade* command requires a Level Two password.

Note: Instead of downloading one compressed file, you can download a file which is composed of a list of compressed files.

To upgrade the NVM-Series database:

1. Load the upgrade software onto the IDEA Host Computer using the instructions provided with the upgrade disks.
2. Make sure NVM-Series computer has at least 2 % disk space available. To see how much is available, use the NVM-Series *Message Usage* Report.

If the amount of data being downloaded is large (closer to 6 MB than 2 MB), you may not want to download it via a modem if you will be using 2400 baud or less. This is because the telephone line will be tied up for a long time and there is a pretty good likelihood of losing modem carrier at some point during a prolonged telephone call.

3. Access the MLV Easy Mode Menu. See *Accessing the MLV Functions* in Chapter 2.

Upgrading the NVM-Series Software (cont'd)

4. Select *Upgrade*.
5. Type the name of a compressed file (entering the full path), then press ENTER. If you are entering a filename that represents a list of files, enter the “at” sign (@) before the filename.

The ACTIVITY LOG box shows which files are being upgraded. The bottom of the screen shows the elapsed time and the different options you have while the *Upgrade* procedure is taking place.

6. Wait for the message, **Operation completed** in the bottom right-hand corner of the screen. Press any key to continue.



**Nitsuko America, Telecom Division
4 Forest Parkway
Shelton, CT 06484**

TEL: 203-926-5400

FAX: 203-929-0535

Other Important Telephone Numbers

Sales:	203-926-5450
Customer Service:	203-926-5444
Customer Service FAX:	203-926-5454
Technical Service:	203-925-8801
Discontinued Product Service:	900-990-2541
Technical Training:	203-926-5430
Emergency Technical Service (After hours)	203-929-7920
(Excludes discontinued products)	