

# Panasonic

## 16-Channel VoIP Gateway Card Getting Started

---

Model No. **KX-TDA0490**



Thank you for purchasing a Panasonic 16-Channel VoIP Gateway Card.  
Please read this manual carefully before using this product and save this manual for future use.

---

# Table of Contents

<b>1</b>	<b>Overview</b>	<b>5</b>
1.1	Example Network Diagram	6
1.2	Network Devices and Numbering Plan	7
1.2.1	Network Application	8
1.2.2	Numbering Plan Example	9
1.2.3	Numbering Plan Summary	12
<b>2</b>	<b>Installing in the PBX</b>	<b>13</b>
2.1	Installation	14
2.1.1	Names and Locations	14
2.1.2	Installing the VoIP Gateway Card in the PBX	15
2.2	Cable Connection	17
2.2.1	Attaching a Ferrite Core to the Cable	17
2.2.2	Connection for Programming	18
2.2.3	Connection to the LAN	19
<b>3</b>	<b>Programming the VoIP Gateway Card</b>	<b>21</b>
3.1	Preparations	22
3.1.1	Preparing the PC	22
3.2	Programming the VoIP Gateway Card in the Los Angeles Office	25
3.2.1	Starting the IP-GW16 Maintenance Utility	25
3.2.2	Changing the Status of the VoIP Gateway Card	27
3.2.3	Assigning the IP Address	28
3.2.4	Assigning the Hunt Pattern	29
3.2.5	Programming the Address Translation Table	31
3.2.6	Downloading the Address Translation Table from the VoIP Gateway Card	34
3.2.7	Rebooting the VoIP Gateway Card	35
3.2.8	Confirming the IP Address Assignment	36
3.3	Programming the VoIP Gateway Card in the Chicago Office	37
<b>4</b>	<b>Programming the PBX</b>	<b>41</b>
4.1	Programming the PBX in the Los Angeles Office	42
<b>A</b>	<b>Guidance for VoIP Installation</b>	<b>45</b>
A1	VoIP Requirements	46
A1.1	Bandwidth Assessment	46
A1.2	Network Configuration	48
A1.3	Network Devices	52
A1.4	QoS (Quality of Service)	53
A2	VoIP Requirements Checklist	54
<b>B</b>	<b>Alternative Numbering Plan Example</b>	<b>57</b>
B1	Extension Number Method	58
B1.1	Example Network	58
B1.2	Numbering Plan Example	59
B2	Programming for the Extension Number Method	61
B2.1	Programming the VoIP Gateway Card	61
B2.2	Programming the PBX in the Los Angeles Office	63

---

<b>C</b>	<b>Initialization of the VoIP Gateway Card .....</b>	<b>65</b>
C1	<b>Initializing the VoIP Gateway Card .....</b>	<b>66</b>
<b>D</b>	<b>Using the KX-TDA0490 and KX-TDA0480 in One Network .....</b>	<b>67</b>
D1	<b>Considerations in Installation.....</b>	<b>68</b>



---

# Section 1

## Overview

*Panasonic PBX with VoIP Gateway Card will allow organizations to route both voice and fax communications over digital data networks.*

*The VoIP Gateway Card, designed to be easily integrated into existing IP networks, seamlessly bridges Public Switched Telephone Network (PSTN) and analog telephones with digital data networks without interrupting pre-existing data communications. Because communications do not take place over conventional telephone networks, the high cost of long distance communications is virtually eliminated.*

# 1.1 Example Network Diagram

The following diagram illustrates a simple VoIP network connecting PBXs at 2 locations. The VoIP Gateway Card converts outgoing voice or fax signals into IP packets for transmission. On the incoming side, it reverses this process and translates the packets back into appropriate voice or fax signals.

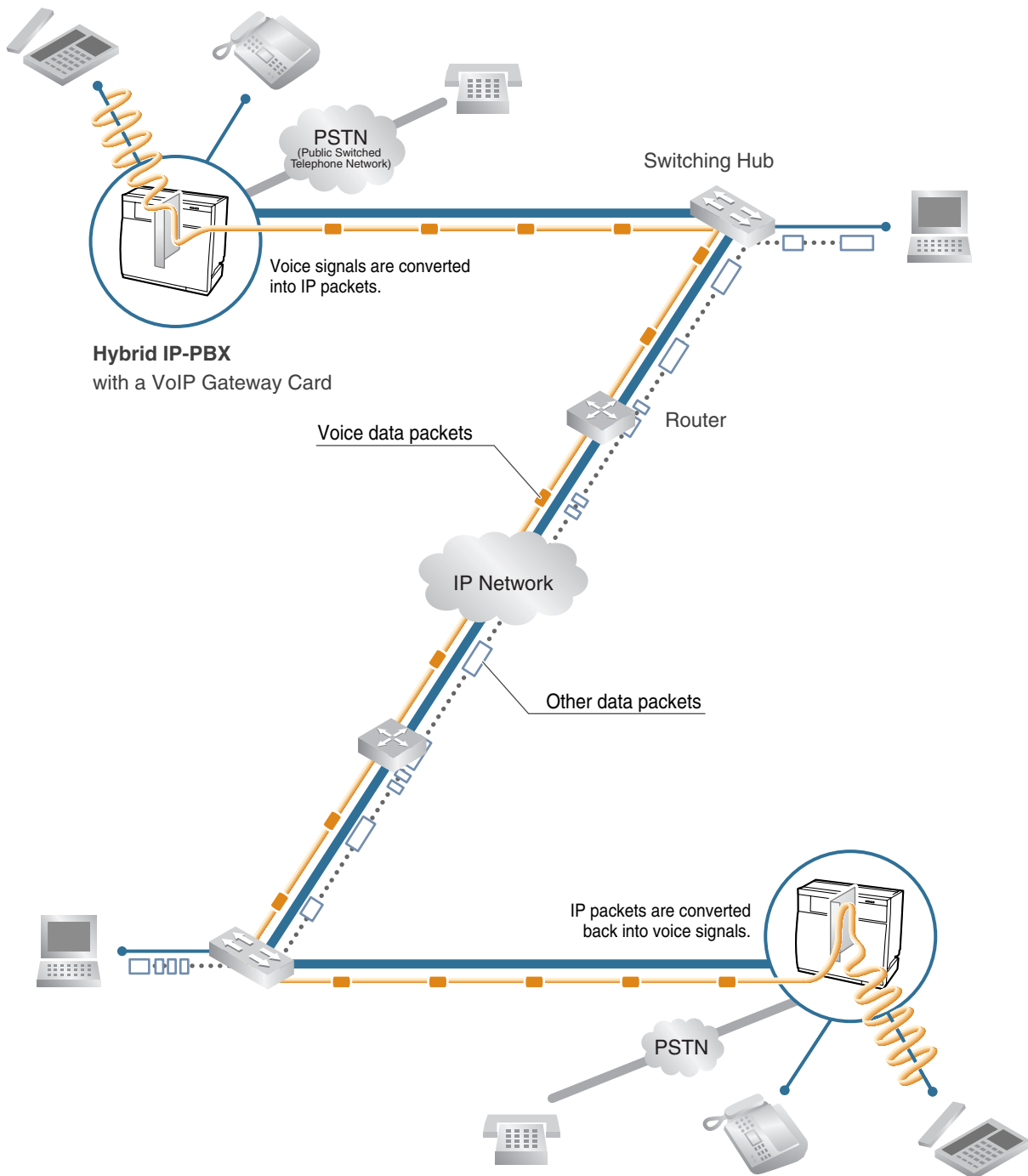

# 1.2 Network Devices and Numbering Plan

You will need to have network configuration information available to install VoIP Gateway Cards. Referring to this example diagram, consult your network administrator to obtain necessary information to configure your own VoIP network.

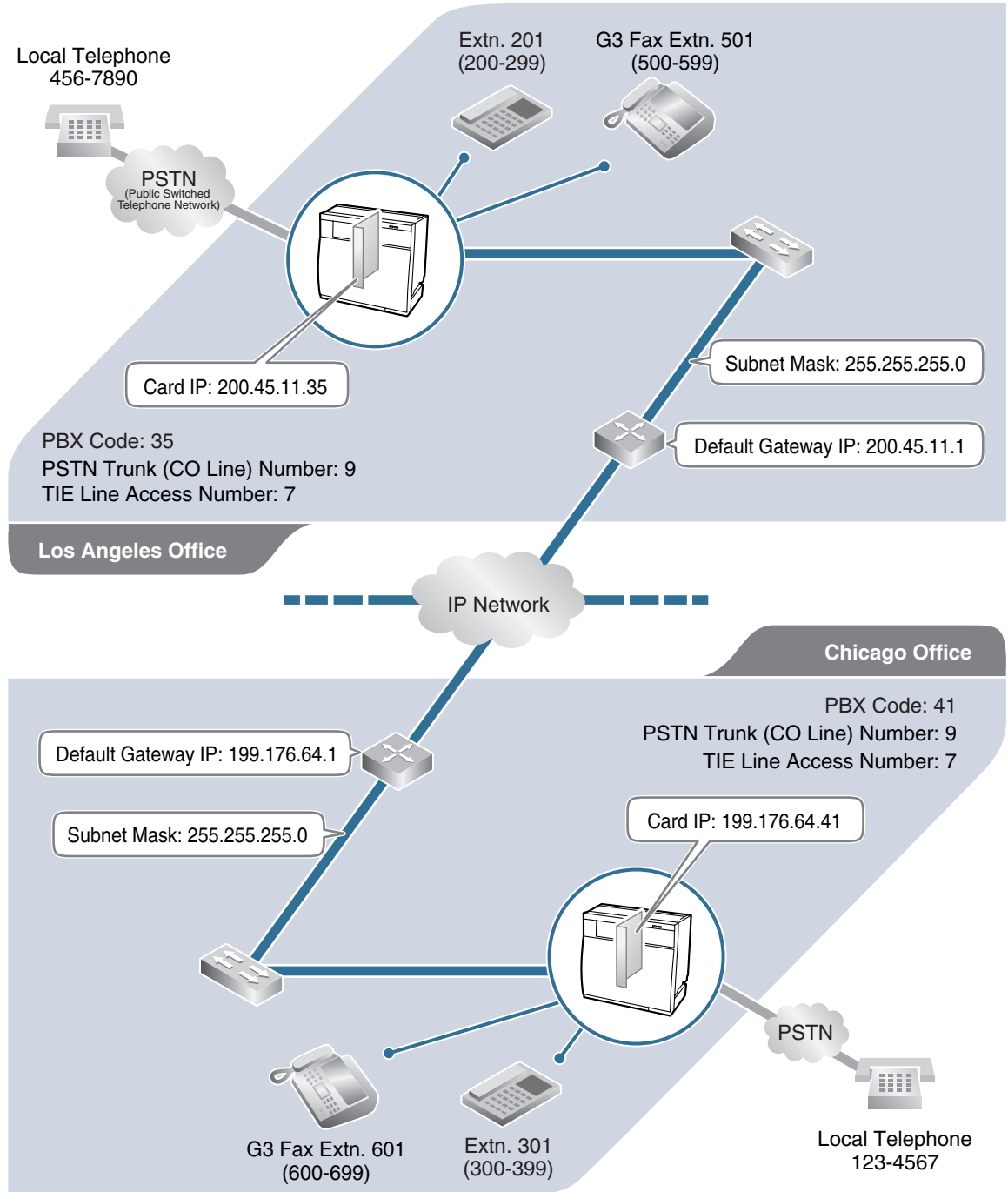

## 1.2.1 Network Application

### QSIG Network Interface

QSIG is a protocol based on ISDN (Q.931) that offers enhanced PBX features in a private network. The QSIG network supports private communications by the TIE line service method. Implementation of VoIP Gateway Cards provides a VoIP interface to employ a QSIG network between PBXs at different locations by using an IP network instead of conventional telephone networks.

### Types of IP Network

The VoIP Gateway Card's quality of performance depends on the type of IP network in use. Managed IP networks provide better quality of service compared to unmanaged networks such as the Internet, where quality of service is not guaranteed.

#### Examples of recommended IP networks

- Digital Leased Line
- IP-VPN (Virtual Private Network)
- Frame Relay

#### Not recommended

- Internet (including an Internet VPN)

#### Note

Unlike an IP-VPN, which is set up over a network provider's own IP network, an Internet VPN is set up over the Internet. As delays and loss in data transmission are likely to occur over the Internet, an Internet VPN is not recommended for use.

### Firewall

A firewall protects the internal networks of an organization against unauthorized penetration from outside. When routing a VoIP network through a firewall, some performance degradation may result. If for practical reasons you must route the VoIP network through a firewall, refer to "A1.3 Network Devices" for more details.

### Using the KX-TDA0490 with Other KX-TDA Series VoIP Gateway Cards

When using the KX-TDA0490 in a network that contains other KX-TDA series VoIP Gateway Cards, keep in mind the following points:

#### 1. Making and Receiving Calls

Calls can be made and received between the KX-TDA0490 and other KX-TDA series VoIP Gateway Cards. However, the KX-TDA0480 requires a special setting to be able to communicate with the KX-TDA0490 on the network. Refer to "D1 Considerations in Installation" for more details.

#### 2. Using QSIG Services

All QSIG services available with the PBX can be used between the KX-TDA0490 and KX-TDA0484/KX-TDA5480. However, CLIP service is the only available QSIG service between the KX-TDA0490 and KX-TDA0480.



## 1.2.2 Numbering Plan Example

There are 2 methods to plan your numbering system, as follows:

<b>PBX code method</b>	In addition to the destination number, the caller dials the unique PBX code of the PBX to which the called party is connected. Therefore, extension numbers at separate PBXs in the network can overlap. For example, each PBX in the network can have an extension whose number is 201.
<b>Extension number method</b>	The caller dials only the destination number of the called party to call through PBXs at different locations (hence there are fewer digits to dial than with the PBX code method). To employ the extension number method, no 2 PBXs can have extensions sharing the same number. For example, if one PBX in the network has an extension whose number is 201, no other PBX can have an extension with the same number (201).

This section provides a network numbering mechanism using the PBX code method based on the previous example diagram. Configure your network referring to this example.

### **Note**

An example using the extension number method is provided in "B Alternative Numbering Plan Example".

## IP Addressing Information

IP addressing information is typically supplied by a network administrator. Consult your network administrator for specific values.

	<b>Los Angeles Office</b>	<b>Chicago Office</b>	<b>Description</b>
Card IP Address	200.45.11.35	199.176.64.41	Identifies the location of each VoIP Gateway Card in the network during VoIP communications. A unique IP address must be assigned to each card.
Default Gateway Address	200.45.11.1	199.176.64.1	Identifies the IP address of the primary gateway (typically a router or similar device) that exchanges IP packets with the other gateways on the VoIP network.
Subnet Mask Address	255.255.255.0	255.255.255.0	Defines which digits of an IP address are used for the network address and the host address at each network location. A card IP address must fall within the same subnet as that of the default gateway (e.g., router) that is connected to the card.

## PBX Numbering Information

PBX numbering information is necessary to set up phone numbers for a VoIP network. Set the numbers conforming to existing PBX numbering systems.

	Los Angeles Office	Chicago Office	Description
PBX Code	35	41	A unique number (ranging from 1 to 7 digits) assigned to identify each PBX within a network. In this example, for convenience, each PBX code corresponds to the last portion of the IP address of its card; that is, because the Los Angeles office card has the IP address 200.45.11.35, Los Angeles PBX code is 35.
TIE Line Access Number	7	7	An access number to use the TIE line service.
PSTN Trunk (CO Line) Number	9	9	An access number to seize a local PSTN trunk (CO line).
Extension Number	200 to 299	300 to 399	A number assigned to each extension.
Fax Extension Number	500 to 599	600 to 699	A number assigned to each fax extension.

## Dialing Examples

The VoIP network allows you to access the PBX at one location from another to establish: (1) an extension call, or (2) an outside call through the local PSTN as if you are calling from the same area.

### Calling from Los Angeles to Chicago

To extension 301 via VoIP network



To local telephone 123-4567 via VoIP network through local PSTN

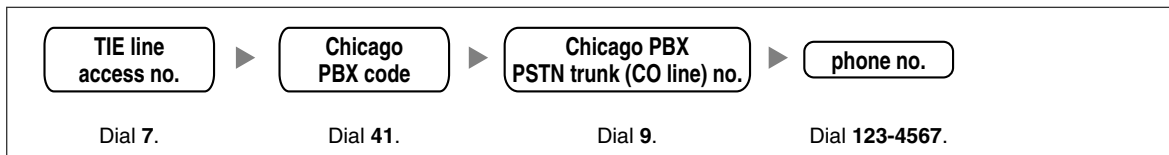

### Calling from Chicago to Los Angeles

To extension 201 via VoIP network

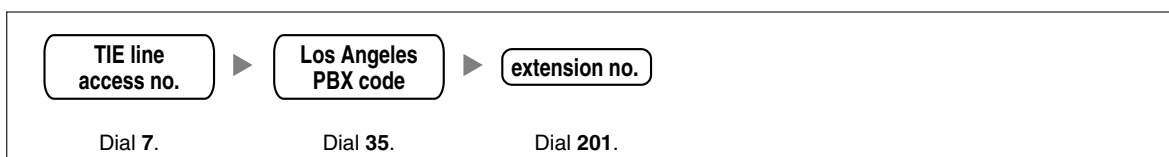

To local telephone 456-7890 via VoIP network through local PSTN

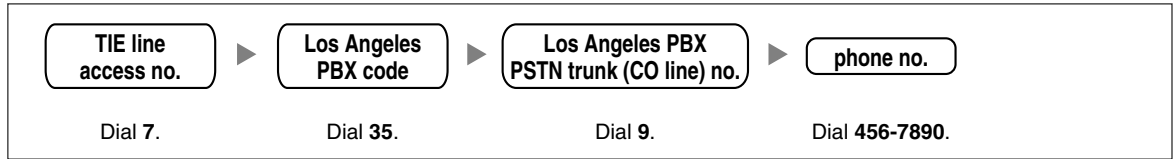

## PBX Connection Information

PBX connection information is created by combining IP Addressing Information and PBX Numbering Information. Referring to the sample below, create your own PBX connection information.

**Leading Number:**

A number composed of the PBX code followed by the first digit of the destination number. See the example on the right.

**Remaining Digits:**

The maximum number of digits to be dialed following the leading number to access the destination. (However, for example, setting the remaining digits to 7 does not mean that the user must dial all 7 digits when making a call.) See the example on the right.

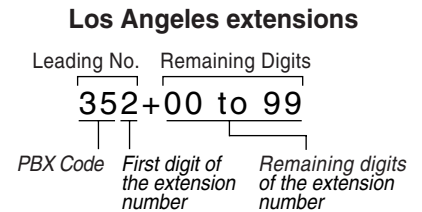

**Card IP Address:**

The IP address of each card in the network (as the access destination).

	Los Angeles Office (PBX Code: 35)			Chicago Office (PBX Code: 41)		
	Extn.	FAX Extn.	PSTN Access	Extn.	FAX Extn.	PSTN Access
Leading Number	352	355	359	413	416	419
Remaining Digits	2	2	7	2	2	7
Card IP Address	200.45.11.35			199.176.64.41		

## 1.2.3 Numbering Plan Summary

Reproduce this page and write down your network information in the space provided below for each card in the network. Consult your network administrator to fill in the shaded entries.

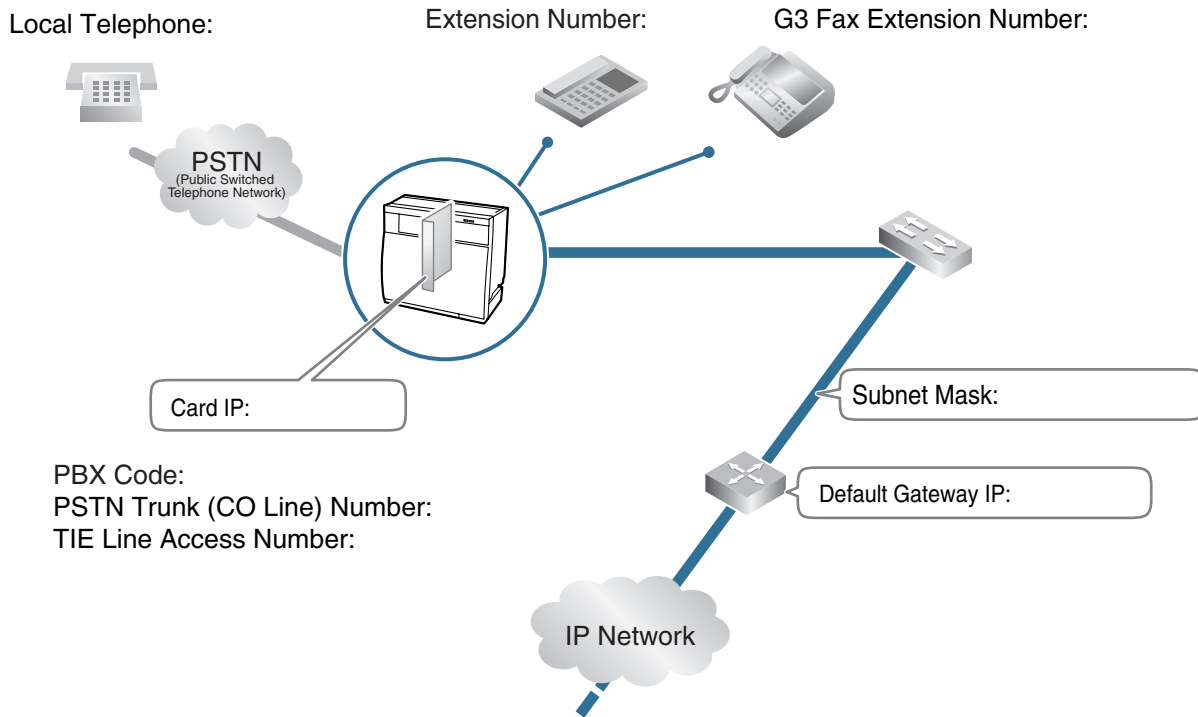

### IP Address

Card IP Address	
Default Gateway IP Address	
Subnet Mask Address	

### PBX Numbering

PBX Code	
TIE Line Access Number	
PSTN Trunk (CO Line) Number	
Extension Number	
Fax Extension Number	

### PBX Connection

	Extensions	Fax Extensions	PSTN Access
Leading Number			
Remaining Digits			
Card IP Address			

---

## **Section 2**

# ***Installing in the PBX***

*This section describes the physical installation process of the VoIP Gateway Card covering the following topics: (1) installing the card in the PBX, and (2) connecting the card to a network device using a Category 5 (CAT5) Ethernet cable.*

## 2.1 Installation

### 2.1.1 Names and Locations

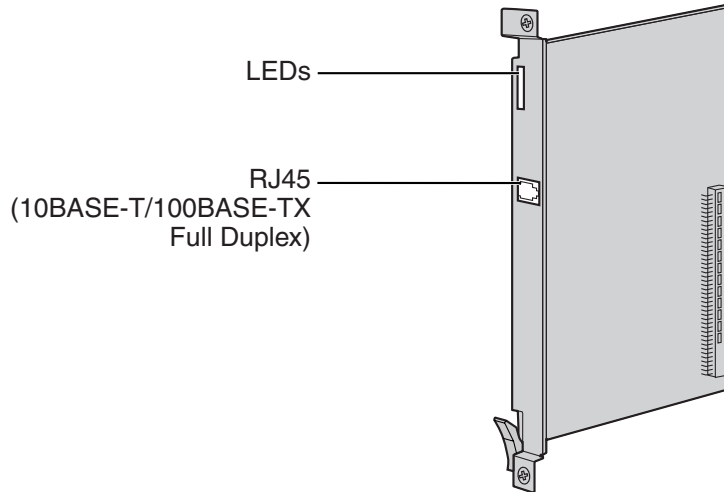

#### Indication Light (LED)

When the VoIP Gateway Card is operating, each LED should show the status identified in **bold-face letters** under normal conditions.

Indication	Color	Description
CARD STATUS	Green/Red	Card status indication <ul style="list-style-type: none"> <li>• OFF: Power Off</li> <li>• <b>Green ON: Normal (all ports are idle)</b></li> <li>• Green Flashing (60 times per minute): Normal (a port is in use)</li> <li>• Red ON: Fault (includes reset)</li> <li>• Red Flashing (60 times per minute): Out of Service</li> </ul>
ONLINE	Green	On-line status indication <ul style="list-style-type: none"> <li>• <b>ON: On-line mode</b></li> <li>• OFF: Off-line mode</li> <li>• Flashing: Maintenance mode</li> </ul> <p><b>Note</b> If the LINK indicator is OFF, the ONLINE indicator will also be OFF.</p>
ALARM	Red	Alarm indication <ul style="list-style-type: none"> <li>• ON: Alarm</li> <li>• <b>OFF: Normal</b></li> </ul>
VoIP BUSY	Green	VoIP (H.323) process indication <ul style="list-style-type: none"> <li>• OFF: VoIP process inactive</li> <li>• ON: VoIP process active</li> </ul>

Indication	Color	Description
LINK	Green	Link status indication <ul style="list-style-type: none"> <li>• <b>ON: Normal connection</b></li> <li>• OFF: Connection error</li> </ul>
DATA	Green	Data transmission indication <ul style="list-style-type: none"> <li>• ON: Data transmitting</li> <li>• OFF: No data transmitted</li> </ul>

## 2.1.2 Installing the VoIP Gateway Card in the PBX

Install the VoIP Gateway Card in a free slot of the PBX.

1. Insert the card along the guide rails.

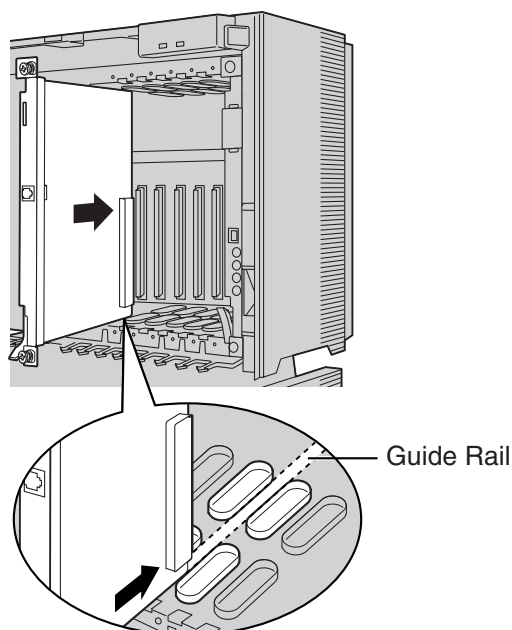

2. Holding the card as shown below, push the release lever in the direction of the arrow so that the card engages securely with the connector on the back board.

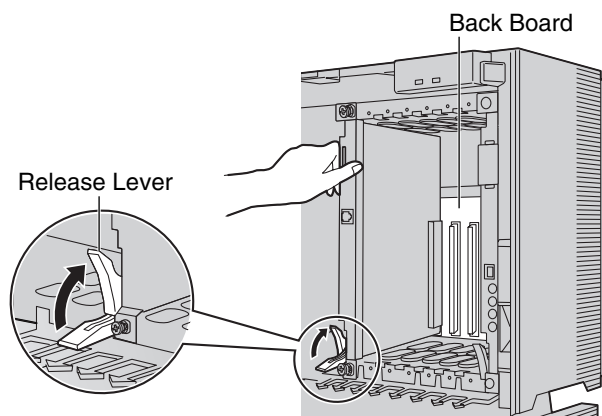

3. Turn the 2 screws clockwise to fix the card in place.

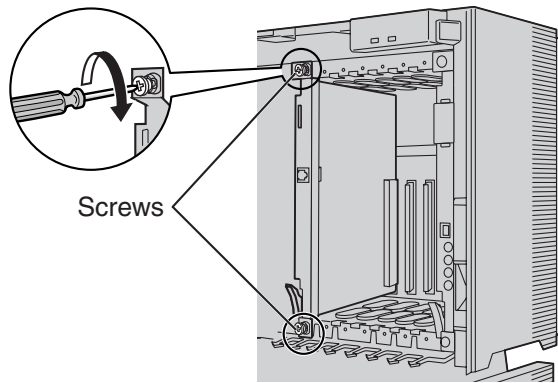

**Note**

Make sure the screws are tightened to ground the card securely.



## 2.2 Cable Connection

Use a Category 5 (CAT5) Ethernet cable (10BASE-T/100BASE-TX) with an RJ45 connector to connect the VoIP Gateway Card to a network device.

When connecting the card to a switching hub, use an Ethernet straight cable; when connecting directly to a router or PC, use an Ethernet cross cable.

### **Note**

Use only CAT5 Ethernet cable for connection.

### 2.2.1 Attaching a Ferrite Core to the Cable

When connecting the VoIP Gateway Card to a network device, first attach a ferrite core (included with the card) to the cable.

1. Wrap the cable once around the ferrite core, leaving 5 cm between the ferrite core and the connector.
2. Close the case of the ferrite core.

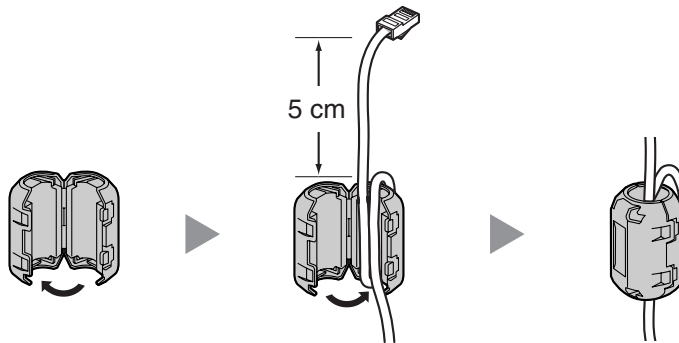

If you need to open the ferrite core, use a flathead screwdriver to unlatch the case of the ferrite core.

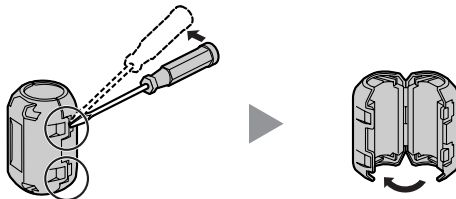

## 2.2.2 Connection for Programming

When assigning a new IP address to the VoIP Gateway Card for the first time, connect a PC directly to the card using an Ethernet cross cable.

1. Connect the Ethernet cable to the RJ45 connector of the card.
2. Connect the other end of the cable to the PC.

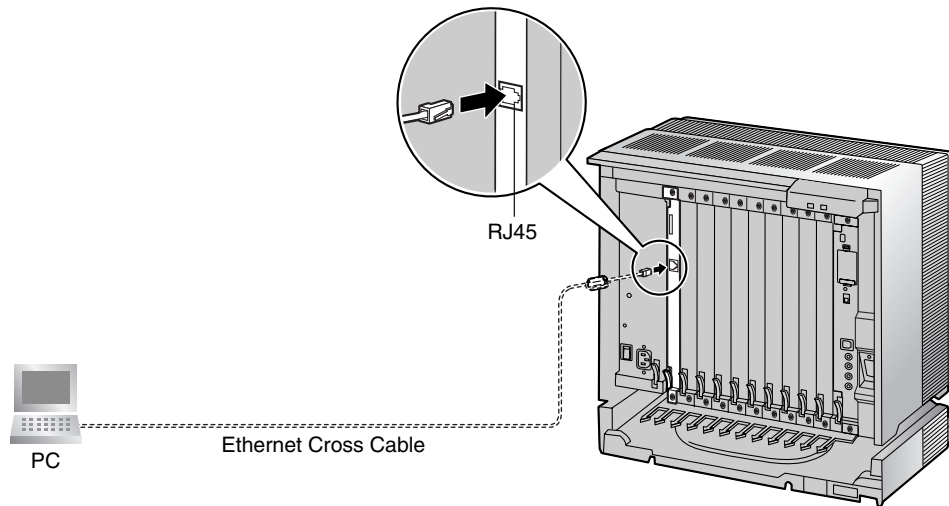

## 2.2.3 Connection to the LAN

Do not connect the VoIP Gateway Card to the LAN unless it has been assigned an IP address for actual VoIP operations on the network. Doing so may result in the default IP address of the card overlapping with an existing IP address on the LAN, or cause network failure.

1. Connect the Ethernet cable to the RJ45 connector of the card.
2. Connect the other end of the cable to the remote LAN equipment.

### Connecting to a switching hub

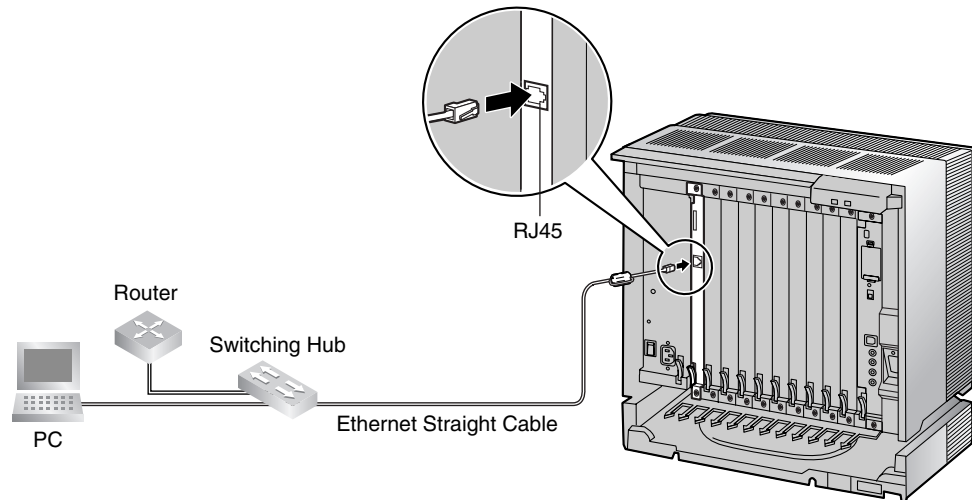

### Notes

- Make sure to connect to a switching hub. Do not connect to a repeater hub, as this will result in degradation in speech quality.
- Also, make sure to set the port of the switching hub that connects to the card to operate under "Auto Negotiation" mode. This will help assure error-free communication between the card and the switching hub.

### Connecting directly to a router

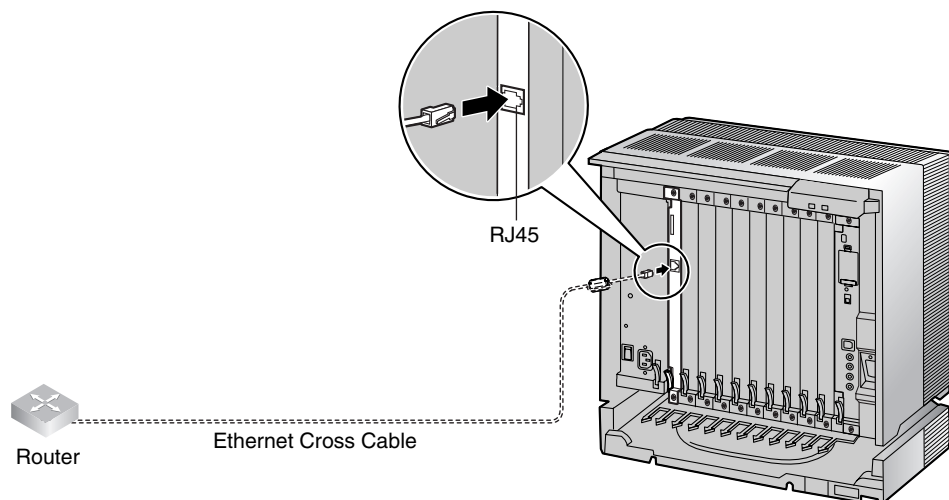



---

## Section 3

# Programming the VoIP Gateway Card

*One way of setting up a VoIP network for the first time is to go through the whole programming process of a VoIP Gateway Card at one location in the network, then start programming the other cards at different locations.*

*Based on the theoretical network illustrated previously in this manual, this section demonstrates the procedure to program the cards in the Los Angeles and Chicago offices.*

## 3.1 Preparations

A web programming utility called the IP-GW16 Maintenance Utility is available for programming of the VoIP Gateway Card.

For a complete discussion of web programming, refer to the VoIP Gateway Card Programming Guide.

### System Requirements

- The IP-GW16 Maintenance Utility requires Microsoft® Internet Explorer 5.0 or above.

### Trademarks

- Microsoft is either a registered trademark or trademark of Microsoft Corporation in the United States and/or other countries.
- All other trademarks identified herein are the property of their respective owners.
- Screen shots reprinted with permission from Microsoft Corporation.

### 3.1.1 Preparing the PC

To prepare for programming using the IP-GW16 Maintenance Utility, configure your PC by (1) assigning an IP address that belongs to the same network as that of the VoIP Gateway Card, and (2) choosing the appropriate options for the Internet properties.

#### Note

The procedure below is based on the Windows XP operating system as an example.

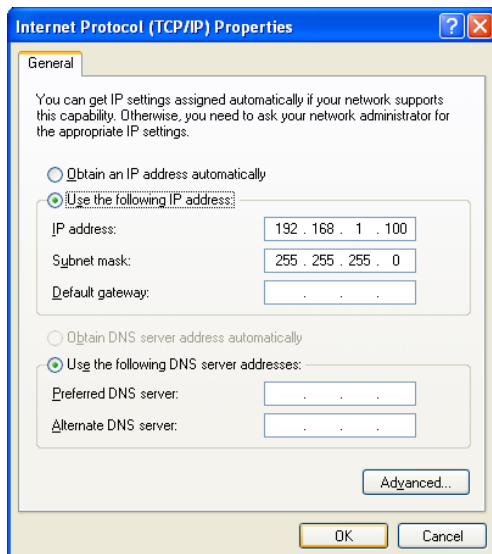

1. Open **Internet Protocol (TCP/IP) Properties** from the **Start** menu.
  2. a. Click **Use the following IP address**.
  - b. In the **IP address** box, type **192.168.1.100**.  
This is an example entry for the case when the card has the default IP address (192.168.1.200).
  - c. In the **Subnet mask** box, type **255.255.255.0**.
  - d. Click **OK**.
3. a. Start Internet Explorer from the **Start** menu.
  - b. Click **Internet Options** from the **Tools** menu.

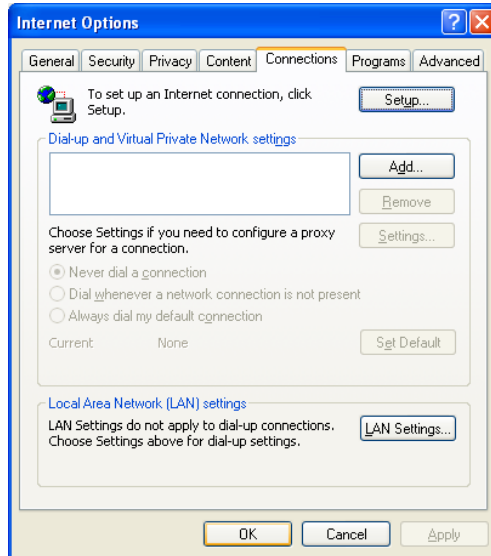

4. a. Click the **Connections** tab.
- b. Click **Never dial a connection**.
- c. Click **LAN Settings**.

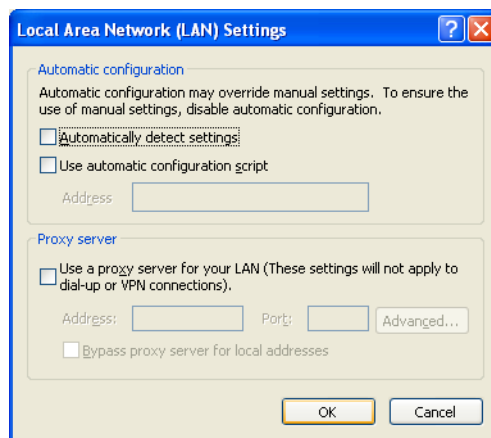

5. a. Click to clear all check boxes.
- b. Click **OK**.

Your PC is now ready for programming through direct access to the card.

### Notice When Programming the Card through an IP Network

When the card is put in actual operation on an IP network, you can access and program the card through the network. However, if the network has a proxy server installed, you must apply appropriate proxy settings to your PC. In this case, follow the steps below in substitution for step 5 above:

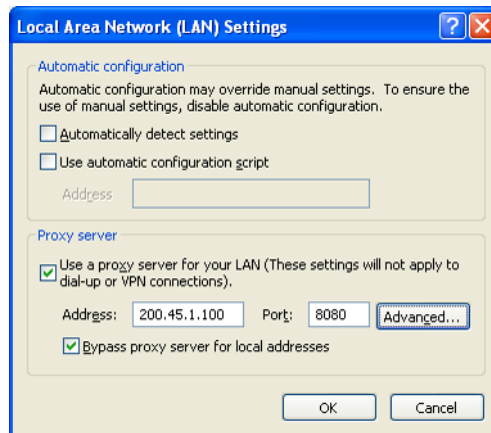

5. Click **Advanced**.

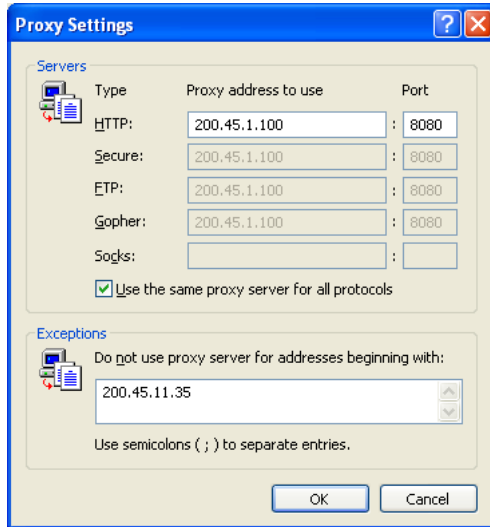

6. a. Under **Do not use proxy server for addresses beginning with:**, type the IP address of the card.
- b. Click **OK**.

Your PC is now ready for programming the card through an IP network.



## 3.2 Programming the VoIP Gateway Card in the Los Angeles Office

Based on the example network in "1.2 Network Devices and Numbering Plan", this section demonstrates the procedure to program a VoIP Gateway Card for use in the Los Angeles office, as the first step of setting up a VoIP network. VoIP communications between the 2 offices will be possible when the cards, as well as the PBXs, in both offices are fully programmed.

The procedure to program the card in the Chicago office is given in "3.3 Programming the VoIP Gateway Card in the Chicago Office". In addition, the procedure to program the PBX in the Los Angeles office is given in "4.1 Programming the PBX in the Los Angeles Office".

### 3.2.1 Starting the IP-GW16 Maintenance Utility

Make sure that a PC is connected directly to the VoIP Gateway Card with an Ethernet cross cable (see "2.2.2 Connection for Programming").

The card should not be connected to the LAN at this point.

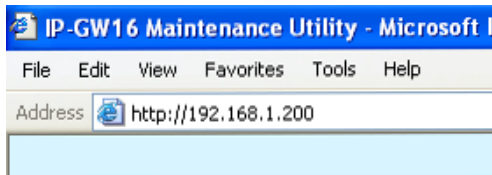

1. Start Internet Explorer from the **Start** menu.
2.
  - a. In the **Address** box of Internet Explorer, type **http://192.168.1.200** (default IP address of the card).
  - b. Press the ENTER key on the keyboard.

#### Notes

- If you cannot see the log-in screen, return to "3.1.1 Preparing the PC" and confirm that your PC has been configured appropriately.
- If you forget the IP address, you must initialize the card to the default setting (see "C1 Initializing the VoIP Gateway Card").

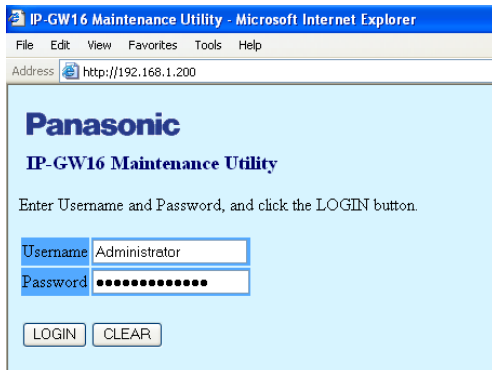

3.
  - a. In the **Username** box, type **Administrator** (default user name).
  - b. In the **Password** box, type **Administrator** (default password).
  - c. Click **LOGIN**.

#### Note

If you forget the user name or password, you must initialize the card to the default setting (see "C1 Initializing the VoIP Gateway Card").

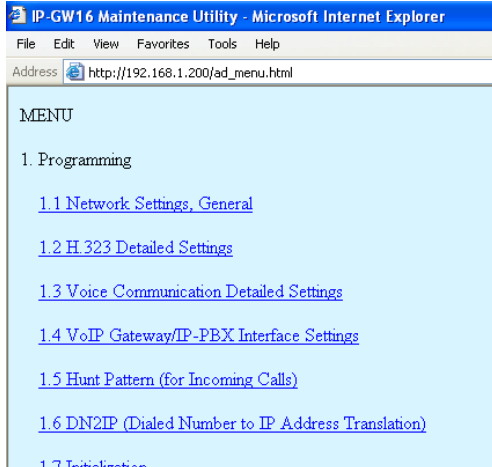

The main menu appears.

### **Note**

For readability of the text on the screen, it is recommended that you adjust the text size of Internet Explorer to below medium.

### **Note**

If you finish a programming session without logging out from the card (e.g., quitting Internet Explorer, or returning to the log-in screen with the "Back" button of Internet Explorer), you cannot log in again for the period of time specified by the parameter **Programming Auto Disconnect Time** (default: 10 min).

For the log-out procedure and **Programming Auto Disconnect Time** setting, refer to "2.5.2 Log Out" and "2.3.2 Maintenance Settings" of the VoIP Gateway Card Programming Guide, respectively.

## 3.2.2 Changing the Status of the VoIP Gateway Card

When programming the VoIP Gateway Card, place the card in the "STOP" status.



1. Click **2.1 Change RUN/STOP status** in the main menu.

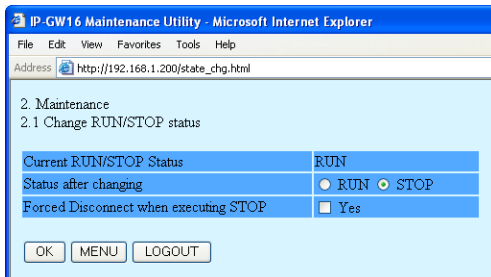

2. a. Click **STOP** for **Status after changing**.
- b. Click **OK**.

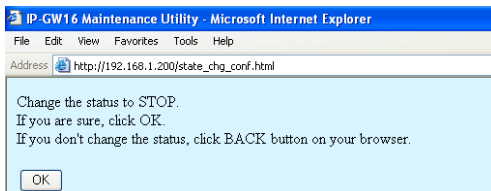

3. Click **OK**.

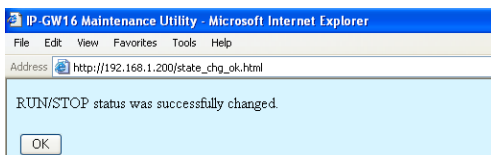

4. Click **OK**.

### 3.2.3 Assigning the IP Address

When programming the VoIP Gateway Card for the first time, a new IP address must be assigned. Once this is done and the card is on-line, it will be able to communicate with the other cards over the VoIP network.

The specific setting values are based on the table under "IP Addressing Information" in "1.2.2 Numbering Plan Example".

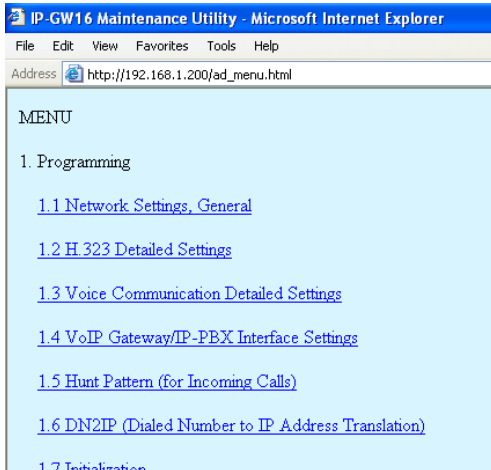

1. Click **1.1 Network Settings, General** in the main menu.

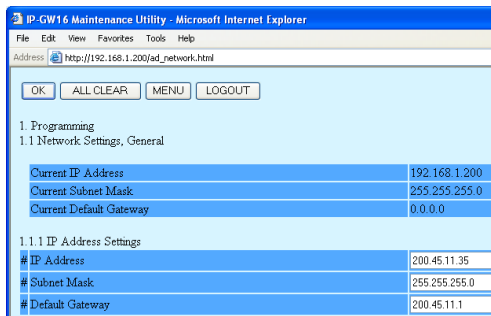

2. a. In the **IP Address** box, type **200.45.11.35**.  
 b. In the **Subnet Mask** box, type **255.255.255.0**.  
 c. In the **Default Gateway** box, type **200.45.11.1**.  
 d. Click **OK**.

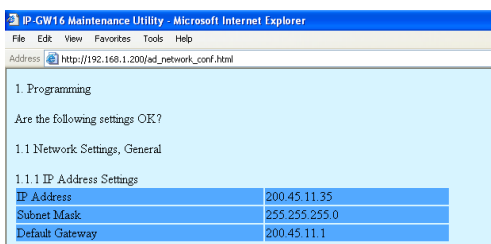

3. Confirm your entry, and then click **OK**.

**Note**

For more details about IP address assignment, refer to "2.2.1 Network Parameters" of the VoIP Gateway Card Programming Guide.

## 3.2.4 Assigning the Hunt Pattern

The hunt pattern determines how to route incoming calls through the VoIP Gateway Card to the PBX.

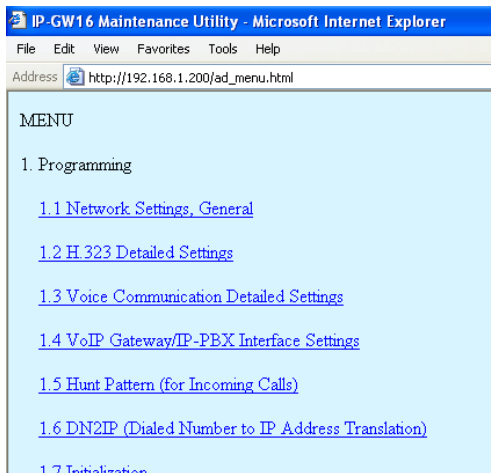

1. Click **1.5 Hunt Pattern (for Incoming Calls)** in the main menu.

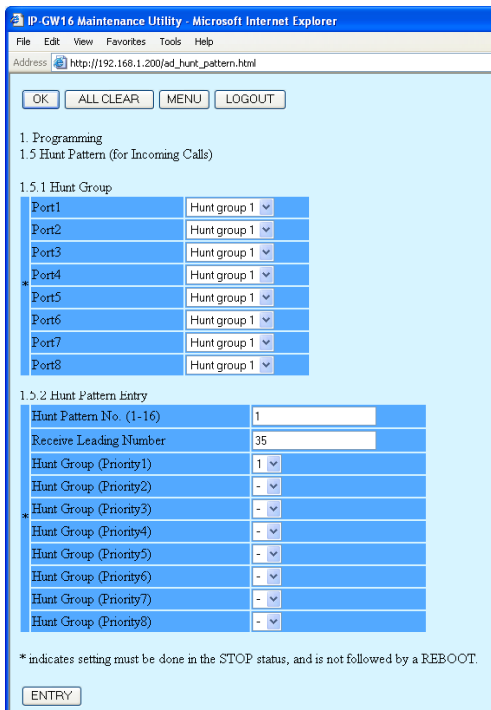

- In the **Hunt Pattern No.** box, type **1**.  
A hunt pattern will be created with this numbering.
- In the **Receive Leading Number** box, type **35** (PBX code).
- Click **ENTRY**.
- Click **OK**.

## 3.2 Programming the VoIP Gateway Card in the Los Angeles Office

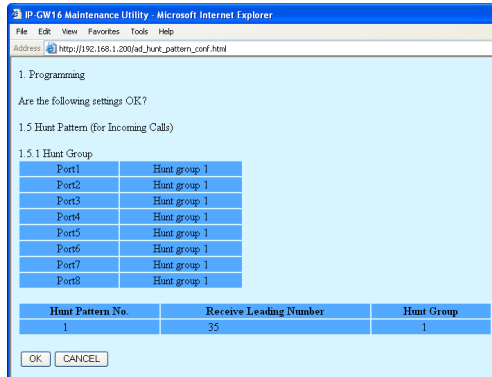

3. Confirm your entry, and then click **OK**.

### **Note**

For more details about hunt pattern assignment, refer to "2.2.5 Hunt Pattern Parameters" of the VoIP Gateway Card Programming Guide.

## 3.2.5 Programming the Address Translation Table

The function of an address translation table in a VoIP network is to provide 2-way translation of telephone numbers and IP addresses\*1. The address translation table is owned jointly by all VoIP Gateway Cards in the network. Therefore, whenever the address translation table is changed, it is important to update all the cards in the network with the latest information; otherwise VoIP communications cannot be established.

It is possible, at one location in the network, to program the address translation table that contains information for the entire network. The completed address translation table can then be distributed across the network, so that all the cards share the same information (see "3.2.6 Downloading the Address Translation Table from the VoIP Gateway Card", and "Uploading Address Translation Table to the VoIP Gateway Card" in "3.3 Programming the VoIP Gateway Card in the Chicago Office").

### Note

The address translation table created for the KX-TDA0490 can be shared with the KX-TDA0484 and KX-TDA5480.

The procedure below demonstrates the process of programming the address translation table necessary for VoIP communications between the Los Angeles and Chicago offices.

The specific setting values are based on the table under "PBX Connection Information" in "1.2.2 Numbering Plan Example".

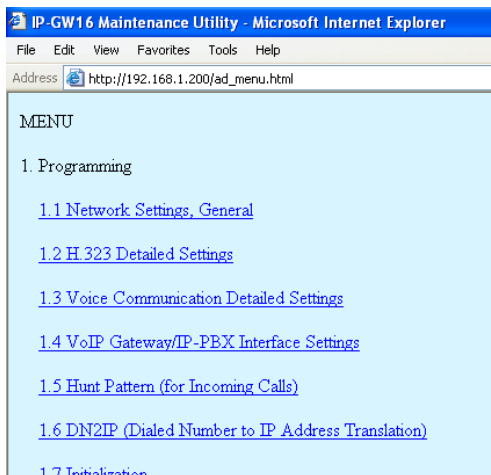

1. Click **1.6 DN2IP (Diald Number to IP Address Translation)** in the main menu.

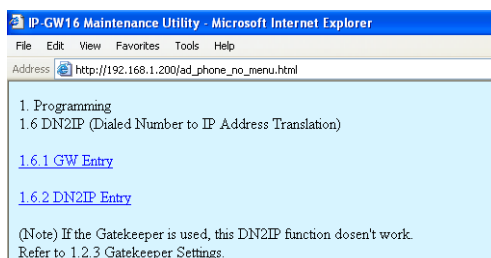

2. Click **1.6.1 GW Entry**.

\*1 IP address-to-telephone number translation can also be handled by using an H.323 Gatekeeper device. To configure Gatekeeper devices, refer to the manufacturer's documentation. This manual focuses on the method using the VoIP Gateway Card's internal address translation capabilities.

### 3.2 Programming the VoIP Gateway Card in the Los Angeles Office

IP-GW16 Maintenance Utility - Microsoft Internet Explorer

File Edit View Favorites Tools Help

Address http://192.168.1.200/ad\_register\_gw.html

OK MENU PREVIOUS LOGOUT

1. Programming

1.6 DN2IP (Dialed Number to IP Address Translation)

1.6.1 GW Entry

GW No. (0-511)	0
Comment	Los Angeles
IP Address	200.45.11.35
Group No.	0

\* indicates setting must be done in the STOP status, and is not followed by a REBOOT.

ENTRY

3. Do the following to configure the gateway entry for the Los Angeles office:
  - a. In the **GW No.** box, type **0**.  
A gateway entry for the card will be created with this numbering.
  - b. In the **Comment** box, type **Los Angeles** (a unique identifier of the card in the VoIP network).
  - c. In the **IP Address** box, type **200.45.11.35**.
  - d. In the **Group No.** box, type **0**.

#### Note

Having the value **0** for **Group No.** means that the card does not belong to any gateway group. Grouping is useful when installing multiple cards at one location. For details, refer to "2.2.6 Address Translation Table—GW Entry" of the VoIP Gateway Card Programming Guide.

IP-GW16 Maintenance Utility - Microsoft Internet Explorer

File Edit View Favorites Tools Help

Address http://192.168.1.200/ad\_register\_gw.html

OK MENU PREVIOUS LOGOUT

1. Programming

1.6 DN2IP (Dialed Number to IP Address Translation)

1.6.1 GW Entry

GW No. (0-511)	1
Comment	Chicago
IP Address	199.176.64.41
Group No.	0

\* indicates setting must be done in the STOP status, and is not followed by a REBOOT.

ENTRY

- e. Click **ENTRY**.
4. Do the following to configure the gateway entry for the Chicago office:
  - a. In the **GW No.** box, type **1**.
  - b. In the **Comment** box, type **Chicago**.
  - c. In the **IP Address** box, type **199.176.64.41**.
  - d. In the **Group No.** box, type **0**.
  - e. Click **ENTRY**.
  - f. Click **OK**.

IP-GW16 Maintenance Utility - Microsoft Internet Explorer

File Edit View Favorites Tools Help

Address http://192.168.1.200/ad\_register\_gw\_conf.html

1. Programming

Are the following settings OK?

1.6 DN2IP (Dialed Number to IP Address Translation)

1.6.1 GW Entry

GW No.	Comment	IP Address	Group No.
0	Los Angeles	200.45.11.35	-
1	Chicago	199.176.64.41	-

OK CANCEL

5. Confirm your entry, and then click **OK**.  
The gateway entries for the Los Angeles and Chicago offices are now configured.



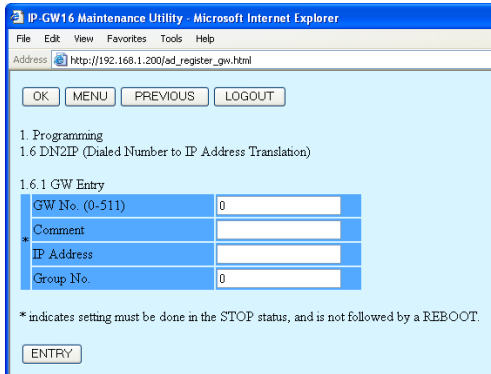

6. Click **PREVIOUS**.

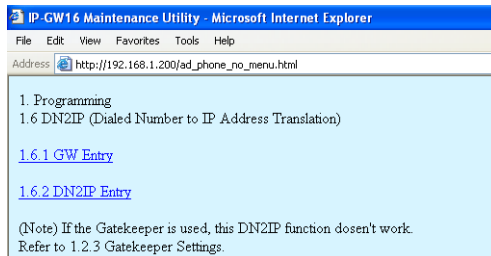

7. Click **1.6.2 DN2IP Entry**.

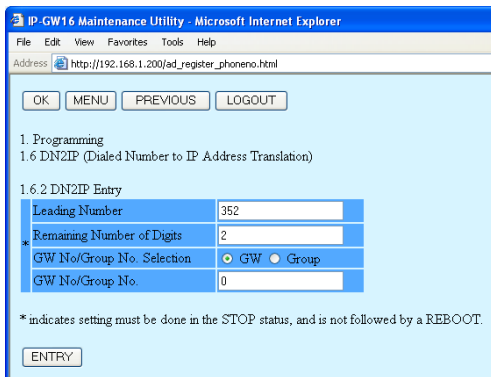

8. Do the following to configure the Los Angeles extensions:

- a. In the **Leading Number** box, type **352** (PBX code [35] + extension starting digit [2]).
- b. In the **Remaining Number of Digits** box, type **2** (2 digits to dial [00 to 99] following the leading number).
- c. Click **GW** for **GW No/Group No. Selection**.
- d. In the **GW No/Group No.** box, type **0** (the gateway entry for the card).
- e. Click **ENTRY**.

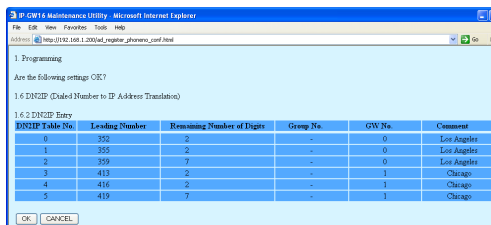

9. a. Referring to step 8, complete the address translation table as shown on the left.
- b. Click **OK**.
- c. Confirm your entry, and then click **OK**.

**Note**

For more details about address translation programming, refer to "2.2.6 Address Translation Table—GW Entry" and "2.2.7 Address Translation Table—DN2IP Entry" of the VoIP Gateway Card Programming Guide.

## 3.2.6 Downloading the Address Translation Table from the VoIP Gateway Card

After the address translation table has been fully programmed, download the data from the VoIP Gateway Card.

The downloaded data can be uploaded to the other cards on the VoIP network (see "Uploading Address Translation Table to the VoIP Gateway Card" in "3.3 Programming the VoIP Gateway Card in the Chicago Office"), so that all the cards can communicate with each other over the network.

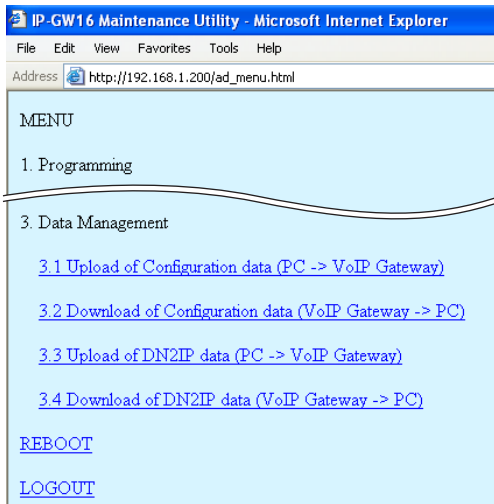

1. Click **3.4 Download of DN2IP data (VoIP Gateway → PC)** in the main menu.

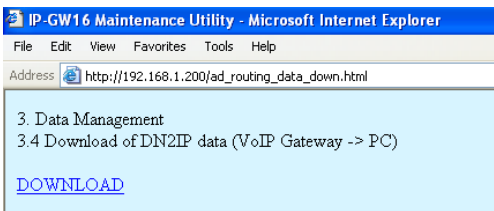

2. a. Click **DOWNLOAD**.  
b. Specify the file name and the folder in which to save the file.

### Note

For more details about downloading the address translation table, refer to "2.4.4 Download of Address Translation Table" of the VoIP Gateway Card Programming Guide.

## 3.2.7 Rebooting the VoIP Gateway Card

For all the changes to the parameters to become effective, you must reboot the VoIP Gateway Card.

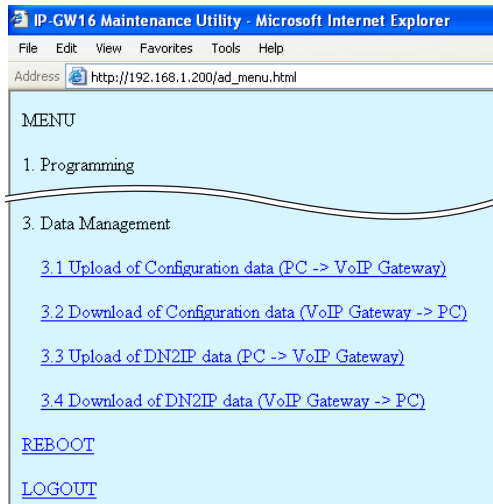

1. Click **REBOOT** in the main menu.

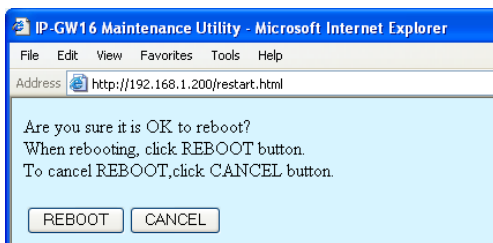

2. Click **REBOOT**.

## 3.2.8 Confirming the IP Address Assignment

After programming of the VoIP Gateway Card is finished, try to access the card with the new IP addressing information. If you can connect to the card without problems, the card can be placed on the LAN for VoIP operations (see "2.2.3 Connection to the LAN").

Follow the procedure below, referring to "3.1.1 Preparing the PC" and "3.2.1 Starting the IP-GW16 Maintenance Utility".

1. Set the IP address settings of the PC to the following values:
  - IP address: 200.45.11.100
  - Subnet Mask address: 255.255.255.0
2. Start Internet Explorer from the **Start** menu.
3. In the **Address** box of Internet Explorer, type **http://200.45.11.35** (the new IP address of the card).
4. Press the ENTER key on the keyboard.  
If you can log in, then the card has been successfully programmed.

After you have confirmed that the card has been successfully programmed, it is strongly recommended that you download the configuration data from the card and save it on your PC for backup and archive purposes.

The procedure for downloading the configuration data is provided in "2.4.2 Download of Configuration Data" of the VoIP Gateway Card Programming Guide.

## 3.3 Programming the VoIP Gateway Card in the Chicago Office

This section details the procedure to program the VoIP Gateway Card in the Chicago office, which for the most part is a duplication of that for the Los Angeles office. For general information that is not discussed here, refer to the relevant sections in "3.2 Programming the VoIP Gateway Card in the Los Angeles Office".

There are differences in the procedure where distinct setting values are required for parameters that are dependent on the specific network configuration of the Chicago office. Also, the address translation table does not need to be programmed, because the one downloaded from the card in the Los Angeles office already contains the information for the entire network. You can simply upload the address translation table from the Los Angeles office, and the cards can communicate with each other on the network.

### Starting the IP-GW16 Maintenance Utility

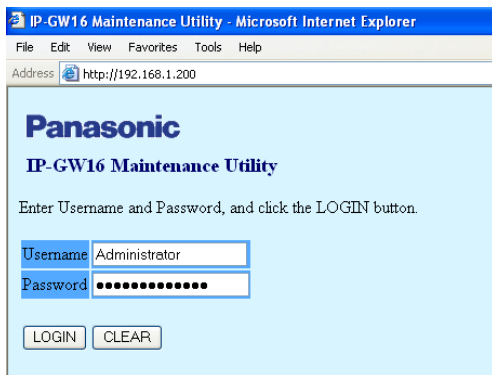
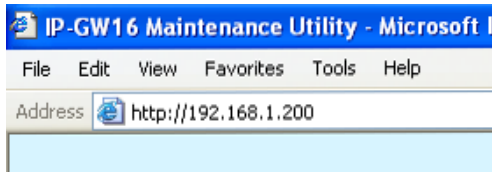

1. Start Internet Explorer from the **Start** menu.
2.
  - a. In the **Address** box of Internet Explorer, type **http://192.168.1.200** (default IP address of the card).  
Make sure that the PC has the appropriate IP address setting to access the card (refer to "3.1.1 Preparing the PC").
  - b. Press the ENTER key on the keyboard.
3.
  - a. In the **Username** box, type **Administrator** (default user name).
  - b. In the **Password** box, type **Administrator** (default password).
  - c. Click **LOGIN**.  
The main menu appears.

### Changing the Status of the VoIP Gateway Card

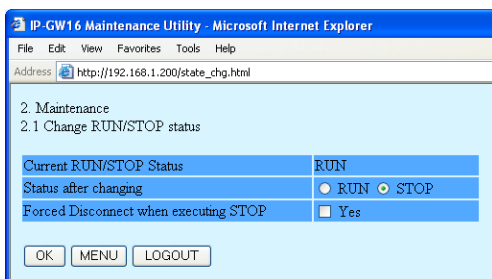

1. Click **2.1 Change RUN/STOP status** in the main menu.
2.
  - a. Click **STOP** for **Status after changing**.
  - b. Click **OK**.
  - c. Click **OK**.
  - d. Click **OK**.

## Assigning the IP Address

Note that the card in the Chicago office requires different IP address settings from the card in the Los Angeles office.

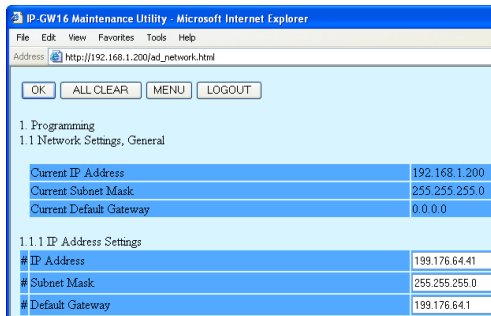

1. Click **1.1 Network Settings, General** in the main menu.
2.
  - a. In the **IP Address** box, type **199.176.64.41**.
  - b. In the **Subnet Mask** box, type **255.255.255.0**.
  - c. In the **Default Gateway** box, type **199.176.64.1**.
  - d. Click **OK**.

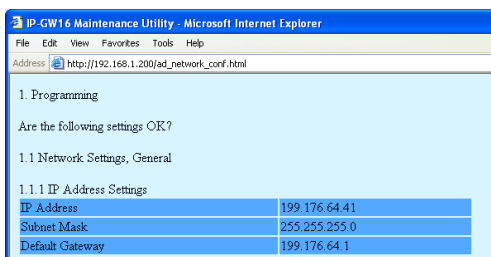

3. Confirm your entry, and then click **OK**.

## Assigning the Hunt Pattern

Note that the card in the Chicago office requires a different PBX code from the card in the Los Angeles office.

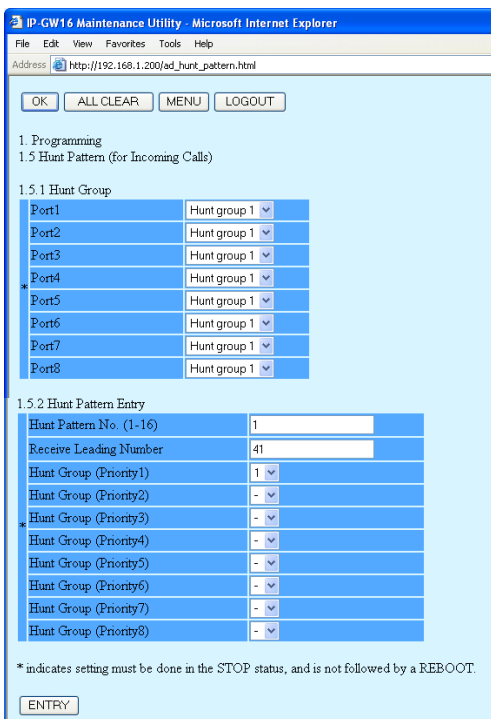

1. Click **1.5 Hunt Pattern (for Incoming Calls)** in the main menu.
2.
  - a. In the **Hunt Pattern No.** box, type **1**.
  - b. In the **Receive Leading Number** box, type **41** (PBX code).
  - c. Click **ENTRY**.
  - d. Click **OK**.

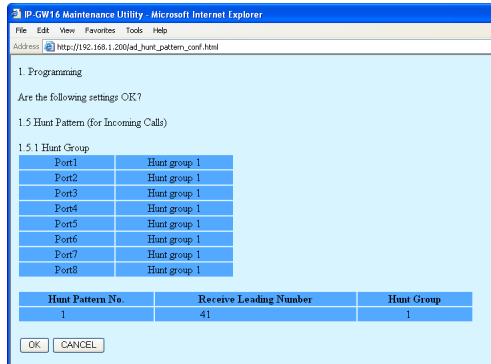

3. Confirm your entry, and then click **OK**.

## Uploading Address Translation Table to the VoIP Gateway Card

For the VoIP Gateway Cards in the Los Angeles and Chicago offices to communicate properly over the VoIP network, the cards must share the same address translation table.

Follow the procedure below to upload the address translation table downloaded from the card in the Los Angeles office (see "3.2.6 Downloading the Address Translation Table from the VoIP Gateway Card") to the card in the Chicago office.

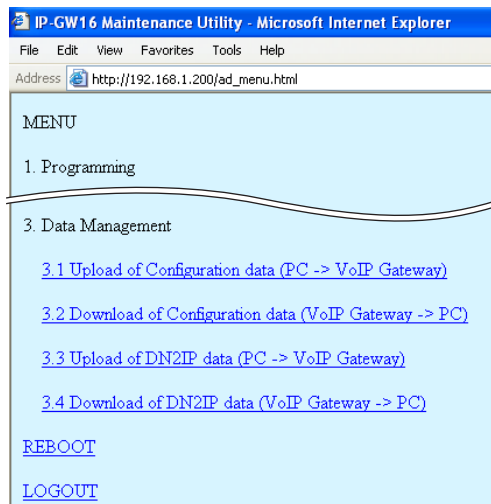

1. Click **3.3 Upload of DN2IP data (PC → VoIP Gateway)** in the main menu.

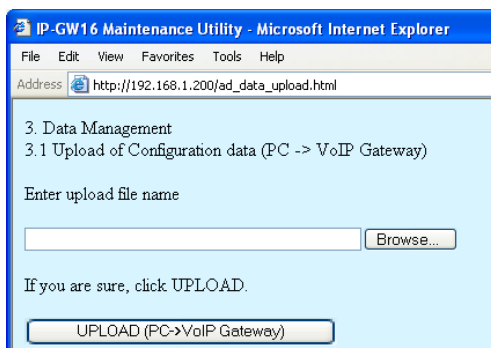

2. a. Click **Browse** and choose a file to upload.  
 b. Click **UPLOAD(PC→VoIP Gateway)**.

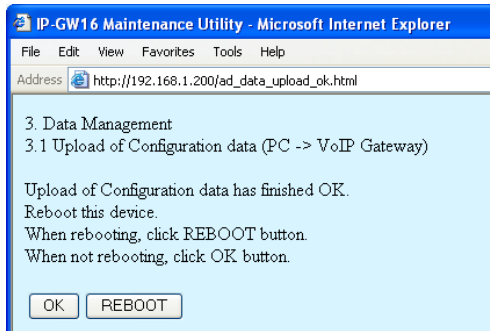

3. Click **REBOOT**.

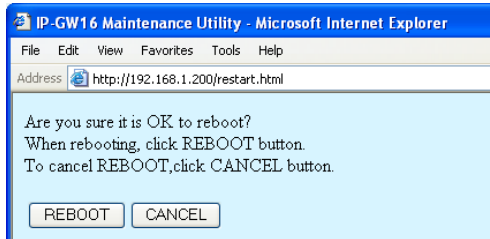

4. Click **REBOOT**.

#### **Note**

For more details about uploading the address translation table, refer to "2.4.3 Upload of Address Translation Table" of the VoIP Gateway Card Programming Guide.

## Confirming the IP Address Assignment

Note that the card in the Chicago has been assigned a different IP address from the card in the Los Angeles office.

1. Set the IP address settings of the PC to the following values:
  - IP address: 199.176.64.100
  - Subnet Mask address: 255.255.255.0
2. Start Internet Explorer from the **Start** menu.
3. In the **Address** box of Internet Explorer, type **http://199.176.64.41** (the new IP address of the card).
4. Press the ENTER key on the keyboard.

If you can log in, then the card has been successfully programmed.

After you have confirmed that the card has been successfully programmed, it is strongly recommended that you download the configuration data from the card and save it on your PC for backup and archive purposes.

The procedure for downloading the configuration data is provided in "2.4.2 Download of Configuration Data" of the VoIP Gateway Card Programming Guide.



---

## **Section 4**

# ***Programming the PBX***

*This section details the procedure to program the PBX to use the VoIP Gateway Card.*

## 4.1 Programming the PBX in the Los Angeles Office

For successful operation of a VoIP network using the VoIP Gateway Card as a QSIG network interface, the PBX at each location in the network must be programmed appropriately. For a detailed discussion of related features, refer to the Hybrid IP-PBX Feature Guide.

This section details the procedure to program the PBX in the Los Angeles office. After the PBX in the Los Angeles office has been fully programmed, repeat the procedure for the PBX in the Chicago office with the appropriate setting values.

### Notes

- It is assumed that you have already installed the KX-TDA Maintenance Console (PC programming software of the PBX) in your PC.
- The contents and design of the software are subject to change without notice.

1. Start the KX-TDA Maintenance Console from the **Start** menu.

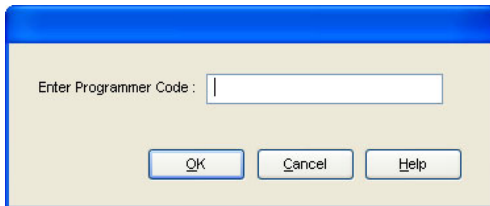

2. a. Type the Installer Level Programmer Code (default: **INSTALLER**).  
b. Click **OK**.

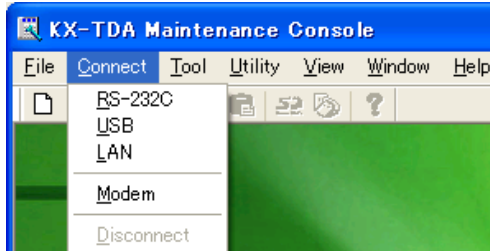

3. a. Click **Connect** → **RS-232C** or **USB**.  
b. In the next screen, type the system password for installer (default: **1234**).  
c. Click **OK**.  
The program menu appears.

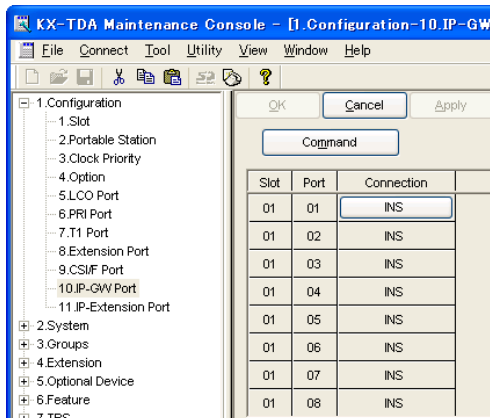

4. a. Double-click **Configuration**.  
b. Double-click **IP-GW Port**.  
Confirm that ports 1 through 8 are in service (**INS**).

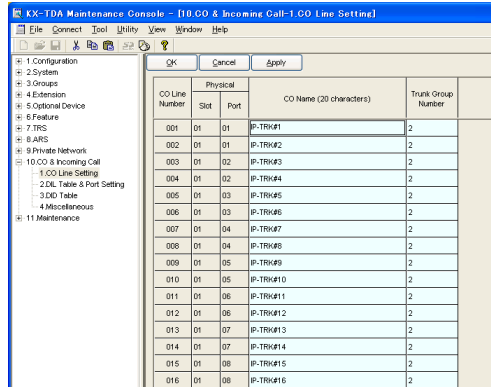

5. a. Double-click **CO & Incoming Call**.
- b. Double-click **CO Line Setting**.
- c. Type the **CO Name** and assign an unused **Trunk Group Number** to be used for all VoIP gateway trunks (CO lines).
- d. Click **OK**.

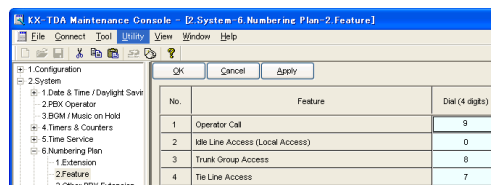

6. a. Double-click **System**.
- b. Double-click **Numbering Plan**.
- c. Double-click **Feature**.
- d. In the **Tie Line Access** box, type the dialing number.
- e. Click **OK**.

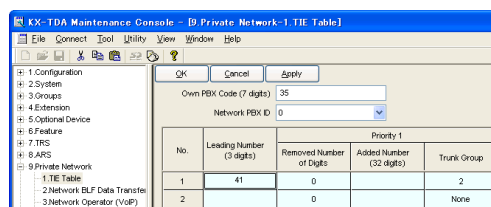

7. a. Double-click **Private Network**.
- b. Double-click **TIE Table**.
- c. In the **Own PBX Code** box, type **35** (the PBX code of the local PBX in the network).
- d. In the **Leading Number** box, type **41** (the PBX code of the remote PBX in the network).
- e. In the corresponding **Trunk Group** list, click the number of the trunk (CO line) group to be used when making calls.
- f. Set the number modification pattern, if necessary.
- g. Click **OK**.

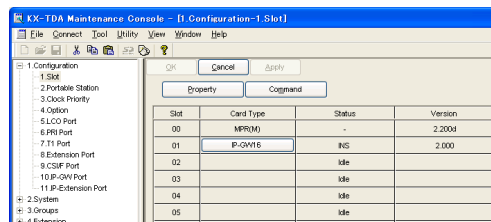

8. a. Double-click **Configuration**.
- b. Double-click **Slot**.
- c. Click **Status** of the card.
- d. Set the status to **OUS**.
- e. Click **Card Type** of the card.
- f. In the **Value** list, click **Overlap** (default) or **En-bloc**\*1.
- g. Click **OK**.
- h. Click **Status** of the card.
- i. Set the status to **INS**.

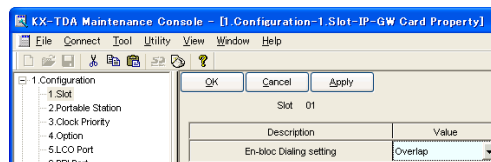

\*1 When "En-bloc" is selected, you need to press "#" after dialing the phone number.

**Note**

For details about network parameter settings, refer to the relevant sections of the Hybrid IP-PBX Feature Guide.



---

# ***Appendix A***

## ***Guidance for VoIP Installation***

# A1 VoIP Requirements

## A1.1 Bandwidth Assessment

When using the VoIP Gateway Card, you must ensure that the IP network in use has enough bandwidth to support VoIP communications. If the amount of bandwidth required for VoIP communications is larger than what the network can accommodate, speech quality will be compromised. In addition, there may be some adverse effect on the performance of other applications (e.g., email or web applications) that use the same network. Therefore, care must be taken when assessing bandwidth requirements.

Inform your network administrator of the required bandwidth, and make sure that the network can support VoIP communications even under conditions of maximum network traffic.

### Bandwidth Calculation

Provided below is the formula to find out the amount of bandwidth required for VoIP communications:

**Required Bandwidth**  
 = (No. of Fax Machines × Required Bandwidth for the G.711 CODEC) +  
 [(16 - No. of Fax Machines) × Required Bandwidth for Voice Communication]

Required bandwidth for one VoIP channel is shown in the tables below (for more details, refer to "2.2.3 Voice Communication Parameters" in the VoIP Gateway Card Programming Guide).

### Required Bandwidth for One VoIP Channel

The required bandwidth depends on what combination of CODEC and packet sending interval is used. Keep in mind the following points about the type of CODEC and packet sending interval, in terms of the speech quality:

- The speech quality of the CODECs varies as follows: (High) G.711, G.729A, G.723.1 (Low)
- The shorter the packet sending interval, the higher the speech quality.
- The higher the speech quality the VoIP Gateway Card provides, the more bandwidth the card requires.

#### Via LAN

CODEC	Packet Sending Interval				
	20 ms	30 ms	40 ms	60 ms	90 ms
G.711	87.2 kbps	79.5 kbps	75.6 kbps	71.7 kbps	—
G.729A	31.2 kbps	23.5 kbps	19.6 kbps	15.7 kbps	—
G.723.1 5.3 kbps	—	20.8 kbps	—	13.1 kbps	10.5 kbps
G.723.1 6.3 kbps	—	21.9 kbps	—	14.1 kbps	11.6 kbps

**Via WAN (PPP: Point-to-Point Protocol)**

CODEC	Packet Sending Interval				
	20 ms	30 ms	40 ms	60 ms	90 ms
G.711	84 kbps	77.3 kbps	74 kbps	70.7 kbps	—
G.729A	28 kbps	21 kbps	18 kbps	14.7 kbps	—
G.723.1 5.3 kbps	—	18.7 kbps	—	12 kbps	9.8 kbps
G.723.1 6.3 kbps	—	19.7 kbps	—	13.1 kbps	10.8 kbps

**Example**

Consider the following case as an example:

- Communication: via LAN
- No. of Fax Machines: 2
- G.711 Packet Sending Interval: 20 ms (requiring 87.2 kbps per channel)
- G.729A Packet Sending Interval for Voice Communication: 20 ms (requiring 31.2 kbps per channel)

In this case, the required bandwidth will be as follows:

<p><b>Required Bandwidth</b></p> $= (2 \times 87.2) + [(16 - 2) \times 31.2]$ $= 611.2 \text{ (kbps)}$
--

Therefore, inform your network administrator and make sure that the network can support a bandwidth of 611.2 kbps even when the network is under conditions of maximum traffic.

**Note**

It is recommended that all cards in a VoIP network have the same packet sending interval.

**Additional Information**

As described above, it is possible to control the required bandwidth by selecting a certain combination of CODEC and packet sending interval. However, it is also possible to control required bandwidth by limiting the number of available VoIP channels.

The card supports a total of 8 ports, each having 2 separate channels. By disabling some of the ports, you can reduce the bandwidth required for VoIP communications.

**To limit the number of VoIP channels:**

- Set the status of the ports you wish to disable (starting from the highest-numbered port) to **OUS**. For example, if you wish to use only 10 of the available 16 VoIP channels (i.e., disable 6 channels), set the ports 8, 7, and 6 to **OUS** as shown below:

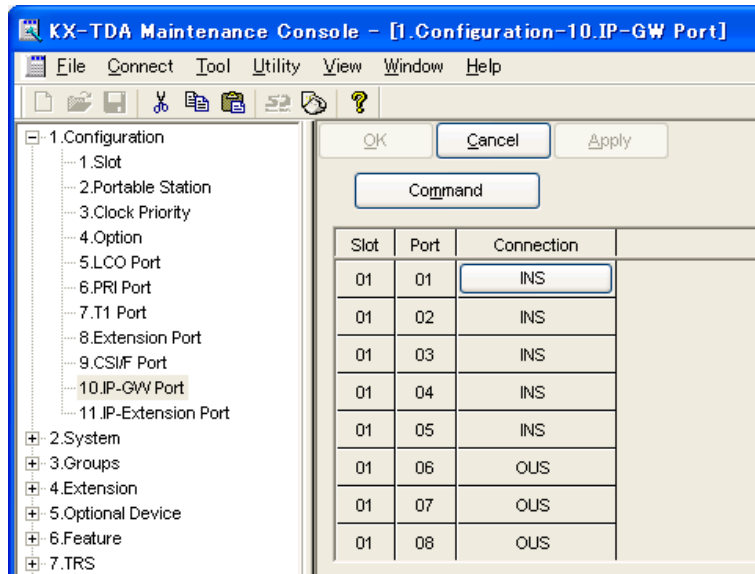

In this case, the equation for bandwidth calculation, based on the previous example, will be changed as follows:

**Required Bandwidth**

$$= (\text{No. of Fax Machines} \times \text{Required Bandwidth for the G.711 CODEC}) + [(\mathbf{10} - \text{No. of Fax Machines}) \times \text{Required Bandwidth for Voice Communication}]$$

$$= (2 \times 87.2) + [(\mathbf{10} - 2) \times 31.2]$$

$$= 424 \text{ (kbps)}$$

## A1.2 Network Configuration

You must evaluate the structure of the existing network to see if a VoIP network can be implemented. Below are the points that should be taken into your evaluation.

### Is the IP network a managed network?

A VoIP network should be implemented on a managed IP network such as Frame Relay, Leased Line, or IP-VPN (Virtual Private Network).

An unmanaged network, such as the Internet (including an Internet VPN), cannot be used to employ a VoIP network because delays and loss in data transmission can cause huge degradation in speech quality.



## Is it possible to have static IP addressing?

Because the maintenance of the VoIP Gateway Card is carried out from a personal computer (PC) through an IP network, the card must be assigned a static IP address.

Static IP addressing must be made possible even when the DHCP feature is used. For more details, refer to "2.2.1 Network Parameters" in the VoIP Gateway Card Programming Guide.

## Is network address translation (NAT/NAPT) disabled?

In a network where address translation techniques (e.g., NAT/NAPT) are used to convert between global and local IP addresses, VoIP communications based on the H.323 protocol cannot be carried out appropriately. Generally, NAT/NAPT are features that are available with routers.

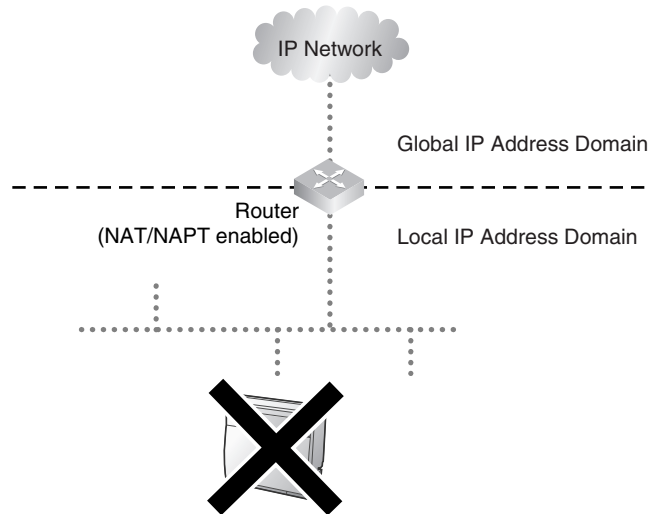

### **Note**

If the router on the network supports the "H.323 NAT" feature, it may be possible to have VoIP communications over the network. For more information, consult your network administrator.

## Does only a single router provide access to the IP network?

In a dual network, 2 routers provide access to the IP network as shown in the diagram below. However, the VoIP Gateway Card cannot take the advantage of having 2 routers as access points to the IP network.

For example, if router A, whose IP address is assigned as the default gateway IP address of the card, fails, VoIP communications are no longer possible; the card is not able to switch its default gateway from router A to router B to access the IP network. For more details about the default gateway setting, refer to "2.2.1 Network Parameters" of the VoIP Gateway Card Programming Guide.

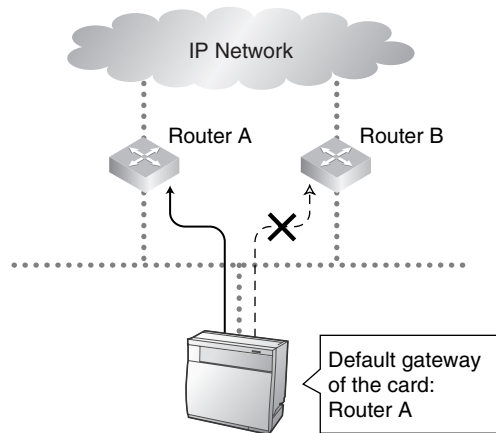

## Is there only a single IP network between 2 ends of a call?

A huge degradation in speech quality will be produced when calls are made through multiple IP networks as shown below; therefore, it is recommended that you avoid establishing a VoIP network in this fashion.

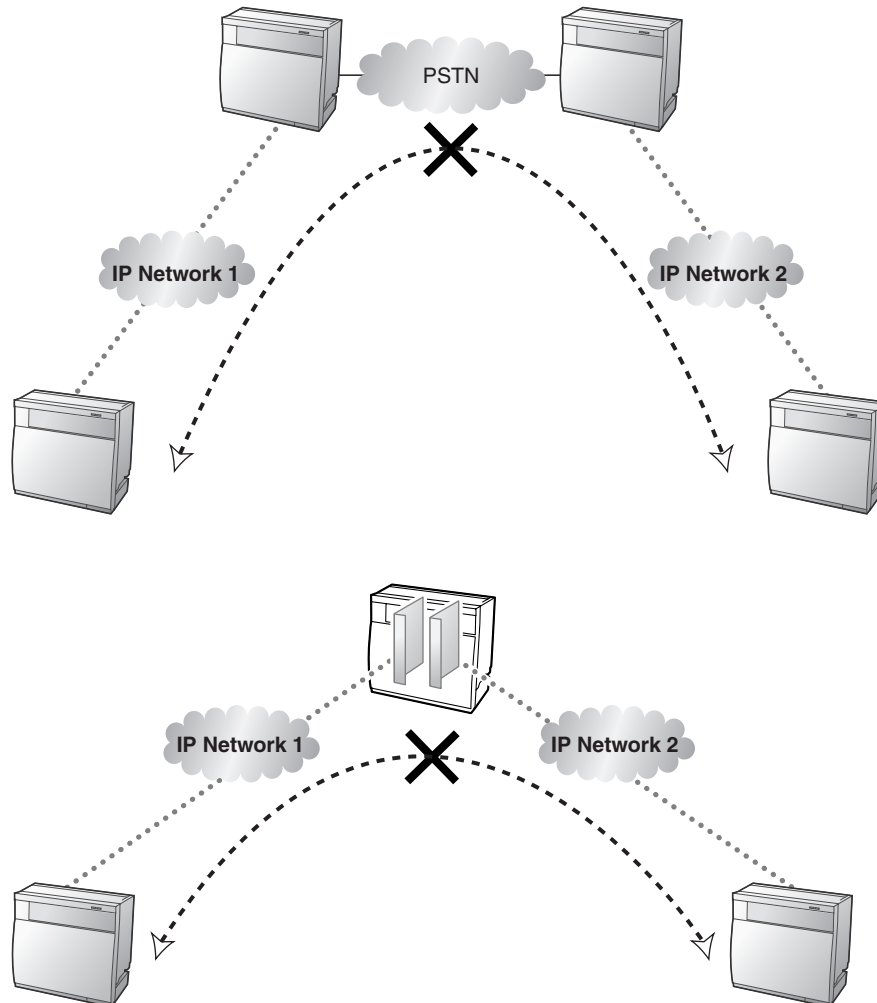

## Is the card located appropriately?

Transmission delays can cause pauses and loss in VoIP communications. The more network devices (e.g., routers and switches) there are between the communicating cards, the larger the transmission delays, because a certain amount of delay is inevitable when packets go through each network device (hop).

One preventative measure is to install the card so that the number of transmission hops is kept to a minimum. In the diagram below, the card is located as close to the IP network interface as possible.

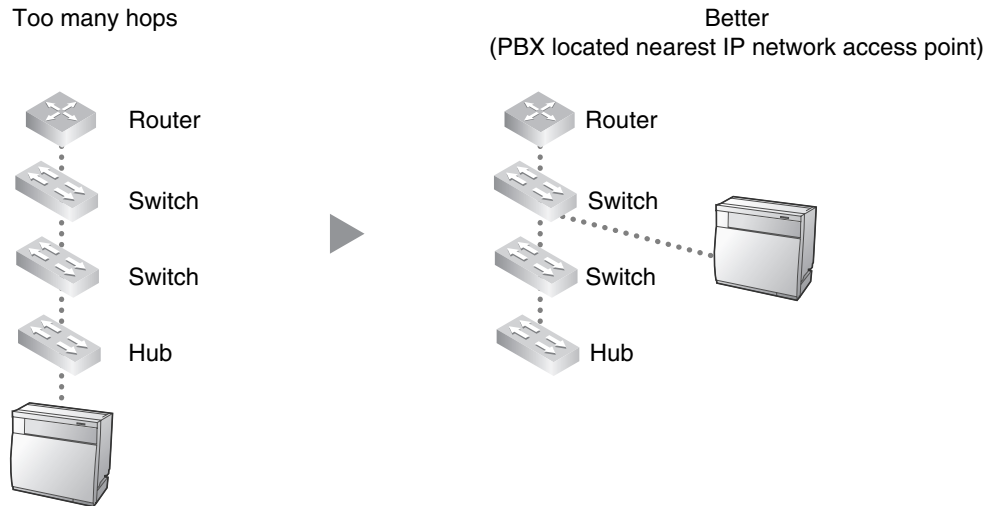

## A1.3 Network Devices

You must evaluate the network devices that are used in the existing network to see if a VoIP network can be implemented. Below are the points that should be taken into your evaluation.

### Can the firewall pass packets from the VoIP Gateway Card?

If the VoIP network contains a firewall, the firewall must be configured appropriately to allow VoIP packets, which are listed in the table below, to pass through the network without being blocked by filtering.

For more information, consult your network administrator.

Protocol	TCP/UDP	Default Port No.
HTTP*1	TCP	80
RTP/RTCP*2	UDP	5004 to 5035
H.225.0 Call Signaling*2	TCP	1720
H.245*2	TCP	1712 to 1724
H.225.0 RAS*2	UDP	1719
QSIG Connectionless Tunneling*1	TCP	1718

\*1 For the actual setting values, refer to "2.2.1 Network Parameters" in the VoIP Gateway Card Programming Guide.

\*2 For the actual setting values, refer to "2.2.2 H.323 Parameters" in the VoIP Gateway Card Programming Guide.

## Are layer 2 or higher switches used?

Use of repeater hubs can increase the network load, and therefore will result in degradation in speech quality.

To ensure high speech quality, use only layer 2 or higher switches.

### **Note**

Also note that the port of the switch that connects to the card should be set to operate under "Auto Negotiation" mode. This will help assure error-free communication between the card and the switch.

## Are Category 5 (CAT5) cables used?

When connecting network devices, make sure to use CAT5 cables. If other types of cables are used, communications may not be carried out normally.

## A1.4 QoS (Quality of Service)

Some routers permit the configuration of priority control features. This allows the router to give higher priority to voice packets and lower the rate of loss and delays during transmissions, hence improving speech quality. It is strongly recommended that you use this feature, especially in networks where traffic is heavy.

Typically, a router identifies what packets to pass in priority by checking the value in the ToS field of the header of IP packets. The VoIP Gateway Card has the ability to set the ToS field of outgoing voice packets (see "2.2.3 Voice Communication Parameters" in the VoIP Gateway Card Programming Guide). When the card is appropriately configured, the router can give voice packets from the card higher priority.

Consult your network administrator when setting the ToS field, as the setting value must conform to the router's specifications.

### **Note**

Some switches also permit the configuration of priority control features. For more information, consult your network administrator.

## A2 VoIP Requirements Checklist

Use the following checklists to see if you can implement a VoIP network. The answers identified in **underlined bold-face letters** are the required answers for the corresponding questions.

### Bandwidth Assessment

No.	Question	Answer	Memo	Ref.
1	<p><b>Does the network have enough bandwidth to support VoIP communications?</b></p> <p>Make sure that there is more bandwidth available for VoIP communications than the amount actually required.</p>	<input type="checkbox"/> <b><u>Yes</u></b> <input type="checkbox"/> No	<ul style="list-style-type: none"> <li>• IP network bandwidth = kbps</li> <li>• Available bandwidth for VoIP = kbps</li> <li>• Required bandwidth for VoIP = kbps</li> </ul>	p. 46

### Network Configuration

No.	Question	Answer	Memo	Ref.
2-a	<p><b>Is the IP network a managed network?</b></p> <p>Make sure to use a managed IP network such as Frame Relay, Leased Line, or IP-VPN (Virtual Private Network). The VoIP Gateway Card is not intended for use on the Internet (including an Internet VPN).</p>	<input type="checkbox"/> <b><u>Yes</u></b> <input type="checkbox"/> No	Type of IP network:	p. 48
2-b	<b>Is it possible to have static IP addressing?</b>	<input type="checkbox"/> <b><u>Yes</u></b> <input type="checkbox"/> No		p. 49
2-c	<b>Is network address translation (NAT/NAPT) disabled?</b>	<input type="checkbox"/> <b><u>Yes</u></b> <input type="checkbox"/> No		p. 49
2-d	<b>Does only a single router provide access to the IP network?</b>	<input type="checkbox"/> <b><u>Yes</u></b> <input type="checkbox"/> No		p. 50
2-e	<b>Is there only a single IP network between 2 ends of a call?</b>	<input type="checkbox"/> <b><u>Yes</u></b> <input type="checkbox"/> No		p. 51
2-f	<b>Is the card located appropriately?</b>	<input type="checkbox"/> Yes <input type="checkbox"/> No	No. of hops (routers/switches) within one location:	p. 52

## Network Devices

No.	Question	Answer	Memo	Ref.
3-a	<p><b>Can the firewall pass packets from the VoIP Gateway Card?</b></p> <p>When a firewall is used, make sure to configure the firewall appropriately to allow VoIP packets to pass through the network without being blocked by filtering.</p>	<input type="checkbox"/> <b>Yes</b> <input type="checkbox"/> No	Model of the firewall:	p. 52
3-b	<p><b>Are layer 2 or higher switches used?</b></p> <p>Do not use repeater hubs as they can increase the network load.</p> <p>Also note that the port of the switch that connects to the card should be set to operate under "Auto Negotiation" mode.</p>	<input type="checkbox"/> <b>Yes</b> <input type="checkbox"/> No	Model of the switch:	p. 53
3-c	<p><b>Are Category 5 (CAT5) cables used?</b></p>	<input type="checkbox"/> <b>Yes</b> <input type="checkbox"/> No		p. 53

## QoS (Quality of Service)

No.	Question	Answer	Memo	Ref.
4	<p><b>Can the router or switch be configured to use priority control features?</b></p>	<input type="checkbox"/> Yes <input type="checkbox"/> No	<p>Model of the router/switch:</p> <p>VoIP Gateway Card's ToS field setting:</p>	p. 53





---

***Appendix B***  
***Alternative Numbering Plan Example***

# B1 Extension Number Method

This section provides a numbering plan example using the extension number method, as supplementary information to the PBX code method discussed in "1.2.2 Numbering Plan Example".

## B1.1 Example Network

The following diagram illustrates a simple VoIP network configured for the extension number method.

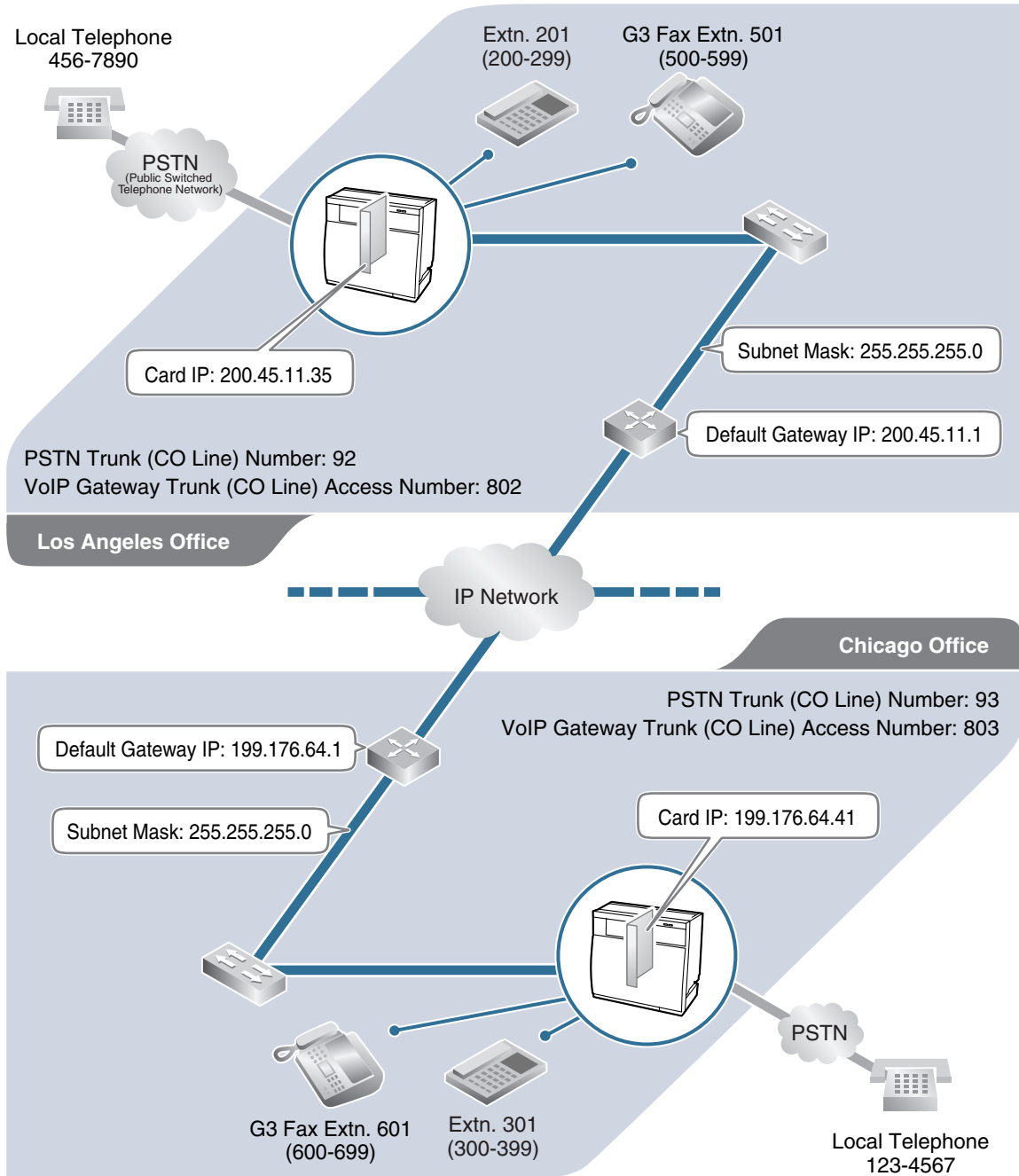

## B1.2 Numbering Plan Example

### IP Addressing Information

The following table is a duplication of the table used for the PBX code method.

	Los Angeles Office	Chicago Office	Description
Card IP Address	200.45.11.35	199.176.64.41	Identifies the location of each VoIP Gateway Card in the network during VoIP communications. A unique IP address must be assigned to each card.
Default Gateway Address	200.45.11.1	199.176.64.1	Identifies the IP address of the primary gateway (typically a router or similar device) that exchanges IP packets with the other gateways on the VoIP network.
Subnet Mask Address	255.255.255.0	255.255.255.0	Defines which digits of an IP address are used for the network address and the host address at each network location. A card IP address must fall within the same subnet as that of the default gateway (e.g., router) that is connected to the card.

### PBX Numbering Information

The following table contains "VoIP Gateway Trunk (CO Line) Access Number", instead of "PBX Code" and "TIE Line Access Number" as used in the PBX code method.

	Los Angeles Office	Chicago Office	Description
VoIP Gateway Trunk (CO Line) Access Number	802	803	An access number to seize a VoIP gateway trunk (CO line).
PSTN Trunk (CO Line) Number	92	93	An access number to seize a local PSTN trunk (CO line).
Extension Number	200 to 299	300 to 399	A number assigned to each extension.
Fax Extension Number	500 to 599	600 to 699	A number assigned to each fax extension.

## Dialing Examples

With the extension number method, the caller dials only the destination number of the called party to call through PBXs at different locations.

### Calling from Los Angeles to Chicago

To extension 301 via VoIP network



To local telephone 123-4567 via VoIP network through local PSTN

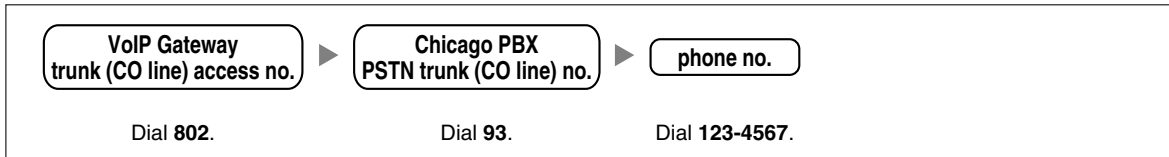

### Calling from Chicago to Los Angeles

To extension 201 via VoIP network



To local telephone 456-7890 via VoIP network through local PSTN

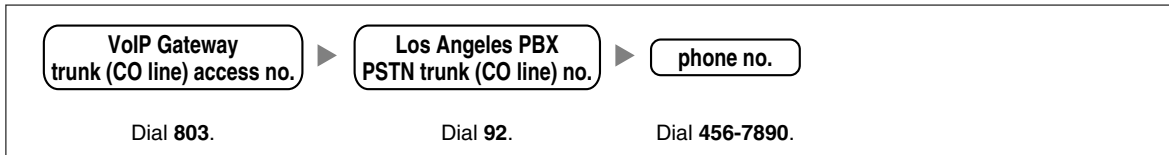

## PBX Connection Information

	Los Angeles Office			Chicago Office		
	Extn.	FAX Extn.	PSTN Access	Extn.	FAX Extn.	PSTN Access
Leading Number	2	5	92	3	6	93
Remaining Digits	2	2	7	2	2	7
Card IP Address	200.45.11.35			199.176.64.41		

## B2 Programming for the Extension Number Method

When programming the VoIP Gateway Cards and PBXs for use in a network configured for the extension number method instead of the PBX code method, some of the steps in the programming procedures require different setting values.

The following 2 sections provide specific steps that require different setting values. The steps other than those provided here have common setting values, and are therefore omitted from this explanation.

### B2.1 Programming the VoIP Gateway Card

The hunt patterns and address translation table need different setting values for the extension number method, as shown in the screen shots provided below.

#### Programming the VoIP Gateway Card in the Los Angeles Office

Create hunt patterns with the setting values shown below, following the procedure in "3.2.4 Assigning the Hunt Pattern".

The screenshot shows a web browser window titled "IP-GW16 Maintenance Utility - Microsoft Internet Explorer". The address bar shows "http://192.168.1.200/ad\_hunt\_pattern\_conf.html". The main content area displays the following configuration steps:

1. Programming

Are the following settings OK?

1.5 Hunt Pattern (for Incoming Calls)

1.5.1 Hunt Group

Port1	Hunt group 1
Port2	Hunt group 1
Port3	Hunt group 1
Port4	Hunt group 1
Port5	Hunt group 1
Port6	Hunt group 1
Port7	Hunt group 1
Port8	Hunt group 1

Hunt Pattern No.	Receive Leading Number	Hunt Group
1	2	1
2	5	1
3	92	1

At the bottom of the page, there are "OK" and "CANCEL" buttons.

Program an address translation table with the setting values shown below, following the procedure in "3.2.5 Programming the Address Translation Table".

1. Programming

Are the following settings OK?

1.6 DN2IP (Dialed Number to IP Address Translation)

1.6.2 DN2IP Entry

DN2IP Table No.	Leading Number	Remaining Number of Digits	Group No.	GW No.	Comment
0	2	2	-	0	Los Angeles
1	5	2	-	0	Los Angeles
2	92	7	-	0	Los Angeles
3	3	2	-	1	Chicago
4	6	2	-	1	Chicago
5	93	7	-	1	Chicago

OK CANCEL

### Programming the VoIP Gateway Card in the Chicago Office

Create hunt patterns with the setting values shown below, following the procedure in "Assigning the Hunt Pattern" under "3.3 Programming the VoIP Gateway Card in the Chicago Office".

1. Programming

Are the following settings OK?

1.5 Hunt Pattern (for Incoming Calls)

1.5.1 Hunt Group

Port1	Hunt group 1
Port2	Hunt group 1
Port3	Hunt group 1
Port4	Hunt group 1
Port5	Hunt group 1
Port6	Hunt group 1
Port7	Hunt group 1
Port8	Hunt group 1

Hunt Pattern No.	Receive Leading Number	Hunt Group
1	3	1
2	6	1
3	93	1

OK CANCEL

## B2.2 Programming the PBX in the Los Angeles Office

The steps below are provided in substitution for steps 6 and 7 of the procedure detailed in "4.1 Programming the PBX in the Los Angeles Office". Program the PBX in the Los Angeles office using the extension number method, following these steps.

After programming the PBX in the Los Angeles office, follow the same procedure to program the PBX in the Chicago office with the appropriate setting values.

### Step 6

Assign the PSTN trunk (CO line) access number:

In the **Idle Line Access (Local Access)** box, type **92** (for Los Angeles office PSTN access).

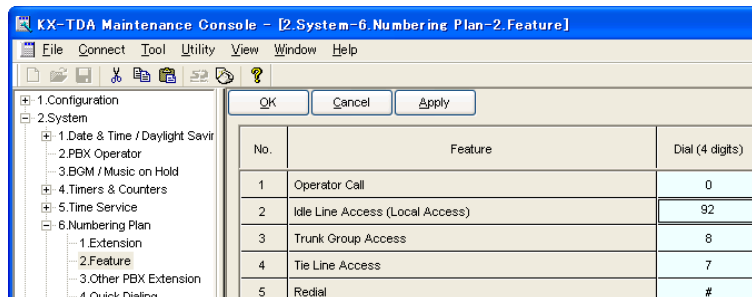

### Step 7

Assign the leading number used to reach the extensions of the remote PBX:

In the **Other PBX Extension Number (TIE)** box (01 and 02), type **3** (for the Chicago office extensions) and **6** (for the Chicago office fax extensions).

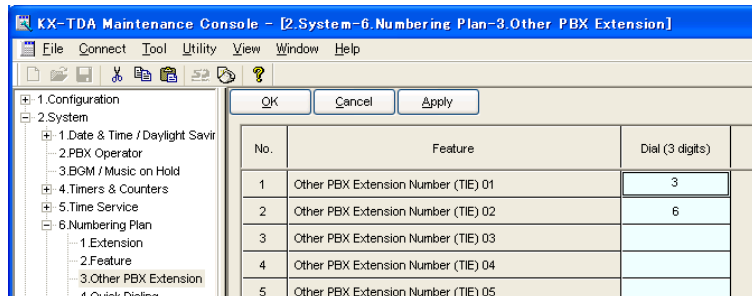

### Step 8

Assign the routing information to route calls to the remote PBX:

In the **Leading Number** box, type **3** (for the Chicago office extensions), **6** (for the Chicago office fax extensions), and **93** (for Chicago office PSTN access).

#### Note

Do not set any value in the **Own PBX Code** box.

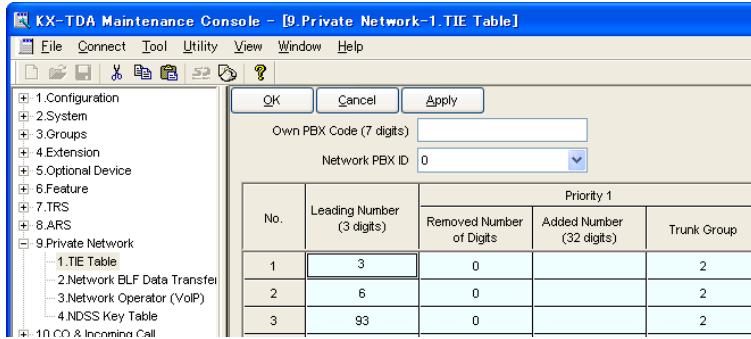

After the above step, follow step 8 of the procedure in "4.1 Programming the PBX in the Los Angeles Office".



---

# ***Appendix C***

## ***Initialization of the VoIP Gateway Card***

# C1 Initializing the VoIP Gateway Card

In case you have forgotten, for example, the IP address or log-in password you set to the VoIP Gateway Card, follow the procedure below to return the settings of the card to the factory default.

## Note

Resetting the card will restore all settings, not just the IP address and log-in password, to the factory default.

1. Install the card to the PBX, and then turn on the power to the PBX.

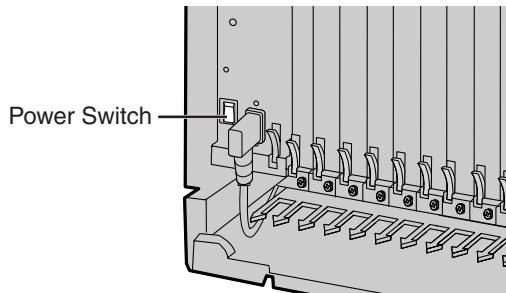

2. Using the KX-TDA Maintenance Console, confirm that the card is in service (INS).

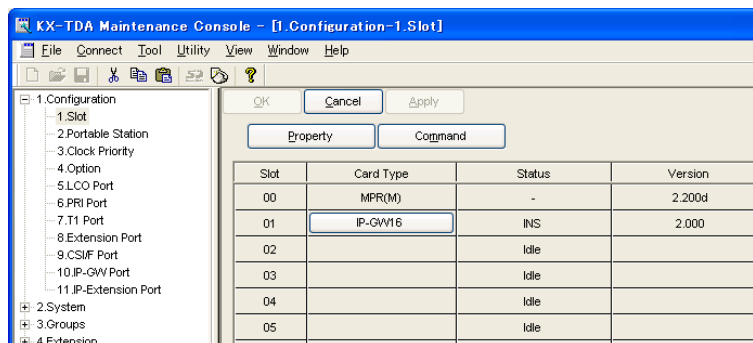

3. Set the System Initialize Switch to the "SYSTEM INITIALIZE" position.

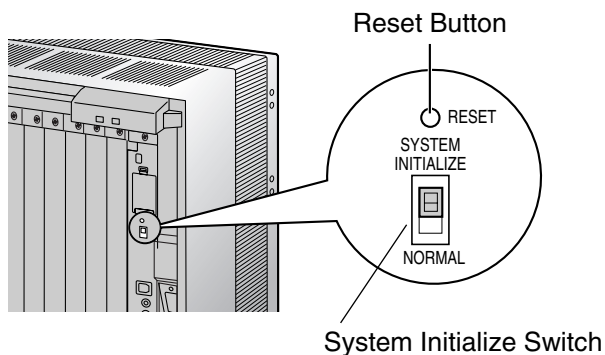

## CAUTION

Do not press the Reset Button nor turn the power off then on while the System Initialize Switch is in this position. Doing so will initialize the PBX.

4. Using the KX-TDA Maintenance Console, set the status of the card to **OUS**, then set it back to **INS**.
5. Return the System Initialize Switch to the "NORMAL" position.

---

## ***Appendix D***

# ***Using the KX-TDA0490 and KX-TDA0480 in One Network***

# D1 Considerations in Installation

Provided below are the points to consider when the VoIP network contains both the KX-TDA0490 and KX-TDA0480 VoIP Gateway Cards.

## Adding the KX-TDA0490 to the Network Using the KX-TDA0480 Maintenance Console Software

For the KX-TDA0480 to recognize the KX-TDA0490 in the network, you must add it as an "Other Unit" in a Unit Group (network) when programming with the MCS as shown below:

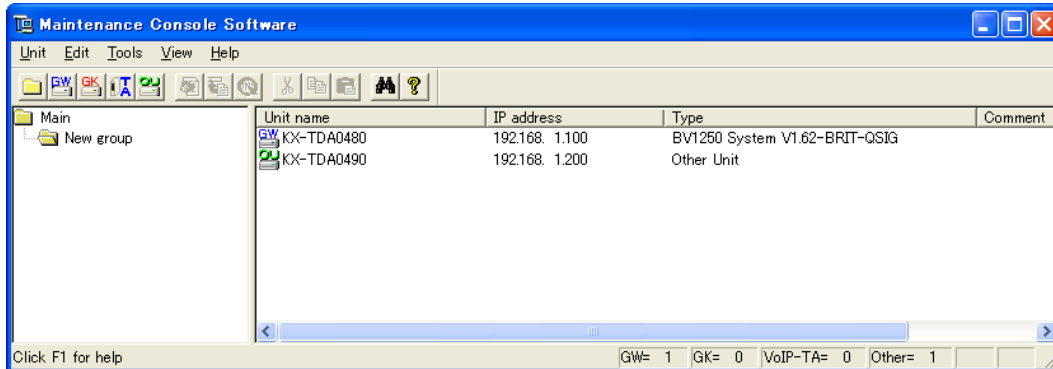

### Note

For programming instructions and other information about the KX-TDA0480, refer to the documentation for the KX-TDA0480.

## Restrictions on Feature Compatibility

Some restrictions exist when using the KX-TDA0490 with the KX-TDA0480, as detailed below:

- CLIP service is the only QSIG service available between the KX-TDA0490 and KX-TDA0480. There is no compatibility for other QSIG services.
- Fax communications cannot take place between the KX-TDA0490 and KX-TDA0480.



**Panasonic Consumer Electronics Company  
Division of Panasonic Corporation of North America**

One Panasonic Way  
Secaucus, NJ 07094

**Panasonic Puerto Rico, Inc.**

Ave. 65 de Infantería, Km. 9.5  
San Gabriel Industrial Park  
Carolina, Puerto Rico 00985

<http://www.panasonic.com/csd>

**Copyright:**

This material is copyrighted by Panasonic Communications Co., Ltd., and may be reproduced for internal use only. All other reproduction, in whole or in part, is prohibited without the written consent of Panasonic Communications Co., Ltd.

© 2005 Panasonic Communications Co., Ltd. All Rights Reserved.

**PSQX3382YA** KK0105AH1015